

# EOS C200 EOS C200B

---

Digital Cinema Camera

Firmware ver. 1.0.7.1.00

**COPYRIGHT WARNING:**

Unauthorized recording of copyrighted materials may infringe on the rights of copyright owners and be contrary to copyright laws.

-India only-

This product is not to be disposed of with your household waste. This product should be handed over to a designated collection point. For more information regarding return and recycling of WEEE products, please visit <https://in.canon/en/consumer/web/e-waste> or write to us at [cipl.ewaste@canon.co.in](mailto:cipl.ewaste@canon.co.in). Also, this product including its components, consumables, parts and spares complies with the "E-Waste (Management) Rules, 2022" and prohibits use of lead, mercury, hexavalent chromium, polybrominated biphenyls or polybrominated diphenyl ethers in concentrations exceeding 0.1 % by weight and 0.01 % by weight for Cadmium, except for the exemptions set in Schedule II of the Rules.

**Trademark Acknowledgements**

- SD, SDHC and SDXC Logos are trademarks of SD-3C, LLC.
- Canon is an authorized licensee of the CFast 2.0™ trademark, which may be registered in various jurisdictions.
- Microsoft and Windows are trademarks or registered trademarks of Microsoft Corporation in the United States and/or other countries.
- Apple and macOS are trademarks of Apple Inc., registered in the U.S. and other countries.
- Wi-Fi is a registered trademark of the Wi-Fi Alliance.
- JavaScript is a trademark or registered trademark of Oracle Corporation, its affiliates or subsidiaries in the United States and other countries.
- HDMI, the HDMI logo and High-Definition Multimedia Interface are trademarks or registered trademarks of HDMI Licensing Administrator, Inc. in the United States and other countries.
- Other names and products not mentioned above may be trademarks or registered trademarks of their respective companies.
- This device incorporates exFAT technology licensed from Microsoft.
- This product is licensed under AT&T patents for the MPEG-4 standard and may be used for encoding MPEG-4 compliant video and/or decoding MPEG-4 compliant video that was encoded only (1) for a personal and noncommercial purpose or (2) by a video provider licensed under the AT&T patents to provide MPEG-4 compliant video. No license is granted or implied for any other use for MPEG-4 standard.
- THIS PRODUCT IS LICENSED UNDER THE AVC PATENT PORTFOLIO LICENSE FOR THE PERSONAL USE OF A CONSUMER OR OTHER USES IN WHICH IT DOES NOT RECEIVE REMUNERATION TO (i) ENCODE VIDEO IN COMPLIANCE WITH THE AVC STANDARD ("AVC VIDEO") AND/OR (ii) DECODE AVC VIDEO THAT WAS ENCODED BY A CONSUMER ENGAGED IN A PERSONAL ACTIVITY AND/OR WAS OBTAINED FROM A VIDEO PROVIDER LICENSED TO PROVIDE AVC VIDEO. NO LICENSE IS GRANTED OR SHALL BE IMPLIED FOR ANY OTHER USE. ADDITIONAL INFORMATION MAY BE OBTAINED FROM MPEG LA, L.L.C. SEE [HTTP://WWW.MPEGLA.COM](http://www.mpegla.com)

## Highlights of the Camera

The Canon EOS C200 / EOS C200B Digital Cinema Camera is the latest camera in the highly-respected Cinema EOS line. Cinema EOS cameras are increasingly relied upon by industry professionals due to their state-of-the-art technology and the cameras' high quality. The C200 / C200B continues that tradition by offering many features that will help you articulate your creative vision.

### 4K Recording System with Cinema Quality

#### Advanced 4K-compatible Super-35mm-equivalent CMOS sensor

At the heart of the camera is a Super-35mm-equivalent CMOS sensor and two DIGIC DV 6 image processors, which enable the camera to capture and process video at an effective pixel count of 8.85 megapixels (4096x2160) and offer a center resolution of 1,800 TV lines<sup>1</sup>. The sensor integrates noise-reduction technology that allows you to record video at sensitivity levels from ISO 160 to ISO 25600<sup>2</sup>.

<sup>1</sup> Varies depending on the lens used.

<sup>2</sup> The ISO speed range can be extended up to ISO 100 on one end, and ISO 102400 on the other.

#### Interchangeable lenses

Enjoy the freedom of using interchangeable lenses to achieve the look you want. The C200 / C200B features an EF lens mount allowing you to use over 100 high-quality lenses from the Canon Cinema Lens series and EF Lens series.

#### Multiple recording formats

The camera offers you a choice of the recording format, depending on your project's requirements. The camera records 4K RAW data using the newly developed Cinema RAW Light<sup>3</sup> (hereafter, referred to as RAW) format, directly to the CFast Card. The RAW data that the camera records is a proprietary format and is even suitable as HDR source material. The second recording format is XF-AVC, which boasts high compression while maintaining high video quality. The third recording format is MP4, a widely-used and versatile format.

<sup>3</sup> Please note that the Cinema RAW Light data recorded by this camera is different from the Cinema RAW data recorded by other Cinema EOS cameras.

#### A variety of video and audio configuration options (📖 64)

RAW clips are recorded in 4096x2160 and, depending on the frame rate, in 12- or 10-bit color depth. Both MP4 and XF-AVC clips can be recorded in 3840x2160 or 1920x1080 and in 8-bit color depth. For details on available combinations of frame size, frame rate and color depth, see the video configuration settings tables (📖 65). The camera records audio in 4-channel linear PCM or 2-channel MPEG-2 AAC-LC (MP4 clips only). With such versatile options, the camera is sure to offer

you a configuration that meets your project's needs and shooting style.

#### Recording media

The camera records RAW clips to a CFast 2.0 card or MP4 clips and XF-AVC clips to an SD card. Because the camera is equipped with two SD card slots, you can use two SD cards to continue recording on the other card when the one being used becomes full (relay recording) or to record the same clip simultaneously on both cards to have a backup recording (double slot recording)<sup>4</sup> (📖 51). While you record primary clips on a CFast card, you can simultaneously record proxy clips—smaller files (2048x1080) for offline editing—on an SD card (📖 113).

<sup>4</sup> Relay recording and double slot recording are not available for proxy clips.

### Operability and Adaptability

#### Freely customizable compact design

The modular components, such as the LM-V1 LCD Monitor<sup>5</sup>, LA-V1 LCD Attachment Unit<sup>5</sup>, HDU-2 Handle Unit<sup>5</sup> and GR-V1 Camera Grip<sup>5</sup>, will let you expand and adapt the camera's configuration to match your shooting conditions (📖 36).

<sup>5</sup> Supplied accessory for the C200; optional accessory for the C200B.

#### Assignable buttons

The camera and modular units feature a number of buttons (on the camera's body, LCD monitor and camera grip) to which you can assign a large number of functions (📖 125). Assign functions that you use often to the assignable buttons you find most convenient to personalize the camera to your needs and preferences.

#### Dual Pixel CMOS AF

The camera features Dual Pixel CMOS AF and offers various autofocus functions (📖 80): Continuous AF, One-shot AF (to use autofocus only when you choose) or AF-boosted MF (to let you focus manually most of the way and let the camera finish focusing automatically). Using AF-boosted MF the camera does not perform unreliable focus adjustments, resulting in a smoother focusing operation than with continuous AF. The camera can also focus automatically on people's faces (Face AF, 📖 87) and track moving subjects while keeping them in focus.

You can control a number of AF-related settings including AF frame size and position, and AF speed. Even while focusing manually, the Dual Pixel Focus Guide function (📖 82) serves as a visual, intuitive guide that you can use to check if the image is in focus and the required adjustment, if it is not. This can be very helpful to ensure you always get amazingly sharp 4K video.

### Remote operation

You can attach the optional RC-V100 Remote Controller to the camera to control it from a distance. The remote controller lets you control a wide range of camera settings (📖 123).

You can also operate the camera remotely via Wi-Fi using the Browser Remote application (📖 170). Browser Remote lets you check the live view image from the camera and adjust main camera settings.

## Versatile Artistic Expression

### Special recording modes

The special recording modes (📖 114) give you more creative control over your recordings. You can create a slow motion effect in your recordings, record a frame at a set interval (ideal for nature shots and other subjects with little movement) or record a frame every time you press a button (ideal for stop motion animation).

### Custom picture settings

The improved custom picture menu gives you even more options to control the “look” of your images. Select one of the preset picture settings or set the combination of gamma curve, color space and color matrix that you wish to use. Then, you can adjust a number of other image-related parameters in detail.

## Other Functions

### Save XF-AVC clips with ease

Use the XF Utility software (📖 159) to save XF-AVC clips to a computer. The software even allows you to organize your clips.

### Software for aiding RAW production workflow

Cinema RAW Development (📖 160) can develop the recorded 4K RAW data and export it as a standard file type such as DPX or OpenEXR. You can also import an EDL to recreate an edit created on NLE software. This helps make a smooth transition to the color grading process.

### Assistance functions

The camera offers a number of assistance functions, such as peaking and magnification (📖 82), onscreen markers (📖 90), zebra patterns (📖 91) and B&W image (📖 42), that you can display on the LCD monitor or viewfinder<sup>6</sup>, or output through the SDI terminal to display on an external monitor. When using a logarithmic gamma curve, you can also apply a LUT (📖 156) to the displays or video output for easier monitoring.

<sup>6</sup> C200 only.

### Other improved features

- 5 levels of ND filter (📖 71).
- In-camera correction for peripheral illumination and chromatic aberration (📖 39).
- Monaural built-in microphone for note taking.
- Three sets of customizable My Menu submenus (📖 34).
- Menu settings file that can be saved in the camera or on an SD card to restore all the menu settings or replicate them perfectly on another C200 / C200B camera (📖 137).
- Improved clip name format with more information for easier identification and organization of clips (📖 61).
- Battery packs compatible with Intelligent System for better remaining usage time information.



# Table of Contents

## 1. Introduction 9

### About this Manual 9

Conventions Used in this Manual 9

### Supplied Accessories 11

### Names of Parts 12

LM-V1 LCD Monitor and LA-V1 LCD Attachment Unit 17

GR-V1 Camera Grip 18

HDU-2 Handle Unit 19

Microphone Holder 19

### 4K Workflow Overview 20

Color Grading with the ACES Workflow 21

## 2. Preparations 23

### Preparing the Power Supply 23

Using a Battery Pack 23

Using a Power Outlet 26

Turning the Camera On and Off 27

### Preparing the Handle Unit and LCD Monitor 28

Attaching the HDU-2 Handle Unit 28

Attaching and Removing the LM-V1 LCD Monitor 28

### Date, Time and Language Settings 31

Setting the Date and Time 31

Changing the Language 32

### Using the Menus 33

Selecting an Option from the Menu 33

Using the Customized Submenu (My Menu) 34

### Preparing the Camera 36

Configuring the Modular Units 36

Preparing the Lens 37

Using the LCD Monitor 40

**C200** Using the Viewfinder 40

Adjusting the LCD Screen or Viewfinder (**C200** only) 41

Using a Tripod 42

Removing and Attaching the GR-V1 Camera Grip 43

Attaching the Microphone Holder 44

Attaching the Shoulder Strap 44

Removing and Attaching the Terminal Covers 45

Using the Optional EVF-V70 Electronic Viewfinder 46

### Preparing Recording Media 47

Compatible Recording Media 47

Inserting a CFast Card 48

Removing a CFast card 48

Inserting and Removing an SD Card 49

Initializing Recording Media 50

Switching Between the SD Card Slots 50

Relay Recording and Double Slot Recording 51

Checking the Remaining Recording Time on Recording Media 51

Recovering Clips 52

### Adjusting the Black Balance 53

## 3. Recording 55

### Recording Video 55

Preparing to Record 55

Recording 56

Onscreen Displays 57

Setting the Clip File Name 61

Selecting the File Numbering Method for MP4 Clips and Photos 62

Using the Fan 63

### Video Configuration: Video Format, System Frequency, Frame Rate and Resolution 64

Selecting the Main Recording Format 64

Selecting the System Frequency 64

Selecting the Frame Rate 64

Selecting the Resolution and Color Sampling Settings 65

### Changing Main Camera Functions with the FUNC Button 66

Using the Direct Setting Mode 66

### Shutter Speed 67

Changing the Shutter Speed Mode and Value 68

### ISO Speed/Gain 69

Changing the ISO Speed or Gain Value 69

Using the Control Dial 70

### ND Filter 71

- Adjusting the Aperture 72**
    - Manual Aperture 72
    - Momentary Automatic Aperture - Push Auto Iris 74
    - Automatic Aperture 74
    - Exposure Compensation - AE Shift 75
    - Light Metering Mode 76
  - White Balance 77**
    - Custom White Balance 77
    - Color Temperature/Preset White Balance 78
    - Auto White Balance (AWB) 79
  - Adjusting the Focus 80**
    - Manual Focus 81
    - One-Shot AF 84
    - AF-Boosted MF 84
    - Continuous AF 85
    - Changing the AF Frame Size and Position 86
    - Face Detection 87
    - Tracking a Specific Subject 88
  - Zooming 89**
  - Onscreen Markers and Zebra Patterns 90**
    - Displaying Onscreen Markers 90
    - Displaying Zebra Patterns 91
  - Setting the Time Code 92**
    - Selecting the Time Code Mode 92
    - Selecting Drop or Non-Drop Frame 93
    - Putting the Time Code Display on Hold 93
  - Setting the User Bit 95**
  - Recording Audio 96**
    - Audio Settings and Recorded Audio Channels 96
    - Connecting an External Microphone or External Audio Input Source to the Camera 98
    - Setting the Audio Input Type for the INPUT 1/INPUT 2 Terminals 99
    - Selecting the Audio Format for Clips 99
    - Selecting the Audio Input Source for Audio Channels 100
    - Adjusting the Audio Recording Level 101
    - Advanced Audio Input Settings 102
    - Monitoring the Audio with Headphones 104
  - Colors Bars/Audio Reference Signal 105**
    - Color Bars 105
    - Audio Reference Signal 105
  - Waveform Monitor 106**
    - Displaying the Waveform Monitor 106
    - Configuring the Waveform Monitor 106
  - Adding Marks to Recordings 108**
    - Adding a Shot Mark while Recording 108
    - Adding an  Mark or  Mark after Recording 108
  - Using Metadata 109**
    - Setting a User Memo Created with Canon XF Utility 109
    - Entering Information About the Recording 110
  - Recording GPS Information (Geotagging) 111**
  - Reviewing a Recording 112**
  - Simultaneous Recording of Proxy Clips 113**
  - Special Recording Modes 114**
    - Slow Motion Recording Mode 114
    - Pre-recording Mode 115
    - Frame Recording Mode 116
    - Interval Recording Mode 117
    - Continuous Recording 118
  - Taking Photos 120**
  - Photo Playback 121**
    - Displaying the [Photos] Index Screen 121
    - Viewing Photos 121
  - Deleting Photos 122**
  - Using the Optional RC-V100 Remote Controller 123**
- ## 4. Customization 125
- Assignable Buttons 125**
    - Changing the Assigned Function 125
    - Using an Assignable Button 126
  - Custom Picture Settings 129**
    - Selecting Custom Picture Files 129
    - Preset Picture Settings 129
    - Editing a Custom Picture File's Settings 130
    - Resetting Custom Picture Files 131
    - Renaming Custom Picture Files 131
    - Protecting Custom Picture Files 131
    - Copying Custom Picture Files 131
    - Embedding Custom Picture Settings in a Clip 132
    - Available Custom Picture Settings 133
  - Saving and Loading Camera Settings 137**
    - Saving Camera Settings 137
    - Loading Camera Settings 137

## 5. Playback 139

### Playback 139

- Clip Index Screen 139
- Playing Back Clips 141
- Onscreen Displays 141
- Playback Controls 143
- Adjusting the Volume 143

### Clip Operations 144

- Using the Clip Menu 144
- Displaying Clip Information 145
- Adding  Marks or  Marks 146
- Deleting an  Mark or  Mark from a Clip 146
- Adding Shot Marks 147
- Deleting All Shot Marks in a Clip from the Index Screen 147
- Deleting Clips 147
- Deleting the User Memo and GPS Information 148

## 6. External Connections 149

### Video Output Configuration 149

- Recording Video Signal Configuration and Video Output Configuration by Terminal 149
- Playback Video Configuration and Video Output Configuration by Terminal 150

### Connecting to an External Monitor or Recorder 152

- Connection Diagram 152
- Using the SDI Terminal 152
- Using the HDMI OUT Terminal 153
- Setting the Scan Mode of the Output Signal 154
- Outputting Simultaneously from the HDMI OUT Terminal and SDI Terminal 155
- HDR Output 155
- Applying a LUT to Screens/Video Outputs 156
- Output by terminal/device and HDR setting 156
- Superimposing Onscreen Displays on Screens/Video Outputs 157

### Audio Output 158

### Working with Clips on a Computer 159

- Saving MP4 Clips 159
- Saving XF-AVC Clips 159
- Developing RAW Clips 160

## 7. Network Functions 161

### About the Network Functions 161

### Connecting to a Wi-Fi Network 162

- Camera Access Point 163
- Connecting in Infrastructure Mode 164
- Wi-Fi Protected Setup (WPS) 165
- Searching for Access Points 166
- Manual Setup 167

### Connecting to a Wired (Ethernet) Network 168

### Selecting a Network Connection 169

### Checking and Changing Network Settings 169

### Browser Remote: Controlling the Camera from a Network Device 170

- Setting Up Browser Remote 170
- Starting Browser Remote 171
- Using Browser Remote 173

### FTP File Transfer 182

- Preparations 182
- Transferring Clips (FTP Transfer) 183

## 8. Additional Information 185

### Menu Options 185

### Displaying the Status Screens 196

### Troubleshooting 207

- List of Messages 212

### Handling Precautions and Safety Instructions 217

### Maintenance/Others 221

### Optional Accessories 222

### Specifications 224

### Appendix: Compatible Lenses and Functions 230

### Reference Tables 231

### Index 232



## About this Manual

Thank you for purchasing the Canon EOS C200 / EOS C200B\*. Please read this manual carefully before you use the camera and retain it for future reference. Should the camera fail to operate correctly, refer to *Troubleshooting* (📖 207).

\* Availability differs from area to area.

## Conventions Used in this Manual

- **!** **IMPORTANT:** Precautions related to the camera's operation.
- **i** **NOTES:** Additional topics that complement the basic operating procedures.
- **📖:** Reference page number.
- **C200B:** The icon refers to text and illustrations that apply only to the indicated model.
- The following terms are used in this manual.
  - “Screen” refers to the LCD screen on the LCD monitor<sup>1</sup> and to the viewfinder<sup>2</sup> screen on the camera.
  - “SD card” refers to an SD, SDHC or SDXC memory card.
  - “Recording media” refers to CFast cards and SD cards.
  - “RAW data” refers to the data recorded using Cinema RAW Light.
- Photographs in the manual are simulated pictures taken with a still camera. Some screenshots have been altered to make them easier to read.
- Illustrations in the manual show the Canon EOS C200 camera with the LM-V1 LCD Monitor<sup>1</sup>, LA-V1 LCD Attachment Unit<sup>1</sup>, HDU-2 Handle Unit<sup>1</sup>, GR-V1 Camera Grip<sup>1</sup> and Canon EF 50mm f/1.4 USM lens attached.

<sup>1</sup> Supplied accessory for the C200; optional accessory for the C200B.

<sup>2</sup> **C200B** The C200B is not equipped with a viewfinder but the optional EVF-V70 Electronic Viewfinder can be purchased separately.

The arrow is used to abbreviate steps in procedures. For a detailed explanation on how to use the menus, refer to *Using the Menus* (📖 33). For a concise summary of all available menu options and settings, refer to the appendix *Menu Options* (📖 185).

### Operating modes

A shaded icon (like **CAMERA**) indicates that the function described can be used in the operating mode shown or for recordings made in the movie format shown in the icon; a non-shaded icon (like **CAMERA**) indicates that the function cannot be used. For details, refer to *Turning the Camera On and Off* (📖 27) and *Selecting the Main Recording Format* (📖 64).

**Setting the Time Code**

In **CAMERA** mode, the camera generates a time code signal and records it with the recorded clips. The time code signal can be output from the SDI terminal and HDMI OUT terminal. In **MEDIA** mode, the time code embedded in the clip being played back can be output from the SDI terminal.

Depending on the frame rate used, you may be able to select between a drop frame and a non-drop frame time code signal (📖 93). The default mode varies depending on the country/region of purchase and, though the time code display style is different for DF and NDF, in this section the NDF display style is used for simplicity's sake.

**Selecting the Time Code Mode**

You can select the camera's time code mode.

Operating modes: **CAMERA** | **MEDIA** | **RAW** | **MP4** | **XF-AVC**

**1** Open the **[Time Code Mode]** submenu.

**MENU** ● [ **3** ] System Setup ● [Time Code Mode]

**2** Select the desired option and then press the joystick.

**Options**

[Preset]: The time code starts from an initial value you can select in advance. The default initial time code is 00:00:00:00. See the following procedures to select the time code running mode and set the initial time code.

[Regen.]: The camera will read the selected recording media and the time code will continue from the last time code recorded on the recording media. The time code runs only while recording so clips recorded consecutively on the same recording media will have continuous time codes.

**Setting the Time Code Running Mode**

If you set the time code mode to [Preset], you can select the time code running mode.

**1** Open the **[Time Code Run]** submenu.

**MENU** ● [ **3** ] System Setup ● [Time Code Run]

**2** Select the desired option and then press the joystick.

**Options**

[Rec Run]: The time code runs only while recording so clips recorded consecutively on the same recording media will have continuous time codes.

[Free Run]: The time code starts running the moment you press the joystick and keeps running regardless of the camera's operation.

When a procedure requires selecting an option, the available options are listed within or after the procedure. Brackets [ ] are used to refer to menu options as they are displayed on screen.

## Supplied Accessories

The following accessories are supplied with the camera. Note that some accessories are supplied only with the C200.

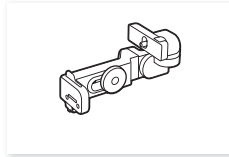
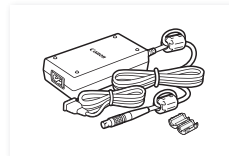
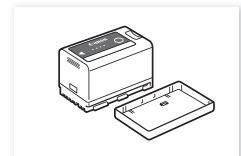
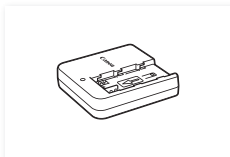
LM-V1 LCD Monitor<sup>1</sup>LA-V1 LCD Attachment Unit<sup>1</sup>UN-5 Unit Cable<sup>1</sup>HDU-2 Handle Unit<sup>1</sup>Microphone Holder  
(incl. M4 fixation bolts (x 2))GR-V1 Camera Grip<sup>1, 2</sup>  
(incl. grip attachment ring)CA-A10 AC Adapter  
(incl. power cord and ferrite core)BP-A30 Battery Pack  
(incl. terminal cover)

CG-A20 Battery Charger

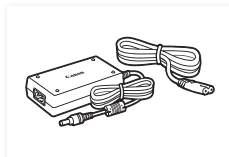
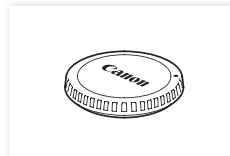
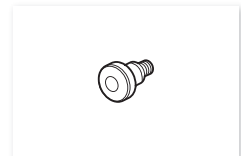
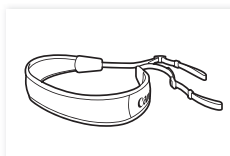
CA-CP200B Compact Power Adapter  
(for the CG-A20; incl. power cord)Eye Cup<sup>1</sup>Viewfinder Cap<sup>1</sup>Body Cap<sup>2</sup>Thumb Rest<sup>3</sup>Hex wrench (for 0.64 cm, 1/4"  
screws, 0.64 cm (1/4") hex socket  
head bolt, and bolt retainers (x4)<sup>1</sup>Tape Measure Hook<sup>2</sup>SS-1200 Shoulder Strap<sup>1</sup>

<sup>1</sup> C200 only.

<sup>2</sup> Comes pre-attached to the camera.

<sup>3</sup> C200B Comes pre-attached to the camera.

**About the lens kit:** At the time of purchase, the lens kit is supplied with a lens (model number is on the product box). Visit your local Canon website to download its instruction manual. Please note that the lens is also sold separately so the supplied accessories listed in that instruction manual differ slightly from the accessories supplied with the lens kit.

## Names of Parts

12

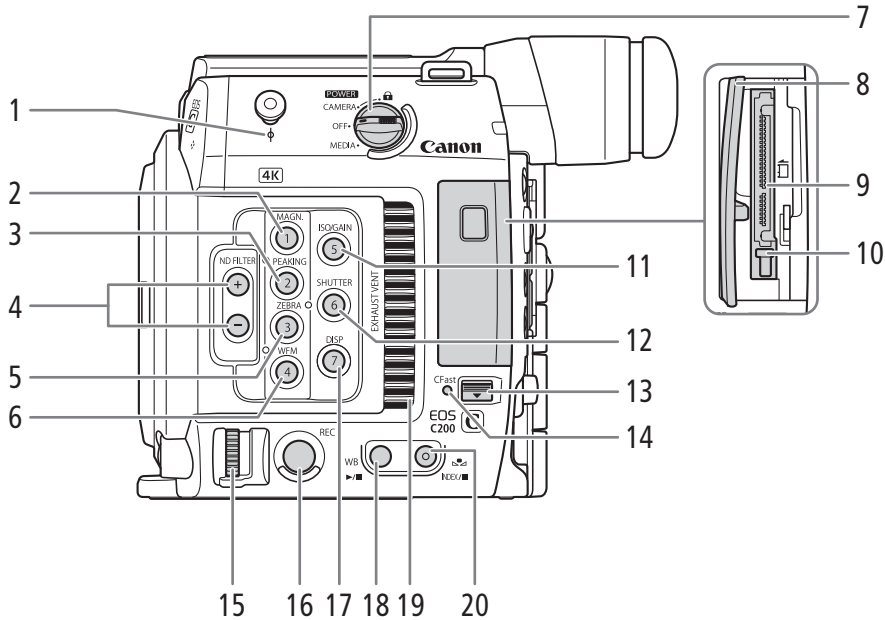

- |  |  |
|--|--|
| <p>1 Tape measure hook and <math>\phi</math> focal plane mark</p> <p>2 MAGN. (magnification) button ( 83)/<br/>Assignable button Camera 1 ( 125)</p> <p>3 PEAKING button ( 83)/<br/>Assignable button Camera 2 ( 125)</p> <p>4 ND FILTER +/- buttons ( 71)</p> <p>5 ZEBRA button ( 91)/<br/>Assignable button Camera 3 ( 125)</p> <p>6 WFM (waveform monitor) button ( 106)/<br/>Assignable button Camera 4 ( 125)</p> <p>7 <b>POWER</b> switch ( 27)</p> <p>8 CFast card slot cover</p> <p>9 CFast card slot ( 48)</p> <p>10 Card release button for CFast card slot ( 48)</p> <p>11 ISO/GAIN button ( 69)/<br/>Assignable button Camera 5 ( 125)</p> | <p>12 SHUTTER (shutter speed mode) button ( 67)/<br/>Assignable button Camera 6 ( 125)</p> <p>13 CFast card slot cover switch</p> <p>14 CFast access indicator</p> <p>15 Control dial ( 70, 72)</p> <p>16 REC (start/stop recording) button ( 56)</p> <p>17 DISP (display) button ( 57, 141)/<br/>Assignable button Camera 7 ( 125)</p> <p>18 WB (white balance) button ( 77)/<br/>▶/   (play/pause) button ( 141)</p> <p>19 Exhaust ventilation outlet ( 63)</p> <p>20 ◀ (white balance adjustment) button ( 77)/<br/>INDEX button ( 140)/<br/>■ (stop) button ( 141)</p> |
|--|--|



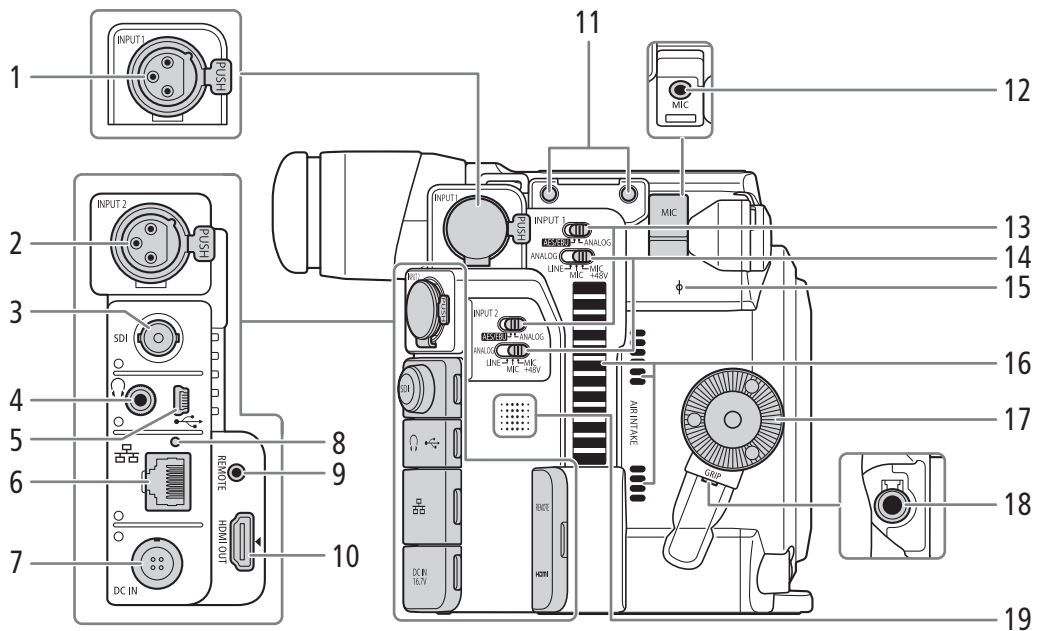

- |    |  |    |  |
|----|--|----|--|
| 1  | INPUT 1 terminal (XLR) ( 98)   | 11 | Screw holes for the microphone holder fixation bolts                         |
| 2  | INPUT 2 terminal (XLR) ( 98)   | 12 | MIC (microphone) terminal ( 98)  |
| 3  | SDI terminal ( 149, 152)   | 13 | Audio input selection switches for INPUT 1 and INPUT 2 ( 99)                 |
| 4  | ⌚ (headphone) terminal ( 104)  | 14 | ANALOG (analog audio source selection) switches for INPUT 1/INPUT 2 ( 99)    |
| 5  | USB terminal ( 111, 159)   | 15 | φ Focal plane mark   |
| 6  | 🌐 (Ethernet) terminal ( 168)   | 16 | Air intake vent ( 63)  |
| 7  | DC IN terminal ( 26)   | 17 | Camera grip attachment thread/Rosette ( 43)<br>Compliant with ARRI rosettes. |
| 8  | 🌐 (Ethernet) indicator ( 168)  | 18 | Camera grip connection terminal ( 43)  |
| 9  | REMOTE terminal<br>For connecting the optional RC-V100 Remote Controller or commercially available remote controllers. | 19 | Speaker ( 188)   |
| 10 | HDMI OUT terminal ( 149, 153)  |    |  |

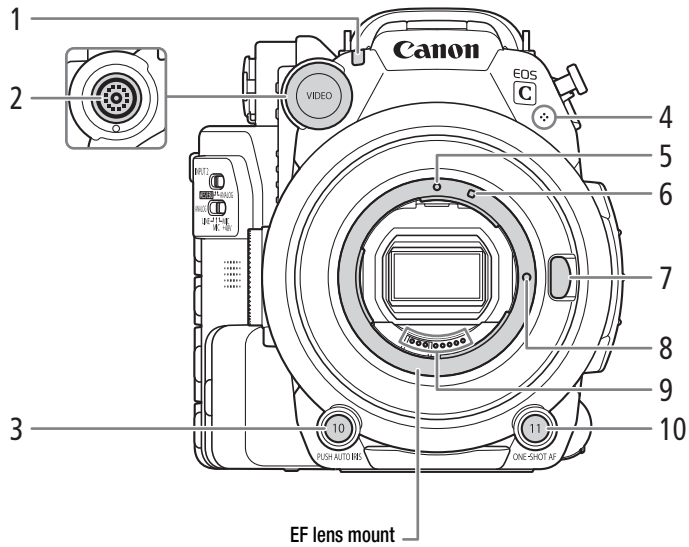

- |  |  |
|--|--|
| <ul style="list-style-type: none"> <li>1 Tally lamp ( 56)</li> <li>2 VIDEO terminal ( 28)</li> <li>3 PUSH AUTO IRIS (momentary automatic aperture) button ( 74)/ Assignable button Camera 10 ( 125)</li> <li>4 Built-in monaural microphone ( 103)</li> <li>5 EF lens mount index ( 37)</li> </ul> | <ul style="list-style-type: none"> <li>6 EF-S lens mount index ( 37)</li> <li>7 Lens release button ( 37)</li> <li>8 EF lens lock pin ( 37)</li> <li>9 EF lens contacts ( 37)</li> <li>10 ONE-SHOT AF (focus automatically once) button ( 84)/ Assignable button Camera 11 ( 125)</li> </ul> |
|--|--|

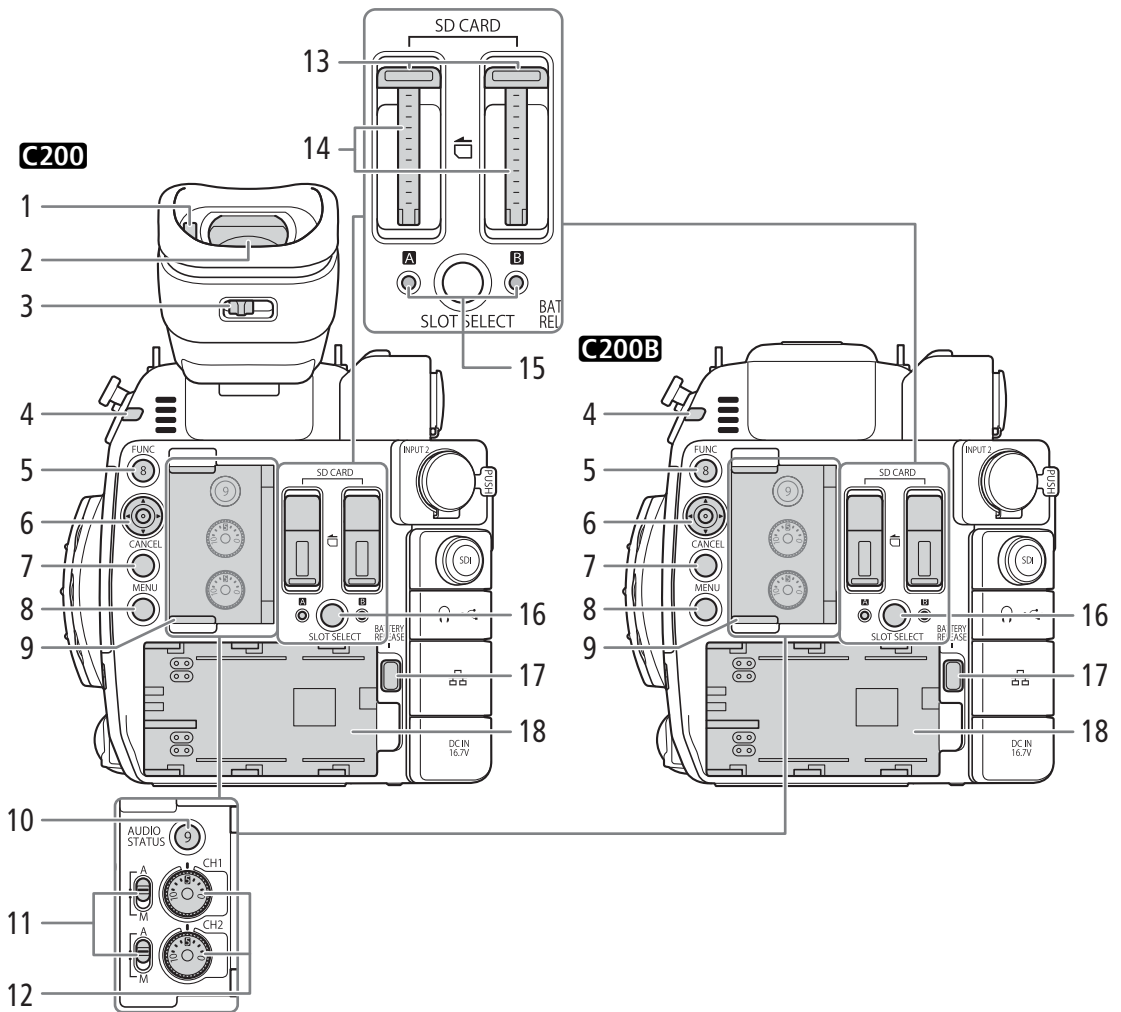

- 1 Eye sensor ( 40)
- 2 Viewfinder ( 40, 41)
- 3 Diopter adjustment lever ( 40)
- 4 Tally lamp ( 56)
- 5 FUNC (main functions) button ( 66)/  
Assignable button Camera 8 ( 125)
- 6 Joystick ( 33)
- 7 CANCEL button ( 33)
- 8 MENU button ( 33, 125)
- 9 Cover for audio controls
- 10 AUDIO STATUS (display Audio status screen)  
button ( 200)/  
Assignable button Camera 9 ( 125)
- 11 Audio level switches for CH1 (top) and CH2  
(bottom) ( 101)

- 12 Audio level dials for CH1 (top) and CH2 (bottom)  
( 101)
- 13 SD card slot A (left) and B (right) covers ( 48)
- 14 SD card slots ( 49)  
In this manual, SD cards in each slot are referred  
to as "SD card A" and "SD card B", respectively.
- 15 SD CARD **A** (SD card slot A) and SD CARD **B**  
(SD card slot B) access indicators ( 49)
- 16 SLOT SELECT (SD card selection) button ( 50,  
140)
- 17 BATTERY RELEASE button ( 25)
- 18 Battery compartment ( 25)

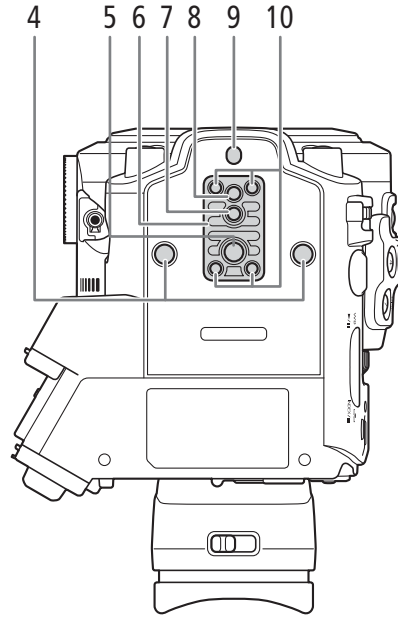
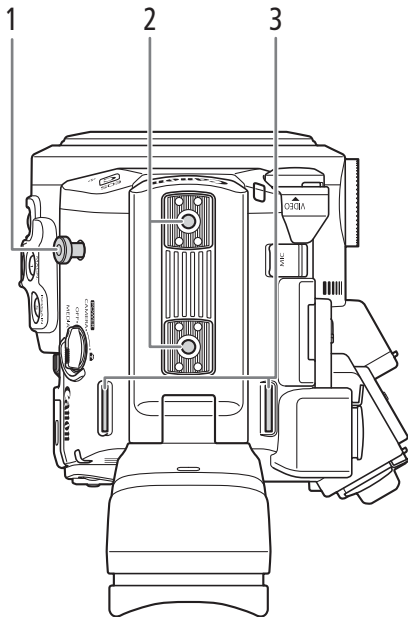

- 1 Tape measure hook  
Use the hook to accurately measure the distance from the focal plane.
- 2 Accessory socket  
For mounting accessories with 1/4"-20 screws (6.9 mm (0.27 in.) deep).
- 3 Strap mounts (☞ 44)
- 4 Screw holes for 1/4"-20 mounting screws (8.5 mm (0.33 in.) deep)

- 5 Screw hole for 3/8"-16 mounting screws (10 mm (0.39 in.) deep) (☞ 42)
- 6 TB-1 Tripod Base
- 7 Tripod socket for tripods with 0.95 cm (3/8 in.) screws (5.5 mm (0.22 in.) deep) (☞ 42)
- 8 Screw hole for 1/4"-20 mounting screws (7 mm (0.28 in.) deep) (☞ 42)
- 9 Tripod socket for tripods with 0.64 cm (1/4 in.) screws (5 mm (0.20 in.) deep) (☞ 42)
- 10 Tripod base screws (☞ 42)

## LM-V1 LCD Monitor<sup>1</sup> and LA-V1 LCD Attachment Unit<sup>1</sup>

<sup>1</sup> Supplied accessory for the C200; optional accessory for the C200B.

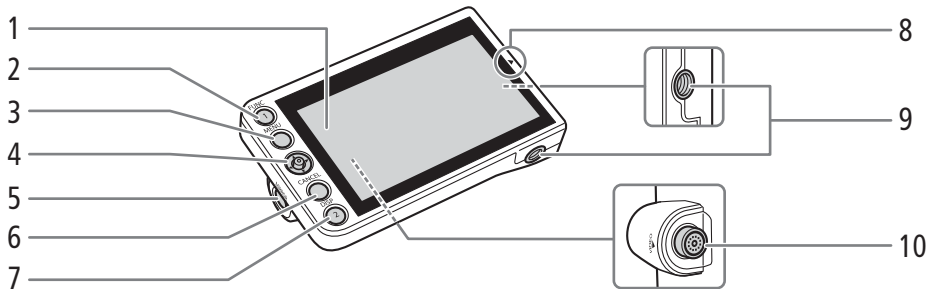

- |   |  |
|---|--|
| <ul style="list-style-type: none"> <li>1 LCD panel with touch screen (📖 40, 41)</li> <li>2 FUNC (main functions) button (📖 66)/<br/>Assignable button Monitor 1 (📖 125)</li> <li>3 MENU button (📖 33, 125)</li> <li>4 Joystick (📖 33)</li> <li>5 MIRROR (invert the displayed image) button<br/>(📖 40)</li> <li>6 CANCEL button (📖 33)</li> </ul> | <ul style="list-style-type: none"> <li>7 DISP (display) button (📖 57, 141)/<br/>Assignable button Monitor 2 (📖 125)</li> <li>8 ▲ mark for aligning the LCD monitor's position<br/>(📖 28)</li> <li>9 Screw hole for 1/4"-20 screws (11.2 mm (0.44 in.)<br/>deep)</li> <li>10 VIDEO terminal (📖 28)</li> </ul> |
|---|--|

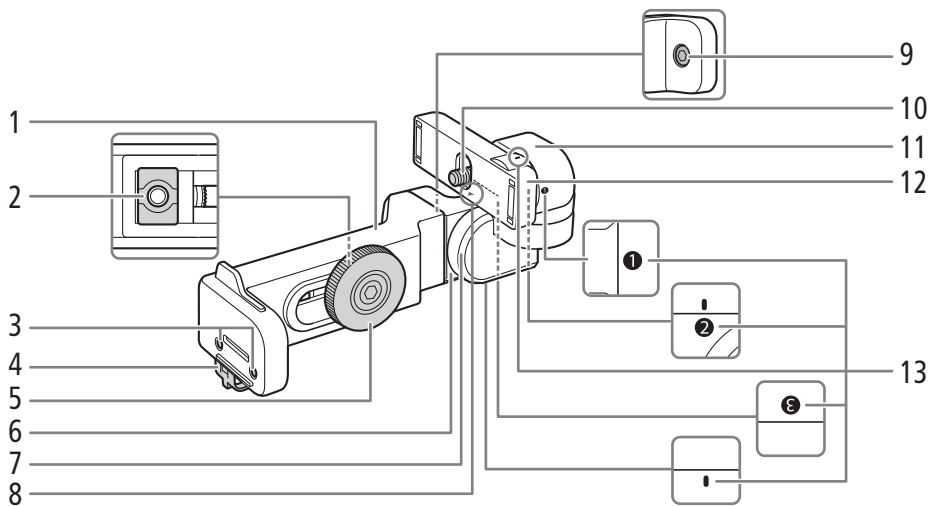

- |  |  |
|--|--|
| <ul style="list-style-type: none"> <li>1 LCD attachment unit base 1 (📖 28)</li> <li>2 LCD attachment unit mount (📖 28)</li> <li>3 Sockets for the microphone holder (📖 44)</li> <li>4 Cable clamp (📖 28)</li> <li>5 LCD attachment unit lock screw (📖 28)</li> <li>6 LCD attachment base 2 (📖 28)</li> <li>7 LCD attachment unit pivot B (📖 28)</li> </ul> | <ul style="list-style-type: none"> <li>8 ▲ mark for aligning the LCD monitor's position<br/>(📖 28)</li> <li>9 Pivot base fixation bolt</li> <li>10 LCD monitor fixation bolt (📖 28)</li> <li>11 LCD attachment unit pivot A (📖 28)</li> <li>12 LCD monitor mount (📖 28)</li> <li>13 LCD attachment unit alignment marks</li> </ul> |
|--|--|

## GR-V1 Camera Grip<sup>1</sup>

**C200** At the time of purchase, the camera grip is pre-attached to the camera.

18

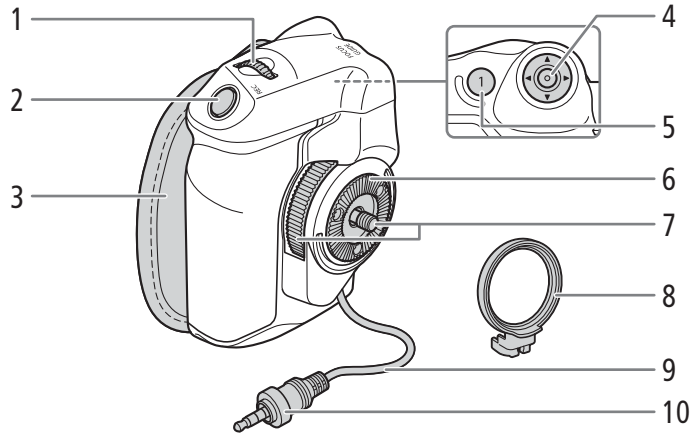

- |  |                                |
|--|--------------------------------|
| 1 Control dial (📖 70, 72)  | 6 Rosette                      |
| 2 REC (start/stop recording) button (📖 56)                       | Compliant with ARRI rosettes.  |
| 3 Grip belt (📖 44)   | 7 Lock screw (📖 43)            |
| 4 Joystick (📖 33)/SET button (📖 33)                              | 8 Grip attachment ring (📖 43)  |
| 5 FOCUS GUIDE button (📖 82)/<br>Assignable button Grip 1 (📖 125) | 9 Grip connection cable (📖 43) |
|  | 10 Connection plug (📖 43)      |

<sup>1</sup> Supplied accessory for the C200; optional accessory for the C200B.

## HDU-2 Handle Unit<sup>1</sup>

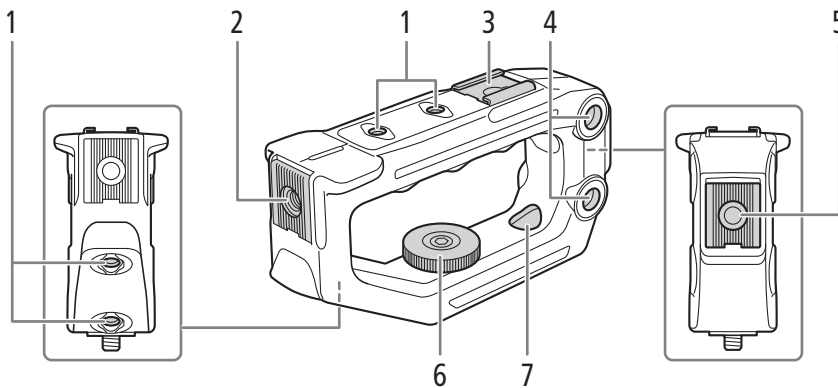

- |   |  |
|---|--|
| <p>1 Screw holes for 1/4"-20 screws (6 mm (0.24 in.) deep; 4 in total on the handle unit.</p> <p>2 Front accessory mount<sup>2</sup><br/>Includes a screw hole for 1/4"-20 screws (8.8 mm (0.35 in.) deep)</p> <p>3 Top accessory shoe</p> <p>4 Through-holes (Ø 8.8 mm (0.35 in.))</p> | <p>5 Rear accessory mount<br/>Includes a screw hole for 1/4"-20 screws (8.8 mm (0.35 in.) deep)</p> <p>6 Lock screw</p> <p>7 Thru-hole mounting holes for attaching the handle unit to the camera (📖 28)</p> |
|---|--|

<sup>1</sup> Supplied accessory for the C200; optional accessory for the C200B.

<sup>2</sup> With socket for 0.64 cm (1/4") screws

## Microphone Holder

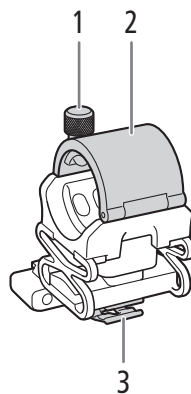

- 1 Microphone lock screw (📖 98)
- 2 Microphone holder (📖 98)
- 3 Microphone cable clamp (📖 98)

## 4K Workflow Overview

The following illustrates the typical 4K workflow for this camera.

20 Operating modes: CAMERA | MEDIA | RAW | MP4 | XF-AVC

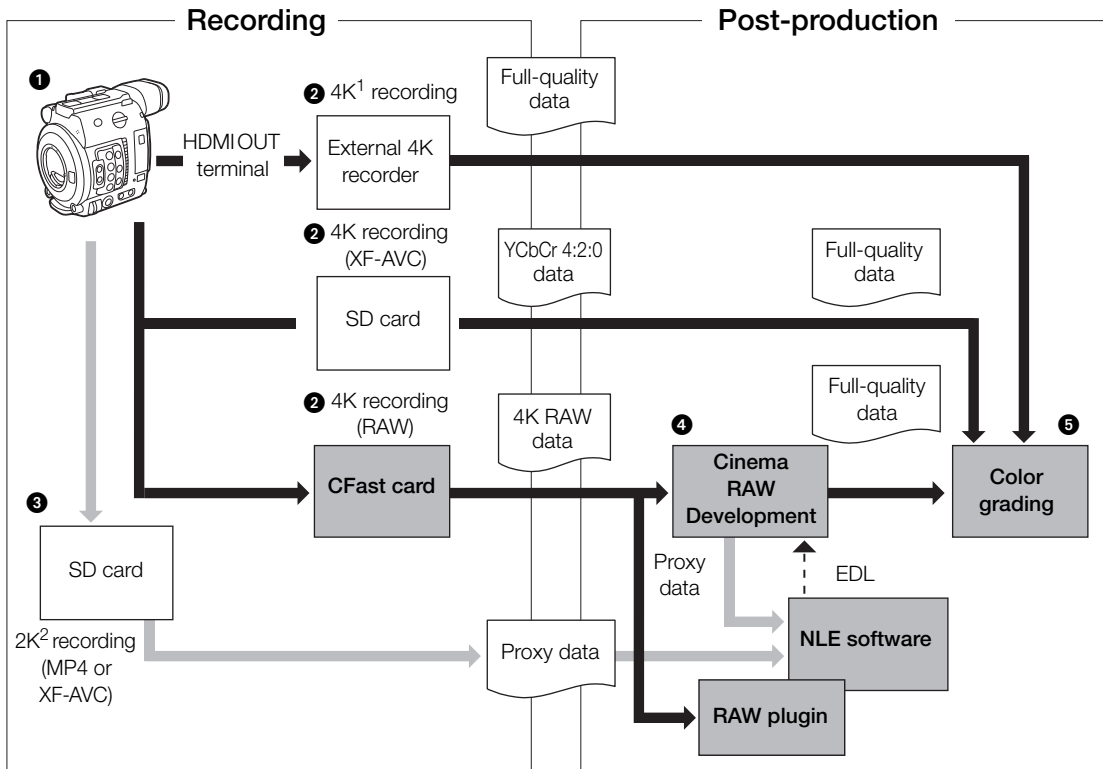

<sup>1</sup> For MP4 and XF-AVC recordings, the resolution is 3840x2160.

<sup>2</sup> For proxy recordings, the resolution is 2048x1080.

- ❶ Shoot in 4K mode (📖 64).
- ❷ You can record 4K RAW on a CFast card or 4K YCbCr 4:2:0 data on an SD card in the camera, or record 4K data using an external 4K recorder connected to the camera's HDMI OUT terminal (📖 152).
- ❸ In addition to the primary 4K recording to the CFast card, you can record simultaneously 2K proxy clips on an SD card in the camera (📖 113).
  - When the proxy clip is XF-AVC format, the file names of the primary and proxy clips will be similar (📖 61).
  - When the primary clip is XF-AVC format, proxy clip recording is not available.
- ❹ After recording on a CFast card, develop the CFast card data using the Cinema RAW Development software (📖 160) to generate full-quality data.
  - You can also generate proxy data with the software.
- ❺ Perform color grading based on the full-quality data.



## Color Grading with the ACES Workflow

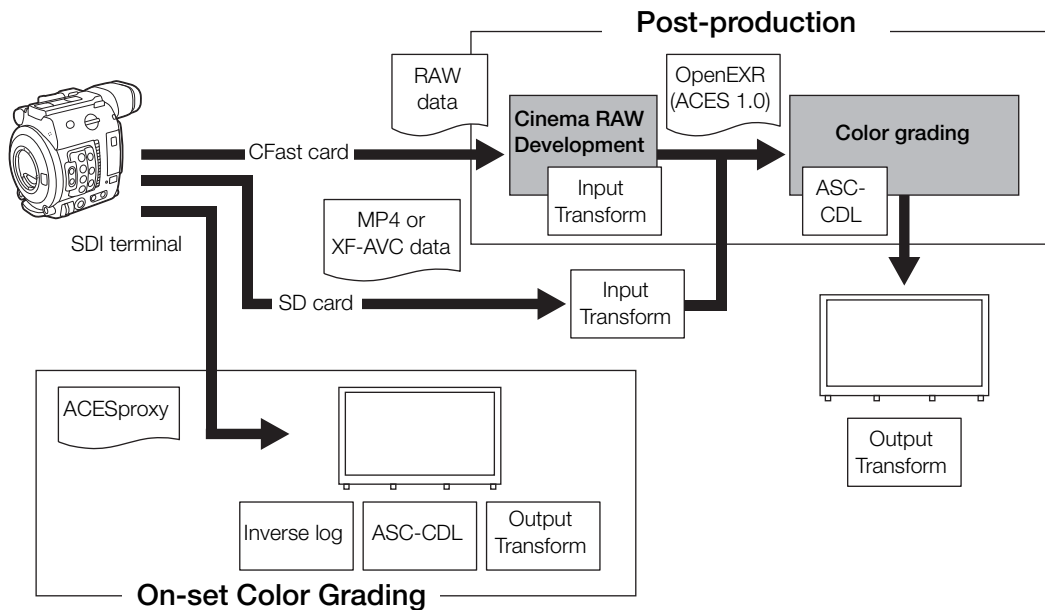

- ACESproxy:** ACESproxy video data that is output from the SDI terminal when performing on-set color grading. Select the [LUT: ACESproxy] option for the LUT setting, depending on where the video is to be output (156).
- Input Transform:** Refers to the table used for converting color information of the input device to ACES2065-1 color space.
- Output Transform:** Refers to the table used for mapping ACES2065-1 color space information to the specific color information scheme used by the display device.
- ASC-CDL:** Refers to the list that contains color grading adjustment data. This step requires equipment compatible with ASC-CDL.



## Preparing the Power Supply

You can power the camera using a battery pack or directly using the AC adapter. If you connect the AC adapter to the camera while a battery pack is attached, the camera will draw power from the power outlet.

### Using a Battery Pack

You can power the camera using the supplied BP-A30 Battery Pack or the optional BP-A60 Battery Pack. Both battery packs are compatible with Intelligent System so you can check the approximate remaining battery usage time (in minutes) on the screen. For more accurate readings, when using a battery pack for the first time, charge it fully and then use the camera until the battery pack is completely exhausted.

### Charging the Battery Pack

Charge battery packs using the supplied CG-A20 Battery Charger and CA-CP200B Compact Power Adapter. Before charging, remove the terminal cover of the battery pack.

- 1 Connect the power cord to the CA-CP200B Compact Power Adapter.
  - For North America: Make sure you use the power cord for the CA-CP200B. See the sidebar below for information on differentiating the supplied power cords.
- 2 Connect the DC plug of the CA-CP200B Compact Power Adapter to the battery charger.
- 3 Plug the power cord of the CA-CP200B Compact Power Adapter into a power outlet.
- 4 Attach the battery pack to the CG-A20 Battery Charger.
  - Press lightly and slide the battery pack in the direction of the arrow until it clicks.
  - The CHARGE indicator starts flashing and also indicates the battery pack's approximate charge. The indicator will stay on when charging has completed.

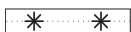

approx. 0% to 49%: Flashes once every 2 seconds

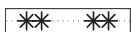

approx. 50% to 74%: Flashes twice every 2 seconds

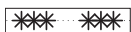

approx. 75% to 99%: Flashes 3 times every 2 seconds

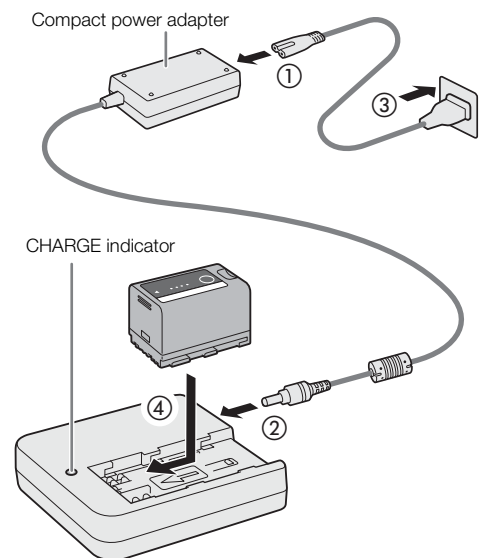

- 5 Remove the battery pack from the battery charger.
- 6 Unplug the power cord from the power outlet and disconnect the DC plug from the battery charger.
- 7 Disconnect the power cord from the compact power adapter.

### Differentiating the Supplied Power Cords (for North America)

The CA-A10 AC Adapter and CA-CP200B Compact Power Adapter each include a power cord. The plug for the CA-A10's power cord has a socket with a straight side, while the plug for the CA-CP200B's power cord has circular sockets.



CA-A10 power cord plug



CA-CP200B power cord plug

### ! IMPORTANT

- Do not connect to the battery charger any product that is not expressly recommended for use with this camera.
- When using the battery charger or compact power adapter, do not fix it permanently to one place as this may cause a malfunction.
- To prevent equipment breakdowns and excessive heating, do not connect the supplied battery charger or AC adapter to voltage converters for overseas travels or special power sources such as those on aircraft and ships, DC-AC inverters, etc.

### i NOTES

- We recommend charging the battery pack in temperatures between 10 °C and 30 °C (50 °F and 86 °F). Outside the temperature range of 0 °C to 40 °C (32 °F to 104 °F), charging will not start.
- If there is a malfunction with the battery charger, compact power adapter or battery pack, the charge indicator will go out and charging will stop.
- For handling precautions regarding the battery pack, refer to *Battery Pack* (📖 219).
- For approximate charging times, refer to the *Reference Tables* (📖 231). For approximate recording times with a fully charged battery pack, refer to the *Specifications* (📖 227).
- Charged battery packs continue to discharge naturally. Therefore, charge them on the day of use, or the day before, to ensure a full charge.
- We recommend that you prepare battery packs to last 2 to 3 times longer than you think you might need.
- Repeatedly charging and discharging the battery pack will eventually shorten its battery life. You can check the battery life on the [Battery/Hour Meter] status screen (📖 203). Fully charging the battery pack and then discharging it completely will give you a more accurate reading.
- **USA and Canada only:** The Lithium ion/polymer battery that powers the product is recyclable. Please call 1-800-8-BATTERY for information on how to recycle this battery.



### Attaching the Battery Pack

- 1 Set the **POWER** switch to OFF.
- 2 Insert the battery pack all the way into the compartment as shown in the illustration and press it gently toward the left until it clicks.

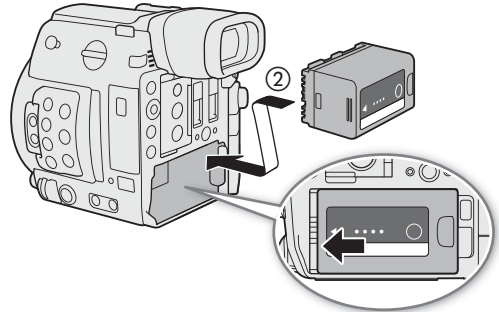
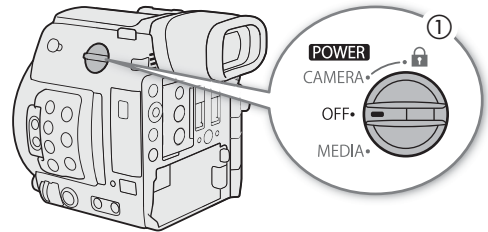

### Removing the Battery Pack

- 1 Set the **POWER** switch to OFF.
- 2 Holding down the BATTERY RELEASE button, slide the battery pack toward the right and then pull it out.

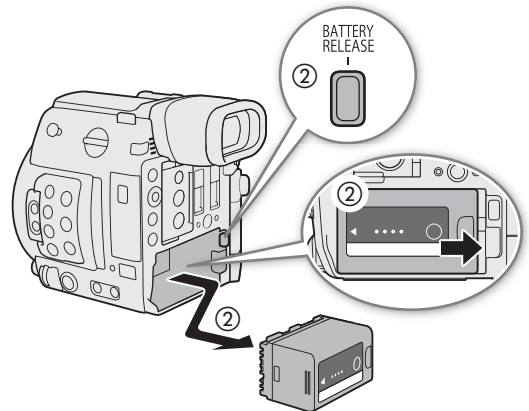

### Checking the Remaining Battery Charge

When the camera is turned on, you can check the approximate remaining battery usage time (in minutes) by looking at any recording/playback screen or the [Battery/Hour Meter] status screen (📖 203). You can also check the approximate charge level on the battery pack itself.

Press the CHECK button on the battery pack. An indicator will light for approximately 3 seconds and show the approximate remaining battery charge.

☼ ○ ○ ○	0-25%
☼ ☼ ○ ○	26-50%
☼ ☼ ☼ ○	51-75%
☼ ☼ ☼ ☼	76-100%

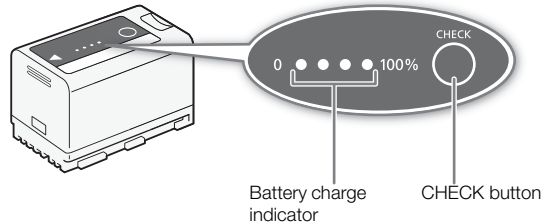

### Using a Power Outlet

You can also power the camera directly from a power outlet using the supplied CA-A10 AC Adapter. While the camera is powered using a power outlet, you can replace the battery pack even when the camera is turned on. North America only: The power cord for the CA-A10 AC Adapter is different from that for the CA-CP200B Compact Power Adapter. If you do not use the correct power cord, it will not connect to the AC adapter.

### Attaching the Ferrite Core

Before using the supplied CA-A10 AC Adapter, attach the supplied ferrite core to the power cord. This can help reduce the likelihood of RF interference.

- 1 Attach the ferrite core to the power cord about 4 cm (1.6 in.) from the plug that goes into the AC adapter.
- 2 Pass the cable through the center of the core and wrap it around the core twice and close the ferrite core.
  - For use in North America, you only need to wrap the cable around the core once.

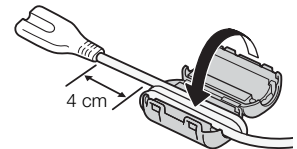

### Connecting the CA-A10 AC Adapter

- 1 Set the **POWER** switch to OFF.
- 2 Connect the AC adapter's DC plug to the DC IN terminal on the camera.
  - Align the cable so the red dot on the plug is facing up.
  - To disconnect the AC adapter, pull back the metallic tip of the plug and then disconnect the cable from the terminal.
- 3 Connect the power cord to the AC adapter and plug it into a power outlet.

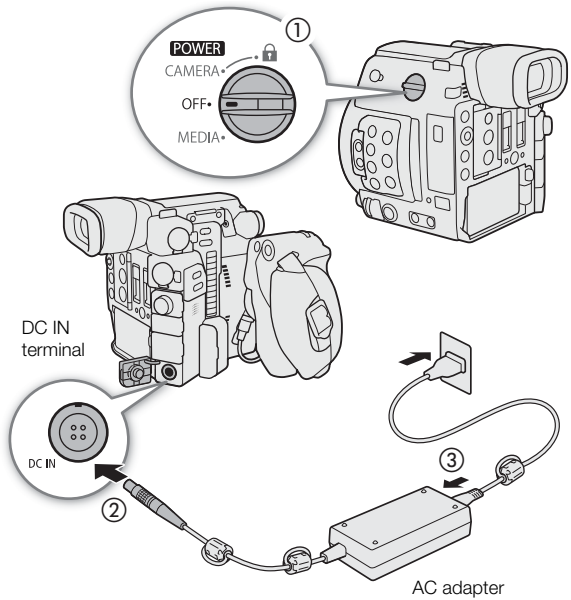

### ! IMPORTANT

- Make sure to turn off the camera before connecting or disconnecting the AC adapter.
- When using the AC adapter, do not fix it permanently to one place as this may cause a malfunction.

### Turning the Camera On and Off

The camera has two operating modes: CAMERA (CAMERA) mode for making recordings and MEDIA (MEDIA) mode for playing back recordings. Select the operating mode using the **POWER** switch.

#### To turn on the camera

Set the **POWER** switch to CAMERA for CAMERA mode or MEDIA for MEDIA mode.

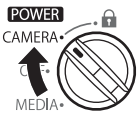

CAMERA mode



MEDIA mode

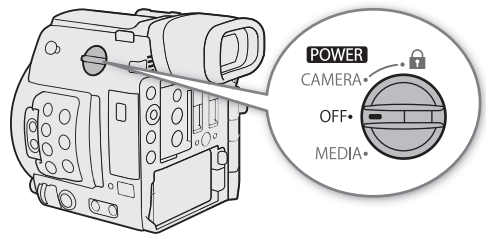

#### To turn off the camera

Set the **POWER** switch to OFF.

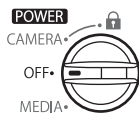

## Preparing the Handle Unit and LCD Monitor

### Attaching the HDU-2 Handle Unit

- 1 Attach the handle unit to the camera.
  - 2 Use the hex wrench<sup>1</sup> (for 0.64 cm, 1/4" screws) and turn the lock screw and hex socket head bolt<sup>1</sup> to secure the handle unit firmly.
- <sup>1</sup> Supplied with the HDU-2.

#### NOTES

- The handle unit has 0.64 cm (1/4") sockets, giving you the option to attach a variety of commercially available accessories.
- The handle unit has two through-holes (Ø 8.8 mm (0.35 in.)) that are 35.5 mm (1.4 in.) apart center-to-center.

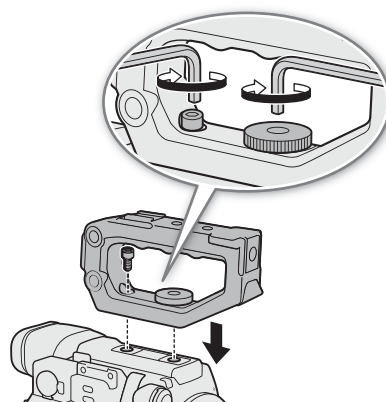

### Attaching and Removing the LM-V1 LCD Monitor

By attaching the LA-V1 LCD Attachment Unit<sup>1</sup> to the LM-V1 LCD Monitor<sup>1</sup>, you can attach the LCD monitor to the HDU-2 Handle Unit<sup>1</sup> or directly to the camera body itself. For details on adjusting the LCD monitor, refer to *Using the LCD Monitor* (□ 40) and *Adjusting the LCD Screen or Viewfinder* (□ 41). You can also use an optional LM-V2 LCD Monitor with the camera. If you use the LM-V2 in combination with an optional LA-V2 LCD Attachment Unit, you can attach it to the handle unit or camera unit in the same way as the LM-V1. The operating procedure of the LM-V2 and adjustment procedure of the screen are the same as for the LM-V1.

<sup>1</sup> Supplied accessory for the C200; optional accessory for the C200B.

### Attaching the LCD Monitor

To attach the LCD monitor to the handle unit

- 1 Set the **POWER** switch to OFF.
  - 2 Rotate the LCD monitor mount 180° toward the LCD attachment unit lock screw (①) and attach the LCD monitor (②).
- Align the ▲ marks on the LCD monitor and LCD monitor mount.
  - Use the hex wrench<sup>1</sup> (for 0.64 cm, 1/4" screws) to secure it firmly with the LCD monitor fixation bolt on the LCD monitor mount.
- <sup>1</sup> Supplied with the HDU-2.
- Based on your needs, you can mount the LCD monitor so that it faces toward or away from you.

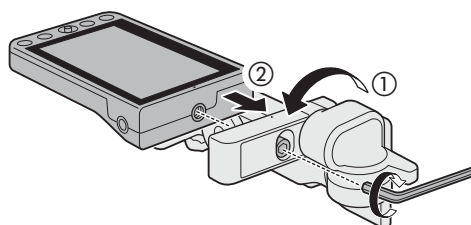



3 Align the LCD attachment unit mount to the handle unit's front accessory mount and then use the wrench to tighten the LCD attachment unit lock screw (③).

4 Rotate the LCD monitor mount 180° toward the handle unit (④).

5 Using the UN-5 Unit Cable<sup>2</sup>, connect the camera's VIDEO terminal to the LCD monitor's VIDEO terminal (⑤).

<sup>2</sup> Supplied accessory for the C200; optional accessory for the C200B.

- Align the ▲ marks on the cables' plugs and terminals.
- Put the cable through the LCD attachment unit's cable clamp (⑥). If necessary, adjust the position of the cable so that it does not get in the way of the lens.

**i** NOTES

- Depending on the situation, the screws may become loose. If necessary, use the hex wrench (for 0.64 cm, 1/4" screws) to tighten them.

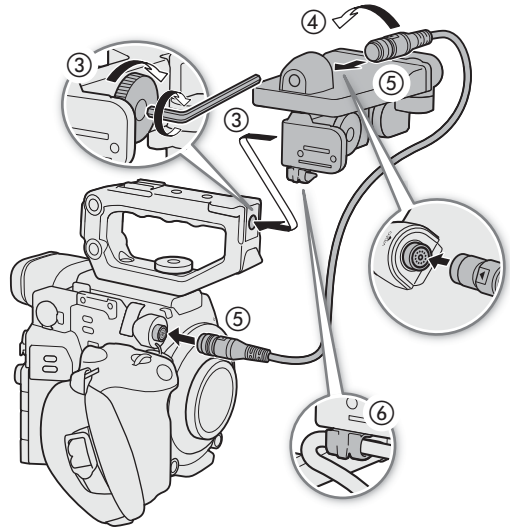

**To attach the LCD monitor to the camera**

1 Set the **POWER** switch to OFF.

- If the handle unit is attached to the camera, remove it.

2 Remove LCD attachment unit base 2 (②).

- Use a hex wrench (for 0.64 cm, 1/4" screws)<sup>1</sup>.

<sup>1</sup> Supplied with the HDU-2.

3 Attach LCD attachment unit base 2 to the camera (③).

- Use the hex wrench to secure it firmly with the hex socket head bolt.

4 Rotate LCD attachment unit pivot B 90° toward the SD card slots and then rotate the LCD monitor mount 180° toward the tape measure hook (④).

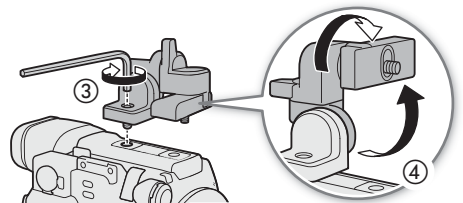
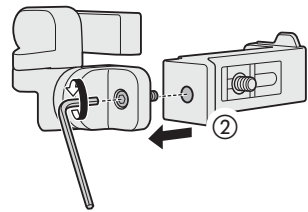

5 Attach the LCD monitor.

- Use the socket for 1/4"-20 screws on the bottom of the LCD monitor.
- Use the hex wrench to secure it firmly with the hex socket head bolt.

6 Rotate LCD attachment unit pivot A 180° toward the SD card slots and then rotate pivot B 90° toward the lens (6).

7 Using a UN-5 Unit Cable<sup>2</sup>, connect the camera's VIDEO terminal to the LCD monitor's VIDEO terminal (7).

<sup>2</sup> Supplied accessory for the C200; optional accessory for the C200B.

- Align the ▲ marks on the cables' plugs and terminals.

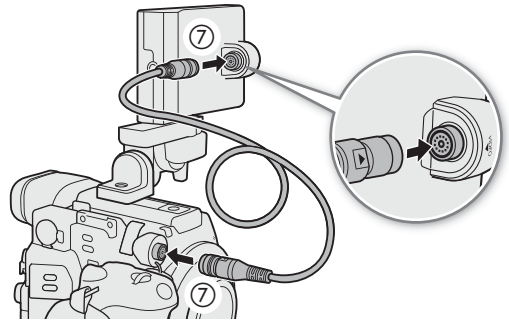
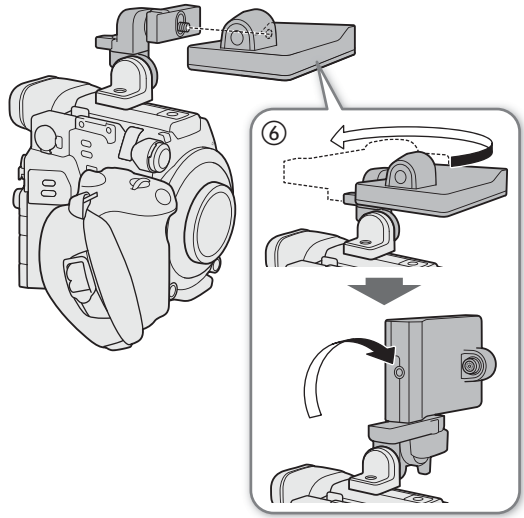

Removing the LCD Monitor and LCD Attachment Unit

1 Set the **POWER** switch to OFF.

2 Disconnect the unit cable from the camera's and monitor's VIDEO terminal (2).

- Pull back the metallic tip of the plug and then disconnect the cable from the terminal.

3 Unscrew the LCD attachment lock screw and then remove the LCD attachment unit and monitor (3).

**!** IMPORTANT

- Be careful not to drop the camera when attaching or removing the LCD monitor.

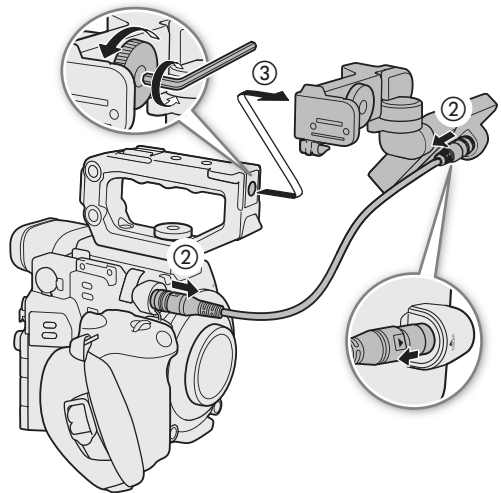

## Date, Time and Language Settings

### Setting the Date and Time

You will need to set the date and time on the camera before you can start using it. When the internal clock is not set, or if the settings were lost because the lithium button battery is depleted, the [Date/Time] screen will appear automatically with the time zone selected when you turn on the camera.

Operating modes: CAMERA MEDIA | RAW MP4 XF-AVC







1 Push the joystick up/down to select the desired time zone and then press the joystick itself to move to the next field.

- To move to the next field you can also push the joystick right.
- The default time zone is [UTC-05:00] (New York) or [UTC+01:00] (Central Europe), depending on the country/region of purchase. Time zones are based on Coordinated Universal Time (UTC).

2 Change the rest of the fields in the same way.

3 Select [Set] and then press the joystick to start the clock and close the screen.



#### NOTES

- You can display the date/time in CAMERA mode with the **MENU** ➤ [ 6] Monitoring Setup] ➤ [Custom Display 2] ➤ [Date/Time] setting and in MEDIA mode with the **MENU** ➤ [ 5] Monitoring Setup] ➤ [Custom Display] ➤ [Date/Time] setting.
- With the following settings, you can change the time zone, date and time also after the initial setup. You can also change the date format and clock format (12 or 24 hours).
  - **MENU** ➤ [ 1] System Setup] ➤ [Time Zone], [Date/Time] and [Date Format]
- When the built-in rechargeable lithium battery is exhausted, the date and time setting may be lost. In such case, recharge the built-in lithium battery ( 220) and set the time zone, date and time again.
- Using the optional GP-E2 GPS Receiver, you can have the camera adjust settings automatically according to the UTC date/time information received from the GPS signal ( 111).

## Changing the Language

The camera's default language is English. You can change it to German, Spanish, French, Italian, Polish, Portuguese, Russian, Simplified Chinese, Korean or Japanese. Please note that some settings and screens will be displayed in English, regardless of the language setting.

Operating modes: CAMERA MEDIA | RAW MP4 XF-AVC

- 1 Press the MENU button.
- 2 Push the joystick up/down to select [ 1 System Setup] and then press the joystick.
- 3 Select [Language ] in a similar fashion and then press the joystick.
- 4 Push the joystick up/down to select a language.
- 5 Press the joystick to change the language and then press the MENU button to close the menu.

## Using the Menu

Many of the camera's functions can be adjusted from the menu that opens after pressing the MENU button. In **CAMERA** mode, you can also register frequently used menu settings in a customized submenu (My Menu) for easy access. For details about the available menu options and settings, refer to *Menu Options* (185).

Operating modes: **CAMERA** **MEDIA** | **RAW** **MP4** **XF-AVC**

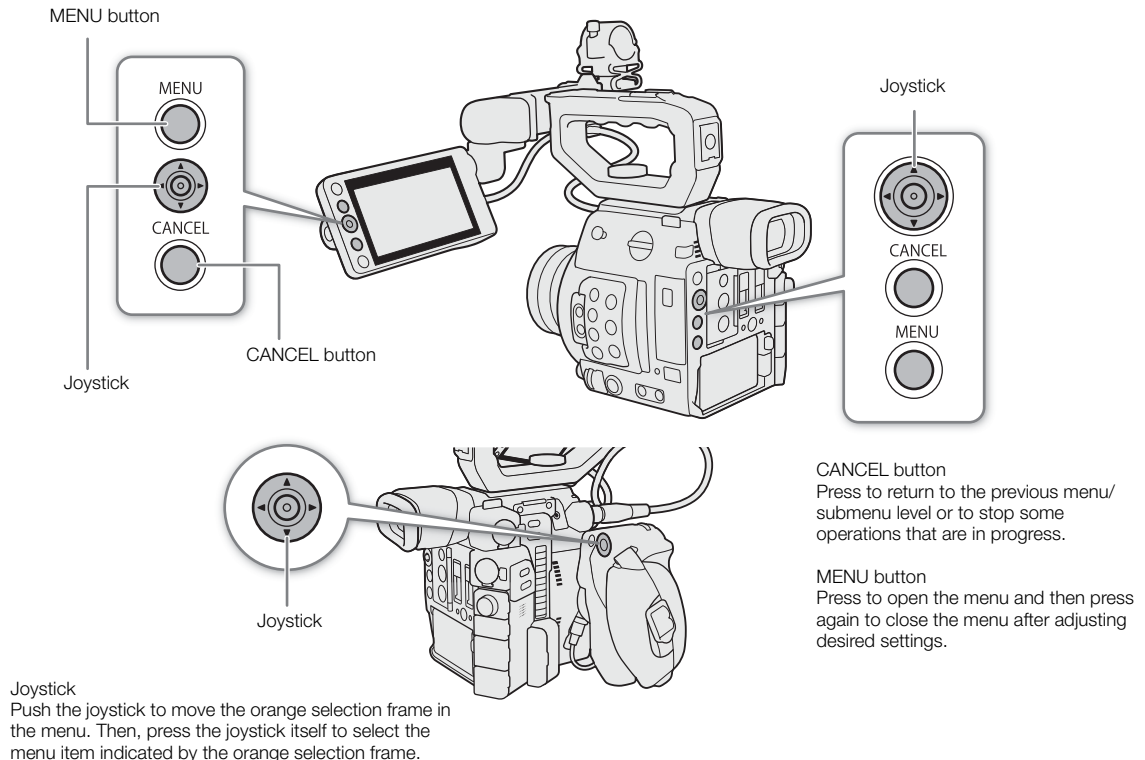

### Selecting an Option from the Menu

The following is a step-by-step explanation of how to select an option from the menu for most menu items. For some menu items, refer also to the function's description for additional operations that may be necessary. In the procedures throughout the rest of this manual, closing the menu is assumed and not included in the procedure.

#### 1 Press the MENU button.

- The menu opens with the orange selection frame indicating the menu item that was selected the previous time the menu was closed (unless the camera was turned off).

#### 2 Push the joystick left/right to select the desired submenu.



- To select a different submenu, push the joystick up/down repeatedly or press the CANCEL button until the current submenu icon is highlighted in orange.

#### 3 If the orange selection frame does not appear on a menu item in the submenu, push the joystick down or press the joystick.

- The orange selection frame will appear on a menu item.

- 4 Push the joystick left/right to select the desired “page” number and then up/down to select the desired menu item.
- 5 Press the joystick.
  - Setting options will appear with a ► mark next to the currently selected option.
- 6 Push the joystick up/down to select the desired setting option and then press the joystick.
- 7 Press the MENU button to close the menu.

### NOTES

- For brevity's sake, references in the text to settings in the setup menus will include only the tab of the desired menu, page number and the setting name. For example, “You can adjust the date and time later on with the **MENU** ► [  1 System Setup] ► [Date/Time] setting.”
- Unavailable items may appear grayed out.
- Pressing the MENU button at any time closes the menu.
- On some screens, the following icons may be displayed as a guide: **SET**, **MENU**, **CANCEL**. They refer, respectively, to pressing the joystick (or SET button on the GR-V1 Camera Grip or a remote control), the MENU button and the CANCEL button.
- When an optional RC-V100 Remote Controller is connected to the camera, you can use the remote controller's up/down/left/right/SET buttons in the same way as the camera's joystick. Pressing the SET button is equivalent to pressing the joystick on the camera.
- You can check most of the current settings on the status screens ( 196).

## Using the Customized Submenu (My Menu)

You can register up to 6 frequently used menu settings under a My Menu submenu for easy access. You can save up to 5 separate sets of My Menu settings so you can customize different options for different shooting situations. Furthermore, if you set an assignable button to [My Menu] ( 125), you can press the button to access your registered menu settings even faster and more easily.

### Selecting a My Menu Set

- 1 Open the My Menu screen.  
**MENU** ► [  My Menu]
- 2 Select the desired My Menu set and then press the joystick.

### Adding Menu Settings

- 1 Open the My Menu [Register] screen.  
**MENU** ► [  My Menu] \* ► [Edit] ► [Register]
- \* Each My Menu set appears on a different page. Select the page that corresponds to the desired set.
  - Press the CANCEL button to cancel the operation and return to the regular menu.
- 2 Navigate the menus to find the menu setting you want to add and then press the joystick.
- 3 Select [OK] and then press the joystick twice.
  - The menu setting you registered will now appear under the currently selected My Menu set.

## Rearranging Menu Settings

1 Open the My Menu [Move] screen.

**MENU** ➤ [★ My Menu] \* ➤ [Edit] ➤ [Move]

\* Each My Menu set appears on a different page. Select the page that corresponds to the desired set.

2 Push the joystick to select the setting you want to move and then press the joystick.

- The  icon will appear next to the setting you selected to move.

3 Push the joystick up/down to move the setting to the desired position and then press the joystick.

## Removing Menu Settings

1 Open the My Menu [Delete] screen.

**MENU** ➤ [★ My Menu] \* ➤ [Edit] ➤ [Delete]

\* Each My Menu set appears on a different page. Select the page that corresponds to the desired set.

2 Push the joystick to select the setting you want to remove and then press the joystick.

3 Select [OK] and then press the joystick twice.

## Resetting the My Menu Submenu

1 Reset all the menu settings registered to the currently selected My Menu set.

**MENU** ➤ [★ My Menu] \* ➤ [Edit] ➤ [Reset All]

\* Each My Menu set appears on a different page. Select the page that corresponds to the desired set.

2 Select [OK] and then press the joystick twice.

## Renaming the Selected My Menu Set

You can give each of the 5 My Menu sets a more descriptive name to make them easier to identify.

1 Open the My Menu [Rename] screen.

**MENU** ➤ [★ My Menu] \* ➤ [Edit] ➤ [Rename]

\* Each My Menu set appears on a different page. Select the page that corresponds to the desired set.

2 Enter the desired name (8 characters long) using the keyboard screen ( 35).

3 Select [OK] and then press the joystick.

## Using the Virtual Keyboard Screen

1 Use the joystick to select a character and then press the joystick to add it.

- Push the joystick up/down/left/right to select the desired character and press the joystick to enter it. Use the arrows (↑/↓/←/→) to change the position of the cursor and the backspace character () to delete the last character entered.
- Repeat this step as necessary to enter the desired text.
- Some characters will not be available, depending on the function.

2 After entering the desired text, select [OK] and then press the joystick to close the keyboard screen.



Current character / Character limit

## Preparing the Camera

This section outlines the basic preparations for the camera such as attaching a lens and attaching the modular units to the camera: GR-V1 Camera Grip<sup>1</sup>, thumb rest, eye cup<sup>1</sup>, etc.

<sup>1</sup> Supplied accessory for the C200; optional accessory for the C200B.

### Configuring the Modular Units

Your camera is nothing if not versatile and you can choose the configuration that best fits your needs and shooting conditions.

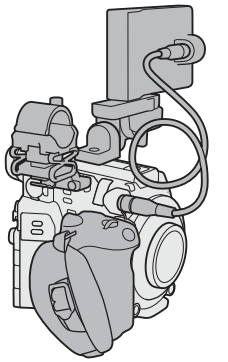
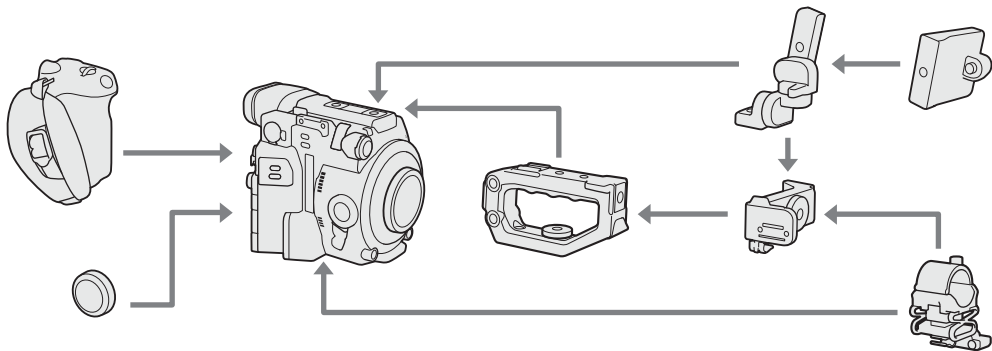

Configuration with LCD monitor and camera grip

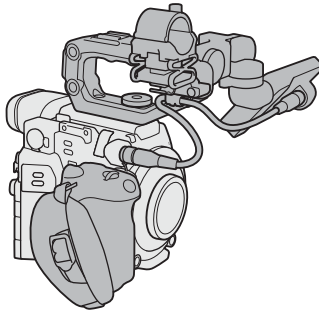

Configuration with LCD monitor, camera grip and handle

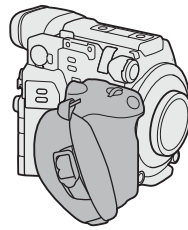

Light configuration with grip for hand-held shooting

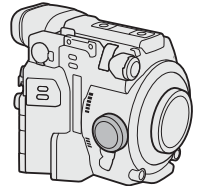

Minimal configuration with thumb rest

#### ! IMPORTANT

- Be careful not to drop the camera or modular units when attaching, removing or adjusting the various accessories. Use a table or other stable surface to change the camera's configuration.

#### i NOTES

- **Compatibility with the optional SU-15 Shoulder Support Unit:** The camera is compatible with the optional SU-15 Shoulder Support Unit, which allows you to use the camera in a shoulder-mounted fashion. Attach the SU-15 to the camera using the camera mount through holes close to the tripod base. For details, refer to the SU-15's instruction manual.

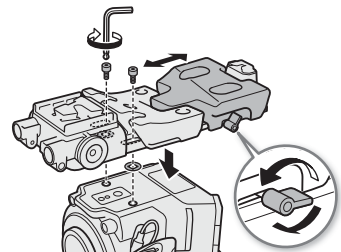



- You can use the optional RD-1 Rod Clamp to use the camera with a commercially available viewfinder or other accessories with a  $\varnothing$  15 mm (0.59 in.) rod.

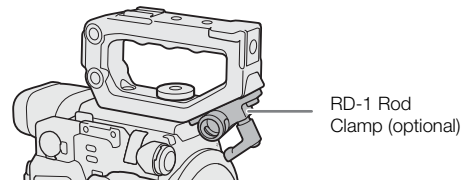

## Preparing the Lens

As much as possible, attach and remove the lens quickly and in a clean environment free of dust. Refer also to the instruction manual of the lens used.

### ! IMPORTANT

- When attaching/removing a lens, avoid direct sunlight or strong light sources. Also, be careful not to drop the camera or lens.

### i NOTES

- After removing a lens/When a lens is not attached to the camera:
  - Do not touch the lens's surfaces, the lens mount or any components inside the lens mount area.
  - Place the body cap back on the lens mount and the dust caps on the lens. Clean any dust or dirt from the body cap and dust caps before using them.

## Attaching an EF Lens

- 1 Set the **POWER** switch to OFF.
- 2 Remove the body cap from the camera and the dust caps from the lens.
- 3 Attach the lens to the camera and turn the lens in the direction of the arrow until it clicks in place.
  - EF lenses: Align the red mark on the lens with the red EF Lens mount index mark on the camera.
  - EF-S lenses: Align the white mark on the lens with the white EF-S Lens mount index mark on the camera.

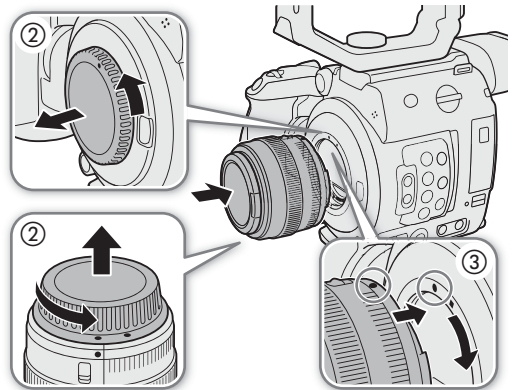

## Removing an EF Lens

- 1 Set the **POWER** switch to OFF.
- 2 Hold down the lens release button and turn the lens all the way in the direction of the arrow until it stops.
- 3 Remove the lens and replace the body cap on the camera and the dust caps on the lens.

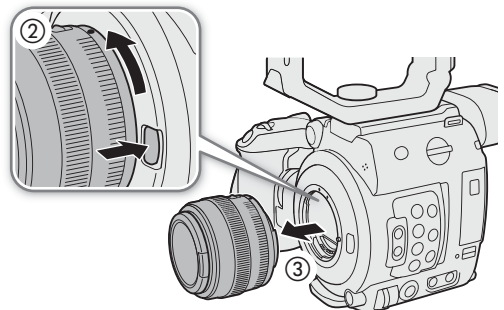

**i** NOTES

- Turning on the image stabilization function of an EF lens may reduce the effective usage time of the battery pack. When image stabilization is not necessary, for example if the camera is fixed to a tripod, it is recommended to turn it off.
- Depending on the lens used, you may experience one or more of the following limitations.
  - The lens model name may be shortened when displayed on the screen.
  - You may not be able to focus manually when the focus mode switch is set to AF.
  - You may not be able to use the focus preset function on super telephoto lenses.
  - You may not be able to use the power zoom function on lenses with that function.
- This camera's sensor is larger than the sensor size for which EF-S lenses are designed (APS-C). When using EF-S lenses with this camera, you may notice peripheral illumination fall-off or vignetting.
- When using a compatible lens, you can use the **MENU** ➤ [**F** 6] System Setup] ➤ [Retract Lens] setting (📖 194) to retract the lens automatically when the camera's power is turned off.

**Updating the Firmware of an EF Lens**

You can update the lens firmware of the EF lens attached to the camera. For details about firmware updates for EF lenses, visit your local Canon website.

Operating modes: CAMERA | MEDIA | RAW | MP4 | XF-AVC

- 1 Download the lens firmware update file from the Canon website and save it on an SD card. Insert the SD card containing the lens firmware update into SD card slot B.
- 2 Attach the lens you wish to update to the camera and open the lens firmware submenu.
  - MENU** ➤ [**F** 6] System Setup] ➤ [Firmware] ➤ [Lens]
  - The current lens firmware version will appear on the screen.
  - If the [Lens] option is grayed out, the attached lens may not support firmware updates, the SD card may be in SD card slot A or the SD card used may not contain a valid lens firmware file. Check the lens and SD card and repeat the procedure from the beginning.
- 3 Select [OK] and then press the joystick.
- 4 Select the lens firmware file (file extension .LFU) and then press the joystick.
- 5 Select [OK] and then press the joystick
  - The lens firmware will be updated. Once in progress, the lens firmware update cannot be canceled.
- 6 When the confirmation message appears, press the joystick.

**!** IMPORTANT

- Be sure to observe the following precautions while the lens firmware is being updated.
  - Do not disconnect the power source or turn off the camera.
  - Do not remove the lens.
  - Do not operate any buttons or controls on the camera.
  - Do not open the SD card slot cover and do not remove the SD card.

**i** NOTES

- The lens firmware cannot be updated while pre-recording is activated.
- We recommend that you power the camera from a power outlet using the AC adapter or use a sufficiently charged battery pack.
- When using an optional EF Extender, remove the Extender before performing the procedure.

## In-Camera Lens Correction

Depending on the characteristics of the lens used, the corners of an image frame may be darker than the center due to light fall-off (peripheral illumination drop), or color shift/color fringing may be visible along high-contrast edges in the image (chromatic aberration). If the camera has correction data available for the EF lens used, it can apply this correction data to compensate as necessary.

Operating modes: CAMERA MEDIA | RAW MP4 XF-AVC

- 1 Attach the lens you want to use.
- 2 Open the desired correction screen.
  - MENU** [P] [6] Camera Setup] [Periph. Illum. Corr.] or [Chromatic Aberr. Corr.]
    - If correction data is not available, the corresponding menu option will appear grayed out. Visit your local Canon website and check if there is correction data available for the lens you are using. If so, download the necessary update package and upgrade the camera's firmware following the instructions supplied therein.
- 3 Select [On] and then press the joystick
  - As long as **MENU** [P] [6] Camera Setup] [Periph. Illum. Corr.] or [Chromatic Aberr. Corr.] is set to [On], the camera will automatically apply the appropriate correction data.

## Correction for EF-S Lenses

The peripheral illumination fall-off may be more pronounced with EF-S lenses than with EF lenses. To prevent this, when you use an EF-S lens, you can change the image area that is used for producing the image.

Operating modes: CAMERA MEDIA | RAW MP4 XF-AVC

- 1 Open the [EF-S Lens] submenu.
  - MENU** [P] [5] Camera Setup] [EF-S Lens]
- 2 Select [On] and then press the joystick.
  - **[EF-S]** will appear at the lower center of the screen.
  - When [EF-S Lens] is set to [On], the image is enlarged digitally by a factor of approximately 1.04x, slightly affecting the image quality. In most cases, using the default [Off] setting is recommended.

### NOTES

- **About in-camera lens correction data:** The camera contains a register of correction data for compatible lenses that were available at the time the camera went on sale. Correction data for future lenses will be made available as part of the regular updates released for the camera's firmware. For more details, visit your local Canon website.
- No peripheral illumination/chromatic aberration correction will be applied in the following cases:
  - When the appropriate correction data is not available for the lens attached.
  - When using non-Canon lenses. Even if the corresponding menu setting is available (not grayed out), setting it to [Off] is recommended.
- When peripheral illumination correction is activated:
  - Depending on the recording conditions, noise may appear in the periphery of the image as a result of the correction.
  - The level of correction will be lower for lenses that cannot provide distance information.
  - The level of correction will be lower the higher the ISO speed/gain setting used.
  - When using EF-S lenses, peripheral illumination fall-off may be more pronounced.

## Using the LCD Monitor

You can rotate and position the LCD monitor in a number of ways to match your shooting style.

### 1 Rotate the LCD monitor mount 90° toward the lens.

- Make sure LCD attachment unit alignment mark ① (on LCD attachment unit pivot A) and – (on the LCD monitor mount) are aligned.

### 2 Rotate LCD attachment unit pivot B 180° toward the CFast card slot.

- Make sure LCD attachment unit alignment mark ② (on LCD attachment base 2) and – (on LCD attachment unit pivot B) are aligned.

### 3 Adjust the LCD monitor to the desired position.

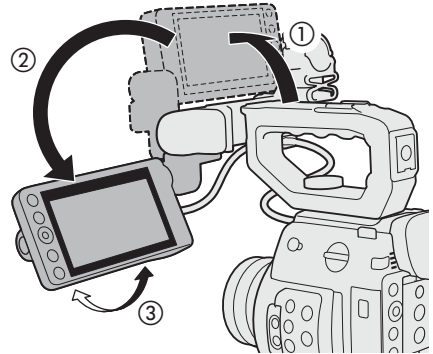

**C200** You can use the viewfinder and watch the LCD screen at the same time

## **i** NOTES

- Based on the LCD monitor's position, you can invert the image displayed on the screen. Repeatedly pressing the MIRROR button will change the displayed image in the following order: Image inverted horizontally → Image inverted vertically → Image inverted horizontally and vertically → Original image. When the image is inverted only horizontally or vertically, the camera's onscreen displays will be turned off.
- You can use the **MENU** ➤ [Y 5 System Setup] ➤ [Touch Screen Response] setting to adjust the LCD monitor's response to touch input.

## **C200** Using the Viewfinder

The camera's viewfinder features an OLED screen that turns on automatically when you look through the viewfinder. The screen also turns off automatically shortly after you stop using the viewfinder.

### Adjusting the Viewfinder

- 1 Adjust the angle as necessary.
- 2 Turn on the camera and adjust the dioptic adjustment lever until the viewfinder's image is sharp.

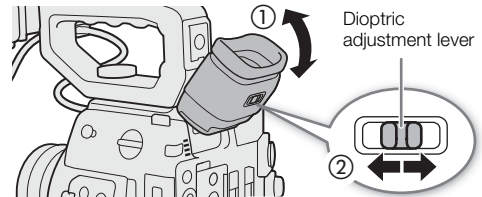

## **i** NOTES

- You can turn on the viewfinder permanently by setting **MENU** ➤ [INFO 3 Monitoring Setup] ➤ [VF Eye Sensor] to [Off].

### Attaching and Removing the Eye Cup

Attach the eye cup so that it covers the rubber rim of the viewfinder unit. To remove the eye cup, pull it gently in a "peeling off" motion from the bottom up.

- For left eye use, attach the eye cup so that the protruding part faces the opposite side.

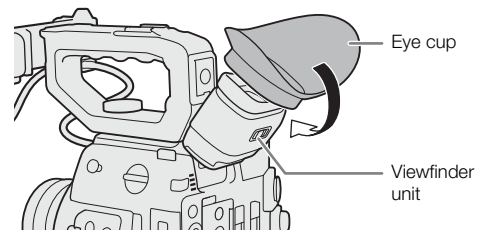

**!** IMPORTANT

- Pointing the viewfinder lens at the sun or other strong light sources may cause damage to internal components. When you are not using the viewfinder, make sure to attach the viewfinder cap to the viewfinder. This will also protect the viewfinder from scratches and dirt. Attach the viewfinder cap by inserting it into the rubber rim of the viewfinder unit.

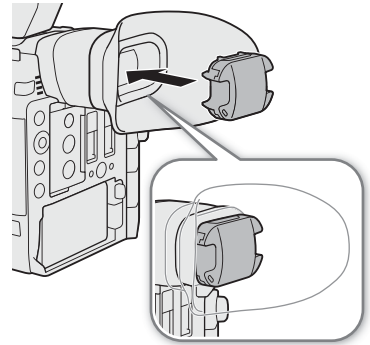
**Adjusting the LCD Screen or Viewfinder (C200 only)**

You can adjust the brightness, contrast, color, sharpness, and luminance level of the LCD screen and viewfinder independently of each other. These adjustments will not affect your recordings.

Operating modes: CAMERA MEDIA | RAW MP4 XF-AVC

1 Open the setup menu for the LCD screen or viewfinder.

- MENU** ➤ [MENU] [1] Monitoring Setup] (for the LCD screen) or [MENU] [3] Monitoring Setup] (for the viewfinder)
- Select the desired brightness, contrast, color, sharpness or luminance setting and then press the joystick.
  - When the viewfinder is turned off, the menu items will appear grayed out.
- Select the desired level and then press the joystick.
  - Repeat steps 2 and 3 to adjust other settings as necessary.

**Menu items by setting**

Setting	Menu item	
	LCD screen	Viewfinder
Brightness	[LCD LM-V1 Brightness]	[VF Brightness]
Contrast	[LCD LM-V1 Contrast]	[VF Contrast]
Color	[LCD LM-V1 Color]	[VF Color]
Sharpness	[LCD LM-V1 Sharpness]	[VF Sharpness]
Luminance	[LCD LM-V1 Luminance]	[VF Luminance]

**i** NOTES

- When the optional LM-V2 LCD Monitor is connected, adjust it with the **MENU** ➤ [MENU] [2] Monitoring Setup] ➤ “LCD LM-V2” setting items.
- If you set an assignable button to [LCD LM-V1 Setup], [LCD LM-V2 Setup] or [Viewfinder Setup] (125), you can press the button to open the [MENU] [1] Monitoring Setup] menu [MENU] [2] Monitoring Setup] menu or [MENU] [3] Monitoring Setup] menu, respectively.
- About the LCD and viewfinder screens:** The screens are produced using extremely high-precision manufacturing techniques, with more than 99.99% of the pixels operating to specification. Very rarely, pixels may misfire or may light up permanently as white dots. This has no effect on the recorded image and does not constitute a malfunction

### Setting the Screen to Black & White

The viewfinder and LCD screen display in color by default but you can set them to black & white. Even when the screen is black & white, onscreen text and icons will still be displayed in color.

Operating modes: CAMERA MEDIA | RAW MP4 XF-AVC

1 Open the display selection menu for the viewfinder or LCD screen.

**MENU** **[INFO]** **[5]** Monitoring Setup<sup>1</sup> **[>]** [B&W Image: VF Output] (**C200** only) or [B&W Image: VIDEO Output]

<sup>1</sup> **C200B** Appears on the previous page in the menu.

2 Select [On] and then press the joystick.

### Using a Tripod

The camera is shipped with the TB-1 Tripod Base. When mounting the camera on a tripod with 0.95 cm (3/8") mounting screws, use the tripod socket for tripods with 0.95 cm (3/8") screws; for a tripod with 0.64 cm (1/4") screws, use the tripod socket for tripods with 0.64 cm (1/4") screws.

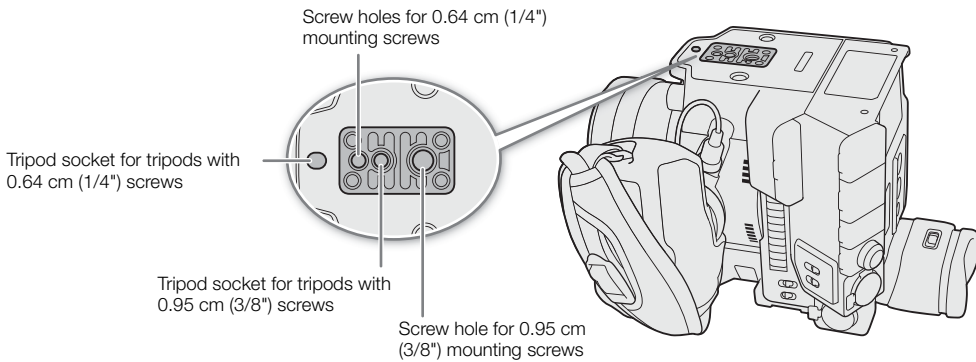

#### ! IMPORTANT

- Do not use tripods with mounting screws exceeding the depth of the screw holes on the camera as this may damage the camera.

## Removing and Attaching the GR-V1 Camera Grip

The camera grip comes originally attached to the C200; it is an optional accessory for the C200B. You can remove it and replace it with the thumb rest should the minimal configuration be necessary.

### Removing the Camera Grip

- 1 Set the **POWER** switch to OFF.
- 2 Unscrew the camera grip's lock screw and gently detach the camera grip.
  - The camera grip contains an internal connection cable so be sure not to pull it too forcefully.
- 3 Remove the grip attachment ring and disconnect the camera grip's connection plug.
  - You can attach the grip attachment ring to the connection cable so that you do not lose it.

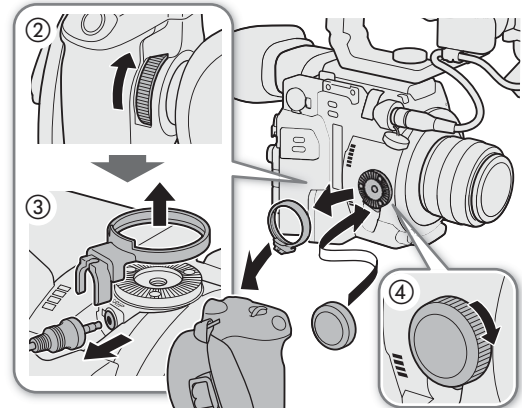
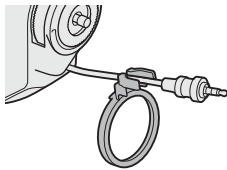

- 4 Screw the thumb rest onto the camera.

### Attaching the Camera Grip

The camera grip can be attached in a number of positions from 90° toward the lens to 60° toward the viewfinder at 6° intervals.

- 1 Set the **POWER** switch to OFF.
- 2 Unscrew the thumb rest and remove it from the camera.
- 3 Lay the camera on a flat, stable surface with the rosette facing up.
- 4 Firmly insert the camera grip's plug all the way into the camera grip connection terminal on the camera.
  - Make sure to insert the plug all the way in, until the terminal is not visible.
  - If the plug is not correctly connected, all the controls on the camera may be disabled.
- 5 Attach the grip attachment ring.
- 6 Return the camera to an upright position, with the top side facing upward.
- 7 Attach the camera grip to the camera aligning it at the desired angle and tighten the camera grip's lock screw.

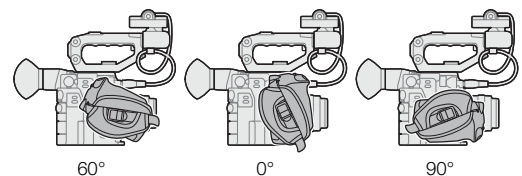
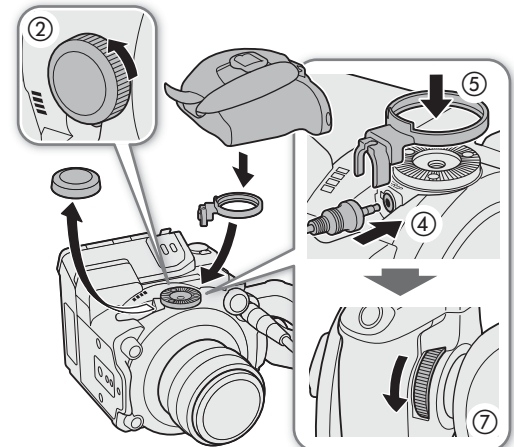

### Adjusting the Grip Belt

Adjust the grip belt so that you can reach the REC button on the camera grip with your index finger but still have a comfortable but secure grip.

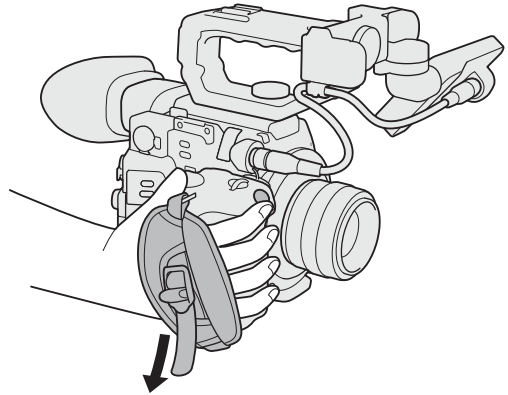

### Attaching the Microphone Holder

- 1 Attach the microphone holder to the LCD attachment unit.
  - You can also attach the microphone holder to the camera directly.
- 2 Use a commercially available Phillips head (“crosshead”) screwdriver to secure it firmly with the supplied M4 bolts.

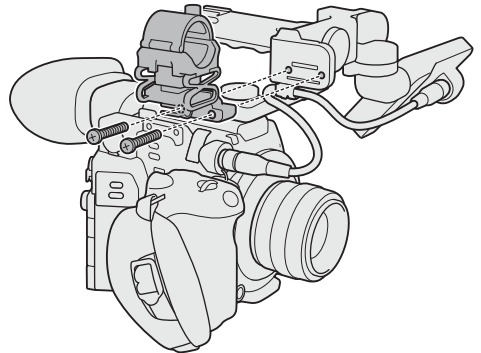

### Attaching the Shoulder Strap

The SS-1200 Shoulder Strap is supplied with the C200 while it is an optional accessory for the C200B.

Pass the ends through the strap mount and adjust the length of the strap.

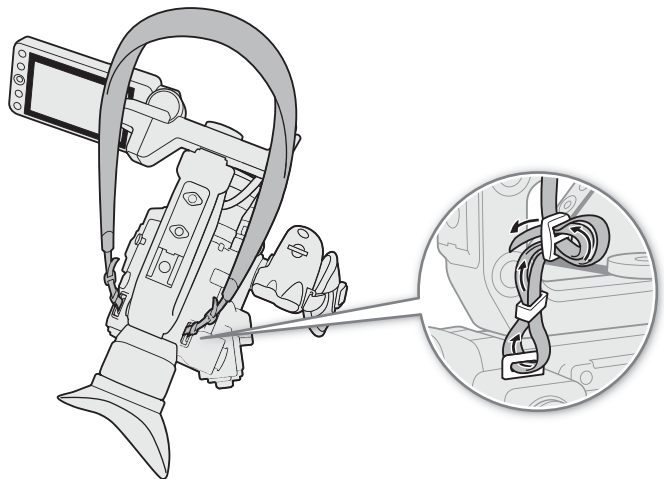



## Removing and Attaching the Terminal Covers

You can remove the covers of the camera's terminals to access them more easily.

### Removing the Terminal Covers

Open the terminal cover and gently pull it straight out.

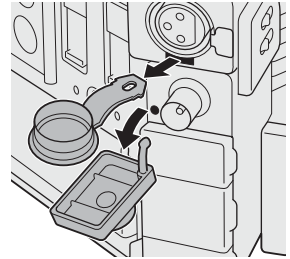

45

### Attaching the Terminal Covers

Insert the connecting strip into the opening to attach the terminal cover.

#### **i** NOTES

- If the connecting strip is difficult to grasp, use a pair of tweezers or similar tool.

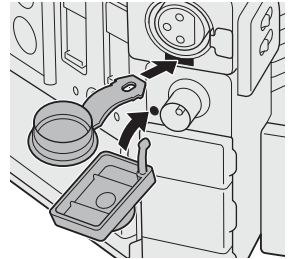

## Using the Optional EVF-V70 Electronic Viewfinder

You can attach the optional EVF-V70 OLED Electronic Viewfinder (1920x1080 pixels) to the camera instead of the LCD monitor and use the buttons and dials on the EVF-V70 to operate the camera. Attaching the EVF-V70 also requires attaching the handle unit<sup>1</sup> and optional CL-V2 Clamp Base. The assistance functions that can be output to the LCD monitor through the VIDEO terminal will also be output to the EVF-V70.

<sup>1</sup> Supplied accessory for the C200; optional accessory for the C200B.

- 1 Attach the handle unit ( 28).
- 2 Set the **POWER** switch to OFF.
- 3 Perform the steps up to, but not including, attaching the clamp base to the camera described in the EVF-V70's instruction manual (steps 1 to 4 of *Attaching the Viewfinder*).
- 4 Attach the optional CL-V2 Clamp Base to the handle unit.
  - Use a hex wrench\* to secure it firmly with the hex socket head bolts\*.
  - \* Supplied with the clamp base.
- 5 Attach the EVF-V70.
  - Perform the steps after attaching the clamp base to the camera described in the EVF-V70's instruction manual (steps 6 to 11 of *Attaching the Viewfinder*).

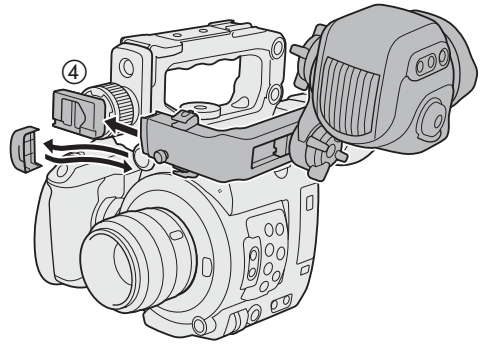
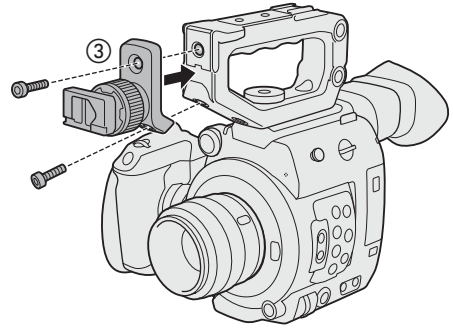

## Preparing Recording Media

The camera records clips<sup>1</sup> on CFast or SD cards<sup>2</sup> and photos on SD cards. The camera features two SD card slots. When you insert two SD cards in the camera, the camera can record 4K clips simultaneously on both cards, or it can switch automatically to recording on the other SD card when an SD card becomes full.

Initialize recording media (📷 50) when you use them with this camera for the first time.

<sup>1</sup> Clips that are, in general, intended to be a deliverable are referred to as “primary clips” while clips that are intended to be edited offline are referred to as “proxy clips”. Primary clips are recorded to the CFast card (for RAW clips) or SD card (for MP4 or XF-AVC clips); proxy clips can be in MP4 or XF-AVC format and are recorded only to the SD card.

<sup>2</sup> The SD card is used also to save custom picture files and menu settings files.







### Compatible Recording Media

The following types of memory card can be used with this camera. For the latest information about recording media tested for use with this camera, visit your local Canon website.

#### CFast cards

CFast 2.0-compliant cards.

#### SD cards<sup>1</sup>

SD card type:			
	SD cards	SDHC cards	SDXC cards
UHS Speed Class <sup>2, 3</sup> :			
SD Speed Class <sup>2, 3</sup> :			

<sup>1</sup> As of February 2018, the clip recording function has been tested using SD cards made by Panasonic, Toshiba and SanDisk.

<sup>2</sup> UHS and SD Speed Class are standards that indicate the minimum guaranteed data transfer rate of SD cards.

<sup>3</sup> To record XF-AVC clips, we recommend using SD cards rated Speed Class 10, or UHS Speed Class 1 or 3. To record 4K clips (3840x2160) or clips using slow motion recording mode, we recommend using SD cards rated UHS Speed Class 3.

#### ! IMPORTANT

- CFast cards can become hot due to the high operating temperature inside the camera. Removing a CFast card immediately after using it for recording may cause burns or cause you to drop the CFast card, resulting in damage to the card.
- **About CFast and SDXC cards:** You can use CFast and SDXC cards with this camera but these types of cards are initialized by the camera using the exFAT file system.
  - When using exFAT-formatted cards with other devices (digital recorders, card readers, etc.), make sure that the external device is compatible with exFAT. For more information on compatibility, contact the computer, operating system or memory card manufacturer.
  - If you use exFAT-formatted cards with a computer OS that is not exFAT-compatible, you may be prompted to format the card. In such case, **cancel the operation to prevent data loss**.
- After repeatedly recording, deleting and editing clips (if the memory is fragmented), you may notice slower writing speeds to the recording media and recording may even stop. In such case, save your recordings and initialize the recording media with the camera. Be sure to initialize recording media especially before shooting important scenes.

#### i NOTES

- Proper operation cannot be guaranteed for all recording media.

### Inserting a CFast Card

- 1 Slide the CFast card slot cover switch in the direction of the arrow.
  - The CFast card slot cover will open.
- 2 Insert the CFast card straight, with the label facing the SD card slots, all the way into the slot.
- 3 Close the CFast card slot cover.
  - Do not force the cover closed if the CFast card is not correctly inserted.

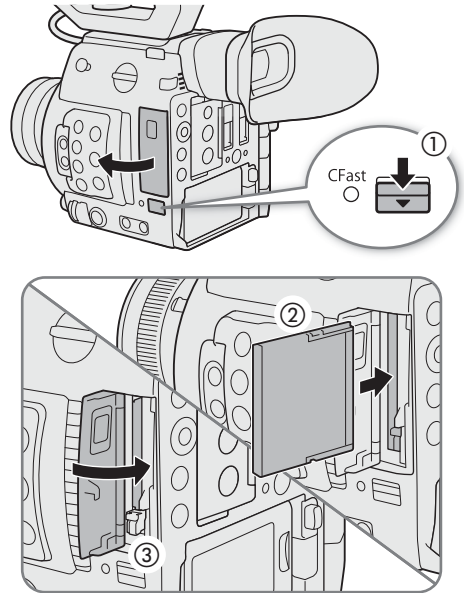

### CFast card access indicator

CFast indicator	CFast card status
Red	Accessing the CFast card.
Green	Recording/playback is possible.
Off	A CFast card is not inserted.

If you set **MENU** ➤ [**F** 5] System Setup ➤ [LED] ➤ [CFast Access LED] to [Off], the CFast card access indicator will not illuminate.

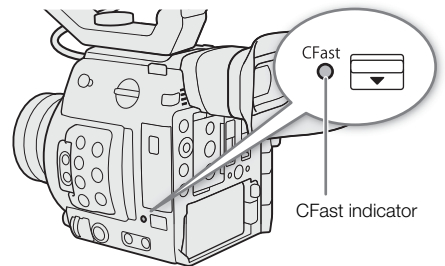

### Removing a CFast card

- 1 Wait until the CFast card access indicator is off or is illuminated in green.
- 2 Slide the CFast card slot cover switch in the direction of the arrow.
  - The CFast card slot cover will open.
- 3 Make sure the CFast card access indicator is off and then push the CFast card release button.
- 4 Pull out the CFast card and close the CFast card slot cover.

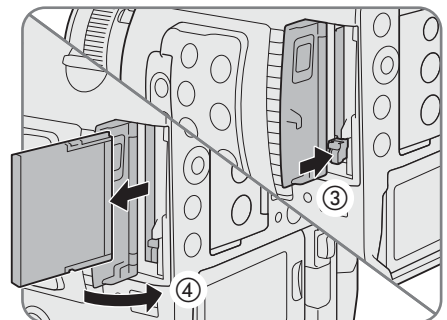

### ! IMPORTANT

- Observe the following precautions while the CFast card access indicator is illuminated in red. Failure to do so may result in permanent data loss.
  - Do not disconnect the power source or turn off the camera.
  - Do not remove the CFast card.

## Inserting and Removing an SD Card

You can insert an SD card into SD card slot A or slot B. If you have two SD cards, you can use both slots.

- 1 Open the SD card slot cover.
- 2 Insert the SD card, with the label facing the right side of the camera (the side with the air intake vent), all the way into the SD card slot until it clicks.
  - To remove the SD card, make sure the SD access indicator is off and then push the SD card once to release it. When the SD card springs out, pull it all the way out.
- 3 Close the SD card slot cover.
  - Do not force the cover closed if the SD card is not correctly inserted.

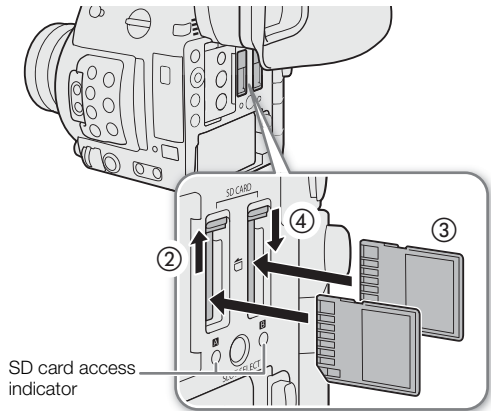

### SD card access indicators

SD CARD <b>A</b> / SD CARD <b>B</b> indicator	SD card status
Red	Accessing the SD card.
Green	SD card is ready for recording, or playback of clips and photos is possible.
Off	An SD card is not inserted, the SD card is not being accessed, the SD card is write-protected with the LOCK switch, or the SD card slot is not currently selected.

If you set **MENU** ➤ [ 5 System Setup ] ➤ [LED] ➤ [SD Card Access LED] to [Off], the SD card access indicators will not illuminate.

### ! IMPORTANT

- Observe the following precautions while an SD card access indicator is illuminated in red. Failure to do so may result in permanent data loss.
  - Do not disconnect the power source or turn off the camera.
  - Do not remove the SD card.
- SD cards have front and back sides that are not interchangeable. Inserting an SD card facing the wrong direction can cause a malfunction of the camera. Be sure to insert the SD card as described in step 3.

### i NOTES

- SD cards have a physical switch to prevent writing on the card so as to avoid the accidental erasure of the card's content. To write-protect the SD card, set the switch to the LOCK position.

## Initializing Recording Media

The first time you use a recording media with this camera, initialize it first. You can also initialize a recording media to permanently delete all the data it contains.

Operating modes: CAMERA MEDIA | RAW MP4 XF-AVC

1 Open the [Initialize Media] submenu.

**MENU** ➤ [ ] [ 1 ] Recording/Media Setup ➤ [Initialize Media]

2 Select [CFast], [SD Card A] or [SD Card B] and then press the joystick.

3 Select [OK] and then press the joystick.

4 When the confirmation message appears, press the joystick.

- The recording media is initialized and all the data it contains is erased.

### IMPORTANT

- Initializing a recording media will permanently erase all data, including photos and protected custom picture files. Lost data cannot be recovered. Make sure you save important recordings in advance.
- Depending on the SD card, initialization may take up to a few minutes.

### NOTES

- While recording on an SD card, you can initialize another SD card in the other SD card slot.
- If you set an assignable button to [Initialize Media] ( 125), you can press the button to open the initialization submenu.

## Switching Between the SD Card Slots

The camera features two SD card slots, SD card slot A and SD card slot B. If both slots contain an SD card, you can switch between them as necessary.

Operating modes: CAMERA MEDIA | RAW MP4 XF-AVC

Press the SLOT SELECT button.

- The access indicator of the selected SD card slot will illuminate in green. On the screen, the SD card selected is indicated with a mark next to SD card icon.

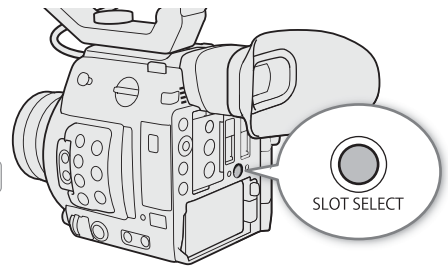

### NOTES

- If both SD card slots contain an SD card and you open the cover of the selected slot, the camera will automatically switch to the other slot.
- You cannot use the SLOT SELECT button to switch between SD card slots while recording.
- You can also perform this function remotely using Browser Remote on a connected network device ( 170).

## Relay Recording and Double Slot Recording

The camera features two convenient recording methods that can be used when both SD card slots contain an SD card: relay recording and double slot recording.

**Relay recording:** This function allows you to continue recording on another SD card without interruption if the SD card you are using becomes full. Relay recording is available from SD card slot A to SD card slot B, and vice versa.

**Double slot recording:** This function records the same clip simultaneously to both SD cards, which is a convenient way to make a backup copy of your recording while you record.

Operating modes: CAMERA MEDIA | RAW MP4 XF-AVC

### To use relay recording

1 Open the [Relay Recording] submenu.

**MENU** ➤ [  3 ] Recording/Media Setup] ➤ [Relay Recording]

2 Select [On] and then press the joystick.

### To use double slot recording

1 Open the [Double Slot Recording] submenu.

**MENU** ➤ [  3 ] Recording/Media Setup] ➤ [Double Slot Recording]

2 Select [On] and then press the joystick.

-  appears at the top of the screen.

### NOTES

- Relay recording (the switch to the other SD card) will not be performed during slow motion recording even if the recording media becomes full.
- If an SD card becomes full during double slot recording, recording on both cards will stop. On the other hand, if an error occurs with one of the SD cards, recording will continue on the other card.
- Double slot recording cannot be used together with relay recording, slow motion recording or continuous recording.

## Checking the Remaining Recording Time on Recording Media

In CAMERA mode, the display on the upper left of the screen shows the recording media icons and the remaining recording time<sup>1</sup> (in minutes) on each card ( 58).

On the [Media] status screen ( 201), you can check the total space, and used space on each recording media. For SD cards only, the remaining recording time, remaining number of photos and speed class are displayed as well.

<sup>1</sup> Remaining recording times are approximate and calculated based on the current video configuration used.

## Recovering Clips

Some actions, such as suddenly turning off the camera or removing the recording media while data is being recorded, can cause data errors in the recorded clip.

52

Operating modes: CAMERA MEDIA | RAW MP4 XF-AVC

- 1 Open the index screen with the clip you wish to recover (📖 139).
- 2 Select the desired clip (a clip with the ? icon instead of a thumbnail image) and then press the joystick.
- 3 Select [Recover Clip] and then press the joystick.
- 4 Select [OK] and then press the joystick.
  - The camera will attempt to recover the corrupted data.
- 5 When the confirmation message appears, press the joystick.

### NOTES

- In the RAW clip or MP4 clip index screen, recovered clips appear with a ▶ icon instead of the usual thumbnail.
- This procedure may delete clips shorter than 0.5 seconds in length.
- In some cases, it may not be possible to recover the data. This is more likely when the file system is corrupted or the recording media is physically damaged.
- Only clips recorded with this camera can be recovered. Photos cannot be recovered.



## Adjusting the Black Balance

You can have the camera adjust the black balance automatically when ambient temperature changes considerably or if there is a noticeable change in a true black video signal.

Operating modes: CAMERA MEDIA | RAW MP4 XF-AVC

### 1 Attach the body cap to the lens mount.

- If a lens was attached, turn off the camera and remove the lens. Place the body cap back on the lens mount and turn on the camera.

### 2 Open the [ABB] screen.

**MENU**    Camera Setup]  [ABB]

### 3 Select [OK] and then press the joystick.

- The automatic black balance procedure will start. It will take approximately 40 seconds, depending on the frame rate.

### 4 When the confirmation message appears, press the joystick.

- If the sensor is not completely shielded from light, [Error] will appear on the screen. Press the joystick and repeat the procedure from the beginning.

### NOTES

- Adjusting the black balance is necessary in the following cases:
  - When using the camera for the very first time or after a long period of not using it.
  - After sudden or extreme changes in ambient temperature.
  - After changing the ISO speed/gain settings.
  - After resetting the camera's settings or all the settings.
  - After activating or deactivating slow motion recording mode (including switching to another special recording mode).
- During the adjustment of the black balance, you may notice some irregular displays appear on the screen. This is not a malfunction.



## Recording Video

This section explains the basics of recording clips\*. For details on recording audio, refer to *Recording Audio* (📖 96).

Before making important recordings for the first time, make test recordings using the video configuration(s) you plan to use to check that the camera operates correctly. Should the camera fail to operate correctly, refer to *Troubleshooting* (📖 207).

\* "Clip" refers to a single movie unit recorded with a single recording operation. You can also include metadata with the clip.

Operating modes: CAMERA MEDIA | RAW MP4 XF-AVC

### Preparing to Record

- 1 Attach the LCD monitor, handle unit, camera grip, etc. as necessary to build the desired configuration (📖 36).
- 2 Attach a charged battery pack to the camera (📖 25).
- 3 Insert recording media (CFast card, one or two SD cards) as necessary (📖 48, 49).
  - Insert SD cards into both SD card slots to use relay recording, double slot recording (📖 51) or continuous recording (📖 118).
  - Insert an SD card into SD card slot B to record photos.
  - To use an external recorder (📖 152), complete the necessary connections and settings.
- 4 Attach a lens (📖 37).
- 5 Adjust the viewfinder (**C200** only) and/or LCD screen.

## Recording

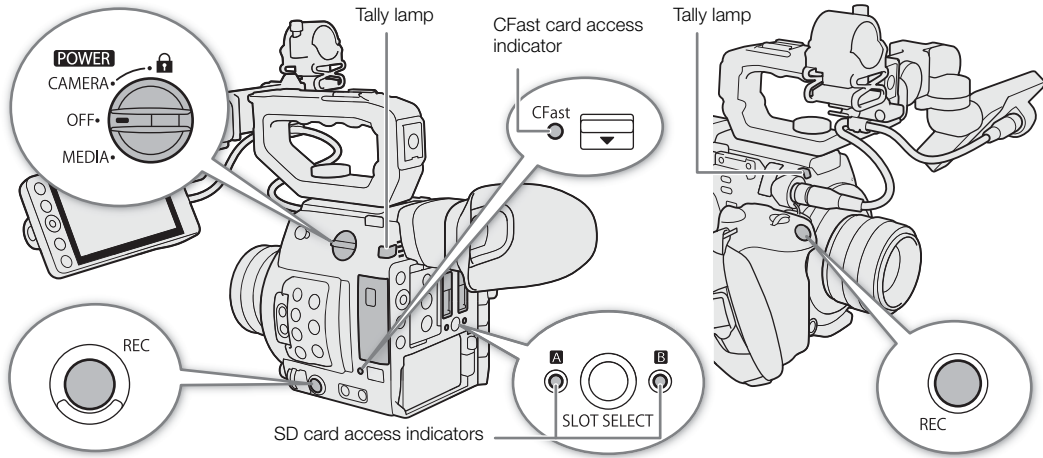

### 1 Set the **POWER** switch to **CAMERA**.

- The camera turns on in **CAMERA** mode and enters record standby mode.
- The access indicators of card slots with a card inserted will illuminate momentarily in red. Then, the access indicator of the recording media slot selected for recording will change to green.

### 2 Press the **REC** button to begin recording.

- Recording starts. The tally lamps illuminate and the recording indicator [●REC] appears at the top of the screen.
- You can use the REC button on the camera's body (left side) or camera grip.
- You can also perform this function remotely using Browser Remote on a connected network device (170).
- For details about recording proxy clips, refer to *Simultaneous Recording of Proxy Clips* (113).

### 3 Press the **REC** button to stop recording.

- The clip is recorded and the camera enters record standby mode. The tally lamp will also go out.

### ! IMPORTANT

- Observe the following precautions while an access indicator is illuminated in red. Failure to do so may result in permanent data loss.
  - Do not open the card slot cover of the card being accessed and do not remove the card.
  - Do not disconnect the power source or turn off the camera.
- Be sure to save your recordings regularly (159), especially after making important recordings. Canon shall not be liable for any loss or corruption of data.

### i NOTES

- You can use the review function (112) to play back part or all of the last clip recorded without having to switch to **MEDIA** mode.
- If you record using metadata settings, those settings will be recorded with the clip. For more details, refer to *Setting the Clip File Name* (61).
- If the camera switches to the other SD card while recording video due to the relay recording function (51), the two parts (before/after the switch) will be recorded as separate clips.
- A single MP4 or XF-AVC clip can be recorded continuously for up to 6 hours. At that point, a new clip will be created automatically and recording will continue on a separate clip.

**Locking the Controls in Recording Mode**

Once in **CAMERA** mode, you can set the **POWER** switch to **LOCK** (key lock) to lock all the physical controls (buttons and switches) on the camera, save for the REC button\*. This is useful in preventing settings from being changed due to inadvertently pressing one of the buttons. Return the **POWER** switch to the **CAMERA** position to reactivate the controls.

\* You can choose to lock the REC button on the camera body or the camera grip with the **MENU** ➔ [F 4] System Setup ➔ [Camera REC Button] and [Camera Grip REC Button] settings. In either case, you can still operate the camera using the Browser Remote application (170).

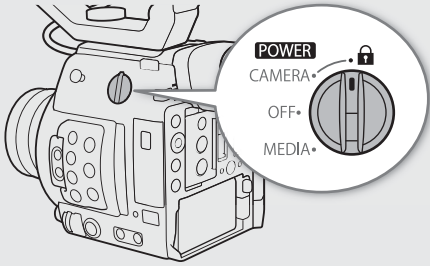

**Onscreen Displays**

Refer to this section for an explanation of the various screen displays that appear in **CAMERA** mode. You can use the custom display function (190) to turn off individual onscreen displays if they are not required. The menu item that controls each display is given in the following table (1: indicates a menu item under [Custom Display 1] and 2: indicates a menu item under [Custom Display 2]).

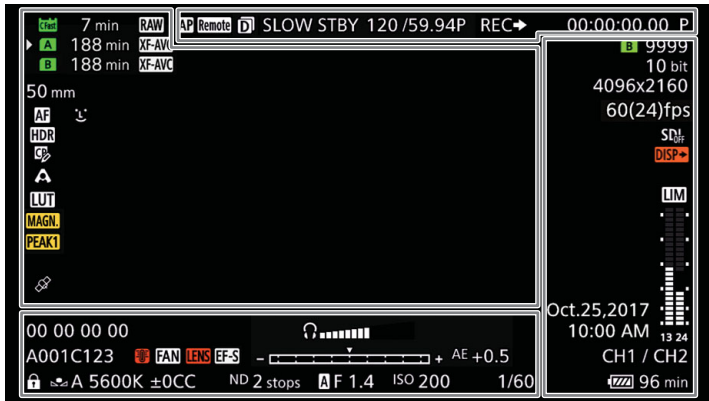

**AF frames**

Depending on the focus function used you may see some of the following AF frames.

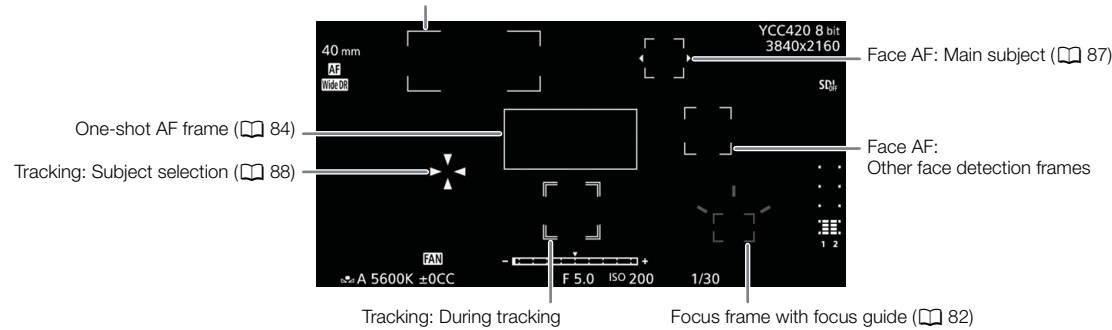

Continuous AF frame – always in white (85)  
AF-Boosted MF frame – in yellow; manual adjustment range; in white: automatic adjustment range (84)





## Left side of the screen



Icon/Display	Description	Custom Display
Recording media status, estimated remaining recording time and recording format		2: [Remaining Rec Time]
. 0000 min, END	CFast card status: in green - can record (RAW clips); in white - reading the CFast card; in yellow - remaining recording time is 5 minutes or less; in red - remaining recording time is less than 1 minute; in red with [END] - the CFast card is full.	
(in red)	No CFast card or cannot record on the CFast card.	
,  , 0000 min, END	SD card status: in green - can record (MP4 or XF-AVC clips); in white - reading the SD card; in yellow - remaining recording time is 5 minutes or less; in red - remaining recording time is less than 1 minute; in red with [END] - the SD card is full. The SD card selected for recording is indicated with a  mark.	
,  (in red)	No SD card or cannot record on the SD card.	
<b>RAW</b> , <b>MP4</b> , <b>XF-AVC</b>	Recording format ( 64)	
0000 mm	Approximate focal length of the lens	1: [Focal Length]
<b>AF</b> , <b>MF</b>	Focus mode ( 80)	1: [Focus Mode]
,	Face AF ( 87)	
,  ,  ,  ,  ,  ,  , <b>HDR</b>	Custom picture gamma settings ( 129) HDR output ( 155)	1: [Custom Picture/HDR]
	Detailed picture settings of the custom picture file are active ( 134).	1: [Custom Picture/HDR]
,	Light metering mode ( 76)	1: [Light Metering]
<b>LUT</b>	A viewing LUT has been applied to at least one display or output terminal ( 156) <ul style="list-style-type: none"> <li>The icon will appear on all active display devices regardless of which screen/output terminal the LUT was applied to.</li> </ul>	1: [LUT]
<b>MAGN.</b> (in yellow)	Magnification ( 83)	1: [Magnification]
<b>PEAK1</b> (in yellow), <b>PEAK2</b> (in yellow)	Peaking ( 83)	1: [Peaking]
<b>MEMO</b>	User memo ( 109)	2: [User Memo]
	GPS signal ( 111): continuously on - satellite signal acquired; flashing - satellite signal not acquired. <ul style="list-style-type: none"> <li>Displayed only when an optional GP-E2 GPS Receiver is connected to the camera.</li> </ul>	2: [GPS]

## Top of the screen



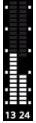
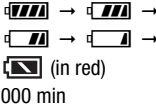

Icon/Display	Description	Custom Display
Network functions:		
	Network connection status: in white - function ready to be used; in yellow - connecting to or disconnecting from a network; in red - error has occurred.	2: [Network Functions]
	Double slot recording (📖 51)	2: [Recording Mode]
Recording operation:		
STBY, ● REC	Clip recording: record standby, recording.	2: [Recording Mode]
INT STBY, ● INT, ● INT REC	Interval recording (📖 117): record standby (before the sequence has started), record standby (once the sequence has started), recording. • In record standby mode before the interval recording sequence has started, [INT] flashes.	
FRM STBY, ● FRM STBY, ● FRM REC	Frame recording (📖 116): record standby (before the sequence has started), record standby (once the sequence has started), recording. • In record standby mode before the frame recording sequence has started, [FRM] flashes.	
SLOW STBY, ● SLOW REC	Slow motion recording (📖 114): record standby, recording.	
PRE REC STBY, ● PRE REC	Pre-recording (📖 115): record standby, recording.	
STBY → <b>A</b> CONT STBY → <b>B</b> , ● REC → <b>A</b> ● CONT REC → <b>B</b>	Continuous recording (📖 118): both cards in record standby, both cards recording. • The upper row (→ <b>A</b> ) indicates the status of the normal (non-continuous) clips on SD card A. The row below it (→ <b>B</b> ) indicates the status of the continuous recording on SD card B.	
1s - 10m00s	Interval recording counter (📖 117)	
00.00P	Frame rate (📖 64) • During slow motion recording, the shooting frame rate is also displayed (000/00.00P).	2: [Frame Rate]
REC →, STBY →	Output recording command (📖 153)	2: [Rec Command]
00:00:00.00, 00:00:00:00 R, P, F, H	Time code (📖 92) Time code status (📖 94)	2: [Time Code]

## Right side of the screen

Icon/Display	Description	Custom Display
 0000	Approximate number of photos that can be recorded on the SD card (📖 120)	2: [Remaining Photos]
 (in red)	No SD card or cannot record photos on the SD card.	—
00 bit, YCC420 8 bit	Color depth, color sampling (📖 65)	2: [Resolution/ Color Sampling]
0000x0000	Resolution (📖 65)	2: [Resolution/ Color Sampling]
SD <sub>off</sub>	SDI terminal not active (📖 152)	2: [Output Terminals Status]
60(24)fps, 60(30)fps	Video output (📖 125)	2: [Output Terminals Status]
 (in red)	Output onscreen displays (📖 157)	2: [OSD Output]

Icon/Display	Description	Custom Display
	Audio peak limiter (📖 101)	2: [Audio Level Indicator]
	Audio level meter (📖 101)	
Date/time		2: [Date/Time]
CH0/CH0	Audio output channels (📖 158)	2: [Monitor Channels]
 000 min	Remaining battery charge The icon shows an estimate of the remaining charge. The remaining recording time is displayed, in minutes, next to the icon. <ul style="list-style-type: none"> <li>When  is displayed, replace the battery pack with a fully charged one.</li> <li>Depending on the conditions of use, the actual battery charge may not be indicated accurately.</li> </ul>	2: [Remaining Battery]

## Bottom/Bottom-Center of the screen

Icon/Display	Description	Custom Display
00 00 00 00	User bit (📖 95)	2: [User Bit]
A001C001 to Z999D999	Clip identification. Includes the camera index, reel number and clip number components of the clip file name (📖 61).	2: [Reel/Clip Number]
	Temperature warning (📖 63)	2: [Temperature/Fan]
<b>FAN</b>	Fan operation (📖 63)	2: [Temperature/Fan]
<b>FAN</b> (in red)	Fan warning (📖 209)	2: [Temperature/Fan]
<b>LENS</b> (in red)	Lens error warning (📖 209)	1: [Lens]
<b>1.5x</b> , <b>3.0x</b> , <b>6.0x</b>	Digital tele-converter (📖 89)	1: [Tele-converter]
<b>EF-S</b>	EF-S lens correction (📖 39)	1: [EF-S Lens]
	Key lock (📖 57)	1: [Key Lock]
 0000 K ±0CC	White balance (📖 77)	1: [White Balance]
	Headphone volume (📖 143)	—
	Exposure bar (📖 75) <ul style="list-style-type: none"> <li>Only displayed when the gain, iris and shutter are all set to manual adjustment.</li> </ul>	1: [Exposure Bar]
AE ±0.00	AE Shift (📖 75)	1: [AE Shift]
ND 00 stops	ND filter (📖 71)	1: [ND Filter]
<b>A</b> , 0.0, closed	Aperture value (📖 72)	1: [Iris]
ISO 000000, 00.0dB	ISO speed/Gain (📖 69)	1: [ISO/Gain]
1/0000, 000.00Hz, 000.00°	Shutter speed (📖 67)	1: [Shutter]

 NOTES

- You can repeatedly press the DISP button to switch the onscreen displays in the following sequence.

Show all onscreen displays → show onscreen markers<sup>1</sup> → hide all onscreen displays<sup>2</sup>.

<sup>1</sup> Only when a marker in **MENU** [  [6] Assistance Functions] is activated. The various frames used for focus-related functions are displayed as well.

<sup>2</sup> Except for the recording operation.



## Setting the Clip File Name

The camera allows you to change several settings that determine the clip file name of recorded RAW and XF-AVC clips. Personalize the clip file name according to your preferences or organizational conventions to create files that are easier to identify and organize.

Operating modes: CAMERA MEDIA | RAW MP4 XF-AVC

The basic file name structure for RAW and XF-AVC clips is as follows. When recording a proxy clip with a RAW clip, the proxy clip's file name depends on the proxy clip's format. For XF-AVC proxy clips, the file names of the primary and proxy clips will be almost identical (components 1 to 6). For MP4 proxy clips, the file names will differ, as the proxy clip will follow the naming convention for MP4 files (□ 62).

A 0 0 1 C 0 0 1 \_ y y m m d d X X \_ C A N O N \_ 0 1 P  

1    2    3
4
5
6
7

- 1 **Camera index:** One character (A to Z) that identifies the camera used.
- 2 **Reel number:** 3 characters (001 to 999) that identify the recording media used. The number is assigned automatically but you can set the initial number.  
After you insert a new card (just purchased or initialized), the number advances by one when the first recording is made.
- 3 **Clip number:** 4 characters (C001 to D999). The clip number advances automatically with each clip recorded (switching to D001 after C999), but you can set the initial clip number and select the clip numbering method.
- 4 Recording date (set automatically by the camera).
- 5 Random component: 2 characters (numbers 0 to 9 and capital letters A to Z) that change randomly with each clip.
- 6 **User defined field:** 5 characters (numbers 0 to 9 and capital letters A to Z) for any other identification purposes.
- 7 The camera will automatically add the suffix “\_P” to the file name of XF-AVC proxy clips. Additionally, when an SD/SDHC card is used to record XF-AVC proxy clips, a stream number (01 to 99) will be added before the “P”. The stream number will advance every time the video (stream) file within the clip is split and recording continues on a separate stream file.

## Setting the components of the clip file name

### To set the camera ID

- 1 Open the [Camera Index] screen.  
**MENU** ➤ [  4 Recording/Media Setup ] ➤ [Metadata] ➤ [Camera Index]
- 2 Push the joystick up/down to select the desired camera ID and then press the joystick twice.

### To set the clip numbering method

- 1 Open the [Clip Numbering] screen.  
**MENU** ➤ [  4 Recording/Media Setup ] ➤ [Metadata] ➤ [Clip Numbering]
- 2 Select [Reset] or [Continuous] and then press the joystick.

### Options

- [Reset]: The clip number will restart from 001 every time you insert a new card.
- [Continuous]: Clip numbers will start from the initial number set with [Clip Number] (following procedure) and continue across multiple cards.

**To set the reel number or initial clip number**

The initial clip number can only be set when [Clip Numbering] is set to [Continuous].

1 Open the [Reel Number] or [Clip Number] screen.

**MENU** ➤ [  4 Recording/Media Setup] ➤ [Metadata] ➤ [Reel Number] or [Clip Number]

2 Select [Change] and then press the joystick.

- To reset the reel/clip number to [001], select [Reset] instead.

3 Push the joystick up/down to select the first digit of the reel/clip number and then press the joystick to move to the next.

- Change the rest of the digits in the same way.

4 Select [Set] and then press the joystick.

**To set the user-defined field**

1 Open the [User Defined] screen.

**MENU** ➤ [  4 Recording/Media Setup] ➤ [Metadata] ➤ [User Defined]

2 Select [Change] and then press the joystick.

- Select [Reset] and then press the joystick to reset the user-defined field to [CANON].

3 Push the joystick up/down to select the first character and then press the joystick to move to the next.

- Change the rest of the characters in the same way.

**Selecting the File Numbering Method for MP4 Clips and Photos**

MP4 clips and photos are automatically assigned consecutive numbers and stored on the SD card in folders. You can select the numbering method used for MP4 clips and photos.

Operating modes:  CAMERA  MEDIA |  RAW  MP4  XF-AVC

1 Open the [MP4 Clip/Photo Numbering] submenu.

**MENU** ➤ [  4 Recording/Media Setup] ➤ [MP4 Clip/Photo Numbering]

2 Select the desired option and then press the joystick.

**Options**

[Reset]: MP4 clip/photo numbers will restart from 100-0001 every time you insert a new SD card. If an SD card already contains previous recordings, numbers will continue from the number following that of the last MP4 clip or photo on the SD card.

[Continuous]: MP4 clip/photo numbers will continue from the number following that of the last MP4 clip or photo recorded with the camera. This setting is the most convenient for managing files on a computer. We recommend using the [Continuous] setting.

**Understanding folder names**

- An example folder name is "101\_1025". The first 3 digits indicate the folder number (from 100 to 999) and the last 4 digits indicate the month and day when the folder was created. In the example, the folder numbered 101 was created on October 25.

**Understanding MP4 clip/photo numbers**

- An example number is "101-0107". The first 3 digits indicate the folder number the recording is stored in and the last 4 digits indicate the consecutive number assigned to the recording (from 0001 to 9999).
- The recording's number also indicates the name and location of the file on the SD card. For example, an MP4 clip/photo numbered 101-0107 that was recorded on October 25, is located in the "DCIM\101\_1025" folder as the file "MVI\_0107.MP4" (for an MP4 clip) or "IMG\_0107.JPG" (for a photo).

## NOTES

- Each folder can contain up to 500 recordings. When that number is exceeded, a new folder is created automatically.

## Using the Fan



The camera uses an internal cooling fan to reduce the camera's internal heat. In **CAMERA** mode, you can change the fan's operation mode and speed. In **MEDIA** mode, the fan runs at all times but you can select its speed.

### Setting the Fan's Operation in **CAMERA** Mode

Operating modes: **CAMERA** **MEDIA** | **RAW** **MP4** **XF-AVC**

- 1 Open the fan's [Mode] submenu.  
**MENU** ➤ [**F** 5 System Setup] ➤ [Fan] ➤ [Mode]
- 2 Select the desired option and then press the joystick
  - If you selected [Automatic], the rest of the procedure is not necessary. If you selected [Always On], continue the procedure to set the fan speed.
- 3 Open the [Fan Speed (Always)] submenu.  
**MENU** ➤ [**F** 5 System Setup] ➤ [Fan] ➤ [Fan Speed (Always)]
- 4 Select the desired fan speed and then press the joystick.

#### Options

[Automatic]: The fan runs while the camera is not recording and is automatically turned off while the camera is recording. However, if the internal temperature of the camera is too high ( appears in red), the fan will be activated automatically (in that case, **FAN** will appear next to the  icon). When the camera's temperature has decreased sufficiently, the fan will be turned off. Use this setting when you do not want the camera to pick up the fan's operating sound.

[Always On]: The fan runs at all times.

### Setting the Fan Speed in **MEDIA** Mode

Operating modes: **CAMERA** **MEDIA** | **RAW** **MP4** **XF-AVC**

- 1 Open the [Fan Speed] submenu.  
**MENU** ➤ [**F** 4 System Setup] ➤ [Fan Speed]
- 2 Select the desired fan speed and then press the joystick.

## IMPORTANT

- While the fan is running, the exhaust vent will emit warm air.
- Be careful not to obstruct in any way the fan's air vents ( 12, 13).

## NOTES

- Depending on the ambient temperature and other shooting conditions, the fan may not turn off even if you set its operating mode to [Automatic].

## Video Configuration: Video Format, System Frequency, Frame Rate and Resolution

With the following procedures you can set the video configuration used for main recording clips. Select the video format, system frequency, frame rate, resolution (frame size) and color sampling settings that best match your creative needs. Available options for some settings may change depending on previous selections for other settings. See the tables following the procedures for a summary.

For details about the video configuration of proxy clips, refer to *Simultaneous Recording of Proxy Clips* (📖 113).

### Selecting the Main Recording Format

The camera can record clips in RAW<sup>1</sup>, MP4 or XF-AVC. RAW clips are recorded to the CFast card while MP4 and XF-AVC clips are recorded to an SD card. RAW clips require post-processing but give you high-quality and a great amount of control in how the final picture turns out. XF-AVC clips deliver high-quality video due to efficient compression. MP4 clips have a smaller file size and are very versatile.

<sup>1</sup> Please note that the Cinema RAW Light data recorded by this camera is different from the Cinema RAW data recorded by other Cinema EOS cameras.

Operating modes: CAMERA MEDIA | RAW MP4 XF-AVC

1 Open the [Main Rec Format] submenu.

**MENU** ➤ [📷 1 Recording/Media Setup] ➤ [Main Rec Format]

2 Select [RAW (CFast)], [MP4 (SD Card)] or [XF-AVC (SD Card)] and then press the joystick.

### Selecting the System Frequency

Operating modes: CAMERA MEDIA | RAW MP4 XF-AVC

1 Open the [System Frequency] submenu.

**MENU** ➤ [📷 1 Recording/Media Setup] ➤ [System Frequency]

2 Select the desired option and then press the joystick.

- The camera will reset and restart in the selected mode.

### Selecting the Frame Rate

When shooting RAW clips, the frame rate will also determine the color depth. Refer to the following table. This procedure is not necessary when the system frequency is set to [24.00 Hz].

Operating modes: CAMERA MEDIA | RAW MP4 XF-AVC

1 Open the [Frame Rate] submenu.

**MENU** ➤ [📷 2 Recording/Media Setup] ➤ [Frame Rate]

2 Select the desired option and then press the joystick.

- The selected frame rate will appear on the top of the screen.

## Selecting the Resolution and Color Sampling Settings

Operating modes: CAMERA MEDIA | RAW\* MP4 XF-AVC

\* For RAW clips, the resolution is set to 4096x2160 and cannot be changed.

1 Open the [Resolution/Color Sampling] submenu.

**MENU** [ 2 Recording/Media Setup ] [Resolution/Color Sampling]

2 Select the desired option and then press the joystick.

- The selected resolution/color sampling will appear on the right of the screen ( 59).

### Available video configuration settings (RAW clips)

Resolution	Color depth	Bit rate <sup>1</sup>	System frequency/Frame rate					
			59.94 Hz			50.00 Hz		24.00 Hz
			59.94P	29.97P	23.98P	50.00P	25.00P	24.00P
4096x2160	10 bit	1 Gbps	●	–	–	●	–	–
	12 bit		–	●	●	–	●	●

### Available video configuration settings (MP4 clips)

Resolution and color sampling		Bit rate and compression <sup>1, 2</sup>	System frequency/Frame rate					
			59.94 Hz			50.00 Hz		24.00 Hz
			59.94P	29.97P	23.98P	50.00P	25.00P	24.00P
3840x2160	YCbCr 4:2:0, 8 bit	150 Mbps, Long GOP	●	●	●	●	●	●
1920x1080	YCbCr 4:2:0, 8 bit	35 Mbps, Long GOP	●	●	●	●	●	●

### Available video configuration settings (XF-AVC clips)

Resolution and color sampling		Bit rate and compression <sup>1, 2</sup>	System frequency/Frame rate							
			59.94 Hz				50.00 Hz			24.00 Hz
			59.94i	59.94P	29.97P	23.98P	50.00P	50.00i	25.00P	24.00P
3840x2160	YCbCr 4:2:0, 8 bit	160 Mbps, Long GOP	–	●	●	●	–	●	●	●
1920x1080	YCbCr 4:2:0, 8 bit	45 Mbps, Long GOP	●	●	●	●	●	●	●	●

<sup>1</sup> The camera uses a variable bit rate (VBR).

<sup>2</sup> Long GOP options compress the image after analyzing also changes across a group of pictures and offer better compression (smaller data size).

### NOTES

- For details on the signal output from each terminal, refer to *Video Output Configuration* ( 149).

## Changing Main Camera Functions with the FUNC Button

You can adjust three main camera functions—shutter speed, white balance and ISO speed/gain—using the FUNC button (direct setting mode).

This section will explain the basic operation of the direct setting mode. For specific details about the functions refer to the each function's section: shutter speed (📖 67), white balance (📖 77), ISO speed/gain (📖 69).

Operating modes: CAMERA MEDIA | RAW MP4 XF-AVC

### Using the Direct Setting Mode

#### 1 Press the FUNC button.

- The onscreen display of the function to be adjusted will be highlighted in orange.
- Press the FUNC button repeatedly or push the joystick left/right to select the function you wish to adjust.

#### 2 Push the joystick up/down to select the desired value (ISO speed, gain, shutter speed) or desired white balance mode and then press the joystick.

- The selected value will be set and the camera will exit the direct setting mode.
- The onscreen display of the selected function will return to normal.
- Depending on the function selected, additional adjustment may be possible or necessary before pressing the joystick.

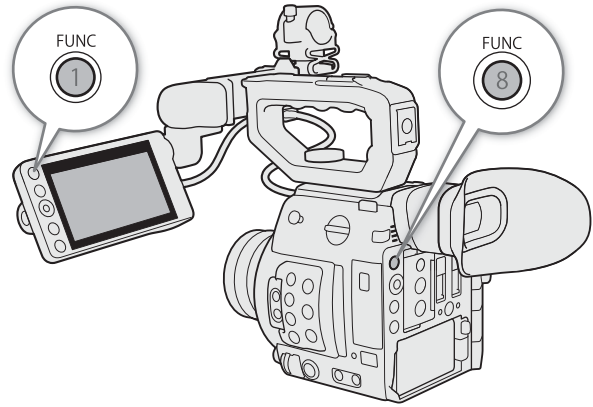

#### **i** NOTES

- The camera will automatically end the direct setting mode in the following cases.
  - If no operation was performed for more than 6 seconds.
  - If the menu or a status screen was opened.

## Shutter Speed

Set the shutter speed based on the recording conditions. For example, you may want to set slower shutter speeds in darker environments. The camera offers the following modes.

You can also perform this function remotely using Browser Remote on a connected network device (📖 170).

Operating modes: CAMERA MEDIA | RAW MP4 XF-AVC

[Speed]<sup>2</sup>: Allows you to set the shutter speed (in fractions of a second). You can select the increment to use when adjusting the shutter speed between 1/3-stop and 1/4-stop increments.

[Angle]: You can set the shutter angle to determine the shutter speed.

[Clear Scan]<sup>2</sup>: Set the frequency in order to record CRT computer monitors without displaying black bands or flicker on the screen.

[Slow]<sup>5</sup>: You can set slower shutter speeds to obtain brighter recordings in places with insufficient lighting. This mode is not available during slow motion recording.

[Off]<sup>2</sup>: The camera uses a standard shutter speed based on the frame rate.

### Available Shutter Speeds

The available shutter speeds vary depending on the system frequency and frame rate used.

Shutter speed mode	System frequency/Frame rate					
	59.94 Hz		24.00 Hz	50.00 Hz		
	59.94P / 59.94i <sup>1</sup>	29.97P	23.98P	24.00P	50.00P / 50.00i <sup>1</sup>	25.00P
[Speed] <sup>2</sup>	1/24 to 1/2000 <sup>3</sup>					
[Angle] <sup>2, 4</sup>	360.00°, 240.00°, 180.00°, 120.00°, 90.00°, 60.00°, 45.00°, 30.00°, 22.50°, 15.00°, 11.25°					
[Clear Scan] <sup>2</sup>	23.98 Hz to 250.38 Hz			24.00 Hz to 250.40 Hz		
[Slow] <sup>5</sup>	1/4, 1/8, 1/15, 1/30	1/4, 1/8, 1/15	1/3, 1/6, 1/12		1/3, 1/6, 1/12, 1/25	1/3, 1/6, 1/12
[Off] <sup>2</sup>	1/60	1/30	1/24		1/50	1/25

<sup>1</sup> 59.94i and 50.00i are available only for XF-AVC clips.

<sup>2</sup> During slow motion recording, available values will vary depending on the selected shooting frame rate.

<sup>3</sup> The available shutter speeds will depend on the selected frame rate and increment.

<sup>4</sup> You can also select angle values equivalent to the following shutter speeds: 1/100, 1/60, 1/50, 1/40, 3/100, 1/30, 1/25. Available angle values will vary depending on the frame rate used.

<sup>5</sup> Not available during slow motion recording.

## Changing the Shutter Speed Mode and Value

You can also perform this function remotely using Browser Remote on a connected network device (📖 170).

1 Open the shutter speed [Shutter Mode] submenu.

**MENU** ➤ [📷] 2 [Camera Setup] ➤ [Shutter Mode]

2 Select the desired mode and then press the joystick.

- If you selected [Speed] (the default value), continue the procedure to select the increment scale to use when adjusting the shutter speed; otherwise, skip to step 5.

3 Open the [Shutter Increment] submenu.

**MENU** ➤ [📷] 2 [Camera Setup] ➤ [Shutter Increment]

4 Select [1/3 stop] or [1/4 stop] and then press the joystick.

5 Adjust the shutter speed, angle value or clear scan frequency using the direct setting mode.

- After closing the menu, press the SHUTTER button to enter the direct setting mode with the shutter speed highlighted. Select the desired value and then press the joystick. For details refer to *Using the Direct Setting Mode* (📖 66).
- You can also use the FUNC button and joystick to enter the direct setting mode.
- The selected shutter speed will appear on the bottom of the screen.

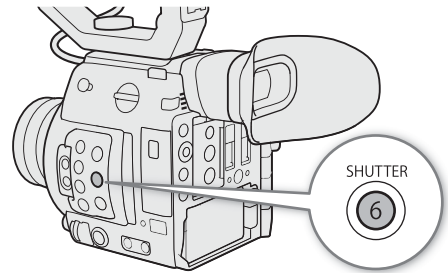

### Using Slow Shutter Mode

When recording in dark surroundings, you can obtain a brighter picture by using slow shutter mode. You can also use this mode when you wish to add certain effects to your recordings, such as blurring the background during panning shots or recording a moving subject with an afterimage trail.

- Image quality may not be as good as when using faster shutter speeds in brighter surroundings.

### **i** NOTES

- When recording under artificial light sources such as fluorescent, mercury or halogen lamps, the screen may flicker depending on the shutter speed. You may be able to avoid flicker by setting the shutter speed mode to [Speed] and the shutter speed to a value matching the frequency of the local electrical system: 1/50\* or 1/100 for 50 Hz systems, 1/60 or 1/120 for 60 Hz systems.
- Closing down the aperture when recording under bright conditions may cause the picture to appear soft or out of focus. To avoid the loss of sharpness due to diffraction, use a faster shutter speed, a denser ND filter (📖 71) or open up the aperture.
- When the shutter speed mode is set to [Slow], bright red, green or blue dots may appear on the screen. In such case, use a faster shutter speed or select a lower ISO speed or gain value (📖 69).
- When an optional RC-V100 Remote Controller is connected to the camera, you can change the shutter speed mode with the remote controller's SHUTTER SELECT button and the shutter speed value with the remote controller's SHUTTER ▲/▼ buttons.

\* May not be available depending on the frame rate.



## ISO Speed/Gain

Depending on the shooting conditions, you may want to adjust the brightness of the image. You can do so by changing the ISO speed or gain value to adjust the sensitivity of the sensor.

You can also perform this function remotely using Browser Remote on a connected network device (📖 170).

Operating modes: CAMERA MEDIA | RAW MP4 XF-AVC

### Available ISO speed and gain settings<sup>1</sup>

	Increment <sup>2</sup>	Normal range	Extended range <sup>3</sup>
ISO speed	[1 stop] (1-stop increments)	160 <sup>4</sup> , 200, 400, 800, 1600, 3200, 6400, 12800, 25600	100, 51200, 102400
	[1/3 stop] (1/3-stop increments)	160, 200, 250, 320, 400, 500, 640, 800, 1000, 1250, 1600, 2000, 2500, 3200, 4000, 5000, 6400, 8000, 10000, 12800, 16000, 20000, 25600	100, 125, 32000, 40000, 51200, 64000, 80000, 102400
Gain	[Normal] (3-dB increments)	-2 dB <sup>4</sup> , 0 dB to 42 dB	-6 dB, -3 dB, 45 dB to 54 dB
	[Fine] (0.5-dB increments)	-2 dB to 42 dB	42.5 dB to 54 dB

<sup>1</sup> The minimum sensitivity needed to obtain the recommended dynamic range is ISO 400 / 6 dB gain (when the [Gamma] setting in the custom picture file (📖 133) is set to [Canon Log] or [Wide DR]) or ISO 800 / 12 dB gain (when it is set to [Canon Log 3]).

<sup>2</sup> **MENU** ➤ [📷 2] Camera Setup ➤ [ISO Increment] setting (ISO speed) or [Gain Increment] setting (gain).

<sup>3</sup> Sensitivity settings that are outside the recommended range but can still be used by setting **MENU** ➤ [📷 2] Camera Setup ➤ [ISO/Gain Extended Range] to [On].

<sup>4</sup> Available only when [ISO/Gain Extended Range] is set to [Off].

## Changing the ISO Speed or Gain Value

1 Open the ISO speed/gain [ISO/Gain] submenu.

**MENU** ➤ [📷 2] Camera Setup ➤ [ISO/Gain]

2 Select [ISO] or [Gain] and then press the joystick.

3 Open the [ISO Increment] or [Gain Increment] submenu to select the adjustment increment to use when adjusting the ISO speed or gain, respectively.

**MENU** ➤ [📷 2] Camera Setup ➤ [ISO Increment] (ISO speed)

**MENU** ➤ [📷 2] Camera Setup ➤ [Gain Increment] (gain)

4 Select the desired option and then press the joystick.

5 After closing the menu, press the ISO/GAIN button to enter the direct setting mode with the ISO speed or gain value highlighted.

- Select the desired value and then press the joystick. For details refer to *Using the Direct Setting Mode* (📖 66).
- You can also use the FUNC button and joystick to enter the direct setting mode.
- The selected ISO speed/gain value will appear on the bottom of the screen.

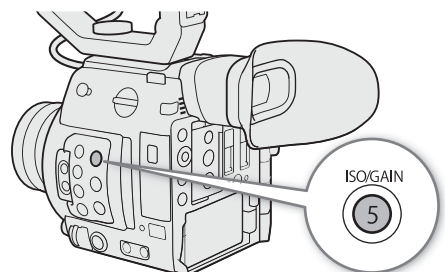

## Using the Control Dial

You can adjust the ISO speed or gain value using the control dial on the camera or that on the camera grip<sup>1</sup>.

You will need to set in advance the function of one of the control dials to [ISO/Gain]. You can select the function assigned to each control dial independently.

<sup>1</sup> Supplied accessory for the C200; optional accessory for the C200B.

### Assigning ISO Speed/Gain Control to a Control Dial

1 Open the [Camera Ctrl Dial] (control dial on the camera) or [Camera Grip Ctrl Dial] (control dial on the camera grip) submenu.

**MENU** ➤ [F 4] System Setup] ➤ [Camera Ctrl Dial] or [Camera Grip Ctrl Dial]

2 Select [ISO/Gain] and then press the joystick.

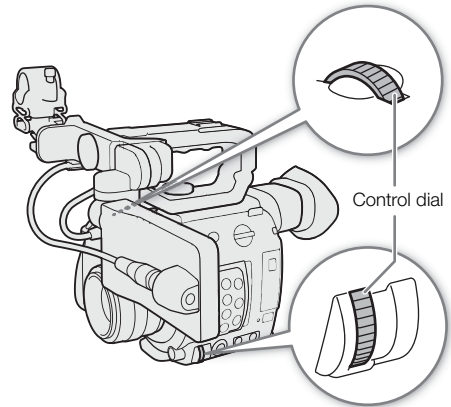

### Changing the ISO Speed or Gain Value

To select whether to change the ISO speed or the gain, perform the previous procedure (☐ 69). Turn the control dial assigned to [ISO/Gain] to set the desired ISO speed or gain value.

#### **i** NOTES

- When high ISO speeds or gain levels are set, the picture may flicker slightly.
- When high ISO speeds or gain levels are set, bright red, green or blue dots may appear on the screen. In such case, use a faster shutter speed (☐ 67) or select a lower ISO speed or gain value.
- When the ISO speed or gain level is changed, some noise may appear momentarily on the screen. Do not adjust the ISO speed/gain level while recording.
- You can use the **MENU** ➤ [F 4] System Setup] ➤ [Camera Ctrl Dial Dir.] or [Camera Grip Ctrl Dial Dir.] setting to change the direction of the adjustment when you turn the control dial on the camera or on the camera grip, respectively.
- When an optional RC-V100 Remote Controller is connected to the camera, you can adjust the ISO speed or gain value with the remote controller's ISO/GAIN ▲/▼ buttons.

## ND Filter

Using the ND filter allows you to open up the aperture to obtain a shallower depth of field even when recording in bright surroundings. You can also use the ND filter to avoid the soft focus caused by diffraction when using small apertures. By default, you can select one of 3 density levels (2 to 6 stops) and, if you enable the extended ND range, you can select one of 5 density levels (2 to 10 stops). You can also perform this function remotely using Browser Remote on a connected network device (170).

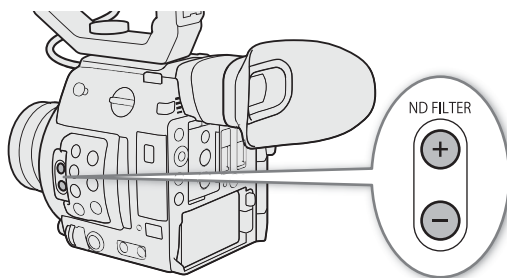

Operating modes: CAMERA MEDIA | RAW MP4 XF-AVC

Press the ND FILTER + or – button to select the desired ND filter setting.

- Repeatedly pressing ND FILTER + button will change the ND filter setting in the following order: [ND 2 stops] → [ND 4 stops] → [ND 6 stops] → [ND 8 stops]\* → [ND 10 stops]\* → ND filter off. (The ND FILTER – button cycles through the settings in reverse order.)
  - The selected ND filter setting will appear on the bottom of the screen.
- \* Only when **MENU** ➤ [ ] Camera Setup ➤ [Extended ND Range] is set to [On].

### **i** NOTES

- If you set an assignable button to [ND +] or [ND –] (125), you can press the button to change the ND filter setting.
- Depending on the scene, the color may change when turning the ND filter on/off. Setting a custom white balance (77) may be effective in such case.
- **About the extended ND range:** When you switch to or from a density level in the extended range (8 or 10 stops), you may notice one or both of the following circumstances.
  - The focus may shift, affecting also the indication on the lens's focus distance scale.
  - Depending on the lens, the camera may not be able to focus at infinity focus.
- **About changing the ND filter setting using the optional RC-V100 Remote Controller:**
  - When the remote controller is connected to the camera, you can use the remote controller's ND button in the same way as the camera's ND FILTER + button.
  - For settings between 2 and 8 stops, the corresponding ND filter indicator (1 to 4, respectively) will illuminate in orange. When the ND filter is set to 10 stops, indicators 1 and 4 will both illuminate.

## Adjusting the Aperture

You can affect the brightness of your recordings or change the depth of field by adjusting the aperture. By default, the camera is set to manual aperture but, depending on the lens used, the camera offers 3 ways to adjust the aperture. Refer to the list of compatible lenses and functions that can be used (📖 230).

**Manual aperture:** Adjust the aperture value manually using the control dial on the camera or on the camera grip<sup>1</sup>, or remotely, using Browser Remote on a connected network device (📖 170).

**Push Auto Iris:** Momentary automatic aperture. During manual aperture, press the PUSH AUTO IRIS button or use Browser Remote (📖 170) to temporarily adjust the aperture automatically.

**Automatic aperture:** The camera adjusts the aperture automatically.

<sup>1</sup> Supplied accessory for the C200; optional accessory for the C200B.

### Required settings on EF Cinema lenses

To adjust the aperture from the camera, you will need to enable automatic adjustment using the controls on the lens. Required settings vary depending on the lens. Refer to the following table and the instruction manual of the lens used.

Lens	Part used on the lens	Setting for automatic adjustment
CN7x17 KAS S/E1 CN10x25 IAS S/E1 CN20x50 IAS H/E1	Iris operation change-over switch	A
CN-E18-80mm T4.4 L IS KAS S CN-E70-200mm T4.4 L IS KAS S	Iris auto/manual change-over switch	A

Operating modes: CAMERA | MEDIA | RAW | MP4 | XF-AVC

## Manual Aperture

You can adjust the aperture value of an EF lens using the control dial on the camera or the camera grip. You can select the function assigned to each control dial independently.

By default, both control dials' function is set to aperture control. If it has been changed, follow the procedure below to set in advance the function of one of the control dials to [Iris].

### Assigning aperture control to a control dial

1 Open the [Camera Ctrl Dial] (control dial on the camera) or [Camera Grip Ctrl Dial] (control dial on the camera grip) submenu.

**MENU** ➤ [Y] [4] System Setup ➤ [Camera Ctrl Dial] or [Camera Grip Ctrl Dial]

2 Select [Iris] and then press the joystick.

## Changing the aperture mode and value

1 Open the [Iris Mode] submenu.

**MENU** ➤ [☰] [1] Camera Setup] ➤ [Iris Mode]

- This setting is available only when an EF lens compatible with automatic aperture is attached to the camera. For non-compatible lenses, the aperture mode will be set to [Manual] and cannot be changed. Skip to step 3.
- When using a compatible EF Cinema lens, enable automatic adjustment on the lens (📖 72).

2 Select [Manual] and then press the joystick.

3 Open the [Iris Increment] submenu.

**MENU** ➤ [☰] [1] Camera Setup] ➤ [Iris Increment]

4 Select [1/2 Stop] or [1/3 Stop] and then press the joystick.

- You can further select [Fine Increment] from the same submenu and set it to [On] to use the smallest iris increment allowed by the lens attached. Nevertheless, the aperture value displayed on the screen will be the closest value in the selected increment scale.

5 Turn the control dial assigned to [Iris] to adjust the aperture.

- The selected aperture value will appear on the bottom of the screen.

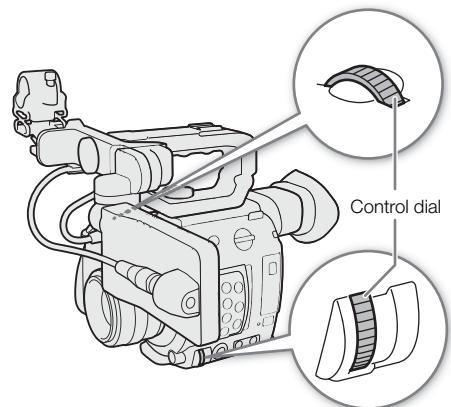

### **i** NOTES

- You can use the **MENU** ➤ [☰] [4] System Setup] ➤ [Camera Ctrl Dial Dir.] or [Camera Grip Ctrl Dial Dir.] setting to change the direction of the adjustment when you turn the control dial on the camera or on the camera grip, respectively.
- If you set an assignable button to [Iris +] or [Iris -] (📖 125), you can press the button to respectively open up the aperture (smaller F values) or close it (larger F values).
- When using an EF lens with no lens contacts or most EF Cinema lenses\*, you cannot adjust the aperture using the camera. Adjust the aperture using the lens.
  - \* Select EF Cinema lenses (📖 230) support iris adjustment from this camera.
- When using an EF lens that can correct the aperture value according to the position of the zoom, you can use the **MENU** ➤ [☰] [1] Camera Setup] ➤ [Zoom-Iris Correct.] setting to activate this correction.
- When an optional RC-V100 Remote Controller is connected to the camera, you can adjust the aperture with the remote controller's IRIS dial. At default settings, turn the dial right to open up the aperture and left to close the aperture.
- When an EF Cinema lens is attached to the camera, the aperture value displayed on the screen will be a T value. The aperture value (T value) displayed on the screen may differ from the indication on the lens's aperture scale.
- When using an EF Cinema lens compatible with iris adjustment from the camera, when the iris is almost fully closed, the aperture value (T value) may appear in gray on the screen.
- When using an EF Cinema lens compatible with iris adjustment from the camera, when you change the aperture value from a position of fully open or fully closed iris, multiple adjustment operations may be required until the aperture changes.

## Momentary Automatic Aperture - Push Auto Iris

During manual aperture, you can press the PUSH AUTO IRIS button to have the camera temporarily take control and automatically adjust the aperture for an optimal exposure. You can also perform this function remotely using Browser Remote on a connected network device (📖 170).

### 1 Set the iris mode to [Manual] (📖 73).

- When using a compatible EF Cinema lens, enable automatic adjustment on the lens (📖 72).

### 2 Press and hold the PUSH AUTO IRIS button.

- The camera will automatically adjust the aperture to obtain optimal exposure. As long as you hold the button pressed down, **A** will appear on the screen next to the aperture value.
- When you release the button, automatic aperture mode will end and the **A** icon will disappear. The selected aperture value will appear on the bottom of the screen.

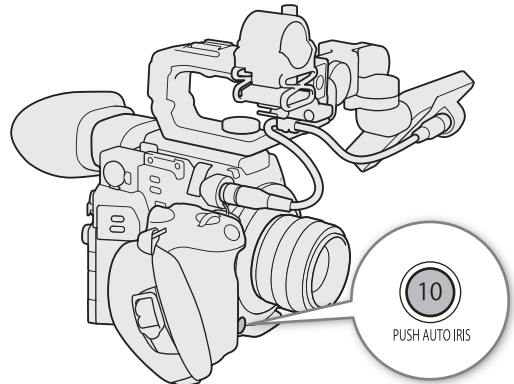

### **i** NOTES

- You can use the **MENU** ➤ [**☰** 3 Camera Setup] ➤ [AE Response] setting to change how quickly the aperture changes during automatic aperture mode. This setting has no effect when using a CN7x17 KAS S/E1 or CN20x50 IAS H/E1 lens.
- Push auto iris is not available during slow motion recording.

## Automatic Aperture

When a compatible EF lens is attached to the camera, you can have the camera automatically adjust the aperture.

### 1 Open the aperture [Iris Mode] submenu.

**MENU** ➤ [**☰** 1 Camera Setup] ➤ [Iris Mode]

### 2 Select [Automatic] and then press the joystick.

- When using a compatible EF Cinema lens, enable automatic adjustment on the lens (📖 72).
- The camera will automatically adjust the aperture to obtain optimal exposure. The selected aperture value will appear on the bottom of the screen with an **A** icon next to it.

### **i** NOTES

- If you set an assignable button to [Iris Mode] (📖 125), you can press the button to toggle between the [Automatic] and [Manual] settings when a compatible EF lens (📖 230) is attached to the camera.
- Automatic aperture is not available during slow motion recording.
- The aperture value may change in the following cases.
  - While using the built-in extender or iris compensation function of an EF Cinema lens, when you switch from automatic aperture to manual aperture.
  - When the aperture controls on the lens are switched between automatic/manual mode.
- When using EF lenses that let you adjust the aperture gain, if the aperture gain is set too high, the aperture adjustment may not be stable (aperture hunting), depending on the shooting conditions. In such case, reset the lens's aperture gain to its initial value.

## Exposure Compensation - AE Shift

Use AE shift to compensate the exposure that was set using automatic aperture, in order to darken or lighten the image.

You can also perform this function remotely using Browser Remote on a connected network device (📖 170).

1 Open the [AE Shift] submenu.

**MENU** ➤ [🔍 3] Camera Setup ➤ [AE Shift]

2 Select an AE shift level and then press the joystick.

- You can select one of 17 AE shift levels from  $-2.0$  to  $+2.0$ .
- The selected AE shift level will be displayed above the exposure bar and the camera will attempt to adjust the exposure accordingly.

### **i** NOTES

- If you set an assignable button to [AE Shift +] or [AE Shift -] (📖 125), you can press the button to adjust the AE shift level.

#### The Exposure Bar

The ▼ on top of the exposure bar indicates optimal exposure without any shift ( $AE\pm 0$ ); the scale markings indicate the deviation from optimal exposure in  $1/2$  EV increments. The indicator inside the exposure bar represents the current exposure. When the difference between current and optimal exposure is larger than  $\pm 2$  EV, the indicator will flash at the edge of the exposure bar. Optimal exposure will change depending on the light metering mode used.

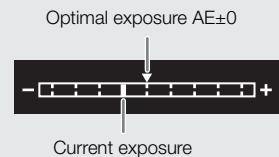



## Light Metering Mode

Select the light metering mode to match the recording conditions. Using the appropriate setting will ensure that the camera obtains the most suitable exposure level when automatic aperture is used.

1 Open the [Light Metering] submenu.

**MENU** ➤ [  3 Camera Setup] ➤ [Light Metering]

2 Select the desired option and then press the joystick.

- The icon of the selected mode ( or ) appears on the left of the screen.

### Options

[Backlight]: Suitable when recording backlit scenes.

[Standard]: Averages the light metered from the entire screen, giving more weight to the subject in the center.

[Spotlight]: Use this option when recording a scene in which only a certain part of the picture is lit, for example, when the subject is lit by a spotlight.

### NOTES



- If you set an assignable button to [Backlight] or [Spotlight] ( 125), you can press the button to turn the respective light metering mode on and off.



## White Balance

The camera uses an electronic white balance process to calibrate the picture and produce accurate colors under different lighting conditions. There are 4 methods of setting the white balance.

You can also perform this function remotely using Browser Remote on a connected network device (📖 170).

**Custom white balance:** You can use a gray card or white object with no pattern to establish the white balance and set it to one of two custom white balance positions, A or B. When recording under fluorescent lights, we recommend setting the custom white balance.



**Preset white balance:** Set the white balance to  (daylight) or  (incandescent lamp). You can further adjust the color temperature (K) value and the color compensation (CC) value.

**Set color temperature:** Allows you to set the color temperature between 2,000 K and 15,000 K, and further adjust the color compensation (CC) value, which adjusts the color along the green/magenta gradation.

**Auto white balance (AWB):** The camera automatically adjusts the white balance to the optimal level.

Operating modes: CAMERA MEDIA | RAW MP4 XF-AVC

### NOTES

- The [White Balance] and [Color Matrix Tuning] settings in the custom picture file (📖 136) take precedence over the white balance set with these procedures.
- You can use the **MENU** ➤ [ 3 Camera Setup] ➤ [Shockless WB] setting to make the transition look smoother when you change the white balance settings.
- You can use the **MENU** ➤ [ 3 Camera Setup] ➤ [C. Temp. Increment] setting to change the units for the color temperature increment to [Mired] (5-mired increments) or [Kelvin] (100-kelvin increments). Even when [Mired] is selected, the color temperature is converted to and displayed in kelvins. Changing this setting may change the white balance setting.
- When an optional RC-V100 Remote Controller is connected to the camera, you can adjust the white balance with the remote controller's AWB button, A button, B button, PRESET button and  button.
- The color temperatures displayed on the screen are approximate. Use them only as a reference.

## Custom White Balance

### 1 Press the WB button.

- The white balance mode icon will be highlighted in orange.
- You can also use the FUNC button and joystick to enter the direct setting mode.

### 2 Push the joystick up/down to select the A or B icon and then press the joystick.



- If a custom white balance has been stored previously, pressing the joystick will apply the stored custom white balance. You do not need to perform the rest of the procedure.

### 3 Point the camera at a gray card or white object so that it fills the whole screen.

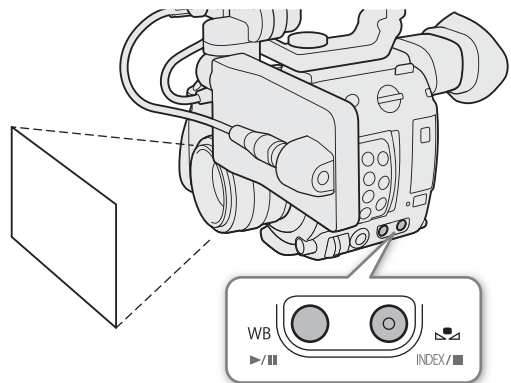
- Use the same lighting conditions you plan to use when recording.



#### 4 Press the button.

- The  A or  B icon will flash quickly.
- Make sure the gray card or white object fills the screen until the procedure is completed.
- Once the icon stops flashing, the procedure is completed. The setting is retained even if you turn off the camera.
- The selected color temperature/color compensation (CC) value will be set and will appear on the screen next to the white balance icon.

#### NOTES

- Readjust the custom white balance if the light source or ND filter setting changes.
- Very rarely and depending on the light source,  may keep flashing (it will change to a slow flashing). The result will still be better than with the auto white balance.
- After the camera registers a custom white balance the color temperature or CC value may appear in gray. This indicates that the value registered exceeds the range of values that can be displayed but the white balance is correctly calibrated and you can continue shooting.

## Color Temperature/Preset White Balance

#### 1 Press the WB button.

- The white balance mode icon will be highlighted in orange.
- You can also use the FUNC button and joystick to enter the direct setting mode.

#### 2 Push the joystick up/down to select the or icon (preset white balance), or the icon (color temperature setting).

- Press the joystick to set the preset setting or the default color temperature. To fine-tune the preset white balance settings or change the color temperature, continue the procedure instead of pressing the joystick.



#### 3 Press the button.

- You can also press the FUNC button or push the joystick right.
- The color temperature will be highlighted in orange. To adjust the color compensation (CC) value, push the joystick right again.

#### 4 Push the joystick up/down to change the color temperature/color compensation (CC) value and then press the joystick.

- The selected color temperature/color compensation (CC) value will be set and will appear on the screen next to the white balance icon.

#### Adjustment ranges

White balance mode/setting	Adjustment range	
	Color temperature (K)	Color compensation (CC) value
 (daylight)	4,300 K to 8,000 K	-5 to +5
 (incandescent lamp)	2,700 K to 3,700 K	
 (set color temperature)	2,000 K to 15,000 K	-20 to +20

## Auto White Balance (AWB)

The camera constantly adjusts the white balance automatically to achieve an optimal level. The camera will adjust the white balance if the light source changes.

### 1 Press the WB button.

- The white balance mode icon will be highlighted in orange.
- You can also use the FUNC button and joystick to enter the direct setting mode.

### 2 Push the joystick up/down to select the **AWB** icon and then press the joystick.

- The selected color temperature/color compensation (CC) value will be set and will appear on the screen next to the white balance icon.

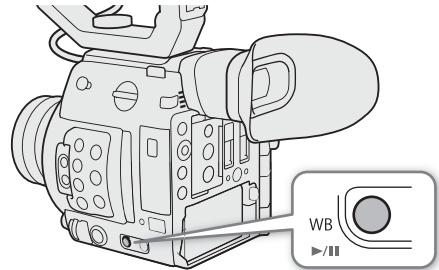

### **i** NOTES

- Custom white balance may provide better results in the following cases:
  - Changing lighting conditions
  - Close-ups
  - Subjects in a single color (sky, sea or forest)
  - Under mercury lamps and certain types of fluorescent and LED lights
- You can use the **MENU** ➤ [P] [3] Camera Setup] ➤ [AWB Response] setting to change how quickly the white balance changes in auto white balance (AWB) mode.
- If you set an assignable button to [AWB Lock] (📖 125), you can press the button to lock the current white balance settings set automatically by the camera. To cancel the lock, press the button again (resume auto white balance mode) or select a different white balance setting.
- Auto white balance is not available during slow motion recording.

## Adjusting the Focus

Depending on the lens used, the camera offers several ways to focus and incorporates Dual Pixel CMOS AF technology for advanced autofocus performance. Refer to the list of compatible lenses and functions that can be used (📖 230). You can also adjust the focus remotely using Browser Remote on a connected network device (📖 170).

**Manual focus:** Turn the focus ring on the lens to adjust the focus. The camera offers several focus assistance functions (📖 82) to help you focus more accurately when using the manual focus.

**One-shot AF<sup>1</sup>:** With the lens's focus mode switch set to AF, you will be able to focus manually but still have the option to press the ONE-SHOT AF button to let the camera focus automatically once on the subject inside the AF frame.

**AF-Boosted MF<sup>1</sup>:** Focus manually most of the way and let the camera finish focusing automatically.

**Continuous AF<sup>1</sup>:** The camera continuously focuses on the subject inside the AF frame. You can use the focus lock function (📖 86) to change the composition of the picture while keeping the focus on the selected spot.

**Face AF<sup>1</sup>:** The camera automatically detects a person's face, focuses on it and can track it if that person moves.

**Tracking<sup>1</sup>:** After you select a subject, the camera keeps focusing it and tracks the subject if it moves.

Note that some methods allow you to operate aspects of the focus by touching the LCD screen<sup>2</sup>.

<sup>1</sup> Not available when a manual focus lens is attached to the camera.

<sup>2</sup> Supplied accessory for the C200; optional accessory for the C200B.

Operating modes: CAMERA | MEDIA | RAW | MP4 | XF-AVC

### Focusing methods and required settings

Focusing method		Focus mode switch on an EF lens <sup>1</sup>	AF mode <sup>2</sup>
Manual focus	Focus ring	MF	–
		AF <sup>3</sup>	[One Shot]
	Browser Remote	AF	
One-shot AF	ONE-SHOT AF button	AF	[One Shot]
	Browser Remote		
AF-Boosted MF	Focus ring → Camera (automatic)	AF	[AF-Boosted MF]
	Browser Remote → Camera (automatic)		
Continuous AF	Automatic (camera or Browser Remote)	AF	[Continuous]
Face AF <sup>4</sup> /Tracking <sup>5</sup>	Camera or Browser Remote	AF	–

<sup>1</sup> For the necessary settings on compatible EF Cinema lenses, see the table below.

<sup>2</sup> **MENU** ➤ [P] [4] Camera Setup ➤ [AF Mode].

<sup>3</sup> Depending on the lens, the focus ring may be disabled when the focus mode switch is set to AF.

<sup>4</sup> **MENU** ➤ [P] [5] Camera Setup ➤ [Face Detection].

<sup>5</sup> To activate tracking, set an assignable button to [Tracking] and press the button.

### Required settings on EF Cinema lenses

To adjust the focus from the camera, you will need to change the focus mode using the controls on the lens. Required settings vary depending on the lens. Refer to the following table and the instruction manual of the lens used.

Lens	Part used on the lens	Setting for automatic adjustment	Setting for manual adjustment
EF lens	Focus mode switch	AF	MF
CN7x17 KAS S/E1 CN10x25 IAS S/E1 CN20x50 IAS H/E1	Focus operation change-over knob	SERVO	MANU.
CN-E18-80mm T4.4 L IS KAS S CN-E70-200mm T4.4 L IS KAS S	Autofocus/Manual Focus change-over switch	AF	MF

## Manual Focus

Focus manually using the focus ring on the lens. You can also perform this function remotely using Browser Remote on a connected network device (📖 170).

The autofocus mode is set to [One Shot] by default. If you need to change the setting, start the procedure from the beginning. Otherwise, you can start from step 3 below.

### 1 Open the focus [AF Mode] submenu.

**MENU** ➤ [📷 4] Camera Setup ➤ [AF Mode]

### 2 Select [One Shot] and then press the joystick.

- On an EF lens, you can set the lens's focus mode switch to MF. On a compatible EF Cinema lens, enable manual adjustment on the lens (📖 80).

### 3 Press the FOCUS GUIDE button to display the focus guide.

- If you are not using the camera grip, you can alternatively set an assignable button to [Focus Guide] (📖 125).

### 4 Turn the focus ring to adjust the focus.

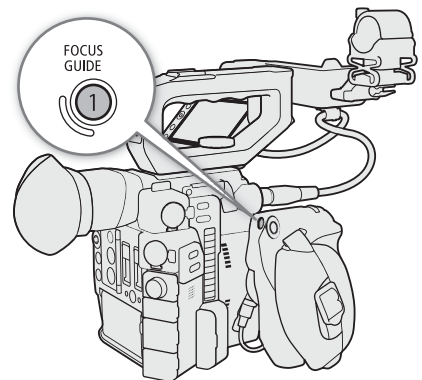

## **i** NOTES

- With some EF lenses, you may be able to operate the focus ring even when the focus mode switch is set to AF.
- If you operate the zoom after focusing, the focus on the subject may be lost.
- If you focus manually and then leave the camera with the power turned on, the focus on the subject may be lost after a while. This possible slight shift in focus is a result of the internal temperature rising in the camera and lens. Check the focus before resuming shooting.
- When adjusting the focus, be careful not to touch the front of the lens or moving parts on the lens except for the focus ring.
- When an optional RC-V100 Remote Controller is connected to the camera, you can adjust the focus with the remote controller's FOCUS dial. At default settings, turn the dial right to focus farther and left to focus nearer.

### Using the Focus Assistance Functions

In order to focus more accurately, you can use the following focus assistance functions: Dual Pixel Focus Guide, an onscreen guide that shows you if the picture is in focus; peaking, which creates a clearer contrast by emphasizing the outlines of the subject; and magnification, which enlarges the image on the screen. You can use peaking and the focus guide or peaking and magnification simultaneously for greater effect.

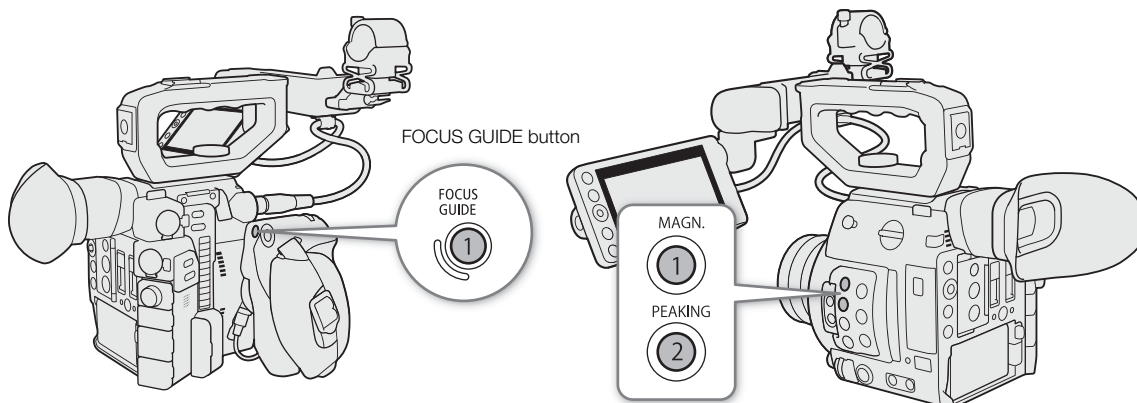

#### Dual Pixel Focus Guide

The focus guide gives you an intuitive visual indication of the current focus distance and the direction and amount of adjustment necessary to bring the picture into full focus. When used in combination with face detection (87), the guide will focus on the vicinity of the eyes of the person detected as the main subject.

#### 1 Press the FOCUS GUIDE button to display the focus guide.

- If you are not using the camera grip, you can alternatively set an assignable button to [Focus Guide] (125).
- Alternatively, you can use the **MENU** ➤ [Assistance Functions] ➤ [Focus Guide] setting to turn the focus guide on and off.

#### 2 If necessary, use the joystick to move around the focus frame.

- When using the LCD monitor<sup>1</sup>, you can move the focus frame by touching the area of the screen to focus on.
- You can display a secondary focus frame using the **MENU** ➤ [Assistance Functions] ➤ [Focus Guide 2nd Frame] setting. When both focus frames are displayed on the screen, you can press the joystick to switch the focus guide between them.

<sup>1</sup> Supplied accessory for the C200; optional accessory for the C200B.

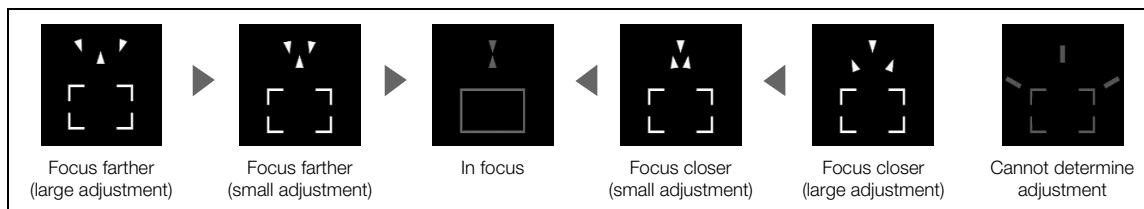

#### **i** NOTES

- With subjects or in situations where autofocus may not work well (85), the focus guide may not work correctly.
- The Dual Pixel Focus Guide function cannot be used in the following cases:
  - While the focus is being adjusted automatically using one-shot AF, AF-Boosted MF or continuous AF.
  - When the aperture value used is F11 or larger.
  - When a manual focus lens is attached to the camera, except for compatible EF Cinema lenses (230).

- When the digital tele-converter is set to an option other than [Off].
- When the Dual Pixel Focus Guide function is used together with Face AF or tracking, the focus guide may not focus the main subject's eyes correctly, depending on the direction in which the face is turned.

## Peaking

The camera offers two peaking levels.

1 Press the PEAKING button.

- The peaking icon (**PEAK1** or **PEAK2**) appears on the left of the screen and the outlines in the image will be emphasized, depending on the focus.
  - Press the button again to turn off peaking.
  - Alternatively, you can use the **MENU** ➤ [**AF** 2 Assistance Functions] ➤ [Peaking: VIDEO Output] or [Peaking: VF Output]<sup>1</sup> setting to turn peaking on and off.
- <sup>1</sup> **C200** only.

2 Open the peaking's [Peaking] submenu to select the peaking level.

**MENU** ➤ [**AF** 2 Assistance Functions] ➤ [Peaking]

3 Select the desired level and then press the joystick.

## Magnification

1 Press the MAGN. button.

- **MAGN.** appears at the left of the screen and the center of the screen<sup>1</sup> is magnified approximately 2 times.
- The orange frame displayed on the top right of the screen (magnification frame) shows the approximate part of the image shown magnified.
- Press the joystick to further increase the magnification to approximately 4 times. Press the joystick again to return to the previous magnification.

2 If necessary, use the joystick to move around the magnification frame and check other parts of the image.

- When using the LCD monitor<sup>2</sup>, you can also drag your finger across the screen to move the frame.
- Press the CANCEL button to return the magnification frame to the center position.

3 Press the MAGN. button again to cancel the magnification.

<sup>1</sup> If one of the AF frames or a face detection frame is displayed on the screen, the area around the active frame will be magnified instead.

<sup>2</sup> Supplied accessory for the C200; optional accessory for the C200B.

## NOTES

### • About Peaking/Magnification:

- You can use the **MENU** ➤ [**AF** 2 Assistance Functions] ➤ [Peaking 1] and [Peaking 2] settings to set the color, gain and frequency of the two peaking levels independently of each other.
- You can select whether to display the peaking effect from the VIDEO terminal or on the camera viewfinder (**C200** only) with the **MENU** ➤ [**AF** 2 Assistance Functions] ➤ [Peaking: VIDEO Output] and [Peaking: VF Output] settings.
- You can select whether to display the magnified image on the camera viewfinder (**C200** only) and from the VIDEO terminal, or from the SDI/HDMI OUT<sup>1</sup> terminal with the **MENU** ➤ [**AF** 3 Assistance Functions] ➤ [Magn.: VF+VIDEO Output] (**C200B** [Magn.: VIDEO Output]) and [Magn.: SDI/HDMI Output] settings.
- You can also use the **MENU** ➤ [**AF** 2 Assistance Functions] ➤ [B&W during Peaking] or **MENU** ➤ [**AF** 3 Assistance Functions] ➤ [B&W during Magn.] to switch the screen to black & white while using the respective assistance function.
- The assistance functions will not affect your recordings.
- The magnified image will stop being displayed if you change the recording format or resolution and color sampling setting.

<sup>1</sup> Magnification is not available when the video output from the HDMI terminal is 4K (3840x2160).

- While color bars are displayed, peaking, magnification and waveform monitor are not available.

## One-Shot AF

In this focus mode, you will focus manually in most situations but still have the option to have the camera focus automatically only once on the subject inside the AF frame that appears on the screen. You can also change the size and position of the AF frame.

### 1 Set the focus mode switch on the lens to AF.

- On a compatible EF Cinema lens, enable automatic adjustment on the lens (📖 81).
- **AF** will appear on the left of the screen.

### 2 Open the focus [AF Mode] submenu.

**MENU** ➤ [📷 4 Camera Setup] ➤ [AF Mode]

### 3 Select [One Shot] and then press the joystick.

### 4 If necessary, change the size and position of the AF frame (📖 86).

- You can move the AF frame by touching the desired position on the LCD screen.

### 5 Press and hold the ONE-SHOT AF button.

- A white AF frame will appear on the screen and the camera will focus automatically. When you are using Face AF, the face detection frame around the face of the person who has been determined to be the main subject will turn white.
- When correct focus has been achieved, the AF frame turns green. If the camera cannot focus automatically, the AF frame will turn red.
- The AF frame will disappear when you release the ONE-SHOT AF button.

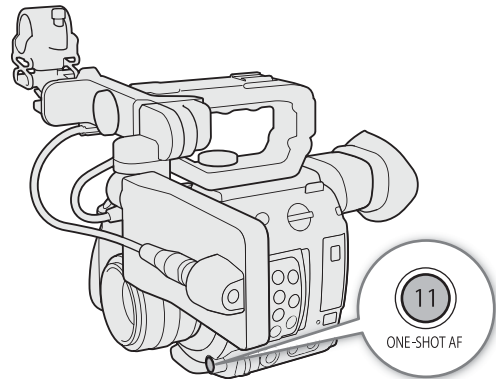

## **i** NOTES

- One-shot AF will not work in the following cases.
  - When slow motion recording is activated.
  - When the shutter speed mode is set to [Slow] and the shutter speed is set to 1/4 or 1/3.
  - When Face AF is set to [Face Only] and a face has not been detected.
  - When the digital tele-converter is activated.
- When the aperture value used is F11 or higher, Dual Pixel CMOS AF will not work and the camera will focus using contrast-detection autofocus.

## AF-Boosted MF

In this focus mode, you can focus manually most of the way and let the camera finish focusing automatically. This is very convenient when you want to make certain that your 4K recordings are in sharp focus. Additionally, with this mode, if the camera cannot evaluate how to adjust the focus, it will not perform unreliable focus adjustments. This results in an overall smoother focusing operation than with continuous AF.

### 1 Set the focus mode switch on the lens to AF.

- On a compatible EF Cinema lens, enable automatic adjustment on the lens (📖 81).
- **AF** will appear on the left of the screen.

### 2 Open the focus [AF Mode] submenu.

**MENU** ➤ [📷 4 Camera Setup] ➤ [AF Mode]

### 3 Select [AF-Boosted MF] and then press the joystick.

- When the focus is in the manual adjustment range, a yellow focus frame will appear on the screen.

### 4 If necessary, change the size and position of the AF frame (📖 86).



## 5 Turn the focus ring to adjust the focus.

- Focus manually to bring the subject closer into focus. When the focus enters the automatic adjustment range, the focus frame will turn white and the camera will then finish focusing automatically.
- While the focus stays within the automatic adjustment range, the camera will keep the subject in focus automatically.

## Continuous AF

The camera will focus automatically on a subject inside the main area of the image (approximately 80% of the screen's length and width).

### 1 Set the focus mode switch on the lens to AF

- On a compatible EF Cinema lens, enable automatic adjustment on the lens (☞ 81).
- **AF** will appear on the left of the screen.

### 2 Open the focus [AF Mode] submenu.

**MENU** ➤ [P] 4 Camera Setup] ➤ [AF Mode]

### 3 Select [Continuous] and then press the joystick.

- A white AF frame will appear on the screen. If necessary, change the size and position of the AF frame (☞ 86).
- When you are using Face AF, a white detection frame will appear around the face of the person who has been determined to be the main subject.

## NOTES

### About the autofocus (AF) functions:

- The point where the camera focuses may change slightly depending on shooting conditions, such as subject, brightness and zoom position. Check the focus before resuming shooting.
- Autofocus may take longer in the following cases.
  - When the frame rate set in the video configuration is set to 29.97P, 25.00P, 24.00P or 23.98P.
  - With some EF lenses, the camera may take longer to focus automatically or may not be able to focus correctly. Visit your local Canon website for the latest information.
- When using autofocus with compatible EF lenses, you can change various aspects of the autofocus function with the following settings. Visit your local Canon website for the latest information.
  - **MENU** ➤ [P] 4 Camera Setup] ➤ [Apply AF Speed Limit] to select whether the selected AF speed is applied at all times or only while recording.
  - **MENU** ➤ [P] 4 Camera Setup] ➤ [AF Speed] to set the AF speed (the speed at which the focus is adjusted) to one of 10 levels.
  - **MENU** ➤ [P] 4 Camera Setup] ➤ [AF Response] to set the responsiveness of the autofocus function to one of 7 levels.
  - While using continuous AF, you can hold the ONE-SHOT AF button pressed down to temporarily adjust the focus using the maximum AF speed and AF response. This is helpful when you want to focus quickly after focus was lost or to keep a subject in focus while you follow it.
- Continuous AF will not work in the following cases.
  - When using an EF lens that does not have a focus mode switch.
  - While adjusting the aperture, except when using an EF lens compatible with automatic aperture (☞ 230).
  - While adjusting the focus using a remote controller attached to the REMOTE terminal.
  - When slow motion recording is activated.
  - When the digital tele-converter is activated.

- Autofocus may not work well on the following subjects or in the following cases. In such case, focus manually.
  - Reflective surfaces
  - Subjects with low contrast or without vertical lines
  - Fast moving subjects
  - When an ISO speed or gain value in the extended range is selected (📖 69).
  - When the [Gamma] setting in the custom picture file (📖 133) is set to one of the Canon Log settings or [Wide DR].
  - When using small apertures.
  - When subjects at different distances appear inside the AF frame.
  - Through dirty or wet windows
  - Night scenes
  - Subjects with a repetitive pattern

### Activating AF Lock

While using continuous AF or AF-Boosted MF, you can lock the focus on a certain subject and then move the camera to change the composition. To use AF lock, you must set an assignable button to [AF Lock] in advance.



- 1 Set an assignable button to [AF Lock] (📖 125).
- 2 While the autofocus is active, press the assignable button.
  - The focus will be locked and **AF** and the AF frame will turn gray. When you are using Face AF, the face detection frame around the main subject will turn gray.
  - Press the button again to cancel the AF lock.

### NOTES

- AF lock will be canceled automatically in the following cases:
  - If the camera is turned off or the camera's system frequency is changed.
  - If the lens is removed or replaced.
  - If **MENU** ➤ [ 4] Camera Setup] ➤ [AF Mode] is changed to [One Shot].
  - If the camera is set to slow motion recording mode.
  - When the digital tele-converter is activated.

### Changing the AF Frame Size and Position

You can change the size and position of the AF frame that appears on the screen while using one of the autofocus functions.

- 1 Open the [AF Frame Position] submenu.
  - MENU** ➤ [ 4] Camera Setup] ➤ [AF Frame Position]
- 2 Select the desired option and then press the joystick.
- 3 Open the [AF Frame Size] submenu.
  - MENU** ➤ [ 4] Camera Setup] ➤ [AF Frame Size]
- 4 Select the desired option and then press the joystick.

#### Options

[Selectable]: You can move the AF frame using the joystick or by touching the LCD screen. Press the CANCEL button to return the frame to the center of the screen.

[Center Frame]: A fixed AF frame appears at the center of the screen.

[Large]: Standard AF frame size.

[Small]: Smaller AF frame size (about 1/3 the standard size).

### NOTES

- When the digital tele-converter or EF-S lens correction is activated, the AF frame will return to the center.

## Face Detection

When the face detection function is activated, the camera will detect people's faces. When there are a number of people in the picture, one person will be determined to be the main subject but you have the option to select a different person as the main subject. The camera will keep tracking the main subject even when it moves. You can use face detection with one of the autofocus functions to let the camera focus on the main subject automatically (Face AF). You can also combine face detection with the Dual Pixel Focus Guide function (□ 82) to help you focus on the main subject manually.

1 Open the [Face Detection] submenu.

**MENU** ➤ [📷 5] Camera Setup ➤ [Face Detection]

2 Select [On] and then press the joystick.

3 Open the [Face AF] submenu.

**MENU** ➤ [📷 5] Camera Setup ➤ [Face AF]

4 Select the desired option and then press the joystick.

5 Point the camera at the subject.

- A face detection frame will appear around all detected faces. The person identified as main subject will have a face detection frame with small arrows (◀▶) on the sides. If necessary, push the joystick left/right or touch the desired subject on the LCD screen to change the main subject when there is more than one person.
- During continuous AF, the camera will keep focusing on the main subject's face. During one-shot AF, the camera will focus on the main subject's face while you hold the ONE-SHOT AF button pressed down.
- If you use face detection together with the tracking function (□ 88), the camera will be able to track the selected main subject more reliably.

### Options

[Face Priority]: When there is no face detected, the camera focuses automatically according to the AF mode currently selected.

[Face Only]: When there is no face detected, the camera locks the focus.

### Face AF operation by AF mode

MENU ➤ [📷 4] Camera Setup ➤ [AF Mode] setting and focus operation	MENU ➤ [📷 5] Camera Setup ➤ [Face AF] setting			
	[Face Priority]		[Face Only]	
	Face detected	No face detected	Face detected	No face detected
[One Shot] while the ONE-SHOT AF button is not pressed	Manual focus			
[One Shot] while the ONE-SHOT AF button is held pressed down	Focus on the detected face	Focus on the subject inside the AF frame	Focus on the detected face	Manual focus
[Continuous] (autofocus), [AF-Boosted MF] within the automatic adjustment range				
[AF-Boosted MF] within the manual adjustment range (yellow AF frame)	Manual focus			

**i** NOTES

- In certain cases, faces may not be detected correctly. Typical examples include:
  - Faces extremely small, large, dark or bright in relation to the overall picture.
  - Faces that are turned to the side, at a diagonal, partially hidden or upside-down.
- Face detection cannot be used in the following cases:
  - When the shutter speed used is slower than 1/30 (59.94 Hz recordings), 1/25 (50.00 Hz recordings) or 1/24 (24.00 Hz recordings).
  - When slow motion recording is activated.
  - When a manual focus lens is attached to the camera.
  - When the digital tele-converter is activated.
- The camera may mistakenly detect the faces of non-human subjects. In such case, turn face detection off.
- If you set an assignable button to [Face Detection] (📖 125), you can press the button to turn the function on and off. If you set an assignable button to [Face AF], you can press the button to toggle between the face detection options.

## Tracking a Specific Subject



You can have the camera track other moving subjects that are not faces and also combine the tracking function with one of the autofocus functions to let the camera focus on the desired subject automatically. To use the tracking function, you will need to set an assignable button to [Tracking] in advance.

1 Set an assignable button to [Tracking] (📖 125).

2 Press the assignable button.

- The subject selection mark  will appear on the screen.
- Press the assignable button again or the CANCEL button to exit the subject selection screen.

3 Select the subject you want to track.

- Push the joystick up/down/left/right or touch the desired subject on the LCD screen to place the center of the  mark on the desired subject and then press the joystick. If the tracking failed, the  mark will turn red momentarily. Select the subject again.

4 The  mark changes to a tracking frame and the camera will start tracking the selected subject.

- During continuous AF, the camera will keep focusing on the selected subject. During one-shot AF, the camera will focus on the selected subject while you hold the ONE-SHOT AF button pressed down.
- Press the joystick again or press the assignable button to return to the subject selection screen and select a different subject, or press the CANCEL button to end the tracking function and return the camera to the focus mode that was used previously.

**i** NOTES

- The camera may start tracking the incorrect subject if there is another subject in the picture with similar color/pattern characteristics. In that case, press the joystick to return to the selection screen and select the desired subject again.

## Zooming

When an EF Cinema lens compatible with zooming or the optional PZ-E1 Power Zoom Adapter with a compatible EF lens is attached to the camera, you can use the joystick on the camera grip<sup>1</sup> to operate the zoom. You can also zoom remotely using Browser Remote on a connected network device (📖 170).

<sup>1</sup> Supplied accessory for the C200; optional accessory for the C200B.

### Required settings on EF Cinema lenses

To operate the zoom from the camera, you will need to enable automatic adjustment using the controls on the lens. Required settings vary depending on the lens. Refer to the following table and the instruction manual of the lens used.

Lens	Part used on the lens	Setting for automatic adjustment
CN7x17 KAS S/E1 CN10x25 IAS S/E1 CN20x50 IAS H/E1	Zoom operation change-over knob	SERVO
CN-E18-80mm T4.4 L IS KAS S CN-E70-200mm T4.4 L IS KAS S	Zoom change-over switch	SERVO
EF-S 18-135mm F3.5-5.6 IS USM*	Zoom mode switch	PZ (Power Zoom)

\* When using with the optional PZ-E1 Power Zoom Adapter. Make the required setting on the PZ-E1, not the lens.

Operating modes: CAMERA MEDIA | RAW MP4 XF-AVC

1 Enable automatic zoom adjustment on the lens.

2 Open the zoom activation submenu.

**MENU** ➤ [🗨️ 5] Camera Setup] ➤ [Camera Grip Zoom]

3 Select [On] and then press the joystick.

4 Open the zoom speed submenu.

**MENU** ➤ [🗨️ 5] Camera Setup] ➤ [Camera Grip Zoom Speed]

5 Select the desired zoom speed and then press the joystick.

- Zoom speeds are constant; [1] being the slowest and [16] the fastest.

6 Close the menu and use the joystick on the camera grip to zoom.

- Push the joystick up to zoom in (telephoto) and push it down to zoom out (wide-angle).

### **i** NOTES

- When an optional RC-V100 Remote Controller is connected to the camera and the lens is correctly set, you can zoom with the remote controller's ZOOM dial.
- When using slow zoom speeds, it may take longer for the lens to start moving.
- You can use the **MENU** ➤ [🗨️ 5] Camera Setup] ➤ [Tele-converter] setting to set the digital tele-converter to approximately 1.5x, 3x or 6x.
- If you set an assignable button to [Tele-converter] (📖 125), you can press the button to turn the digital tele-converter on and off. The digital tele-converter will activate at the previously selected level.

# Onscreen Markers and Zebra Patterns

Using onscreen markers allows you to make sure your subject is correctly framed and is within the appropriate safe area. The zebra patterns help you identify areas that are overexposed. The onscreen markers and zebra pattern will not affect your recordings.

Operating modes: CAMERA MEDIA | RAW MP4 XF-AVC

## Displaying Onscreen Markers

The camera offers several onscreen markers. You can display multiple onscreen markers simultaneously.

### 1 Open a marker activation submenu.

**MENU** [6 Assistance Functions] [Center Marker], [Horizontal Marker], [Grid Marker], [Aspect Marker]

**MENU** [7 Assistance Functions] [Safe Area Marker]

### 2 Select a marker you wish to display, select the desired marker color and then press the joystick.

- Select [Off] to turn off the selected marker.
- You can display multiple markers simultaneously. Repeat this step as necessary.
- If you selected [Aspect Marker] or [Safe Area Marker], select the desired safe area or aspect ratio with the following procedures ( 91) before continuing with step 3.

### 3 Select [Markers: VF+VIDEO Output] (**C200B** [Markers: VIDEO Output]) and/or [Markers: SDI/HDMI Output], select [On] and then press the joystick.

- Select [Markers: VF+VIDEO Output] (**C200B** [Markers: VIDEO Output]) to display the markers on the viewfinder (**C200** only) and from the VIDEO terminal; select [Markers: SDI/HDMI Output] to display the markers from the SDI/HDMI OUT terminal. Select [Off] instead to not display the onscreen markers on the respective video outputs.

## Options

- [Center Marker]: Displays a small marker that indicates the center of the screen.
- [Horizontal Marker]: Displays a horizontal line to help you compose level shots.
- [Grid Marker]: Displays a grid that allows you to frame your shots correctly (horizontally and vertically).
- [Aspect Marker]: Displays markers that indicate various aspect ratios to help you keep your shot within that area. Available options for [Marker Aspect Ratio] are [4:3], [13:9], [14:9], [16:9], [1.375:1], [1.66:1], [1.75:1], [1.85:1], [1.90:1], [2.35:1], [2.39:1] and [Custom], a free aspect ratio set by the user.
- [Safe Area Marker]: Displays indicators that show various safe areas, such as the action safe area and text safe area. You can select the core area used as the basis for calculating the safe area and a percentage ([80%], [90%], [92.5%] or [95%]), relative to that core area.

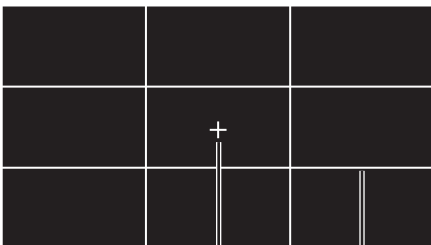

Center marker      Grid

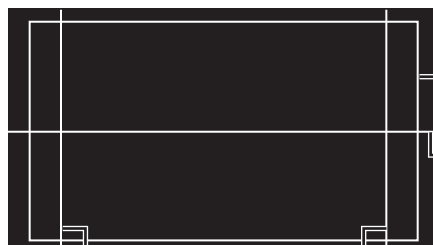

Safe area 80% out of the whole picture  
Level marker

Aspect guide 4:3

### To set the aspect ratio



- 1 Select [Marker Aspect Ratio], select the desired option and then press the joystick
  - If you selected one of the preset aspect ratios, the rest of the procedure is not necessary. If you selected [Custom], continue the procedure to set the desired aspect ratio.
- 2 Select [Marker Custom Asp. Ratio] and then press the joystick.
- 3 Push the joystick up/down to select the first digit of the aspect ratio and then press the joystick to move to the next.
  - Change the rest of the digits in the same way.
- 4 Select [Set] and then press the joystick.

### To set the safe area

If an aspect marker is not selected, the safe area will be calculated as a percentage of the whole image ([Whole Picture]) and you can only select the percentage (step 2). To calculate the safe area as a percentage of an aspect ratio marker ([Selected Aspect Marker]), select an aspect ratio marker in advance and perform the procedure from the beginning.

- 1 Select [Basis for Marker Safe Area], select the desired option and then press the joystick.
- 2 Select [Marker Safe Area %], select the desired percentage and then press the joystick.

### NOTES

- You can turn off all other onscreen displays, leaving only the onscreen markers ( 60).
- Markers are not available when the video output from the HDMI OUT terminal is 4K (3840x2160) recorded at 59.94P or 50.00P.
- If you set an assignable button to [Markers: All] ( 125), you can press the button to turn the onscreen markers on and off.

## Displaying Zebra Patterns

The camera has a zebra pattern function that shows black and white diagonal stripes over areas that are overexposed. There are two types of zebra patterns and you can display both simultaneously. Zebra 1 lets you identify areas within a certain range ( $\pm 5\%$  of a specified level from 5% to 95%) while zebra 2 lets you identify areas that are over a specified level (from 0% to 100%).

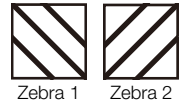



- 1 Open the [Zebra] submenu.

**MENU**   [4] Assistance Functions]  [Zebra]

- 2 Select a zebra pattern.

- 3 Open the zebra level submenu.

**MENU**   [4] Assistance Functions]  [Zebra 1 Level] or [Zebra 2 Level]

- 4 Select the desired zebra level and then press the joystick.
- 5 Press the ZEBRA button to activate the selected zebra pattern.

- Alternatively, before closing the menu, you can also select [Zebra: VIDEO Output] or [Zebra: VF Output]<sup>1</sup>, select [On] and then press the joystick to display the zebra pattern from the VIDEO terminal or on the camera viewfinder<sup>1</sup>.

<sup>1</sup> **C200** only.

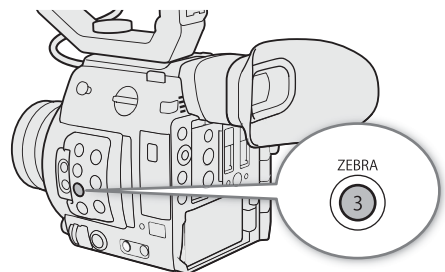

## Setting the Time Code

In **CAMERA** mode, the camera generates a time code signal and records it with the recorded clips. The time code signal can be output from the SDI terminal and HDMI OUT terminal. In **MEDIA** mode, the time code embedded in the clip being played back can be output from the SDI terminal.

Depending on the frame rate used, you may be able to select between a drop frame and a non-drop frame time code signal (□ 93). The default mode varies depending on the country/region of purchase and, though the time code display style is different for DF and NDF, in this section the NDF display style is used for simplicity's sake.

### Selecting the Time Code Mode

You can select the camera's time code mode.

Operating modes: **CAMERA** **MEDIA** | **RAW** **MP4** **XF-AVC**

1 Open the [Time Code Mode] submenu.

**MENU** ➤ [**F** 3] System Setup ➤ [Time Code Mode]

2 Select the desired option and then press the joystick.

#### Options

- [Preset]: The time code starts from an initial value you can select in advance. The default initial time code is 00:00:00:00.  
See the following procedures to select the time code running mode and set the initial time code.
- [Regen.]: The camera will read the selected recording media and the time code will continue from the last time code recorded on the recording media. The time code runs only while recording so clips recorded consecutively on the same recording media will have continuous time codes.

### Setting the Time Code Running Mode

If you set the time code mode to [Preset], you can select the time code running mode.

1 Open the [Time Code Run] submenu.

**MENU** ➤ [**F** 3] System Setup ➤ [Time Code Run]

2 Select the desired option and then press the joystick.

#### Options

- [Rec Run]: The time code runs only while recording so clips recorded consecutively on the same recording media will have continuous time codes.
- [Free Run]: The time code starts running the moment you press the joystick and keeps running regardless of the camera's operation.



## Setting the Time Code's Initial Value

If you set the time code mode to [Preset], you can set the initial value of the time code.

1 Open the [Set Time Code] submenu.

**MENU**  [ 3] System Setup]  [Set Time Code]

2 Select [Change] and then press the joystick.

- The time code setting screen appears with an orange selection frame indicating the hours.
- To reset the time code to [00:00:00:00], select [Reset] instead. If the running mode is set to [Free Run], the time code will be reset the moment you press the joystick and keep running continuously from 00:00:00:00.

3 Push the joystick up/down to set the hours and press the joystick to move to the minutes.

- Change the rest of the fields (minutes, seconds, frame) in the same way.
- Press the CANCEL button to close the screen without setting the time code.

4 Select [Set] and press the joystick to close the screen.

- If the running mode is set to [Free Run], the time code will start running from the selected time code the moment you press the joystick.

## Selecting Drop or Non-Drop Frame

When the frame rate is set to 59.94P, 59.94i or 29.97P, you can select between a drop frame (DF) or non-drop frame (NDF) time code, depending on how you plan to use your recordings.

With all other frame rates, the time code is set to non-drop frame (NDF) and cannot be changed.

Operating modes: CAMERA MEDIA | RAW MP4 XF-AVC

1 Open the [Time Code DF/NDF] submenu.

**MENU**  [ 3] System Setup]  [Time Code DF/NDF]

2 Select [DF] or [NDF] and then press the joystick.

- The time code display will differ depending on the setting. When you select [DF], the time code will appear as [00:00:00.00]; when you select [NDF], it will appear as [00:00:00:00].

## Putting the Time Code Display on Hold

If you set an assignable button to [Time Code Hold] ( 125), you can press the button to freeze the display of the time code\*. While the time code display is put on hold, [H] will appear on the screen next to the time code.

Operating modes: CAMERA MEDIA | RAW MP4 XF-AVC

The time code continues to run normally while the time code display is on hold. When you resume the time code display, the current time code will be displayed.



\* The time code signal output from the terminals will not be put on hold. However, the time code displayed on a monitor connected to the HDMI OUT terminal will be put on hold.

### About the Time Code Display

An icon may appear next to the time code depending on the operation. Refer to the following table.

Icon	Description
R	The time code mode is set to [Regen].
P	The time code mode is set to [Preset] and the running mode is set to [Rec Run].
F	The time code mode is set to [Preset] and the running mode is set to [Free Run].
H	Time code display is on hold.
No icon	Time code during clip playback.

### NOTES

- The frames value of the time code runs from 0 to 23 (frame rate set to 23.98P or 24.00P), from 0 to 24 (frame rate set to 25.00P, 50.00i or 50.00P), or from 0 to 29 (all other frame rates). However, if the frame rate is set to 23.98P or 24.00P and the SDI/HDMI scan mode is set to [PsF], the frames value will run from 0 to 29.
- When you are using interval recording, frame recording or slow motion recording, you cannot select the [Free Run] running mode. Conversely, when you are using pre-recording mode, [Free Run] is set automatically and cannot be changed.
- When you are using interval recording, frame recording or slow motion recording, the time code signal will not be output from the SDI terminal or HDMI OUT terminal.
- When you mix drop frame and non-drop frame time codes, there might be a discontinuity in the time code at the point where the recording starts.
- When you are using the [Free Run] running mode, the time code will continue running as long as the lithium button battery has some charge left, even if you disconnect all other power sources.
- If you set an assignable button to [Time Code] ( 125), you can press the button to open the [ 3] System Setup] menu.

## Setting the User Bit

The user bit display can be selected from the date or the time of recording, or an identification code consisting of 8 characters in the hexadecimal system. There are sixteen possible characters: the numbers 0 to 9 and the letters A to F. The user bit is recorded with RAW or XF-AVC clips and can be output from the SDI terminal and HDMI OUT terminal.

Operating modes: CAMERA MEDIA | RAW MP4 XF-AVC

### 1 Open the [User Bit Type] submenu.

**MENU** ► [F 3] System Setup ► [User Bit Type]

### 2 Select the desired user bit type and press the joystick.

- Select [Setting] to set your own identification code, [Time] to use the time as the user bit, or [Date] to use the date as the user bit.
- If you selected [Time] or [Date], the rest of the procedure is not necessary. If you selected [Setting], continue the procedure to set the identification code.

### 3 Select [Change] and then press the joystick.

- The user bit setting screen appears with an orange selection frame on the leftmost digit.
- To reset the user bit to [00 00 00 00], select [Reset] instead.

### 4 Push the joystick up/down to select the first character and press the joystick to move to the next.

- Change the rest of the characters in the same way.
- Press the CANCEL button to close the screen without setting the user bit.

### 5 Select [Set] and press the joystick to close the screen.

## Recording Audio

The camera features 4-channel linear PCM and 2-channel MPEG-2 AAC-LC<sup>1</sup> audio recording and playback. The sampling frequency is 48 kHz and the audio sampling bit depth depends on the recording format. You can record audio using the INPUT terminals (commercially available microphones, analog line-in audio sources, AES/EBU digital audio sources), the MIC terminal (commercially available microphones) or the built-in monaural microphone<sup>2</sup>.

An audio signal will also be output with the video signal from the SDI terminal and HDMI OUT terminal. You can record this audio signal on an external recorder.

<sup>1</sup> Available for MP4 clips only.

<sup>2</sup> Only for recording notes while shooting.

## Audio Settings and Recorded Audio Channels

Which audio inputs are recorded to which audio channels is determined by a combination of menu settings and audio-related controls on the camera. Refer to the camera illustration below and the table on the next page.

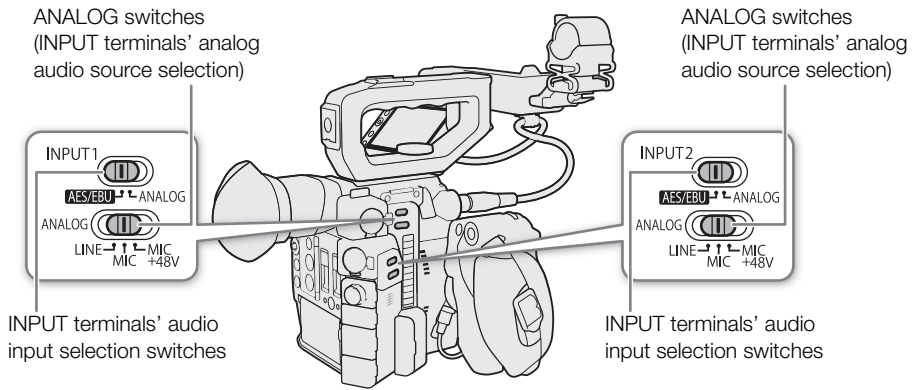

[Select CH1/ CH2 Input] <sup>1</sup>	[Select CH3/ CH4 Input] <sup>2</sup>	Audio input selection switches		[CH2 Input] <sup>2</sup>	Recorded audio channels/audio sources			
		for INPUT 1	for INPUT 2		CH1	CH2	CH3 <sup>3</sup>	CH4 <sup>3</sup>
[INPUT Terminals]	[MIC Terminal]	AES/EBU	–	–	INPUT 1 terminal (digital audio)		MIC terminal (L)	MIC terminal (R)
[INPUT Terminals]	[INPUT Terminals]	AES/EBU	AES/EBU	–	INPUT 1 terminal (digital audio)		INPUT 2 terminal (digital audio)	
[INPUT Terminals]	[INPUT Terminals]	AES/EBU	ANALOG	–	INPUT 1 terminal (digital audio)		–	INPUT 2 terminal
[INPUT Terminals]	[Monaural Mic]	AES/EBU	–	–	INPUT 1 terminal (digital audio)		Built-in microphone (mono)	Built-in microphone (mono)
[INPUT Terminals]	[MIC Terminal]	ANALOG	–	[INPUT 2]	INPUT 1 terminal	INPUT 2 terminal	MIC terminal (L)	MIC terminal (R)
[INPUT Terminals]	[MIC Terminal]	ANALOG	–	[INPUT 1]	INPUT 1 terminal	INPUT 1 terminal	MIC terminal (L)	MIC terminal (R)
[INPUT Terminals]	[INPUT Terminals]	ANALOG	AES/EBU	[INPUT 1]	INPUT 1 terminal	INPUT 1 terminal	INPUT 2 terminal (digital audio)	
[INPUT Terminals]	[INPUT Terminals]	ANALOG	AES/EBU	[INPUT 2]	INPUT 1 terminal	–	INPUT 2 terminal (digital audio)	
[INPUT Terminals]	[INPUT Terminals]	ANALOG	ANALOG	[INPUT 2]	INPUT 1 terminal	INPUT 2 terminal	INPUT 1 terminal	INPUT 2 terminal
[INPUT Terminals]	[INPUT Terminals]	ANALOG	ANALOG	[INPUT 1]	INPUT 1 terminal	INPUT 1 terminal	INPUT 1 terminal	INPUT 2 terminal
[INPUT Terminals]	[Monaural Mic]	ANALOG	–	[INPUT 2]	INPUT 1 terminal	INPUT 2 terminal	Built-in microphone (mono)	Built-in microphone (mono)
[INPUT Terminals]	[Monaural Mic]	ANALOG	–	[INPUT 1]	INPUT 1 terminal	INPUT 1 terminal	Built-in microphone (mono)	Built-in microphone (mono)
[MIC Terminal]	[INPUT Terminals]	–	ANALOG	–	MIC terminal (L)	MIC terminal (R)	INPUT 1 terminal	INPUT 2 terminal
[MIC Terminal]	[INPUT Terminals]	–	AES/EBU	–	MIC terminal (L)	MIC terminal (R)	INPUT 2 terminal (digital audio)	
[MIC Terminal]	[MIC Terminal]	–	–	–	MIC terminal (L)	MIC terminal (R)	MIC terminal (L)	MIC terminal (R)
[MIC Terminal]	[Monaural Mic]	–	–	–	MIC terminal (L)	MIC terminal (R)	Built-in microphone (mono)	Built-in microphone (mono)
[Monaural Mic]	[INPUT Terminals]	–	ANALOG	–	Built-in microphone (mono)	Built-in microphone (mono)	INPUT 1 terminal	INPUT 2 terminal
[Monaural Mic]	[INPUT Terminals]	–	AES/EBU	–	Built-in microphone (mono)	Built-in microphone (mono)	INPUT 2 terminal (digital audio)	
[Monaural Mic]	[MIC Terminal]	–	–	–	Built-in microphone (mono)	Built-in microphone (mono)	MIC terminal (L)	MIC terminal (R)
[Monaural Mic]	[Monaural Mic]	–	–	–	Built-in microphone (mono)	Built-in microphone (mono)	Built-in microphone (mono)	Built-in microphone (mono)

<sup>1</sup> **MENU** ➤ [J] [1] Audio Setup ➤ [Select CH1/CH2 Input] and [Select CH3/CH4 Input] settings.

<sup>2</sup> **MENU** ➤ [J] [1] Audio Setup ➤ [CH2 Input] setting.

<sup>3</sup> Available for MP4 clips when **MENU** ➤ [2] Recording/Media Setup ➤ [Audio Format (MP4)] is set to [LPCM 16 bit 4CH].

## NOTES

- On the [Audio] status screens ( 200), you can check the audio level adjustment mode and input source for each of the audio channels.

### Connecting an External Microphone or External Audio Input Source to the Camera

To each of the INPUT terminals you can attach commercially available microphones, digital audio sources (AES/EBU), or analog line in sources with an XLR connector. To the MIC terminal you can attach commercially available condenser microphones with their own power supply, and a Ø 3.5 mm stereo mini plug. Using the supplied microphone holder, you can fix external microphones with a diameter of 19 mm to 20 mm.

Follow the procedure below to attach a microphone (refer also to the following illustration). To connect an external device to the camera, plug the device's cable into the desired INPUT terminal (4).

- 1 Loosen the microphone lock screw (1), open the microphone holder and insert the microphone (2).

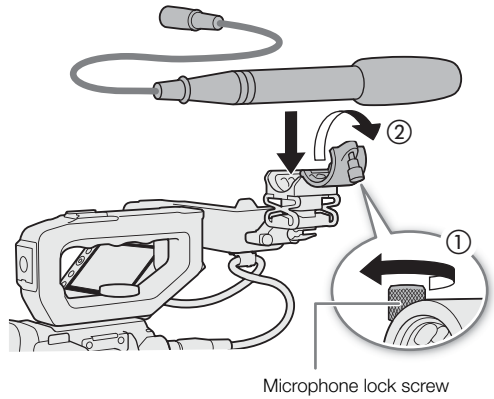

- 2 Tighten the lock screw and put the microphone cable through the cable clamp under the microphone holder (3).

- 3 Plug the microphone cable into the desired INPUT terminal (4) or the MIC terminal (5).

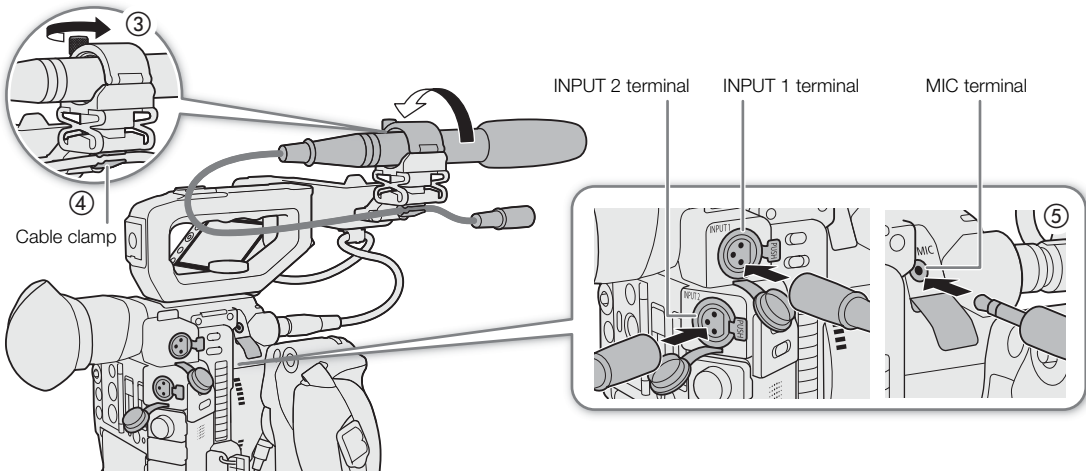

## Setting the Audio Input Type for the INPUT 1/INPUT 2 Terminals

Using the INPUT 1/INPUT 2 terminals, you can record audio independently from a microphone or audio input source.

On the camera, set the audio-related switches for the INPUT terminal you wish to use according to the type of audio input you wish to use.

1 Set the audio input selection switch for the desired INPUT terminal to AES/EBU (digital audio) or ANALOG (analog audio).

- When the switch is set to AES/EBU, the audio recording level for that input cannot be adjusted.

2 If you selected analog audio, set the INPUT terminal's ANALOG (analog source selection) switch to MIC (microphone) or LINE (audio device).

- To supply a microphone with phantom power, set the switch to MIC+48V instead. Make sure to connect the microphone first, before turning the phantom power on. Keep the microphone connected when turning off the phantom power.
- When using the INPUT terminals to record to only one channel, use the INPUT 1 terminal.

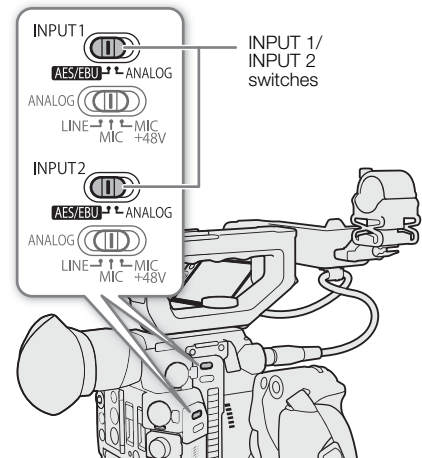

### ! IMPORTANT

- When connecting an analog microphone or device that does not support phantom power, make sure to set the corresponding INPUT switch to MIC or LINE, respectively. If you set the switch to MIC+48V, the microphone or device may be damaged.

## Selecting the Audio Format for Clips

When shooting RAW (primary) or MP4 (primary or proxy) clips, you can select the audio format.

Operating modes: CAMERA MEDIA | RAW MP4 XF-AVC

1 Open the [Audio Format (RAW)] or [Audio Format (MP4)] submenu.

**MENU** ➤ [ ] 2 Recording/Media Setup ➤ [Audio Format (RAW)] or [Audio Format (MP4)]

2 Select the desired option and then press the joystick.

### Options for RAW clips

[LPCM 16 bit 4CH]: The clip is recorded using 4-channel linear PCM with an audio sampling bit depth of 16 bit.

[LPCM 24 bit 4CH]: The clip is recorded using 4-channel linear PCM with an audio sampling bit depth of 24 bit.

### Options for MP4 clips

[AAC 16 bit 2CH]: The clip is recorded using 2-channel MPEG-2 AAC-LC with an audio sampling bit depth of 16 bit. This format is more versatile and allows the clip to be played back on various devices.

[LPCM 16 bit 4CH]: The clip is recorded using 4-channel linear PCM with an audio sampling bit depth of 16 bit. This format is uncompressed and has higher quality.

**i** NOTES

- When shooting XF-AVC (primary or proxy) clips, the audio format is 4-channel linear PCM with an audio sampling bit depth of 24 bit.

## Selecting the Audio Input Source for Audio Channels

You can select the audio input source that will be recorded on CH1/CH2 or CH3/CH4, independently for each pair of audio channels. For details refer to the *Audio Settings and Recorded Audio Channels* table (📖 96).

Operating modes: CAMERA | MEDIA | RAW | MP4 | XF-AVC

1 Select the desired pair of audio channels.

**MENU** ➤ [J]) 1 Audio Setup ➤ [Select CH1/CH2 Input] or [Select CH3/CH4 Input]

2 Select [INPUT Terminals] (external microphone or audio device), [MIC Terminal] (external microphone) or [Monaural Mic] (built-in microphone) and then press the joystick.

- If necessary, repeat steps 1 and 2 to select the audio input source for the other pair of audio channels.
- For information on the monaural microphone, see *About the monaural microphone* (📖 103).

## Recording a Single Analog Audio Input to Two Audio Channels

By default, when using analog audio sources (line in or microphone) connected to the INPUT terminals, each audio input is recorded to a separate audio channel (INPUT 1 to CH1 and INPUT 2 to CH2).

If necessary (for example, as an audio backup recording), you can record the same analog audio source connected to the INPUT 1 terminal to both audio channels, CH1 and CH2. In that case, you can adjust the audio recording levels of each channel independently of each other.

1 Open the [CH2 Input] submenu.

**MENU** ➤ [J]) 1 Audio Setup ➤ [CH2 Input]

2 Select the desired option and then press the joystick.

### Options

[INPUT 2]: Records audio to each channel separately. Audio input into INPUT 1 is recorded to CH1, while audio input into INPUT 2 is recorded to CH2.

[INPUT 1]: Audio input into INPUT 1 is recorded to both channels. Audio input into INPUT 2 will not be recorded.



## Adjusting the Audio Recording Level

When a channel is set to an analog audio input, you can select the automatic audio recording level adjustment or adjust the audio level manually, independently for each channel. When a channel is set to a digital audio source or the built-in monaural microphone, the audio recording level cannot be adjusted.

Operating modes: CAMERA MEDIA | RAW MP4 XF-AVC

### Automatic Audio Level Adjustment for CH1 or CH2

Set the audio level switch of the desired channel to A (automatic) to let the camera automatically adjust that channel's audio level.

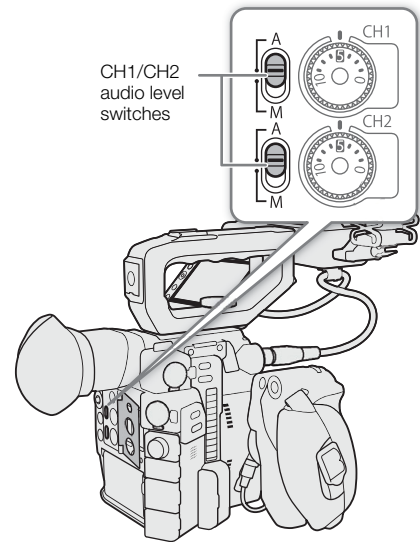

### Manual Audio Level Adjustment for CH1 or CH2

You can set the audio level for each channel manually from  $-\infty$  to +18 dB.

- 1 Set the audio level switch of the desired channel to M (manual).
- 2 Turn the corresponding audio level dial to adjust the audio level.
  - For reference, the 0 corresponds to  $-\infty$ , 5 corresponds to 0 dB, and 10 corresponds to +18 dB.
  - As a guideline, adjust the audio recording level so that the audio level meter on the screen will go to the right of the -18 dB mark (one mark right of the -20 dB mark) only occasionally.
  - Closing the protective cover will prevent the audio controls from being changed inadvertently.

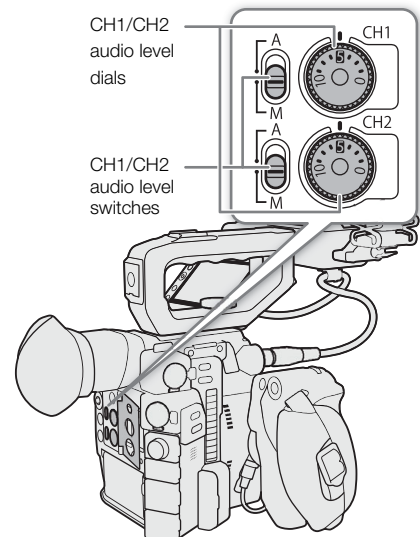

### Audio Level Adjustment for CH3 or CH4

To adjust audio levels for CH3 and CH4, set the recording format to RAW or XF-AVC, or set it to MP4 and then set **MENU** ➤ [🔧] 2 [Recording/Media Setup] ➤ [Audio Format (MP4)] to [LPCM 16 bit 4CH] in advance.

1 Open the [Audio Rec Level CH3], [Audio Rec Level CH4] or [Audio Rec Level CH3/CH4] submenu.

**MENU** ➤ [🔊] 2 [Audio Setup] ➤ [Audio Rec Level CH3], [Audio Rec Level CH4] or [Audio Rec Level CH3/CH4]

2 Select [Automatic] or [Manual] and then press the joystick.

- If you selected [Automatic], the rest of the procedure is not necessary. If you selected [Manual], continue the procedure to set the audio recording level.

3 Open the [CH3 Level], [CH4 Level] or [CH3/CH4 Level] submenu.

**MENU** ➤ [🔊] 2 [Audio Setup] ➤ [CH3 Level], [CH4 Level] or [CH3/CH4 Level]

4 Push the joystick up/down to set the audio recording level and then press the joystick.

- For reference, 0 corresponds to  $-\infty$ , 50 corresponds to 0 dB, and 100 corresponds to +18 dB.
- As a guideline, adjust the audio recording level so that the audio level meter on the screen will go to the right of the -18 dB mark (one mark right of the -20 dB mark) only occasionally.

#### Linking the audio level adjustment of CH1/CH2 or CH3/CH4

- When both CH1 and CH2, or CH3 and CH4, are set to the INPUT terminals or MIC terminal and to the same type of analog audio source (external line input or external microphone), you can use the **MENU** ➤ [🔊] 1 [Audio Setup] ➤ [CH1/CH2 ALC Link] or [CH3/CH4 ALC Link] setting to link the audio level adjustment of both channels.
- When CH1 and CH2 are linked, you can use the CH1 audio level switch and audio level dial to affect both CH1 and CH2. When CH3 and CH4 are linked, you can use the [Audio Rec Level CH3/CH4] and [CH3/CH4 Level] settings to affect both CH3 and CH4.

#### NOTES

- If at least one of the channels is set to the INPUT terminals, an analog audio source and manual audio level adjustment, you can activate the audio limiter to prevent audio distortions. When activated, the audio limiter will limit the amplitude of audio input signals when they start to distort. Use the **MENU** ➤ [🔊] 3 [Audio Setup] ➤ [INPUT 1&2 Limiter] setting.
- We recommend using headphones when adjusting the audio level. If the input level is too high, audio may become distorted even if the audio level indicator shows an appropriate level.
- If you set an assignable button to [Audio Level Indicator] (📖 125), you can press the button to turn the onscreen audio level indicator on and off.
- The audio recording level of the monaural microphone is set to automatic and cannot be changed.

## Advanced Audio Input Settings

Operating modes: CAMERA | MEDIA | RAW | MP4 | XF-AVC

### Adjusting the Microphone's Sensitivity (INPUT Terminals)

When the ANALOG switch for INPUT 1 or INPUT 2 is set to MIC or MIC+48V and the INPUT switch of the terminal is set to ANALOG, you can select the external microphone's sensitivity.

1 Open the desired INPUT terminal's sensitivity submenu.

**MENU** ➤ [🔊] 3 [Audio Setup] ➤ [INPUT 1 Mic Trimming] or [INPUT 2 Mic Trimming]

2 Select the desired level and then press the joystick.

- You can select one of 5 sensitivity levels from  $-12$  dB to  $+12$  dB.

### Activating the Microphone's Attenuator (INPUT Terminals)

When the INPUT 1 or INPUT 2 switch is set to MIC or MIC+48V and the INPUT switch of the terminal is set to ANALOG, you can activate the external microphone's attenuator (20 dB).

1 Open the desired INPUT terminal's microphone attenuator submenu.

**MENU** ➤ [**J**] [3] Audio Setup] ➤ [INPUT 1 Mic Att.] or [INPUT 2 Mic Att.]

2 Select [On] and then press the joystick.

### Activating the Microphone's Attenuator (MIC Terminal)

If the audio level is too high and the sound sounds distorted, activate the microphone attenuator (20 dB). To do so, make sure **MENU** ➤ [**J**] [1] Audio Setup] ➤ [Select CH1/CH2 Input] or [Select CH3/CH4 Input] is set to [MIC Terminal].

1 Open the [MIC Att.] submenu.

**MENU** ➤ [**J**] [3] Audio Setup] ➤ [MIC Att.]

2 Select [On] and then press the joystick.

### Activating the Low-Cut Filter (MIC Terminal)

You can activate the low-cut filter, for example to reduce the sound of wind in the background when recording outdoors. To do so, make sure **MENU** ➤ [**J**] [1] Audio Setup] ➤ [Select CH1/CH2 Input] or [Select CH3/CH4 Input] is set to [MIC Terminal].

1 Open the [MIC Low Cut] submenu.

**MENU** ➤ [**J**] [3] Audio Setup] ➤ [MIC Low Cut]

2 Select [On] and then press joystick.

- When you activate the low-cut filter, some low-frequency sounds may be suppressed along with the sound of wind.

#### About the monaural microphone

The monaural microphone allows you to add comments while shooting, which can be synchronized to the audio and video during editing. The audio recording level of the monaural microphone is adjusted automatically and cannot be changed. To use the monaural microphone, set **MENU** ➤ [**J**] [1] Audio Setup] ➤ [Select CH1/CH2 Input] or [Select CH3/CH4 Input] to [Monaural Mic].

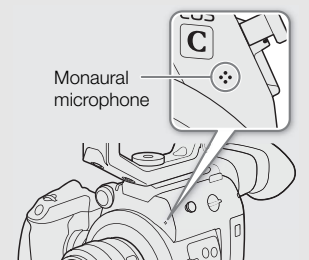





## Monitoring the Audio with Headphones

Connect headphones with a Ø 3.5 mm stereo mini-plug to the  (headphone) terminal to monitor the recorded audio.

 (headphone) terminal

### NOTES

- You can adjust the headphone volume with the **MENU**  [J])  Audio Setup]<sup>1</sup>  [Headphone Volume] setting. If you set an assignable button to [Headphones +] or [Headphones -] ( 125), you can press the button to adjust the headphone volume without using the menu.

<sup>1</sup> For  mode, page .

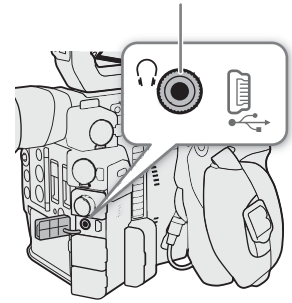

## Colors Bars/Audio Reference Signal

You can have the camera generate color bars and a 1 kHz audio reference signal and output them from the VIDEO terminal, viewfinder<sup>1</sup>, SDI terminal, HDMI OUT terminal and  (headphone) terminal<sup>2</sup>.

<sup>1</sup> C200 only.

<sup>2</sup> Audio reference signal only.

Operating modes: CAMERA | MEDIA | RAW | MP4 | XF-AVC

### Color Bars

The camera offers 3 types of color bars.

1 Open the [Color Bars] submenu to activate the color bars.

**MENU** ➤ [ 6] Camera Setup ➤ [Color Bars]

2 Select [On] and then press the joystick.

- The selected color bars appear on the screen.
- Turning off the camera or changing the operating mode to MEDIA mode will deactivate the color bars.

3 Open the [Color Bar Type] submenu.

**MENU** ➤ [ 6] Camera Setup ➤ [Color Bar Type]

4 Select the type of color bars and then press the joystick.

### NOTES

- If you set an assignable button to [Color Bars] ( 125), you can press the button to turn the color bars on/off.
- You cannot change the type of color bars while recording or while pre-recording mode is activated.
- While color bars are displayed, peaking, magnification and waveform monitor are not available.

### Audio Reference Signal

The camera can output a 1 kHz audio reference signal with the color bars.

1 Open the [1 kHz Tone] submenu.

**MENU** ➤ [ 4] Audio Setup ➤ [1 kHz Tone]

2 Select the desired level and then press the joystick.

- Available levels are -12 dB, -18 dB and -20 dB.
- Select [Off] to turn off the signal.
- The signal is output at the selected level.

## Waveform Monitor

The camera can display a simplified waveform monitor. You can select one of 6 types of monitors and also adjust the waveform amplification.

Operating modes: CAMERA MEDIA | RAW MP4 XF-AVC

### Displaying the Waveform Monitor

Press the WFM button.

- The waveform monitor window will appear on the right of the screen.
- Alternatively, you can display the video scopes using the **MENU** ➤ [  5 Assistance Functions]\* ➤ [WFM: VF+VIDEO Output] (C200B [WFM: VIDEO Output]) or [WFM: SDI Output] setting.

\* In MEDIA mode, [  1 Assistance Functions].

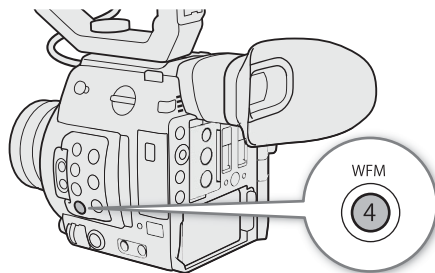

### Configuring the Waveform Monitor

1 Open the [WFM Type] submenu.

**MENU** ➤ [  5 Assistance Functions]\* ➤ [WFM Type]

2 Select the desired option and then press the joystick.

- If you selected [Select Line], continue the procedure to set the Y coordinate of the line you wish to display. Otherwise, skip to step 6 to change the gain.

3 To select the line's Y coordinate, open the [WFM Select Line] submenu.

**MENU** ➤ [  5 Assistance Functions]\* ➤ [WFM Select Line]

4 Push the joystick up/down to select the first digit of the Y coordinate and then press the joystick to move to the next.

- Change the rest of the digits in the same way to select the Y coordinate of the desired line.
- When the number of horizontal lines (vertical component) of the resolution used is 1080, you can select a value between 0 and 1079 (1-line increments); when the vertical resolution is 2160, you can select a value between 0 and 2158 (2-line increments).

5 Select [Set] and then press the joystick.

6 Open the [WFM Gain] submenu.

**MENU** ➤ [  5 Assistance Functions]\* ➤ [WFM Gain]

7 Select the desired amplification ratio and then press the joystick.

- If you selected [1x], the rest of the procedure is not necessary. If you selected [2x], the display range of the waveform monitor's Y axis will be reduced by half. Continue the procedure to select the minimum luminance value (in %) shown on the Y axis.

\* In MEDIA mode, [  1 Assistance Functions].

8 Open the [WFM Y Position] submenu.

**MENU** ➤ [F5] Assistance Functions\* ➤ [WFM Y Position]

9 Select the desired percentage and then press the joystick.

\* In [MEDIA] mode, [F1] Assistance Functions].

### Options

[Line]: Sets the waveform monitor to line display mode.

[Line+Spot]: The waveform of the area in the red frame is displayed in red on top of the [Line] mode waveform.

[Select Line]: The selected horizontal line will be displayed along with its waveform.

[Field]: Sets the waveform monitor to field display mode.

[RGB]: Functions like an RGB parade scope.

[YPbPr]: Functions like a YPbPr parade scope.

### NOTES

- You can select whether to display the waveform monitor on the camera viewfinder (**C200** only) and from the VIDEO terminal, or from the SDI terminal with the **MENU** ➤ [F5] Assistance Functions] ➤ [WFM: VF+VIDEO Output] (**C200B** [WFM: VIDEO Output] or [WFM: SDI Output] settings).
- The waveform monitor will not be affected even if a LUT is applied to the clip's video.
- The waveform monitor cannot be displayed while magnification is activated.
- If the [Knee] settings in the custom picture file (📖 134) were changed, a horizontal line will appear on the waveform monitor indicating the luminance (Y) level corresponding to the knee point.

### About the waveform monitor display:

- To display Canon Log 3 or Canon Log, set **MENU** ➤ [CP<sub>HDR</sub> 1] Custom Picture/HDR] ➤ [HDR/LUT] to [HDR: Off], the other settings in the same screen to an option other than [LUT: Off], and then one of the following:
  - **MENU** ➤ [CP<sub>HDR</sub> 1] Custom Picture/HDR] ➤ [Preset] to [Canon Log 3] or [Canon Log].
  - **MENU** ➤ [CP<sub>HDR</sub> 1] Custom Picture/HDR] ➤ [Gamma] to [Canon Log 3] or [Canon Log].
- To display HDR (HLG) or HDR (PQ), set **MENU** ➤ [CP<sub>HDR</sub> 1] Custom Picture/HDR] ➤ [HDR/LUT] to [HDR: HLG] or [HDR: PQ].

## Adding Marks to Recordings

While recording XF-AVC clips, you can flag an important shot by adding a “shot mark” (S). After recording, you can also add an OK mark (OK) or check mark (✓) to the entire clip to flag clips you want to set apart. You can also perform this function remotely using Browser Remote on a connected Wi-Fi device (170).

When the camera is in **MEDIA** mode, you can add or delete shot marks (147).

Operating modes: **CAMERA** | **MEDIA** | **RAW** | **MP4** | **XF-AVC**

### Adding a Shot Mark while Recording

To add a shot mark to a clip while recording, you must first set an assignable button to [Add Shot Mark].

1 Set an assignable button to [Add Shot Mark] (125).

2 While you are recording, press the assignable button at the beginning of the shot you wish to mark.

- A message indicating the shot mark will appear and the selected shot mark will be added to the current frame of the clip.

#### **i** NOTES

- Up to 100 shot marks can be added to a single clip.
- There may be up to a 0.5 second delay from when you press the button to when the camera adds the shot mark.
- When a clip contains a shot mark, **S** will appear next to the clip's thumbnail in the playback index screen.
- Shot marks cannot be added in the following cases:
  - During pre-recording mode before pressing the REC button to record.
  - During interval recording or frame recording mode.

### Adding an OK Mark or ✓ Mark after Recording

After recording an XF-AVC clip, you can add an OK mark (OK) or check mark (✓) to the clip to flag it and set it apart. Furthermore, you can use the OK mark to protect important clips, as clips with an OK mark cannot be deleted.

To add an OK mark or ✓ mark, you must first set in advance an assignable button to [Add OK Mark] or [Add ✓ Mark].

1 Set an assignable button to [Add OK Mark] or [Add ✓ Mark] (125).

- To add both types of clip marks (to different clips), set one assignable button to [Add OK Mark] and another assignable button to [Add ✓ Mark].

2 After recording, press the assignable button.

- A message indicating the clip mark will appear and the selected clip mark will be added to the clip just recorded.

#### **i** NOTES

- A clip cannot have both an OK mark and a ✓ mark at the same time.



## Using Metadata

The camera automatically adds metadata to XF-AVC clips while they are being recorded. You can use Canon XF Utility to check and search for specific metadata. You can also create and transfer a user memo remotely using Browser Remote on a connected Wi-Fi device (📖 170).

### Metadata components

Metadata	Entering content			Checking content
	Camera	Canon XF Utility	Browser Remote	Canon XF Utility
User Memo: clip title, creator, location and description.	–	● <sup>1</sup>	●	●
GPS information: altitude, latitude and longitude.	● <sup>2</sup>	● <sup>3</sup>	●	●
Information about the recording: scene and take.	●	–	–	●
Information about camera settings: shutter speed, ISO speed/gain value, etc.	– <sup>4</sup>	–	–	●
Unique Material Identifiers (UMID): country, organization and user codes based on the SMPTE standard.	● (📖 188)	–	–	–

<sup>1</sup> User memo files need to be created using the software and saved on an SD card in advance.

<sup>2</sup> Only when an optional GP-E2 GPS Receiver is attached to the camera. While recording, GPS information is recorded automatically by the camera (📖 111).

<sup>3</sup> GPS information can only be added to clips already recorded.

<sup>4</sup> Recording data is logged automatically by the camera.

Operating modes: CAMERA MEDIA | RAW MP4 XF-AVC

## Setting a User Memo Created with Canon XF Utility

Before you can add a user memo, you must first install Canon XF Utility (📖 159). Next, create the user memo and then save it to an SD card. Once you insert the SD card in the camera and select the user memo, it will be added to clips you record.

### 1 Use Canon XF Utility to save a user memo to an SD card.

- For details, refer to *Managing User Memo Profiles* in the Canon XF Utility Instruction Manual.

### 2 Insert the SD card into SD card slot B.

### 3 Open the metadata [Setting] submenu.

**MENU** ➤ [📷 4] Recording/Media Setup ➤ [Metadata] ➤ [Setting]

### 4 Select [SD Card] and then press the joystick.

### 5 Open the [User Memo] submenu.

**MENU** ➤ [📷 4] Recording/Media Setup ➤ [Metadata] ➤ [User Memo]

### 6 Select the file name of the desired user memo and then press the joystick.

- The **MEMO** icon appears on the left of the screen.
- Select [Off] to record clips without a user memo.

## NOTES

- After you set a user memo, do not remove the SD card while you are recording. If the SD card is removed, the user memo will not be added to the clip.
- You must set the user memo before you start recording for it to be added to the clip. You cannot change the user memo already added to a clip using the camera but you can do so with Canon XF Utility.
- When the optional GP-E2 GPS Receiver is attached to the camera and the GPS function is activated, the user memo information will not be recorded, even if you have selected a user memo file from the SD card.

## Entering Information About the Recording

You can enter scene and take information to help identify the recording later on.

1 Open the [Scene] or [Take] submenu.

**MENU** ➤ [📁 4] Recording/Media Setup ➤ [Metadata] ➤ [Scene] or [Take]

2 Select [Change] and then press the joystick.

- Enter the desired text using the keyboard screen (📖 35).
- To clear the scene/take information, select [Reset] instead.

3 Select [OK] and then press the joystick.

## Recording GPS Information (Geotagging)

When the optional GP-E2 GPS Receiver is connected to the camera's USB terminal, the camera will automatically record the GPS information (longitude, latitude and altitude) to clips and photos you record. Later, the GPS information can be used to organize and search clips using Canon XF Utility ( 159). In **MEDIA** mode, you can check if a clip contains GPS information on the [Clip Info] screen ( 145).

For details about attaching and configuring the receiver, refer to the GP-E2's instruction manual.

### Connecting the GPS Receiver

Turn off the camera and the receiver. Connect the receiver to the camera's USB terminal using the USB cable\*. While recording, place the receiver in the carrying case\* and attach it to the camera's grip belt or carry it on your person. For details about connecting and using the receiver, refer to the GP-E2 Instruction Manual.

\* Supplied with the optional GP-E2 GPS Receiver.

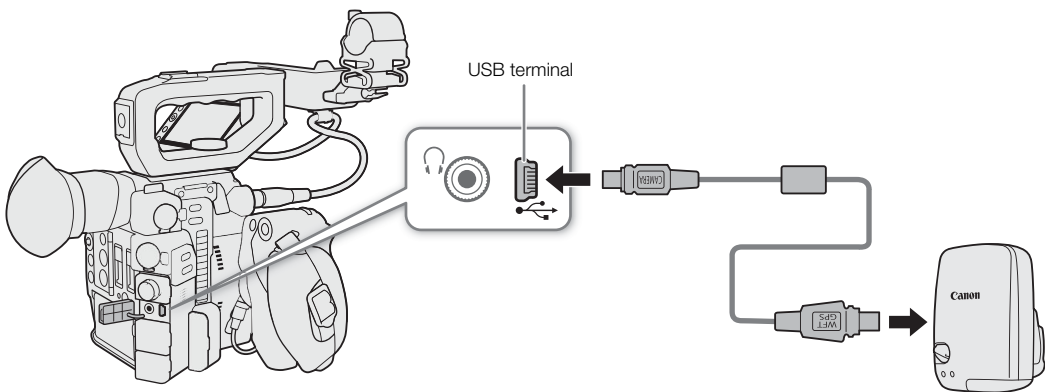

### Adjusting the Date/Time Automatically According to GPS Position

You can set **MENU** ➤ [ 5 System Setup] ➤ [GPS Auto Time] to [On], to have the camera automatically adjust its date and time settings according to the information received from the GPS signal. The date and time will be updated automatically the first time a correct GPS signal is acquired after turning on the camera.

- When **MENU** ➤ [ 5 System Setup] ➤ [GPS Auto Time] is set to [On], the **MENU** ➤ [ 1 System Setup] ➤ [Time Zone] and [Date/Time] submenus will not be available.

### ! IMPORTANT

- In certain countries/regions, the use of GPS may be restricted. Be sure to use the GPS receiver in accordance with local laws and regulations of the country/region where the receiver is used. Be particularly careful when traveling outside of your home country.
- Be careful about using the GPS receiver in places where the use of electronic devices is restricted.
- The recorded GPS information may contain data that can lead others to locate or identify you. Be careful when sharing geotagged recordings with others or when uploading them to the Web.
- Do not leave the GPS receiver near strong electromagnetic fields such as near powerful magnets and motors.

### i NOTES

- On the [GPS Information Display] status screen ( 206), you can check the current GPS information and satellite signal strength.
- You can use the [ 6 Monitoring Setup] ➤ [Displayed Units] setting to change the units shown on the screen between meters and feet.
- GPS signal reception may take some time after replacing the battery pack or when first turning on the camera.
- Do not place the unit cable or cable connected to the SDI or HDMI OUT terminal near a GPS receiver as doing so may interfere with the GPS information.
- The GPS information recorded with clips corresponds to the location at the start of the recording.

## Reviewing a Recording

If you set an assignable button to [Review Recording] in advance, you can review all or part of the last clip recorded even with the camera set to **CAMERA** mode.

Operating modes: **CAMERA** | **MEDIA** | **RAW** | **MP4** | **XF-AVC**

1 Set an assignable button to [Review Recording] in advance (📖 125).

2 Open the [Review Recording] submenu to set the review length.

**MENU** ➤ [🔑 5] System Setup ➤ [Review Recording]

3 Select the desired option and then press the joystick.

4 After you finish recording a clip, press the assignable button.

- The last clip that was recorded is played back for the selected duration. [▶ REVIEW] appears at the top of the screen.
- You can push the joystick left/right during the playback to skip 10 seconds backward or forward, respectively. When there are less than 10 seconds from the start of the clip, pushing the joystick left will start playing back the clip from the beginning. When there are less than 4 seconds from the end of the clip, pushing the joystick right will have no effect.
- Audio will be output from the 🎧 (headphone) terminal, HDMI OUT terminal and SDI terminal.
- Press the assignable button again or the CANCEL button to stop reviewing the clip and return the camera to record standby mode.
- After the clip finishes playing back, the camera returns to record standby mode.

### Options

[Entire Clip]: Allows you to review the entire clip.

[Last 4 sec]: Allows you to review just the last 4 seconds of the clip.

### 📘 NOTES

- If the camera switched SD cards during a recording, the camera will play back the clip on the SD card most recently recorded on.

## Simultaneous Recording of Proxy Clips

In addition to a primary clip recorded in RAW on a CFast card, you can simultaneously record the same scene as a proxy clip (in MP4 or XF-AVC format) on an SD card. Because proxy clips are relatively smaller files, they are suitable for offline editing.

Operating modes: CAMERA MEDIA | RAW MP4 XF-AVC

- 1 Set the main recording format to RAW (📖 64).
- 2 Open the proxy recording [Sub Rec Format] submenu.  
**MENU** ➤ [📷 1 Recording/Media Setup] ➤ [Sub Rec Format]
- 3 If necessary, select the audio format (📖 99).
- 4 Select [MP4 (SD Card)] or [XF-AVC (SD Card)] and then press the joystick.
- 5 Press the REC button to start and stop recording.
  - A proxy clip will be recorded on the SD card at the same time the primary clip is recorded on the CFast card.

### Video and audio configuration of proxy clips

The recorded proxy clip has the following video configuration. The frame rate is the same as that used for the primary clip. The audio configuration depends on the proxy clip's audio recording format (📖 99)

**Resolution and color sampling:** 2K (2048x1080), YCbCr 4:2:0, 8 bit

**Bit rate:** 35 Mbps (for MP4 proxy clips) or 45 Mbps (for XF-AVC proxy clips)

### ! IMPORTANT

- Observe the following precautions while an access indicator is illuminated in red. Failure to do so may result in permanent data loss.
  - Do not open the card slot cover of the card being accessed and do not remove the card.
  - Do not disconnect the power source or turn off the camera.

### i NOTES

- If the recording of the primary clip stops during simultaneous recording, recording of the proxy clip will stop as well.
- When an SDHC card is used to record proxy clips, the video (stream) file in a proxy clip will be split approximately every 4 GB for clips with long recording times. Still, playback on the camera will be continuous.
- During HDR output (📖 155), the BT.709 LUT (📖 156) will be applied automatically to the proxy clip. The dynamic range will be 800% maximum when [HDR/LUT] is set to [HDR: PQ]; it will be 425% maximum when [HDR/LUT] is set to [HDR: HLG].
- If proxy clip recording is activated but no CFast card is inserted in the camera, the proxy clip will not be recorded.

## Special Recording Modes

The camera features the following special recording modes.

**Slow motion recording:** This mode allows you to change the shooting frame rate to achieve a slow motion effect during playback.

**Pre-recording:** The camera will start recording a few seconds before you press the REC button. This is especially useful when it is difficult to predict when to start recording.

**Frame recording:** The camera will record one frame every time you press the REC button. This mode is suitable for recording stop motion animation.

**Interval recording:** The camera will automatically record one frame at a pre-defined interval. This mode is suitable for recording subjects with little movement, such as natural surroundings or plants.

**Continuous recording:** The camera will keep recording continuously on SD card B until you stop it so you do not miss any shooting opportunities. This mode is available only for MP4 clips.

### Slow Motion Recording Mode

The camera can record using a progressive frame rate (shooting frame rate) that is different from the playback frame rate. Recording a clip at a higher frame rate than the [Frame Rate] setting will result in a slow motion effect during playback (up to 1/5 of the original speed). The maximum recording length of a clip depends on the frame rate but the playback time cannot exceed approximately 6 hours.

Sound is not recorded when slow motion recording is activated.

Operating modes: CAMERA | MEDIA | RAW | MP4 | XF-AVC

#### Available shooting frame rates and maximum recording time

Video configuration			Shooting frame rate*	Approx. maximum recording time for a single clip
Frame rate	Resolution	Color sampling		
59.94P	1920x1080	YCbCr 4:2:0, 8 bit	119.88P	3 hr.
29.97P				1 hr. 30 min.
23.98P				1 hr. 12 min.
24.00P			120P	1 hr. 12 min.
50.00P			100P	3 hr.
25.00P				1 hr. 30 min.

\* When the frame rate is 119.88P, it will appear on the screen as 120.

1 Open the [Recording Mode] submenu.

[] [1] Recording/Media Setup] ➤ [Recording Mode]

2 Select [Slow Motion Recording] and then press the joystick.

- [SLOW STBY] appears at the top of the screen. Also, the shooting frame rate appears at the top of the screen next to the frame rate setting (the playback frame rate).

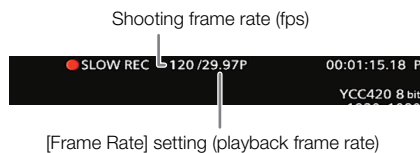

- 3 Press the REC button to begin recording.
  - The tally lamp illuminates.
  - [SLOW STBY] changes to [● SLOW REC] while recording.
- 4 Press the REC button again to stop recording.
  - The clip is recorded at the selected frame rate.
  - The tally lamp goes out and [SLOW STBY] appears at the top of the screen.
- 5 When you have finished recording, turn off the special recording mode.
  - Repeat steps 1 and 2 selecting [Normal Recording] instead.

### NOTES

- You can use only one special recording mode at a time.
- The shooting frame rate cannot be changed while recording.
- The time code signal will not be output from the SDI or HDMI OUT terminal.
- If you change the main recording format or system frequency, slow motion recording mode will be canceled and the shooting frame rate will be reset to its default value.
- **About the time code during slow motion recording mode:**
  - The time code mode can be set to [Regen.], or to [Preset] with [Rec Run] running mode.
  - If the time code running mode was set to [Free Run], the time code running mode will be changed automatically to [Rec Run] when slow motion recording is activated.
  - When the special recording mode is deactivated, the time code running mode will return to its previous setting.

## Pre-recording Mode

When pre-recording mode is activated, the camera starts recording continuously into a temporary memory (approx. 3 seconds) so when you press the REC button, the clip will contain also a few seconds of video and audio recorded before you pressed the button.

Operating modes: CAMERA MEDIA | RAW MP4 XF-AVC

- 1 Open the [Recording Mode] submenu.
 

**MENU** ➤ [  1 Recording/Media Setup ] ➤ [Recording Mode]
- 2 Select [Pre-Recording] and then press the joystick.
  - [PRE REC STBY] appears at the top of the screen.
- 3 Press the REC button to begin recording.
  - The tally lamp illuminates.
  - [PRE REC STBY] changes to [● PRE REC] while recording.
- 4 Press the REC button again to stop recording.
  - The camera records the clip, including a few seconds of video and audio recorded before the REC button was pressed.
  - The tally lamp goes out and [PRE REC STBY] appears at the top of the screen.
- 5 When you have finished recording, turn off the special recording mode.
  - Repeat steps 1 and 2 selecting [Normal Recording] instead.

### NOTES

- You can use only one special recording mode at a time.
- While pre-recording mode is activated, the audio format for MP4 clips cannot be changed.
- If you change the main recording format or system frequency, pre-recording mode will be canceled.

- **About the time code during pre-recording mode:**

- The time code of the clip will start a few seconds before the REC button was pressed.
- The time code will be recorded with the running mode set to [Free Run].
- If the time code mode was set to [Regen.], or to [Preset] with [Rec Run] running mode, the time code running mode will be changed automatically to [Free Run] when pre-recording is activated.
- When the special recording mode is deactivated, the time code running mode will return to its previous setting.

## Frame Recording Mode

We recommend operating the camera remotely or stabilizing the camera, for example, on a tripod. Sound is not recorded in this mode.

Operating modes: CAMERA MEDIA | RAW MP4 XF-AVC

### Activating and Configuring

1 Open the [Recording Mode] submenu.

**MENU** ➤ [  ] [  ] Recording/Media Setup] ➤ [Recording Mode]

2 Select [Frame Recording] and then press the joystick.

- [FRM STBY] appears at the top of the screen (with [FRM] flashing).

### Recording

1 Press the REC button to begin recording.

- The camera automatically records one frame.
- The tally lamp illuminates.
- [FRM STBY] changes to [● FRM REC] while recording frames and [● FRM STBY] when frames are not being recorded.
- Repeat until you finish recording.

2 When you have finished recording, turn off the special recording mode.

- Repeat steps 1 and 2 of the previous procedure selecting [Normal Recording] instead.
- Frame recording mode ends and all of the recorded frames are joined together into one clip.
- The tally lamp goes out and [STBY] appears at the top of the screen.

### NOTES

- You can use only one special recording mode at a time.
- Some frames at the point the recording was stopped may be recorded and added to the end of the clip.
- If you change the main recording format or system frequency, frame recording mode will be canceled.
- **About the time code during frame recording mode:**
  - The time code mode can be set to [Regen.], or to [Preset] with [Rec Run] running mode.
  - If the time code running mode was set to [Free Run], the time code running mode will be changed automatically to [Rec Run] when interval recording is activated.
  - When the special recording mode is deactivated, the time code running mode will return to its previous setting.
  - The time code signal will not be output from the SDI terminal or HDMI OUT terminal.









## Interval Recording Mode

Set the interval in advance. At each interval, the camera will record one frame. Sound is not recorded in this mode.

Operating modes: CAMERA MEDIA | RAW MP4 XF-AVC

### Activating and Configuring

- 1 Open the [Recording Mode] submenu.
  - MENU**  [  1 Recording/Media Setup ]  [Recording Mode]
- 2 Select [Interval Recording] and then press the joystick.
  - [INT STBY] appears at the top of the screen (with [INT] flashing).
- 3 Open the [Recording Interval] submenu.
  - MENU**  [  1 Recording/Media Setup ]  [Recording Interval]
- 4 Select the desired interval and then press the joystick.
  - You can select one of 7 interval settings from 1 second to 10 minutes.

### Recording

- 1 Press the REC button to begin recording.
  - The camera automatically records one frame at the specified interval.
  - The tally lamp illuminates.
  - [INT STBY] changes to [● INT REC] while recording frames, and [● INT] and a countdown until the next recording between recordings.
- 2 Press the REC button again to stop recording.
  - All of the recorded frames are joined together into one clip.
  - The tally lamp goes out and [INT STBY] appears at the top of the screen (with [INT] flashing).
- 3 When you have finished recording, turn off the special recording mode.
  - Repeat steps 1 and 2 of the previous procedure selecting [Normal Recording] instead.

### NOTES

- You can use only one special recording mode at a time.
- The interval cannot be changed while recording.
- Some frames at the point the recording was stopped may be recorded and added to the end of the clip.
- If you change the main recording format or system frequency, interval recording mode will be canceled.
- **About the time code during interval recording mode:**
  - The time code mode can be set to [Regen.], or to [Preset] with [Rec Run] running mode.
  - If the time code running mode was set to [Free Run], the time code running mode will be changed automatically to [Rec Run] when interval recording is activated.
  - When the special recording mode is deactivated, the time code running mode will return to its previous setting.
  - The time code signal will not be output from the SDI terminal or HDMI OUT terminal.

## Continuous Recording

Once the continuous recording starts, the camcorder will keep recording continuously until you access the menu to stop it. This will create a backup recording to make sure you do not miss any shooting opportunities. In this mode, video and audio are recorded on both cards.

Use the menu to start/stop the continuous recording. While the continuous clip is being recorded on SD card B, you can use the camera's REC button to record 'normal' (non-continuous) clips as usual on SD card A. The configuration of the continuous recording on SD card B is as follows.

Resolution: 1920x1080

Video format: MP4

Audio format: 4-channel linear PCM, 16 bit

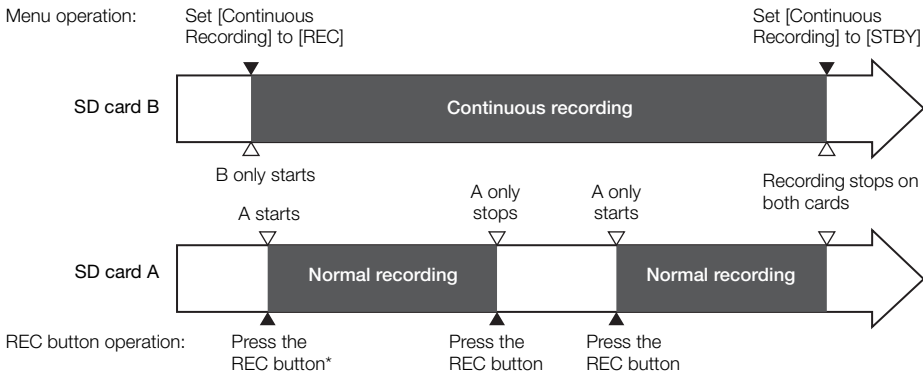

\* When continuous recording mode is activated and both cards are in recording standby, you can also press the REC button to start recording on both cards.

Operating modes: CAMERA | MEDIA | RAW | MP4 | XF-AVC

### Activating

1 Set the main recording format to [MP4 (SD Card)] (64).

2 Open the [Recording Mode] submenu.

**MENU** ➤ [ 1 Recording/Media Setup ] ➤ [Recording Mode]

3 Select [Continuous Recording] and then press the joystick.

- The continuous recording mode is activated and [CONT STBY ➤ B] appears at the top of the screen. The normal recording indicator changes to [STBY ➤ A].

### Recording

1 Open the [Continuous Recording] submenu.

**MENU** ➤ [ 1 Recording/Media Setup ] ➤ [Continuous Recording]

2 Select [REC] and then press the joystick.

- The tally lamp illuminates and continuous recording starts on SD card B. [CONT STBY ➤ B] changes to [●CONT REC ➤ B].

3 While recording continues on SD card B, you can use the REC button to record normal (non-continuous) recordings on SD card A.

- Press the REC button to start recording on SD card A. [STBY ➤ A] changes to [REC ➤ A]. Press the REC button again to stop recording only on SD card A.
- Alternatively, when both SD cards are in recording standby, you can press the REC button to begin recording on both cards.

4 To stop the continuous recording, open the [Continuous Recording] submenu.

**MENU** ➤ [  1] Recording/Media Setup] ➤ [Continuous Recording]

5 Select [STBY] and then press the joystick.

- The tally lamp goes out and recording stops on both SD cards. [●CONT REC➔ B] and [REC➔ A] change to [CONT STBY➔ B] and [STBY➔ A], respectively.

6 When you have finished recording, turn off the special recording mode.

**MENU** ➤ [  1] Recording/Media Setup] ➤ [Recording Mode] ➤ [Normal Recording]

- Selecting a different special recording mode will also deactivate the continuous recording mode.

### NOTES

- You can use only one special recording mode at a time.
- When continuous recording mode is activated, if recording on SD card B (continuous recording) is not available, normal recording on SD card A will not be possible either.
- When continuous recording mode is activated, recording on SD card B (continuous recording) will continue even in the following cases.
  - SD card A becomes full.
  - SD card A is removed from the camera.
- When continuous recording mode is activated, the **MENU** ➤ [  2] Recording/Media Setup] ➤ [Resolution/Color Sampling] and [Audio Format (MP4)] settings cannot be changed.
- If you change the main recording format or system frequency, continuous recording mode will be canceled.
- **About the time code during continuous recording mode:** When the time code mode is set to [Regen.], only the time codes on SD card B will be read out.

## Taking Photos

Photos are saved onto SD card B and their size depends on the video configuration currently in use.

Resolution currently in use	Photo size	Approximate file size per image
4096x2160	2048x1080	930 KB
3840x2160	3840x2160	3,080 KB
1920x1080	1920x1080	880 KB

Operating modes: CAMERA | MEDIA | RAW | MP4 | XF-AVC

1 Set an assignable button to [Photo] (📷 125).

2 When the camera is in record standby mode, press the assignable button to take a photo.

- **B** and the number of available photos appear on the upper right of the screen.
- The SD CARD **B** access indicator will illuminate in red as the photo is being recorded.

### ! IMPORTANT

- Observe the following precautions while the SD CARD **B** access indicator is illuminated in red. Failure to do so may result in permanent data loss.
  - Do not disconnect the power source or turn off the camera.
  - Do not remove the SD card.

### i NOTES

- Photos cannot be taken during pre-recording mode.
- You cannot take photos while using Browser Remote.
- If the LOCK switch on the SD card is set to prevent writing, you will not be able to record photos or grab frames. Change the position of the LOCK switch in advance.

## Photo Playback

You can view the photos that you took with the camera. Photos can be played back only from SD card B.

Operating modes: CAMERA MEDIA | RAW MP4 XF-AVC

121

### Displaying the [Photos] Index Screen

Display the [Photos] index screen to view photos.

- 1 Set the **POWER** switch to **MEDIA**.
  - The camera switches to MEDIA mode and the clip index screen appears.
- 2 Press the **INDEX** button.
  - The index screen selection menu appears.
- 3 Select **[Photo Index]** and then press the joystick.
  - The [Photos] index screen appears.

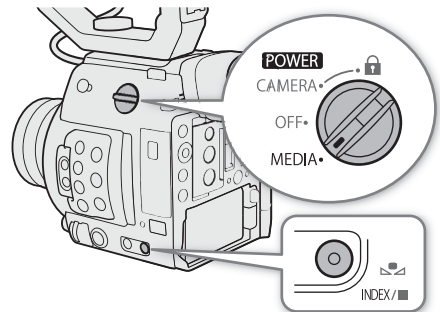

### Viewing Photos

- 1 Move the orange selection frame to the desired photo.
- 2 Press the **▶/||** button to view the photo.
  - The photo playback screen appears and the selected photo is displayed.
  - Push the joystick left/right to switch to the previous/next photo.
  - Press the **DISP** button to hide/show the onscreen displays.
  - Press the **■** button to return to the [Photos] index screen.

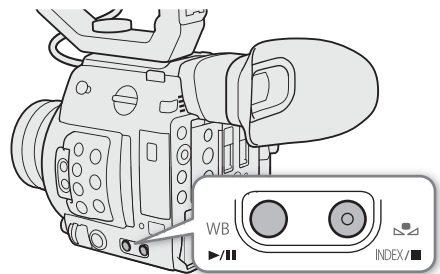

#### ! IMPORTANT

- Observe the following precautions while the SD card access indicator is illuminated in red. Failure to do so may result in permanent data loss.
  - Do not disconnect the power source or turn off the camera.
  - Do not remove the SD card.

#### i NOTES

- The following photos may not be displayed correctly.
  - Photos not recorded with this camera.
  - Image files that were created, edited or renamed using a computer.

## Deleting Photos

You can delete a photo you no longer need. Photos can be deleted one at a time from the photo playback screen.

Operating modes: CAMERA MEDIA | RAW MP4 XF-AVC

The basic operation of the photo menu is identical to that of the clip menu (📖 144).

- 1 Select the photo you wish to delete.
  - Display the desired photo (📖 121) or open the [Photos] index screen and move the orange selection frame to the desired photo.
- 2 Press the joystick to open the photo menu.
- 3 Select [Delete] and then press the joystick.
  - The screen prompts you to confirm the operation.
- 4 Select [OK] and then press the joystick.
  - Select [Cancel] instead to cancel the operation.
  - The selected photo is deleted.
- 5 When the confirmation message appears, press the joystick.

### ! IMPORTANT

- Be careful when deleting photos. Deleted photos cannot be recovered.

## Using the Optional RC-V100 Remote Controller

You can connect the optional RC-V100 Remote Controller to the camera's REMOTE terminal in order to control the camera (including advanced recording functions) from a distance. The remote controller lets you turn the camera on, navigate the menus and remotely control the aperture and shutter speed, change picture-related settings like the knee and sharpness, and more.

Use the cable supplied with the remote controller to connect it to the camera. For details on how to connect and use the remote controller, refer to its instruction manual.

Operating modes: CAMERA MEDIA | RAW MP4 XF-AVC

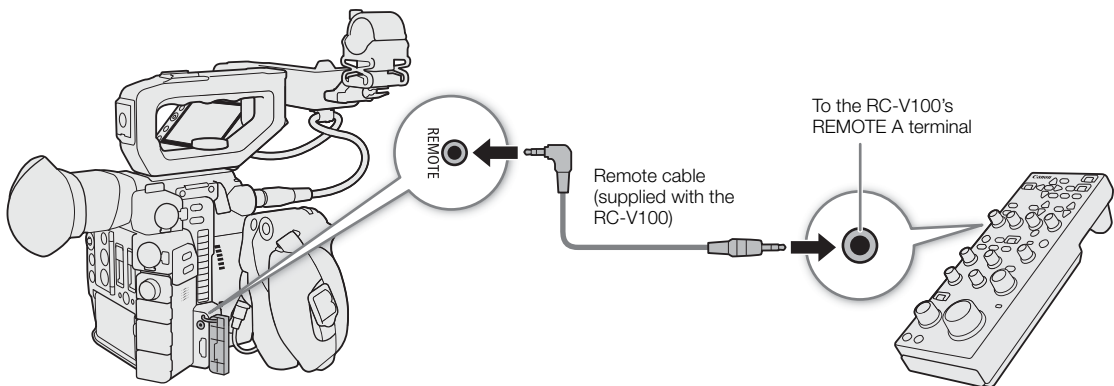

1 Turn off the camera and connect the optional RC-V100 Remote Controller to the camera.

2 Turn on the camera and open the [REMOTE Term.] submenu.

**MENU** ➤ [🔍 1 System Setup] ➤ [REMOTE Term.]

3 Select [RC-V100 (REMOTE A)] and then press SET.

### Options

[RC-V100 (REMOTE A)]: Select this option to use the optional RC-V100 Remote Controller.

[Standard]: Select this option to use commercially available remote controls.

### **i** NOTES

- The AGC button, AUTO KNEE button and AF button on the remote controller will not operate the camera.
- The AUTO IRIS button on the remote controller will operate the camera only when a compatible EF lens (📖 230) is attached to the camera.
- The ZOOM dial on the remote controller can operate the lens only when a compatible EF Cinema lens (📖 230) is attached to the camera.
- Adjusting picture-related settings with the remote controller can be performed only when the detailed settings were activated (**MENU** ➤ [🔍 HDR 1 Custom Picture/HDR] ➤ [Activate Other Settings] is set to [On], 📖 129).





## Assignable Buttons

The camera offers a number of buttons to which you can assign various functions (assignable buttons). Assign often-used functions to the buttons you find most convenient, to personalize the camera to your needs and preferences.

You can use 11 assignable buttons on the camera's body, two assignable buttons on the LM-V1 LCD Monitor<sup>1</sup>, and one assignable button on the GR-V1 Camera Grip<sup>1</sup>. In addition, the RC-V100 Remote Controller and EVF-V70 Electronic Viewfinder offer four assignable buttons each and the LM-V2 offers two assignable buttons that can be used when these optional accessories are attached to the camera. In most cases, the names of the buttons printed on the camera and modular units also indicate their default settings.

<sup>1</sup> Supplied accessory for the C200; optional accessory for the C200B.

Operating modes: CAMERA MEDIA | RAW MP4 XF-AVC

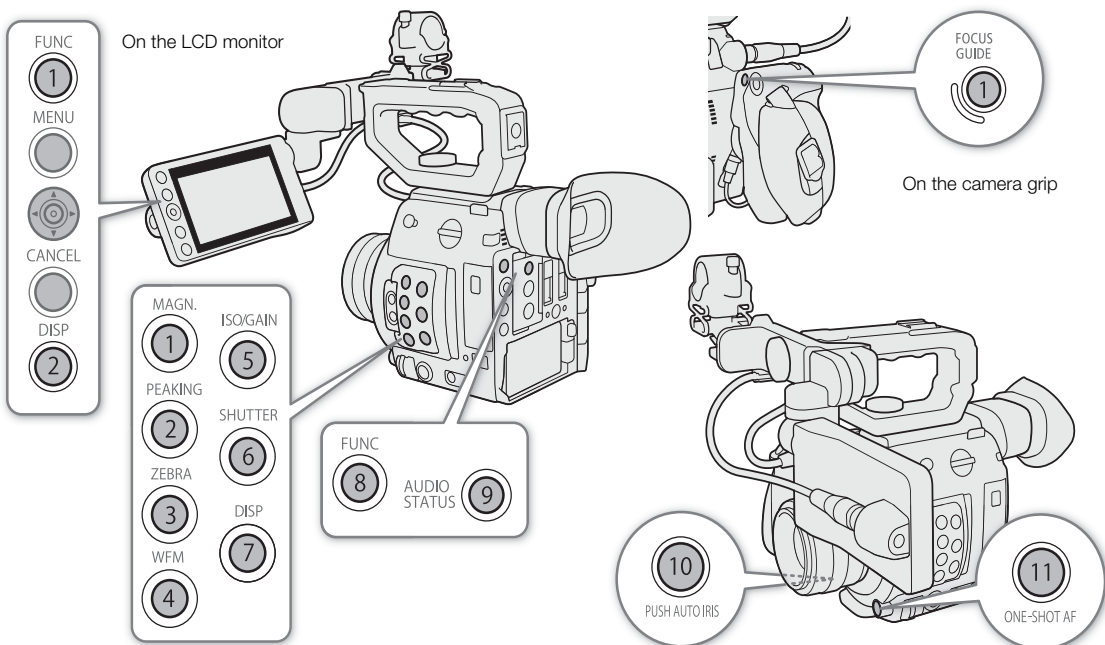

## Changing the Assigned Function

1 Press the MENU button and, while holding it pressed down, press the assignable button whose function you wish to change.

- A list of available functions appears with the current function assigned to the button highlighted.
- You can also open the submenu corresponding to the button whose function you wish to change under **MENU** ➤ [🔍 Assignable Buttons].

2 Select the desired function and then press the joystick.

- The selected function will be assigned to the selected button.
- If you selected one of the preset functions, the rest of the procedure is not necessary. If you selected [User Setting], continue the procedure to register a menu setting.

3 Navigate the menus to find the menu setting you want to register and then press the joystick.

- The selected menu setting will be assigned to the selected button. User-selected settings will be indicated with a **MENU** in the assignable buttons' submenu.

**i** NOTES

- In **CAMERA** mode, you can check the four [Assignable Buttons] status screens (📖 199) to see what functions are currently assigned to each button.
- You can reset only the functions assigned to the assignable buttons, without affecting other camera settings, with the **MENU** ➤ [🔧 1 System Setup] ➤ [Reset] ➤ [Assignable Buttons] function. All the assignable buttons will return to their default function.















### Using an Assignable Button

After you assign a function to one of the buttons, press the button to activate the function. For some functions, an options menu may appear. In such case, select the desired option and then press the joystick.





#### Assignable Functions

Functions can be set separately in **CAMERA** mode and **MEDIA** mode. Refer to the following table for assignable functions and available modes.

Function name	Description	CAMERA	MEDIA	📖
[One-Shot AF] <sup>1</sup>	The camera focuses automatically one time only (one-shot AF function).	●	–	84
[AF Lock]	Locks the focus during continuous AF.	●	–	86
[Face AF]	Toggles the [Face AF] setting between [Face Priority] and [Face Only].	●	–	87
[Face Detection]	Turns the face detection function on/off.	●	–	87
[Tracking]	Turns the tracking function on/off.	●	–	88
[Focus Guide]	Turns the Dual Pixel Focus Guide function on/off.	●	–	82
[Peaking: All]	Turns peaking on/off from the VIDEO terminal and viewfinder <sup>2</sup> .	●	–	83
[Peaking: VIDEO Output], [Peaking: VF Output] <sup>2</sup>	Turns peaking on/off on the respective screen/video output.	●	–	83
[Magn.: All]	Turns magnification on/off from the viewfinder <sup>2</sup> and terminals capable of magnification output.	●	–	83
<b>C200</b> [Magn.: VF+VIDEO Output], <b>C200B</b> [Magn.: VIDEO Output], [Magn.: SDI/HDMI Output]	Turns magnification on/off on the respective screen/video output.	●	–	83
[Tele-converter]	Turns the digital tele-converter on/off. The digital tele-converter will activate at the level selected in the setup menu.	●	–	89
[Push Auto Iris]	The camera automatically adjusts the aperture only while the button is held pressed down.	●	–	74
[Iris Mode]	Switches the aperture adjustment mode between automatic and manual.	●	–	72
[Iris +]	Opens up the aperture.	●	–	73
[Iris -]	Closes the aperture.	●	–	
[ND +]	Cycles through ND filter settings in increasing (higher density) order.	●	–	71
[ND -]	Cycles through ND filter settings in decreasing (lower density) order.	●	–	

Function name	Description	CAMERA	MEDIA	
[AE Shift +]	Compensates the exposure making the image brighter.	●	–	75
[AE Shift –]	Compensates the exposure making the image darker.	●	–	
[Backlight]	Turns the [Backlight] light metering option on/off.	●	–	76
[Spotlight]	Turns the [Spotlight] light metering option on/off.	●	–	
[Zebra: All]	Turns zebra patterns on/off from the VIDEO terminal and viewfinder <sup>2</sup> .	●	–	91
[Zebra: VIDEO Output], [Zebra: VF Output] <sup>2</sup>	Turns zebra patterns on/off on the respective screen/video output.	●	–	91
[WFM: All]	Turns the waveform monitor on/off from the viewfinder <sup>2</sup> and terminals capable of waveform monitor output.	●	●	106
<b>C200</b> [WFM: VF+VIDEO Output], <b>C200B</b> [WFM: VIDEO Output], [WFM: SDI Output]	Turns the waveform monitor on/off on the respective screen/video output.	●	●	106
[LUT: All]	Turns the LUT on/off from the viewfinder <sup>2</sup> and terminals capable of LUT output.	●	–	156
[LUT: VIDEO Output], [LUT: VF Output] <sup>2</sup> , [LUT: SDI Output]	Turns on/off the application of the selected LUT on the respective screen/video output.	●	–	106
[Set White Balance]	Starts the white balance calibration for a custom white balance setting.	●	–	77
[AWB Lock]	While using auto white balance (AWB), locks the current white balance settings.	●	–	79
[ <b>AWB</b> AWB], [  Set A], [  Set B], [  Daylight], [  Tungsten], [  Kelvin]	Changes the white balance mode/setting to the respective option.	●	–	77
[LCD LM-V1 Setup]	Opens the [  1] Monitoring Setup] menu.	●	●	41
[LCD LM-V2 Setup] <sup>2</sup>	Opens the [  2] Monitoring Setup] menu.	●	●	
[Viewfinder Setup] <sup>3</sup>	Opens the [  3] Monitoring Setup] menu.	●	●	
[EVF-V70 Setup] <sup>4</sup>	Opens the [  4] Monitoring Setup]* menu. * <b>C200B</b> Appears on the previous page in the menu.	●	●	
[OSD Output]	Turns on/off the inclusion of onscreen displays on the selected screens/video outputs.	●	●	157
[Display]	Changes the onscreen display level.	●	●	60
[Markers: All]	Turns onscreen markers on/off from the viewfinder <sup>2</sup> and terminals capable of onscreen marker output.	●	–	90
<b>C200</b> [Markers: VF+VIDEO Output], <b>C200B</b> [Markers: VIDEO Output], [Markers: SDI/HDMI Output]	Turns onscreen markers on/off on the respective screen/video output.	●	–	90
[Color Bars]	Turns color bars on/off.	●	–	105
[Photo] <sup>1</sup>	Records a photo.	●	–	120
[Review Recording] <sup>1</sup>	Plays back the last clip recorded in <b>CAMERA</b> mode.	●	–	112
[Time Code]	Opens the [  3] System Setup] menu.	●	–	92
[Time Code Hold] <sup>1</sup>	Puts the time code display on hold or resumes it.	●	●	93
[Add Shot Mark]*	Adds a shot mark to the clip.	●	●	108
[Add  Mark]	Adds an  mark to the clip.	●	●	
[Add  Mark]	Adds a  mark to the clip.	●	●	

## Assignable Buttons

Function name	Description	CAMERA	MEDIA	
[Headphones +]	Increases the headphone volume.	●	●	143
[Headphones -]	Reduces the headphone volume.	●	●	
[Monitor Channels]	Switches the audio output channel.	●	●	158
[Audio Level Indicator]	Turns the audio level meter on/off.	●	●	101
[FUNC]	Enters the direct setting mode, replicating the function of the camera's FUNC button.	●	–	66
[Slow Motion Recording]	Turns slow motion recording mode on/off.	●	–	114
[Output : 60 ⇄ 60 (24) fps]	Turns on/off making output terminal/screen video equivalent to 24 fps (or 30 fps) when the frame rate is 59.94P or 59.94i.	●	–	–
[Output : 60 ⇄ 60 (30) fps]		●	–	–
[Shutter]	Enters the direct setting mode with the shutter speed highlighted and ready to be adjusted.	●	–	68
[ISO/Gain]	Enters the direct setting mode with the ISO speed or gain value highlighted and ready to be adjusted.	●	–	69
[White Balance]	Enters the direct setting mode with the white balance highlighted and ready to be adjusted.	●	–	77
[Status] <sup>1</sup>	Displays the status screens.	●	●	196
[Audio Status]	Displays the [Audio] status screens. You can press the joystick to open the  [1] Audio Setup] menu.	●	●	200
[Custom Picture/HDR]	Opens the most recently opened [  Custom Picture/HDR] menu.	●	–	129
[My Menu]	Opens the [My Menu] customized menu.	●	–	34
[Initialize Media]	Opens the [Initialize Media] submenu.	●	●	50
[  User Setting] <sup>1</sup>	Customizable slot. Assign to the button any menu setting you would like to register.	●	●	–

<sup>1</sup> Function can be used only by assigning it to a button.

<sup>2</sup> Available only when the optional LM-V2 LCD Monitor is attached to the camera.

<sup>3</sup>  only.

<sup>4</sup> Available only when the optional EVF-V70 OLED Electronic Viewfinder is attached to the camera.

## Custom Picture Settings

The camera lets you change many settings (📖 133) that control various aspects of the image produced. As a set, all these settings are treated as a single custom picture file. After adjusting the desired settings to your preference, you can save up to 20 custom picture files (in the camera or on an SD card), and load them later to apply exactly the same settings (📖 131). Saving and loading custom picture files are available only for SD card B.

### NOTES

- Custom picture files are exclusively compatible for use only with C200 / C200B cameras.

## Selecting Custom Picture Files

Select a custom picture file to apply its settings to your recordings or to edit, rename, protect, or transfer it.



Operating modes: CAMERA MEDIA | RAW MP4 XF-AVC

1 Open the custom picture file's [Select] screen.

**MENU** ➤  [1] Custom Picture/HDR ➤ [File] ➤ [Select]

- When an optional RC-V100 Remote Controller is connected to the camera, you can press the remote controller's CUSTOM PICT. button to open the  Custom Picture/HDR submenu.

2 Push the joystick up/down to select the desired file and then press the joystick.

- Select one of the custom picture files saved in the camera (C1 to C20). To use the settings of a custom picture file saved on an SD card, copy the file to the camera in advance (📖 132).
- When you close the menu, the selected custom picture file's settings will be applied.
- The icon of the [Gamma] setting in effect will appear on the left of the screen. If the detailed settings were activated (**MENU** ➤  [1] Custom Picture/HDR) ➤ [Activate Other Settings] is set to [On],  will appear on the left of the screen.

## Preset Picture Settings

Operating modes: CAMERA MEDIA | RAW MP4 XF-AVC

The camera offers the following preset picture settings (combinations of gamma curve and color matrix). When you edit a custom picture file to your preference, you can use one of the presets or turn the presets off and change the desired settings individually (📖 133). The default setting is [BT.709].

[Preset]*	[Gamma]*	[Color Matrix]*	Characteristics
[Canon Log 3]	[Canon Log 3]	[Neutral]	This setting uses Canon Log 3 gamma and presumes a workflow that includes post-production processing. This gamma curve keeps the characteristics of the [Canon Log] setting while expanding its dynamic range.
[Canon Log]	[Canon Log]	[Cinema EOS Original]	This setting uses Canon Log gamma and presumes a workflow that includes post-production processing. It can obtain an impressive dynamic range and color tones appropriate for post-production.
[BT.709]	[Wide DR]	[Neutral]	These settings produce the widest dynamic range possible without requiring post-production. The color space can be selected from 2 options.

\* In the **MENU** ➤  [1] Custom Picture/HDR] menu.

**i** NOTES

- **About the logarithmic gamma curves (Canon Log settings)**

These gamma curves assume the need for post-production processing. They were designed to make the most of the imaging sensor characteristics in order to obtain impressive levels of dynamic range.

- In **CAMERA** mode, you can apply a LUT to the LCD screen and viewfinder and to video output from the SDI terminal to use gamma curve settings more suitable for viewing on a monitor screen.
- There are also other LUTs available that can be applied for processing in post-production. For the latest information on available LUTs, please visit your local Canon website.

- **About changing custom picture related settings using the optional RC-V100 Remote Controller**

- If a protected custom picture file is selected on the camera, custom picture related settings cannot be changed using the remote controller.
- Adjusting custom picture related settings using the remote controller will change the settings registered under the currently selected custom picture file. If you want to keep an important custom picture file, copy it in advance to an SD card or select in advance a custom picture file you do not mind changing.

## Editing a Custom Picture File's Settings

Operating modes: **CAMERA** **MEDIA** | **RAW** **MP4** **XF-AVC**

1 Select a custom picture file (📖 129).

2 Open the [Preset] submenu.

**MENU** ➤ [**CP**<sub>HDR</sub>] [1] Custom Picture/HDR] ➤ [Preset]

3 Select the desired option and then press the joystick.

- To use preset picture settings: Select the desired preset setting (📖 129) and skip to step 5.
- To select the main settings individually: Select [Off] and continue to step 4.

4 Select [Gamma], select the desired gamma curve and then press the joystick.

- Select [Color Matrix] to select the color matrix in the same way.

5 To change the custom picture's detailed settings, open the [Activate Other Settings] submenu.

**MENU** ➤ [**CP**<sub>HDR</sub>] [1] Custom Picture/HDR] ➤ [Activate Other Settings]

6 Select [On] and then press the joystick to activate the custom picture's detailed settings.

7 Select a setting and then press the joystick.

- The custom picture's detailed settings are in **MENU** ➤ [**CP**<sub>HDR</sub>] [1] Custom Picture/HDR] ➤ [Other Settings].

8 Change the setting to the desired level and then press the joystick.

- Refer to *Available Custom Picture Settings* (📖 133) for details on the various settings.
- Repeat steps 7 and 8 for other settings, as necessary.
- When you close the menu, the new custom picture settings will be applied.

## Resetting Custom Picture Files

Operating modes: CAMERA MEDIA | RAW MP4 XF-AVC

- 1 Select a custom picture file (📖 129).
- 2 Open the [Reset] submenu.  
**MENU** ➤ [CP\_HDR 1 Custom Picture/HDR] ➤ [File] ➤ [Reset]
- 3 Select [OK] and then press the joystick.

## Renaming Custom Picture Files

Operating modes: CAMERA MEDIA | RAW MP4 XF-AVC

- 1 Select a custom picture file (📖 129).
- 2 Open the [Rename] submenu.  
**MENU** ➤ [CP\_HDR 1 Custom Picture/HDR] ➤ [File] ➤ [Rename]
- 3 To change the file name, select [Input] and then press the joystick.
  - Enter the desired file name (up to 8 characters) using the keyboard screen (📖 35).
- 4 Select [OK] and then press the joystick.

## Protecting Custom Picture Files

Protecting a custom picture file prevents its settings from being accidentally changed.

Operating modes: CAMERA MEDIA | RAW MP4 XF-AVC

- 1 Select a custom picture file (📖 129).
- 2 Open the [Protect] submenu.  
**MENU** ➤ [CP\_HDR 1 Custom Picture/HDR] ➤ [File] ➤ [Protect]
- 3 Select [Protect] and then press the joystick.
  - In the custom picture file selection screen,  will appear next to the file name.
  - To remove protection settings, select [Unprotect] instead.

## Copying Custom Picture Files

You can transfer custom picture files between the camera and SD card B.

Operating modes: CAMERA MEDIA | RAW MP4 XF-AVC

### Copying a File from the Camera to SD Card B

- 1 Select a custom picture file (📖 129).
- 2 Open the [Copy to SD Card B] submenu.  
**MENU** ➤ [CP\_HDR 1 Custom Picture/HDR] ➤ [File] ➤ [Copy to SD Card B]

- 3 Select the destination file and then press the joystick.
  - Select an existing custom picture file to overwrite it or, if this option is available, select [New File] to save the settings as a new custom picture file on SD card B.
- 4 Select [OK] and then press the joystick.
  - The file on SD card B will be overwritten or a new file will be created on the SD card.
- 5 When the confirmation message appears, press the joystick.

### Replacing a File in the Camera with a File on SD Card B

- 1 Select the custom picture file that you wish to replace (📖 129).
- 2 Open the [Load from SD Card B] submenu.  
**MENU** ➤ [CP<sub>HDR</sub>] 1 Custom Picture/HDR] ➤ [File] ➤ [Load from SD Card B]
- 3 Select the file with the settings that you want to replicate and then press the joystick.
- 4 Select [OK] and then press the joystick.
  - The file in the camera will be overwritten by the one on SD card B.
- 5 When the confirmation message appears, press the joystick.

### Embedding Custom Picture Settings in a Clip

When you record a clip using custom picture settings, you can have the custom picture file embedded in the metadata and saved along with the clip.

Operating modes: CAMERA MEDIA | RAW MP4 XF-AVC

- 1 Open the [Add CP File] submenu.  
**MENU** ➤ [📷] 4 Recording/Media Setup] ➤ [Metadata] ➤ [Add CP File]
- 2 Select [On] and then press the joystick.
  - Select [Off] to not embed custom picture settings in a clip.



## Available Custom Picture Settings

### [ 1 Custom Picture/HDR] Menu

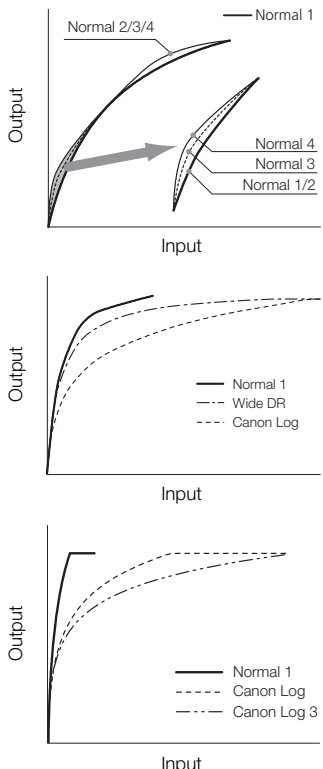
Submenu levels / Menu items	Options / Additional information
[Preset]	<p>[Canon Log 3], [Canon Log], [<b>BT.709</b>], [Off]</p> <p>The camera offers a number of preset color settings (combinations of color space, gamma curve and color matrix). For details, refer to <i>Preset Picture Settings</i> ( 129).</p> <p>[Off]: Select this setting when you want to set a different combination of custom picture settings with the individual custom picture settings described below.</p>
<p>[Gamma]</p>  <p>The first graph shows Normal 1 (solid line) and Normal 2/3/4 (dashed line). The second graph shows Normal 1 (solid line), Wide DR (dashed line), and Canon Log (dotted line). The third graph shows Normal 1 (solid line), Canon Log (dashed line), and Canon Log 3 (dotted line).</p>	<p>[Canon Log 3], [Canon Log], [<b>Wide DR</b>], [Normal 1 (Standard)], [Normal 2 (x4.0)], [Normal 3 (BT.709)], [Normal 4 (x5.0)]</p> <p>Changes the overall look of the image.</p> <p>[Canon Log 3]: Logarithmic gamma curve that keeps the characteristics of the [Canon Log] setting while expanding its dynamic range. Requires image processing in post-production.</p> <p>[Canon Log]: Logarithmic gamma curve that obtains an impressive dynamic range. Requires image processing in post-production.</p> <p>[Wide DR]: Gamma curve with a very wide dynamic range. Optimized for playback on TV monitors.</p> <p>[Normal 1 (Standard)]: Standard picture for playback on TV monitors.</p> <p>[Normal 2 (x4.0)]: Setting suitable for playback on TV monitors. Produces brighter highlights (bright areas of the image) than with the [Normal 1 (Standard)] setting.</p> <p>[Normal 3 (BT.709)]: Setting suitable for playback on TV monitors. Produces a more faithful black gradation in the shadows (dark areas of the image) than with the [Normal 2 (x4.0)] setting.</p> <p>[Normal 4 (x5.0)]: Setting suitable for playback on TV monitors. Produces even better black gradation in the shadows (dark areas of the image) than with the [Normal 3 (BT.709)] setting.</p>
[Color Matrix]	<p>[<b>Neutral</b>], [Production Camera], [Cinema EOS Original], [Video], [Off]</p> <p>The color matrix affects the overall color tonality of the image.</p> <p>[Neutral]: Reproduces neutral colors.</p> <p>[Production Camera]: Reproduces colors more suitable for motion picture production.</p> <p>[Cinema EOS Original]: Color matrix developed by Canon, designed to reproduce the 4K output of an EOS C500 camera using the BT.709 color space.</p> <p>[Video]: Reproduces the colors of an EOS C300/EOS C500 camera with no custom picture settings applied.</p> <p>[Off]: Colors are not adjusted.</p>
[Activate Other Settings]	<p>[On], [<b>Off</b>]</p> <p>Set this setting to [On] to enable the editing of the custom picture's detailed settings explained in the following table.</p>
[Other Settings]	<p>[Black], [Black Gamma], [Low Key Satur.], [Knee], [Sharpness], [Noise Reduction], [White Balance], [Color Matrix Tuning], [Other Functions]</p> <p>Categories of the custom picture's detailed settings explained in the following table.</p>

[HDR] 1 Custom Picture/HDR [Other Settings] Submenu (Detailed Settings)

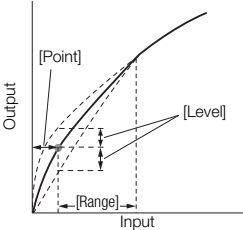
Submenu levels / Menu items	Options / Additional information
[Black]	
[Master Pedestal]	<p>–50 to 50 (<math>\pm 0</math>)</p> <p>Increases or decreases the black level. Higher settings will make dark areas brighter but decrease contrast. When [Gamma] is set to one of the Canon Log settings, this setting has no effect on the picture.</p>
[Master Black Red], [Master Black Green], [Master Black Blue]	<p>–50 to 50 (<math>\pm 0</math>)</p> <p>These settings correct the color cast in blacks. When [Gamma] is set to one of the Canon Log settings, these settings have no effect on the picture.</p>
[Black Gamma]	
[Level]	–50 to 50 ( $\pm 0$ )
[Range], [Point]	–20 to 50 ( $\pm 0$ )
	<p>These settings control the lower part of the gamma curve (dark areas of the image). When [Gamma] is set to one of the Canon Log settings or [Wide DR], these settings are not available.</p> <p>[Level]: Raises or lowers the lower part of the gamma curve.</p> <p>[Range]: Selects the adjustment range from the selected [Point].</p> <p>[Point]: Determines the shape of the lower part of the gamma curve.</p>
[Low Key Satur.]	
[Activate]	<p>[On], [Off]</p> <p>Set this setting to [On] to enable the adjustment of color saturation in dark areas with the [Level] setting.</p>
[Level]	<p>–50 to 50 (<math>\pm 0</math>)</p> <p>Specifies how saturated colors are in dark areas.</p>
[Knee]	
[Activate]	<p>[On], [Off]</p> <p>Set this setting to [On] to enable the adjustment of the knee point with the following settings. When [Gamma] is set to one of the Canon Log settings or [Wide DR], the [Knee] settings are not available.</p>

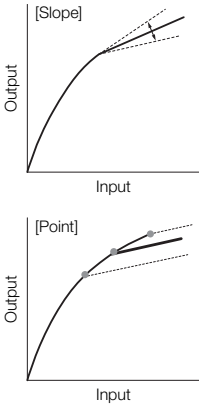
Submenu levels / Menu items	Options / Additional information
[Slope]	-35 to 50 ( <b>±0</b> )
[Point]	50 to 109 ( <b>95</b> )
[Saturation]	-10 to 10 ( <b>±0</b> )
	<p>These settings control the upper part of the gamma curve (highlights of the image). By compressing the highlights, you can prevent parts of the image from being overexposed.</p> <p>[Slope]: Determines the slope of the gamma curve above the knee point.</p> <p>[Point]: Sets the knee point of the gamma curve.</p> <p>[Saturation]: Adjusts the color saturation in the highlights.</p>
[Sharpness]	
[Level]	-10 to 50 ( <b>±0</b> ) Sets the sharpness level of the video output signal and the recorded signal.
[H Detail Freq.]	-8 to 8 ( <b>±0</b> ) Sets the center frequency of horizontal sharpness. Setting higher values increases the frequency, which, in turn, increases the sharpness.
[Coring Level]	-30 to 50 ( <b>±0</b> ) Sets the level of correction of artifacts caused by high sharpness levels (coring). Higher values prevent sharpness from being applied to minute details, resulting in less noise.
[Coring D-Ofst]	0 to 50 ( <b>0</b> ) Sets the coring level of the minimum brightness level (level-dependent offset).
[Coring D-Curve]	0 to 8 ( <b>0</b> ) Sets the curve of coring adjustment, in other words, how the coring level changes from the value set for [Coring Level] to that set for [Coring D-Ofst] (level-dependent curve).
[HV Detail Bal.]	-8 to 8 ( <b>±0</b> ) Adjusts the ratio between horizontal and vertical detail. Higher values emphasize vertical detail while lower values emphasize horizontal detail.
[Limit]	-50 to 50 ( <b>±0</b> ) Restricts how much sharpness is applied.
[Select]	0 to 15 ( <b>0</b> ) In addition to the sharpness set by [Level], [Select] sets the sharpness for areas with higher frequencies. Higher values apply more sharpness to areas with higher frequencies. Use this for subjects in which normal sharpening is not effective.
[Knee Aperture Gain]	0 to 9 ( <b>0</b> )
[Knee Aperture Slope]	0 (no slope), 1 (steep slope) to 3 (gradual slope) ( <b>1</b> ) These settings allow you to adjust the sharpness of only the areas above the knee point. When [Gamma] is set to one of the Canon Log settings or [Wide DR], these settings have no effect on the picture. [Knee Aperture Gain]: Determines the amount of sharpness. [Knee Aperture Slope]: Sets the slope of the sharpness.
[Level Depend Level]	0 to 50 ( <b>0</b> ) Sets the brightness of the dark areas of the image that will be affected.

Submenu levels / Menu items	Options / Additional information
[Level Depend Slope]	0 (no slope), 1 (steep slope) to 3 (gradual slope) <b>(0)</b> Determines the slope of the area between the upper and lower parts of the gamma curve.
[Level Depend Offset]	0 to 50 <b>(0)</b> Adjusts the sharpness level of dark areas in the image. Setting higher values will lower the sharpness level.
<b>[Noise Reduction]</b>	
[Level]	1 (lowest level) to 12 (highest level), <b>[Off]</b> Reduces the amount of noise that appears in the image.
<b>[White Balance]</b>	
[R Gain], [B Gain]	-50 to 50 <b>(±0)</b> These settings adjust the amount of white balance throughout the whole image by changing the intensity of red tones ([R gain]) and blue tones ([B Gain]).
<b>[Color Matrix Tuning]</b>	
[Gain]	-50 to 50 <b>(±0)</b>
[Phase]	-18 to 18 <b>(±0)</b> These settings adjust the color intensity ([Gain]) and color phase ([Phase]) of the color matrix, affecting the color tones of the whole image.
[R-G], [R-B], [G-R], [G-B], [B-R], [B-G]	-50 to 50 <b>(±0)</b> Each matrix changes the tint of the picture along the color gradations detailed below, affecting the color tones of the whole image. [R-G]: cyan/green and red/magenta; [R-B]: cyan/blue and red/yellow; [G-R]: magenta/red and green/cyan; [G-B]: magenta/blue and green/yellow; [B-R]: yellow/red and blue/cyan; [B-G]: yellow/green and blue/magenta.
<b>[Other Functions]</b>	
[Setup Level]	-50 to 50 <b>(±0)</b> Adjusts the black level set by the [Black] ➤ [Master Pedestal] setting. When [Gamma] is set to one of the Canon Log settings, this setting has no effect on the picture.
[Over 100%]	<b>[Through]</b> , [Press], [Clip] Determines how the camera handles video signals exceeding 100%. [Through]: Leave the signal unchanged. [Clip]: Clip the signal at 100%. [Press]: Compress a signal of up to 108% down to 100% levels.

**i** NOTES

- If editing of the custom picture file's detailed settings is enabled ([Activate Other Settings] is set to [On]), when an optional RC-V100 Remote Controller is connected to the camera, the following custom picture settings can be changed using the buttons and dials on the remote controller.
  - [Other Settings] ➤ [Black] ➤ [Master Pedestal], [Master Black Red], [Master Black Blue]
  - [Other Settings] ➤ [Black Gamma] ➤ [Level]
  - [Other Settings] ➤ [Knee] ➤ [Slope], [Point] (only when [Knee] ➤ [Activate] is set to [On])
  - [Other Settings] ➤ [Sharpness] ➤ [Level]
  - [Other Settings] ➤ [White Balance] ➤ [R Gain], [B Gain]

## Saving and Loading Camera Settings

After you adjust settings in the various menus, you can save those settings in the camera or on SD card B. You can load those settings at a later date or on another C200 / C200B camera so that you can use that camera in the exact same way.

Operating modes: CAMERA MEDIA | RAW MP4 XF-AVC

### Saving Camera Settings

1 Open the [Save] submenu.

[] System Setup] ➤ [Transfer Menu/] ➤ [Save]

2 Select [To Camera] or [To SD Card B] and then press the joystick.

3 Select [OK] and press the joystick.

- The camera's menu settings will be saved to the selected destination. If menu settings were previously saved, the old file will be overwritten by the current menu settings.

4 When the confirmation message appears, press the joystick.

### Loading Camera Settings

1 Open the [Load] submenu.



[] System Setup] ➤ [Transfer Menu/] ➤ [Load]

2 Select [From Camera] or [From SD Card B] and then press the joystick.

3 Select [OK] and press the joystick.

- The camera's menu settings will be replaced by the settings saved on the selected source. Then, the screen will turn black momentarily and the camera will restart.

#### NOTES

- The following menu settings are not saved with this operation when the passwords have been set by the user.
  - Encryption keys/passwords under [] Network Settings] ➤ [Connection Settings]
  - The passwords under [] Network Settings] ➤ [Browser Remote Settings] ➤ [Full: Password], [Camera: Password] and [Meta: Password]
  - The password under [] Network Settings] ➤ [FTP Transfer Settings] ➤ [FTP: Password]
- When menu settings are loaded with this operation, even protected custom picture files in the camera will be replaced.
- Camera settings files are exclusively compatible for use only with C200 / C200B cameras.



## Playback

This section explains how to play back clips with the camera. For details on playing back clips using an external monitor, refer to *Connecting to an External Monitor or Recorder* (📖 152). For details on viewing photos on the SD card, refer to *Viewing Photos* (📖 121).

Operating modes: CAMERA | MEDIA | RAW | MP4 | XF-AVC

### Clip Index Screen

Playback functions are accessed from the clip index screen. To open the clip index screen, set the camera to MEDIA mode. When the primary recording format is RAW, clips are saved on the CFast card; when it is MP4 or XF-AVC, clips are saved on an SD card. If the recording media contains clips recorded at a system frequency other than the one currently used by the camera, you will not be able to play back the clips. In such case, change the camera's system frequency (📖 64) to match the recordings on the recording media.

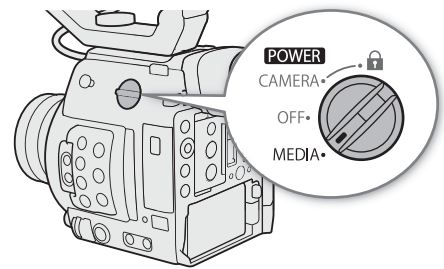

Set the **POWER** switch to MEDIA.

- The camera switches to MEDIA mode and the clip index screen appears. The index screen that appears depends on the currently selected recording format but you can change the index screen with the procedure on the next page.
- Some of the information on the index screen will change depending on the selected clip.



- 1 Shot mark (📖 108)
- 2  mark/ mark (📖 108)
- 3 Orange selection frame
- 4 Clip identification (camera index, reel number and clip number) (📖 61)  
For MP4 clips, the file name (📖 62) appears instead.
- 5 Recording date and time
- 6 Clip thumbnail
- 7 Recording media  
  SD card (the one currently selected appears in white)  
 CFast card
- 8 Network icon  
Appears when transferring a clip to an FTP server.
- 9 Clip number / Total number of clips
- 10 Recording date (month and day only) and time
- 11 Clip's start time code
- 12 Clip duration
- 13 Embedded custom picture file (📖 132)
- 14 Special recording mode (📖 114)
- 15 Color sampling and resolution (📖 64)  
For RAW clips, [RAW] appears instead of the color sampling.
- 16 Frame rate (📖 64)

### Switching Between the SD Card Slots

If both SD card slots contain a SD card, you can switch between them as necessary.

Press the SLOT SELECT button.

- The access indicator of the selected SD card slot will illuminate in green.

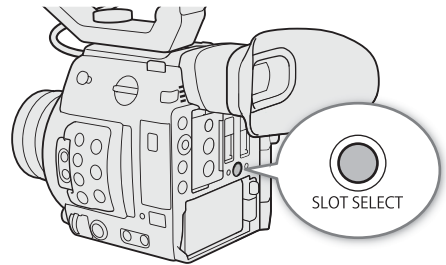

### Switching to Other Index Screens

The clip index screen shows primary clips recorded on the currently selected recording media. From the clip index screen you can switch to the following index screens to view just some of the clips or other types of recordings.

[RAW] index screen: Only clips recorded in RAW on the CFast card.

[MP4] index screen: Only clips recorded in MP4 format on the same SD card.

[XF-AVC] index screen: Only clips recorded in XF-AVC format on the same SD card.

[Photos] index screen: Photos on SD card B.

- 1 Press the INDEX button.
  - When you press the button on the clip index screen, the index screen selection menu will appear.
- 2 Select the desired index screen and then press the joystick.
  - The selected index screen appears.
  - Select [Cancel] instead to cancel the operation.
  - Press the INDEX button again to return to the clip index screen.

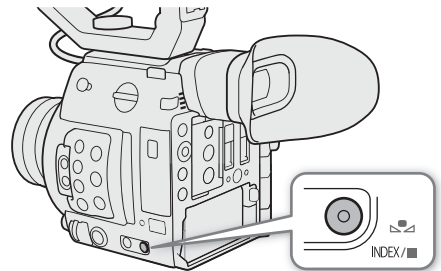



## Playing Back Clips

After you select a clip to play back from the index screen, you can control the playback with the buttons on the camera (play/pause/stop only) or with the joystick and onscreen joystick guide ( 143).

- 1 Move the orange selection frame to the clip you want to play back.
- 2 Press the ►/|| button to start playback.
  - The selected clip will be played back.
  - Press the ►/|| button again or press the joystick to pause/resume the playback.
  - Press the ■ button to stop the playback and return to the index screen.

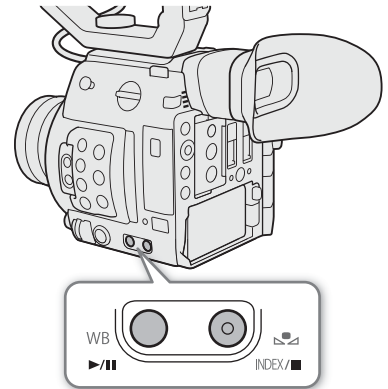

### Custom picture settings of RAW clips during playback

RAW clips are played back with the following custom picture settings.

**[Gamma]:** [Wide DR]

**[Color Space]:** [BT.709]

**[Color Matrix]:** [Neutral]

Other picture settings are the same as those when [Activate Other Settings] is set to [Off].

### ! IMPORTANT

- Observe the following precautions while an access indicator is illuminated in red. Failure to do so may result in permanent data loss.
  - Do not disconnect the power source or turn off the camera.
  - Do not open the card slot cover of the card being accessed and do not remove the card.

## Onscreen Displays

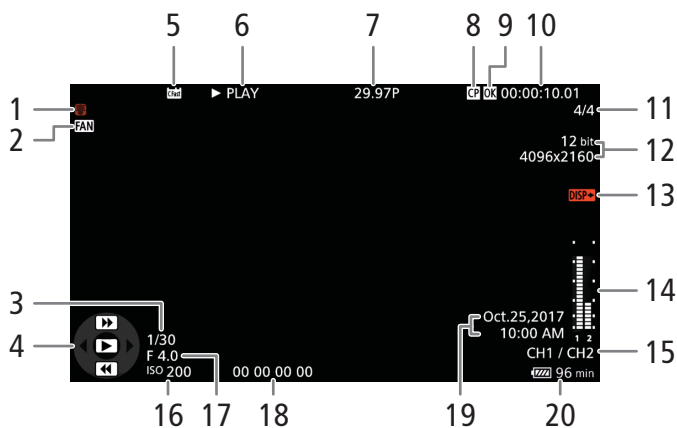

- 1 High temperature warning (📖 208)
- 2 Fan operation (📖 63)
- 3 Shutter speed<sup>1</sup> (📖 67)
- 4 Joystick guide (📖 143)
- 5 Recording media
  - SD card
  - CFast card
- 6 Playback operation
- 7 Frame rate (📖 64)
 

For clips recorded using slow motion recording, the shooting frame rate and playback frame rate will both be displayed.
- 8 Embedded custom picture file (📖 132)
- 9 mark/ mark (📖 108)
- 10 Time code (📖 92)
- 11 Clip number / Total number of clips
- 12 Color depth and resolution (📖 64)
 

Color sampling and resolution are displayed for MP4 and XF-AVC clips.
- 13 Onscreen displays superimposed on video output (📖 157)
- 14 Audio level meter<sup>2</sup>
- 15 Audio output channel (📖 158)
- 16 ISO Speed/Gain<sup>1</sup> (📖 69)
- 17 Aperture value<sup>1</sup> (📖 72)
- 18 User bit (📖 95)
- 19 Recording date and time<sup>3</sup>
- 20 Remaining battery time (📖 58)

<sup>1</sup> Only when [] [5] Monitoring Setup] (C200B [] [4] Monitoring Setup]) ➤ [Custom Display] ➤ [Camera Data] is set to [On].

<sup>2</sup> Only when [] [5] Monitoring Setup] (C200B [] [4] Monitoring Setup]) ➤ [Custom Display] ➤ [Audio Level Indicator] is set to [On].

<sup>3</sup> Only when [] [5] Monitoring Setup] (C200B [] [4] Monitoring Setup]) ➤ [Custom Display] ➤ [Date/Time] is set to [On].

## 6 Playback operation

- PLAY Playback
- PAUSE Playback pause
- Frame reverse/Frame advance
- F FWD ▶▶ Fast playback\*
- ◀◀ F REV Fast reverse playback\*

\* The playback speed (x5, x15 or x60) will also appear in the indicator.

## NOTES

- You can repeatedly press the DISP button to switch the onscreen displays in the following sequence.  
Show all onscreen displays → hide the joystick guide → hide all onscreen displays\*
- \* Except for momentary displays like the clip number when the playback switches to a different clip, or the time code and playback operation at the end of the playback.

## Playback Controls

The following playback types are available using the onscreen joystick guide and any of the joysticks.

Playback type	Operation
Fast playback	During playback, push the joystick up or down. Repeat to increase the playback speed to approximately 5x → 15x → 60x the normal speed.
Frame advance/reverse	During playback pause, push the joystick up or down.
Return to playback mode	Press the joystick itself. Alternatively, you can press the ►/⏏ button.

143

### **i** NOTES

- There is no audio during any of the playback types listed in the previous table.
- During some playback modes, you may notice some anomalies (blocky video artifacts, banding, etc.) in the playback picture.
- The speed indicated on the screen is approximate.
- If the clip's bit rate setting includes Long GOP compression, during frame advance, the time advanced between frames is approximately 0.5 seconds.

## Adjusting the Volume

You can use the speaker or connect headphones to the  (headphone) terminal to listen to the audio during playback. Adjust the headphone volume with the **MENU** ➤ [J) **i** Audio Setup] ➤ [Speaker Volume] or [Headphone Volume] setting. If you set an assignable button to [Headphones +] or [Headphones -] ([125](#)), you can press the button to adjust the headphone volume without using the menu. The audio signal will also be output from the SDI terminal and HDMI OUT terminal.

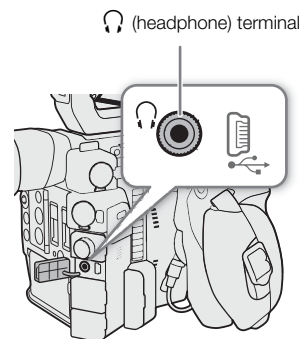







### **i** NOTES

- For details on changing the audio channel, refer to *Audio Output* ([158](#)).

## Clip Operations

Besides playing back a clip, you can perform other operations such as deleting a clip or displaying clip information. This is done through the clip menu, which contains different functions depending on the index screen. Refer to the following table for available functions and refer to the following pages for more details of the functions.

### Clip Menu Functions

Menu item	Description	Index screen		
		[RAW]	[MP4]	[XF-AVC]
[Cancel]	Closes the clip menu.	●	●	●
[Display Clip Info]	Displays the clip information screen (145).	●	●	●
[Add  Mark], [Delete  Mark]	Adds or deletes an  mark (108).	–	–	● <sup>1</sup>
[Add  Mark], [Delete  Mark]	Adds or deletes a  mark (108).	–	–	● <sup>1</sup>
[Del. All Shot Marks]	Deletes all the shot marks from a clip.	–	–	●
[Recover Clip] <sup>2</sup>	Recovers a clip (52).	●	●	●
[Delete Clip]	Deletes a clip (147).	●	●	●
[Delete User Memo]	Deletes the user memo and GPS information of a clip (148).	–	–	●
[FTP Transfer]	Transfers clips using the FTP protocol (182).	–	●	●

<sup>1</sup> If the clip already contains such a clip mark, only the delete option will be available.

<sup>2</sup> Appears only when a clip requires recovery. In such case, only [Cancel], [Recover Clip] and [Delete Clip] will appear in the menu.

## Using the Clip Menu

Operating modes: CAMERA | MEDIA | RAW | MP4 | XF-AVC

### 1 Select a clip and then press the joystick.

- The clip menu appears. Available functions depend on the index screen and which functions are enabled.

### 2 Select the desired function and then press the joystick.

- The function is enabled. For some functions, further action may be required. Follow the onscreen directions.
- Press the CANCEL button instead to return to the clip index screen.

### ! IMPORTANT

- Observe the following precautions while an access indicator is illuminated in red. Failure to do so may result in permanent data loss.
  - Do not disconnect the power source or turn off the camera.
  - Do not open the card slot cover of the card being accessed and do not remove the card.

### i NOTES

- To perform operations on MP4 or XF-AVC clips recorded on an SD card, make sure the LOCK switch on the SD card is not set to prevent writing.

## Displaying Clip Information

Operating modes: CAMERA MEDIA | RAW MP4 XF-AVC

Select [Display Clip Info] in the clip menu to display the selected clip's information screen ([Clip Info] screen). Push the joystick left/right to switch to the previous/next clip. When you have finished, press the CANCEL button to return to the clip index screen.

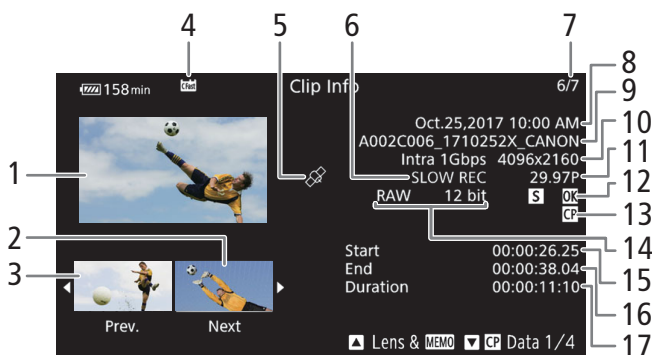

- |   |   |
|---|---|
| <ul style="list-style-type: none"> <li>1 Thumbnail of the selected clip</li> <li>2 Thumbnail of the next clip</li> <li>3 Thumbnail of the previous clip</li> <li>4 Recording media           <ul style="list-style-type: none"> <li>[A] [B] SD card (the one currently selected appears in white)</li> <li>[CFast] CFast card</li> </ul> </li> <li>5 Clip geotagged with GPS information (📖 111)</li> <li>6 Special recording mode (📖 114)</li> <li>7 Clip number / Total number of clips</li> <li>8 Recording date and time</li> </ul> | <ul style="list-style-type: none"> <li>9 Clip file name (📖 61, 62)</li> <li>10 Compression, bit rate and resolution (📖 64)</li> <li>11 Frame rate (📖 64)</li> <li>12 [OK] mark/[✓] mark/[S] mark (📖 108)</li> <li>13 Embedded custom picture file (📖 132)</li> <li>14 Color sampling (📖 64)<br/>For RAW clips, [RAW] and the color depth appear instead.</li> <li>15 Clip's start time code</li> <li>16 Clip's end time code</li> <li>17 Clip duration</li> </ul> |
|---|---|

## Displaying the Lens Information and User Memo

Operating modes: CAMERA MEDIA | RAW MP4 XF-AVC



From the [Clip Info] screen, push the joystick up to display the [Lens & MEMO] screen. In this screen you can check details about the lens used to record the clip. If the clip has an embedded user memo, you will see the user memo content in this screen as well. Push the joystick down to return to the [Clip Info] screen.

## Displaying Custom Picture Settings

Operating modes: CAMERA MEDIA | RAW MP4 XF-AVC





When displaying the [Clip Info] screen of a clip that has a custom picture file recorded with it, push the joystick down to display the first of four screens with the clip's custom picture settings ([CP Data 1/4] screen). Push the joystick down to display the other three [CP Data] screens → [Lens & MEMO] screen → [Clip Info] screen.





## Adding Marks or Marks

You can add an OK mark () or check mark () to XF-AVC clips to help you identify particular clips for a future purpose. Furthermore, you cannot delete clips with an  mark so you can use this mark also to protect important clips.





Operating modes:   |   

### Adding an Mark or Mark during Playback









To add an OK mark () or check mark () to a clip during playback or playback pause, you must first set an assignable button to [Add  Mark] or [Add  Mark] in advance.

- 1 Set an assignable button to [Add  Mark] or [Add  Mark] ([□ 125](#)).
  - To add both types of clip marks (to different clips), set one assignable button to [Add  Mark] and another assignable button to [Add  Mark].
- 2 Open the [XF-AVC] index screen and select the desired clip.
- 3 During playback or playback pause, press the assignable button to add the clip mark.
  - A message indicating the clip mark will appear and the selected clip mark will be added to the clip.
  - Adding a clip mark to a clip during playback will pause the playback.

### Adding an Mark or Mark from the Index Screen



- 1 Open the [XF-AVC] index screen, select the desired clip and then press the joystick to open the clip menu.
- 2 Select [Add  Mark] or [Add  Mark] and then press the joystick.
  - The clip information screen appears and it prompts you to confirm the operation.
- 3 Select [OK] and then press the joystick.
  - The screen changes back to the clip index screen and an  mark or  mark appears next to the selected clip's thumbnail.
  - Select [Cancel] instead to cancel the operation.

#### NOTES

- A clip cannot have both an  mark and  mark at the same time. When you add a  mark to a clip with an  mark, the  mark will be deleted. Similarly, when you add an  mark to a clip with a  mark, the  mark will be deleted.

### Deleting an Mark or Mark from a Clip

Operating modes:   |   

- 1 Open the [XF-AVC] index screen, select the desired clip and then press the joystick to open the clip menu.
- 2 Select [Delete  Mark] or [Delete  Mark] and then press the joystick.
  - The clip information screen appears and it prompts you to confirm the operation.
- 3 Select [OK] and then press the joystick.
  - The screen changes back to the clip index screen and the selected mark is deleted.
  - Select [Cancel] instead to cancel the operation.

## Adding Shot Marks

During playback, you can add a shot mark (S) to frames that you want to set apart in an XF-AVC clip.

Operating modes: CAMERA MEDIA | RAW MP4 XF-AVC

### Adding Shot Marks during Playback

To add a shot mark to a clip during playback or playback pause, you must first set an assignable button to [Add Shot Mark] in advance.

- 1 Set an assignable button to [Add Shot Mark] (☰ 125).
- 2 During playback or playback pause, press the assignable button at the point in the clip to add the shot mark.
  - A message indicating the shot mark appears on the screen and the shot mark is added to the clip.
  - Adding a shot mark to a clip during playback will pause the playback.

#### NOTES

- Up to 100 shot marks can be added to a single clip.
- There may be up to a 0.5 second delay between the frame shown when you press the assignable button and the frame to which the camera adds the shot mark.

## Deleting All Shot Marks in a Clip from the Index Screen

Operating modes: CAMERA MEDIA | RAW MP4 XF-AVC

- 1 Select the desired clip and then press the joystick to open the clip menu.
- 2 Select [Del. All Shot Marks] and then press the joystick.
  - The clip information screen appears and it prompts you to confirm the operation.
- 3 Select [OK] and then press the joystick.
  - All shot marks in the selected clip are deleted and the screen changes back to the previous index screen.

## Deleting Clips

You can delete clips from a CFast or SD card one at a time. To delete XF-AVC clips with an OK mark, delete the OK mark beforehand (☰ 146)

Operating modes: CAMERA MEDIA | RAW MP4 XF-AVC

- 1 Select the desired clip and then press the joystick to open the clip menu.
- 2 Select [Delete Clip] and then press the joystick.
  - The clip information screen appears and it prompts you to confirm the operation.
- 3 Select [OK] and then press the joystick.
  - Select [Cancel] instead to cancel the operation.
  - While the clip is being deleted, the operation cannot be canceled.
- 4 When the confirmation message appears, press the joystick.

## Deleting the User Memo and GPS Information

Operating modes: CAMERA MEDIA | RAW MP4 XF-AVC

148

- 1 Open the [XF-AVC] index screen, select the desired clip and then press the joystick to open the clip menu.
- 2 Select [Delete User Memo] and then press the joystick.
  - The [Delete User Memo] screen appears and it prompts you to confirm the operation.
- 3 Select [OK] and then press the joystick.
  - The user memo and GPS information are deleted and the screen changes back to the clip index screen.
  - Select [Cancel] instead to cancel the operation.



## Video Output Configuration

The video signal output from the SDI terminal and HDMI™ OUT terminal, depends on the clip's video configuration and on various menu settings. Output will be from either the SDI terminal or HDMI terminal\*, and the camera will switch the output automatically.

In the following tables, the listed bit depth refers to the video signal's effective bit depth.

\* When [SDI Output Always On] (□ 155) is [Off]

### Recording Video Signal Configuration and Video Output Configuration by Terminal

Refer to the following table for the video output configuration from each terminal, depending on the recording video configuration used. Footnotes appear at the end of the tables (□ 151).

Operating modes: CAMERA MEDIA | RAW MP4 XF-AVC

Recording video configuration			Video output configuration					
Video format <sup>1</sup>	Frame rate <sup>2</sup>	Resolution	SDI terminal <sup>3 4</sup>			HDMI OUT terminal <sup>4</sup>		
			SDI output <sup>5</sup>			Maximum resolution <sup>5</sup>		
			SDI/HDMI scan mode <sup>5</sup>			SDI/HDMI scan mode <sup>5</sup>		
			p <sup>5</sup>		PsF <sup>5</sup>	p <sup>5</sup>		PsF <sup>5</sup>
			2048x1080 / 1920x1080 <sup>5</sup>	1920x1080 <sup>5</sup>	–	3840x2160 <sup>5</sup>	1920x1080 <sup>5</sup>	–
RAW	59.94P 29.97P 23.98P	4096x2160	2048x1080 YCbCr 4:2:2 10 bit	1920x1080 <sup>6</sup> YCbCr 4:2:2 10 bit	59.94i / 29.97PsF <sup>7</sup> 1920x1080 <sup>6</sup> YCbCr 4:2:2 10 bit	1920x1080 <sup>6</sup> YCbCr 4:2:2 10 bit	59.94i 1920x1080 <sup>6</sup> YCbCr 4:2:2 10 bit	
	50.00P 25.00P				50.00i / 25.00PsF <sup>8</sup> 1920x1080 <sup>6</sup> YCbCr 4:2:2 10 bit		50.00i 1920x1080 <sup>6</sup> YCbCr 4:2:2 10 bit	
	24.00P				60.00i 1920x1080 <sup>6</sup> YCbCr 4:2:2 10 bit		60.00i 1920x1080 <sup>6</sup> YCbCr 4:2:2 10 bit	
MP4 / XF-AVC	59.94P 29.97P 23.98P	3840x2160	1920x1080 YCbCr 4:2:2 10 bit	59.94i / 29.97PsF <sup>7</sup> 1920x1080 YCbCr 4:2:2 10 bit	3840x2160 YCbCr 4:2:2 8 bit <sup>9</sup>	1920x1080 YCbCr 4:2:2 10 bit	59.94i 1920x1080 YCbCr 4:2:2 10bit	
	59.94i (XF-AVC only)	1920x1080			1920x1080 YCbCr 4:2:2 10 bit	1920x1080 YCbCr 4:2:2 10 bit		720x480 (59.94P only)
		119.88P <sup>10</sup>	59.94P 1920x1080 YCbCr 4:2:2 8 bit	59.94i 1920x1080 YCbCr 4:2:2 8 bit	59.94P 1920x1080 YCbCr 4:2:2 8 bit	59.94i 1920x1080 YCbCr 4:2:2 8 bit		
		50.00P 25.00P	3840x2160	1920x1080 YCbCr 4:2:2 10 bit	50.00i / 25.00PsF <sup>8</sup> 1920x1080 YCbCr 4:2:2 10 bit	3840x2160 YCbCr 4:2:2 8 bit <sup>9</sup>	1920x1080 YCbCr 4:2:2 10 bit	50.00i 1920x1080 YCbCr 4:2:2 10 bit
	1920x1080	1920x1080 YCbCr 4:2:2 10 bit	1920x1080 YCbCr 4:2:2 10 bit			720x576 (50.00P only)		

Recording video configuration			Video output configuration					
Video format <sup>1</sup>	Frame rate <sup>2</sup>	Resolution	SDI terminal <sup>3 4</sup>			HDMI OUT terminal <sup>4</sup>		
			SDI output <sup>5</sup>			Maximum resolution <sup>5</sup>		
			SDI/HDMI scan mode <sup>5</sup>			SDI/HDMI scan mode <sup>5</sup>		
			p <sup>5</sup>		PsF <sup>5</sup>	p <sup>5</sup>		PsF <sup>5</sup>
			2048x1080 / 1920x1080 <sup>5</sup>	1920x1080 <sup>5</sup>	–	3840x2160 <sup>5</sup>	1920x1080 <sup>5</sup>	–
MP4 / XF-AVC	100.00P <sup>10</sup>	1920x1080	50.00P 1920x1080 YCbCr 4:2:2 8 bit		50.00i 1920x1080 YCbCr 4:2:2 8 bit	50.00P 1920x1080 YCbCr 4:2:2 8 bit		50.00i 1920x1080 YCbCr 4:2:2 8 bit
	50.00i (XF-AVC only)		1920x1080 YCbCr 4:2:2 10 bit					
	24.00P	3840x2160	1920x1080 YCbCr 4:2:2 10 bit	60.00i 1920x1080 YCbCr 4:2:2 10 bit	3840x2160 YCbCr 4:2:2 8 bit	1920x1080 YCbCr 4:2:2 10 bit	60.00i 1920x1080 YCbCr 4:2:2 10 bit	
		1920x1080						
120.00P <sup>10</sup>	1920x1080	60.00P 1920x1080 YCbCr 4:2:2 8 bit		60.00i 1920x1080 YCbCr 4:2:2 8 bit	60.00P 1920x1080 YCbCr 4:2:2 8 bit		60.00i 1920x1080 YCbCr 4:2:2 8 bit	

### Playback Video Configuration and Video Output Configuration by Terminal

Refer to the following tables for the video output configuration from each terminal, depending on the video configuration of the clip being played back.

Operating modes:   |

Clip's video configuration			Video output configuration					
Video format <sup>1</sup>	Frame rate <sup>2</sup>	Resolution	SDI terminal <sup>3 4</sup>			HDMI OUT terminal <sup>4</sup>		
			SDI output <sup>5</sup>			Maximum resolution <sup>5</sup>		
			SDI/HDMI scan mode <sup>5</sup>			SDI/HDMI scan mode <sup>5</sup>		
			p <sup>5</sup>		PsF <sup>5</sup>	p <sup>5</sup>		PsF <sup>5</sup>
			2048x1080 / 1920x1080 <sup>5</sup>	1920x1080 <sup>5</sup>	–	3840x2160 <sup>5</sup>	1920x1080 <sup>5</sup>	–
RAW	59.94P 29.97P 23.98P	4096x2160	2048x1080 YCbCr 4:2:2 10 bit	1920x1080 <sup>6</sup> YCbCr 4:2:2 10 bit	59.94i / 29.97PsF <sup>7</sup> 1920x1080 <sup>6</sup> YCbCr 4:2:2 10 bit	1920x1080 <sup>6</sup> YCbCr 4:2:2 10 bit	59.94i 1920x1080 <sup>6</sup> YCbCr 4:2:2 10 bit	
	50.00P 25.00P				50.00i / 25.00PsF <sup>8</sup> 1920x1080 <sup>6</sup> YCbCr 4:2:2 10 bit			50.00i 1920x1080 <sup>6</sup> YCbCr 4:2:2 10 bit
	24.00P				60.00i 1920x1080 <sup>6</sup> YCbCr 4:2:2 10 bit			60.00i 1920x1080 <sup>6</sup> YCbCr 4:2:2 10 bit

Clip's video configuration			Video output configuration					
Video format <sup>1</sup>	Frame rate <sup>2</sup>	Resolution	SDI terminal <sup>3 4</sup>			HDMI OUT terminal <sup>4</sup>		
			SDI output <sup>5</sup>			Maximum resolution <sup>5</sup>		
			SDI/HDMI scan mode <sup>5</sup>			SDI/HDMI scan mode <sup>5</sup>		
			p <sup>5</sup>		PsF <sup>5</sup>	p <sup>5</sup>		PsF <sup>5</sup>
			2048x1080 / 1920x1080 <sup>5</sup>	1920x1080 <sup>5</sup>	—	3840x2160 <sup>5</sup>	1920x1080 <sup>5</sup>	—
MP4 / XF-AVC	59.94P 29.97P 23.98P	3840x2160	1920x1080 YCbCr 4:2:2 8 bit		59.94i / 29.97PsF <sup>7</sup> 1920x1080 <sup>6</sup> YCbCr 4:2:2 8 bit	3840x2160 YCbCr 4:2:2 8 bit <sup>9</sup>	1920x1080 YCbCr 4:2:2 8 bit	59.94i 1920x1080 <sup>6</sup> YCbCr 4:2:2 8 bit
		1920x1080				1920x1080 <sup>6</sup> YCbCr 4:2:2 8 bit		
		2048x1080 <sup>11</sup>	2048x1080 YCbCr 4:2:2 8 bit	1920x1080 <sup>6</sup> YCbCr 4:2:2 8 bit		720x480 (59.94P only)		
	59.94i (XF-AVC only)	1920x1080	1920x1080 YCbCr 4:2:2 8 bit					
	50.00P 25.00P	3840x2160	1920x1080 YCbCr 4:2:2 8 bit		50.00i / 25.00PsF <sup>8</sup> 1920x1080 <sup>6</sup> YCbCr 4:2:2 8 bit	3840x2160 YCbCr 4:2:2 8 bit <sup>9</sup>	1920x1080 YCbCr 4:2:2 8 bit	50.00i 1920x1080 <sup>6</sup> YCbCr 4:2:2 8 bit
		1920x1080				1920x1080 <sup>6</sup> YCbCr 4:2:2 8 bit		
		2048x1080 <sup>11</sup>	2048x1080 YCbCr 4:2:2 8 bit	1920x1080 <sup>6</sup> YCbCr 4:2:2 8 bit		720x576 (50.00P only)		
	50.00i (XF-AVC only)	1920x1080	1920x1080 YCbCr 4:2:2 8 bit					
	24.00P	3840x2160	1920x1080 YCbCr 4:2:2 8 bit		60.00i 1920x1080 <sup>6</sup> YCbCr 4:2:2 8 bit	3840x2160 YCbCr 4:2:2 8 bit	1920x1080 YCbCr 4:2:2 8 bit	60.00i 1920x1080 <sup>6</sup> YCbCr 4:2:2 8 bit
		1920x1080				1920x1080 <sup>6</sup> YCbCr 4:2:2 8 bit		
2048x1080 <sup>11</sup>		2048x1080 YCbCr 4:2:2 8 bit	1920x1080 <sup>6</sup> YCbCr 4:2:2 8 bit					

<sup>1</sup> MENU [1] Recording/Media Setup] [Main Rec Format].

<sup>2</sup> The frame rate of the video output will be the same as that used for recording (except during slow motion recording and when the SDI/HDMI scan mode is set to PsF).

<sup>3</sup> When [On (Linked to VIDEO Term.)] is set in MENU [2] System Setup] [SDI Output Always On], video is output at 1920x1080 60.00P (when 24.00 Hz) / 59.94P (when 59.94 Hz) / 50.00P (when 50.00 Hz) YCbCr 4:2:2 8 bit.

<sup>4</sup> You can choose to superimpose onscreen displays on the video output from the SDI terminal or HDMI OUT terminal (□ 157). (This is not available for the HDMI OUT terminal when outputting 4K (3840x2160) video at 59.94P or 50.00P.)

You can apply peaking (□ 83) and magnification (□ 83) to the video output from the SDI terminal.

<sup>5</sup> Refers to the [2] System Setup] [SDI Output], [HDMI Max Res.] and [SDI/HDMI Scan Mode] settings and their options.

<sup>6</sup> Video with a resolution of 4096x2160 or 2048x1080 will be displayed letterboxed.

<sup>7</sup> Only when the frame rate is 29.97P.

<sup>8</sup> Only when the frame rate is 25.00P.

<sup>9</sup> Output will be YCbCr 4:2:0 8 bit when the frame rate is 59.94P or 50.00P.

<sup>10</sup> Only during slow motion recording mode.

<sup>11</sup> When [1] Recording/Media Setup] [Sub Rec Format] is set to [MP4 (SD Card)] or [XF-AVC (SD Card)].

## Connecting to an External Monitor or Recorder

When you connect the camera to an external device, be it a monitor (to monitor the recording or for playback) or an external video recorder (for recording), use the terminal on the camera that matches the one you wish to use on the monitor. Then, select the video signal output configuration (☰ 149).

### Connection Diagram

We recommend that you power the camera from a power outlet using the AC adapter.

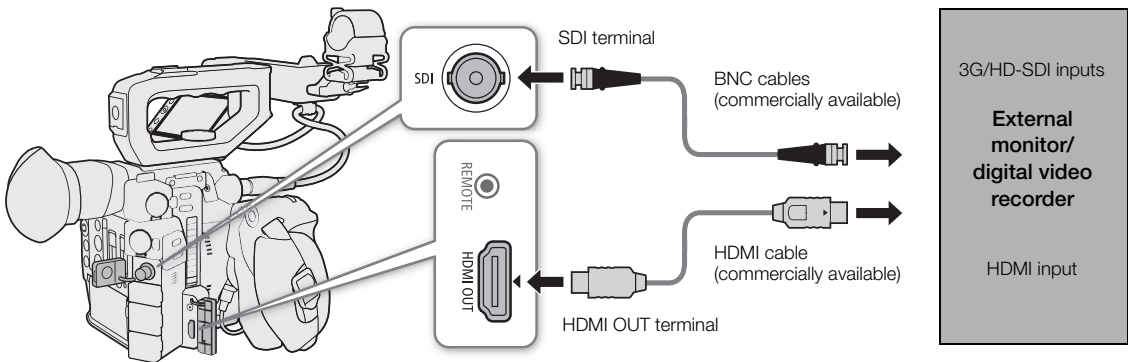

### Using the SDI Terminal

The digital signal that is output from the SDI terminal includes the video signal, audio signal (up to 4 channels) and the recording command signal. When using the SDI terminal, you can output various assistance displays (onscreen markers, magnification, onscreen displays) in order to check them also on an external monitor.

### Selecting the Output Signal

Operating modes: CAMERA MEDIA | RAW MP4 XF-AVC

1 Open the [SDI Output] submenu.

**MENU** ➤ [Y 2] System Setup ➤ [SDI Output]

2 Select the desired option and then press the joystick.

#### Options

[2048x1080/1920x1080]: Outputs video with a resolution of 2048x1080 or 1920x1080.

[1920x1080]: Outputs 1920x1080 (Full HD) video. When the horizontal resolution of the recording video configuration is 4096 or 2048, the image will be displayed letterboxed.

## Setting the 3G-SDI Mapping Level

Operating modes: CAMERA MEDIA | RAW MP4 XF-AVC

1 Open the [3G-SDI Mapping] submenu.

**MENU** ➤ [🔧 2 System Setup] ➤ [3G-SDI Mapping]

2 Select the desired option and then press the joystick.

- You can select a video output signal compliant with Level A or Level B of the SMPTE ST 425-1 standard.

## Preparations for Recording 2K Video Using an External Recorder

You can connect an external video recorder to the camera's SDI terminal to record 2K video. Refer also to the external recorder's instruction manual for details on how to record.

For details about the audio channels that are output, refer to *Audio Output* (📖 158).

Operating modes: CAMERA MEDIA | RAW MP4 XF-AVC

### **i** NOTES

- Depending on the external recorder, you may not be able to record at the desired video configuration.
- After you connect the camera to the external recorder, make a test recording first to check that audio and video are recorded correctly on the external recorder.
- You can set **MENU** ➤ [🔧 4 Recording/Media Setup] ➤ [Rec Command] to [On] to use the camera's REC button to control also the recording operation of an external recorder connected to the SDI terminal. However, this function cannot be used when a special recording mode other than pre-recording is activated.

## Using the HDMI OUT Terminal

The HDMI™ OUT terminal also offers a digital connection and outputs both a video and audio signal. You can output also the camera's time code signal and onscreen displays (including onscreen markers)\*. The audio output signal will be 2-channel linear PCM audio (16-bit, 48 kHz sampling). When recording with 4-channel audio, you can select which audio channels to output (📖 158).

\* Not available for 4K clips (3840x2160) recorded at 59.94P or 50.00P.

### Selecting the Output Signal in CAMERA Mode

When the camera is in CAMERA mode, you can select the maximum resolution output and whether to output the time code from the HDMI OUT terminal.

Operating modes: CAMERA MEDIA | RAW MP4 XF-AVC

1 Open the [HDMI Max Res.] submenu to select the maximum resolution.

**MENU** ➤ [🔧 2 System Setup] ➤ [HDMI Max Res.]

2 Select [3840x2160] or [1920x1080] and then press the joystick.

3 Open the [HDMI Time Code] submenu to output the time code.

**MENU** ➤ [🔧 4 Recording/Media Setup] ➤ [HDMI Time Code]

4 Select [On] and then press the joystick.

## Selecting the Output Signal in MEDIA Mode

When the camera is in MEDIA mode, you can select the maximum resolution output from the HDMI OUT terminal.

Operating modes: CAMERA | MEDIA | RAW MP4 XF-AVC

1 Open the [HDMI Max Res.] submenu.

**MENU** [ 2] System Setup [HDMI Max Res.]

2 Select [3840x2160] or [1920x1080] and then press the joystick.

### NOTES

- The HDMI OUT terminal is for output only. Do not connect the camera to another device's output terminal using the HDMI OUT terminal as this will cause a malfunction.
- Correct operation cannot be guaranteed when connecting the camera to DVI monitors.
- Video may not be output correctly depending on the monitor. In such case, use another terminal.
- You can set both **MENU** [ 4] Recording/Media Setup [Rec Command] and [HDMI Time Code] to [On] to use the camera's REC button to control also the recording operation of an external recorder connected to the HDMI OUT terminal. The camera's time code signal will be output as well.
- The time code will not be output from the HDMI OUT terminal in the following cases.
  - During MEDIA mode.
  - During SD output.
  - During slow motion recording.
  - During interval recording.
  - During frame recording.

## Setting the Scan Mode of the Output Signal

You can set the scan mode of the video signal output from the SDI terminal or HDMI OUT terminal.

Operating modes: CAMERA | MEDIA | RAW MP4 XF-AVC

1 Open the [SDI/HDMI Scan Mode] submenu.

2 Select [P] or [PsF] and then press the joystick.

## Outputting Simultaneously from the HDMI OUT Terminal and SDI Terminal

The camera can output video signals simultaneously from the HDMI OUT terminal and SDI terminal. Perform this operation in the index screen while in MEDIA mode.

Operating modes: CAMERA MEDIA | RAW MP4 XF-AVC

Enable SDI output.

1 Open the [SDI Output Always On] submenu.

**MENU** ➤ [F 2] System Setup ➤ [SDI Output Always On]

2 Select [On (Linked to VIDEO Term.)] and then press the joystick.

### NOTES

#### About output from the SDI terminal when SDI output is always on

- The video output configuration is 1920x1080 60.00P (when 24.00 Hz) / 59.94P (when 59.94 Hz) / 50.00P (when 50.00 Hz) YCbCr 4:2:2 8bit.
- Each assistance display is linked with the settings for the VIDEO terminal.
- The audio signal, time code signal, and recording commands are not output.
- Pressing the MIRROR button does not change the displayed image. When the display of the LCD monitor is inverted horizontally and vertically, the screen display is cleared.

## HDR Output

When you record RAW clips, the camera can output high dynamic range (HDR) video compliant with the ITU-R BT.2100(HLG) or ITU-R BT.2100(PQ) standard from the SDI terminal or HDMI OUT terminal. The signal output will use narrow range coding.

Operating modes: CAMERA MEDIA | RAW MP4 XF-AVC

1 Open the [HDR/LUT] screen.

**MENU** ➤ [ HDR 1] Custom Picture/HDR ➤ [HDR/LUT]

2 Select [HDR: Off] and then press the joystick.

3 Push the joystick left/right to select [HDR: HLG] or [HDR: PQ] and then press the joystick.

- Select [HDR: Off] to turn off HDR output.

## Applying a LUT to Screens/Video Outputs

While recording using special gamma curves, you can apply a LUT to video output from the SDI terminal, VIDEO terminal or viewfinder ([C200] only). When a LUT is applied, the displayed image will look as if a standard gamma curve were used, making it easier to check the image on the display device used. To check the image on an external monitor, you will need a monitor that is compatible with the video's color space.

### Available LUT options by gamma curve

Available LUTs depend on the gamma curve used, whether it was set through one of the **MENU** ➤

[C<sub>HDR</sub>] 1 Custom Picture/HDR] ➤ [Preset] settings or through the individual **MENU** ➤

[C<sub>HDR</sub>] 1 Custom Picture/HDR] ➤ [Gamma] settings.

[Gamma]	Available LUTs			
	[LUT: BT.709]	[LUT: HDR Assist. (1600%)]	[LUT: HDR Assist. (400%)]	[LUT: ACESproxy]
[Canon Log 3]	●	●	●	●
[Canon Log]	●	–	–	–
[Wide DR]	–	–	–	–

Operating modes: CAMERA MEDIA | RAW MP4 XF-AVC

1 Open the [HDR/LUT] screen.

**MENU** ➤ [C<sub>HDR</sub>] 1 Custom Picture/HDR] ➤ [HDR/LUT]

2 Push the joystick up/down to select the desired output device or terminal.

3 Press the joystick.

4 Push the joystick left/right to select the desired LUT.

- Available options depend on the output device or terminal, and the [C<sub>HDR</sub>] 1 Custom Picture/HDR] ➤ [Preset] and [Gamma] settings.
- Repeat steps 2 and 3 to select a LUT for a different output device or terminal.
- The gamma curve and color space of the video output will change.
- If a LUT is not needed, select [LUT: Off]<sup>1</sup>.

<sup>1</sup> This option is available for the VIDEO terminal and viewfinder only when [HDR: Off] is selected.

## Output by terminal/device and HDR setting

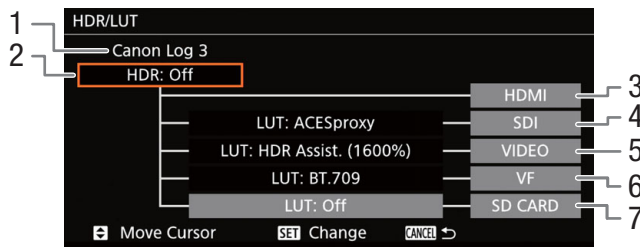

- 1 Current gamma curve set through [Preset] or [Gamma].
- 2 HDR setting
- 3 HDMI terminal output: Same as the gamma curve set through [Preset] or [Gamma].

- 4 SDI terminal output
- 5 VIDEO terminal output
- 6 Viewfinder output<sup>1</sup>
- 7 SD card output

<sup>1</sup> [C200] only.



## Options

Applied LUT	Output Settings with LUT applied		Description
	Gamma curve	Color space	
[LUT: BT.709]	Wide DR	BT.709	LUT for viewing on the screen or external monitors compatible with BT.709 specifications.
[LUT: HDR Assist. (1600%)] <sup>1</sup> , [LUT: HDR Assist. (400%)] <sup>1</sup>	Original gamma curve	BT.709	LUT for viewing HDR (high dynamic range) images on monitoring devices connected to the VIDEO terminal. The LUT follows the BT.2100 transfer function to convert a brightness range of 1600% or 400% respectively into output the same as video displayed on an HDR-compatible display.
[LUT: ACESproxy] <sup>2</sup>	ACESproxy	ACESproxy	LUT for viewing on external monitors compatible with the ACESproxy standard established by ACES (Academy Color Encoding System). The signal output will use full range coding.
[LUT: Off]	–	–	No LUT applied.

<sup>1</sup> Available only for output from the VIDEO terminal and the camera's viewfinder (C200 only).

<sup>2</sup> Only when [C<sub>HDR</sub> 1 Custom Picture/HDR] ► [Preset] is set to [Canon Log 3]. Available only for SDI output.

### NOTES

- When you apply the [LUT: ACESproxy] LUT to the SDI terminal, it will output ACESproxy video data. Using a compatible monitor, you can perform on-set color grading and check the image after color correction as you continue shooting.
- If you set an assignable button to [LUT: All] (125), you can press the button to turn on and off the LUTs applied to all output terminals/screens at once.
- If you change the **MENU** ► [C<sub>HDR</sub> 1 Custom Picture/HDR] ► [Preset] or [Gamma] setting, the LUT will be deactivated and all the terminals' output settings will be reset to [LUT: Off].

## Superimposing Onscreen Displays on Screens/Video Outputs

You can choose to superimpose onscreen displays on the video output from the SDI terminal or HDMI OUT terminal. Doing so will display the onscreen displays on an external monitor. This setting will not affect your recordings.

Operating modes: CAMERA MEDIA | RAW MP4 XF-AVC

### 1 Open the [OSD Output] submenu.

**MENU** ► [1] 6 Monitoring Setup<sup>1</sup> ► [OSD Output]

### 2 Select [On] and then press the joystick.

- **DISP** appears on the right of the screen (only if [1] 6<sup>1</sup> Monitoring Setup) ► [Custom Display 2] ► [OSD Output] is set to [On]).

<sup>1</sup> **C200B** Appears on the previous page in the menu.

### NOTES

- When the video output from the HDMI OUT terminal is 4K (3840x2160) recorded at 59.94P or 50.00P, the onscreen displays will not be superimposed on the video.
- If you set an assignable button to [OSD Output] (125), you can press the button to turn on and off the superimposing of onscreen displays on video output.

## Audio Output

The camera can output audio from the SDI terminal, HDMI OUT terminal,  (headphone) terminal or speaker\*. When recording with 4-channel audio, you can select which two channels of the 4 audio channels recorded with the clip will be output from the terminals and speaker.

\* Only monaural output is available for the speaker.

### Audio output configuration

Recorded audio configuration		Audio output during recording/playback	
Audio format	Audio bit depth or bit rate	SDI terminal	HDMI OUT terminal <sup>1</sup>
4-channel linear PCM	24 bit or 16 bit	4-channel linear PCM 24 bit	2-channel linear PCM 16 bit
2-channel MPEG-2 AAC-LC	256 kbps		

<sup>1</sup> You can select the two channels to be output with the procedure below.

Operating modes: CAMERA | MEDIA\* | RAW | MP4 | XF-AVC





\* Not available for the SDI terminal.

#### 1 Open the audio channel selection submenu of the desired terminal.

**MENU**  [  ] **4** [Audio Setup]<sup>1</sup>  [Monitor Channels] (headphones or speaker) or [HDMI OUT Channels] (HDMI OUT terminal)

<sup>1</sup> For MEDIA mode, page **1**.

#### 2 Select the desired option and then press the joystick.

- The audio channels selected for output will appear on the right of the screen (only when **MENU**  [  ] **6** [Monitoring Setup]<sup>1</sup>  [Custom Display 2]  [Monitor Channels] is set to [On]).

<sup>1</sup> **C200B** Appears on the previous page in the menu.

### Options

All of the following settings are available for [Monitor Channels]; only [CH1/CH2] and [CH3/CH4] are available for [HDMI OUT Channels].

Setting	Audio output	
	L	R
[CH1/CH2]	CH1	CH2
[CH1/CH1]	CH1	CH1
[CH2/CH2]	CH2	CH2
[CH1+2/CH1+2]	CH1+CH2 mixed	CH1+CH2 mixed
[CH3/CH4]*	CH3	CH4
[CH3/CH3]*	CH3	CH3
[CH4/CH4]*	CH4	CH4
[CH3+4/CH3+4]*	CH3+CH4 mixed	CH3+CH4 mixed
[CH1+3/CH2+4]*	CH1+CH3 mixed	CH2+CH4 mixed

\* CAMERA mode only. Not available when **MENU**  [  ] **2** [Recording/Media Setup]  [Audio Format (MP4)] is set to [AAC 16 bit 2CH].

### NOTES

- If you set an assignable button to [Monitor Channels] ( 125), you can press the button to toggle between the audio channel output options.

## Working with Clips on a Computer

Canon offers software applications as free downloads that allows you to save MP4 clips and XF-AVC clips recorded with the camera on a computer, develop RAW clips, and more.

### Saving MP4 Clips

You can use the software Data Import Utility to save your MP4 clips. Refer to PIXELA's website below (English only) to download the software and for the latest information on it. For other inquires regarding the software, consult a Canon Service Center.

[http://www.pixela.co.jp/oem/canon/e/index\\_biz.html](http://www.pixela.co.jp/oem/canon/e/index_biz.html)

#### Saving Clips Using Data Import Utility:

- Save clips to the computer using an SD card reader.
- Join relay clips (📄 51) that were saved on separate SD cards and save them as a single clip.
- Join multiple video stream files of a single clip split because of the 4 GB maximum file size restriction and save them as a single clip.

For more details, including system requirements and how to install the software, check the Data Import Utility Software Guide, a PDF file in the [Manual] folder of the downloaded compressed file that contains the software.

### Saving XF-AVC Clips

You can use Canon XF Utility to save and organize XF-AVC clips on a computer and the Canon XF plugins to easily use the clips directly from major non-linear editing (NLE) applications. The software and plugins are available as free downloads from your local Canon Web site. Check the download page for the system requirements and the latest information about the software.

You will find detailed instructions about installing and uninstalling the software in the "Read This First" PDF file included in the compressed file you will download from the Web site. For details about using the software, refer to the instruction manual (PDF file) that is installed with the software.

**Canon XF Utility:** Software application that allows you to save clips on a computer, check, play back and organize clips and grab still frames from clips. The software is available for Windows and macOS (OS X).

**Canon XF Plugin for Avid Media Access:** Plugin that allows you to easily import clips from a recording media or a local folder in the computer to the compatible version of Avid Media Composer (an NLE application compatible with Avid Media Access), directly from within the application. The plugin is available for the Windows and macOS (OS X) versions of Avid Media Composer.

## Developing RAW Clips

Use the Cinema RAW Development software to develop RAW clips recorded on a CFast card. After you develop the clips and export them to a full-quality standard file type such as DPX, they will be ready for color grading. Alternatively, you can use the Canon RAW Plugin to easily use RAW clips unaltered (in RAW) directly from major non-linear editing (NLE) applications. The software and plugin are available as free downloads from your local Canon website. Check the download page for the system requirements and the latest information about the software.

You will find detailed instructions about installing and uninstalling the software in the “Read This First” PDF file included in the compressed file you will download from the website. For details about using the software, refer to the instruction manual (PDF file) that is installed with the software.

**Cinema RAW Development:** Software application that allows you to develop, play back and export RAW clips. The software is available for Windows and macOS.

**Canon RAW Plugin for Avid Media Access:** Plugin that allows you to easily import RAW clips from a storage device or a local folder in the computer to the compatible version of Avid Media Composer (an NLE application compatible with Avid Media Access), directly from within the application. The plugin is available for the Windows and macOS versions of Avid Media Composer.

**Canon RAW Plugin for Final Cut Pro X:** Plugin that allows you to easily import RAW clips from a storage device to Apple Final Cut Pro X, directly from within the application. The plugin is available for macOS.

## About the Network Functions

You can connect the camera to a wireless network using Wi-Fi (📖 162) or to a wired network using an Ethernet cable (📖 168).

### Network functions and connection types

Network function	Description	Wired network	Wi-Fi		📖
			Infrastructure <sup>1</sup>	Camera Access Point <sup>2</sup>	
Browser Remote	Control the camera remotely from the Web browser of a connected device.	●	–	●	170
FTP File Transfer	Transfer clips recorded with the camera to another device connected to the network using the FTP protocol.	●	●	–	182

<sup>1</sup> Connection to a Wi-Fi network via an external access point (wireless router, etc.)

<sup>2</sup> Direct connection to one Wi-Fi-enabled device where the camera serves as the Wi-Fi access point.

### Before using the network functions

- The instructions in this chapter assume you already have a correctly configured and working network, network device(s) and/or Wi-Fi access point. If necessary, refer to the documentation provided with the network devices you plan to use.
- Configuring the network settings requires adequate knowledge about configuring and using wired (Ethernet) and/or wireless (Wi-Fi) networks. Canon cannot provide support regarding network configurations.

### ! IMPORTANT

- Data transmitted over networks is not encrypted.
- Canon shall not be liable for any loss of data or damage resulting from incorrect network configuration or settings. Additionally, Canon shall not be liable for any loss or damage caused by the use of network functions.
- Using an unprotected Wi-Fi network can expose your data to monitoring by unauthorized third parties. Also, the camera is shipped with some default passwords. Changing the initial settings is recommended.

### i NOTES

- **About the Wi-Fi antenna:** When using the camera's Wi-Fi functions, do not cover the Wi-Fi antenna with your hand or other object. Covering it may interfere with wireless signals.
- When connecting the camera to a wireless network using Wi-Fi, we recommend removing the camera grip to help ensure a stable connection.
- Do not open the card slot covers of any recording media while using network functions.
- Do not lay cables connected to the SDI terminal or HDMI OUT terminal or unit cables near the Wi-Fi antenna. Doing so may negatively affect the wireless communication over Wi-Fi.

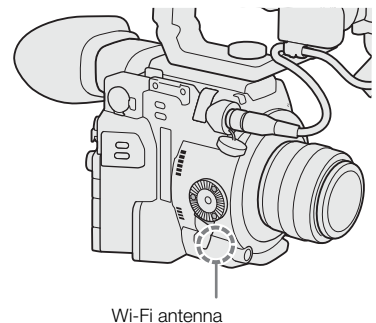

## Connecting to a Wi-Fi Network

The camera is Wi-Fi certified and can connect to a Wi-Fi network using an external access point (wireless router) or can itself serve as a Wi-Fi access point. The camera can connect to wireless routers (access points) and network devices compliant with the 802.11a/b/g/n protocol and that are Wi-Fi certified (bear the logo shown on the right).



Note that using an unprotected Wi-Fi network can expose your data to monitoring by unauthorized third parties. Be aware of the risks involved.

You can connect the camera to the network in Infrastructure mode, using an access point (wireless router etc.), or in Camera Access Point mode, directly to a network device. The type of connection you can use, depends on the network function you wish to use (📖 161).

For an Infrastructure connection, the camera offers 4 ways to configure an access point and the method you use will depend on the type and specifications of the access point and network you plan to use.

**Camera Access Point:** When shooting in a location where there are no access points available, the camera can serve as a wireless access point\*. Wi-Fi enabled devices will be able to connect to the camera directly.

\* Limited only to the connection between the camera and supported Wi-Fi enabled devices. The functionality is not the same as that of commercially available access points.

### Infrastructure connection:

**WPS (button):** If your wireless router supports Wi-Fi Protected Setup (WPS), setup will be easy and require minimal configuring and no passwords. To check if your wireless router has a WPS button and for details about how to activate the Wi-Fi protected setup, refer to the instruction manual of your wireless router.



**WPS (PIN code):** Even if your wireless router does not have a dedicated WPS button, it may support WPS using a PIN code instead. For setup using a PIN code, you will need to know in advance how to activate the wireless router's WPS function. For details refer to the instruction manual of your wireless router.

**Searching for Access Points:** If your access point does not support the WPS function or you cannot activate it, you can have the camera search for access points in the area.

**Manual Setup:** If the access point you want to use has stealth mode activated and it cannot be automatically detected by the camera, you can enter all the necessary settings manually. This requires more advanced knowledge of Wi-Fi and network settings.

### ! IMPORTANT

- Depending on the country/region of use, some restrictions on outdoor use or camera access point connections may apply when operating the IEEE802.11a/n wireless standard in the 5 GHz band. For details see REGIONS OF USE in the supplied Basic Guide.

## Camera Access Point

In this mode the camera itself serves as a wireless access point to which other Wi-Fi-enabled devices can connect. Follow the instructions on the screen to complete the procedure.

### 1 Open the connection method selection submenu.

**MENU** [Globe] [1] Network Settings] [Connection Settings] select the desired configuration number\* [Edit]

\* You can save up to 4 network configuration profiles in the camera. Push the joystick up/down to select the configuration number.

### 2 Select [Camera Access Point] and then press the joystick.

### 3 To enter the [SSID] (network name), select [Input] and then press the joystick.

- Enter the SSID (network name) the camera will use as a Wi-Fi access point using the keyboard screen ( 35).
- The network name is needed to connect the network device to the camera. If necessary, write it down.
- After entering the network name, select [OK] and then press the joystick.

### 4 Select the frequency band for the Wi-Fi connection.

[5 GHz] or [2.4 GHz] press the joystick.

- For Europe: Because only the 2.4 GHz frequency band is available for Camera Access Point mode, skip to step 5.

### 5 Select the channel and then press the joystick.

- Available channels will be different depending on the wireless connection mode selected in the previous step.

### 6 Select the encryption method and then press the joystick.

- If you selected [Open/No encryption], skip to step 8. If you selected [WPA2-PSK/AES], continue with step 7.

### 7 Enter the password of the access point.

- Enter the desired text using the keyboard screen ( 35).
- This encryption key (password) is needed to connect the network device to the camera. If necessary, write it down.

### 8 Continue with the procedure to configure the IP address assignment ( 163).

## Configuring the IP Address Settings

At this point you need to configure the TCP/IP settings for the camera to be able to connect to a Wi-Fi network. If you need to configure the TCP/IP settings manually, consult the network administrator to obtain the relevant information.

### 1 Select the method for assigning the IP address: Select [Automatic] or [Manual] and then press the joystick.

- If you selected [Automatic], the IP address will be assigned automatically. Continue with the procedure to review and save the configuration ( 164).

### 2 Enter the IP address.

- Push the joystick up/down to select a value for the first field and then press the joystick to move to the next field. After completing the four fields of an address, select [Set] and then press the joystick to confirm the address.

### 3 Enter the [Subnet Mask] in the same way.

- For Camera Access Point connections, the rest of the procedure is not necessary. Continue with the procedure to review and save the configuration ( 164).

### 4 Enter the [Default Gateway], [Primary DNS Server] and [Secndry DNS Server] using the method described in step 2.

- After entering the secondary DNS server, continue with the procedure to review and save the configuration ( 164).

### Saving the Configuration

1 Review the access point's configuration and then press the joystick.

- Push the joystick left/right to review additional settings before pressing the joystick.

2 To change the [Network Configuration Name], select [Input] and then press the joystick.

- If you wish, you can give the network configuration profile a more descriptive name to make it easier to identify. Enter the desired name using the keyboard screen (📖 35).

3 Select [OK] and then press the joystick to save the network configuration.

4 When the confirmation screen appears, press the joystick.

### Connecting in Infrastructure Mode

1 Open the connection method selection submenu.

**MENU** ➤ [🌐 1 Network Settings] ➤ [Connection Settings] ➤ select the desired configuration number\* ➤ [Edit]

\* You can save up to 4 network configuration profiles in the camera. Push the joystick up/down to select the configuration number.

2 Select [Infrastructure] and then press the joystick.

3 Select the desired network setup method and then press the joystick.

- Continue the setup with the procedure corresponding to the method you wish to use (see the reference pages below).

[WPS: Button] (📖 165)

[WPS: PIN Code] (📖 165)

[Search for Access Points] (📖 166)

[Manual] (📖 167)



## Wi-Fi Protected Setup (WPS)

Wi-Fi Protected Setup (WPS) is the easiest way to set up a Wi-Fi access point. You can do simply by pushing a button (if the access point (wireless router) you want to connect to has a WPS button) or using a PIN code issued by the camera.

### Wireless Routers with a WPS Button

**1 Press and hold the WPS button on the wireless router.**

- The length of time required to hold down the WPS button depends on the wireless router. Refer to the instruction manual of your wireless router and make sure the wireless router's WPS function is activated.

**2 Within 2 minutes, press the joystick.**

- While [Connecting] appears on the screen, you can press the joystick to cancel the operation.

**3 Continue with the procedure to configure the IP address assignment (📖 163).**

### NOTES

- The [WPS: Button] method may not work correctly if there are several active access points in the area. In such case try using [WPS: PIN Code] or [Search for Access Points] (📖 166) instead.

### WPS using a PIN code

**1 After you select [WPS: PIN Code], the camera will generate and display an 8-digit PIN code on the screen.**

**2 Enter the PIN code into the wireless router's WPS (PIN code) setup screen.**

- For most wireless routers, you must use a Web browser to access the setup screen.
- For details about how to access your wireless router's settings and activate the Wi-Fi Protected Setup (WPS) using a PIN code, refer to the instruction manual of your wireless router.

**3 Within 2 minutes, press the joystick.**

- While [Connecting] appears on the screen, you can press the joystick to cancel the operation.
- After the connection is correctly established, the screen to configure the IP address will appear.

**4 Continue with the procedure to configure the IP address assignment (📖 163).**

### Searching for Access Points

The camera will automatically detect access points in the vicinity. After you select the desired access point, you only need to enter the selected network's password to connect the camera. For details about the access point's network name (SSID) and password refer to the wireless router's instruction manual or consult the network administrator in charge of the access point.

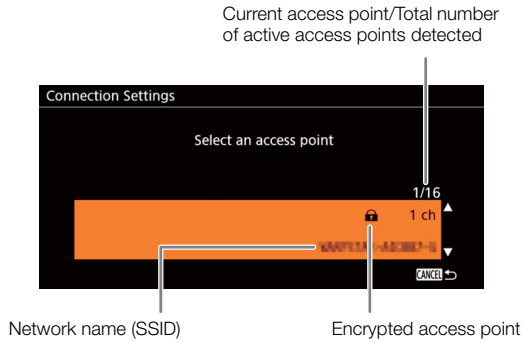

- 1 After you select [Search for Access Points], the camera will search for active access points in the vicinity and display a list of available options on the screen.
- 2 Push the joystick up/down to select the desired access point and then press the joystick.
- 3 If necessary, select the WEP index key.
  - This step is only necessary if the Wi-Fi network's authentication method is set to [Shared Key] or if the encryption method is set to [WEP].
- 4 To enter the [Encryption Key] (password), select [Input] and then press the joystick.
  - Enter the password of the selected Wi-Fi network using the keyboard screen (📖 35).
- 5 Continue with the procedure to configure the IP address assignment (📖 163).

## Manual Setup

If you prefer, you can enter manually the details of the Wi-Fi network you want to connect to. Follow the instructions on the screen to complete the procedure.

### 1 To enter the [SSID] (network name), select [Input] and then press the joystick.

- Enter the SSID (network name) of the selected Wi-Fi network using the keyboard screen (📖 35).
- The network name is needed to connect the network device to the camera. If necessary, write it down.
- After entering the network name, select [OK] and then press the joystick.

### 2 Select the Wi-Fi network's authentication method and then press the joystick.

- If you selected [Shared Key], skip to step 4.

### 3 Select the Wi-Fi network's encryption method and then press the joystick.

- If the authentication method is [Open], you can select [WEP] and continue to step 4, or [No Encryption] and skip to step 6.
- If the authentication method is [WPA-PSK] or [WPA2-PSK], you can select [TKIP] or [AES].

### 4 If necessary, select the WEP index key.

### 5 To enter the [Encryption Key] (password), select [Input] and then press the joystick.

- Enter the password of the selected Wi-Fi network using the keyboard screen (📖 35).

### 6 Continue with the procedure to configure the IP address assignment (📖 163).



#### NOTES

Valid passwords vary depending on the encryption method.

64-bit WEP encryption: 5 ASCII characters or 10 hexadecimal characters.

128-bit WEP encryption: 13 ASCII characters or 26 hexadecimal characters.





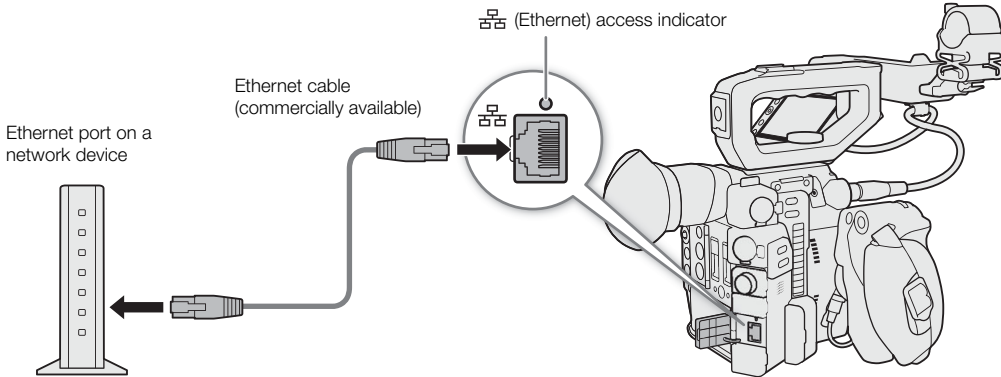

AES / TKIP encryption: 8 to 63 ASCII characters or 64 hexadecimal characters.

\* Note: ASCII characters include the numbers 0 to 9, the letters a to z and A to Z and some punctuation marks and special symbols. Hexadecimal characters comprise the numbers 0 to 9 and the letters a to f and A to F.

## Connecting to a Wired (Ethernet) Network

Connect the camera to a router or other device connected to a wired (Ethernet) network using a commercially available Ethernet cable. Use Category 5e, shielded twisted pair (STP) Ethernet cables compatible with Gigabit Ethernet (1000BASE-T) and with good shielding capability.



- 1 Connect a commercially available Ethernet cable to the  (Ethernet) terminal on the camera and an Ethernet port on a network device.
- 2 Open the connection method selection submenu.  
**MENU**  [  1 Network Settings ]  [Connection Settings]  select the desired configuration number\*   
[Edit]
- \* You can save up to 4 network configuration profiles in the camera. Push the joystick up/down to select the configuration number.
- 3 Select [Ethernet] and then press the joystick.
- 4 Continue with the procedure to configure the IP address assignment (  163).

## Selecting a Network Connection

You can save up to 4 network configuration profiles. If you just saved a new network configuration, it will already be automatically selected so follow this procedure to select a different configuration profile.

1 Open the [Connection Settings] screen.

**MENU** ➤ [🌐 1 Network Settings] ➤ [Connection Settings]

2 Select the desired configuration number and then press the joystick.

3 Select [OK] and then press the joystick.

## Checking and Changing Network Settings

You can check and, if necessary, edit the settings of the currently selected network configuration profile even after the initial setup. Changing settings manually requires more advanced knowledge of Wi-Fi and network settings.

1 Open the configuration profile selection submenu.

**MENU** ➤ [🌐 1 Network Settings] ➤ [Connection Settings]

2 Select the desired configuration number and then press the joystick.

3 Select [Edit] and then press the joystick.

4 Select [Infrastructure], [Camera Access Point] or [Ethernet].

- Continue with the procedure corresponding to the network connection method being used.
  - For infrastructure connections, follow the procedure for *Connecting in Infrastructure Mode* starting from step 3 (📖 164).
  - For camera access point connections, follow the procedure for *Camera Access Point* starting from step 3 (📖 163).
  - For Ethernet connections, follow steps 1 and 4 of the procedure for *Connecting to a Wired (Ethernet) Network* (📖 168).

## Browser Remote: Controlling the Camera from a Network Device

After connecting the camera to a network (Wi-Fi or wired using the  (Ethernet) terminal), you can operate the camera remotely via Browser Remote, a Web browser application that can be accessed using the Web browser on network devices\* (via Wi-Fi or with an Ethernet connection). Using Browser Remote, you can check the camera's live view image and control various recording settings. On the Browser Remote screen, you can also check the remaining recording time on the recording media, power source levels and the camera's time code.

\* For details about compatible devices, operating systems, Web browsers, etc., please visit your local Canon website.

### Setting Up Browser Remote

You can set a unique camera identification code and designate the port that the Browser Remote application should use when accessing the camera through network. The port number (HTTP protocol) used by Browser Remote is usually set to port 80, but you can change it if necessary. The camera ID will appear on the Browser Remote screen, making it easy to identify which camera the application is controlling in case of a multi-camera shooting setup.

Operating modes: CAMERA MEDIA | RAW MP4 XF-AVC

#### Changing the Port Number and Camera ID

1 Open the [Browser Remote Settings] submenu.

**MENU**    Network Settings  [Browser Remote Settings]

2 To change the port number, select [Port No.] and then press the joystick.

- To change the camera ID, skip to step 5.

3 Push the joystick left/right to select the digit to change and then push the joystick up/down to change the value.

- Repeat this step as necessary to change the other digits.

4 Select [Set] and then press the joystick to confirm the port number.



5 To change the camera ID, select [Camera ID] and then press the joystick.

- Enter the desired camera ID using the keyboard screen ( 35).

6 Select [OK] and then press the joystick.

#### User Settings

A user name and password are required before the Browser Remote application can access and operate the camera. You can set up to three different users and select whether you want to allow single-user operation (full control) or two-user operation (one controlling camera functions and another in charge of metadata input for XF-AVC clips).

[Full] Can access all 3 Browser Remote screens:  (main recording screen),  (metadata screen) and  (basic screen).

[Camera] Can access only the  (main recording) screen. This would be the main operator controlling the camera.

[Meta] Can access only the  (metadata) screen. This would be the person in charge of keeping the XF-AVC clip information up to date.

## Starting Browser Remote

After connecting the camera to the network, you can start the Browser Remote application on the Web browser\* of any network device\*\* connected to the same network. You can check the Browser Remote settings on the status screen (📖 196).

\* A Web browser that supports JavaScript and is enabled to accept cookies is required.

\*\* For details about compatible devices, operating systems, Web browsers, etc., please visit your local Canon website.

Operating modes: CAMERA MEDIA | RAW MP4 XF-AVC

### Preparations on the camera

1 Set an assignable button to [Status] in advance (📖 125).

2 Connect the camera to the desired network (📖 169).

- Use a Camera Access Point connection (📖 163) or Ethernet connection (📖 168).

3 Activate Browser Remote on the camera.

**MENU** ➤ [🌐 1 Network Settings] ➤ [Activate] ➤ [Browser Remote]

- With Camera Access Point connections, the camera will start functioning as a wireless access point. With Ethernet connections, connect the camera to the desired network using an Ethernet cable.
- **Remote** and the connection type icon will appear at the top of the screen. When the icons turn white, the camera is ready to accept commands from the Browser Remote application.

4 If necessary, you can check the network settings while Browser Remote is activated.

- Press the assignable button to open the status screens and push the joystick left/right to display the [Network] status screens to check the following settings.
  - [Network 1/5]: SSID for Camera Access Point connections
  - [Network 4/5]: URL for Browser Remote
  - [Network 5/5]: User name and password settings for Browser Remote (only the default password will be displayed)
- Press the assignable button to close the status screen.

### On the connected network device

1 Connect the network device to the camera.

- With Camera Access Point connections, select the camera's SSID (network name) in the Wi-Fi settings and use the password from step 4 above. With Infrastructure and Ethernet connections, connect the device to the same access point as the camera.

2 Start the Web browser on the network device.

**3 Enter the camera's URL exactly as shown on the Browser Remote information screen.**

- Enter the URL you checked previously into the Web browser's address bar.

**4 Enter the user name and password.**

- Be sure to log in with the user name and password of one of the users that were set on the camera (170). If necessary, consult the administrator who configured the camera's settings.
- The Browser Remote screen will appear. The screen displayed will differ depending on the user information used to log in.
- While Browser Remote is correctly connected to the camera, the network connection indicator's ●●●● will turn on one by one and then turn off in an endless loop.
- The camera's ID and lens information will appear on the Browser Remote screen while live view is not activated.

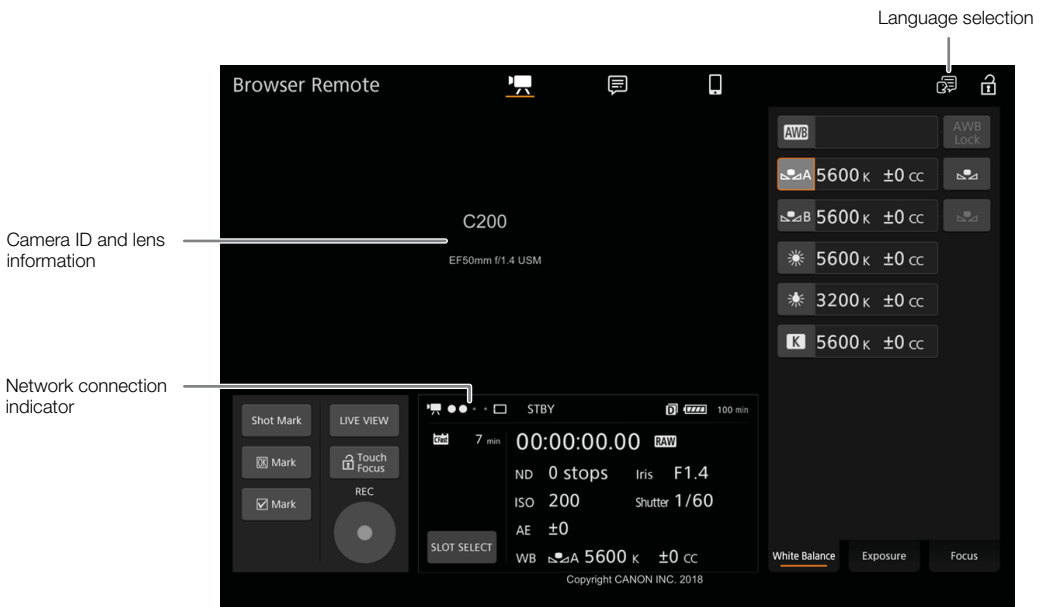

**5 Select the language for Browser Remote.**

- Click/touch the language selection icon and select the desired language from the list. Most buttons and controls emulate physical controls on the camera and are labeled in English only, regardless of the language selected.

**6 Use the Browser Remote controls to operate the camera.**

- Descriptions of the controls are given in the following pages. Detailed operation is given in each function's reference page.

**7 When you have finished using Browser Remote, turn it off on the camera**

**MENU** ➤ [Globe icon] [1] Network Settings] ➤ [Activate] ➤ [Off]

- The network icons will turn yellow and then disappear from the screen and the connection with the application will be terminated.





**i** NOTES

- The live view image will not be displayed in Browser Remote while color bars are displayed on the camera.
- Depending on the network used and the strength of the Wi-Fi signal (for Wi-Fi connections), you may notice delays in the refreshing of the live view image and other settings.
- If Browser Remote is set to a language other than the language set on network device, the application may not be displayed correctly.

### Using Browser Remote

The Browser Remote application has 3 screens: [📺] the main screen for controlling the camera remotely in recording mode, [🗨️] the metadata screen, and [📱] a basic screen that allows users only to start/stop recording using a smartphone or other device with a small screen. The screen displayed will differ depending on the user information used to log in.

The following sections explain how to use the Browser Remote controls. For detailed information and applicable restrictions about the functions themselves, please refer to each function's explanation.

**i** NOTES

- Browser Remote does not support multi-touch gestures.

### The Main Remote Recording Screen [📺]

\* [Full]/[Camera] users only.

When using a computer, tablet and other devices with larger screens, this screen offers all the controls available for operating the camera remotely via Browser Remote.





\* Onscreen display/indication only. The content or value cannot be changed using Browser Remote.

**1 Live view screen**

Shows the camera's live view image. When the live view image is not turned on, the camera ID and lens information will appear here.

**2 Status indicators**

- : Wi-Fi connection indicator. While Browser Remote is correctly connected to the camera, the dots will keep turning on and off in a loop.
- STBY, etc. : Recording operation (same as on the camera, [book icon 59](#)).
- STBY ➔, REC ➔: Output recording command ([book icon 188](#)).
- : Appears during double slot recording ([book icon 51](#)).
- , etc. : Remaining battery charge ([book icon 60](#))

**3 [LIVE VIEW] button**

Touch the button to display the camera's live view image on the Browser Remote screen.

**4 Clip marks and shot marks buttons**

When recording, you can flag important frames in a clip by adding shot marks or tag important clips by adding clip marks ([book icon 108](#)).

To add a shot mark: While recording a clip, touch [Shot Mark].

To add a clip mark: After recording a clip, touch [ Mark] to add an  mark to the clip, or [ Mark] to add a  mark to the clip.



**(i) NOTES**

- Depending on the Wi-Fi connection's strength, there may be delay of 0.5 seconds or more between the frame shown when you touch/click the button and the frame to which the camera adds the shot mark.

**5 [ Touch Focus] button**

Touch the button to unlock (enable) the touch focus mode.

**6 Browser Remote screen selection ([Full] user only)**

Touch [] to open the main remote recording screen, [] to open the metadata screen ([book icon 179](#)) or [] to open the basic screen for devices with a small screen ([book icon 181](#)).

**7 Language selection**

Most of the application's controls emulate physical buttons on the camera and appear in English only, regardless of the language selected.

**8 Key lock button**

Touch the icon to lock the Browser Remote screens in order to prevent settings from being changed inadvertently.

**9 [REC] button**

Touch the button to start recording. While recording, the center of the button turns red.  
Touch the button again to stop recording.

**10 Recording media selection and approximate remaining recording time**

The currently selected recording media is indicated with a  mark next to the icon.  
Remaining recording times are approximate and calculated based on the current video configuration used.

**11 [SLOT SELECT] button**

Touch the button to select the other SD card when both SD card slots contain a SD card.

## 12 Current camera settings

This panel displays an overview of the camera settings currently used. You can change camera settings with the controls in the detailed camera settings panel (14) on the right.

[ND]: ND filter	[WB]: White balance
[ISO]/[Gain]: ISO speed or gain value	[Iris]: Aperture value
[AE]: AE shift	[Shutter]: Shutter speed

## 13 Recording format (📖 64)

## 14 Time code (same as on the camera)

## 15 Detailed camera settings panel (📖 175)

Touch one of the tabs at the bottom to select the camera settings you wish to adjust:

[White Balance]:	White balance mode and related settings.
[Exposure]:	Exposure related settings—aperture, shutter speed and ISO/speed gain.
[Focus]:	Focus related settings.
[Zoom]:	Zoom operation (only when using a compatible lens, 📖 230).

## The Main Remote Recording Screen: Detailed Camera Settings

The following sections explain how to use the controls in the detailed camera settings panel. For detailed information and applicable restrictions about the functions themselves, please refer to each function’s explanation.



### To change the white balance

Touch the [White Balance] tab in the detailed camera settings panel.

#### 1 Auto white balance button

Touch [**AWB**] to set the camera to auto white balance (AWB) mode.

#### 2 Custom white balance buttons

Touch [A] or [B].

To register a custom white balance: Point the camera at a gray card or white object with no pattern so it fills the center of the monitoring/live view screen and touch []. Use the same lighting conditions you plan to use when recording.

During the procedure, the icon in the button will flash quickly. When it stops flashing, the procedure is completed and the custom white balance will be applied.

#### 3 Preset and user-set white balance settings

Touch a button to apply the corresponding white balance settings as shown in the button.

#### 4 [AWB Lock] button

When auto white balance is activated, touch the button to lock the current white balance settings and keep them when you change the subject.

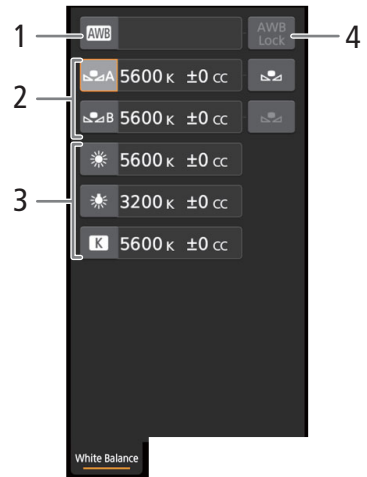

### To adjust the color temperature or color compensation (CC) value

Select a white balance setting other than [**AWB**], [A] or [B].

- 1 Touch the right part of the white balance button (current color temperature and CC value).
- 2 Touch the [K] tab (color temperature) or [CC] tab (color compensation value) and select the desired value from the list.
  - If necessary, repeat this step to adjust the other setting.

**To change exposure related settings**

Touch the [Exposure] tab in the detailed camera settings panel.

**1 ND Filter buttons**

- To use the extended ND range options, touch [Extended Range On] or [Extended Range Off].
- Touch [-] or [+] to change the density of the ND filter (displayed above the buttons). You can also touch the current ND filter setting and select the desired setting from a list of options.

**2 Aperture related buttons** (only when using a compatible lens,  230)

- To let the camera adjust the aperture automatically, touch [Manual] and select [Automatic] instead. No further settings are necessary. To adjust the aperture manually, select [Manual] and use the aperture-related controls as described below.
- To change the adjustment increment, touch [1/3] and select the desired iris increment ([1/2], [1/3], [1/2 Fine] or [1/3 Fine]). With [1/2 Fine] or [1/3 Fine] you can use the smallest aperture increment allowed by the lens. (However, the aperture value displayed will be the closest value in the selected increment scale.)
- Touch [-] or [+] to change the aperture value (displayed above the buttons). You can also touch the current aperture value and select the desired value from a list of options.
- When an EF Cinema lens is attached to the camera, the aperture value will appear as a T value.
- During manual aperture adjustment, you can also touch [PUSH AUTO IRIS] to have the camera adjust the aperture automatically once. (The manual aperture buttons will not be available at this time.)
- When using an EF Cinema lens with the built-in extender function activated, you cannot change the aperture by selecting an aperture value.

**3 ISO speed/Gain related buttons**

ISO speeds are displayed by default. To adjust the gain instead, touch [ISO] and select [Gain].

- To use the ISO speeds/gain values in the extended range, touch [Extended Range On] or [Extended Range Off].
- To change the adjustment increment, touch [1/3] (ISO speed) or [Normal] (gain) and select the desired ISO increment ([1/3] or [1]) or gain increment ([Normal] or [Fine]).
- Touch [-] or [+] to change the ISO speed/gain value (displayed above the buttons). You can also touch the current ISO speed/gain value and select the desired value from a list of options.

**4 Shutter speed related buttons**

- To change the shutter speed mode, touch [Angle] and select the desired shutter speed mode ([Speed] (standard shutter speed), [Angle], [Clear Scan], [Slow] (slow shutter speeds), or [Off]).
- To change the adjustment increment if you selected [Speed], touch [1/3] and select the desired increment ([1/3] or [1/4]).
- Touch [-] or [+] to change the shutter speed (displayed above the buttons). You can also touch the current shutter speed value and select the desired value from a list of options.

**5 AE shift buttons**

Touch [-] or [+] to change the AE shift level.

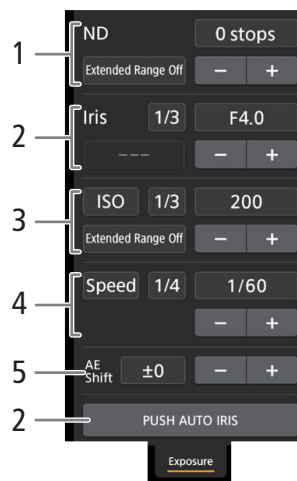

**To adjust the focus and use focus-related functions**

Touch the [Focus] tab in the detailed camera settings panel. To use the following functions, make sure that the focus mode on the lens is set to automatic (📖 80).

- If the focus mode on the lens is set to manual, you will not be able to use Browser Remote to control the focus. Depending on the lens used, remote operation may not work correctly.

**1 AF mode button**

**2 AF frame position button**

Touch the button to select the position of the AF frame. Select [Center Frame] for a fixed AF frame at the center of the live view screen, or [Selectable] to be able to touch the live view screen to select where to focus (📖 178).

**3 Face AF mode button**

Touch the button to select how the camera will focus when the Face AF function is activated and no face is detected (📖 87).

**4 [AF Speed] button**

Touch the button to select the adjustment speed of applicable lenses when using autofocus functions.

**5 [Face Detection] button**

**6 [Focus Guide] (Dual Pixel Focus Guide function) button**

**7 [ONE-SHOT AF] button (📖 177) / [AF Lock] button (📖 178)**

**8 Tracking buttons**

**9 Manual focus buttons**

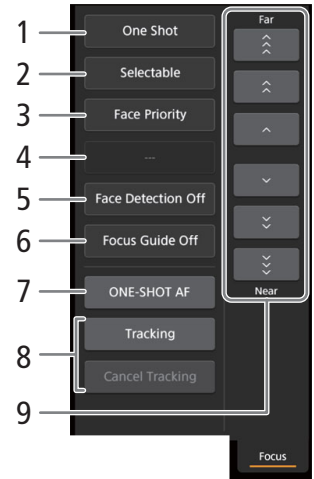

**Manual focus**

- 1 Touch the AF mode button and select [One Shot].
- 2 Touch one of the manual focus buttons on the [Near] side to focus closer or one of the controls on the [Far] side to focus farther away. There are three levels of adjustment - [ ^ ]/[ v ] is the smallest and [ ^ ]/[ v ] is the largest.

**Focus Guide**

- 1 Touch the [Focus Guide] button.
- 2 Touch [On] to display the focus guide (📖 82).
  - Only one focus guide frame can be displayed on the Browser Remote live screen. If the focus guide is activated and the secondary focus guide frame is activated on the camera, the face detection and tracking functions cannot be used.

**One-shot AF**

- 1 Touch the AF mode button and select [One Shot].
- 2 Touch the [ONE-SHOT AF] button.
  - A white AF frame will appear on the live view screen and the camera will focus automatically.
  - When correct focus has been achieved, the AF frame turns green. If the camera cannot focus automatically, the AF frame will turn red.
  - When the AF frame position is set to [Selectable], you can touch inside the live view screen to select where to focus (📖 178).
  - If necessary, touch [AF Speed] to change the adjustment speed of the autofocus function.

### AF-Boosted MF

- 1 Touch the AF mode button and select [AF-Boosted MF].
  - When the focus is in the manual adjustment range, a yellow focus frame will appear on the live view screen.
  - When the AF frame position is set to [Selectable], you can touch inside the live view screen to select where to focus (📖 178).
- 2 Touch one of the manual focus buttons to focus closer ([Near] side) or farther ([Far] side) as necessary.
  - When the focus enters the automatic adjustment range, the focus frame will turn white and the camera will then finish focusing automatically.
  - When the focus is not in the automatic adjustment range or when the focus is locked with AF lock, you can focus manually.
  - If necessary, touch [AF Speed] to change the adjustment speed of the autofocus function.
  - During AF-boosted MF mode, the [ONE-SHOT AF] button will change to [AF Lock].

### Continuous AF

- 1 Touch [AF Speed] to change the adjustment speed of the autofocus function.
- 2 Touch the AF mode button and select [Continuous].
  - A white AF frame will appear on the live view screen and the camera will focus automatically.
  - When the AF frame position is set to [Selectable], you can touch inside the live view screen to select where to focus (📖 178).
  - During continuous AF mode, the [ONE-SHOT AF] button will change to [AF Lock]. Touch the [AF Lock] button to lock the focus at its current position and frame the picture as necessary. Touch the button again to release the AF lock.
  - When the focus is locked with AF lock, you can focus manually.

### Touching the screen to focus on a subject

You can touch on a subject that appears in the Browser Remote's live view screen in order to select it for focusing.

- 1 Touch the AF frame position button and select [Selectable].
- 2 Make sure the touch focus function has been unlocked and the 🔒 icon appears in the button (📖 174).
- 3 Touch the desired subject in the live view screen.
  - Depending on the focus mode used, a frame may appear on the selected subject and the camera may also focus on the subject automatically and even start tracking the subject.

### Face AF

When the face detection function is activated, the camera will detect people's faces and track the main subject even when it moves. You can use face detection with one of the autofocus functions to let the camera focus on the main subject automatically (Face AF).

- 1 Touch [Face Detection] and select [On].
- 2 If necessary, touch the Face AF mode button and select [Face Only] or [Face Priority].
  - A face detection frame will appear on the live view screen around all detected faces. The main subject is indicated with arrows (◀▶) on the sides. The camera will track the main subject as it moves.
  - Touch on the face of a different subject to select it as the main subject.
  - During continuous AF, the camera will keep focusing on the main subject's face. During one-shot AF, the camera will focus on the main subject's face when you touch [ONE-SHOT AF].

### Tracking other subjects

In addition to Face AF, you can have the camera track other moving subjects that are not faces and also combine the tracking function with one of the autofocus functions to let the camera focus on the desired subject automatically.

- 1 Touch [Tracking].
- 2 Touch the live view screen to select the subject you wish to track.
  - A tracking frame will appear on the live view screen and the camera will track the subject as it moves.
  - During continuous AF, the camera will keep focusing on the selected subject. During one-shot AF, the camera will focus on the selected subject when you touch [ONE-SHOT AF].
  - Touch [Cancel Tracking] to select a different subject, or touch [Tracking] again to end the tracking function.

### To adjust the zoom

The zoom can be adjusted only when an EF Cinema lens compatible with zoom adjustment or an EF lens compatible with the optional PZ-E1 Power Zoom Adapter is attached to the camera.

- 1 Set the lens's zoom operation change-over knob to SERVO.
  - If you are using the PZ-E1, set the zoom mode switch to PZ (Power Zoom).
- 2 Touch the [Zoom] tab in the detailed camera settings panel.
- 3 Drag the zoom slider up/down to zoom in [T] or out [W], respectively.

### NOTES

- If you operate the zoom slider slowly it may take some time until the lens starts moving.

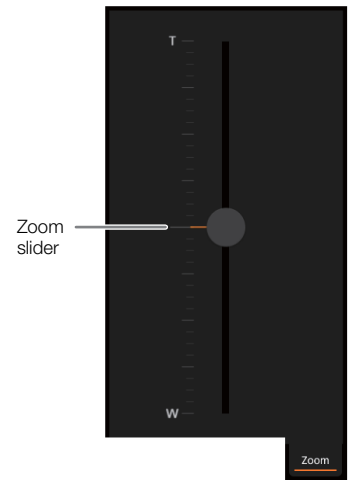

### The Metadata Screen

\* [Full]/[Meta] users only.

Using Browser Remote you can create, edit and transfer to the camera a metadata profile that can be embedded with the recorded clips. This metadata profile includes the user memo information (clip title, creator, location and description), as well as GPS information. For details, refer to *Using Metadata* ( 109).

To open the metadata screen, touch the  icon at the top of the Browser Remote screen.

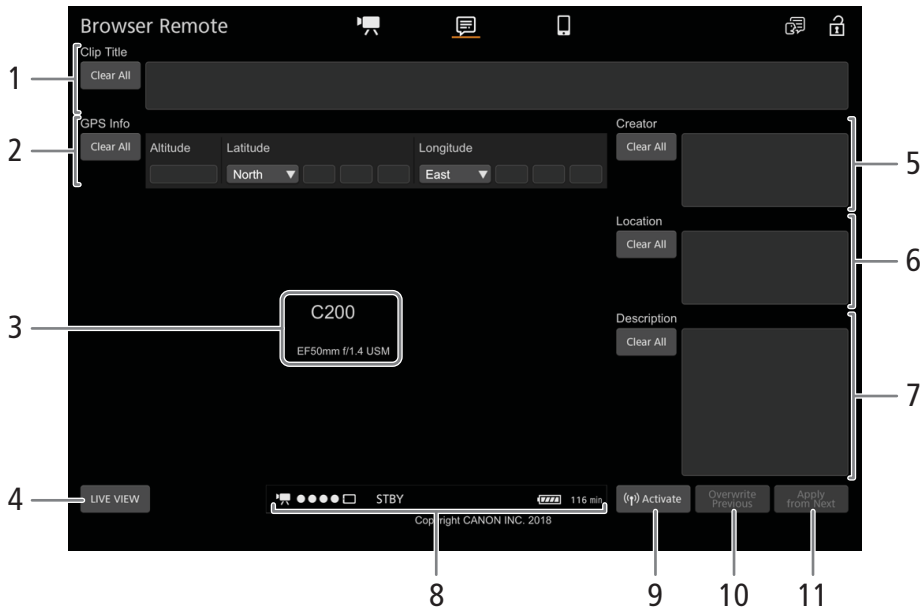

**1 Clip title**

Touch/click inside the text box and enter the desired text. To delete the text, touch [Clear All].

**2 GPS information**

To enter the altitude: Touch inside the [Altitude] text box and enter the desired value.

To enter the latitude: Touch inside one of the text boxes and enter (from left to right) the degrees, minutes and seconds values. To select a southern latitude, touch [North] and select [South] instead.

To enter the longitude: Touch inside one of the text boxes and enter (from left to right) the degrees, minutes and seconds values. To select a western longitude, touch [East] and select [West] instead.

- Touch [Clear All] to delete all the GPS-related fields at once.

**3 Live view screen**

Shows the camera's live view image. When the live view image is not turned on, the camera ID and lens information will appear here.

- The live view image will be turned off automatically while the camera is displaying color bars.

**4 [LIVE VIEW] button**

Touch the button to display the camera's live view image on the Browser Remote screen.

**5 Clip's creator**

**6 Recording location**

**7 Description of the clip**

Touch inside the text box and enter the desired text. To delete the text, touch [Clear All].

**8 Status indicators**

See the descriptions in the section about the [📷] screen (📖 174).

**9 [(🔊) Activate] button**

Touch the button to give priority to the metadata entered in this screen when recording clips. This overrides the metadata read from a file saved on the SD card.



## 10 [Overwrite Previous] button/[Overwrite] button









**While recording:** Touch [Overwrite] to send the metadata entered in this screen to the camera, replacing any metadata that the clip being recorded might have.

**After recording a clip:** Touch [Overwrite Previous] to send the metadata entered in this screen to the camera, replacing any metadata embedded in the last clip recorded.

## 11 [Apply from Next] button

Touch the button to send the metadata entered in this screen to the camera so it is embedded only with clips that are recorded after the transfer. This option does not overwrite the metadata of clips already recorded or being recorded.

### NOTES

- The metadata sent to the camera from Browser Remote will be lost in the following cases.
  - If the camera was turned off.
  - If the **MENU**   [4] Recording/Media Setup  [Metadata]  [Setting] setting was changed.
- Using Browser Remote ( Activate) button), you can give priority to metadata sent from the application. However, you cannot return the priority back to the SD card. To use a user memo file saved on the SD card you will need to set **MENU**   [4] Recording/Media Setup  [Metadata]  [Setting] to [SD Card] on the camera itself.
- Metadata sent to the camera from Browser Remote will not be added to relay clips recorded before the switch to the current CFast card.

## The Basic Screen

When using a smartphone or other device with a smaller screen, this screen offers only a small live image screen for final confirmation and the [REC] button to start and stop recording.

To open the basic screen, touch the  icon at the top of the Browser Remote screen.

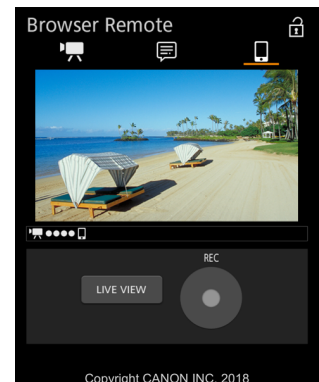

## FTP File Transfer

You can transfer MP4 or XF-AVC clips from the camera to another device connected to the network, using the FTP protocol.

The following explanations assume that the FTP server is on, ready and correctly configured.

Operating modes: CAMERA | MEDIA | RAW | MP4 | XF-AVC

### Preparations

Before you can transfer clips to a connected device, you need to configure the FTP server settings and other settings related to the handling of folders and files. If necessary, consult the network administrator in charge of the FTP server.

#### FTP Server and Transfer Settings

1 Open the [FTP Server] submenu.

**MENU** ➤ [Globe] [1] Network Settings] ➤ [FTP Transfer Settings]

2 Enter the destination FTP server.

- Enter the FTP server's IP address or host name using the keyboard screen (☞ 35).

3 Enter the [FTP: User Name], [FTP: Password], and [Destination Folder] in the same way.

4 Select [Port No.] and press the joystick to change the port number.

- Enter the port number using the keyboard screen (☞ 35).

5 Select whether to activate the passive mode.

[Passive Mode] ➤ [On] or [Off] ➤ Press the joystick

- [Off] is the standard setting for most cases. [On] (passive mode) is more appropriate for FTP transfers within a network behind a firewall.

6 Select whether to create a new folder for every transfer date.

[New Folder by Date] ➤ [On] or [Off] ➤ Press the joystick

7 Select how to handle file transfers when a file with the same name already exists on the server.

[Same Named Files] ➤ Desired option ➤ Press the joystick

#### Options for [New Folder by Date]

[On]: A new subfolder under the transfer destination folder "YYYYMMDD\HHMMSS" will be created for every transfer operation.

[Off]: All the files will be transferred to the folder set as [Destination Folder] in the FTP server settings.

#### Options for [Same Named Files]

[Skip]: If a file with the same name already exists in the destination folder, the file will not be transferred.

[Overwrite]: Even if a file with the same name already exists in the destination folder, the file will be transferred, overwriting any file with the same name in the destination folder.

## Transferring Clips (FTP Transfer)

After you record proxy clips to an SD card, you can transfer them to the FTP server. You can check the FTP-related settings on the status screens (📖 196).

### Transferring a Single Clip

- 1 Connect the camera to the desired network (📖 169).
  - Use an Infrastructure connection (📖 164) or Ethernet connection (📖 168).
  - With Ethernet connections, connect the camera to the desired network using an Ethernet cable.
- 2 Select the desired clip and then press the joystick.
  - The clip menu will appear.
- 3 Select [FTP Transfer] and then press the joystick.
- 4 Select [OK] and then press the joystick.
  - Press the CANCEL button to cancel the operation.
  - **FTP** will appear on the top of the screen, next to the connection type icon.
  - When the connection is established, the icons will change from yellow to white.
  - When the icons turn white, the clip will be transferred to the FTP server.
  - While the clip is being transferred, you can press the joystick to cancel.
  - When the transfer is completed, the network icons will turn yellow and then disappear from the screen.
- 5 When the confirmation message appears, press the joystick.

### Transferring Multiple Clips

- 1 Open the desired index screen (📖 140).
- 2 Connect the camcorder to the desired network (📖 169).
  - Use an Infrastructure connection (📖 164) or Ethernet connection (📖 168).
  - With Ethernet connections, connect the camera to the desired network using an Ethernet cable.
- 3 Open the [FTP Transfer] submenu.  
 [🌐 ⓘ Network Settings] ➤ [FTP Transfer]
- 4 Select [Select] to select which clips to transfer, or [All] to transfer all the clips and then press the joystick.
  - If you selected [Select], use the joystick to move between the clips. Press the joystick to select a clip to transfer and repeat as necessary. After selecting all the desired clips, press the MENU button.
- 5 Select [OK] and then press the joystick.
  - **FTP** will appear on the top of the screen, next to the connection type icon.
  - When the connection is established, the icons will change from yellow to white.
  - When the icons turn white, all the applicable clips will be transferred to the FTP server.
  - Press the CANCEL button to cancel the operation.
  - While the clips are transferred, you can press the joystick to cancel.
  - When the transfer is completed, the network icons will turn yellow and then disappear from the screen.
- 6 When the confirmation message appears, press the joystick.

 IMPORTANT

- Observe the following precautions when transferring files. Failing to do so may interrupt the transfer and incomplete files may remain at the transfer destination.
  - Do not open the SD card slot cover.
  - Do not remove the power source or turn off the camera.
- If incomplete files remain at the transfer destination, check the content and make sure they are safe to delete before deleting them.

 NOTES

- Depending on the access point's settings and capabilities, it may take some time to transfer files.

## Menu Options

For details about how to select an item, refer to *Using the Menus* (📖 33). A menu item's location within a menu is indicated by the page number icon (1 2, etc.) in the left column. For details about each function, see the reference page or the explanation accompanying the menu entry. Setting options in boldface indicate default values.

Depending on the camera's operating mode and the settings, some menu items may not be available. Such menu items do not appear or appear grayed out in menu screens.

To skip directly to the page of a specific menu:

[📷 Camera Setup] menu	📖 185	[🛠 Assistance Functions] menu	📖 191
[📷 Custom Picture/HDR] menu	📖 186	[🌐 Network Settings] menu	📖 192
[📷 Recording/Media Setup] menu	📖 187	[🔗 Assignable Buttons] menu	📖 193
[🎧 Audio Setup] menu	📖 188	[⚙ System Setup] menu	📖 193
[📺 Monitoring Setup] menu	📖 189	[★ My Menu] customized menu	📖 195

[📷 Camera Setup] menu (CAMERA mode only)

Menu item	Setting options and additional information
1 [Iris Mode]	[Automatic], <b>[Manual]</b> (📖 73) This setting is available only when a compatible lens (📖 230) is attached to the camera.
[Iris Increment]	[1/2 stop], <b>[1/3 stop]</b> (📖 73)
[Fine Increment]	[On], <b>[Off]</b> (📖 73)
[Zoom-Iris Correct.]	[On], <b>[Off]</b> If you are using a compatible lens, when this setting is set to [On], the camera will adjust the aperture as needed to keep the selected aperture value while zooming. Because of this adjustment, the brightness of the image might flicker slightly or you may hear the operation sound.
[Extended ND Range]	[On], <b>[Off]</b> (📖 71)
2 [Shutter Mode]	<b>[Speed]</b> , [Angle], [Clear Scan], [Slow], [Off] (📖 67)
[Shutter Increment]	[1/3 stop], <b>[1/4 stop]</b> (📖 67)
[ISO/Gain]	<b>[ISO]</b> , [Gain] (📖 69)
[ISO/Gain Extended Range]	[On], <b>[Off]</b> (📖 69)
[ISO Increment]	[1 stop], <b>[1/3 stop]</b> (📖 69)
[Gain Increment]	<b>[Normal]</b> , [Fine] (📖 69)

	Menu item	Setting options and additional information	
3	[Light Metering]	[Backlight], <b>[Standard]</b> , [Spotlight]	( 76)
	[AE Shift]	-2.0 to +2.0 in 0.25 point intervals ( <b>±0</b> )	( 75)
	[AE Response]	[High], <b>[Normal]</b> , [Low]	( 74)
		Determines how quickly the aperture is adjusted during automatic exposure. This setting has no effect when one of the following lenses is attached. · CN7x17 KAS S/E1 · CN10x25 IAS S/E1 · CN20x50 IAS H/E1	
	[Shockless WB]	[On], <b>[Off]</b>	( 77)
	[AWB Response]	[High], <b>[Normal]</b> , [Low]	( 79)
	[C. Temp. Increment]	<b>[Mired]</b> , [Kelvin]	( 77)
4	[AF Mode]	<b>[One Shot]</b> , [AF-Boosted MF], [Continuous]	( 80)
	[AF Frame Position]	<b>[Selectable]</b> , [Center Frame]	( 86)
	[AF Frame Size]	<b>[Large]</b> , [Small]	( 86)
	[Apply AF Speed Limit]	<b>[Always]</b> , [Only While Recording]	( 85)
	[AF Speed]	-7 to +2 ( <b>0</b> )	( 85)
	[AF Response]	-3 to +3 ( <b>0</b> )	( 85)
5	[Face Detection]	[On], <b>[Off]</b>	( 87)
	[Face AF]	<b>[Face Priority]</b> , [Face Only]	( 87)
	[Camera Grip Zoom]	[On], <b>[Off]</b>	( 89)
	[Camera Grip Zoom Speed]	1 to 16 ( <b>8</b> )	( 89)
	[Tele-converter]	[6.0x], [3.0x], [1.5x], <b>[Off]</b>	
		The digital tele-converter allows you to digitally increase the focal length of the camera by the selected multiplier. Note that the image is digitally processed so the image will deteriorate throughout the zoom range.	
	[EF-S Lens]	[On], <b>[Off]</b>	( 39)
6	[ABB]	-	( 53)
	[Color Bars]	[On], <b>[Off]</b>	( 105)
	[Color Bar Type]	<b>[SMPTE]</b> , <b>[EBU]*</b> , [ARIB]	( 105)
	[Periph. Illum. Corr.]	[On], <b>[Off]</b>	( 39)
	[Chromatic Aberr. Corr.]	[On], <b>[Off]</b>	( 39)

\* The default value depends on the country/region or purchase.

### [C<sub>HDR</sub>] Custom Picture/HDR] menu (CAMERA mode only)

	Menu item	Setting options and additional information	
1	[HDR/LUT]	<b>[HDR: Off]</b> , [HDR: HLG], [HDR: PQ] [SDI]: <b>[LUT Off]</b> , [LUT: BT.709], [LUT: ACESproxy] [VIDEO], <b>[C200]</b> [VF]: <b>[LUT Off]</b> , [LUT: BT.709], [LUT: HDR Assist. (1600%)], [LUT: HDR Assist. (400%)]	( 155) ( 156)
	[Preset]	[Canon Log 3], [Canon Log], <b>[BT.709]</b> , [Off]	( 129)
	[Gamma]	[Canon Log 3], [Canon Log], <b>[Wide DR]</b> , [Normal 1 (Standard)], [Normal 2 (x4.0)], [Normal 3 (BT.709)], [Normal 4 (x5.0)]	( 133)
	[Color Matrix]	<b>[Neutral]</b> , [Production Camera], [Cinema EOS Original], [Video], [Off]	( 133)

Menu item	Setting options and additional information
[Activate Other Settings]	[On], <b>[Off]</b> (📖 134 - 136)
[Other Settings]	Refer to the reference page. (📖 134)
[File]	
[Select]	<b>[C1:CP000001]</b> to [C20:CP000020] (📖 129)
[Rename]	– (📖 131)
[Protect]	<b>[Unprotect]</b> , [Protect] (📖 131)
[Reset]	[Cancel], [OK] (📖 131)
[Copy to SD Card B], [Load from SD Card B]	– (📖 131)

### 📷 Recording/Media Setup] menu

Menu item	Setting options and additional information
1	
[Initialize Media]	
[CFast], [SD Card A], [SD Card B]	[Cancel], [OK] (📖 50)
[Main Rec Format]	[RAW (CFast)], <b>[MP4 (SD Card)]</b> , [XF-AVC (SD Card)] (📖 64)
[System Frequency]	<b>[59.94 Hz]</b> , <b>[50.00 Hz]</b> <sup>1</sup> , [24.00 Hz] (📖 64)
[Recording Mode]	<b>[Normal Recording]</b> , [Slow Motion Recording], [Pre-Recording], [Frame Recording], [Interval Recording], [Continuous Recording] (📖 114)
[Recording Interval]	<b>[1 sec]</b> , [5 sec], [10 sec], [30 sec], [1 min], [5 min], [10 min] (📖 117)
[Sub Rec Format]	[MP4 (SD Card)], [XF-AVC (SD Card)], <b>[Off]</b> (📖 113)
[Continuous Recording]	[REC], [STBY] (📖 118)
2	
[Frame Rate]	When [System Frequency] is set to [59.94 Hz]: [59.94i]*, <b>[59.94P]</b> , [29.97P], [23.98P] When [System Frequency] is set to [50.00 Hz]: [50.00i]*, <b>[50.00P]</b> , [25.00P] * XF-AVC clips only. (📖 64)
[Resolution/Color Sampling]	[4096x2160 12 bit], [4096x2160 10 bit], [3840x2160 YCC420 8 bit], [1920x1080 YCC420 8 bit] (📖 64) For RAW clips, the setting is automatically selected by the camera.
[Audio Format (MP4)]	<b>[AAC 16 bit 2CH]</b> , [LPCM 16 bit 4CH] (📖 99)
[Audio Format (RAW)]	<b>[LPCM 16 bit 4CH]</b> , [LPCM 24 bit 4CH] (📖 99)
3	
[Relay Recording], [Double Slot Recording]	[On], <b>[Off]</b> (📖 51)
4	
[Metadata]	
[Camera Index]	<b>[A]</b> to [Z] (📖 61)
[Reel Number], [Clip Number]	<b>[001]</b> to [999], [Change], [Reset], [Cancel] (📖 61)
[User Defined]	User defined string up to 5 characters ( <b>[CANON]</b> ), [Change], [Reset], [Cancel] (📖 61)
[Scene], [Take]	Scene description up to 16 characters / Take description up to 8 characters, [Change], [Reset], [Cancel] (📖 110)
[Setting]	[Remote], <b>[SD Card]</b> (📖 109, 179)
[User Memo]	<b>[Off]</b> , list of user memo files available on the SD card (📖 109)

Menu item	Setting options and additional information
[Country Code], [Organization], [User Code]	Identifiers up to 4 characters ( <b>[00__]</b> default for [Organization] only), [Change], [Reset], [Cancel] [Country Code]: This identifier is the country code defined by ISO-3166-1 and is to be entered starting from the left. [Organization]: This identifier represents the organization that owns or operates the camera and can be obtained by registering with the SMPTE Registration Authority. If the organization is not registered, enter [0000]. [User Code]: This identifier designates the user. Leave this blank if [Organization] is set to [0000].
[Add  File]	[On], <b>[Off]</b> (132)
[Clip Numbering]	[Reset], <b>[Continuous]</b> (61)
[Rec Command]	[On], <b>[Off]</b> When this setting is [On] and you connect the camera to an external recorder, if you start or stop recording with the camera, the other device will also start or stop recording.
[HDMI Time Code]	[On], <b>[Off]</b> (153)
[MP4 Clip/Photo Numbering]	[Reset], <b>[Continuous]</b> (62)

<sup>1</sup> The default value depends on the country/region or purchase.

### [] Audio Setup] menu

Menu item	Setting options and additional information
[1]	
[Select CH1/CH2 Input]	<b>[INPUT Terminals]</b> , [MIC Terminal], [Monaural Mic] (100)
[CH2 Input]	<b>[INPUT 2]</b> , [INPUT 1] (100)
[Select CH3/CH4 Input]	<b>[INPUT Terminals]</b> , [MIC Terminal], [Monaural Mic] (100)
[CH1/CH2 ALC Link], [CH3/CH4 ALC Link]	[Linked], <b>[Separated]</b> (102)
[Speaker Volume]	[Off], 1 to 15 ( <b>8</b> ) Available only during  mode, this allows the speaker's volume to be adjusted.
[2]	
[Audio Rec Level CH3]	<b>[Automatic]</b> , [Manual] (102)
[CH3 Level]	0 to 100 ( <b>50</b> ) (102)
[Audio Rec Level CH4]	<b>[Automatic]</b> , [Manual] (102)
[CH4 Level]	0 to 100 ( <b>50</b> ) (102)
[Audio Rec Level CH3/CH4]	<b>[Automatic]</b> , [Manual] (102)
[CH3/CH4 Level]	0 to 100 ( <b>50</b> ) (102)
[3]	
[INPUT 1 Mic Trimming]	[+12 dB], [+6 dB], <b>[0 dB]</b> , [-6 dB], [-12 dB] (101)
[INPUT 1 Mic Att.]	[On], <b>[Off]</b> (103)
[INPUT 2 Mic Trimming]	[+12 dB], [+6 dB], <b>[0 dB]</b> , [-6 dB], [-12 dB] (101)
[INPUT 2 Mic Att.]	[On], <b>[Off]</b> (103)
[INPUT 1&2 Limiter]	[On], <b>[Off]</b> (102)
[MIC Att.]	[On], <b>[Off]</b> (103)
[MIC Low Cut]	[On], <b>[Off]</b> (103)
[4]	
[1 kHz Tone]	[-12 dB], [-18 dB], [-20 dB], <b>[Off]</b> (105)
[Headphone Volume] <sup>1</sup>	[Off], 1 to 15 ( <b>8</b> ) (143)
[Monitor Channels] <sup>1</sup>	<b>[CH1/CH2]</b> , [CH1/CH1], [CH2/CH2], [CH1+2/CH1+2], [CH3/CH4], [CH3/CH3], [CH4/CH4], [CH3+4/CH3+4], [CH1+3/CH2+4] (158)



Menu item	Setting options and additional information
[HDMI OUT Channels] <sup>1</sup>	[CH1/CH2], [CH3/CH4] ( 158)

<sup>1</sup> Appears on page [1] in [MEDIA] mode.

### [Monitoring Setup] menu

Menu item	Setting options and additional information
[1] [LCD LM-V1 Brightness]	-99 to +99 ( <b>±0</b> ) ( 41)
[LCD LM-V1 Contrast]	-99 to +99 ( <b>±0</b> ) ( 41)
[LCD LM-V1 Color]	-20 to +20 ( <b>±0</b> ) ( 41)
[LCD LM-V1 Sharpness]	1 to 4 ( <b>2</b> ) ( 41)
[LCD LM-V1 Luminance]	[+2], [+1], [ <b>Normal</b> ] ( 41)

[2] [LCD LM-V2 Brightness]	-99 to +99 ( <b>±0</b> )
[LCD LM-V2 Contrast]	-99 to +99 ( <b>±0</b> )
[LCD LM-V2 Color]	-20 to +20 ( <b>±0</b> )
[LCD LM-V2 Sharpness]	1 to 4 ( <b>2</b> )
[LCD LM-V2 Luminance]	[+2], [+1], [ <b>Normal</b> ]
	[LCD LM-V2] settings are used to adjust, respectively, the brightness, contrast, color saturation, sharpness and luminance of an optional LM-V2 LCD Monitor.























C200 [3]	Menu item	Setting options and additional information
	[VF Brightness]	-99 to +99 ( <b>±0</b> ) ( 41)
	[VF Contrast]	-99 to +99 ( <b>±0</b> ) ( 41)
	[VF Color]	-20 to +20 ( <b>±0</b> ) ( 41)
	[VF Sharpness]	1 to 4 ( <b>2</b> ) ( 41)
	[VF Luminance]	[High], [ <b>Normal</b> ] ( 41)
	[VF Eye Sensor]	[ <b>On</b> ], [Off]
		When this setting is set to [On], the viewfinder will be dimmed automatically when the sensor does not detect the user's eye near the eyepiece for 30 seconds (or 10 seconds, in playback mode).

4 (C200B [3])	Menu item	Setting options and additional information
	[EVF-V70 Brightness]	-99 to +99 ( <b>±0</b> ) Adjusts the EVF-V70's brightness.
	[EVF-V70 Contrast]	-99 to +99 ( <b>±0</b> ) Adjusts the EVF-V70's contrast.
	[EVF-V70 Color]	-20 to +20 ( <b>±0</b> ) Adjusts the EVF-V70's color.
	[EVF-V70 Sharpness]	1 to 4 ( <b>2</b> ) Adjusts the EVF-V70's sharpness.
	[EVF-V70 Luminance]	[High], [ <b>Normal</b> ] Adjusts the EVF-V70's luminance.
	[EVF-V70 Eye Sensor]	[ <b>On</b> ], [Off]
		When this setting is set to [On], the EVF-V70 will be dimmed automatically when the sensor does not detect the user's eye near the eyepiece for 30 seconds (or 10 seconds, in playback mode).

	Menu item	Setting options and additional information
5	( <b>C200B</b> 4)	
	[B&W Image: VIDEO Output], <b>C200</b> [B&W Image: VF Output]	[On], [Off] ( 42)
	[Custom Display]	-
	[Audio Level Indicator]	[On], [Off]
	[Date/Time], [Camera Data]	[On], [Off]
		These settings are available only when the menu is opened from the playback screen ( 141) and determine whether the following onscreen displays will appear on the playback image. [Audio Level Indicator]: The audio level meter (clips only). [Date/Time]: The date and time when the clip/photo was recorded. [Camera Data]: The aperture value, shutter speed and ISO speed/gain value used to record the clip (clips only).
6	( <b>C200B</b> 5)	
	[OSD Output]	[On], [Off] ( 157)
	[Custom Display 1]	( 57)
	[Light Metering], [Custom Picture/HDR], [Focal Length], [ND Filter], [Focus Mode], [Key Lock], [White Balance], [AE Shift], [Exposure Bar], [Iris], [ISO/Gain], [Shutter], [Peaking], [Tele-converter], [EF-S Lens], [Magnification], [LUT], [Lens]	[On], [Off]
	[Custom Display 2]	( 57)
	[Remaining Battery], [Remaining Rec Time]	[Only Warnings], [Normal], [Off]
	[Recording Mode], [Time Code], [Reel/Clip Number], [Interval Counter]	[On], [Off]
	[Remaining Photos]	[Only Warnings], [Normal], [Off]
	[Temperature/Fan], [Resolution/Color Sampling], [Frame Rate], [Output Terminals Status], [OSD Output]*, [Rec Command], [User Memo]*, [User Bit]*, [Monitor Channels]*, [Audio Level Indicator], [Network Functions], [GPS]	[On], [Normal]: Show the icon/onscreen display always or whenever the necessary conditions are triggered. [Only Warnings]: Show the icon/onscreen display only when a critical level is reached. • The default setting for items marked with an asterisk (*) is [Off].
	[Date/Time]	[Date/Time], [Time], [Date], [Off]
	[Displayed Units]	[Meters], [Feet] <sup>1</sup> Changes the distance units used in camera displays between meters and feet.

<sup>1</sup> The default value depends on the country/region or purchase.

[ Assistance Functions] menu

	Menu item	Setting options and additional information	
1	[Focus Guide]	[On], <b>[Off]</b>	(  82)
	[Focus Guide 2nd Frame]	[On], <b>[Off]</b>	(  82)
2	[Peaking: VIDEO Output], <b>C200</b> [Peaking: VF Output]	[On], <b>[Off]</b>	(  83)
	[Peaking]	<b>[Peaking 1]</b> , [Peaking 2]	(  83)
	[Peaking 1]		(  83)
	[Color]	<b>[White]</b> , [Red], [Yellow], [Blue]	
	[Gain]	[Off], 1 to 15 ( <b>8</b> )	
	[Frequency]	1 to 4 ( <b>2</b> )	
	[Peaking 2]		(  83)
	[Color]	[White], <b>[Red]</b> , [Yellow], [Blue]	
	[Gain]	[Off], 1 to 15 ( <b>15</b> )	
	[Frequency]	1 to 4 ( <b>1</b> )	
	[B&W during Peaking]	[On], <b>[Off]</b>	(  83)
	3	<b>C200</b> [Magn.: VF+VIDEO Output], <b>C200B</b> [Magn.: VIDEO Output], [Magn.: SDI/HDMI Output]	[On], <b>[Off]</b>
[B&W during Magn.]		[On], <b>[Off]</b>	(  83)
4	[Zebra: VIDEO Output], <b>C200</b> [Zebra: VF Output]	[On], <b>[Off]</b>	(  91)
	[Zebra]	<b>[Zebra 1]</b> , [Zebra 2], [Zebra 1+2]	(  91)
	[Zebra 1 Level]	[5 ±5%] to [95 ±5%] in 5 percentage point intervals ( <b>[70 ±5%]</b> )	(  91)
	[Zebra 2 Level]	0% to 100% in 5 percentage point intervals ( <b>[100%]</b> )	(  91)
5	<b>C200</b> [WFM: VF+VIDEO Output] <sup>1</sup> , <b>C200B</b> [WFM: VIDEO Output], [WFM: SDI Output] <sup>1</sup>	[On], <b>[Off]</b>	(  106)
	[WFM Type] <sup>1</sup>	<b>[Line]</b> , [Line+Spot], [Select Line], [Field], [RGB], [YPbPr]	(  106)
	[WFM Gain] <sup>1</sup>	<b>[1x]</b> , [2x]	(  106)
	[WFM Y Position] <sup>1</sup>	<b>[0%]</b> , [15%], [30%], [45%], [50%]	(  106)
	[WFM Select Line] <sup>1</sup>	When the vertical resolution is 1080: 0 to 1079 ( <b>[540]</b> ) in 1-line increments, [Set] When the vertical resolution is 2160: 0 to 2158 ( <b>[1080]</b> ) in 2-line increments, [Set]	(  106)
6	<b>C200</b> [Markers: VF+VIDEO Output], <b>C200B</b> [Markers: VIDEO Output], [Markers: SDI/HDMI Output]	<b>[On]</b> , [Off]	(  90)
	[Center Marker]	[Yellow], [Blue], [Green], [Red], [Black], [Gray], [White], <b>[Off]</b>	(  90)
	[Horizontal Marker]	[Yellow], [Blue], [Green], [Red], [Black], [Gray], [White], <b>[Off]</b>	(  90)
	[Grid Marker]	[Yellow], [Blue], [Green], [Red], [Black], [Gray], [White], <b>[Off]</b>	(  90)
	[Aspect Marker]	[Yellow], [Blue], [Green], [Red], [Black], [Gray], [White], <b>[Off]</b>	(  90)

Menu item	Setting options and additional information
[Marker Aspect Ratio]	[4:3], [13:9], [14:9], [16:9], [1.375:1], [1.66:1], [1.75:1], [1.85:1], [1.90:1], [2.35:1], <b>[2.39:1]</b> , [Custom] (90)
[Marker Custom Asp. Ratio]	1.00:1 to 9.99:1 ( <b>1.00:1</b> ), [Set] (90)
[7]	
[Safe Area Marker]	[Yellow], [Blue], [Green], [Red], [Black], [Gray], [White], <b>[Off]</b> (90)
[Basis for Marker Safe Area]	<b>[Whole Picture]</b> , [Selected Aspect Marker] (90)
[Marker Safe Area %]	[80%], [90%], [92.5%], <b>[95%]</b> (90)

<sup>1</sup> Appears on page 1 in MEDIA mode.

[🌐 Network Settings] menu

Menu item	Setting options and additional information
[1]	
[Connection Settings]	<b>[1: (NONE)]</b> , [2: (NONE)], [3: (NONE)], [4: (NONE)] (169)
[Activate]	<b>[Off]</b> , [Browser Remote] (170)
[Browser Remote Settings]	(170)
[Port No.]	1 to 65535 ( <b>[80]</b> )
[Camera ID]	Camera identifier up to 8 characters ( <b>[C200]</b> )
[Users Settings]	<b>[One User (Full)]</b> , [Two Users (Camera/Meta)]
[Full: User Name], [Camera: User Name], [Meta: User Name]	User name up to 8 characters (Default user names are <b>[Full]</b> , <b>[Camera]</b> and <b>[Meta]</b> , respectively)
[Full: Password], [Camera: Password], [Meta: Password]	Password up to 8 characters ( <b>[12345678]</b> )
[FTP Transfer]	[Select], [All]
[FTP Transfer Settings]	(182)
[FTP Server]	Server name up to 32 characters
[FTP: User Name]	User name up to 32 characters
[FTP: Password]	Password up to 32 characters
[Destination Folder]	Destination folder's path up to 152 characters (Default is the root folder <b>[/]</b> )
[Port No.]	1 to 65535 ( <b>[21]</b> )
[Passive Mode]	[On], <b>[Off]</b>
[New Folder by Date]	<b>[On]</b> , [Off]
[Same Named Files]	<b>[Skip]</b> , [Overwrite]

### [Assignable Buttons] menu

Following are the default settings for each assignable button. For a complete list of the functions that can be assigned, refer to the detailed table (126).

	Menu item	Setting options and additional information
1	[Camera 1] to [Camera 7]	1: <b>[Magn.: All]</b> , 2: <b>[Peaking: All]</b> , 3: <b>[Zebra: All]</b> , 4: <b>[WFM: All]</b> , 5: <b>[ISO/Gain]</b> , 6: <b>[Shutter]</b> , 7: <b>[Display]</b>
2	[Camera 8] to [Camera 11]	8: <b>[FUNC]</b> , 9: <b>[Audio Status]</b> , 10: <b>[Push Auto Iris]</b> , 11: <b>[One-Shot AF]</b>
3	[Camera Grip: 1]	1: <b>[Focus Guide]</b>
4	[LCD LM-V1/V2: 1] and [LCD LM-V1/V2: 2]	1: <b>[FUNC]</b> , 2: <b>[Display]</b>
5	[EVF-V70: 1] to [EVF-V70: 4]	1: <b>[FUNC]</b> , 2: <b>[EVF-V70 Setup]</b> , 3: <b>[Magn.: All]</b> , 4: <b>[(NONE)]</b>
6	[RC-V100: 1] to [RC-V100: 4]	1: <b>[Magn.: All]</b> , 2: <b>[Peaking: All]</b> , 3: <b>[Zebra: All]</b> , 4: <b>[WFM: All]</b>

### [System Setup] menu

	Menu item	Setting options and additional information
1	[Reset]	[All Settings], [Camera Settings] <sup>1</sup> , [Assignable Buttons] These settings reset the following camera settings to default values/settings. [All Settings]: All the camera's settings except for the hour meter. [Camera Settings]: White balance, iris, ISO speed, gain, shutter speed, [Camera Setup] settings and custom picture settings. [Assignable Buttons]: Only the assignable buttons.
	[Transfer Menu/CP]	(137)
	[Save]	[To Camera], [To SD Card B]
	[Load]	[From Camera], [From SD Card B]
	[Time Zone]	List of world time zones. <b>[UTC-05:00 New York]</b> or <b>[UTC+01:00 Central Europe]</b> <sup>2</sup> (31)
	[Date/Time]	– (31)
	[Date Format]	[YMD], [YMD/24H], <b>[MDY]</b> , [MDY/24H], <b>[DMY]</b> , [DMY/24H] <sup>2</sup> (31)
	[Language ]	[Deutsch], <b>[English]</b> , [Español], [Français], [Italiano], [Polski], [Português], [Русский], [简体中文], [한국어], [日本語] (32)
	[REMOTE Term.]	[RC-V100 (REMOTE A)], <b>[Standard]</b> (123)
2	[HDMI Max Res.]	[3840x2160], <b>[1920x1080]</b> (153)
	[SDI Output]	[2048x1080 / 1920x1080], <b>[1920x1080]</b> (152)
	[3G-SDI Mapping]	[Level A], <b>[Level B]</b> (153)
	[SDI/HDMI Scan Mode]	<b>[P]</b> , [PsF] (154)
	[SDI Output Always On]	[ON (Linked to VIDEO Term.)], <b>[Off]</b>
3	[Time Code Mode]	<b>[Preset]</b> , [Regen.] (92)
	[Time Code Run]	<b>[Rec Run]</b> , [Free Run] (92)
	[Time Code DF/NDF]	<b>[DF]</b> , [NDF] (93)

Menu item	Setting options and additional information	
[Set Time Code]	<b>[00:00:00:00]</b> to [23:59:59:29] (for 59.94 Hz recordings) or [23:59:59:24] (for 50.00 Hz recordings), [Change], [Reset], [Cancel]	( 93)
[User Bit Type]	<b>[Setting]</b> , [Time], [Date]	( 95)
<b>4</b>		
[Camera Ctrl Dial] <sup>1</sup> , [Camera Grip Ctrl Dial] <sup>1</sup>	<b>[Iris]</b> , [ISO/Gain], [Off] Selects the function of the control dial on the camera or camera grip.	
[Camera Ctrl Dial Dir.] <sup>1, 3</sup> , [Camera Grip Ctrl Dial Dir.] <sup>1, 3</sup>	[Reverse], <b>[Normal]</b> Changes the direction of the adjustment when operating the control dial on the camera or camera grip.	
[EVF-V70 SELECT Dial Dir.] <sup>1, 3</sup>	[Reverse], <b>[Normal]</b> Changes the direction of the adjustment when operating the SELECT dial on the optional EVF-V70 OLED Electronic Viewfinder.	
[Key Lock] <sup>1</sup>	[All Buttons], <b>[All Except REC Button]</b>	
[Camera REC Button] <sup>1</sup> , [Camera Grip REC Button] <sup>1</sup>	[Disable], <b>[Enable]</b> Independently enables or disables the uses of the REC buttons on the camera.	
[Fan Speed]	[High], <b>[Low]</b>	( 63)
<b>5</b>		
[LED] <sup>1, 4</sup>		( 57)
[Tally Lamp (Front)], [Tally Lamp (Rear)], [CFast Access LED], [SD Card Access LED], [Ethernet]	<b>[On]</b> , <b>[Off]</b> These settings determine whether the following LEDs and indicators will illuminate. [Tally Lamp (Front)], [Tally Lamp (Rear)]: The tally lamps on the camera. Note that regardless of this setting, when the camera is turned off, the tally lamps will illuminate in red momentarily after the <b>POWER</b> button is pressed. [CFast Access LED], [SD Card Access LED]: The SD card access indicators and the CFast card access indicator when the camera is accessing the respective recording media. [Ethernet]: The Ethernet indicator when the camera is accessing a wired network.	
[Fan]		( 63)
[Mode]	[Automatic], <b>[Always On]</b>	
[Fan Speed (Always)]	[High], <b>[Low]</b>	
[Touch Screen Response] <sup>5</sup>	<b>[Normal]</b> , [Low]	( 40)
[Review Recording]	<b>[Entire Clip]</b> , [Last 4 sec]	( 112)
[GPS Auto Time]	[On], <b>[Off]</b>	( 111)
<b>6</b>		
[Retract Lens] <sup>1</sup>	<b>[On]</b> , [Off] When one of the following lenses is attached to the camera and the focus mode switch on the lens is set to AF, if this setting is set to [On], the lens will retract fully when the camera is turned off. • EF 40mm f/2.8 STM • EF-S 24mm f/2.8 STM • EF 50mm f/1.8 STM	
[Reset Hour Meter] <sup>1</sup>	– The camera has two “hour meters” – the first keeps track of total operation time and the second keeps track of operation time since the last time the second hour meter was reset with this function.	
[Firmware] <sup>1</sup>		
[Camera]	– Displays the current firmware version of the camera. This setting is usually unavailable.	
[Lens]	–	( 38)

<sup>1</sup> CAMERA mode only.

<sup>2</sup> The default value depends on the country/region or purchase.

<sup>3</sup> Appears on page 3 in MEDIA mode.

<sup>4</sup> Appears on page 4 in MEDIA mode.

<sup>5</sup> Only when the LM-V1 LCD Monitor (supplied accessory for the C200; optional accessory for the C200B) or optional LM-V2 LCD Monitor is attached.

## [★ My Menu] (CAMERA mode only)

	Menu item	Setting options and additional information
1	[CAMERA-1 Edit]	[Register], [Move], [Delete], [Reset All], [Rename]
2	[CAMERA-2 Edit]	[Register], [Move], [Delete], [Reset All], [Rename]
3	[CAMERA-3 Edit]	[Register], [Move], [Delete], [Reset All], [Rename]
4	[CAMERA-4 Edit]	[Register], [Move], [Delete], [Reset All], [Rename]
5	[CAMERA-5 Edit]	[Register], [Move], [Delete], [Reset All], [Rename]

## Displaying the Status Screens

You can use the status screens to check the camera's various settings. You can also output the status screens to an external monitor.

Operating modes: CAMERA | MEDIA | RAW | MP4 | XF-AVC

- 1 Set an assignable button to [Status] in advance (📖 125).
- 2 Press the assignable button to open the status screens.
  - The status screen most recently displayed will appear unless you turned off the camera or changed the operating mode. In such case, the [Gamma/Color Space/Color Matrix] status screen appears in CAMERA mode and the [Assignable Buttons 1/4] status screen appears in MEDIA mode.
- 3 Push the joystick left/right to scroll through the status screens.
- 4 When you have finished, press the assignable button set to [Status] again to exit the status screens.
  - Alternatively, you can press the CANCEL button.

[Gamma/Color Space/Color Matrix] screen	📖 196
[📷 Data] screens	📖 197
[Camera] screens	📖 198
[Assignable Buttons] screens	📖 199
[Audio] screens	📖 200
[Media] screen	📖 201
[Terminal Outputs] screen	📖 201
[Recording] screen	📖 202
[Metadata] screen	📖 202
[Battery/Hour Meter] screen	📖 203
[Network] screens	📖 204
[GPS Information Display] screen*	📖 206

\* Only when the optional GP-E2 GPS Receiver is attached to the camera's system extension terminal.

### [Gamma/Color Space/Color Matrix] Status Screen ( CAMERA mode only)

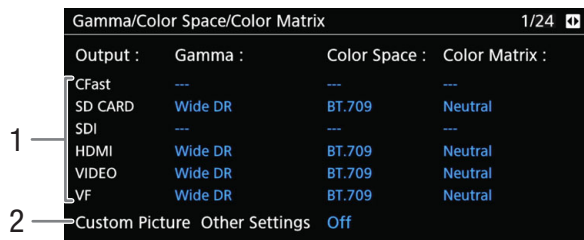

- 1 Gamma curve, color space and color matrix used for recordings, video output and displays  
 [CFast]: Settings used for clips recorded on the CFast card (📖 129, 133)  
 [SD CARD]: Settings/LUT used for clips recorded on the SD card (📖 113)  
 [SDI], [HDMI]: Settings/LUT used for video output from the respective terminals (📖 156)
  - 2 [VIDEO], [VF]: Settings/LUT used for the camera's LCD screen and viewfinder<sup>1</sup> (📖 156)  
<sup>1</sup> C200 only.
- 2 **MENU** ➤ [C<sub>HDR</sub>] 1 Custom Picture/HDR ➤ [Activate Other Settings] setting (whether detailed settings in the custom picture file are active or not)



[CP Data 1/2] Status Screen (CAMERA mode only)

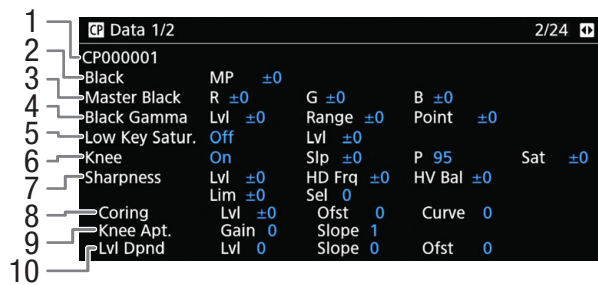

- |  |   |
|--|---|
| <ul style="list-style-type: none"> <li>1 Custom picture file name (📖 129)</li> <li>2 Master pedestal (📖 134)</li> <li>3 Master black RGB levels (📖 134)</li> <li>4 Black gamma settings (level, range and point) (📖 134)</li> <li>5 Low key saturation (📖 134)</li> <li>6 Knee settings (slope, point and saturation) (📖 134)</li> </ul> | <ul style="list-style-type: none"> <li>7 Sharpness settings (level, horizontal detail frequency, horizontal/vertical detail balance, limit and select) (📖 135)</li> <li>8 Coring settings (level, offset and curve) (📖 135)</li> <li>9 Sharpness settings (knee aperture gain and slope) (📖 135)</li> <li>10 Level depend settings (level, slope and offset) (📖 135)</li> </ul> |
|--|---|

[CP Data 2/2] Status Screen (CAMERA mode only)

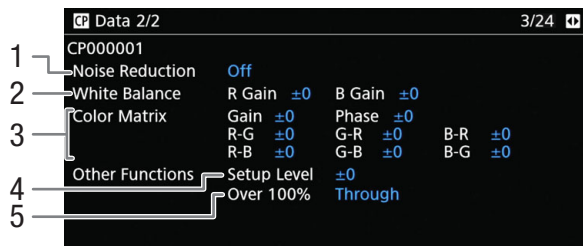

- |  |   |
|--|---|
| <ul style="list-style-type: none"> <li>1 Noise reduction (📖 136)</li> <li>2 White balance settings (📖 136)</li> <li>3 Color matrix fine-tuning settings (📖 136)</li> </ul> | <ul style="list-style-type: none"> <li>4 Setup level (📖 136)</li> <li>5 Handling of clips exceeding 100% (📖 136)</li> </ul> |
|--|---|

[Camera 1/4] to [Camera 4/4] Status Screens (CAMERA mode only)

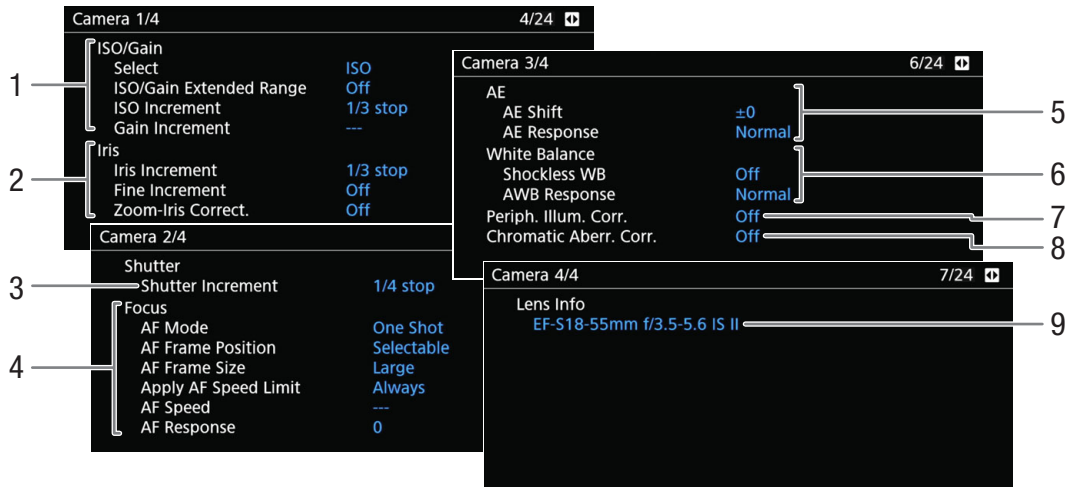

- 1 ISO speed/Gain (📖 69)  
Selected mode, extended range, ISO increment and gain increment
- 2 Aperture (📖 72)  
Iris increment, aperture correction while zooming
- 3 Shutter speed increment (📖 68)
- 4 Focus (📖 80)  
AF mode, AF frame settings, AF speed and AF response settings

- 5 Automatic exposure (AE)  
AE shift (📖 75), AE response (📖 74)
- 6 White balance (📖 77)  
Shockless white balance, auto white balance (AWB) response
- 7 Correction for peripheral illumination (📖 39)
- 8 Correction for chromatic aberration (📖 39)
- 9 Lens model name info (📖 37)

## [Assignable Buttons 1/4] to [Assignable Buttons 4/4] Status Screens

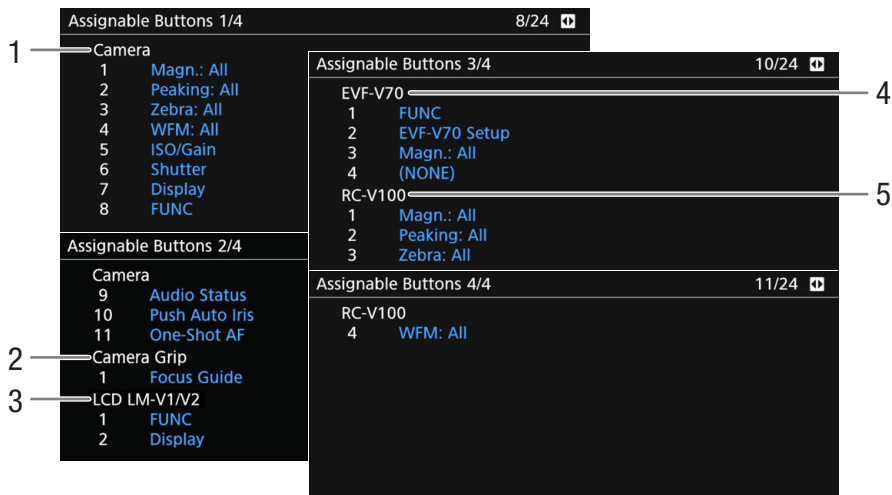

Current functions of the assignable buttons (📖 125)

- 1 On the camera's body
- 2 On the camera grip<sup>1</sup>
- 3 On the LCD monitor<sup>1</sup>
- 4 On the optional EVF-V70 Electronic Viewfinder
- 5 On the optional RC-V100 Remote Controller

<sup>1</sup> Supplied accessory for the C200; optional accessory for the C200B.

### [Audio] Status Screens

When you set an assignable button to [Audio Status], the status screens are the same except that you can press the joystick to open the [Audio Setup] menu.

In CAMERA mode

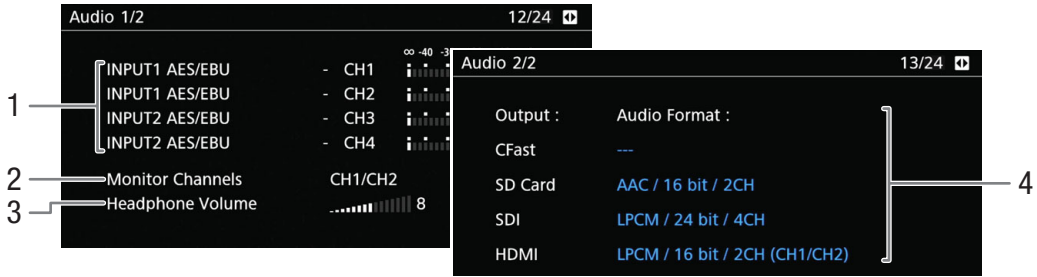

In MEDIA mode

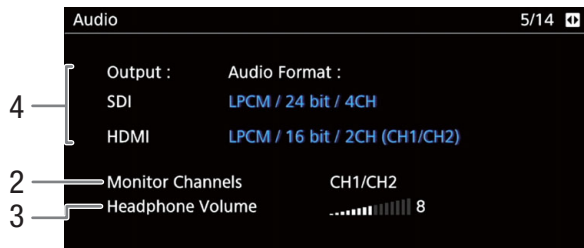

- 1 Audio source input, audio level adjustment mode and audio level indicator for each audio channel (📖 96)
- 2 Audio channels output from the headphones/speaker (📖 158)
- 3 Headphone volume (📖 143)
- 4 Audio format (📖 96), audio bit depth (📖 158) and audio channels (📖 158) used for recording or output.

- [CFast]: Settings used for clips recorded on the CFast card.
- [SD Card]: Settings used for clips recorded on the SD card.
- [SDI], [HDMI]: Settings used for audio output from the respective terminals.

## [Media] Status Screen



- |  |                              |
|--|------------------------------|
| 1 SD card A                                    | 6 Used (recorded) space      |
| 2 SD card B                                    | 7 Available space            |
| 3 CFast card                                   |                              |
| <b>For each:</b>                               |                              |
| 4 Visual bar: Approximate used/available space | 8 Number of remaining photos |
| 5 Total space                                  | 9 SD/UHS speed class         |

Only for the SD card:

### **i** NOTES

- Depending on the recording media, the total space displayed on the screen may differ from the nominal capacity listed on the CFast card or SD card.

## [Terminal Outputs] Status Screen

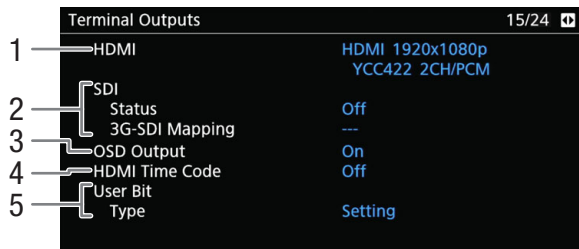

- |   |  |
|---|--|
| 1 HDMI OUT terminal status (📖 153): Signal type (HDMI/DVI), video output, audio output  | 3 Output of onscreen displays (📖 157)                              |
| 2 SDI terminal status: Video output <sup>1</sup> (📖 152), 3G-SDI output mapping (📖 153) | 4 Time code output from the HDMI OUT terminal <sup>2</sup> (📖 153) |
|   | 5 User bit <sup>2</sup> (📖 95)                                     |

<sup>1</sup> The displayed bit depth refers to the video signal's bit depth.

<sup>2</sup> CAMERA mode only.

### [Recording] Status Screen (CAMERA mode only)

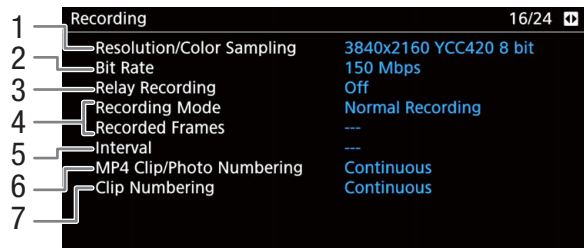

- |  |   |
|--|---|
| 1 Resolution and color sampling (📖 65) | 5 Interval length for interval recording mode (📖 117) |
| 2 Bit rate (📖 64)                      | 6 MP4 Clip/Photo numbering (📖 62)                     |
| 3 Relay recording (📖 51)               | 7 Clip numbering (📖 61)                               |
| 4 Special recording mode (📖 114)       |   |

### [Metadata] Status Screen (CAMERA mode only)

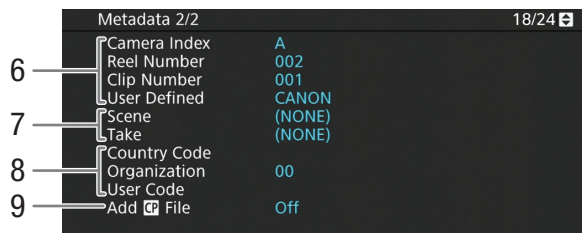
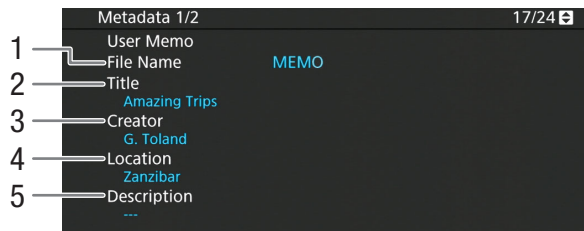

- |   |   |
|---|---|
| 1 User memo file name (📖 109)   | 7 Scene and take information (📖 110)  |
| 2 Clip title  | 8 Unique material identifier (UMID) code (📖 188): country, organization, user |
| 3 Camera operator   | 9 Embed custom picture files with clips (📖 132)                               |
| 4 Filming location  |   |
| 5 Clip description  |   |
| 6 Clip name information (📖 61) (camera index, reel number, clip number, user-defined field) |   |

## [Battery/Hour Meter] Status Screen

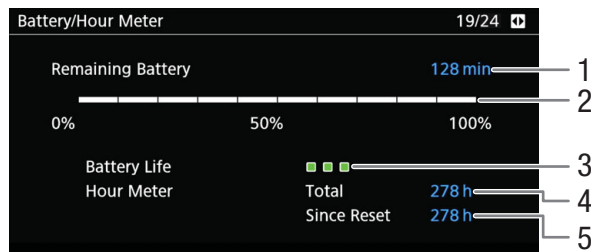

- |   |                                    |   |   |
|---|------------------------------------|---|---|
| 1 | Remaining recording time           | 4 | Total operation time (📖 194)                          |
| 2 | Remaining recording time indicator | 5 | Operation time since using [Reset Hour Meter] (📖 194) |
| 3 | Battery life indicator             |   |   |

### [Network 1/5] to [Network 3/5] Status Screens\*

\* In **MEDIA** mode, [Network 1/6] to [Network 3/6].

204

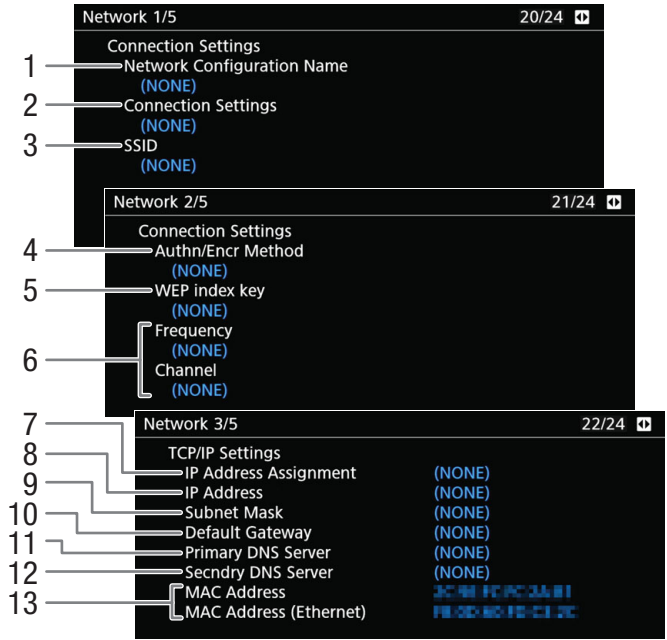

#### Connection settings of the current network connection (📖 161)

- 1 Network configuration name (📖 169)
- 2 Connection type
- 3 SSID (network name)
- 4 Authentication and encryption method
- 5 WEP index key
- 6 Wi-Fi frequency band and channel

#### TCP/IP settings of the current network connection (📖 163)

- 7 IP address assignment method
- 8 IP address
- 9 Subnet mask
- 10 Default gateway
- 11 Primary DNS server (assignment method/ IP address)
- 12 Secondary DNS server (assignment method/ IP address)
- 13 Camera's MAC address (wireless and Ethernet)



**[Network 4/5] and [Network 5/5] Status Screens (CAMERA mode only)**

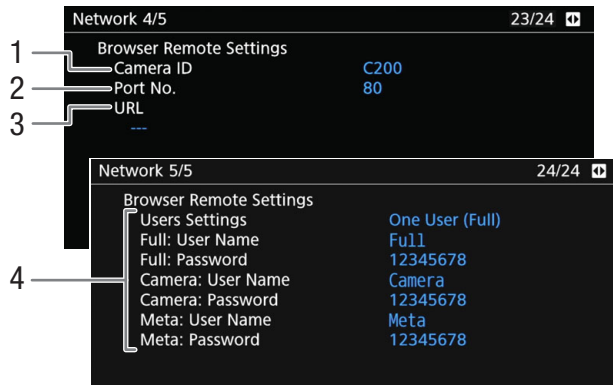

**Settings for Browser Remote (170)**

- 1 Camera ID
- 2 Port number
- 3 Camera's URL
- 4 User setting (170), user name and password settings

**[Network 4/6] to [Network 6/6] Status Screens (MEDIA mode only)**

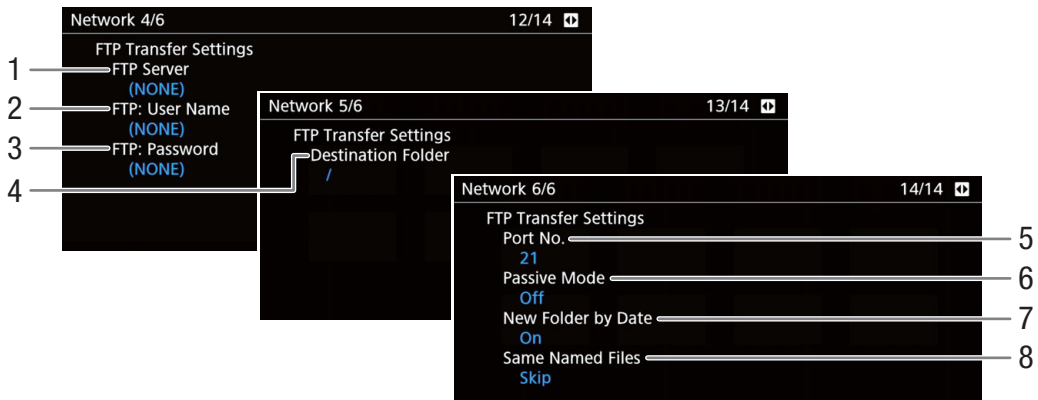

**FTP server settings (182)**

- 1 FTP server (host) name
- 2 User name
- 3 Password protection\*
- 4 Destination folder on the FTP server
- 5 Port number
- 6 Passive mode
- 7 Create new folders by transfer date
- 8 Handling of same-named files

\* The password itself will not be displayed.

[GPS Information Display] Status Screen (CAMERA mode only)

206

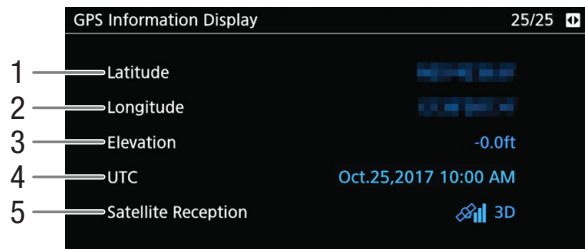

- 1 Latitude
- 2 Longitude
- 3 Elevation
- 4 UTC (coordinated universal time) date and time
- 5 Satellite signal strength

For details refer to *Recording GPS Information (Geotagging)* (📖 111).

## Troubleshooting

If you have a problem with your camera, refer to this section. Consult your dealer or a Canon Service Center if the problem persists.

### Power source

#### The camera will not turn on or it turns off by itself.

- The battery pack is exhausted. Replace or charge the battery pack.
- Remove the battery pack and reattach it correctly.

#### Shortly after turning it on, the camera turns off on its own.

- You are using a battery pack that is not compatible for use with this camera. Use a recommended battery pack (□ 223).

#### Cannot charge the battery pack.

- The temperature of the battery pack is outside the charging range. If the battery pack's temperature is below 0 °C (32 °F), warm it before charging it; if it is above 40 °C (104 °F), let the battery pack cool down before charging it.
- Charge the battery pack in temperatures between 0 °C and 40 °C (32 °F and 104 °F).
- The battery pack is faulty. Replace the battery pack.

#### The battery pack is exhausted extremely quickly even at normal temperatures.

- Check the [Battery/Hour Meter] status screen (□ 203) to check if the battery pack has reached the end of its battery life. If so, buy a new battery pack.

### Recording

#### The camera's controls are not responsive/disabled.

- The camera grip's plug may not be correctly connected to the camera. When attaching the camera grip to the camera, make sure the camera grip's plug is firmly inserted all the way into the connection terminal on the camera (□ 43). If you changed the angle of the camera grip, make sure you did not partially disconnect the plug by mistake.
- When the **POWER** switch is set to **Ⓐ**, all buttons (or all buttons with the exception of some REC buttons) are locked and cannot be operated. Set the **POWER** switch to CAMERA. You can change which controls are locked with the **MENU** ➤ [4] System Setup ➤ [Key Lock] setting (□ 194).

#### Pressing the REC button will not start recording.

- The recording media is full or it already contains the maximum number of clips (999 clips). Delete some clips (□ 147) or save your clips (□ 159) and initialize the recording media (□ 50) to free some space. Alternatively, replace the recording media.
- The REC button that was used may be disabled. Change the current settings in the **MENU** ➤ [4] System Setup ➤ [Camera REC Button] or [Camera Grip REC Button] setting to enable the use of the desired REC buttons.
- You may not be able to start or stop recording while controls on the optional RC-V100 Remote Controller are being operated. Stop using the remote controller and then press the REC button.

#### The point where the REC button was pressed does not match the beginning/end of the recording.

- There is a slight interval between pressing the REC button and the actual start/end of recording. This is not a malfunction.

#### The camera will not focus.

- The camera may not be able to focus on certain subjects using autofocus. Focus manually (□ 81).
- When the AF mode is set to AF-boosted MF, start focusing manually until the AF frame changes to white (automatic adjustment range).
- **C200** The viewfinder is not adjusted. Use the dioptic adjustment lever to make the proper adjustment (□ 40).
- The lens is dirty. Clean the lens with a soft lens-cleaning cloth.

#### When a subject flits across in front of the lens, the image appears slightly bent.

- This is a phenomenon typical of CMOS image sensors. When a subject crosses very quickly in front of the camera, the image may seem slightly warped. This is not a malfunction.

#### Bright red, green or blue dots appear on the screen.

- Try adjusting the black balance (□ 53). The camera's CMOS sensor is a delicate piece of precision engineering. Direct exposure of the sensor to ion rays or other types of cosmic radiation may affect it and this may rarely appear as bright colored dots on the screen. This is the nature of CMOS image sensors and does not represent a malfunction.
- The effects of the damage may be more noticeable when the camera is used in places subject to high temperatures, when a high ISO speed or gain level is used and when slow shutter speeds are used.

**Abnormal images appear on the screen and the camera cannot record properly.**

- While recording using an almost empty battery pack together with the AC adapter, the AC adapter was inadvertently disconnected or the power supply was suddenly interrupted. Reconnect the AC adapter and turn the camera off and then on again or replace the battery pack with a fully charged one.

**Changing between recording (● REC) and record standby (STBY) takes longer than usual.**

- When the recording media contains a large number of clips, some operations may take longer than usual. Save your clips (□ 159) and initialize the recording media (□ 50). Alternatively, replace the recording media.

**The camera cannot record to a recording media properly.**

- This may occur as recordings are made and deleted over time. Save your clips (□ 159) and initialize the recording media (□ 50).

**After using the camera for a long time, it becomes hot.**

- The camera may become hot after using it continuously for long periods of time; this is not a malfunction. If the camera becomes unusually hot or it becomes hot after using it only for a short while, it may indicate a problem with the camera. Consult a Canon Service Center.

## Playback

**Cannot delete a clip.**

- The LOCK switch on the SD card is set to prevent accidental erasure. Change the position of the LOCK switch.

**Deleting clips takes longer than usual.**

- When the recording media contains a large number of clips, some operations may take longer than usual. Save your clips (□ 159) and initialize the recording media (□ 50).

**Cannot delete a photo.**

- The LOCK switch on the SD card is set to prevent accidental erasure. Change the position of the LOCK switch.
- Photos that were protected using other devices cannot be deleted with the camera.

## Indicators and Onscreen Displays

 appears in red on the screen.

- Battery pack is exhausted. Replace or charge the battery pack.

 appears on the screen.

- The camera cannot communicate with the battery pack attached so the remaining battery time cannot be displayed.

**The tally lamp does not illuminate.**

- Set **MENU** ➤ [5] System Setup ➤ [LED] ➤ [Tally Lamp (Front)] or [Tally Lamp (Rear)] to [On].

**The tally lamp flashes quickly.**  (4 flashes per second)

- The battery pack is exhausted. Replace or charge the battery pack.
- There is not enough available space on the recording media. Delete some clips (□ 147) to free some space or replace the selected recording media.
- A system error has occurred. Turn the camera off and then on again. If this does not solve the problem, consult a Canon Service Center.

**The tally lamp flashes slowly.**  (1 flash per second)

- The combined available space on the CFast card or both SD cards is low. In the case of SD cards, replace the SD card that is not being recorded onto.

 appears in red on the screen.

- An SD card error occurred. Remove and reinsert the SD card. If the display does not change back to normal, save your recordings (□ 159) and initialize the SD card (□ 50).

/ [A]/ [B] appears in red on the screen followed by [END].

- The indicated recording media is full. Use a different recording media or delete some recordings (□ 122, 147) to free some space on the recording media.

**Even after stopping recording, the access indicator stays illuminated in red.**

- The clip is being recorded on the card. This is not a malfunction.

 appears in yellow on the screen.

- The camera's internal temperature has reached a predetermined level. You can continue using the camera.

**F** appears in red on the screen.

- The camera's internal temperature has risen further while **F** appeared in yellow on the screen.
- If the icon appears in red in **CAMERA** mode while **MENU** ➤ [5] System Setup ➤ [Fan] ➤ [Mode] is set to [Always On] or in **MEDIA** mode while **MENU** ➤ [4] System Setup ➤ [Fan Speed] is set to [High], turn off the camera and wait until the temperature has lowered.
- In **CAMERA** mode, if the fan mode is set to [Automatic] and the fan was turned off while recording, the fan will turn on automatically (in that case, **FAN** will appear on the screen).

**FAN** appears in red on the screen.

- The cooling fan may not be working properly. The camera will automatically turn off in approximately 10 minutes. Consult a Canon Service Center.

**LENS** appears on the screen.

- The camera and lens cannot communicate normally. Clean the lens's contacts and reattach the lens.

**B** appears in red on the screen.

- The lithium button battery's charge has been completely depleted. Save the camera's settings on an SD card (☐ 137) and replace the lithium button battery. Then, restore the camera's settings from the file saved on the SD card.

## Picture and Sound

**The screen of the monitoring device connected to the VIDEO terminal does not turn on.**

- Make sure the unit cable connecting the camera's VIDEO terminal and the monitoring device's VIDEO terminal is correctly connected on both sides.

**The peaking/magnification/zebra pattern/waveform monitor/B&W image does not appear on the screen.**

- Check that display of the desired assistance function is enabled on the screen used with the corresponding output settings.

**HDR video output to external monitors appears brighter now than before updating the firmware.**

- With the current firmware version, the camera follows the ITU-R BT.2408 report's recommendations regarding reference brightness levels for HDR output. The recordings themselves have not been changed.

**Screen displays turn on and off repeatedly.**

- The battery pack is exhausted. Replace or charge the battery pack.
- Remove the battery pack and reattach it correctly.

**Abnormal characters appear on the screen and the camera does not operate properly.**

- Disconnect the power source and reconnect it after a short time. If the problem still persists, use the **MENU** ➤ [1] System Setup ➤ [Reset] ➤ [All Settings] function. This resets all the camera's settings to default values, except for the hour meter.

**Video noise appears on screen.**

- Keep a distance between the camera and devices that emit strong electromagnetic fields such as near powerful magnets and motors, MRI machines or high-voltage power lines.

**Horizontal bands appear on the screen.**

- This is a phenomenon typical of CMOS image sensors when recording under some types of fluorescent, mercury or sodium lamps. This is not a malfunction. You may be able to reduce the symptoms by setting the shutter speed mode to [Speed] and the shutter speed to a value matching the frequency of the local electrical system: 1/50\* or 1/100 for 50 Hz systems, 1/60 or 1/120 for 60 Hz systems.

\* May not be available depending on the frame rate.

**Audio cannot be recorded.**

- The audio input selection switch of the INPUT terminal is in the AES/EBU position but an analog audio source is connected, or it is set to the ANALOG position and a digital audio source is connected. Set the audio related switches correctly according to the audio source you wish to use (☐ 99).
- When using the INPUT 1/INPUT 2 terminals, make sure you are using an XLR connector. When using the MIC terminal, make sure you are using a condenser microphone with its own power supply and a Ø 3.5 mm stereo mini plug.
- The external microphone connected to the INPUT 1/INPUT 2 terminal requires phantom power. Set the corresponding INPUT 1/INPUT 2 audio input selection switch to MIC+48V (☐ 99).

**Audio is recorded at an extremely low level.**

- When using the INPUT 1/INPUT 2 terminals or MIC terminal: The audio level switch for CH1 or CH2 is set to M, and the recording level is set too low. Check the audio level meter on the screen and adjust the audio level correctly (☐ 101).
- The microphone attenuator is on. Turn off the microphone attenuator (☐ 103).

**Sound is distorted or is recorded at lower levels.**

- When recording near loud sounds (such as fireworks, shows or concerts), sound may become distorted or it may not be recorded at the actual levels. Activate the microphone attenuator (☞ 103), or adjust the audio recording level manually.

**Recording Media and Accessories**

**Cannot insert the recording media.**

- The CFast card or SD card you are trying to insert is not facing the correct direction. Turn it over and insert it.

**Cannot record on the CFast card.**

- A compatible CFast card must be used (☞ 47).
- Initialize the CFast card (☞ 50) when you use it with the camera for the first time.
- The CFast card is full or it already contains the maximum number of clips (999 clips). Delete some clips (☞ 147) to free some space or replace the CFast card.

**Cannot record on the SD card.**

- A compatible SD card must be used (☞ 47).
- Initialize the SD card (☞ 50) when you use it with the camera for the first time.
- The LOCK switch on the SD card is set to prevent accidental erasure. Change the position of the LOCK switch.
- Photos can be recorded only to SD card B. Insert an SD card into SD card slot B.
- The SD card is full or it already contains the maximum number of clips (999 clips). Delete some recordings (☞ 122, 147) to free some space or replace the SD card.
- The folder and file numbers for MP4 clips and photos have reached their maximum value. Set **MENU** ➤ [4] Recording/Media Setup] ➤ [MP4 Clip/Photo Numbering] to [Reset] and insert a new SD card.

**Recording to and playing back from a CFast card is slow.**

- This may occur as video is recorded/deleted over time. Save your clips (☞ 159) and initialize the CFast card (☞ 50).

**Recording to and playing back from an SD card is slow.**

- This may occur as clips and photos are recorded/deleted over time. Save your recordings (☞ 159) and initialize the SD card (☞ 50).

**The optional RC-V100 Remote Controller or commercially available remote control does not work.**

- Make sure that **MENU** ➤ [1] System Setup] ➤ [REMOTE Term.] is set to [RC-V100 (REMOTE A)] when using the optional RC-V100 Remote Controller or [Standard] when using a commercially available remote control.
- Turn off the camera, reconnect the remote controller and then turn the camera back on again.
- When **MENU** ➤ [1] Custom Picture/HDR] ➤ [Activate Other Settings] is set to [Off] or the currently selected custom picture file is protected, detailed custom picture settings cannot be adjusted using the RC-V100. Set [Activate Other Settings] to [On] after selecting a custom picture file that is not protected (☞ 129).

**Connections with External Devices**

**Video noise appears on a nearby TV screen.**

- When using the camera in a room where a TV is located, keep a distance between the AC adapter and the power or antenna cables of the TV.

**Playback looks fine on the camera but there is no image on the external monitor.**

- The camera is not connected correctly to the external monitor. Make sure you are using the correct connection (☞ 152).
- The video input on the external monitor is not set to the video terminal to which you connected the camera. Select the correct video input.

**The computer does not recognize the camera even though the camera is connected correctly.**

- Disconnect the USB cable and turn off the camera. After a short while, turn it on again and restore the connection.
- Connect the camera to a different USB port on the computer.
- Establish a USB connection while the [MP4] or [Photo] index screen is displayed.

**Cannot transfer MP4 clips or photos to the computer.**

- The SD card contains too many MP4 clips and photos. Delete MP4 clips or photos until the SD card contains a combined total of 2,500 (Windows)/1,000 (macOS) or fewer and then use a card reader to transfer the recordings from the SD card.

**There is no picture or sound from an external monitor connected to the SDI terminal**

- If an HDMI cable is connected to the HDMI OUT terminal, disconnect it.
- Check that the external monitor's settings match the configuration of the output signal selected on the camera (☞ 149).

**There is no picture or sound from an external monitor connected to the HDMI OUT terminal**

- Disconnect the HDMI cable and then restore the connection or turn the camera off and then on again.

**The peaking/B&W image/magnification/zebra pattern/waveform monitor/onscreen markers do not appear on the viewfinder or in the video from the VIDEO terminal.**

- Check that that display of the desired assistance function is enabled for the desired output device or terminal.

**Magnification/waveform monitor/onscreen markers do not appear in the video from the SDI terminal.**

- Check that that display of the desired assistance function is enabled for the SDI terminal.

**Magnification/onscreen markers do not appear in the video from the HDMI terminal.**

- Check that that display of the desired assistance function is enabled for the HDMI terminal.

## Network Functions

### Check This First

- Are the access point (wireless router), camera, computer or other network devices all turned on?
- Is the network working and correctly configured?
- Are all network devices correctly connected to the same network as the camera?
- Are there any obstructions between the camera and the access point or between the network device used and the access point?

### Cannot connect with an access point.

- There are other devices in the vicinity interfering with the wireless signal. Remove the camera grip and then set up the network-related settings again. If this does not solve the problem, refer to *Precautions Regarding Wi-Fi Networks* (□ 212).
- Password information is not saved with the camera settings. When you load onto the camera settings from an SD card, all the passwords in the network-related settings are reset. Set up the network-related settings as necessary (□ 162).
- Check that the settings on the network device the camera is trying to connect with are correct.

### Cannot establish a Camera Access Point connection with a network device.

- There are other devices in the vicinity interfering with the wireless signal. Remove the camera grip and then set up the network-related settings again. If this does not solve the problem, refer to *Precautions Regarding Wi-Fi Networks* (□ 212).
- When you reset all the camera settings, all network settings are lost as well. Set up the Camera Access Point settings again (□ 163).

### Cannot connect with a wired (Ethernet) network.

- Use a category 5e or better shielded twisted pair (STP) Ethernet cable.
- Try replacing the Ethernet cable.
- When you reset all the camera settings, all network settings are lost as well. Set up the network settings again (□ 162).
- Check that the network device to which the camera is connected is on and functioning properly. To use 1000BASE-T connection speeds, make sure to use network devices compatible with Gigabit Ethernet (1000BASE-T).

### The Browser Remote application will not start on the Web browser.

- Make sure Browser Remote is activated (□ 171).
- The URL entered into the Web browser's address bar is incorrect. Be sure to use the URL exactly as it appears in the [Network 4/5] status screen (□ 205).

### The Browser Remote screen is not displayed correctly on the Web browser.

- The device, operating system or Web browser used may not be supported. For the latest information about supported systems, visit your local Canon Web site.
- Enable JavaScript and cookies in your Web browser's settings. For details, refer to the help modules or online documentation of the Web browser used.
- Delete the cache and cookies for Browser Remote's URL in your Web browser and restart Browser Remote.

## Precautions Regarding Wi-Fi Networks

When using a Wi-Fi network, try the following corrective actions if the transmission rate drops, the connection is lost, or other problems occur.

### Positioning a network device (access point, mobile device, etc.)

- When using a Wi-Fi network indoors, place the network device in the same room as the camera.
- Place the network device in an open, unobstructed location, where people or objects do not come between it and the camera.
- Place the network device as close as possible to the camera. Change the height or facing of the network device, as necessary.

### Nearby electronic devices

- If the transmission rate over a Wi-Fi network drops because of interference from the following electronic devices, switching to the 5 GHz band or to a different channel may solve the problem.
- Wi-Fi networks using the IEEE 802.11b/g/n protocol operate in the 2.4 GHz band. For this reason, the transmission rate may drop if there are nearby microwave ovens, cordless telephones, microphones, or similar devices operating on the same frequency band.
- If another access point operating on the same frequency band as the transmitter is used nearby, the transmission rate may drop.

### Using multiple cameras/wireless transmitters/access points

- Check that there are no IP address conflicts among the devices connected to the same network.
- If multiple C200 / C200B cameras are connected to a single access point, connection speeds may be reduced.
- To reduce radio wave interference when there are multiple access points using IEEE 802.11b/g or IEEE 802.11n (in the 2.4 GHz band), leave a gap of four channels between each wireless access point. For example, use channels 1, 6, and 11, channels 2, 7, and 12, or channels 3, 8, and 13. If you can use IEEE 802.11a/n (in the 5 GHz band), switch to IEEE 802.11a/n and specify a different channel.

## List of Messages

Refer to this section if a message appears on the screen. The messages in this section appear in alphabetical order. Note that for some messages, an indication of the recording media involved (SD card A, SD card B, CFast, or a combination thereof) may appear above the message itself.

### Accessing CFast/SD Card A/SD Card B Do not remove

- You opened the CFast card slot cover or SD card slot cover while the camera was accessing the recording media. Close the card slot cover.

### Battery communication error. Does this battery display the Canon logo?

- This may be due to using a battery pack not recommended by Canon for use with this camera.
- If you are using a battery pack recommended by Canon for use with this camera, there may be a problem with the battery pack or camera. Consult a Canon Service Center.

### Buffer overflow. Recording was stopped.

- The data transfer rate was too high for the recording media in use and the recording was stopped. Use a recommended recording media (□ 47).

### Camera ↔ Lens communication error. Clean the lens's contacts and reattach the lens.

- The camera cannot correctly communicate with the lens due to dirty lens contacts. After the message disappears, the **LENS** icon appears on the screen. Clean the lens contacts with a soft cloth and reattach the lens.

### Cannot play back

- The recording media contains clips that were recorded using a system frequency different from the one currently used by the camera. To play back the recordings on the card, change the **MENU** ➤ [1] Recording/Media Setup] ➤ [System Frequency] setting to match the recordings on the recording media.
- The XF-AVC clip's file control information\* is corrupted or there was a decoder error. Turn the camera off and then on again. If this does not solve the problem, consult a Canon Service Center.

\* Corrupted file control information cannot be recovered. Memory cards or XF-AVC clips with corrupted file control information cannot be read by the software (Canon XF Utility or plugins for NLE applications).

### Cannot switch SD card slots







- The SLOT SELECT button was pressed while the camera is recording. Wait until recording is finished to change the selected SD card slot.

### Change the battery pack

- The battery pack is exhausted. Replace or charge the battery pack.



**Check CFast/SD Card A/SD Card B**

- Cannot access the recording media. Check the recording media and make sure it is inserted correctly.
- A recording media error occurred. The camera cannot record or display the image. Try removing and reinserting the recording media, or use a different recording media.
- You inserted a MultiMedia Card (MMC) into the camera. Use a recommended SD card (□ 47).
- If after the message disappears, ,  or  appears in red, perform the following: Turn off the camera and remove and reinsert the recording media. ,  or  turns back to green you can resume recording/playback. If the problem persists, save your recordings (□ 159) and initialize the recording media (□ 50).

**Check the connection of the camera grip**

- The camera grip may not be attached correctly. Check the connection.



**Cover is open**

- The CFast card slot cover or SD card slot cover was open when the camera was switched to or turned on in  mode. Insert a card and close the card slot the cover.





**Fan error**

- The cooling fan may not be working properly. Consult a Canon Service Center.

**File name error**

- You attempted to record a clip while clip numbers are at their maximum value. Save your clips (□ 159) and initialize the recording media (□ 50) or delete all the clips (□ 147).
- You attempted to take a photo while photo numbers are at their maximum value. Set **MENU**  [4 Recording/Media Setup]  [MP4 Clip/Photo Numbering] to [Reset] and delete all the photos on the SD card (□ 122) or initialize it (□ 50).

**Invalid operation**

- The following operations cannot be performed.
  - Adding a shot mark to a frame that already has a shot mark or to a clip in frame recording mode or interval recording mode.
  - Adding an  mark to a clip that already has an  mark or adding a  mark to a clip that already has a  mark.
  - Pressing the REC button when there are no recording media in the camera.

**Lens error Change the frame rate**

- The lens attached to the camera is not compatible for shooting at the frame rate selected on the camera. Select a different the frame rate (□ 64).

**Lens error Turn the camera off, then on again.**

- There was a communication error between the camera and the lens. Turn the camera off and then on again.

**Lens firmware update Firmware update failed. Try updating again.**

- The lens's firmware could not be correctly updated. Try updating the lens's firmware again.

**May not be possible to record clips on this media**

- The SD card selected for recording has a Speed Class rating of 4 or lower (when the main recording format is MP4) or 6 or lower (when the main recording format is XF-AVC). Use a recommended SD card (□ 47).

**Media full**

- The recording media is full. Replace the recording media or delete some recordings (□ 122, 147) to free some space on the recording media.
- SD card A or SD card B is full so recording will not start. Switch to the SD card in the other SD card slot to record.

**Media is almost full**

- The amount of available space on the recording media is low. Replace the recording media or delete some recordings (□ 122, 147) to free some space on the recording media.
- The amount of available space on SD card A and SD card B combined is low. Replace the SD card that is not selected.

**Media is not supported**

- 600 MB or smaller CFast cards and 256 MB or smaller SD cards cannot be used with the camera. Use a recommended recording media (□ 47).

**Memory card is write-protected**

- The LOCK switch on the SD card is set to prevent accidental erasure. Change the position of the LOCK switch.

**Noise levels will rise on the image of the sub recording and on video outputs not in RAW.**

- The primary recording format is set to RAW and [Gamma] in the custom picture file is set to an option other than [Canon Log] or [Canon Log 3]. Under such conditions, there will be more noise on video recorded with proxy recording clips on the SD card and on video output from the SDI terminal. If you do not need to record RAW video, change the primary recording format.

**Number of clips already at maximum**

- The recording media selected for recording already contains the maximum number of clips (999 clips). Replace the recording media.

**Number of Shot Marks at maximum**

- The shot mark could not be added because the clip already contains 100 shot marks.

**Power Zoom Adapter Check the power supply.**

- The power zoom adapter's remaining battery charge is low. Replace the power zoom adapter's batteries.

**Power Zoom Adapter Temperature too high. Cannot perform task.**

- The power zoom adapter cannot be operated because its temperature is too high. Stop using the power zoom adapter and let it cool down before using it again.

**Recommend checking the data and initializing**

- The recording media cannot be used for any of the following reasons. Save your clips (☐ 159) and initialize the recording media (☐ 50).
  - A problem has occurred with the recording media.
  - The camera cannot read the data on the recording media.
  - The recording media was initialized using a computer.
  - The recording media is partitioned.
- The recording media was initialized using a camera with a different firmware version. To be able to record on the recording media, save the recordings it contains and then initialize it using this camera.

**Recording was stopped.**

- The file control information is corrupted or there was an encoder error. Turn the camera off and then on again. Then, remove the recording media being used and reinsert it. Alternatively, replace the CFast card. If this does not solve the problem, consult a Canon Service Center.

**SD Card A→SD Card B / SD Card B→SD Card A Switched**

- This message appears when you use the SLOT SELECT button to switch the SD card slot in use or recording continued from one SD card to the other.

**SD Card A→SD Card B / SD Card B→SD Card A Will switch in a moment**

- The SD card is almost full so recording will continue on the other SD card in approximately 1 minute.

**Some clips require data recovery.**

- While recording, the camera's power stopped or the memory card was removed, causing an error with the XF-AVC clip. Try recovering the clip (☐ 52).

**The memory card is not compatible with the current recording settings.**

- When recording MP4 or XF-AVC clips, an SD card that is not compatible with UHS Speed Class 3 is in the selected SD card slot while **MENU** ➤ [☐ 2] Recording/Media Setup] ➤ [Resolution/Color Sampling] is set to [3840x2160 YCC420 8 bit]. Replace the SD card with one that supports a UHS Speed Class rating of 3 or set the resolution/bit rate to [1920x1080 YCC420 8 bit].

**The number of ND filters used has changed. Check the focus.**

- When using ND filter settings in the extended range (8 stops or 10 stops), the number of ND filters used changes and this may result in a shift in focus. Check the focus before resuming shooting.

**The video configuration was changed. Check the settings.**

- One or more of the video configuration settings may have changed automatically due to a change in the recording or media settings. Check the settings before you continue recording.

**This function is not compatible with the current lens.**

- The selected setting is not compatible with the lens currently attached to the camera and cannot be used.

**Too many photos and MP4 movies. Disconnect the USB cable.**

- Disconnect the USB cable. Try using a memory card reader or decrease the number of photos and clips on the memory card to fewer than 2,500 (Windows) or 1,000 (macOS) and then restore the connection.

**Unable to recover data**

- Could not recover the selected clip. Save your clips (☐ 159) and delete the clips that could not be recovered (☐ 147).
- The camera may not be able to recover clips when there is not enough space on the recording media. Delete some clips (☐ 147) to free some space.

## Wi-Fi Functions

Along with this list, refer also to the instruction manuals of the access point or other external devices you are using.

### A User is already accessing the server. Try again later.

- This message appears on the screen of the connected device. Another device connected to the network is already operating the camera. To use this device, first end the connection on the device accessing the camera and then touch Retry.

### Cannot log in to FTP server.

- Check the user name and password information in the FTP server settings (□ 182).

### Cannot transfer files to FTP server.

- Check that there is enough available space in the data storage device (hard disk, etc.) that contains the destination folder on the FTP server.

### FTP transfer error. File transfer was not completed.

- An error occurred while transferring files to the FTP server. Turn then camera and the FTP server off and then on again and try again the FTP transfer.

### IP address conflict

- Another device on the same network has the same IP address assigned to the camera. Change the IP address of the conflicting device or the camera.

### LAN cable not connected.

- You attempted to connect to a wired network but the Ethernet cable is not connected. Check that the Ethernet cable is correctly connected to the camera's  (Ethernet) terminal and to the LAN/Ethernet port on the network device.

### Multiple access points detected. Try the operation again.

- There are multiple access points sending out a WPS signal at the same time. Try the operation again later or perform setup using the [WPS: PIN Code] or [Search for Access Points] option (□ 165).

### Network is not working correctly

- There's a hardware problem with the camera's network related circuitry. Try turning the camera off and the on again. If the problem persists, consult a Canon Service Center.

### No access points found

- The camera searched for active Wi-Fi networks (access points) in the area but none were found. Make sure the access point is working correctly and try connecting again.
- The access point is operating in stealth mode. Deactivate the stealth function in the wireless router (access point) settings.
- The connection wizard may not be able to find the access point if MAC address filtering is activated. Check the [Network 3/5] status screen (□ 196) and make sure to add the camera's MAC address to the list of approved wireless devices in the wireless router (access point) settings.

### Reached the end of the adjustment range

- This appears on the screen of the connected device. When focusing with Browser Remote, this message will appear when a focus adjustment would push the focus out of the lens's available range.

### Some files could not be transferred.

- The file system is corrupted or you attempted to transfer clips not recorded with this camera. Delete those clips from the SD card and then transfer the files again (□ 182).
- The destination folder contains files with the same file name as those to be transferred. Rename the files or set **MENU** ➤ [1] Network Settings] ➤ [FTP Transfer Settings] ➤ [Same Named Files] to [Overwrite] to overwrite the files in the destination folder.

### Unable to complete WPS. Try the operation again.

- More than 2 minutes passed between activating WPS on the access point and selecting [OK] on the camera. Start over the WPS procedure from the beginning.
- The WPS button was not held down long enough. Refer to the instruction manual of your wireless router. When using WPS to make a wireless connection, keep the WPS button held down until the wireless router's WPS function is activated.
- The access point's encryption method is set to [WEP]. Wi-Fi Protected Setup (WPS) cannot connect to access points set to this encryption method. Change the access point's encryption method or use another connection method (□ 162).
- Turn off the camera and access point, turn them back on again and then start over the WPS procedure from the beginning. If this does not solve the problem, try using the [Search for Access Points] option (□ 166).

**Unable to connect**

- Could not connect to the access point or network device selected.
- Cordless phones, microwave ovens, refrigerators and other appliances may interfere with the wireless signal. Try using the camera in a location farther away from such appliances.

216

**Unable to connect to FTP server.**

- Could not connect to the FTP server. Check the FTP server settings (📖 182).

**Unable to obtain an IP address**

- If you are not using a DHCP server, connect using the [Manual] option and enter the IP address using the [Manual] option (📖 167).
- Turn on the DHCP server. If it is already on, make sure it is functioning properly.
- Make sure the address range for the DHCP server is sufficient.
- If you are not using a DNS server, set the DNS address to one other than [0.0.0.0].
- Set the DNS server's IP address in the camera.
- Turn on the DNS server. If it is already on, make sure it is functioning properly.
- Make sure that the DNS server's IP address and the name for that address are correctly configured.
- If you are using a wireless gateway router, make sure all of the devices in the network, including the camera, are configured with the correct gateway address.

**Wi-Fi connection terminated**

- An error occurred on the access point or connected device. Check the network or connected device and try connecting again.
- The Wi-Fi signal became too weak and the wireless connection was lost. Wait a moment or turn off other devices in the area that may be interfering with the Wi-Fi signal and then try connecting again.

**Wi-Fi error. Incorrect authentication method**

- Check the access point's authentication/encryption method and change the camera's Wi-Fi settings (📖 169) as necessary.

**Wi-Fi error. Incorrect encryption key.**

- When the authentication mode was set to [WPA-PSK], [WPA2-PSK] or [Shared Key], or the encryption method was set to [WEP], the encryption key (for WEP, AES or TKIP encryption) entered or its length (number of characters) is incorrect.
  - Valid passwords vary depending on the encryption method:
    - 64-bit WEP encryption: 5 ASCII characters or 10 hexadecimal characters.
    - 128-bit WEP encryption: 13 ASCII characters or 26 hexadecimal characters.
    - AES / TKIP encryption: 8 to 63 ASCII characters or 64 hexadecimal characters.

**Wi-Fi error. Incorrect encryption method**

- Make sure the camera and access point are using the same authentication/encryption method.

## Handling Precautions and Safety Instructions

Be sure to read these instructions in order to operate the product safely. Follow these instructions to prevent injury or harm to the operator of the product or others.

### WARNING

**Denotes the risk of serious injury or death.**

- Stop using the product in any case of unusual circumstances such as the presence of smoke or a strange smell.
- Do not touch any exposed internal parts.
- Do not get the product wet. Do not insert foreign objects or liquids into the product.
- Do not touch the product connected to a power outlet during lightning storms. This may cause electric shock.
- Do not disassemble or modify the product.
- Do not expose the product to strong shocks or vibration.
- Use only power sources specified in this instruction manual for use with the product.
- Observe the following instructions when using a battery charger or AC adapter.
  - Do not touch the battery charger or AC adapter connected to a power outlet during lightning storms.
  - Do not use the product if the power plug is not fully inserted into the power outlet.
  - Do not unplug the product by pulling the power cord.
  - Do not plug in or unplug the product with wet hands.
  - Do not place heavy objects on the power cord. Do not damage, break or modify the power cord.
  - Do not leave the product connected to a power source for long periods of time.
- Do not expose the terminals to dirt or let them come into contact with metallic pins or other metal objects.
- Do not charge batteries/battery packs at temperatures outside the range of 0 - 40 °C (32 - 104 °F).
- Observe the following instructions when using commercially available batteries or provided battery packs.
  - Do not use leaking batteries/battery packs.
  - If a battery/battery pack leaks and the material contacts your skin or clothing, flush the exposed area thoroughly with running water. In case of eye contact, flush thoroughly with copious amounts of clean running water and seek immediate medical assistance.
  - Use batteries/battery packs only with their specified product.
  - Do not heat batteries/battery packs or expose them to fire.
  - Do not charge batteries/battery packs using non-authorized battery chargers.
  - Do not expose the terminals to dirt or let them come into contact with metallic pins or other metal objects.
  - When disposing of batteries/battery packs, insulate the terminals with tape or other means.
- **C200** Do not look through the viewfinder at strong light sources such as the sun on a bright day or lasers and other strong artificial light sources.
- Do not leave a lens or a camera/camcorder with a lens attached, exposed without the lens cap attached. The lens may concentrate the light and cause fire.
- Do not wrap the product in cloth or other materials when in use or shortly after use when the product is still warm in temperature.
- Do not allow the product to maintain contact with the same area of skin for extended periods of time during use. This may result in low-temperature contact burns, including skin redness and blistering, even if the product does not feel hot. The use of a tripod or similar equipment is recommended when using the product in hot places and for people with circulation problems or less sensitive skin.
- Keep the product out of the reach of young children.  
A strap wrapped around a person's neck may result in strangulation.
- Periodically remove any dust buildup from the power plug and power outlet using a dry cloth.
- Follow any indications to turn off the product in places where its use is forbidden. Not doing so may cause other equipment to malfunction due to the effect of electromagnetic waves and even result in accidents.

**⚠ CAUTION**

**Denotes the risk of injury.**

- Strap is intended for use on the body only. Hanging the strap with any product attached on a hook or other object may damage the product. Also, do not shake the product or expose the product to strong impacts. This may cause injury or damage to the product.
- Do not leave the product in places exposed to extremely high or low temperatures. The product may become extremely hot/cold and cause burns or injury when touched.
- Only mount the product on a tripod that is sufficiently sturdy.

## Camera

Be sure to observe the following precautions to ensure maximum performance.

- Do not carry the camera by the LCD panel. Be careful when closing the LCD panel.
- Do not leave the camera in places subject to high temperatures (like the inside of a car parked under direct sunlight), or high humidity.
- Do not hold the camera in the same posture for long periods of time as this may cause low-temperature contact burns. Even if the camera does not feel too hot, prolonged contact with the same body part may cause skin redness or blistering. The use of a tripod is recommended for people with circulation problems or very sensitive skin, or when using the camera in very hot places.
- Do not use the camera near strong electromagnetic fields such as near powerful magnets and motors, MRI machines or high-voltage power lines. Using the camera in such places may cause anomalies in the video, or audio or video noise to appear.
- Do not use or store the camera in dusty or sandy places. The camera is not waterproof – avoid also water, mud or salt. If any of the above should get into the camera it may damage the camera and/or the lens. Consult a Canon Service Center as soon as possible.
- Be careful to avoid dust and dirt particles accumulating on the lens or entering the camera. When you finish using the camera, make sure to attach the body cap to the lens mount and the lens cap and dust cap to the lens.
- Do not point the camera or viewfinder toward an intense light source, such as the sun on a sunny day or an intense artificial light source. Doing so may damage the image sensor or the camera's internal components. Be careful especially when using a tripod or shoulder strap. When you are not using the camera or viewfinder, make sure to attach the lens cap to the lens and the viewfinder cap to the viewfinder.
- Be careful of heat generated by lighting equipment.
- Do not disassemble the camera. If the camera does not function properly, consult qualified service personnel.
- Do not touch the lens contacts on the lens mount. Dirty contacts may cause a poor contact between the camera and the lens resulting in incorrect operation of the camera. After removing the lens, make sure to attach the body cap to the lens mount and the lens cap and dust cap to the lens.
- Handle the camera with care. Do not subject the camera to shocks or vibration as this may cause damage. When using the shoulder strap, do not allow the camera to swing and hit an object.

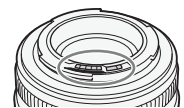

### Long-term storage

If you do not intend to use the camera for a long time, store it in a place free of dust, in low humidity, and at temperatures not higher than 30 °C (86 °F).

## Battery Pack

**DANGER!**

Treat the battery pack with care.

- Keep it away from fire (or it might explode).
- Do not expose the battery pack to temperature higher than 60 °C (140 °F). Do not leave it near a heater or inside a car in hot weather.
- Do not try to disassemble or modify it.
- Do not drop it or subject it to shocks.
- Do not get it wet.

- Dirty terminals may cause a poor contact between the battery pack and the camera. Wipe the terminals with a soft cloth.

### Long-term storage

- Store battery packs in a dry place at temperatures no higher than 30 °C (86 °F).
- To extend the battery life of the battery pack, discharge it completely before storing it.
- Charge and discharge all your battery packs fully at least once a year.

### Always attach the battery terminal cover.

Do not allow any metal objects to touch the terminals (Figure 1), as this can cause a short circuit and damage the battery pack. Attach the terminal cover whenever the battery pack is not being used (Figure 2).

The battery terminal cover has a [ ]-shaped hole. This is useful when you wish to differentiate between charged and uncharged battery packs. For example, with charged battery packs, attach the terminal cover so that the [ ]-shaped hole shows the colored label.

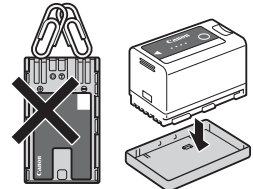
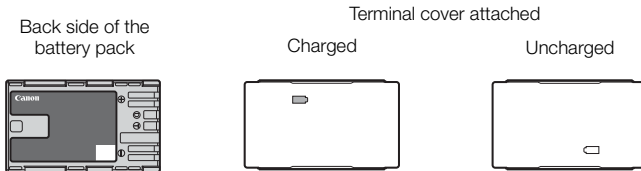

Figure 1

Figure 2



### Remaining battery time

If the remaining battery time displayed is not correct, deplete the battery pack completely and then charge it fully. Still, the correct time may not be displayed if a fully charged battery pack is used continuously in high temperatures or it is left unused for long periods of time. Also, the correct remaining time may not be displayed, depending on the battery life. Use the time shown on the screen as an approximation.

## Lithium Button Battery

### WARNING!

- The battery used in this device may present a fire or chemical burn hazard if mishandled.
- Do not disassemble, modify, immerse in water, heat above 100 °C (212 °F) or incinerate the battery.
- Do not insert the battery into the mouth. If swallowed, seek medical assistance immediately. The battery case may break and the battery fluids may cause internal injuries.
- Keep the battery out of the reach of children.
- Do not recharge, short-circuit or insert the battery in the wrong direction.
- Dispose of the used battery according to applicable recycling regulations. In Europe, the used battery should be returned to the supplier for safe disposal.

- Do not pick up the battery using tweezers or other metal tools, as this will cause a short circuit.
- Wipe the battery with a clean dry cloth to ensure proper contact.
- For CA, USA only  
Included lithium battery contains Perchlorate Material - special handling may apply.  
See [www.dtsc.ca.gov/hazardouswaste/perchlorate/](http://www.dtsc.ca.gov/hazardouswaste/perchlorate/) for details.

## Recording Media

- We recommend backing up the recordings on the recording media onto your computer. Data may be corrupted or lost due to defects or exposure to static electricity. Canon shall not be liable for lost or corrupted data.
- Do not touch or expose the terminals to dust or dirt.
- Do not use recording media in places subject to strong magnetic fields.
- Do not leave recording media in places subject to high humidity and high temperature.
- Do not disassemble, bend, drop, or subject recording media to shocks and do not expose them to water.
- Check the direction before inserting the recording media. Forcing recording media into the slot if it is not correctly oriented may damage the recording media or the camera.
- Do not attach any labels or stickers on the recording media.

## Disposal

When you delete data on the recording media, only the file allocation table is altered and stored data is not physically erased. Take the necessary precautions when you dispose of the recording media, for example by physically damaging it to prevent the leakage of private data.

If giving the recording media to another person, initialize it. Fill it up with unimportant recordings, and then initialize it again. This makes recovering the original recordings very difficult.

## Built-in Rechargeable Lithium Battery

The camera has a built-in rechargeable lithium battery to keep the date/time and other settings. The built-in lithium battery is recharged while you use the camera; however, it will discharge completely if you do not use the camera for about 3 months.

**To recharge the built-in lithium battery:** Connect the DC cable and AC adapter to the camera and use a power outlet to power the camera for 24 hours while it is turned off.



---

## Maintenance/Others

### Cleaning

#### Camera Body

- Use a soft, dry cloth to clean the camera's body. Never use chemically treated cloths or volatile solvents such as paint thinner.

#### Lens

- Remove any dust or dirt particles using a non-aerosol type blower brush.
- Use a clean, soft lens-cleaning cloth to gently wipe the lens. Never use tissue paper.

#### LCD Screen

- Clean the LCD screen using a clean, soft lens-cleaning cloth and commercially available cleaning fluid for eyeglasses.
- Condensation may form on the surface of the screen when the temperature changes suddenly. Wipe it with a soft dry cloth.

### Condensation

Moving the camera rapidly between hot and cold temperatures may cause condensation (water droplets) to form on its internal surfaces. Stop using the camera if condensation is detected. Continued use may damage the camera.

#### Condensation may form in the following cases:

- When the camera is moved quickly from cold to warm places
- When the camera is left in a humid room
- When a cold room is heated rapidly

#### To avoid condensation

- Do not expose the camera to sudden or extreme changes in temperature.
- Remove the recording media and battery pack. Then, place the camera in an airtight plastic bag and let it adjust gradually to temperature changes before removing it from the bag.

#### When condensation is detected

The precise time required for water droplets to evaporate will vary depending on the location and weather conditions. As a general rule, wait for 2 hours before resuming use of the camera.

### Using the Camera Abroad

#### Power Sources

You can use the AC adapter to operate the camera and the battery charger to charge battery packs in any country/region with power supply between 100 and 240 V AC, 50/60 Hz. Consult a Canon Service Center for information on plug adapters for overseas use.

## Optional Accessories

The following optional accessories are compatible with this camera. The availability differs from area to area.

222

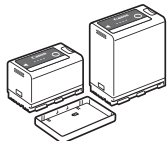

BP-A30, BP-A60  
Battery Pack

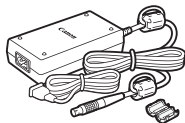

CA-A10 AC Adapter

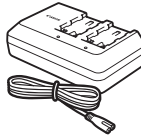

CG-A10 Battery Charger

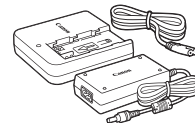

CG-A20 Battery Charger  
and CA-CP200B  
Compact Power Adapter



LM-V1 LCD Monitor



LM-V2 LCD Monitor

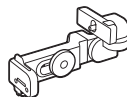

LA-V1 LCD  
Attachment Unit

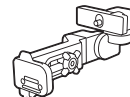

LA-V2 LCD  
Attachment Unit



GR-V1 Camera Grip



HDU-2 Handle Unit



RD-1 Rod Clamp

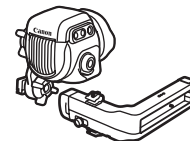

EVF-V70 OLED Electronic  
Viewfinder\*

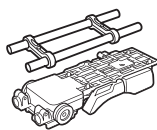

SU-15 Shoulder Support Unit

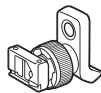

CL-V2 Clamp Base



UN-5 Unit Cable (50 cm, 1.6 ft.)/  
UN-10 Unit Cable (1 m, 3.3 ft.)



RC-V100  
Remote Controller



TB-1 Tripod Adapter Base



GP-E2 GPS Receiver

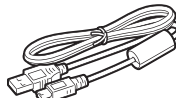

IFC-400PCU  
USB Cable

\* When attaching this accessory to the camera, the optional CL-V2 Clamp Base is required.

**For our customers in the USA:** Call or visit your local retailer/dealer for genuine Canon video accessories. You can also obtain genuine accessories for your Canon camera by calling: 1-800-828-4040, Canon U.S.A. Information Center.

**Use of genuine Canon accessories is recommended.**

The message [Battery communication error] is displayed if you use a non-genuine Canon battery pack, and user response is required. Note that Canon shall not be liable for any damages resulting from accidents, such as malfunction or fire, that occur due to use of non-genuine Canon battery packs.

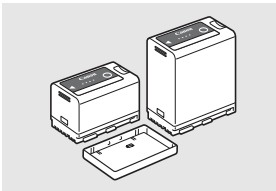

**Battery Packs**

When you need extra battery packs, select only the BP-A30 or BP-A60 Battery Pack.



This mark identifies genuine Canon video accessories. When you use Canon video equipment, we recommend Canon-brand accessories or products bearing the same mark.

**i** NOTES

- You can have the camera's EF lens mount replaced by a PL lens mount. For details, consult the retail dealer from whom you purchased the camera or contact a Canon Service Center.

## Specifications

### C200 / C200B

#### System

- Recording System

Movies:

RAW

Video format: Cinema RAW Light

Audio format: Linear PCM, 16 or 24 bit, 48 kHz, 4 channels

File format: CRM (Canon RAW Movie; Canon proprietary file format)

MP4

Video compression: MPEG-4 AVC/H.264

Audio format: MPEG-2 AAC-LC, 16 bit, 48 kHz, 2 channels

Linear PCM, 16 bit, 48 kHz, 4 channels

File format: MP4

XF-AVC

Video compression: MPEG-4 AVC/H.264

Audio format: Linear PCM, 24 bit, 48 kHz, 4 channels

File format: MXF

Photos: DCF (Design rule for Camera File system), compatible with Exif Ver. 2.3, JPEG compression

- Video Configuration<sup>1</sup> (recording/playback)

Primary clips:

RAW

Bit rate: 1 Gbps

Resolution: 4096x2160

Color depth: 10 bit or 12 bit (depending on the frame rate)

Frame rate: 59.94P, 50.00P, 29.97P, 23.98P, 25.00P, 24.00P

MP4

Bit rate: 150 Mbps, 35 Mbps

Resolution: 3840x2160, 1920x1080

Color sampling: 4:2:0, 8 bit

Frame rate: 59.94P, 50.00P, 29.97P, 23.98P, 25.00P, 24.00P

XF-AVC

Bit rate: 160 Mbps, 45 Mbps

Resolution: 3840x2160, 1920x1080

Color sampling: 4:2:0, 8 bit

Frame rate: 59.94P, 59.94i, 50.00P, 50.00i, 29.97P, 23.98P, 25.00P, 24.00P

Proxy clips:

MP4

Bit rate: 35 Mbps (Long GOP)

Resolution: 2048x1080

Color sampling: 4:2:0, 8 bit

Frame rate: 59.94P, 50.00P, 29.97P, 23.98P, 25.00P, 24.00P

XF-AVC

Bit rate: 45 Mbps (Long GOP)

Resolution: 2048x1080

Color sampling: 4:2:0, 8 bit

Frame rate: 59.94P, 50.00P, 29.97P, 23.98P, 25.00P, 24.00P

<sup>1</sup> Available options may differ depending on the system frequency currently in use.

- **Recording Media (not included)**

For approximate recording times, refer to the *Reference Tables* (📖 231)

Primary clips: CFast 2.0 card, SD card<sup>2</sup> (2 slots)

Proxy clips and photos: SD card<sup>2</sup> (proxy clips: 2 slots, photos: SD card B)

<sup>2</sup> SD, SDHC (SD High Capacity) or SDXC (SD eXtended Capacity) memory card. Custom picture files and camera settings can be saved on and read from the SD card as well.

- **Image Sensor** Super-35mm-equivalent CMOS sensor

Effective pixels (approximate):

When the resolution is 4096x2160, 2048x1080: 8,850,000 pixels (4096x2160)

When the resolution is 3840x2160, 1920x1080: 8,290,000 pixels (3840x2160)

- **C200 Viewfinder:** 1.18 cm\* (0.46 in.) organic LED display, approx. 1,770,000 dots\*, 100% coverage

\* When the language is set to simplified Chinese, the values with an asterisk are as follows:

1.09 cm (0.43 in.), approx. 1,555,000 dots.

- **Lens Mount**

Canon EF mount compatible with Canon EF lenses (including EF-S lenses and EF Cinema lenses)

Lens multiplication factor for 35mm equivalent focal length (approximate):

When the resolution is 4096x2160, 2048x1080: 1.460

When the resolution is 3840x2160, 1920x1080: 1.534

- **Lens Correction**

Peripheral illumination/chromatic aberration correction is available for Canon EF lenses<sup>3</sup>

<sup>3</sup> Some lenses are not compatible with in-camera correction.

- **Shutter Speed**

Speed (1/3-stop increments, 1/4-stop increments), angle, clear scan, slow, off

- **Iris:** Manual (1/2-stop increments, 1/3-stop increments, fine-tuning), push auto iris, automatic aperture

- **ISO Speed**

ISO 100<sup>4</sup>, ISO 125<sup>4</sup>, ISO 160 to ISO 25600, ISO 32000<sup>4</sup> to ISO 102400<sup>4</sup> (1-stop or 1/3-stop increments)

<sup>4</sup> With extended ISO/Gain range.

- **Gain**

[Normal]: -6 dB to 54 dB (3-dB increments)

[Fine]: -2 dB to 54 dB (0.5-dB increments)

- **ND Filter:** Built-in (Off, 2, 4, 6, 8<sup>5</sup> or 10<sup>5</sup> stops), motor operated

<sup>5</sup> With extended ND range.

- **Exposure:** AE shift, light metering modes (standard, spotlight, backlight)

- **White Balance**

Custom white balance (two sets, A and B); two preset settings (daylight, 5,600 K<sup>6</sup> and incandescent lamp, 3,200 K<sup>6</sup>); automatic white balance (AWB); color temperature setting (2,000 K to 15,000 K)

Color temperature and color compensation (CC) adjustment available for all settings except custom white balance and AWB.

<sup>6</sup> Color temperatures are approximate and given for reference purposes only.

- **Focus**

Manual focus, autofocus (one-shot AF, AF-boosted MF, continuous AF, Face AF); face detection and subject tracking available

AF type: Dual Pixel CMOS AF, contrast-detection AF

- **Sensor Sensitivity (ISO 800, 2000 lux, 89.9% reflection)**

59.94 Hz: F10 (2048x1080 at 59.94P); 50.00 Hz: F11 (2048x1080 at 50.00P)

- **S/N Ratio (ISO 800, using Canon Log 3 gamma, HDMI output)**

53 dB (typical, 3840x2160, at 29.97P (59.94 Hz) or 25.00P (50.00 Hz))

- **Subject Illumination (ISO 25600, with a f/1.2 lens, 100% output)**

59.94 Hz: 0.45 lux (shutter speed 1/30)

50.00 Hz: 0.38 lux (shutter speed 1/25)

- **Built-in microphone:** Monaural electret condenser microphone
- **Size of Photos:** 3840x2160, 2048x1080, 1920x1080

## 226 Wi-Fi

- **Wireless Standard:** IEEE802.11b/g/n (2.4 GHz band), IEEE802.11a/n (5 GHz band)
- **Connection Methods:** Infrastructure (Wi-Fi Protected Setup (WPS), search for access points, manual), Camera Access Point
- **Authentication Methods:** Open, shared key; WPA-PSK, WPA2-PSK
- **Encryption Methods:** WEP-64, WEP-128, TKIP, AES

## Terminals

- **SDI Terminal**  
BNC jack, output only, 0.8 Vp-p / 75  $\Omega$ , unbalanced  
3G-SDI: SMPTE 424, SMPTE 425, SMPTE ST 299-2  
HD-SDI: SMPTE 292, SMPTE ST 299-1  
Embedded audio, time code (VITC/LTC)  
HDR output (HLG, PQ), LUT (BT.709, ACESproxy) and supplemental displays (superimposed onscreen displays, magnification, waveform monitor) can also be output.
- **HDMI OUT Terminal**  
HDMI connector, output only  
HDR output (HLG, PQ)  
Time code and supplemental displays (superimposed onscreen displays, magnification) can also be output.
- **INPUT Terminals (INPUT 1 and INPUT 2)**  
XLR 3-pin jack (pin1: shield, pin2: hot, pin3: cold), 2 sets, balanced  
Analog Inputs  
Sensitivity:  
MIC setting: -60 dBu (volume center, full scale -18 dB) / 600  $\Omega$   
LINE setting: 4 dBu (volume center, full scale -18 dB) / 10 k $\Omega$   
Microphone attenuator: 20 dB  
Digital Inputs (AES/EBU)  
AES3 standard (48 kHz, 24 bit, 2ch) / 110  $\Omega$
- **MIC Terminal**  
 $\varnothing$  3.5 mm stereo mini-jack, -72 dBV (volume center, full scale -18 dB) / 5.6 k $\Omega$   
Microphone attenuator: 20 dB
- **🎧 (Headphone) Terminal**  
 $\varnothing$  3.5 mm stereo mini-jack,  $-\infty$  to -8 dBV (16  $\Omega$  load, volume range Min to Max) / 50  $\Omega$  or less
- **USB Terminal**  
mini-B, Hi-Speed USB, output only
- **REMOTE Terminal**  
 $\varnothing$  2.5 mm stereo sub-mini jack
- **🌐 (Ethernet) Terminal**  
Ethernet, 1000BASE-T compatible
- **VIDEO Terminal**  
Proprietary connector for the LM-V1 LCD Monitor<sup>1</sup>, optional LM-V2 LCD Monitor, or optional EVF-V70 Electronic Viewfinder; output only
- **Camera Grip Connection Terminal**  
Proprietary connector for the camera grip unit<sup>1</sup> connection plug  
<sup>1</sup> Supplied accessory for the C200; optional accessory for the C200B.

## Power/Others

- **Power Supply (rated)**  
14.4 V DC (battery pack), 16.7 V DC (DC IN)
- **Power Consumption**  
**C200** with the SDI terminal, LCD screen and viewfinder active  
 19.3 W (recording at 59.94P; MP4/XF-AVC: 3840x2160, RAW: 4096x2160)  
 18.5 W (recording at 50.00P; MP4/XF-AVC: 3840x2160, RAW: 4096x2160)  
**C200B** with the SDI terminal active  
 17.5 W (recording at 59.94P; MP4/XF-AVC: 3840x2160, RAW: 4096x2160)  
 16.6 W (recording at 50.00P; MP4/XF-AVC: 3840x2160, RAW: 4096x2160)
- **Operating Temperature**  
0 – 40 °C (32 – 104 °F)
- **Dimensions (W x H x D)<sup>1</sup>**  
**C200**  
 Camera unit only: 144 x 153 x 179 mm (5.7 x 6.0 x 7.0 in.)  
 Configuration with camera grip: 178 x 153 x 204 mm (7.0 x 6.0 x 8.0 in.)  
 Configuration with camera grip, handle unit, LCD monitor, LCD attachment unit and microphone holder:  
 335 x 275 x 275 mm (1.1 ft. x 10.8 in. x 10.8 in.)  
**C200B**  
 Camera unit only: 144 x 146 x 137 mm (5.7 x 5.7 x 5.4 in.)  
 Configuration with thumb rest and microphone holder: 169 x 209 x 137 mm (6.7 x 8.2 x 5.4 in.)  
<sup>1</sup> All dimensions are approximate.
- **Weight<sup>2</sup>**  
**C200**  
 Camera unit only: 1430 g (3.2 lb.)  
 Camera with handle unit, LCD monitor, LCD attachment unit, camera grip, microphone holder, eye cup and hex socket head bolt (x1)<sup>3</sup>: 2,745 g (6.1 lb.)  
**C200B**  
 Camera unit only: 1,335 g (2.9 lb.)  
 Configuration with thumb rest and microphone holder<sup>3</sup>: 1,630 g (3.6 lb.)  
<sup>2</sup> All weights are approximate.  
<sup>3</sup> Working configuration includes also battery pack (BP-A30), recording media (CFast card), and unit cable (**C200** only).
- **Approximate continuous recording time with a fully charged battery pack:**  
**C200**  
 Recording at 59.94P; MP4/XF-AVC: 3840x2160, RAW: 4096x2160  
 125 min. (supplied BP-A30 battery pack),  
 270 min. (optional BP-A60 battery pack)  
 Recording at 50.00P; MP4/XF-AVC: 3840x2160, RAW: 4096x2160  
 130 min. (supplied BP-A30 battery pack),  
 280 min. (optional BP-A60 battery pack)  
**C200B**  
 Recording at 59.94P; MP4/XF-AVC: 3840x2160, RAW: 4096x2160  
 145 min. (supplied BP-A30 battery pack),  
 310 min. (optional BP-A60 battery pack)  
 Recording at 50.00P; MP4/XF-AVC: 3840x2160, RAW: 4096x2160  
 155 min. (supplied BP-A30 battery pack),  
 325 min. (optional BP-A60 battery pack)

## **C200 Modular Units**

### **LM-V1 LCD Monitor**

Includes the LCD panel (touch panel).

- **LCD Screen:** 10.1 cm (4.0 in.) color LCD, 16:9 aspect ratio, approx. 1,230,000 dots, 100% coverage, capacitive touch screen operation
- **VIDEO Terminal**  
Proprietary connector for connection to the camera; input only
- **Dimensions (W x H x D):** 120 x 75 x 37 mm (4.7 x 3.0 x 1.5 in.)
- **Weight:** Approx. 185 g (6.5 oz.)

### **LA-V1 LCD Attachment Unit**

Includes pivots that allow for rotation

- **Dimensions (W x H x D):** 143 x 117 x 75 mm (5.6 x 4.6 x 3.0 in.)
- **Weight:** Approx. 255 g (9.0 oz.)

### **GR-V1 Camera Grip**

Modular unit can be attached at any of 24 positions (6° intervals); includes limited recording controls.

- **Dimensions (W x H x D):** 60 x 124 x 75 mm (2.4 x 4.9 x 3.0 in.)
- **Weight:** Approx. 260 g (9.2 oz.)

### **HDU-2 Handle Unit**

Offers sockets for attaching additional accessories to the camera.

- **Dimensions (W x H x D):** Approx. 44 x 81 x 156 mm (1.7 x 3.2 x 6.1 in.)
- **Weight:** Approx. 220 g (7.8 oz.)

### **CA-A10 AC Adapter**

- **Rated Input:** 100 – 240 V AC, 50/60 Hz, 100 VA (100 V AC) – 124 VA (240 V AC)
- **Rated Output:** 16.7 V DC, 3.0 A
- **Operating Temperature:** 0 – 40 °C (32 – 104 °F)
- **Dimensions (W x H x D):** Approx. 73 x 40 x 139 mm (2.9 x 1.6 x 5.5 in.)
- **Weight:** Approx. 450 g (15.9 oz.)



### **CG-A20 Battery Charger**

- **Rated Input:** 24 V DC, 1.8 A
- **Rated Output:** 16.7 V DC, 1.5 A
- **Operating Temperature:** 0 – 40 °C (32 – 104 °F)
- **Dimensions (W x H x D):** 100 x 24 x 100 mm (3.9 x 0.9 x 3.9 in.)
- **Weight:** Approx. 145 g (5.1 oz.)

### **CA-CP200B Compact Power Adapter**

- **Rated Input:** 100 – 240 V AC, 50/60 Hz, 90 VA (100 V AC) – 120 VA (240 V AC)
- **Rated Output:** 24 V DC, 1.8 A
- **Operating Temperature:** 0 – 40 °C (32 – 104 °F)
- **Dimensions (W x H x D):** 67.5 x 37 x 134 mm (2.7 x 1.5 x 5.3 in.)
- **Weight:** Approx. 290 g (10.2 oz.)

### **BP-A30 Battery Pack**

- **Battery Type**  
Rechargeable lithium ion battery, compatible with Intelligent System
- **Rated Voltage:** 14.4 V DC
- **Operating Temperature:** 0 – 40 °C (32 – 104 °F)
- **Rated Battery Capacity:** 3100 mAh / 45 Wh
- **Dimensions (W x H x D):** 41.5 x 45.1 x 69.7 mm (1.6 x 1.8 x 2.7 in.)
- **Weight:** Approx. 225 g (7.9 oz.)

## Appendix: Compatible Lenses and Functions

Following is a list of lenses compatible with this camera and the various functions that can be used depending on the lens. Depending on the lens's purchase date, you may need to update the lens's firmware to use these functions. For details, consult a Canon Service Center.

Lens	Iris control from the camera			Zoom control from the camera
	Manual	Push auto iris	Automatic	
EF lenses	●	●	–	–
EF lenses compatible with auto iris	●	●	●	●*
EF Cinema lenses				
CN20x50 IAS H/E1	●	●	●	●
CN7x17 KAS S/E1				
CN10x25 IAS S/E1	●	●	●	●
CN-E18-80mm T4.4 L IS KAS S				
CN-E70-200mm T4.4 L IS KAS S				
Prime lenses compatible with Dual Pixel Focus Guide	–	–	–	–

\* Only for lenses compatible with the optional PZ-E1 Power Zoom Adapter.

Lens	Focus control from the camera					Focus guide
	Manual	One-shot AF	Continuous AF	Face AF	Tracking	
EF lenses	●	●	●	●	●	●
EF lenses compatible with auto iris	●	●	●	●	●	●
EF Cinema lenses						
CN20x50 IAS H/E1	●	–	–	–	–	–
CN7x17 KAS S/E1						
CN10x25 IAS S/E1	●	●	●	●	●	●
CN-E18-80mm T4.4 L IS KAS S						
CN-E70-200mm T4.4 L IS KAS S						
Prime lenses compatible with Dual Pixel Focus Guide	–	–	–	–	–	●

- EF lenses compatible with auto iris:

EF24-105mm f/3.5-5.6 IS STM  
 EF70-200mm f/4L IS II USM  
 EF70-300mm f/4-5.6 IS II USM  
 EF85mm f/1.4L IS USM  
 EF-S10-18mm f/4.5-5.6 IS STM  
 EF-S18-55mm f/3.5-5.6 IS STM

EF-S18-55mm f/4-5.6 IS STM  
 EF-S18-135mm f/3.5-5.6 IS STM  
 EF-S18-135mm f/3.5-5.6 IS USM  
 EF-S35mm f/2.8 MACRO IS STM  
 EF-S55-250mm f/4-5.6 IS STM

- Prime lenses compatible with the Dual Pixel Focus Guide function:

CN-E14mm T3.1 L F  
 CN-E20mm T1.5 L F  
 CN-E24mm T1.5 L F  
 CN-E35mm T1.5 L F

CN-E50mm T1.3 L F  
 CN-E85mm T1.3 L F  
 CN-E135mm T2.2 L F

## Reference Tables

### Approximate Recording Time on Recording Media

#### Primary clips (CFast card; RAW clips)

Bit rate → CFast card capacity ↓	1 Gbps
64 GB	5 min.
128 GB	15 min.
256 GB	30 min.

#### Primary/Proxy clips (SD card)\*

Format →	MP4		XF-AVC	
Bit rate → SD card capacity ↓	150 Mbps	35 Mbps	160 Mbps	45 Mbps
8 GB	5 min.	25 min.	5 min.	20 min.
16 GB	10 min.	55 min.	10 min.	45 min.
32 GB	25 min.	120 min.	25 min.	90 min.
64 GB	55 min.	240 min.	50 min.	185 min.
128 GB	110 min.	485 min.	105 min.	375 min.

\* Times are based on a single recording that continues until the SD card is full.

### Charging Times

Use the supplied CG-A20 Battery Charger to charge battery packs. The charging times given in the following table are approximate and vary according to charging conditions and initial charge of the battery pack.

BP-A30	BP-A60
170 min.	300 min.

☎ (Ethernet) terminal	168
4K RAW video	64
4K workflow	20

**A**

ABB (automatic black balance)	53
Abroad, using the camera	221
Access point	161, 164
Accessories	222
ACES color, ACESproxy	21
AE shift	75
Air vents	63
Aperture	72
Automatic aperture	74
Push auto iris	74
Assignable buttons	125
Audio format	99
Audio output channels	158
Audio peak limiter	102
Audio recording	96
Audio recording level	101
Audio reference signal	105
AWB (auto white balance)	79

**B**

Battery pack	23, 223
Black balance	53
Browser Remote	170
Built-in backup battery	220
Button connection mode (WPS)	165

**C**

Camera Access Point	163
Camera grip <sup>1</sup>	43
Camera settings	137
Canon Log, Canon Log 3 (gamma curves)	133
Canon XF Utility (download)	159

CFAST card	
Compatible CFAST cards	47
Initializing	50
Inserting/Removing	48
Recording method	51
Check marks (☑)	108, 146
Cinema RAW Development	160
Clips	
Adding an OK mark/☑ mark	108, 146
Adding/Deleting shot marks	108, 147
Clip name format	61
Deleting	147
Displaying clip information	145
Playback	141
Proxy clips	113
Recording	55
Recovering	52
Color bars	105
Color sampling	65
Color space	21
Condensation	221
Connection to external devices	152
Continuous recording	118
Custom displays	57
Custom picture	129
Main settings	133
Other settings	134
Preset settings	129

**D**

Data Import Utility	159
Date and time	31
DC IN terminal	26
Developing RAW clips	160
Direct setting mode	66
Double slot recording	51
Drop frame (time code)	93
Dual Pixel Focus Guide	82

**E**

EF Cinema lenses	230
EF lens mount	37
EF-S lens correction	39
External recorder	152, 153
Eye cup	40

<sup>1</sup> Supplied accessory for the C200; optional accessory for the C200B.

**F**

Fan	.63
Focus	.80
AF-boosted MF	.84
AF speed	.85
Continuous AF	.85
Face AF	.87
Focus assistance functions	.82
Manual focus	.81
One-shot AF	.84
Tracking	.88
Frame rate	.64
Frame recording mode	.116
Free-run (time code)	.92
FTP transfer	.182

**G**

Gain	.69
GPS information	.111, 179

**H**

Handle unit <sup>1</sup>	.28
HDMI OUT terminal	.149, 153
HDR (high dynamic range) output	.155
Headphone terminal	.104

**I**

Index screens	
Clips, Photos	.139
Infrastructure	.164
Initializing recording media	.50
INPUT 1/INPUT 2 terminals	.96, 99
Interval recording mode	.117
Iris	.72
ISO speed	.69

**J**

Joystick	.33
Joystick guide	.143

**K**

Key lock	.57
----------	-----

**L**

Language	.32
LCD attachment unit <sup>1</sup>	.28
LCD monitor <sup>1</sup>	.28
LCD screen	.41
Lens	.37
Lens correction (chromatic aberration/peripheral illumination)	.39
Lens firmware	.38
Light metering mode	.76
LUT (lookup table)	.156

**M**

Magnification	.83
Menu settings	.185
Message list	.212
Metadata	.109
MIC terminal	.96
Microphone	
Attenuator	.103
Built-in (monaural)	.103
External	.98, 99
Sensitivity	.102
Modular units	.36
Mounting bracket	.28
MP4 clip/photo numbering	.62
MP4 video	.64
My Menu	.34

**N**

ND filter	.71
Network connection	
Wi-Fi	.162
Wired (Ethernet)	.168
Network functions	.161
Non-drop frame (time code)	.93

**O**

OK marks (OK)	.108, 146
Onscreen displays	.57, 141
Onscreen markers	.90
On-set color grading	.21

<sup>1</sup> Supplied accessory for the C200; optional accessory for the C200B.

<b>P</b>	
Peaking	83
Phantom power (microphone)	99
Photos	
Deleting	122
Recording	120
Viewing	121
PIN code connection mode (WPS)	165
Playback	
Clips	141
Photos	121
Power supply	23
POWER switch	27
Pre-recording mode	115
Proxy clips	113
<b>R</b>	
RAW video	64
Rec run (time code)	92
Recording	
Clips	55
Photos	120
Simultaneous proxy clip recording	113
Recovering corrupted clips	52
Reference tables (charging and recording times, etc.)	231
Relay recording	51
Remaining battery	26, 203
Remote controller	123
Remote operation	123, 170
REMOTE terminal	123
Resolution (frame size)	65
Reviewing a clip	112
Router	162
Running mode (time code)	92
<b>S</b>	
Safe area	90
Saving clips to a computer	159
Saving XF-AVC clips	159
SD card	
Compatible SD cards	47
Initializing	50
Inserting/Removing	49
Search for access points	166
Shooting frame rate	114
Shot marks	108, 147
Shutter speed	67
Slow motion recording mode	114
Specifications	224
Status screens	196
System extension terminal	111
System frequency	64
<b>T</b>	
Terminal covers	45
Thumb rest	43
Time code	92
Tripod	42
Troubleshooting	207
Turning the camera on/off	27
<b>U</b>	
User bit	95
User memo	109
User settings (user names/passwords for Browser Remote)	170
<b>V</b>	
Video configuration	64
Video format	64
Video output configuration	149
VIDEO terminal	28
Viewfinder <sup>1</sup>	41
<b>W</b>	
Waveform monitor	106
White balance	77
Wide DR	133
WPS (Wi-Fi Protected Setup)	165
<b>X</b>	
XF Utility	159
XF-AVC video	64
<b>Z</b>	
Zebra pattern	91
Zoom	89, 179

## CANON CINEMA EOS LIMITED WARRANTY FOR PRODUCTS PURCHASED IN THE UNITED STATES

The limited warranty set forth below is given by Canon U.S.A., Inc. ('Canon USA') with respect to (a) the Canon Cinema EOS Product, and (b) the accessories for the Canon Cinema EOS Product (if any), packaged with this limited warranty (collectively the "Products")\* and purchased in the United States. This limited warranty is only effective upon presentation of your Bill of Sale or other proof of purchase. The Products are warranted to the original end-user purchaser, when delivered in new condition in its original container, under normal use against defective materials or workmanship as follows: Parts: At Canon USA's option, defective parts will be exchanged for new parts or comparable rebuilt parts for a period of ONE YEAR from the date of original purchase. Labor: For a period of ONE YEAR from the date of original purchase, labor will be provided free of charge by Canon USA's factory service centers or designated service facilities located in the United States. When returning Products under this warranty, you must pre-pay the shipping charges, and you must enclose a copy of the Bill of Sale or other proof of purchase with a complete explanation of the problem. During the ONE-YEAR warranty period, repairs will be made and the Products will be return-shipped to you free of charge. For repairs after the warranty period is over, you will be given an estimate of the cost of repair and an opportunity to approve or disapprove of the repair expense before it is incurred. If you approve, repairs will be made and the Products will be returned to you at your risk and expense. If you disapprove, we will return-ship the Products to you at no charge to you to an address within the United States.

**This limited warranty only applies if the Products are used in conjunction with compatible computer equipment and compatible software, as to which items Canon USA will have no responsibility. Canon USA shall have no responsibility under this limited warranty for use of the Products in conjunction with incompatible peripheral equipment and/or incompatible software. Non-Canon brand peripheral equipment and software which may be distributed with, or factory loaded on, the Products, are sold 'AS IS' without warranty of any kind by Canon USA, including any implied warranty regarding merchantability or fitness for a particular purpose. The sole warranty with respect to such non-Canon brand items is given by the manufacturer or producer thereof.**

\* Except for the battery pack packaged with the Products, which carries a separate ninety (90) day limited warranty.

In order to obtain warranty service, please contact the authorized Canon retail dealer from whom you purchased the Products or contact the CANON INFORMATION CENTER AT **855-CINE-EOS** (855-246-3367) or on the internet at [pro.usa.canon.com/support](http://pro.usa.canon.com/support). You will be directed to the nearest service facility for your Products.

This Limited Warranty covers all defects encountered in normal use of the Products and does not apply in the following cases:

- A. Loss or damage to the Products due to abuse, mishandling, accident, improper maintenance, use of non-Canon accessories or failure to follow operating, maintenance or environmental instructions prescribed in Canon USA's user's manual;
- B. If the Products are defective as a result of leaking batteries, sand, dirt or water damage;
- C. If defects or damages are caused by the use of parts or supplies (other than those sold by Canon USA) that cause damage to the Products or that cause abnormally frequent service calls or service problems;
- D. If defects or damages are caused by service other than Canon USA's factory service centers or authorized service facilities;
- E. Any internal modification to product hardware or firmware;
- F. Any applicable fee for Maintenance of the Products;
- G. If the Product has had its serial number or dating altered or removed.

This Limited Warranty does not apply to Products purchased outside the United States. This Limited Warranty does not apply to accessories or consumables not originally packaged with the Product. Please retain this warranty card and your Bill of Sale as a permanent record of your purchase. This card ensures that you are contacted promptly should there be a safety inspection, modification or Product recall under applicable laws or regulations.

**NO IMPLIED WARRANTY, INCLUDING MERCHANTABILITY AND FITNESS FOR A PARTICULAR PURPOSE APPLIES TO THE PRODUCTS AFTER THE APPLICABLE PERIOD OF EXPRESS WARRANTY OR GUARANTY (EXCEPT AS MENTIONED ABOVE) GIVEN BY ANY PERSON, FIRM OR CORPORATION WITH RESPECT TO THE PRODUCTS SHALL BIND CANON USA (SOME STATES DO NOT ALLOW LIMITATIONS ON HOW LONG AN IMPLIED WARRANTY LASTS, SO THE ABOVE LIMITATION OR EXCLUSION MAY NOT APPLY TO YOU). CANON USA SHALL NOT BE LIABLE FOR LOSS OF REVENUES OR PROFITS, EXPENSE FOR SUBSTITUTE PRODUCTS OR SERVICE, STORAGE CHARGES, LOSS OR CORRUPTION OF DATA, INCLUDING WITHOUT LIMITATION, LOSS OR CORRUPTION OF DATA STORED ON THE PRODUCTS' HARD DRIVE, OR ANY OTHER SPECIAL, INCIDENTAL OR CONSEQUENTIAL DAMAGES CAUSED BY THE USE, MISUSE OR INABILITY TO USE THE PRODUCTS, REGARDLESS OF THE LEGAL THEORY ON WHICH THE CLAIM IS BASED, AND EVEN IF CANON USA HAS BEEN ADVISED OF THE POSSIBILITY OF SUCH DAMAGES. NOR SHALL RECOVERY OF ANY KIND AGAINST CANON USA BE GREATER THAN THE PURCHASE PRICE OF THE PRODUCTS SOLD BY CANON USA AND CAUSING THE ALLEGED DAMAGE. WITHOUT LIMITING THE FOREGOING, YOU ASSUME ALL RISK AND LIABILITY FOR LOSS, DAMAGE OR INJURY TO YOU AND YOUR PROPERTY AND TO OTHERS AND THEIR PROPERTY ARISING OUT OF USE, MISUSE OR INABILITY TO USE THE PRODUCTS NOT CAUSED DIRECTLY BY THE NEGLIGENCE OF CANON USA (SOME STATES DO NOT ALLOW THE EXCLUSION OR LIMITATION OF INCIDENTAL OR CONSEQUENTIAL DAMAGES, SO THE ABOVE LIMITATION MAY NOT APPLY TO YOU). THIS LIMITED WARRANTY SHALL NOT EXTEND TO ANYONE OTHER THAN THE ORIGINAL PURCHASER OF THE PRODUCTS OR THE PERSON FOR WHOM IT WAS PURCHASED AS A GIFT.**

This warranty gives you specific legal rights, and you may also have other rights which vary from state to state.

## CANON CINEMA EOS LIMITED WARRANTY FOR PRODUCTS PURCHASED IN CANADA

The limited warranty set forth below is given by Canon Canada Inc. ("Canon Canada") with respect to (a) the Canon Cinema EOS product, and (b) the accessories for the Canon Cinema EOS Product (if any), packaged with this limited warranty (collectively the "Products")\* and purchased in Canada. This limited warranty is only effective upon presentation of your Bill of Sale or other proof of purchase. The Products are warranted to the original end-user purchaser, when delivered in new condition in its original container, under normal use against defective materials or workmanship as follows: Parts: At Canon Canada's option, defective parts will be exchanged for new parts or comparable rebuilt parts for a period of ONE YEAR from the date of original purchase. Labor: For a period of ONE YEAR from the date of original purchase, labor will be provided free of charge by Canon Canada's factory service center or designated service facilities located in Canada. When returning Products under this warranty, you must pre-pay the shipping charges, and you must enclose a copy of the Bill of Sale or other proof of purchase with a complete explanation of the problem. During the ONE-YEAR warranty period, repairs will be made and the Products will be return-shipped to you free of charge. For repairs after the warranty period is over, you will be given an estimate of the cost of repair and an opportunity to approve or disapprove of the repair expense before it is incurred. If you approve, repairs will be made and the Products will be returned to you at your risk and expense. If you disapprove, we will return-ship the Products to you at no charge to you at an address within Canada.

**This limited warranty only applies if the Products are used in conjunction with compatible computer equipment and compatible software, as to which items Canon Canada will have no responsibility. Canon Canada shall have no responsibility under this limited warranty for use of the Products in conjunction with incompatible peripheral equipment and/or incompatible software. Non-Canon brand peripheral equipment and software which may be distributed with, or factory loaded on, the Products, are sold 'AS IS' without warranty of any kind by Canon Canada, including any implied warranty or condition regarding merchantability or fitness for a particular purpose. The sole warranty with respect to such non-Canon brand items is given by the manufacturer or producer thereof.**

\* Except for the battery pack packaged with the Products, which carries a separate ninety (90) day limited warranty.

In order to obtain warranty service, please contact the authorized Canon retail dealer from whom you purchased the Products or contact the CANON PROFESSIONAL SERVICE CENTRE 1-800-667-2666 or on the internet at [www.canon.ca/pro](http://www.canon.ca/pro). You will be directed to the nearest service facility for your Products.

This Limited Warranty covers all defects encountered in normal use of the Products and does not apply in the following cases:

- A. Loss or damage to the Products due to abuse, mishandling, accident, improper maintenance, use of non-Canon accessories or failure to follow operating, maintenance or environmental instructions prescribed in Canon Canada's user's manual;
- B. If the Products are defective as a result of leaking batteries, sand, dirt or water damage;
- C. If defects or damages are caused by the use of parts or supplies (other than those sold by Canon Canada) that cause damage to the Products or that cause abnormally frequent service calls or service problems;
- D. If defects or damages are caused by service other than Canon Canada's factory service centers or authorized service facilities;
- E. Any internal modification to product hardware or firmware;
- F. Any applicable fee for Maintenance of the Products;
- G. If the Product has had its serial number or dating altered or removed.

This Limited Warranty does not apply to Products purchased outside Canada. This Limited Warranty does not apply to accessories or consumables not originally packaged with the Product. Please retain this warranty card and your Bill of Sale as a permanent record of your purchase. This card ensures that you are contacted promptly should there be a safety inspection, modification or Product recall under applicable laws or regulations.

**NO IMPLIED WARRANTY OR CONDITION, INCLUDING MERCHANTABILITY AND FITNESS FOR A PARTICULAR PURPOSE APPLIES TO THE PRODUCTS AFTER THE APPLICABLE PERIOD OF EXPRESS WARRANTY OR GUARANTY (EXCEPT AS MENTIONED ABOVE) GIVEN BY ANY PERSON, FIRM OR CORPORATION WITH RESPECT TO THE PRODUCTS SHALL BIND CANON CANADA (SOME PROVINCES DO NOT ALLOW LIMITATIONS ON HOW LONG AN IMPLIED WARRANTY OR CONDITION LASTS, SO THE ABOVE LIMITATION OR EXCLUSION MAY NOT APPLY TO YOU). CANON CANADA SHALL NOT BE LIABLE FOR LOSS OF REVENUES OR PROFITS, EXPENSE FOR SUBSTITUTE PRODUCTS OR SERVICE, STORAGE CHARGES, LOSS OR CORRUPTION OF DATA, INCLUDING WITHOUT LIMITATION, LOSS OR CORRUPTION OF DATA STORED ON THE PRODUCTS' HARD DRIVE, OR ANY OTHER SPECIAL, INCIDENTAL OR CONSEQUENTIAL DAMAGES CAUSED BY THE USE, MISUSE OR INABILITY TO USE THE PRODUCTS, REGARDLESS OF THE LEGAL THEORY ON WHICH THE CLAIM IS BASED, AND EVEN IF CANON CANADA HAS BEEN ADVISED OF THE POSSIBILITY OF SUCH DAMAGES. NOR SHALL RECOVERY OF ANY KIND AGAINST CANON CANADA BE GREATER THAN THE PURCHASE PRICE OF THE PRODUCTS SOLD BY CANON CANADA AND CAUSING THE ALLEGED DAMAGE. WITHOUT LIMITING THE FOREGOING, YOU ASSUME ALL RISK AND LIABILITY FOR LOSS, DAMAGE OR INJURY TO YOU AND YOUR PROPERTY AND TO OTHERS AND THEIR PROPERTY ARISING OUT OF USE, MISUSE OR INABILITY TO USE THE PRODUCTS NOT CAUSED DIRECTLY BY THE NEGLIGENCE OF CANON CANADA (SOME PROVINCES DO NOT ALLOW THE EXCLUSION OR LIMITATION OF INCIDENTAL OR CONSEQUENTIAL DAMAGES, SO THE ABOVE LIMITATION MAY NOT APPLY TO YOU). THIS LIMITED WARRANTY SHALL NOT EXTEND TO ANYONE OTHER THAN THE ORIGINAL PURCHASER OF THE PRODUCTS OR THE PERSON FOR WHOM IT WAS PURCHASED AS A GIFT.**

This warranty gives you specific legal rights, and you may also have other rights which vary from province to province.





Canon Inc. 30-2, Shimomaruko 3-chome, Ohta-ku, Tokyo 146-8501, Japan  
Canon Europa N.V. Bovenkerkerweg 59, 1185 XB Amstelveen, The Netherlands <http://www.canon-europe.com>

---

**USA** <http://pro.usa.canon.com>  
**CANON U.S.A., INC.**  
<http://pro.usa.canon.com/support>  
☎ (855) CINE-EOS (855-246-3367)  
(USA only)

**UNITED KINGDOM**  
**Canon UK Ltd**  
Unit 160, Centennial Park, Centennial Avenue,  
Elstree, Hertfordshire, WD6 3SG  
☎ 020-7660-0186

---

The information in this document is verified as of September 2023. Subject to change without notice.  
Visit your local Canon website to download the latest version.