

Canon

RF

85mm F1.2 L USM DS

Instructions

ENG

Thank you for purchasing a Canon product.

Canon RF85mm F1.2 L USM DS is a large aperture medium telephoto lens with DS coating for use with EOS R series cameras.

- “USM” stands for Ultrasonic Motor.
- “DS” stands for Defocus Smoothing.

Camera Firmware

Please use the latest version of firmware with the camera in use.

Proper exposure may not be achieved during AE shooting with older versions of the camera firmware. For details on whether the firmware is the latest version or not, and for details on updating the firmware, please check the Canon website.

Conventions used in these instructions



Warning to prevent lens or camera malfunction or damage.



Supplementary notes on using the lens and taking pictures.

Safety Precautions

Precautions to ensure that the camera is used safely. Read these precautions thoroughly. Make sure all details are observed in order to prevent risks and injury to the user and other people.



Warning

Details pertaining to risks that may result in death or serious injury.

- **Do not look directly at the sun or other strong light sources through a lens.** This may result in loss of sight.
- **Do not leave a lens in the sun without the lens cap attached.** The lens may concentrate entering sunlight and cause a malfunction or fire.



Caution

Details pertaining to risks that may result in injury or damage to other objects.

- **Do not leave the product in places exposed to extremely high or low temperatures.** The product may cause burns or injury when touched.

General Precautions

Handling Precautions

- Do not leave the product in excessive heat such as in a car in direct sunlight. High temperatures can cause the product to malfunction.
- If the lens is taken from a cold environment into a warm one, condensation may develop on the lens surface and internal parts. To prevent condensation in this case, first put the lens into an airtight plastic bag before taking it from a cold to warm environment. Then take out the lens after it has warmed gradually. Do the same when taking the lens from a warm environment into a cold one.
- Please also read any lens related handling precautions listed in your camera's instruction manual.

This device complies with Part 15 of the FCC Rules.

Operation is subject to the following two conditions: (1) This device may not cause harmful interference, and (2) this device must accept any interference received, including interference that may cause undesired operation.

Do not make any changes or modifications to the equipment unless otherwise specified in the instructions. If such changes or modifications should be made, you could be required to stop operation of the equipment.

This equipment has been tested and found to comply with the limits for a class B digital device, pursuant to part 15 of the FCC Rules. These limits are designed to provide reasonable protection against harmful interference in a residential installation. This equipment generates, uses and can radiate radio frequency energy and, if not installed and used in accordance with the instructions, may cause harmful interference to radio communications.

However, there is no guarantee that interference will not occur in a particular installation. If this equipment does cause harmful interference to radio or television reception, which can be determined by turning the equipment off and on, the user is encouraged to try to correct the interference by one or more of the following measures:

- Reorient or relocate the receiving antenna.
- Increase the separation between the equipment and receiver.
- Connect the equipment into an outlet on a circuit different from that to which the receiver is connected.
- Consult the dealer or an experienced radio/TV technician for help.

Nomenclature

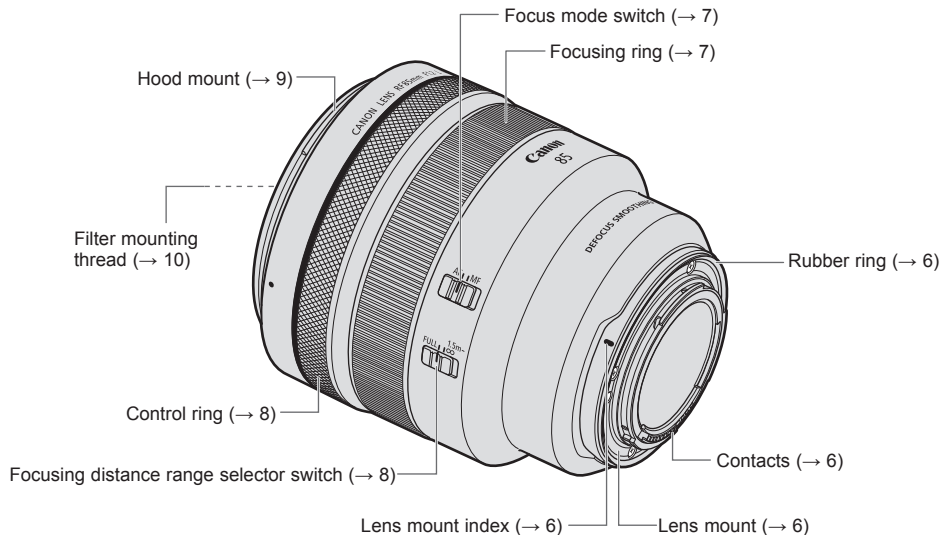

- For detailed information, reference page numbers are provided in parentheses (→ **).

1. Attaching and Detaching the Lens

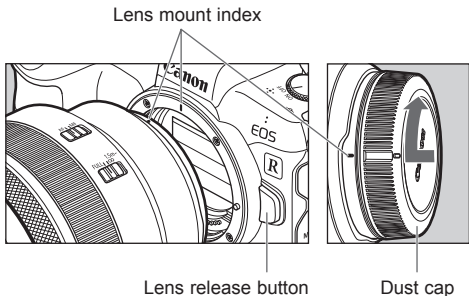

Attaching the Lens

Align the lens mount indexes of the lens and camera, and turn the lens clockwise until you hear a click.

Detaching the Lens

Turn the lens counterclockwise while pressing the camera's lens release button. Detach the lens once it has stopped turning.

Please refer to the camera's instructions for details.



- Set the camera's power switch to OFF when attaching or detaching the lens.
- Attach the lens cap before detaching the lens from the camera.
- After detaching the lens, place the lens with the rear end up and attach the dust cap to prevent the lens surface and contacts from getting scratched. Make sure the lens and dust cap mount indexes are aligned when attaching the dust cap.
- Contacts that are scratched, soiled, or have fingerprints on them may result in faulty connections or corrosion, which may lead to malfunctions. If the contacts get soiled, clean them with a soft cloth.
- The lens mount has a rubber ring to improve dust-resistance and water-resistance performance. This rubber ring may cause friction marks to appear around the camera's lens mount, although this will have no effect on usage.



- Rubber rings can be replaced at Canon Service Center. (chargeable)

2. Setting the Focus Mode

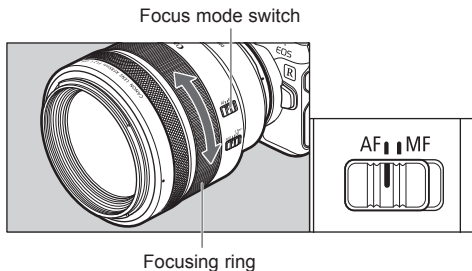

To shoot in autofocus (AF) mode, set the focus mode switch to AF.

To use only manual focusing (MF), set the focus mode switch to MF, and focus by turning the focusing ring.

- Quickly turning the focusing ring may result in delayed focus.
- The lens' focusing ring is electronic.
- When AF operation is set to [ONE SHOT], manual focus is possible after autofocus has been completed by continuing to press the shutter button halfway. (Full-time manual focus) However, the camera settings need to be changed.

3. Setting the Focusing Distance Range

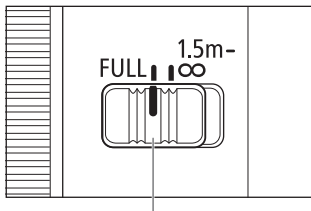

Focusing distance range selector switch

You can set the focusing distance range with a switch. By setting a suitable focusing distance range, the actual autofocusing time will be shorter.

Focusing distance range

1. FULL (0.85 m/2.79 ft. -∞)
2. 1.5 m/4.92 ft. -∞

4. Control Ring

The control ring can be assigned the functions that are commonly used with cameras, such as shutter speed and aperture settings.

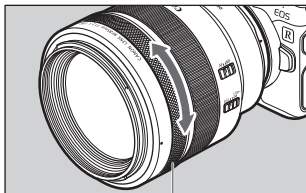

Control ring

The click action of the control ring allows you to have a sense of how much it is being turned. Please refer to the camera's instructions for details on how to use the control ring.



- There are cases in which the sound of control ring operations may be recorded when shooting movies.



- The clicking sensation of the control ring can be removed by the Canon Service Center. (chargeable)

5. Hood

The custom lens hood cuts out unwanted light and protects the front of the lens from rain, snow, and dust.

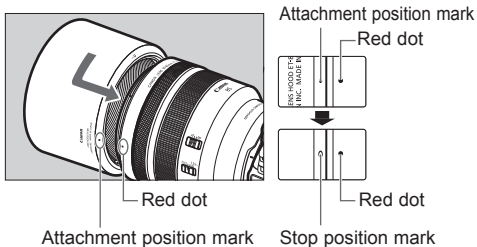

●Attaching the Hood

Align the red attachment position mark on the hood with the red dot on the front of the lens, and then turn the hood in the direction of the arrow until you hear a click.

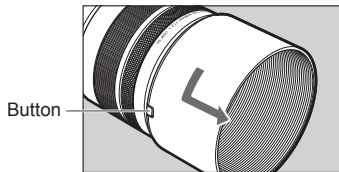

●Detaching the Hood

Keep your finger pressed down on the button located on the side of the hood, and then turn the hood in the direction of the arrow until the attachment position mark on the hood is aligned with the red dot on the front of the lens to detach it. The hood can be reverse-mounted on the lens for storage.

- If the hood is not attached properly, vignetting (darkening of the perimeter of the picture) may occur.
- Grasp and turn the base of the hood when attaching and detaching it. There are cases in which it may become deformed if the hood is turned with it grasped near to the rim.

6. DS Coating and DS Effect

- In addition to being equipped with the same optical system found in the RF85mm F1.2 L USM, the RF85mm F1.2 L USM DS is a shooting lens that features DS coating. DS coating gradually reduces light transmission (obstructs light) from the center of the lens outward. The DS (Defocus Smoothing) effect which results in a soft, unique bokeh is created by controlling the amount of light that passes through the lens, smoothing the edges of out-of-focus areas.

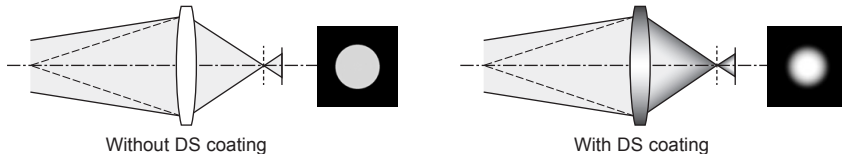

Comparison of lens with and without DS coating and resulting out-of-focus areas

- The DS effect (visual impact of softer-edged, out-of-focus highlights) is strong when the DS lens is shot wide-open and diminishes as the DS lens' aperture is stopped down.

DS Coating and DS Effect

- Since this lens utilizes DS coating which reduces light transmission (obstructs light), the brightness level when the lens is shot wide-open is lower than what is expected when at f/1.2. However, the aperture value displayed by the camera will be displayed as usual using the applicable f-number.
- AE shooting can be performed as usual. However, when deciding the exposure using a hand-held exposure meter, use the following table as a guide and apply the exposure factor using ISO speed or shutter speed before shooting.
It is therefore recommended that you change the exposure level as much as possible during shooting, or that you take pictures while checking the captured images.

Exposure Factor Guide (to be followed when using a hand-held exposure meter)

$\frac{1}{3}$ stop display

f-number displayed on camera	f/1.2	f/1.4	f/1.6	f/1.8	f/2	f/2.2	f/2.5	f/2.8	f/3.2
Exposure factor (stops)	+1 $\frac{1}{3}$	+1	+ $\frac{2}{3}$	+ $\frac{2}{3}$	+ $\frac{1}{3}$	+ $\frac{1}{3}$	+ $\frac{1}{3}$	+ $\frac{1}{3}$	0

$\frac{1}{2}$ stop display

f-number displayed on camera	f/1.2	f/1.4	f/1.8	f/2	f/2.5	f/2.8
Exposure factor (stops)	+1 $\frac{1}{2}$	+1	+ $\frac{1}{2}$	+ $\frac{1}{2}$	+ $\frac{1}{2}$	0

DS Coating and DS Effect

- Other Shooting Precautions
 - Compared to the RF85mm F1.2 L USM, the effect for improving loss of light around the edge of the lens is diminished even when the lens is set to its lowest aperture.
(not applicable when Peripheral Illumination Correction is used)
 - Since the amount of bokeh is less than that offered by the RF85mm F1.2 L USM lens, depth-of-field will appear deeper in shots taken with the DS lens.
 - If you look inside the lens from the front, the surface with DS coating will appear iridescent or you may see a round pattern in the center. However, these factors do not have any negative impact on shooting.

7. Filters (Sold separately)

You can attach filters to the filter mounting thread on the front of the lens.



- Only one filter may be attached.
- If you need a polarizing filter, use the Canon Circular Polarizing Filter PL-C B.
- Detach the hood when adjusting the polarizing filter.

Specifications

Focal Length/Aperture	85mm f/1.2
Lens Construction	9 groups, 13 elements
Minimum Aperture	f/16
Angle of View	Horizontal: 24°, Vertical: 16°, Diagonal: 28° 30'
Min. Focusing Distance	0.85 m/2.79 ft.
Max. Magnification	0.12x
Field of View	Approx. 285 x 190 mm/11.22 x 7.48 in. (at 0.85 m/2.79 ft.)
Filter Diameter	82 mm
Max. Diameter and Length	Approx. 103.2 x 117.3 mm/4.06 x 4.62 in.
Weight	Approx. 1195 g/42.15 oz.
Hood	ET-89
Lens Cap	E-82 II
Case	LP1424

- The lens length is measured from the lens mount surface to the front end of the lens. Add 24.0 mm/0.94 in. when including the lens cap and dust cap.
- The maximum diameter, length and weight listed are for the lens itself only.
- Close-up Lens cannot be attached because there is no size that fits the lens.
- All data listed is measured according to Canon standards.
- Product specifications and appearance are subject to change without notice.

Canon