

PowerShot ELPH 360 HS IXUS 285 HS

Camera User Guide

ENGLISH

- Make sure you read this guide, including the “Safety Precautions” (📖 12) section, before using the camera.
- Reading this guide will help you learn to use the camera properly.
- Store this guide safely so that you can use it in the future.

- Click the buttons in the lower right to access other pages.

 : Next page

 : Previous page

 : Page before you clicked a link

- To jump to the beginning of a chapter, click the chapter title at right.

Before Use

Basic Guide

Advanced Guide

Camera Basics

Auto Mode /
Hybrid Auto Mode

Other Shooting Modes

P Mode

Playback Mode

Wi-Fi Functions

Setting Menu

Accessories

Appendix

Index

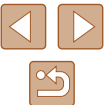

Before Use

Initial Information

Package Contents

Before use, make sure the following items are included in the package. If anything is missing, contact your camera retailer.

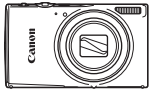

Camera



Battery Pack
NB-11LH*

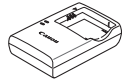

Battery Charger
CB-2LF/CB-2LFE



Wrist Strap

* Do not peel off the adhesive covering from a battery pack.

- Printed matter is also included.
- A memory card is not included (📖2).

Compatible Memory Cards

The following memory cards (sold separately) can be used, regardless of capacity.

- SD memory cards*
- SDHC memory cards*
- SDXC memory cards*



* Cards conforming to SD standards. However, not all memory cards have been verified to work with the camera.

Before Use

Basic Guide

Advanced Guide

Camera Basics

Auto Mode /
Hybrid Auto Mode

Other Shooting Modes

P Mode

Playback Mode

Wi-Fi Functions

Setting Menu

Accessories

Appendix

Index

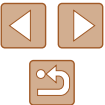

Preliminary Notes and Legal Information

- Take and review some test shots initially to make sure the images were recorded correctly. Please note that Canon Inc., its subsidiaries and affiliates, and its distributors are not liable for any consequential damages arising from any malfunction of a camera or accessory, including memory cards, that result in the failure of an image to be recorded or to be recorded in a way that is machine readable.
- Images recorded by the camera shall be for personal use. Refrain from unauthorized recording that infringes on copyright law, and note that even for personal use, photography may contravene copyright or other legal rights at some performances or exhibitions, or in some commercial settings.
- The camera warranty is valid only in the area of purchase. In case of camera problems while abroad, return to the area of purchase before contacting a Canon Customer Support Help Desk.
- Although the screen (monitor) is produced under extremely high-precision manufacturing conditions and more than 99.99% of the pixels meet design specifications, in rare cases some pixels may be defective or may appear as red or black dots. This does not indicate camera damage or affect recorded images.
- When the camera is used over an extended period, it may become warm. This does not indicate damage.

Conventions in This Guide

- In this guide, icons are used to represent the corresponding camera buttons and switches on which they appear or which they resemble.
- The following camera buttons and controls are represented by icons. Numbers in parentheses indicate the numbers of corresponding controls in “Part Names” (📖4).
 - [▲] Up button (⑤) on back
 - [◀] Left button (⑥) on back
 - [▶] Right button (⑩) on back
 - [▼] Down button (⑦) on back
- Shooting modes and on-screen icons and text are indicated in brackets.
- ⓘ: Important information you should know
- 📌: Notes and tips for expert camera use
- 📖xx: Pages with related information (in this example, “xx” represents a page number)
- Instructions in this guide apply to the camera under default settings.
- For convenience, all supported memory cards are simply referred to as the “memory card”.
- The symbols “▶ Still Images” and “▶ Movies” below titles indicate how the function is used—whether for still images or movies.

Before Use
Basic Guide
Advanced Guide
Camera Basics
Auto Mode / Hybrid Auto Mode
Other Shooting Modes
P Mode
Playback Mode
Wi-Fi Functions
Setting Menu
Accessories
Appendix
Index

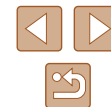

Part Names

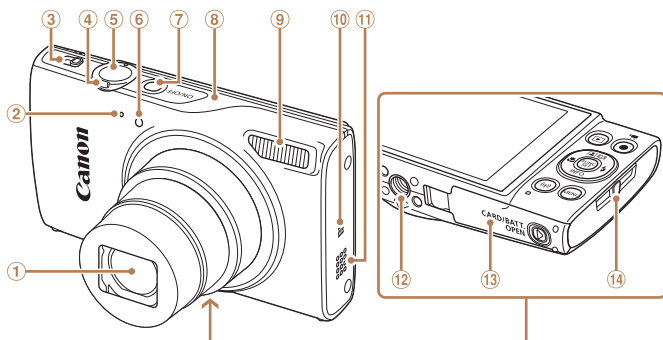

- ① Lens
- ② Microphone
- ③ Mode switch
- ④ Zoom lever
- ⑤ Shutter button
- ⑥ Lamp
- ⑦ Power button
- ⑧ Wi-Fi antenna area
- ⑨ Flash
- ⑩ (N-Mark)*
- ⑪ Speaker
- ⑫ Tripod socket
- ⑬ Memory card/battery cover
- ⑭ Strap mount

* Used with NFC features (88).

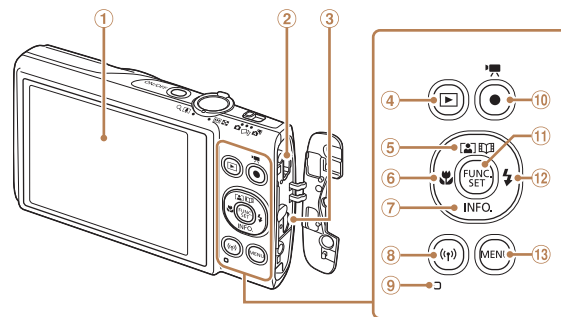

- ① Screen (monitor)
- ② AV OUT (Audio/video output) / DIGITAL terminal
- ③ HDMI™ terminal
- ④ (Playback) button
- ⑤ (Auto Zoom) / (Story Highlights) / Up button
- ⑥ (Macro) / Left button
- ⑦ **INFO.** (Information) / Down button
- ⑧ (Wi-Fi) button
- ⑨ Indicator
- ⑩ Movie button
- ⑪ FUNC. (Function) / SET button
- ⑫ (Flash) / Right button
- ⑬ **MENU** button

- Before Use
- Basic Guide
- Advanced Guide
 - Camera Basics
 - Auto Mode / Hybrid Auto Mode
 - Other Shooting Modes
 - P Mode
 - Playback Mode
 - Wi-Fi Functions
 - Setting Menu
 - Accessories
 - Appendix
- Index



Table of Contents

Before Use

Initial Information	2
Package Contents	2
Compatible Memory Cards	2
Preliminary Notes and Legal Information	3
Conventions in This Guide	3
Part Names	4
Common Camera Operations	11
Safety Precautions	12

Basic Guide

Basic Operations	15
Initial Preparations	15
Attaching the Strap	15
Holding the Camera	15
Charging the Battery Pack	16
Inserting the Battery Pack and Memory Card	16
Removing the Battery Pack and Memory Card	17
Setting the Date and Time	17
Changing the Date and Time	18
Display Language	19
Trying the Camera Out	19
Shooting (Smart Auto)	19
Viewing	21
Erasing Images	21

Advanced Guide

Camera Basics	22
On/Off	22
Power-Saving Features (Auto Power Down)	23
Power Saving in Shooting Mode	23
Power Saving in Playback Mode	23
Shutter Button	23
Shooting Display Options	24
Using the FUNC. Menu	24
Using the Menu Screen	25
On-Screen Keyboard	26
Indicator Display	27
Clock	27
Auto Mode / Hybrid Auto Mode	28
Shooting with Camera-Determined Settings	28
Shooting (Smart Auto)	28
Shooting in Hybrid Auto Mode	30
Digest Movie Playback	31
Still Images/Movies	31
Still Images	31
Movies	32
Scene Icons	32
Image Stabilization Icons	33
On-Screen Frames	34
Common, Convenient Features	34
Zooming In Closer on Subjects (Digital Zoom)	34
Auto Zooming in Response to Subject Movement (Auto Zoom)	35

Before Use
Basic Guide
Advanced Guide
Camera Basics
Auto Mode / Hybrid Auto Mode
Other Shooting Modes
P Mode
Playback Mode
Wi-Fi Functions
Setting Menu
Accessories
Appendix
Index



Using the Self-Timer	36
Using the Self-Timer to Avoid Camera Shake	36
Customizing the Self-Timer	36
Deactivating the Flash	37
Adding a Date Stamp	37
Continuous Shooting	38
Image Customization Features	38
Changing the Aspect Ratio	38
Changing the Number of Recording Pixels (Image Size)	39
Guidelines for Choosing Recording Pixel Setting Based on Paper Size (for 4:3 Images)	39
Changing Movie Image Quality	39
Helpful Shooting Features.....	40
Displaying Grid Lines.....	40
Magnifying the Area in Focus	40
Changing the IS Mode Settings.....	41
Deactivating Image Stabilization	41
Recording Movies with Subjects at the Same Size Shown before Shooting	41
Customizing Camera Operation.....	42
Deactivating the AF-Assist Beam	42
Deactivating the Red-Eye Reduction Lamp.....	42
Changing the Image Display Style after Shots	43
Changing the Image Display Period after Shots	43
Changing the Screen Displayed after Shots	43
Other Shooting Modes.....	44
Enjoying a Variety of Images from Each Shot (Creative Shot)	44
Image Display during Playback	45
Choosing Effects	45
Specific Scenes.....	46

Applying Special Effects.....	47
Shooting with a Fish-Eye Lens Effect (Fish-Eye Effect)	47
Shots Resembling Miniature Models (Miniature Effect).....	48
Playback Speed and Estimated Playback Time (for One-Minute Clips)	48
Shooting with a Toy Camera Effect (Toy Camera Effect).....	49
Shooting in Monochrome.....	49
Special Modes for Other Purposes	50
Auto Shooting after Face Detection (Smart Shutter).....	50
Auto Shooting after Smile Detection (Smile)	50
Auto Shooting after Wink Detection (Wink Self-Timer).....	50
Auto Shooting after Detecting New Person (Face Self-Timer).....	51
Shooting Long Exposures (Long Shutter)	52
High-Speed Continuous Shooting (High-Speed Burst)	52
P Mode	53
Shooting in Program AE ([P] Mode)	53
Image Brightness (Exposure).....	54
Adjusting Image Brightness (Exposure Compensation)	54
Changing the Metering Method	54
Changing the ISO Speed.....	55
Correcting Image Brightness (i-Contrast).....	55
Image Colors	56
Adjusting White Balance.....	56
Custom White Balance.....	56
Changing Image Color Tones (My Colors)	56
Custom Color.....	57
Shooting Range and Focusing	58
Shooting Close-Ups (Macro)	58

Before Use
Basic Guide
Advanced Guide
Camera Basics
Auto Mode / Hybrid Auto Mode
Other Shooting Modes
P Mode
Playback Mode
Wi-Fi Functions
Setting Menu
Accessories
Appendix
Index

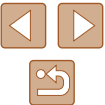

Shooting Distant Subjects (Infinity).....	58
Digital Tele-Converter	59
Changing the AF Frame Mode	59
Face AiAF	59
Choosing Subjects to Focus On (Tracking AF)	60
Center.....	61
Shooting with Servo AF	61
Changing the Focus Setting	62
Flash.....	62
Changing the Flash Mode	62
Auto	62
On.....	62
Slow Synchro	62
Off.....	63
Other Settings	63
Changing the Compression Ratio (Image Quality).....	63
Changing the IS Mode Settings.....	63
Playback Mode	64
Viewing.....	64
Switching Display Modes.....	65
Overexposure Warning (for Image Highlights)	66
Histogram	66
GPS Information Display	66
Viewing Short Movies Created When Shooting Still Images (Digest Movies).....	66
Viewing by Date.....	67
Browsing and Filtering Images.....	67
Navigating through Images in an Index.....	67
Finding Images Matching Specified Conditions.....	68
Viewing Individual Images in a Group	69

Image Viewing Options	70
Magnifying Images	70
Viewing Slideshows.....	70
Changing Slideshow Settings.....	71
Auto Playback of Related Images (Smart Shuffle)	71
Protecting Images	72
Using the Menu	72
Choosing Images Individually.....	73
Selecting a Range	73
Protecting All Images at Once	74
Clearing All Protection at Once	74
Erasing Images	74
Erasing Multiple Images at Once.....	75
Choosing a Selection Method	75
Choosing Images Individually.....	75
Selecting a Range	76
Specifying All Images at Once.....	76
Rotating Images	76
Using the Menu	77
Deactivating Auto Rotation	77
Tagging Images as Favorites	78
Using the Menu	78
Editing Still Images.....	79
Resizing Images.....	79
Cropping.....	79
Changing Image Color Tones (My Colors)	80
Correcting Image Brightness (i-Contrast).....	81
Correcting Red-Eye.....	81
Editing Movies	82
Editing Digest Movies.....	83

Before Use
Basic Guide
Advanced Guide
Camera Basics
Auto Mode / Hybrid Auto Mode
Other Shooting Modes
P Mode
Playback Mode
Wi-Fi Functions
Setting Menu
Accessories
Appendix
Index

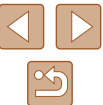

Viewing Albums (Story Highlights)	84
Choosing Themes for Albums	84
Adding Background Music to Albums	85
Creating Your Own Albums.....	85
Wi-Fi Functions	87
Available Wi-Fi Features	87
Sending Images to a Smartphone.....	88
Sending Images to an NFC-Compatible Smartphone	88
Connecting via NFC When Camera Is Off or in Shooting Mode	88
Connecting via NFC When Camera Is in Playback Mode.....	90
Adding a Smartphone.....	91
Using Another Access Point	93
Previous Access Points	93
Saving Images to a Computer.....	94
Preparing to Register a Computer	94
Installing the Software	94
Configuring the Computer for a Wi-Fi Connection (Windows Only)	95
Saving Images to a Connected Computer.....	95
Confirming Access Point Compatibility	95
Using WPS-Compatible Access Points	96
Connecting to Listed Access Points	98
Previous Access Points	99
Sending Images to a Registered Web Service.....	99
Registering Web Services	99
Registering CANON iIMAGE GATEWAY.....	100
Registering Other Web Services	101
Uploading Images to Web Services	102
Printing Images Wirelessly from a Connected Printer.....	103
Sending Images to Another Camera	104

Image Sending Options.....	105
Sending Multiple Images	105
Selecting a Range	105
Sending Favorite Images	106
Notes on Sending Images	106
Choosing the Number of Recording Pixels (Image Size)	107
Adding Comments	107
Sending Images Automatically (Image Sync).....	108
Initial Preparations.....	108
Preparing the Camera	108
Preparing the Computer	108
Sending Images.....	109
Viewing Images Sent via Image Sync on a Smartphone.....	109
Using a Smartphone to View Camera Images and Control the Camera.....	110
Geotagging Images on the Camera	110
Shooting Remotely	110
Editing or Erasing Wi-Fi Settings.....	111
Editing Connection Information	111
Changing a Device Nickname	112
Erasing Connection Information	112
Changing the Camera Nickname	112
Returning the Wi-Fi Settings to Default	113
Setting Menu.....	114
Adjusting Basic Camera Functions	114
Silencing Camera Operations.....	114
Adjusting the Volume.....	114
Hiding Hints and Tips.....	115
Date and Time	115
World Clock	115
Lens Retraction Timing.....	116
Using Eco Mode	116

Before Use
Basic Guide
Advanced Guide
Camera Basics
Auto Mode / Hybrid Auto Mode
Other Shooting Modes
P Mode
Playback Mode
Wi-Fi Functions
Setting Menu
Accessories
Appendix
Index

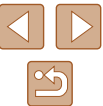

Power-Saving Adjustment	116
Screen Brightness	117
Hiding the Start-Up Screen.....	117
Formatting Memory Cards.....	117
Low-Level Formatting.....	118
File Numbering	118
Date-Based Image Storage.....	119
Metric / Non-Metric Display	119
Checking Certification Logos.....	119
Display Language.....	119
Adjusting Other Settings.....	120
Restoring Default Camera Settings.....	120
Accessories	121
System Map	121
Optional Accessories.....	122
Power Supplies.....	122
Flash Unit	122
Other Accessories	123
Printers	123
Photo and Movie Storage	123
Using Optional Accessories.....	123
Playback on a TV	123
Playback on a High-Definition TV.....	123
Playback on a Standard-Definition TV.....	124
Using the Software	125
Computer Connections via a Cable.....	125
Checking Your Computer Environment	125
Installing the Software	125
Saving Images to a Computer	126

Printing Images	127
Easy Print	127
Configuring Print Settings.....	128
Cropping Images before Printing.....	129
Choosing Paper Size and Layout before Printing	129
Available Layout Options.....	130
Printing ID Photos	130
Printing Movie Scenes.....	130
Movie Printing Options	130
Adding Images to the Print List (DPOF)	131
Configuring Print Settings.....	131
Setting Up Printing for Individual Images	131
Setting Up Printing for a Range of Images.....	132
Setting Up Printing for All Images.....	132
Clearing All Images from the Print List	132
Printing Images Added to the Print List (DPOF).....	132
Adding Images to a Photobook	133
Choosing a Selection Method	133
Adding Images Individually.....	133
Adding All Images to a Photobook	133
Removing All Images from a Photobook	133

Appendix.....	134
Troubleshooting.....	134
On-Screen Messages.....	138
On-Screen Information.....	140
Shooting (Information Display)	140
Battery Level	140
Playback (Detailed Information Display).....	141
Summary of Movie Control Panel.....	141

Before Use
Basic Guide
Advanced Guide
Camera Basics
Auto Mode / Hybrid Auto Mode
Other Shooting Modes
P Mode
Playback Mode
Wi-Fi Functions
Setting Menu
Accessories
Appendix
Index

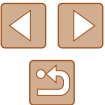

Functions and Menu Tables	142
Functions Available in Each Shooting Mode	142
FUNC. Menu.....	143
Shooting Tab.....	145
Set Up Tab.....	147
Playback Tab	147
Print Tab	148
Playback Mode FUNC. Menu.....	148
Handling Precautions	148
Specifications	149
Camera.....	149
Number of Shots/Recording Time, Playback Time	150
Shooting Range.....	150
Number of Shots per Memory Card	151
Recording Time per Memory Card	151
Battery Pack NB-11LH.....	152
Battery Charger CB-2LF/CB-2LFE.....	152
Index.....	153
Wi-Fi (Wireless LAN) Precautions.....	155
Radio Wave Interference Precautions.....	155
Security Precautions.....	155
Trademarks and Licensing	156
Disclaimer.....	157

Before Use
Basic Guide
Advanced Guide
Camera Basics
Auto Mode / Hybrid Auto Mode
Other Shooting Modes
P Mode
Playback Mode
Wi-Fi Functions
Setting Menu
Accessories
Appendix
Index



Common Camera Operations

Shoot

- Use camera-determined settings (Auto Mode, Hybrid Auto Mode)
 - 428, 430
- See several effects applied to each shot, using camera-determined settings (Creative Shot Mode)
 - 44

Shooting people well



Portraits
(46)

Matching specific scenes



Low Light
(46)



Fireworks
(46)

Applying special effects



Vivid Colors
(47)



Poster Effect
(47)



Fish-Eye Effect
(47)



Miniature Effect
(48)



Toy Camera Effect
(49)



Monochrome
(49)

- Focus on faces
 - 28, 46, 59
- Without using the flash (Flash Off)
 - 37, 63
- Include yourself in the shot (Self-Timer)
 - 36, 51
- Add a date stamp
 - 37
- Movie clips and photos together (Movie Digest)
 - 30

View

- View images (Playback Mode)
 - 64
- Automatic playback (Slideshow)
 - 70
- On a TV
 - 123
- On a computer
 - 125
- Browse through images quickly
 - 67
- Erase images
 - 74
- Create an album automatically
 - 84

Record/View Movies

- Record movies
 - 28
- View movies (Playback Mode)
 - 64

Before Use

Basic Guide

Advanced Guide

Camera Basics

Auto Mode /
Hybrid Auto Mode

Other Shooting Modes

P Mode

Playback Mode

Wi-Fi Functions

Setting Menu

Accessories

Appendix

Index



Print

- Print pictures
 - 127

Save

- Save images to a computer via a cable
 - 126

Use Wi-Fi Functions

- Send images to a smartphone
 - 88
- Share images online
 - 99
- Send images to a computer
 - 94

Safety Precautions

- Before using the product, ensure that you read the safety precautions described below. Always ensure that the product is used correctly.
- The safety precautions noted here are intended to prevent you and other persons from being injured or incurring property damage.
- Be sure to also check the guides included with any separately sold accessories you use.



Warning

Denotes the possibility of serious injury or death.

- Do not trigger the flash in close proximity to people's eyes. Exposure to the intense light produced by the flash could damage eyesight. In particular, remain at least 1 meter (3.3 feet) away from infants when using the flash.
- Store this equipment out of the reach of children and infants. A strap wound around a child's neck may result in asphyxiation. If your product uses a power cord, mistakenly winding the cord around a child's neck may result in asphyxiation.
- Use only recommended power sources.
- Do not disassemble, alter, or apply heat to the product.
- Do not peel off the adhesive covering, if the battery pack has it.
- Avoid dropping or subjecting the product to severe impacts.
- Do not touch the interior of the product if it is broken, such as when dropped.
- Stop using the product immediately if it emits smoke or a strange smell, or otherwise behaves abnormally.
- Do not use organic solvents such as alcohol, benzene, or thinner to clean the product.

Before Use

Basic Guide

Advanced Guide

Camera Basics

Auto Mode / Hybrid Auto Mode

Other Shooting Modes

P Mode

Playback Mode

Wi-Fi Functions

Setting Menu

Accessories

Appendix

Index



- Avoid contact with liquid, and do not allow liquid or foreign objects inside.

This could result in electrical shock or fire.

If the product gets wet, or if liquid or foreign objects get inside, remove the battery pack/batteries or unplug immediately.

- If your model has a viewfinder or interchangeable lens, do not look through the viewfinder or lens at bright light sources (such as the sun on a clear day, or a bright artificial light source).

This may damage your eyesight.

- If your model has an interchangeable lens, do not leave the lens (or the camera with the lens attached) in the sun without the lens cap on.

This could result in a fire.

- Do not touch the product during thunderstorms if it is plugged in. This could result in electrical shock or fire. Immediately stop using the product and distance yourself from it.

- Use only the recommended battery pack/batteries.

- Do not place the battery pack/batteries near or in direct flame.

This may cause the battery pack/batteries to explode or leak, resulting in electrical shock, fire, or injuries. If leaking battery electrolyte comes into contact with eyes, mouth, skin, or clothing, immediately flush with water.

- If the product uses a battery charger, note the following precautions.
 - Remove the plug periodically and, using a dry cloth, wipe away any dust and dirt that has collected on the plug, the exterior of the power outlet, and the surrounding area.
 - Do not insert or remove the plug with wet hands.
 - Do not use the equipment in a manner that exceeds the rated capacity of the electrical outlet or wiring accessories. Do not use if the plug is damaged or not fully inserted in the outlet.
 - Do not allow dust or metal objects (such as pins or keys) to contact the terminals or plug.
 - Do not cut, damage, alter, or place heavy items on the power cord, if your product uses one.

This could result in electrical shock or fire.

- Turn the camera off in places where camera use is prohibited.

The electromagnetic waves emitted by the camera may interfere with the operation of electronic instruments and other devices. Exercise adequate caution when using the product in places where use of electronic devices is restricted, such as inside airplanes and medical facilities.

- Do not allow the camera to maintain contact with skin for extended periods.

Even if the camera does not feel hot, this may cause low-temperature burns, manifested in redness of the skin or blistering. Use a tripod in hot places, or if you have poor circulation or insensitive skin.

	Caution	Denotes the possibility of injury.
--	----------------	------------------------------------

- When carrying the product by the strap, be careful not to bang it, subject it to strong impacts or shocks, or let it get caught on other objects.

- Be careful not to bump or push strongly on the lens. This could lead to injury or damage the camera.

- Be careful not to subject the screen to strong impacts. If the screen cracks, injury may result from the broken fragments.

- When using the flash, be careful not to cover it with your fingers or clothing.

This could result in burns or damage to the flash.

- Avoid using, placing, or storing the product in the following places:
 - Places subject to direct sunlight
 - Places subject to temperatures above 40 °C (104 °F)
 - Humid or dusty places

These could cause leakage, overheating, or an explosion of the battery pack/batteries, resulting in electrical shock, fire, burns, or other injuries. Overheating and damage may result in electrical shock, fire, burns, or other injuries.

- The slideshow transition effects may cause discomfort when viewed for prolonged periods.

- Before Use
- Basic Guide
- Advanced Guide
 - Camera Basics
 - Auto Mode / Hybrid Auto Mode
 - Other Shooting Modes
 - P Mode
 - Playback Mode
 - Wi-Fi Functions
 - Setting Menu
 - Accessories
 - Appendix
- Index

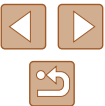

- When using optional lenses, lens filters, or filter adapters (if applicable), be sure to attach these accessories firmly.

If the lens accessory becomes loose and falls off, it may crack, and the shards of glass may lead to cuts.

- On products that raise and lower the flash automatically, make sure to avoid pinching your fingers with the lowering flash.

This could result in injury.

Caution

Denotes the possibility of property damage.

- Do not aim the camera at intense light sources, such as the sun on a clear day or an intense artificial light source.

Doing so may damage the image sensor or other internal components.

- When using the camera on a sandy beach or at a windy location, be careful not to allow dust or sand to enter the camera.
- On products that raise and lower the flash automatically, do not push the flash down or pry it open.

This may cause the product to malfunction.

- Wipe off any dust, grime, or other foreign matter on the flash with a cotton swab or cloth.

The heat emitted from the flash may cause foreign matter to smoke or the product to malfunction.

- Remove and store the battery pack/batteries when you are not using the product.

Any battery leakage that occurs may cause product damage.

- Before you discard the battery pack/batteries, cover the terminals with tape or other insulators.

Contacting other metal materials may lead to fire or explosions.

- Unplug any battery charger used with the product when not in use. Do not cover with a cloth or other objects when in use.

Leaving the unit plugged in for a long period of time may cause it to overheat and distort, resulting in fire.

- Do not leave any dedicated battery packs near pets. Pets biting the battery pack could cause leakage, overheating, or explosion, resulting in product damage or fire.

- If your product uses multiple batteries, do not use batteries that have different levels of charge together, and do not use old and new batteries together. Do not insert the batteries with the + and – terminals reversed.

This may cause the product to malfunction.

- Do not sit down with the camera in your pant pocket. Doing so may cause malfunctions or damage the screen.

- When putting the camera in your bag, ensure that hard objects do not come into contact with the screen. Also close the screen (so that it faces the body), if your product's screen closes.

- Do not attach any hard objects to the product. Doing so may cause malfunctions or damage the screen.



Before Use

Basic Guide

Advanced Guide

Camera Basics

Auto Mode / Hybrid Auto Mode

Other Shooting Modes

P Mode

Playback Mode

Wi-Fi Functions

Setting Menu

Accessories

Appendix

Index



Basic Guide

Basic Operations

Basic information and instructions, from initial preparations to shooting and playback

Initial Preparations

Prepare for shooting as follows.

Attaching the Strap

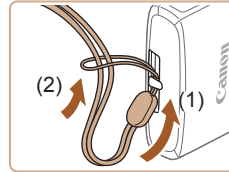

- Thread the end of the strap through the strap mount (1), and then pull the other end of the strap through the loop on the threaded end (2).

Holding the Camera

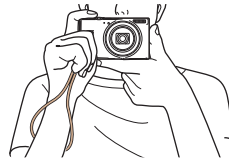

- Place the strap around your wrist.
- When shooting, keep your arms close to your body and hold the camera securely to prevent it from moving. Do not rest your fingers on the flash.

Before Use

Basic Guide

Advanced Guide

Camera Basics

Auto Mode /
Hybrid Auto Mode

Other Shooting Modes

P Mode

Playback Mode

Wi-Fi Functions

Setting Menu

Accessories

Appendix

Index

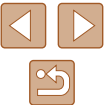

Charging the Battery Pack

Before use, charge the battery pack with the included charger. Be sure to charge the battery pack initially, because the camera is not sold with the battery pack charged.



1 Insert the battery pack.

- After aligning the ▲ marks on the battery pack and charger, insert the battery pack by pushing it in (1) and down (2).

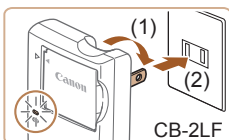

2 Charge the battery pack.

- CB-2LF: Flip out the plug (1) and plug the charger into a power outlet (2).
- CB-2LFE: Plug the power cord into the charger, then plug the other end into a power outlet.
- The charging lamp turns orange, and charging begins.
- When charging is finished, the lamp turns green.

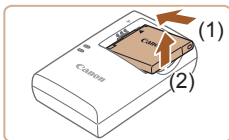
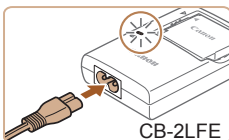

3 Remove the battery pack.

- After unplugging the battery charger, remove the battery pack by pushing it in (1) and up (2).



- To protect the battery pack and keep it in optimal condition, do not charge it continuously for more than 24 hours.
- For battery chargers that use a power cord, do not attach the charger or cord to other objects. Doing so could result in malfunction or damage to the product.



- For details on charging time and the number of shots and recording time possible with a fully charged battery pack, see “Number of Shots/Recording Time, Playback Time” (150).
- Charged battery packs gradually lose their charge, even when they are not used. Charge the battery pack on (or immediately before) the day of use.
- The charger can be used in areas with 100 – 240 V AC power (50/60 Hz). For power outlets in a different format, use a commercially available adapter for the plug. Never use an electrical transformer designed for traveling, which may damage the battery pack.

Inserting the Battery Pack and Memory Card

Insert the included battery pack and a memory card (sold separately). Note that before using a memory card that is new or has been formatted in another device, you should format the memory card with this camera (117).

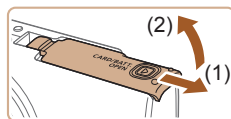

1 Open the cover.

- Slide the cover (1) and open it (2).

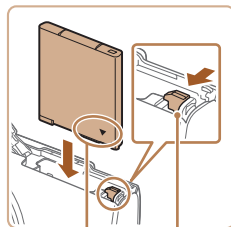

2 Insert the battery pack.

- Holding the battery pack with the terminals (1) facing as shown, press the battery lock (2) in the direction of the arrow and insert the battery pack until the lock clicks shut.
- If you insert the battery pack facing the wrong way, it cannot be locked into the correct position. Always confirm that the battery pack is facing the right way and locks when inserted.

Before Use

Basic Guide

Advanced Guide

Camera Basics

Auto Mode /
Hybrid Auto Mode

Other Shooting Modes

P Mode

Playback Mode

Wi-Fi Functions

Setting Menu

Accessories

Appendix

Index

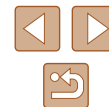

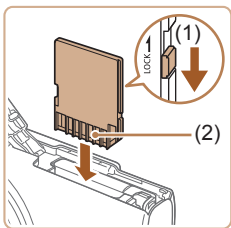

3 Check your card's write-protect switch and insert the memory card.

- Recording is not possible on memory cards with a write-protect switch when the switch is in the locked position. Move the switch toward (1).
- Insert the memory card with the terminals (2) facing as shown until it clicks into place.
- Make sure the memory card is facing the right way when you insert it. Inserting memory cards facing the wrong way may damage the camera.

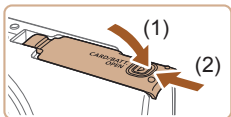

4 Close the cover.

- Lower the cover (1) and hold it down as you slide it, until it clicks into the closed position (2).



- For guidelines on how many shots or hours of recording can be saved on one memory card, see "Number of Shots per Memory Card" (p.151).

Removing the Battery Pack and Memory Card

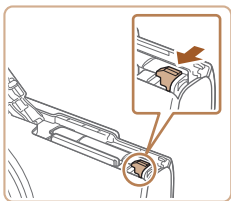

Remove the battery pack.

- Open the cover and press the battery lock in the direction of the arrow.
- The battery pack will pop up.

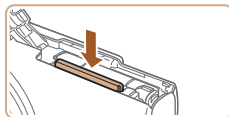

Remove the memory card.

- Push the memory card in until it clicks, and then slowly release it.
- The memory card will pop up.

Setting the Date and Time

Set the current date and time correctly as follows if the [Date/Time] screen is displayed when you turn the camera on. Information you specify this way is recorded in image properties when you shoot, and it is used when you manage images by shooting date or print images showing the date. You can also add a date stamp to shots, if you wish (p.37).

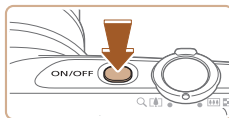

1 Turn the camera on.

- Press the power button.
- The [Date/Time] screen is displayed.

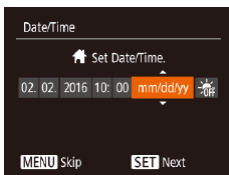

2 Set the date and time.

- Press the [◀][▶] buttons to choose an item.
- Press the [▲][▼] buttons to specify the date and time.
- When finished, press the [⊕] button.

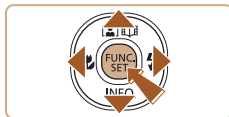

- Before Use
- Basic Guide
- Advanced Guide
 - Camera Basics
 - Auto Mode / Hybrid Auto Mode
 - Other Shooting Modes
 - P Mode
 - Playback Mode
 - Wi-Fi Functions
 - Setting Menu
 - Accessories
 - Appendix
 - Index



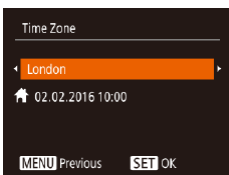

3 Specify your home time zone.

- Press the [◀][▶] buttons to choose your home time zone.

4 Finish the setup process.

- Press the [OK] button when finished. After a confirmation message, the setting screen is no longer displayed.
- To turn off the camera, press the power button.



- Unless you set the date, time, and home time zone, the [Date/Time] screen will be displayed each time you turn the camera on. Specify the correct information.



- To set daylight saving time (1 hour ahead), choose [Off] in step 2 and then choose [On] by pressing the [▲][▼] buttons.

Changing the Date and Time

Adjust the date and time as follows.

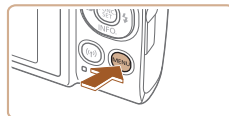

1 Access the menu screen.

- Press the [MENU] button.

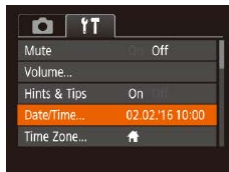

2 Choose [Date/Time].

- Move the zoom lever to choose the [↑] tab.
- Press the [▲][▼] buttons to choose [Date/Time], and then press the [OK] button.

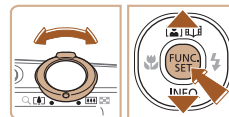

3 Change the date and time.

- Follow step 2 in “Setting the Date and Time” (17) to adjust the settings.
- Press the [MENU] button to close the menu screen.



- Date/time settings can be retained for about 3 weeks by the camera's built-in date/time battery (backup battery) after the battery pack is removed.
- The date/time battery will be charged in about 4 hours once you insert a charged battery pack, even if the camera is left off.
- Once the date/time battery is depleted, the [Date/Time] screen will be displayed when you turn the camera on. Set the correct date and time as described in “Setting the Date and Time” (17).

Before Use

Basic Guide

Advanced Guide

Camera Basics

Auto Mode /
Hybrid Auto Mode

Other Shooting Modes

P Mode

Playback Mode

Wi-Fi Functions

Setting Menu

Accessories

Appendix

Index



Display Language

Change the display language as needed.



1 Enter Playback mode.

- Press the [▶] button.

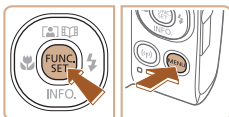

2 Access the setting screen.

- Press and hold the [FUNC SET] button, and then immediately press the [MENU] button.

English	Norsk	Română
Deutsch	Svenska	Türkçe
Français	Español	العربية
Nederlands	Ελληνικά	ગુજરાતી
Dansk	Русский	繁體中文
Português	Polski	繁體中文
Suomi	Čeština	한국어

3 Set the display language.

- Press the [▲][▼][◀][▶] buttons to choose a language, and then press the [FUNC SET] button.
- Once the display language has been set, the setting screen is no longer displayed.



- The current time is displayed if you wait too long in step 2 after pressing the [FUNC SET] button before you press the [MENU] button. In this case, press the [FUNC SET] button to dismiss the time display and repeat step 2.
- You can also change the display language by pressing the [MENU] button and choosing [Language] on the [▶] tab.

Trying the Camera Out

▶ Still Images ▶ Movies

Follow these instructions to turn the camera on, shoot still images or movies, and then view them.

Shooting (Smart Auto)

For fully automatic selection of the optimal settings for specific scenes, simply let the camera determine the subject and shooting conditions.

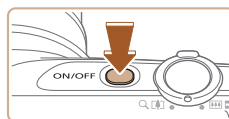

1 Turn the camera on.

- Press the power button.
- The startup screen is displayed.



2 Enter [AUTO] mode.

- Set the mode switch to [CAMERA].
- Press the [FUNC SET] button, press the [▲][▼] buttons to choose [AUTO], and then press the [FUNC SET] button again.
- Press the [▲][▼] buttons to choose [AUTO], and then press the [FUNC SET] button.
- Aim the camera at the subject. The camera will make a slight clicking noise as it determines the scene.
- Icons representing the scene and image stabilization mode are displayed in the upper right of the screen.
- Frames displayed around any detected subjects indicate that they are in focus.



Before Use

Basic Guide

Advanced Guide

Camera Basics

Auto Mode /
Hybrid Auto Mode

Other Shooting Modes

P Mode

Playback Mode

Wi-Fi Functions

Setting Menu

Accessories

Appendix

Index





3 Compose the shot.

- To zoom in and enlarge the subject, move the zoom lever toward [] (telephoto), and to zoom away from the subject, move it toward [] (wide angle).

4 Shoot.

Shooting Still Images

1) Focus.

- Press the shutter button lightly, halfway down. The camera beeps twice after focusing, and frames are displayed to indicate image areas in focus.

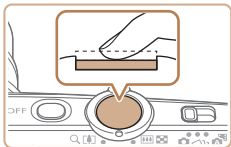

2) Shoot.

- Press the shutter button all the way down.
- As the camera shoots, a shutter sound is played, and in low-light conditions, the flash fires automatically.
- Keep the camera still until the shutter sound ends.
- After displaying your shot, the camera will revert to the shooting screen.

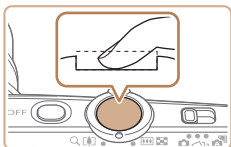

Recording Movies

1) Start recording.

- Press the movie button. The camera beeps once as recording begins, and [●Rec] is displayed with the elapsed time (1).
- Black bars are displayed on the top and bottom edges of the screen, and the subject is slightly enlarged. The black bars indicate image areas not recorded.
- Frames displayed around any detected faces indicate that they are in focus.
- Once recording begins, take your finger off the movie button.

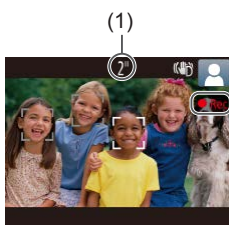

2) Finish recording.

- Press the movie button again to stop recording. The camera beeps twice as recording stops.



Before Use
Basic Guide
Advanced Guide
Camera Basics
Auto Mode / Hybrid Auto Mode
Other Shooting Modes
P Mode
Playback Mode
Wi-Fi Functions
Setting Menu
Accessories
Appendix
Index



Viewing

After shooting images or movies, you can view them on the screen as follows.



1 Enter Playback mode.

- Press the [▶] button.
- Your last shot is displayed.



2 Choose images.

- To view the previous image, press the [◀] button. To view the next image, press the [▶] button.

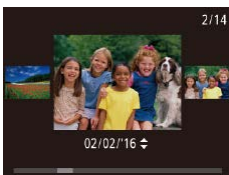

- To access this screen (Scroll Display mode), press and hold the [◀][▶] buttons for at least one second. In this mode, press the [◀][▶] buttons to browse through images.
- To return to single-image display, press the [⊙] button.
- Movies are identified by a [SET ▶] icon. To play movies, go to step 3.



3 Play movies.

- Press the [⊙] button, press the [▲][▼] buttons to choose [▶], and then press the [⊙] button again.
- Playback now begins, and after the movie is finished, [SET ▶] is displayed.
- To adjust the volume, press the [▲][▼] buttons during playback.



- To switch to Shooting mode from Playback mode, press the shutter button halfway.

Erasing Images

You can choose and erase unneeded images one by one. Be careful when erasing images, because they cannot be recovered.

1 Choose an image to erase.

- Press the [◀][▶] buttons to choose an image.

2 Erase the image.

- Press the [⊙] button, press the [▲][▼] buttons to choose [Erase?], and then press the [⊙] button again.
- After [Erase?] is displayed, press the [◀][▶] buttons to choose [Erase], and then press the [⊙] button.
- The current image is now erased.
- To cancel erasure, press the [◀][▶] buttons to choose [Cancel], and then press the [⊙] button.

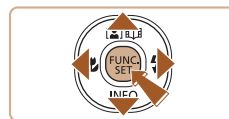

- You can choose multiple images to erase at once (75).

Before Use

Basic Guide

Advanced Guide

Camera Basics

Auto Mode / Hybrid Auto Mode

Other Shooting Modes

P Mode

Playback Mode

Wi-Fi Functions

Setting Menu

Accessories

Appendix

Index



Advanced Guide

Camera Basics

Other basic operations and more ways to enjoy your camera, including shooting and playback options

On/Off

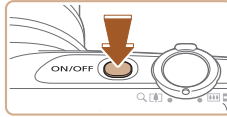

Shooting Mode

- Press the power button to turn the camera on and prepare for shooting.
- To turn the camera off, press the power button again.



Playback Mode

- Press the [▶] button to turn the camera on and view your shots.
- To turn the camera off, press the [▶] button again.



- To switch to Playback mode from Shooting mode, press the [▶] button.
- To switch to Shooting mode from Playback mode, press the shutter button halfway (p. 23).
- The lens will be retracted after about one minute once the camera is in Playback mode. You can turn the camera off when the lens is retracted by pressing the [▶] button.

Before Use

Basic Guide

Advanced Guide

Camera Basics

Auto Mode /
Hybrid Auto Mode

Other Shooting Modes

P Mode

Playback Mode

Wi-Fi Functions

Setting Menu

Accessories

Appendix

Index

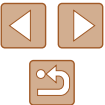

Power-Saving Features (Auto Power Down)

As a way to conserve battery power, the camera automatically deactivates the screen (Display Off) and then turns itself off after a specific period of inactivity.

Power Saving in Shooting Mode

The screen is automatically deactivated after about one minute of inactivity. In about two more minutes, the lens is retracted and the camera turns itself off. To activate the screen and prepare for shooting when the screen is off but the lens is still out, press the shutter button halfway (123).

Power Saving in Playback Mode

The camera turns itself off automatically after about five minutes of inactivity.



- You can deactivate Auto Power Down and adjust the timing of Display Off, if you prefer (116).
- Power saving is not active while the camera is connected to other devices via Wi-Fi (87), or when connected to a computer (126).

Shutter Button

To ensure your shots are in focus, always begin by holding the shutter button halfway down, and once the subject is in focus, press the button all the way down to shoot.

In this manual, shutter button operations are described as pressing the button *halfway* or *all the way down*.

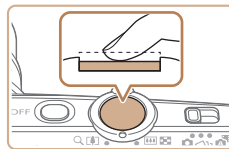

1 Press halfway. (Press lightly to focus.)

- Press the shutter button halfway. The camera beeps twice, and frames are displayed around image areas in focus.

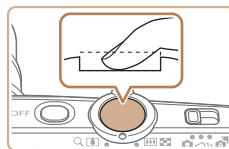

2 Press all the way down. (From the halfway position, press fully to shoot.)

- The camera shoots, as a shutter sound is played.
- Keep the camera still until the shutter sound ends.



- Images may be out of focus if you shoot without initially pressing the shutter button halfway.
- Length of shutter sound playback varies depending on the time required for the shot. It may take longer in some shooting scenes, and images will be blurry if you move the camera (or the subject moves) before the shutter sound ends.

Before Use

Basic Guide

Advanced Guide

Camera Basics

Auto Mode /
Hybrid Auto Mode

Other Shooting Modes

P Mode

Playback Mode

Wi-Fi Functions

Setting Menu

Accessories



Appendix

Index



Shooting Display Options

Press the [▼] button to view other information on the screen, or to hide the information. For details on the information displayed, see “On-Screen Information” (140).

	Information is displayed
	No information is displayed



- Screen brightness is automatically increased by the night view function when you are shooting under low light, making it easier to check how shots are composed. However, on-screen image brightness may not match the brightness of your shots. Note that any on-screen image distortion or jerky subject motion will not affect recorded images.
- For playback display options, see “Switching Display Modes” (65).

Using the FUNC. Menu

Configure commonly used functions through the FUNC. menu as follows. Note that menu items and options vary depending on the shooting mode (143) or playback mode (148).



1 Access the FUNC. menu.

- Press the [FUNC.] button.

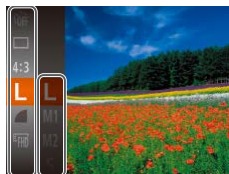

(1)
(2)

2 Choose a menu item.

- Press the [▲][▼] buttons to choose a menu item (1), and then press the [FUNC.] or [▶] button.
- Available options (2) are listed next to menu items, on the right.
- Depending on the menu item, functions can be specified simply by pressing the [FUNC.] or [▶] button, or another screen is displayed for configuring the function.

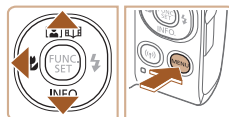

3 Choose an option.

- Press the [▲][▼] buttons to choose an option.
- Items labeled with a [MENU] icon can be configured by pressing the [MENU] button.
- To return to the menu items, press the [◀] button.

Before Use
Basic Guide
Advanced Guide
Camera Basics
Auto Mode / Hybrid Auto Mode
Other Shooting Modes
P Mode
Playback Mode
Wi-Fi Functions
Setting Menu
Accessories
Appendix
Index

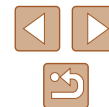



4 Confirm your choice and exit.

- Press the [MENU] button.
- The screen before you pressed the [MENU] button in step 1 is displayed again, showing the option you configured.



- To undo any accidental setting changes, you can restore the camera's default settings (120).

Using the Menu Screen

Configure a variety of camera functions through the menu screen as follows. Menu items are grouped by purpose on tabs, such as shooting [CAMERA], playback [REPLAY], and so on. Note that available menu items vary depending on the selected shooting or playback mode (145 – 148).

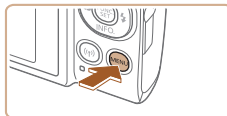

1 Access the menu screen.

- Press the [MENU] button.



2 Choose a tab.

- Move the zoom lever to choose a tab.
- After you have pressed the [▲][▼] buttons to choose a tab initially, you can switch between tabs by pressing the [◀][▶] buttons.

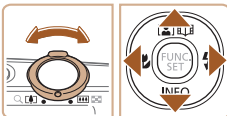

Before Use

Basic Guide

Advanced Guide

Camera Basics

Auto Mode /
Hybrid Auto Mode

Other Shooting Modes

P Mode

Playback Mode

Wi-Fi Functions

Setting Menu

Accessories

Appendix

Index

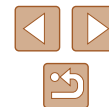

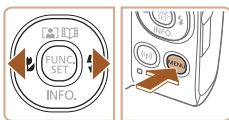
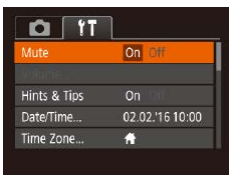
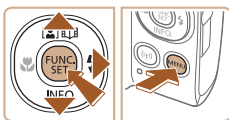
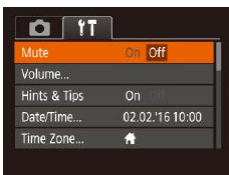

3 Choose a menu item.

- Press the [▲][▼] buttons to choose a menu item.
- For menu items with options not shown, first press the [⊕] or [▶] button to switch screens, and then press the [▲][▼] buttons to select the menu item.
- To return to the previous screen, press the [MENU] button.

4 Choose an option.

- Press the [◀][▶] buttons to choose an option.

5 Confirm your choice and exit.

- Press the [MENU] button to return to the screen displayed before you pressed the [MENU] button in step 1.



- To undo any accidental setting changes, you can restore the camera's default settings (120).

On-Screen Keyboard

Use the on-screen keyboard to enter information for Wi-Fi connections (88). Note that the length and type of information you can enter varies depending on the function you are using.

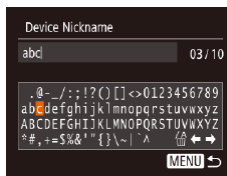

Entering Characters

- Press the [▲][▼][◀][▶] buttons to choose a character, and then press the [⊕] button to enter it.

Moving the Cursor

- Choose [◀] or [▶] and press the [⊕] button.

Deleting Characters

- Choose [↶] and press the [⊕] button. The previous character will be deleted.

Confirming Input and Returning to the Previous Screen

- Press the [MENU] button.

Before Use

Basic Guide

Advanced Guide

Camera Basics

Auto Mode / Hybrid Auto Mode

Other Shooting Modes

P Mode

Playback Mode

Wi-Fi Functions

Setting Menu

Accessories

Appendix

Index



Indicator Display

The indicator on the back of the camera (📖4) blinks in green at these times.

- Connected to a computer (📖126)
- Display off (📖23, 📖116)
- Starting up, recording, or reading
- Communicating with other devices
- Shooting long exposures (📖52)
- Connecting/transmitting via Wi-Fi



- When the indicator blinks green, do not turn the camera off, or open the memory card/battery cover, or shake or hit the camera. This may corrupt images or damage the camera or memory card.

Clock

You can check the current time.

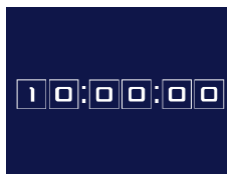

- Press and hold the [📷] button.
- The current time appears.
- If you hold the camera vertically while using the clock function, it will switch to vertical display. Press the [◀][▶] buttons to change the display color.
- Press the [📷] button again to cancel the clock display.



- When the camera is off, press and hold the [📷] button, then press the power button to display the clock.

Before Use

Basic Guide

Advanced Guide

Camera Basics

Auto Mode /
Hybrid Auto Mode

Other Shooting Modes

P Mode

Playback Mode

Wi-Fi Functions

Setting Menu

Accessories

Appendix

Index



Auto Mode / Hybrid Auto Mode

Convenient mode for easy shots with greater control over shooting

Shooting with Camera-Determined Settings

For fully automatic selection of the optimal settings for specific scenes, simply let the camera determine the subject and shooting conditions.

Shooting (Smart Auto)



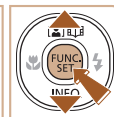
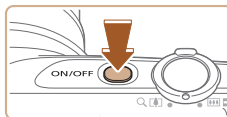







► Still Images ► Movies



1 Turn the camera on.

- Press the power button.
- The startup screen is displayed.

2 Enter [AUTO] mode.

- Set the mode switch to .
- Press the  button, press the  buttons to choose [AUTO], and then press the  button again.
- Press the  buttons to choose [AUTO], and then press the  button.
- Aim the camera at the subject. The camera will make a slight clicking noise as it determines the scene.
- Icons representing the scene and image stabilization mode are displayed in the upper right of the screen (32, 33).
- Frames displayed around any detected subjects indicate that they are in focus.

Before Use

Basic Guide

Advanced Guide

Camera Basics

Auto Mode /
Hybrid Auto Mode

Other Shooting Modes

P Mode

Playback Mode

Wi-Fi Functions

Setting Menu

Accessories

Appendix

Index

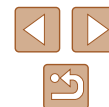



(1)



3 Compose the shot.

- To zoom in and enlarge the subject, move the zoom lever toward [📷] (telephoto), and to zoom away from the subject, move it toward [📷] (wide angle). (A zoom bar (1) showing the zoom position is displayed.)
- To zoom in or out quickly, move the zoom lever all the way toward [📷] (telephoto) or [📷] (wide angle), and to zoom in or out slowly, move it just a little in the desired direction.

4 Shoot.

Shooting Still Images

1) Focus.

- Press the shutter button halfway. The camera beeps twice after focusing, and frames are displayed to indicate image areas in focus.
- Several AF frames are displayed when multiple areas are in focus.

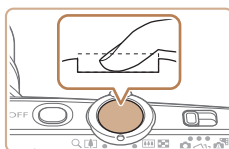
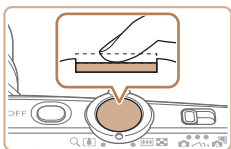

(1)



2) Shoot.

- Press the shutter button all the way down.
- As the camera shoots, a shutter sound is played, and in low-light conditions, the flash fires automatically.
- Keep the camera still until the shutter sound ends.
- After displaying your shot, the camera will revert to the shooting screen.

Recording Movies

1) Start recording.

- Press the movie button. The camera beeps once as recording begins, and [●Rec] is displayed with the elapsed time (1).
- Black bars are displayed on the top and bottom edges of the screen, and the subject is slightly enlarged. The black bars indicate image areas not recorded.
- Frames displayed around any detected faces indicate that they are in focus.
- Once recording begins, take your finger off the movie button.

Before Use
Basic Guide
Advanced Guide
Camera Basics
Auto Mode / Hybrid Auto Mode
Other Shooting Modes
P Mode
Playback Mode
Wi-Fi Functions
Setting Menu
Accessories
Appendix
Index





2) Resize the subject and recompose the shot as needed.

- To resize the subject, repeat the operations in step 3. However, note that the sound of camera operations will be recorded. Note that movies shot at zoom factors shown in blue will look grainy.
- When you recompose shots, the focus, brightness, and colors will be automatically adjusted.

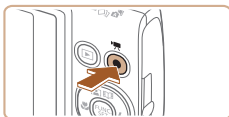

3) Finish recording.

- Press the movie button again to stop recording. The camera beeps twice as recording stops.
- Recording will stop automatically when the memory card becomes full.

Shooting in Hybrid Auto Mode

► Still Images ► Movies

You can make a short movie of the day just by shooting still images. The camera records 2 – 4-second clips of scenes before each shot, which are later combined in a digest movie.



1 Enter [Hybrid Auto] mode.

- Set the mode switch to [Hybrid Auto].



2 Compose the shot.

- Follow steps 3 – 4 in “Shooting (Smart Auto)” (p.28) to compose the shot and focus.
- For more impressive digest movies, aim the camera at subjects about four seconds before shooting still images.

3 Shoot.

- Follow step 4 in “Shooting (Smart Auto)” (p.28) to shoot a still image.
- The camera records both a still image and movie clip. The clip, which ends with the still image and a shutter sound, forms a single chapter in the digest movie.



- Battery life is shorter in this mode than in [AUTO] mode, because digest movies are recorded for each shot.
- A digest movie may not be recorded if you shoot a still image immediately after turning the camera on, choosing [Hybrid Auto] mode, or operating the camera in other ways.
- Camera operating sounds will be recorded in digest movies.

Before Use

Basic Guide

Advanced Guide

Camera Basics

Auto Mode /
Hybrid Auto Mode

Other Shooting Modes

P Mode

Playback Mode

Wi-Fi Functions

Setting Menu

Accessories

Appendix

Index

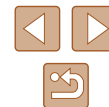



- Digest movie quality is [EHD] and cannot be changed.
- Sounds are not played when you press the shutter button halfway or trigger the self-timer.
- Digest movies are saved as separate movie files in the following cases even if they were recorded on the same day in [A] mode.
 - The digest movie file size reaches approximately 4 GB, or the total recording time reaches approximately 29 minutes and 59 seconds.
 - The digest movie is protected (172).
 - Daylight saving time (117) or time zone (115) settings are changed.
 - A new folder is created (119).
- Recorded shutter sounds cannot be modified or erased.
- If you prefer to record digest movies without still images, adjust the setting in advance. Choose MENU (25) ► [A] tab ► [Digest Type] ► [No Stills] (25).
- Individual chapters can be edited (83).

Digest Movie Playback

Display a still image shot in [A] mode to play the digest movie created on the same day, or specify the date of the digest movie to play (66).

Still Images/Movies



- If the camera makes no operating sounds, it may have been turned on while holding down the [▼] button. To activate sounds, press the [MENU] button, choose [Mute] on the [f] tab, and then press the [◀] [▶] buttons or choose [Off].

Still Images



- A blinking [9] icon warns that images are more likely to be blurred by camera shake. In this case, mount the camera on a tripod or take other measures to keep it still.
- If your shots are dark despite the flash firing, move closer to the subject. For details on the flash range, see "Camera" (149).
- The subject may be too close if the camera only beeps once when you press the shutter button halfway. For details on the range of focus (shooting range), see "Shooting Range" (150).
- To reduce red-eye and to assist in focusing, the lamp may be lit when shooting in low-light conditions.
- A blinking [f] icon displayed when you attempt to shoot indicates that shooting is not possible until the flash has finished recharging. Shooting can resume as soon as the flash is ready, so either press the shutter button all the way down and wait, or release it and press it again.
- Although you can shoot again before the shooting screen is displayed, your previous shot may determine the focus, brightness, and colors used.



- You can change how long images are displayed after shots (43).

Before Use

Basic Guide

Advanced Guide

Camera Basics

Auto Mode /
Hybrid Auto Mode

Other Shooting Modes

P Mode

Playback Mode

Wi-Fi Functions

Setting Menu

Accessories

Appendix

Index



Movies



- Keep your fingers away from the microphone while recording movies. Blocking the microphone may prevent audio from being recorded or may cause the recording to sound muffled.



- Avoid touching camera controls other than the movie button when recording movies, because sounds made by the camera will be recorded.
- Once movie recording begins, the image display area changes and subjects are enlarged to allow for correction of significant camera shake. To shoot subjects at the same size shown before shooting, adjust the image stabilization setting (41).



- Audio recording is monaural.

Scene Icons

► Still Images ► Movies

In [A] and [AUTO] modes, shooting scenes determined by the camera are indicated by the icon displayed, and corresponding settings are automatically selected for optimal focusing, subject brightness, and color.

Background	When Shooting People			Icon Background Color
	People	In Motion*1	Shadows on Face*1	
Bright				Gray
Bright and Backlit			–	
With Blue Sky				Light Blue
Blue Sky and Backlit			–	
Spotlights				Dark Blue
Dark				
Dark, Using Tripod		–	–	

Before Use

Basic Guide

Advanced Guide

Camera Basics

Auto Mode / Hybrid Auto Mode

Other Shooting Modes

P Mode

Playback Mode

Wi-Fi Functions

Setting Menu

Accessories

Appendix

Index



Background	When Shooting Other Subjects			Icon Background Color
	Other Subjects	In Motion*1	At Close Range	
Bright				Gray
Bright and Backlit				
With Blue Sky				Light Blue
Blue Sky and Backlit				
Sunsets			—	Orange
Spotlights				Dark Blue
Dark				
Dark, Using Tripod	*2	—	—	

*1 Not displayed for movies.

*2 Displayed in dark scenes when the camera is held still, as when mounted on a tripod.



- Try shooting in **P** mode (📖53) if the scene icon does not match actual shooting conditions, or if it is not possible to shoot with your expected effect, color, or brightness.

Image Stabilization Icons

► Still Images ► Movies

Optimal image stabilization for the shooting conditions is automatically applied (Intelligent IS). Additionally, the following icons are displayed in **[A/AF]** and **[AUTO]** modes.

	Image stabilization for still images (Normal)
	Image stabilization for still images when panning (Panning)*
	Image stabilization for angular camera shake and shift-shake in macro shots (Hybrid IS). For movies, is displayed and image stabilization is also applied.
	Image stabilization for movies, reducing strong camera shake, as when recording while walking (Dynamic)
	Image stabilization for slow camera shake, such as when recording movies at telephoto (Powered)
	No image stabilization, because the camera is mounted on a tripod or held still by other means. However, during movie recording, is displayed, and image stabilization to counteract wind or other sources of vibration is used (Tripod IS).

* Displayed when you pan, following moving subjects with the camera. When you follow subjects moving horizontally, image stabilization only counteracts vertical camera shake, and horizontal stabilization stops. Similarly, when you follow subjects moving vertically, image stabilization only counteracts horizontal camera shake.



- To cancel image stabilization, set [IS Mode] to [Off] (📖41). In this case, an IS icon is not displayed.
- In **[A/AF]** mode, no **[Panning]** icon is displayed.

Before Use

Basic Guide

Advanced Guide

Camera Basics

Auto Mode / Hybrid Auto Mode

Other Shooting Modes

P Mode

Playback Mode

Wi-Fi Functions

Setting Menu

Accessories

Appendix

Index



On-Screen Frames

► Still Images ► Movies

In [AUTO] mode, a variety of frames are displayed once the camera detects subjects you are aiming the camera at.

- A white frame is displayed around the subject (or person's face) determined by the camera to be the main subject, and gray frames are displayed around other detected faces. Frames follow moving subjects within a certain range to keep them in focus. However, if the camera detects subject movement, only the white frame will remain on the screen.
- When you are pressing the shutter button halfway and the camera detects subject movement, a blue frame is displayed, and the focus and image brightness are constantly adjusted (Servo AF).



- Try shooting in [P] mode (53) if no frames are displayed, if frames are not displayed around desired subjects, or if frames are displayed on the background or similar areas.

Common, Convenient Features

Zooming In Closer on Subjects (Digital Zoom)

► Still Images ► Movies

When distant subjects are too far away to enlarge using optical zoom, use digital zoom for up to about 48x enlargement.



1 Move the zoom lever toward [Z].

- Hold the lever until zooming stops.
- Zooming stops at the largest zoom factor before the image becomes noticeably grainy, which is then indicated on the screen.

2 Move the zoom lever toward [Z] again.

- (1) is the current zoom factor.
- The camera zooms in even closer on the subject.

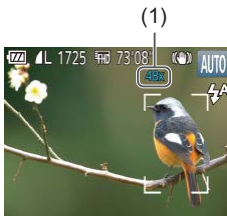

Before Use

Basic Guide

Advanced Guide

Camera Basics

Auto Mode /
Hybrid Auto Mode

Other Shooting Modes

P Mode

Playback Mode

Wi-Fi Functions

Setting Menu

Accessories

Appendix

Index





- Moving the zoom lever will display the zoom bar (which indicates the zoom position). The zoom bar is color-coded to indicate the zoom range.
 - White range: optical zoom range where the image will not appear grainy.
 - Yellow range: digital zoom range where the image is not noticeably grainy (ZoomPlus).
 - Blue range: digital zoom range where the image will appear grainy.
- Because the blue range will not be available at some recording pixel settings (📖39), the maximum zoom factor can be achieved by following step 1.



- To deactivate digital zoom, choose MENU (📖25) ▶ [📷] tab ▶ [Digital Zoom] ▶ [Off].

Auto Zooming in Response to Subject Movement (Auto Zoom)

▶ Still Images ▶ Movies

The camera automatically zooms in and out to keep a detected face (📖28) at a constant size. If the person moves closer, the camera automatically zooms out, and vice versa.



1 Enter Auto Zoom mode.

- Press the [▲] button.
- [👤] is displayed.
- A white frame is displayed around the detected face, and the camera zooms in and out to keep the subject on the screen.



- When multiple faces are detected, a white frame is displayed around the main subject's face and up to two gray frames around other faces, as the camera zooms to keep these subjects on the screen.

2 Shoot.

- Auto zooming continues even after you shoot, and the frames are still displayed.
- To cancel auto zooming, press the [▲] button again. [👤] is displayed.



- Faces may not be detected at some zoom factors, or if the subject's head is tilted or facing the camera indirectly.
- Auto zooming is deactivated in the following situations.
 - When you change the shooting mode
 - When you press the [MENU] button, movie button, or [📷] button
 - When you press the [▶] button



- When a detected subject moves toward the edge of the screen, the camera zooms out to keep the subject on the screen.
- The zoom factor cannot be changed after you press the shutter button all the way down in self-timer mode (📖36).
- The camera prioritizes zooming to keep subjects on the screen. For this reason, it may not be possible to maintain a constant face display size, depending on subject movement and shooting conditions.
- When no face is detected, the camera zooms to a certain level and stops zooming until a face is detected.

Before Use

Basic Guide

Advanced Guide

Camera Basics

Auto Mode / Hybrid Auto Mode

Other Shooting Modes

P Mode

Playback Mode

Wi-Fi Functions

Setting Menu

Accessories

Appendix

Index







Using the Self-Timer

► Still Images ► Movies



With the self-timer, you can include yourself in group photos or other timed shots. The camera will shoot about 10 seconds after you press the shutter button.



1 Configure the setting.

- Press the  button, choose  in the menu, and then choose  (p.24).
- Once the setting is complete,  is displayed.

2 Shoot.

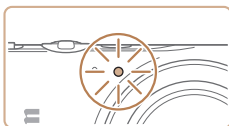

- For Still Images: Press the shutter button halfway to focus on the subject, and then press it all the way down.
- For Movies: Press the movie button.
- Once you start the self-timer, the lamp will blink and the camera will play a self-timer sound.
- Two seconds before the shot, the blinking and sound will speed up. (The lamp will remain lit in case the flash fires.)
- To cancel shooting after you have triggered the self-timer, press the  button.
- To restore the original setting, choose  in step 1.

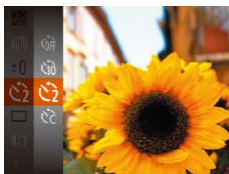

Using the Self-Timer to Avoid Camera Shake

This option delays shutter release until about two seconds after you have pressed the shutter button. If the camera is unsteady while you are pressing the shutter button, it will not affect your shot.





- Follow step 1 in “Using the Self-Timer” (p.36) and choose .
- Once the setting is complete,  is displayed.
- Follow step 2 in “Using the Self-Timer” (p.36) to shoot.







Customizing the Self-Timer

You can specify the delay (0 – 30 seconds) and number of shots (1 – 10).

1 Choose .

- Following step 1 in “Using the Self-Timer” (p.36), choose  and press the  button.

2 Configure the setting.

- Press the /  buttons to choose the delay time or number of shots.
- Press the /  buttons to choose a value, and then press the .
- Once the setting is complete,  is displayed.
- Follow step 2 in “Using the Self-Timer” (p.36) to shoot.

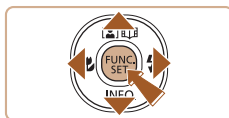
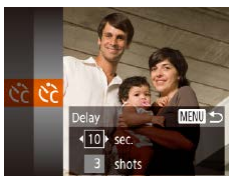

Before Use

Basic Guide

Advanced Guide

Camera Basics

Auto Mode /
Hybrid Auto Mode

Other Shooting Modes

P Mode

Playback Mode

Wi-Fi Functions

Setting Menu

Accessories

Appendix

Index

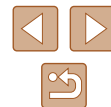



- For movies recorded using the self-timer, recording begins after your specified delay time, but specifying the number of shots has no effect.



- When you specify multiple shots, image brightness and white balance are determined by the first shot. More time is required between shots when the flash fires or when you have specified to take many shots. Shooting will stop automatically when the memory card becomes full.
- When a delay longer than two seconds is specified, two seconds before the shot, the lamp blinking and self-timer sound will speed up. (The lamp will remain lit in case the flash fires.)

Deactivating the Flash

► Still Images ► Movies

Prepare the camera for shooting without the flash as follows.



- Press the [▶] button several times until [🔴] is displayed.
- The flash will no longer be activated.
- To activate the flash, press the [▶] button again. (🔴A is displayed.) The flash will automatically fire in low-light conditions.

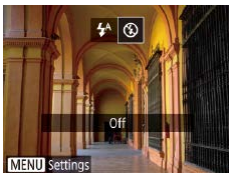

- If a blinking [🔴] icon is displayed when you press the shutter button halfway in camera-shake inducing, low-light conditions, mount the camera on a tripod or take other measures to keep it still.

Adding a Date Stamp

► Still Images ► Movies

The camera can add the shooting date to images, in the lower-right corner. However, note that date stamps cannot be edited or removed, so confirm beforehand that the date and time are correct (📖17).

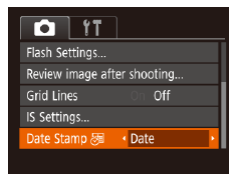
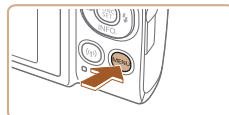

1 Configure the setting.

- Press the [MENU] button, choose [Date Stamp] on the [📷] tab, and then choose the desired option (📖25).
- Once the setting is complete, [📷] is displayed.

2 Shoot.

- As you take shots, the camera adds the shooting date or time to the lower-right corner of images.
- To restore the original setting, choose [Off] in step 1.



- Date stamps cannot be edited or removed.



- Shots taken without adding a date stamp can be printed with one as follows. However, adding a date stamp this way to images that already have one may cause it to be printed twice.
 - Print using printer functions (📖127)
 - Use camera DPOF print settings (📖131) to print

Before Use
Basic Guide
Advanced Guide
Camera Basics
Auto Mode / Hybrid Auto Mode
Other Shooting Modes
P Mode
Playback Mode
Wi-Fi Functions
Setting Menu
Accessories
Appendix
Index



Continuous Shooting

► Still Images ► Movies

In [AUTO] mode, hold the shutter button all the way down to shoot continuously.

For details on the continuous shooting speed, see “Camera” (📖149).



1 Configure the setting.

- Press the [MENU] button, choose [FUNC. SET.] in the menu, and then choose [] (📖24).
- Once the setting is complete, [] is displayed.

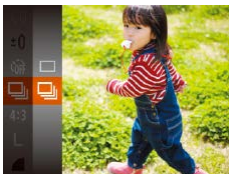

2 Shoot.

- Hold the shutter button all the way down to shoot continuously.



- During continuous shooting, the focus, exposure, and colors are locked at the position/level determined when you pressed the shutter button halfway.
- Cannot be used with the self-timer (📖36).
- Shooting may stop momentarily or continuous shooting may slow down depending on shooting conditions, camera settings, and the zoom position.
- As more shots are taken, shooting may slow down.
- Shooting may slow down if the flash fires.

Image Customization Features

Changing the Aspect Ratio

► Still Images ► Movies

Change the image aspect ratio (ratio of width to height) as follows.



- Press the [MENU] button, choose [4:3] in the menu, and choose the desired option (📖24).
- Once the setting is complete, the screen aspect ratio will be updated.
- To restore the original setting, repeat this process but choose [4:3].

16:9	Used for display on widescreen HDTVs or similar display devices.
3:2	Same aspect ratio as 35mm film, used for printing images at 5 x 7-inch or postcard sizes.
4:3	Native aspect ratio of the camera screen. Used for display on standard-definition televisions or similar display devices. Also used for printing images at 3.5 x 5-inch or A-series sizes.
1:1	Square aspect ratio.



- Not available in [] mode.

Before Use

Basic Guide

Advanced Guide

Camera Basics

Auto Mode /
Hybrid Auto Mode

Other Shooting Modes

P Mode

Playback Mode

Wi-Fi Functions

Setting Menu

Accessories

Appendix

Index



Changing the Number of Recording Pixels (Image Size)

► Still Images ► Movies

Choose the image's number of recording pixels from 4 levels, as follows. For guidelines on how many shots at each recording pixel setting can fit on a memory card, see "Number of Shots per Memory Card" (📖151).

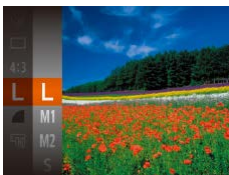

- Press the [MENU] button, choose [L] in the menu, and choose the desired option (📖24).
- The option you configured is now displayed.
- To restore the original setting, repeat this process but choose [L].

Guidelines for Choosing Recording Pixel Setting Based on Paper Size (for 4:3 Images)

L	A2 (16.5 x 23.4 in.)
M1	A3 – A5 (11.7 x 16.5 – 5.8 x 8.3 in.)
M2	3.5 x 5 in., 5 x 7 in., Postcard
S	For e-mailing and similar purposes



- Not available in [A] mode.

Changing Movie Image Quality

► Still Images ► Movies

Three image quality settings are available. For guidelines on the total recording time for movies at each level of image quality that will fit on a memory card, see "Recording Time per Memory Card" (📖151).

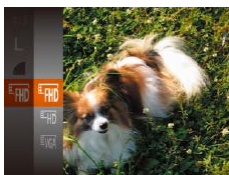

- Press the [MENU] button, choose [FHD] in the menu, and choose the desired option (📖24).
- The option you configured is now displayed.
- To restore the original setting, repeat this process but choose [FHD].

Image Quality	Number of Recording Pixels	Frame Rate	Details
FHD	1920 x 1080	30 fps	For shooting in Full HD.
HD	1280 x 720	30 fps	For shooting in HD.
VGA	640 x 480	30 fps	For shooting in standard definition.



- In [FHD] and [HD] modes, black bars displayed on the top and bottom edges of the screen indicate image areas not recorded.

Before Use

Basic Guide

Advanced Guide

Camera Basics

Auto Mode / Hybrid Auto Mode

Other Shooting Modes

P Mode

Playback Mode

Wi-Fi Functions

Setting Menu

Accessories

Appendix

Index



Helpful Shooting Features

Displaying Grid Lines

► Still Images ► Movies

Grid lines can be displayed on the screen for vertical and horizontal reference while shooting.

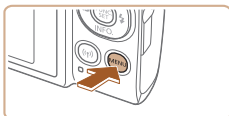

- Press the [MENU] button, choose [Grid Lines] on the [CAMERA] tab, and then choose [On] (📖25).
- Once the setting is complete, grid lines are displayed on the screen.
- To restore the original setting, repeat this process but choose [Off].

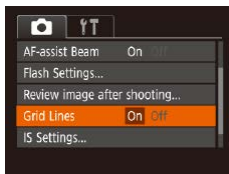

- Grid lines are not recorded in your shots.

Magnifying the Area in Focus

► Still Images ► Movies

You can check the focus by pressing the shutter button halfway, which will enlarge the portion of the image in focus in the AF frame.

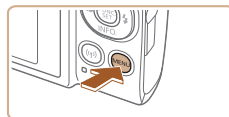

1 Configure the setting.

- Press the [MENU] button, choose [AF-Point Zoom] on the [CAMERA] tab, and then choose [On] (📖25).

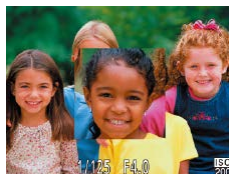

2 Check the focus.

- Press the shutter button halfway. The face detected as the main subject is now magnified.
- To restore the original setting, choose [Off] in step 1.



- The area in focus is not magnified in the following cases when the shutter button is pressed halfway.
 - If a face was not detected, if the person is too close to the camera and their face is too large for the screen, or if the camera detects subject movement
 - When digital zoom is used (📖34)
 - When Tracking AF is used (📖60)
 - When a TV is used as a display (📖123)
- Not available in [A/AF] mode.

Before Use

Basic Guide

Advanced Guide

Camera Basics

Auto Mode /
Hybrid Auto Mode

Other Shooting Modes

P Mode

Playback Mode

Wi-Fi Functions

Setting Menu

Accessories

Appendix

Index



Changing the IS Mode Settings

Deactivating Image Stabilization

▶ Still Images ▶ Movies

When the camera is held still (as when shooting from a tripod), you should set image stabilization to [Off] to deactivate it.

1 Access the setting screen.

- Press the [MENU] button, choose [IS Settings] on the [CAMERA] tab, and then press the [INFO] button (425).

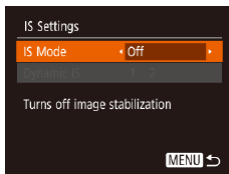

2 Configure the setting.

- Press the [▲][▼] buttons to choose [IS Mode], and then choose [Off] by pressing the [◀][▶] buttons.

Continuous	Optimal image stabilization for the shooting conditions is automatically applied (Intelligent IS) (433).
Off	Deactivates image stabilization.

Recording Movies with Subjects at the Same Size Shown before Shooting

▶ Still Images ▶ Movies

Normally, once movie recording begins, the image display area changes and subjects are enlarged to allow for correction of significant camera shake.

To record movies with subjects at the same size shown before shooting, you can reduce image stabilization.

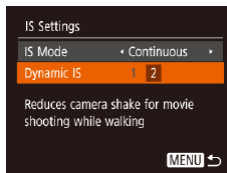

- Follow the steps in "Deactivating Image Stabilization" (441) to access the [IS Settings] screen.
- Choose [Dynamic IS], and then choose [2] (425).



- You can also set [IS Mode] to [Off], so that subjects are recorded at the same size shown before shooting.
- [Dynamic IS] is not available when [IS Mode] is set to [Off] (441).
- When the movie quality is [FHD], Dynamic IS is [1] and cannot be changed.

Before Use

Basic Guide

Advanced Guide

Camera Basics

Auto Mode /
Hybrid Auto Mode

Other Shooting Modes

P Mode

Playback Mode

Wi-Fi Functions

Setting Menu

Accessories

Appendix

Index

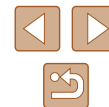

Customizing Camera Operation

Customize shooting functions on the [CAMERA] tab of the menu screen as follows.

For instructions on menu functions, see “Using the Menu Screen” (p.25).

Deactivating the AF-Assist Beam

▶ Still Images ▶ Movies

You can deactivate the lamp that normally lights up to help you focus when you press the shutter button halfway in low-light conditions.

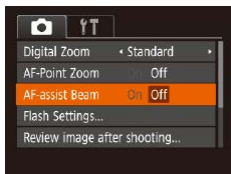

- Press the [MENU] button, choose [AF-assist Beam] on the [CAMERA] tab, and then choose [Off].
- To restore the original setting, repeat this process but choose [On].

Deactivating the Red-Eye Reduction Lamp

▶ Still Images ▶ Movies

You can deactivate the red-eye reduction lamp that lights up to reduce red-eye when the flash is used in low-light shots.

1 Access the [Flash Settings] screen.

- Press the [MENU] button, choose [Flash Settings] on the [CAMERA] tab, and then press the [OK] button.

2 Configure the setting.

- Set [Red-Eye Lamp] to [Off].
- To restore the original setting, repeat this process but choose [On].

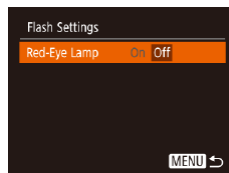

Before Use

Basic Guide

Advanced Guide

Camera Basics

Auto Mode /
Hybrid Auto Mode

Other Shooting Modes

P Mode

Playback Mode

Wi-Fi Functions

Setting Menu

Accessories

Appendix

Index

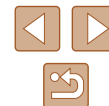

Changing the Image Display Style after Shots

► Still Images ► Movies

You can change how long images are displayed and what information is displayed immediately after shooting.

Changing the Image Display Period after Shots

1 Access the [Review image after shooting] screen.

- Press the [MENU] button, choose [Review image after shooting] on the [CAMERA] tab, and then press the [OK] button.

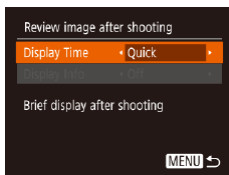

2 Configure the setting.

- Choose [Display Time], and then choose the desired option.
- To restore the original setting, repeat this process but choose [Quick].

Quick	Displays images only until you can shoot again.
2 sec., 4 sec., 8 sec.	Displays images for the specified time. Even while the shot is displayed, you can take another shot by pressing the shutter button halfway again.
Hold	Displays images until you press the shutter button halfway.
Off	No image display after shots.

Changing the Screen Displayed after Shots

Change the way images are displayed after shots as follows.

1 Set [Display Time] to [2 sec.], [4 sec.], [8 sec.], or [Hold] (p. 43).

2 Configure the setting.

- Choose [Display Info], and then choose the desired option.
- To restore the original setting, repeat this process but choose [Off].

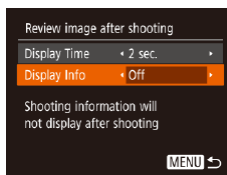

Off	Displays only the image.
Detailed	Displays shooting details (p. 141).



- When [Display Time] (p. 43) is set to [Off] or [Quick], [Display Info] is set to [Off] and cannot be changed.
- By pressing the [▼] button while an image is displayed after shooting, you can switch the display information. Note that the settings of [Display Info] are not changed. By pressing the [OK] button, you can do the following operations.
 - Protect (p. 72)
 - Favorites (p. 78)
 - Erase (p. 74)

Before Use

Basic Guide

Advanced Guide

Camera Basics

Auto Mode / Hybrid Auto Mode

Other Shooting Modes

P Mode

Playback Mode

Wi-Fi Functions

Setting Menu

Accessories

Appendix

Index



Other Shooting Modes

Shoot more effectively in various scenes, and take shots enhanced with unique image effects or captured using special functions



Enjoying a Variety of Images from Each Shot (Creative Shot)

► Still Images ► Movies

The camera determines the subject and shooting conditions, automatically applying special effects and recomposing the shot to emphasize the subject. Six still images are recorded for each shot. You can capture multiple still images with effects using camera-determined settings.



1 Enter [Creative Shot] mode.

- Set the mode switch to [Creative Shot].

2 Shoot.

- Press the shutter button all the way down. As you shoot, the shutter sound is played three times.
- After the six images are displayed in succession, they are displayed simultaneously for about two seconds.
- To keep the images displayed until you press the shutter button halfway, press the [Creative Shot] button. You can choose an image for full-screen display by pressing the [Up][Down][Left][Right] buttons, and then press the [Creative Shot] button.
- To return to the original display, press the [MENU] button.



- Shooting will take some time when the flash fires, but hold the camera steady until the shutter sound is played three times.
- The six images are managed together as a group (p.69).
- Simultaneous display of the six images as shown in step 2 is only available immediately after you shoot.

Before Use

Basic Guide

Advanced Guide

Camera Basics

Auto Mode /
Hybrid Auto Mode

Other Shooting Modes

P Mode

Playback Mode

Wi-Fi Functions

Setting Menu

Accessories

Appendix

Index



Image Display during Playback

The six images from each shot are managed together as a group, and only the first image in the series is displayed during playback. To indicate that the image is part of a group, [SET] is displayed in the upper left of the screen.



- If you erase a grouped image (📖74), all images in the group are also erased. Be careful when erasing images.



- Grouped images can be played back individually (📖69) and ungrouped (📖69).
- Protecting (📖72) a grouped image will protect all images in the group.
- Grouped images can be viewed individually when played back using Image Search (📖67) or Smart Shuffle (📖71). In this case, images are temporarily ungrouped.
- The following actions are not available for grouped images: magnifying (📖70), tagging as favorites (📖78), editing (📖79), printing (📖127), setting up individual image printing (📖131), or adding to a photobook (📖133). To do these things, either view grouped images individually (📖69) or cancel grouping (📖69) first.
- Simultaneous display as shown in step 2 is only available immediately after you shoot.

Choosing Effects

▶ Still Images ▶ Movies

You can choose effects for images captured in [📷] mode.

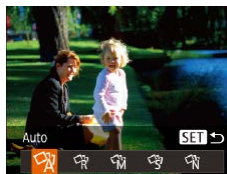

- After choosing [📷] mode, press the [▼] button.
- Press the [◀][▶] buttons to choose an effect, and then press the [📷] button.

📷 Auto	All effects
📷 Retro	Images resemble old photos
📷 Monochrome	Images are generated in one color
📷 Special	Bold, distinctive-looking images
📷 Natural	Subdued, natural-looking images

Before Use

Basic Guide

Advanced Guide

Camera Basics

Auto Mode /
Hybrid Auto Mode

Other Shooting Modes

P Mode

Playback Mode

Wi-Fi Functions

Setting Menu

Accessories

Appendix

Index



Specific Scenes

Choose a mode matching the shooting scene, and the camera will automatically configure the settings for optimal shots.



1 Enter [CAMERA] mode.

- Set the mode switch to [CAMERA].

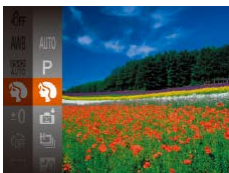

2 Choose a shooting mode.

- Press the [MENU] button, choose [AUTO] in the menu, and then choose a shooting mode (p.24).

3 Shoot.



Shooting Portraits (Portrait)

▶ Still Images ▶ Movies

- Take shots of people with a softening effect.

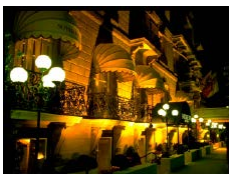

Shooting Evening Scenes without Using a Tripod (Handheld Night Scene)

▶ Still Images ▶ Movies

- Beautiful shots of evening scenes or portraits with evening scenery in the background, without the need to hold the camera very still (as with a tripod).



Shooting under Low Light (Low Light)

▶ Still Images ▶ Movies

- Shoot with minimal camera and subject shake even in low-light conditions.



Shooting Fireworks (Fireworks)

▶ Still Images ▶ Movies

- Vivid shots of fireworks.



- Subjects appear larger in [P] mode compared to other modes.
- In [P] mode, shots may look grainy because the ISO speed (p.55) is increased to suit the shooting conditions.
- Because the camera will shoot continuously in [P] mode, hold it steady while shooting.
- In [P] mode, excessive motion blur or certain shooting conditions may prevent you from obtaining the desired results.
- In [P] mode, mount the camera on a tripod or take other measures to keep it still and prevent camera shake. Additionally, you should set [IS Mode] to [Off] when using a tripod or other means to secure the camera (p.41).



- When you use a tripod for evening scenes, shooting in [AUTO] mode instead of [P] mode will give better results (p.28).
- [P] mode recording pixel setting is [M] (2592 x 1944) and cannot be changed.
- In [P] mode, although no frames are displayed when you press the shutter button halfway, optimal focus is still determined.

Before Use

Basic Guide

Advanced Guide

Camera Basics

Auto Mode / Hybrid Auto Mode

Other Shooting Modes

P Mode

Playback Mode

Wi-Fi Functions

Setting Menu

Accessories

Appendix

Index



Applying Special Effects

Add a variety of effects to images when shooting.



1 Choose a shooting mode.

- Follow steps 1 – 2 in “Specific Scenes” (46) to choose a shooting mode.

2 Shoot.

Shooting in Vivid Colors (Super Vivid)

► Still Images ► Movies

- Shots in rich, vivid colors.



Posterized Shots (Poster Effect)

► Still Images ► Movies

- Shots that resemble an old poster or illustration.



- In [📷] and [🎥] modes, try taking some test shots first, to make sure you obtain the desired results.

Shooting with a Fish-Eye Lens Effect (Fish-Eye Effect)

► Still Images ► Movies

Shoot with the distorting effect of a fish-eye lens.

1 Choose [📷].

- Follow steps 1 – 2 in “Specific Scenes” (46) and choose [📷].

2 Choose an effect level.

- Press the [▼] button, press the [◀][▶] buttons to choose an effect level, and then press the [📷] button.
- A preview is shown of how your shot will look with the effect applied.

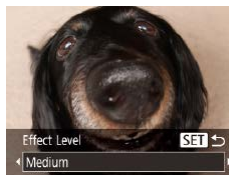

3 Shoot.



- Try taking some test shots first, to make sure you obtain the desired results.

Before Use

Basic Guide

Advanced Guide

Camera Basics

Auto Mode /
Hybrid Auto Mode

Other Shooting Modes

P Mode

Playback Mode

Wi-Fi Functions

Setting Menu

Accessories

Appendix

Index

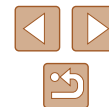

Shots Resembling Miniature Models (Miniature Effect)

► Still Images ► Movies

Creates the effect of a miniature model, by blurring image areas above and below your selected area.
You can also make movies that look like scenes in miniature models by choosing the playback speed before the movie is recorded. People and objects in the scene will move quickly during playback. Note that sound is not recorded.

1 Choose [ZOOM].

- Follow steps 1 – 2 in “Specific Scenes” (46) and choose [ZOOM].
- A white frame is displayed, indicating the image area that will not be blurred.



2 Choose the area to keep in focus.

- Press the [DOWN] button.
- Move the zoom lever to resize the frame, and press the [UP][DOWN] buttons to move it.



3 For movies, choose the movie playback speed.

- Press the [MENU] button, and then press the [LEFT][RIGHT] buttons to choose the speed.

4 Return to the shooting screen and shoot.

- Press the [MENU] button to return to the shooting screen, and then shoot.

Playback Speed and Estimated Playback Time (for One-Minute Clips)

Speed	Playback Time
5x	Approx. 12 sec.
10x	Approx. 6 sec.
20x	Approx. 3 sec.

Movies are played back at 30 fps.



- The zoom is not available when shooting movies. Be sure to set the zoom before shooting.
- Try taking some test shots first, to make sure you obtain the desired results.



- To switch the orientation of the frame to vertical, press the [LEFT][RIGHT] buttons in step 2. To return the frame to horizontal orientation, press the [UP][DOWN] buttons.
- To move the frame when it is in horizontal orientation, press the [UP][DOWN] buttons, and to move the frame when it is in vertical orientation, press the [LEFT][RIGHT] buttons.
- Holding the camera vertically will change the orientation of the frame.
- Movie image quality is [E-VGA] at an aspect ratio of [4:3] and [E-HD] at an aspect ratio of [16:9] (38). These quality settings cannot be changed.

Before Use

Basic Guide

Advanced Guide

Camera Basics

Auto Mode /
Hybrid Auto Mode

Other Shooting Modes

P Mode

Playback Mode

Wi-Fi Functions

Setting Menu

Accessories

Appendix

Index



Shooting with a Toy Camera Effect (Toy Camera Effect)

► Still Images ► Movies

This effect makes images resemble shots from a toy camera by vignetting (darker, blurred image corners) and changing the overall color.

1 Choose [📷].

- Follow steps 1 – 2 in “Specific Scenes” (📖46) and choose [📷].



2 Choose a color tone.

- Press the [▼] button, press the [◀][▶] buttons to choose a color tone, and then press the [📷] button.
- A preview is shown of how your shot will look with the effect applied.

3 Shoot.

Standard	Shots resemble toy camera images.
Warm	Images have a warmer tone than with [Standard].
Cool	Images have a cooler tone than with [Standard].



- Try taking some test shots first, to make sure you obtain the desired results.

Shooting in Monochrome

► Still Images ► Movies

Shoot images in black and white, sepia, or blue and white.

1 Choose [📷].

- Follow steps 1 – 2 in “Specific Scenes” (📖46) and choose [📷].



2 Choose a color tone.

- Press the [▼] button, press the [◀][▶] buttons to choose a color tone, and then press the [📷] button.
- A preview is shown of how your shot will look with the effect applied.

3 Shoot.

B/W	Black and white shots.
Sepia	Sepia tone shots.
Blue	Blue and white shots.

Before Use

Basic Guide

Advanced Guide

Camera Basics

Auto Mode /
Hybrid Auto Mode

Other Shooting Modes

P Mode

Playback Mode

Wi-Fi Functions

Setting Menu

Accessories

Appendix

Index



Special Modes for Other Purposes

Auto Shooting after Face Detection (Smart Shutter)

► Still Images ► Movies

Auto Shooting after Smile Detection (Smile)

The camera shoots automatically after detecting a smile, even without you pressing the shutter button.

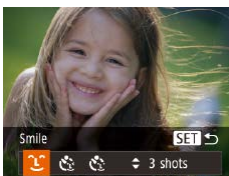

1 Choose [Smile].

- Follow steps 1 – 2 in “Specific Scenes” (46) and choose [Smile], and then press the [▼] button.
- Press the [◀][▶] buttons to choose [Smile], and then press the [OK] button.
- The camera now enters shooting standby mode, and [Smile Detection on] is displayed.



2 Aim the camera at a person.

- Each time the camera detects a smile, it will shoot after the lamp lights up.
- To pause smile detection, press the [M] button. Press the [M] button again to resume detection.



- Switch to another mode when you finish shooting, or the camera will continue shooting each time a smile is detected.



- You can also shoot as usual by pressing the shutter button.
- The camera can detect smiles more easily when subjects face the camera and open their mouth wide enough so that teeth are visible.
- To change the number of shots, press the [▲][▼] buttons after choosing [Smile] in step 1.

Auto Shooting after Wink Detection (Wink Self-Timer)

Aim the camera at a person and press the shutter button all the way down. The camera will shoot about two seconds after a wink is detected.



1 Choose [Wink].

- Follow steps 1 – 2 in “Specific Scenes” (46) and choose [Wink], and then press the [▼] button.
- Press the [◀][▶] buttons to choose [Wink], and then press the [OK] button.

2 Compose the shot and press the shutter button halfway.

- Make sure a green frame is displayed around the face of the person who will wink.

3 Press the shutter button all the way down.

- The camera now enters shooting standby mode, and [Wink to take picture] is displayed.
- The lamp blinks and the self-timer sound is played.

Before Use

Basic Guide

Advanced Guide

Camera Basics

Auto Mode / Hybrid Auto Mode

Other Shooting Modes

P Mode

Playback Mode

Wi-Fi Functions

Setting Menu

Accessories

Appendix

Index



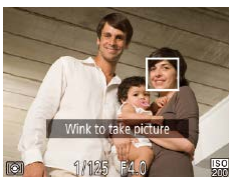

4 Face the camera and wink.

- The camera will shoot about two seconds after detecting a wink by the person whose face is inside the frame.
- To cancel shooting after you have triggered the self-timer, press the [MENU] button.



- If the wink is not detected, wink again slowly and deliberately.
- Winking may not be detected if eyes are obscured by hair, a hat, or glasses.
- Closing and opening both eyes at once will also be detected as a wink.
- If winking is not detected, the camera will shoot about 15 seconds later.
- To change the number of shots, press the [▲][▼] buttons after choosing [👤] in step 1.
- If no one is in the shooting area when the shutter button is pressed all the way down, the camera will shoot after a person enters the shooting area and winks.

Auto Shooting after Detecting New Person (Face Self-Timer)

The camera will shoot about two seconds after detecting that the face of another person (such as the photographer) has entered the shooting area (📖59). This is useful when including yourself in group photos or similar shots.



1 Choose [👤].

- Follow steps 1 – 2 in “Specific Scenes” (📖46) and choose [👤], and then press the [▼] button.
- Press the [◀][▶] buttons to choose [👤], and then press the [📷] button.



2 Compose the shot and press the shutter button halfway.

- Make sure a green frame is displayed around the face you focus on and white frames around other faces.

3 Press the shutter button all the way down.

- The camera now enters shooting standby mode, and [Look straight at camera to start count down] is displayed.
- The lamp blinks and the self-timer sound is played.

4 Join the subjects in the shooting area and look at the camera.

- After the camera detects a new face, the lamp blinking and self-timer sound will speed up. (When the flash fires, the lamp will remain lit.) About two seconds later, the camera will shoot.
- To cancel shooting after you have triggered the self-timer, press the [MENU] button.



- Even if your face is not detected after you join the others in the shooting area, the camera will shoot about 15 seconds later.
- To change the number of shots, press the [▲][▼] buttons after choosing [👤] in step 1.

Before Use
Basic Guide
Advanced Guide
Camera Basics
Auto Mode / Hybrid Auto Mode
Other Shooting Modes
P Mode
Playback Mode
Wi-Fi Functions
Setting Menu
Accessories
Appendix
Index



Shooting Long Exposures (Long Shutter)

► Still Images ► Movies

Specify a shutter speed of 1 – 15 seconds to shoot long exposures. In this case, mount the camera on a tripod or take other measures to prevent camera shake.

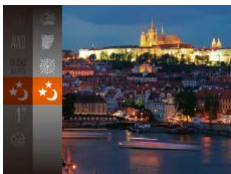

1 Choose [S].

- Follow steps 1 – 2 in “Specific Scenes” (📖46) and choose [S].

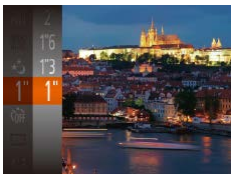

2 Choose the shutter speed.

- Press the [M] button, choose [1"] in the menu, and choose the desired shutter speed (📖24).

3 Check the exposure.

- Press the shutter button halfway to view the exposure for your selected shutter speed.

4 Shoot.



- On-screen image brightness in step 3, when you pressed the shutter button halfway, may not match the brightness of your shots.
- With shutter speeds of 1.3 seconds or slower, there will be a delay before you can shoot again, as the camera processes images to reduce noise.
- Set [IS Mode] to [Off] when using a tripod or other means to secure the camera (📖41).



- If the flash fires, your shot may be overexposed. In this case, set the flash to [🚫] and shoot again (📖62).

High-Speed Continuous Shooting (High-Speed Burst)

► Still Images ► Movies

You can shoot a series of shots in rapid succession by holding the shutter button all the way down. For details on the continuous shooting speed, see “Camera” (📖149).



1 Choose [C].

- Follow steps 1 – 2 in “Specific Scenes” (📖46) and choose [C].

2 Shoot.

- Hold the shutter button all the way down to shoot continuously.



- Recording pixel setting is [M] (2592 x 1944) and cannot be changed.
- Focus, image brightness, and color are determined by the first shot.
- Shooting may stop momentarily or continuous shooting may slow down depending on shooting conditions, camera settings, and the zoom position.
- As more shots are taken, shooting may slow down.

Before Use

Basic Guide

Advanced Guide

Camera Basics

Auto Mode /
Hybrid Auto Mode

Other Shooting Modes

P Mode

Playback Mode

Wi-Fi Functions

Setting Menu

Accessories

Appendix

Index



P Mode

More discerning shots, in your preferred shooting style



- Instructions in this chapter apply when the mode switch set to  and mode to **[P]**.
- **[P]**: Program AE; AE: Auto Exposure
- Before using a function introduced in this chapter in modes other than **[P]**, make sure the function is available in that mode (📖142).

Shooting in Program AE ([P] Mode)

► Still Images ► Movies

You can customize many function settings to suit your preferred shooting style.



1 Enter **[P]** mode.

- Follow steps 1 – 2 in “Specific Scenes” (📖46) and choose **[P]**.

2 Customize the settings as desired (📖54 – 📖63), and then shoot.



- If the optimum exposure cannot be obtained when you press the shutter button halfway, the shutter speed and aperture value are displayed in orange. In this case, try adjusting the ISO speed (📖55) or activating the flash (if subjects are dark, 📖62), which may enable optimum exposure.
- Movies can be recorded in **[P]** mode as well, by pressing the movie button. However, some FUNC. (📖24) and MENU (📖25) settings may be automatically adjusted for movie recording.

Before Use

Basic Guide

Advanced Guide

Camera Basics

Auto Mode /
Hybrid Auto Mode

Other Shooting Modes

P Mode

Playback Mode

Wi-Fi Functions

Setting Menu

Accessories

Appendix

Index

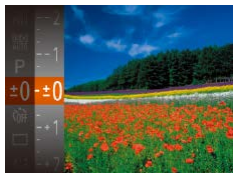

Image Brightness (Exposure)

Adjusting Image Brightness (Exposure Compensation)

► Still Images ► Movies

The standard exposure set by the camera can be adjusted in 1/3-stop increments, in a range of -2 to +2.



- Press the [AE-L/AF-ON] button and choose [AE-LOCK] in the menu. As you watch the screen, press the [▲] / [▼] buttons to adjust brightness (24).
- When shooting movies, shoot with the exposure compensation bar displayed.
- When shooting still images, press the [AE-L/AF-ON] button to display the set exposure compensation amount, and then shoot.



- You can also shoot still images with exposure compensation bar displayed.
- While recording a movie, [AE-L] is displayed, and the exposure is locked.

Changing the Metering Method

► Still Images ► Movies

Adjust the metering method (how brightness is measured) to suit shooting conditions as follows.

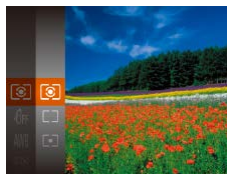

- Press the [METERING] button, choose [METERING] in the menu, and choose the desired option (24).
- The option you configured is now displayed.

Evaluative	For typical shooting conditions, including backlit shots. Automatically adjusts exposure to match the shooting conditions.
Center Weighted Avg.	Determines the average brightness of light across the entire image area, calculated by treating brightness in the central area as more important.
Spot	Metering restricted to within the [] (Spot AE Point frame), displayed in the center of the screen.

Before Use

Basic Guide

Advanced Guide

Camera Basics

Auto Mode /
Hybrid Auto Mode

Other Shooting Modes

P Mode

Playback Mode

Wi-Fi Functions

Setting Menu

Accessories

Appendix

Index

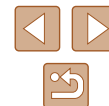

Changing the ISO Speed

► Still Images ► Movies

Set the ISO speed to [AUTO] for automatic adjustment to suit the shooting mode and conditions. Otherwise, set a higher ISO speed for higher sensitivity, or a lower value for lower sensitivity.

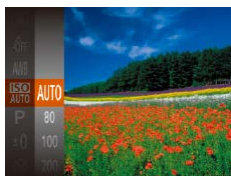

- Press the **[ISO]** button, choose **[ISO]** in the menu, and choose the desired option (📖24).
- The option you configured is now displayed.



- To view the automatically determined ISO speed when you have set the ISO speed to [AUTO], press the shutter button halfway.
- Although choosing a lower ISO speed may reduce image graininess, there may be a greater risk of subject and camera shake in some shooting conditions.
- The faster shutter speed used at higher ISO speeds reduces subject and camera shake and increases the flash range. However, shots may look grainy.

Correcting Image Brightness (i-Contrast)

► Still Images ► Movies

Before shooting, excessively bright or dark image areas (such as faces or backgrounds) can be detected and automatically adjusted to the optimal brightness. Insufficient overall image contrast can also be automatically corrected before shooting to make subjects stand out better.

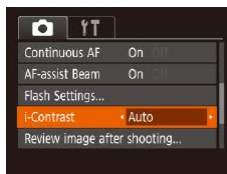

- Press the **[MENU]** button, choose **[i-Contrast]** on the **[CAMERA]** tab, and then choose **[Auto]** (📖25).
- Once the setting is complete, **[Ci]** is displayed.



- Under some shooting conditions, correction may be inaccurate or may cause images to appear grainy.



- You can also correct existing images (📖81).

Before Use

Basic Guide

Advanced Guide

Camera Basics

Auto Mode /
Hybrid Auto Mode

Other Shooting Modes

P Mode

Playback Mode

Wi-Fi Functions

Setting Menu

Accessories

Appendix

Index

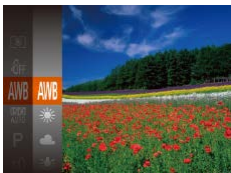

Image Colors

Adjusting White Balance

► Still Images ► Movies

By adjusting white balance (WB), you can make image colors look more natural for the scene you are shooting.



- Press the **[WB]** button, choose **[AWB]** in the menu, and choose the desired option (📖24).
- The option you configured is now displayed.

AWB Auto	Automatically sets the optimal white balance for the shooting conditions.
Day Light	For shooting outdoors in fair weather.
Cloudy	For shooting in cloudy weather or at twilight.
Tungsten	For shooting under ordinary incandescent lighting.
Fluorescent	For shooting under white fluorescent lighting.
Fluorescent H	For shooting under daylight fluorescent lighting.
Custom	For manually setting a custom white balance (📖56).

Custom White Balance

For image colors that look natural under the light in your shot, adjust white balance to suit the light source where you are shooting. Set the white balance under the same light source that will illuminate your shot.



- Follow the steps in “Adjusting White Balance” (📖56) to choose **[WB]**.
- Aim the camera at a plain white subject, so that the entire screen is white. Press the **[MENU]** button.
- The tint of the screen changes once the white balance data has been recorded.



- Colors may look unnatural if you change camera settings after recording white balance data.

Changing Image Color Tones (My Colors)

► Still Images ► Movies

Change image color tones as desired, such as converting images to sepia or black and white.

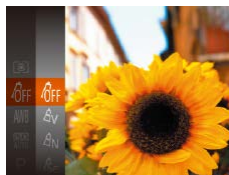

- Press the **[WB]** button, choose **[My Colors]** in the menu, and choose the desired option (📖24).
- The option you configured is now displayed.

Before Use

Basic Guide

Advanced Guide

Camera Basics

Auto Mode /
Hybrid Auto Mode

Other Shooting Modes

P Mode

Playback Mode

Wi-Fi Functions

Setting Menu

Accessories

Appendix

Index



My Colors Off	–
Vivid	Emphasizes contrast and color saturation, making images sharper.
Neutral	Tones down contrast and color saturation for subdued images.
Sepia	Creates sepia tone images.
B/W	Creates black and white images.
Positive Film	Combines the effects of Vivid Blue, Vivid Green, and Vivid Red to produce intense yet natural-looking colors resembling images on positive film.
Lighter Skin Tone	Lightens skin tones.
Darker Skin Tone	Darkens skin tones.
Vivid Blue	Emphasizes blues in images. Makes the sky, ocean, and other blue subjects more vivid.
Vivid Green	Emphasizes greens in images. Makes mountains, foliage, and other green subjects more vivid.
Vivid Red	Emphasizes reds in images. Makes red subjects more vivid.
Custom Color	Adjust contrast, sharpness, color saturation, and other qualities as desired (57).



- White balance (56) cannot be set in or modes.
- With and modes, colors other than people's skin tone may change. These settings may not produce the expected results with some skin tones.

Custom Color

Choose the desired level of image contrast, sharpness, color saturation, red, green, blue, and skin tones in a range of 1 – 5.

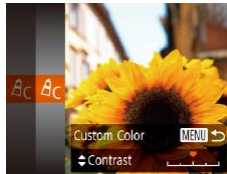

1 Access the setting screen.

- Follow the steps in “Changing Image Color Tones (My Colors)” (56) to choose , and then press the **[MENU]** button.

2 Configure the setting.

- Press the **[▲]**/**[▼]** buttons to choose an item, and then specify the value by pressing the **[◀]**/**[▶]** buttons.
- For stronger/more intense effects (or darker skin tones), adjust the value to the right, and for weaker/lighter effects (or lighter skin tones), adjust the value to the left.
- Press the **[MENU]** button to complete the setting.

Before Use
Basic Guide
Advanced Guide
Camera Basics
Auto Mode / Hybrid Auto Mode
Other Shooting Modes
P Mode
Playback Mode
Wi-Fi Functions
Setting Menu
Accessories
Appendix
Index



Shooting Range and Focusing

Shooting Close-Ups (Macro)

▶ Still Images ▶ Movies

To restrict the focus to subjects at close range, set the camera to [🌻]. For details on the range of focus, see “Shooting Range” (📖150).

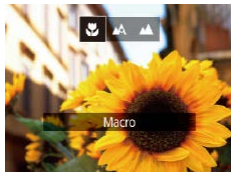

- Press the [◀] button, press the [◀][▶] buttons to choose [🌻], and then press the [⊞] button.
- Once the setting is complete, [🌻] is displayed.



- If the flash fires, vignetting may occur.
- In the yellow bar display area below the zoom bar, [🌻] will turn gray and the camera will not focus.



- To prevent camera shake, try mounting the camera on a tripod and shooting with the camera set to [📷] (📖36).

Shooting Distant Subjects (Infinity)

▶ Still Images ▶ Movies

To restrict the focus to distant subjects, set the camera to [∞]. For details on the range of focus, see “Shooting Range” (📖150).

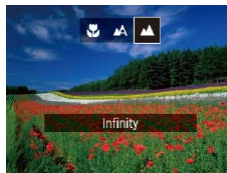

- Press the [◀] button, press the [◀][▶] buttons to choose [∞], and then press the [⊞] button.
- Once the setting is complete, [∞] is displayed.

Before Use

Basic Guide

Advanced Guide

Camera Basics

Auto Mode /
Hybrid Auto Mode

Other Shooting Modes

P Mode

Playback Mode

Wi-Fi Functions

Setting Menu

Accessories

Appendix

Index



Digital Tele-Converter

► Still Images ► Movies

The focal length of the lens can be increased by approximately 1.6x or 2.0x. This can reduce camera shake because the shutter speed is faster than it would be if you zoomed (including using digital zoom) in to the same zoom factor.

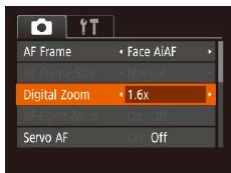

- Press the [MENU] button, choose [Digital Zoom] on the [CAMERA] tab, and then choose the desired option (📖25).
- The view is enlarged and the zoom factor is displayed on the screen.



- The digital tele-converter cannot be used with digital zoom (📖34) or AF-point zoom (📖40).



- The shutter speed may be equivalent when you move the zoom lever all the way toward [TELEPHOTO] for maximum telephoto, and when you zoom in to enlarge the subject to the same size following step 2 in "Zooming In Closer on Subjects (Digital Zoom)" (📖34).

Changing the AF Frame Mode

Change the AF (auto focus) frame mode to suit the shooting conditions as follows.



- Press the [MENU] button, choose [AF Frame] on the [CAMERA] tab, and then choose the desired option (📖25).

Face AiAF

► Still Images ► Movies

- Detects people's faces, and then sets the focus, exposure (evaluative metering only), and white balance ([WB] only).
- After you aim the camera at the subject, a white frame is displayed around the person's face determined by the camera to be the main subject, and up to two gray frames are displayed around other detected faces.
- When the camera detects movement, frames will follow moving subjects, within a certain range.
- After you press the shutter button halfway, up to nine green frames are displayed around faces in focus.

Before Use

Basic Guide

Advanced Guide

Camera Basics

Auto Mode /
Hybrid Auto Mode

Other Shooting Modes

P Mode

Playback Mode

Wi-Fi Functions

Setting Menu

Accessories

Appendix

Index

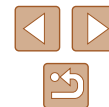



- If faces are not detected, or when only gray frames are displayed (without a white frame), up to nine green frames are displayed in the areas in focus when you press the shutter button halfway.
- If faces are not detected when Servo AF (61) is set to [On], the AF frame is displayed in the center of the screen when you press the shutter button halfway.
- Examples of faces that cannot be detected:
 - Subjects that are distant or extremely close
 - Subjects that are dark or light
 - Faces in profile, at an angle, or partly hidden
- The camera may misinterpret non-human subjects as faces.
- No AF frames are displayed if the camera cannot focus when you press the shutter button halfway.

Choosing Subjects to Focus On (Tracking AF)

► Still Images ► Movies

Shoot after choosing a subject to focus on as follows.

1 Choose [Tracking AF].

- Follow the steps in “Changing the AF Frame Mode” (59) to choose [Tracking AF].
- [AF-Tracking] is displayed in the center of the screen.



2 Choose a subject to focus on.

- Aim the camera so that [AF-Tracking] is on the desired subject, and then press the [AF-Tracking] button.

- When the subject is detected, the camera beeps and [AF-Tracking] is displayed. Even if the subject moves, the camera will continue to track the subject within a certain range.
- If no subject is detected, [AF-Tracking] is displayed.
- To cancel tracking, press the [AF-Tracking] button again.

3 Shoot.

- Press the shutter button halfway. [AF-Tracking] changes to a blue [AF-Tracking], which follows the subject as the camera continues to adjust the focus and exposure (Servo AF) (61).
- Press the shutter button all the way down to shoot.
- Even after your shot, [AF-Tracking] is still displayed and the camera continues to track the subject.



- [Servo AF] (61) is set to [On] and cannot be changed.
- Tracking may not be possible when subjects are too small or move too rapidly, or when subject color or brightness matches that of the background too closely.
- [AF-Point Zoom] on the [Camera] tab is not available.
- [AF-Tracking] and [AF-Tracking] are not available.



- The camera can detect subjects even if you press the shutter button halfway without pressing the [AF-Tracking] button. After your shot, [AF-Tracking] is displayed in the center of the screen.

Before Use
Basic Guide
Advanced Guide
Camera Basics
Auto Mode / Hybrid Auto Mode
Other Shooting Modes
P Mode
Playback Mode
Wi-Fi Functions
Setting Menu
Accessories
Appendix
Index



Center

▶ Still Images ▶ Movies

One AF frame is displayed in the center. Effective for reliable focusing.



- A yellow AF frame is displayed with if the camera cannot focus when you press the shutter button halfway.



- To reduce the AF frame size, press the [MENU] button and set [AF Frame Size] on the tab to [Small] (25).
- The AF frame size is set to [Normal] when you use the digital zoom (34) or digital tele-converter (59).
- To compose shots so that subjects are positioned at the edge or in a corner, first aim the camera to capture the subject in an AF frame, and then hold the shutter button halfway down. As you continue to hold the shutter button halfway, recompose the shot as desired, and then press the shutter button all the way down (Focus Lock).
- The AF frame position is enlarged when you press the shutter button halfway with [AF-Point Zoom] (40) set to [On].

Shooting with Servo AF

▶ Still Images ▶ Movies

This mode helps avoid missing shots of subjects in motion, because the camera continues to focus on the subject and adjust the exposure as long as you press the shutter button halfway.

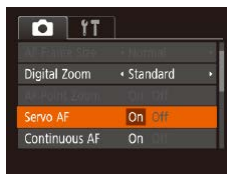

1 Configure the setting.

- Press the [MENU] button, choose [Servo AF] on the tab, and then choose [On] (25).

2 Focus.

- The focus and exposure are maintained where the blue AF frame is displayed while you are pressing the shutter button halfway.



- Focusing may not be possible in some shooting conditions.
- In low-light conditions, Servo AF may not be activated (AF frames may not turn blue) when you press the shutter button halfway. In this case, the focus and exposure are set according to the specified AF frame mode.
- If optimum exposure cannot be obtained, the shutter speed and aperture value are displayed in orange. Release the shutter button, and then press it halfway again.
- [AF-Point Zoom] on the tab (25) is not available.
- Not available when using the self-timer (36).

Before Use

Basic Guide

Advanced Guide

Camera Basics

Auto Mode /
Hybrid Auto Mode

Other Shooting Modes

P Mode

Playback Mode

Wi-Fi Functions

Setting Menu

Accessories

Appendix

Index



Changing the Focus Setting

► Still Images ► Movies

You can change default camera operation of constantly focusing on subjects it is aimed at, even when the shutter button is not pressed. Instead, you can limit camera focusing to the moment you press the shutter button halfway.



- Press the [MENU] button, choose [Continuous AF] on the [CAMERA] tab, and then choose [Off] (📖25).

On	Helps avoid missing sudden photo opportunities, because the camera constantly focuses on subjects until you press the shutter button halfway.
Off	Conserves battery power, because the camera does not focus constantly.

Flash

Changing the Flash Mode

► Still Images ► Movies

You can change the flash mode to match the shooting scene. For details on the flash range, see “Camera” (📖149).

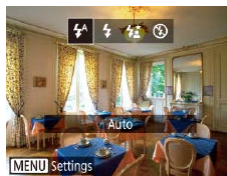

Configure the setting.

- Press the [▶] button, press the [◀][▶] buttons to choose a flash mode, and then press the [MENU] button.
- The option you configured is now displayed.

Auto

Fires automatically in low-light conditions.

On

Fires for each shot.

Slow Synchro

Fires to illuminate the main subject (such as people) while shooting at a slower shutter speed to illuminate backgrounds out of flash range.



- In [📷] mode, mount the camera on a tripod or take other measures to keep it still and prevent camera shake. Additionally, you should set [IS Mode] to [Off] when using a tripod or other means to secure the camera (📖41).
- In [📷] mode, even after the flash fires, ensure that the main subject does not move until the shutter sound is finished playing.

Before Use

Basic Guide

Advanced Guide

Camera Basics

Auto Mode /
Hybrid Auto Mode

Other Shooting Modes

P Mode

Playback Mode

Wi-Fi Functions

Setting Menu

Accessories

Appendix

Index



Off

For shooting without the flash.





- If a blinking  icon is displayed when you press the shutter button halfway in camera-shake inducing, low-light conditions, mount the camera on a tripod or take other measures to keep it still.



Other Settings

Changing the Compression Ratio (Image Quality)

► Still Images ► Movies

Choose from two compression ratios,  (Super Fine) and  (Fine), as follows. For guidelines on how many shots at each compression ratio can fit on a memory card, see “Number of Shots per Memory Card” (151).



- Press the  button, choose  in the menu, and choose the desired option (24).

Changing the IS Mode Settings

► Still Images ► Movies

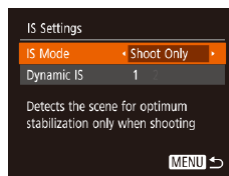

- Follow steps 1 – 2 in “Deactivating Image Stabilization” (41) and choose [Shoot Only].



- If image stabilization cannot prevent camera shake, mount the camera on a tripod or take other measures to hold it still. In this case, set [IS Mode] to [Off].
- The setting is changed to [Continuous] for movie recording.

Before Use

Basic Guide

Advanced Guide

Camera Basics

Auto Mode /
Hybrid Auto Mode

Other Shooting Modes

P Mode

Playback Mode

Wi-Fi Functions

Setting Menu

Accessories

Appendix

Index



Playback Mode

Have fun reviewing your shots, and browse or edit them in many ways

- To prepare the camera for these operations, press the [▶] button to enter Playback mode.



- It may not be possible to play back or edit images that were renamed or already edited on a computer, or images from other cameras.

Viewing

▶ Still Images ▶ Movies

After shooting images or movies, you can view them on the screen as follows.



1 Enter Playback mode.

- Press the [▶] button.
- Your last shot is displayed.



2 Choose images.

- To view the previous image, press the [◀] button. To view the next image, press the [▶] button.

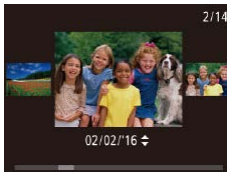

- To access this screen (Scroll Display mode), press and hold the [◀][▶] buttons for at least one second. In this mode, press the [◀][▶] buttons to browse through images.
- To return to single-image display, press the [◻] button.
- To browse images grouped by shooting date, press the [▲][▼] buttons in Scroll Display mode.

Before Use

Basic Guide

Advanced Guide

Camera Basics

Auto Mode /
Hybrid Auto Mode

Other Shooting Modes

P Mode

Playback Mode

Wi-Fi Functions

Setting Menu

Accessories

Appendix

Index

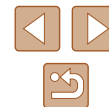



- Movies are identified by a [SET] icon. To play movies, go to step 3.

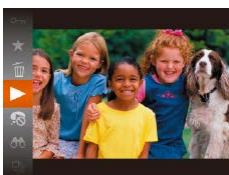

3 Play movies.

- To start playback, press the [Play] button, press the [Left]/[Right] buttons to choose [Next], and then press the [Play] button again.



(1)

4 Adjust the volume.

- Press the [Left]/[Right] buttons to adjust the volume.
- To adjust the volume when the volume indicator (1) is no longer displayed, press the [Left]/[Right] buttons.

5 Pause playback.

- To pause or resume playback, press the [Play/Pause] button.
- After the movie is finished, [SET] icon is displayed.



- To switch to Shooting mode from Playback mode, press the shutter button halfway.
- To deactivate Scroll Display, choose MENU (M) tab ► [Scroll Display] ► [Off].
- To have the most recent shot displayed when you enter Playback mode, choose MENU (M) ► [Resume] ► [Last shot].
- To change the transition shown between images, access MENU (M) and choose your desired effect on the [Transition] tab ► [Transition].

Switching Display Modes

► Still Images ► Movies

Press the [Down] button to view other information on the screen, or to hide the information. For details on the information displayed, see “Playback (Detailed Information Display)” (141).

	No Information Display
	Simple Information Display
	Detailed Information Display

- Before Use
- Basic Guide
- Advanced Guide
 - Camera Basics
 - Auto Mode / Hybrid Auto Mode
 - Other Shooting Modes
 - P Mode
 - Playback Mode
 - Wi-Fi Functions
 - Setting Menu
 - Accessories
 - Appendix
- Index



Overexposure Warning (for Image Highlights)

Washed-out highlights in the image flash on the screen in detailed information display (📖65).

Histogram

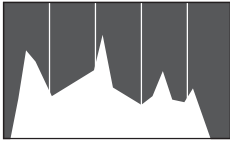

- The graph in detailed information display (📖65) is a histogram showing the distribution of brightness in the image. The horizontal axis represents the degree of brightness, and the vertical axis, how much of the image is at each level of brightness. Viewing the histogram is a way to check exposure.

GPS Information Display

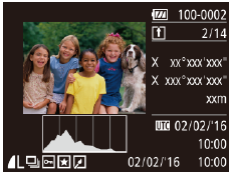

- Using a smartphone connected to the camera via Wi-Fi, you can geotag images on the camera, adding information such as latitude, longitude, and elevation (📖110). You can review this information in the GPS information display.
- Latitude, longitude, elevation, and UTC (shooting date and time) are listed from top to bottom.



- GPS information display is not available for images that lack this information.
- [---] is shown instead of numerical values for items not available on your smartphone or items not recorded correctly.



- UTC: Coordinated Universal Time, essentially the same as Greenwich Mean Time

Viewing Short Movies Created When Shooting Still Images (Digest Movies)

▶ Still Images ▶ Movies

View digest movies recorded automatically in [SET] mode (📖30) on a day of still image shooting as follows.



1 Choose an image.

- Still images shot in [SET] mode are labeled with [SET] icon.



2 Play the digest movie.

- Press the [⊙] button, and then choose [📺] in the menu (📖24).
- The digest movie recorded automatically on the day of still image shooting is played back from the beginning.



- After a moment, [SET] will no longer be displayed when you are using the camera with information display deactivated (📖65).

Before Use

Basic Guide

Advanced Guide

Camera Basics

Auto Mode /
Hybrid Auto Mode

Other Shooting Modes

P Mode

Playback Mode

Wi-Fi Functions

Setting Menu

Accessories

Appendix

Index



Viewing by Date

Digest movies can be viewed by date.

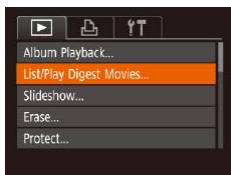

1 Choose a movie.

- Press the [MENU] button, choose [List/Play Digest Movies] on the [▶] tab, and then choose a date (📅25).

2 Play the movie.

- Press the [▶] button to start playback.

Browsing and Filtering Images

Navigating through Images in an Index

▶ Still Images ▶ Movies

By displaying multiple images in an index, you can quickly find the images you are looking for.



1 Display images in an index.

- Move the zoom lever toward [📐] to display images in an index. Moving the lever again will increase the number of images shown.
- To display fewer images, move the zoom lever toward [Q]. Fewer images are shown each time you move the lever.

2 Choose an image.

- Press the [▲][▼][◀][▶] buttons to choose an image.
- An orange frame is displayed around the selected image.
- Press the [Ⓜ] button to view the selected image in single-image display.



Before Use

Basic Guide

Advanced Guide

Camera Basics

Auto Mode /
Hybrid Auto Mode

Other Shooting Modes

P Mode

Playback Mode

Wi-Fi Functions

Setting Menu

Accessories

Appendix





Index



Finding Images Matching Specified Conditions

► Still Images ► Movies

Find desired images quickly on a memory card full of images by filtering image display according to your specified conditions. You can also protect (📖72) or delete (📖74) these images all at once.

 People	Displays images with detected faces.
 Shot Date	Displays the images shot on a specific date.
 Favorites	Displays images tagged as favorites (📖78).
 Still image/Movie	Displays still images, movies, or movies shot in [📷] mode (📖30).

1 Choose a search condition.

- Press the [🔍] button, choose [📷] in the menu, and choose a condition (📖24).
- When you have selected [🕒] or [👤], choose the condition by pressing the [▲][▼][◀][▶] buttons on the screen displayed, and then press the [🔍] button.

2 View the filtered images.

- Images matching your conditions are displayed in yellow frames. To view only these images, press the [◀][▶] buttons.
- To cancel filtered display, choose [📷] in step 1.



- When the camera has found no corresponding images for some conditions, those conditions will not be available.



- To show or hide information, press the [▼] button in step 2.
- Options for viewing the images found (in step 2) include “Navigating through Images in an Index” (📖67), “Magnifying Images” (📖70), and “Viewing Slideshows” (📖70). You can protect, erase, or print all images found or add them to a photobook by choosing [Select All Images in Search] in “Protecting Images” (📖72), “Erasing Multiple Images at Once” (📖75), “Adding Images to the Print List (DPOF)” (📖131), or “Adding Images to a Photobook” (📖133).
- If you edit images and save them as new images (📖79 – 📖83), a message is displayed, and the images that were found are no longer shown.

Before Use
Basic Guide
Advanced Guide
Camera Basics
Auto Mode / Hybrid Auto Mode
Other Shooting Modes
P Mode
Playback Mode
Wi-Fi Functions
Setting Menu
Accessories
Appendix
Index



Viewing Individual Images in a Group

► Still Images ► Movies

Images shot in [Z] or [L] mode (44, 52) are grouped for display, and these grouped images can be viewed one at a time.



1 Choose a grouped image.

- Press the [◀][▶] buttons to choose an image labeled with [SET].



2 Choose [SET].

- Press the [OK] button, and then choose [SET] in the menu (24).



3 View images in the group individually.

- Pressing the [◀][▶] buttons will display only images in the group.
- To cancel group playback, press the [OK] button, choose [SET] in the menu, and press the [OK] button again (24).



- During group playback (step 3), you can use the menu functions accessed by pressing the [OK] button. You can also browse through images quickly “Navigating through Images in an Index” (67) and magnify them “Magnifying Images” (70). By choosing [All Images in Group] for “Protecting Images” (72), “Erasing Multiple Images at Once” (75), “Adding Images to the Print List (DPOF)” (131), or “Adding Images to a Photobook” (133), all images in the group can be manipulated at once.
- To ungroup images so that they are displayed only as single still images, choose MENU (25) ► [▶] tab ► [Group Images] ► [Off] (25). However, grouped images cannot be ungrouped during individual playback.
- In [Z] mode, the simultaneous display after step 2 in “Enjoying a Variety of Images from Each Shot (Creative Shot)” (44) is only shown immediately after you shoot.

Before Use
Basic Guide
Advanced Guide
Camera Basics
Auto Mode / Hybrid Auto Mode
Other Shooting Modes
P Mode
Playback Mode
Wi-Fi Functions
Setting Menu
Accessories
Appendix
Index



Image Viewing Options

Magnifying Images

► Still Images ► Movies



1 Magnify an image.

- Moving the zoom lever toward [Q] will zoom in and magnify the image, and [SET] is displayed. You can magnify images up to about 10x by continuing to hold the zoom lever.
- The approximate position of the displayed area (1) is shown for reference.
- To zoom out, move the zoom lever toward [Q]. You can return to single-image display by continuing to hold it.

2 Move the display position and switch images as needed.

- To move the display position, press the [▲][▼][◀][▶] buttons.
- While [SET] is displayed, you can switch to [SET] by pressing the [⊕] button. To switch to other images while zoomed, press the [◀][▶] buttons. Press the [⊕] button again to restore the original setting.



- You can return to single-image display from magnified display by pressing the [MENU] button.

Viewing Slideshows

► Still Images ► Movies

Automatically play back images from a memory card as follows. Each image is displayed for about three seconds.



- Press the [⊕] button, choose [⊕] in the menu, and choose the desired option (24).
- The slideshow will start after [Loading image] is displayed for a few seconds.
- Press the [MENU] button to stop the slideshow.



- The camera's power-saving functions (23) are deactivated during slideshows.



- To pause or resume slideshows, press the [⊕] button.
- You can switch to other images during playback by pressing the [◀][▶] buttons. For fast-forward or fast-rewind, hold the [◀][▶] buttons down.
- In filtered display (68), only images matching search conditions are played.

Before Use

Basic Guide

Advanced Guide

Camera Basics

Auto Mode /
Hybrid Auto Mode

Other Shooting Modes

P Mode

Playback Mode

Wi-Fi Functions

Setting Menu

Accessories

Appendix

Index



Changing Slideshow Settings

You can set up slideshows to repeat, and you can change the transitions between images and the display duration of each image.

1 Access the setting screen.

- Press the [MENU] button, and then choose [Slideshow] on the [▶] tab (📖25).



2 Configure the setting.

- Choose a menu item to configure, and then choose the desired option (📖25).
- To start the slideshow with your settings, choose [Start] and press the [⏪] button.
- To return to the menu screen, press the [MENU] button.



- [Play Time] cannot be modified when [Bubble] is chosen in [Effect].

Auto Playback of Related Images (Smart Shuffle)

▶ Still Images ▶ Movies

Based on the current image, the camera offers four images that you may wish to view. After you choose to view one of those images, the camera offers four more images. This is an enjoyable way to play back images in an unexpected order. Try this feature after you have taken many shots, in many kinds of scenes.

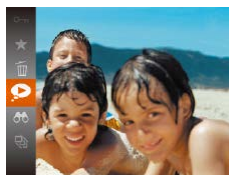

1 Choose Smart Shuffle.

- Press the [⏪] button, and then choose [▶] in the menu (📖24).
- Four candidate images are displayed.

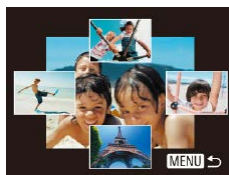

2 Choose an image.

- Press the [▲][▼][◀][▶] buttons to choose the image you want to view next.
- Your chosen image is displayed in the center, surrounded by the next four candidate images.
- For full-screen display of the center image, press the [⏪] button. To restore the original display, press the [⏪] button again.
- Press the [MENU] button to restore single-image display.



- Smart Shuffle is not available in the following cases:
 - There are less than 50 shots taken with this camera
 - An unsupported image is currently displayed
 - Images are shown in filtered display (📖68)
 - During group playback (📖69)

Before Use

Basic Guide

Advanced Guide

Camera Basics

Auto Mode /
Hybrid Auto Mode

Other Shooting Modes

P Mode

Playback Mode

Wi-Fi Functions

Setting Menu

Accessories

Appendix

Index



Protecting Images

► Still Images ► Movies

Protect important images to prevent accidental erasure (📖74).



- Press the [MENU] button, and then choose [Protect] in the menu (📖24). [Protected] is displayed.
- To cancel protection, repeat this process and choose [Protect] again, and then press the [MENU] button.



- Protected images on a memory card will be erased if you format the card (📖117).



- Protected images cannot be erased using the camera's erasure function. To erase them this way, first cancel protection.

Using the Menu

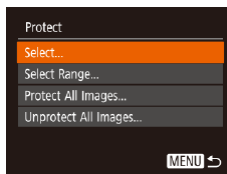
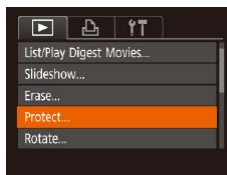

1 Access the setting screen.

- Press the [MENU] button and choose [Protect] on the [▶] tab (📖25).

2 Choose a selection method.

- Choose a menu item and an option as desired (📖25).
- To return to the menu screen, press the [MENU] button.

Before Use

Basic Guide

Advanced Guide

Camera Basics

Auto Mode /
Hybrid Auto Mode

Other Shooting Modes

P Mode

Playback Mode

Wi-Fi Functions

Setting Menu

Accessories

Appendix

Index

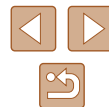







Choosing Images Individually

1 Choose [Select].



- Following step 2 in “Using the Menu” (p. 72), choose [Select] and press the  button.



2 Choose an image.

- Press the   buttons to choose an image, and then press the  button.  is displayed.
- To cancel selection, press the  button again.  is no longer displayed.
- Repeat this process to specify other images.

3 Protect the image.

- Press the  button. A confirmation message is displayed.
- Press the   buttons to choose [OK], and then press the  button.

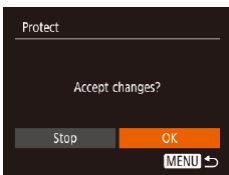

- Images will not be protected if you switch to Shooting mode or turn the camera off before finishing the setup process in step 3.

Selecting a Range

1 Choose [Select Range].

- Following step 2 in “Using the Menu” (p. 72), choose [Select Range] and press the  button.

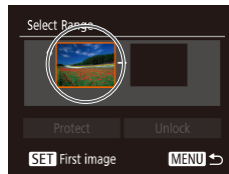

2 Choose a starting image.



- Press the  button.



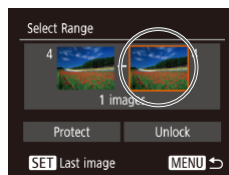



- Press the   buttons to choose an image, and then press the  button.

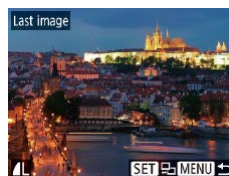

3 Choose an ending image.

- Press the  button to choose [Last image], and then press the  button.



- Press the   buttons to choose an image, and then press the  button.
- Images before the first image cannot be selected as the last image.

Before Use

Basic Guide

Advanced Guide

Camera Basics

Auto Mode /
Hybrid Auto Mode

Other Shooting Modes

P Mode

Playback Mode

Wi-Fi Functions

Setting Menu

Accessories

Appendix

Index





4 Protect the images.

- Press the [▼] button to choose [Protect], and then press the [Ⓜ] button.



- To cancel protection for groups of images, choose [Unlock] in step 4.

Protecting All Images at Once

1 Choose [Protect All Images].

- Following step 2 in “Using the Menu” (📖72), choose [Protect All Images] and press the [Ⓜ] button.

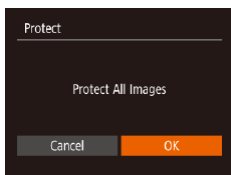

2 Protect the images.

- Press the [◀][▶] buttons to choose [OK], and then press the [Ⓜ] button.

Clearing All Protection at Once

You can clear protection from all images at once. To clear protection, choose [Unprotect All Images] in step 1 of “Protecting All Images at Once”, and then complete step 2.

Erasing Images

► Still Images ► Movies

You can choose and erase unneeded images one by one. Be careful when erasing images, because they cannot be recovered. However, protected images (📖72) cannot be erased.

1 Choose an image to erase.

- Press the [◀][▶] buttons to choose an image.

2 Erase the image.

- Press the [Ⓜ] button, and then choose [🗑] in the menu (📖24).
- After [Erase?] is displayed, press the [◀][▶] buttons to choose [Erase], and then press the [Ⓜ] button.
- The current image is now erased.
- To cancel erasure, press the [◀][▶] buttons to choose [Cancel], and then press the [Ⓜ] button.



Before Use
Basic Guide
Advanced Guide
Camera Basics
Auto Mode / Hybrid Auto Mode
Other Shooting Modes
P Mode
Playback Mode
Wi-Fi Functions
Setting Menu
Accessories
Appendix
Index



Erasing Multiple Images at Once

You can choose multiple images to erase at once. Be careful when erasing images, because they cannot be recovered. However, protected images (🔒72) cannot be erased.

Choosing a Selection Method

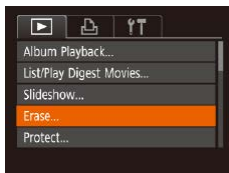

1 Access the setting screen.

- Press the [MENU] button, and then choose [Erase] on the [▶] tab (📖25).

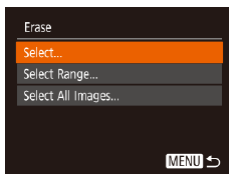

2 Choose a selection method.

- Choose a menu item and an option as desired (📖25).
- To return to the menu screen, press the [MENU] button.

Choosing Images Individually

1 Choose [Select].

- Following step 2 in “Choosing a Selection Method” (📖75), choose [Select] and press the [⊕] button.



2 Choose an image.

- Once you choose an image following step 2 in “Choosing Images Individually” (📖73), [✓] is displayed.
- To cancel selection, press the [⊕] button again. [✓] is no longer displayed.
- Repeat this process to specify other images.

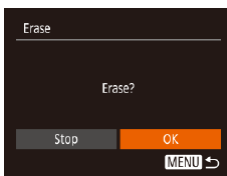

3 Erase the images.

- Press the [MENU] button. A confirmation message is displayed.
- Press the [◀][▶] buttons to choose [OK], and then press the [⊕] button.

Before Use

Basic Guide

Advanced Guide

Camera Basics

Auto Mode /
Hybrid Auto Mode

Other Shooting Modes

P Mode

Playback Mode

Wi-Fi Functions

Setting Menu

Accessories

Appendix

Index



Selecting a Range

1 Choose [Select Range].

- Following step 2 in “Choosing a Selection Method” (75), choose [Select Range] and press the  button.

2 Choose images.

- Follow steps 2 – 3 in “Selecting a Range” (73) to specify images.

3 Erase the images.

- Press the  button to choose [Erase], and then press the  button.

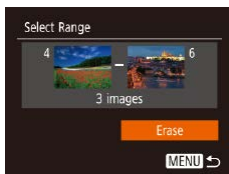

Specifying All Images at Once

1 Choose [Select All Images].

- Following step 2 in “Choosing a Selection Method” (75), choose [Select All Images] and press the  button.

2 Erase the images.

- Press the  buttons to choose [OK], and then press the  button.

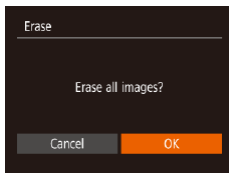

Rotating Images

► Still Images ► Movies

Change the orientation of images and save them as follows.

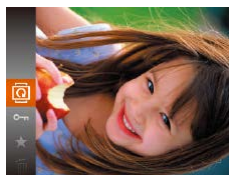



1 Choose .

- Press the  button, and then choose  in the menu (24).



2 Rotate the image.

- Press the  or  button, depending on the desired direction. Each time you press the button, the image is rotated 90°. Press the  button to complete the setting.

Before Use

Basic Guide

Advanced Guide

Camera Basics

Auto Mode /
Hybrid Auto Mode

Other Shooting Modes

P Mode

Playback Mode

Wi-Fi Functions

Setting Menu

Accessories

Appendix

Index

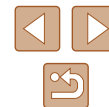

Using the Menu

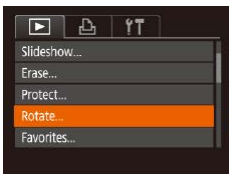

1 Choose [Rotate].

- Press the [MENU] button and choose [Rotate] on the [▶] tab (📖25).



2 Rotate the image.

- Press the [◀][▶] buttons to choose an image.
- The image is rotated 90° each time you press the [⌚] button.
- To return to the menu screen, press the [MENU] button.



- Rotation is not possible when [Auto Rotate] is set to [Off] (📖77).

Deactivating Auto Rotation

Follow these steps to deactivate automatic image rotation, which rotates images based on the current camera orientation.

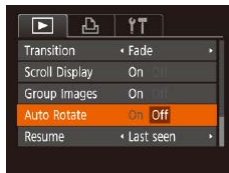

- Press the [MENU] button, choose [Auto Rotate] on the [▶] tab, and then choose [Off] (📖25).



- Images cannot be rotated (📖76) when you set [Auto Rotate] to [Off]. Additionally, images already rotated will be displayed in the original orientation.
- In Smart Shuffle (📖71) mode, even if [Auto Rotate] is set to [Off], images shot vertically will be displayed vertically, and rotated images will be displayed in the rotated orientation.

Before Use

Basic Guide

Advanced Guide

Camera Basics

Auto Mode /
Hybrid Auto Mode

Other Shooting Modes

P Mode

Playback Mode

Wi-Fi Functions

Setting Menu

Accessories

Appendix

Index

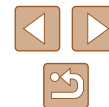

Tagging Images as Favorites

► Still Images ► Movies

You can organize images by tagging them as favorites. By choosing a category in filtered playback, you can restrict the following operations to all of those images.

- “Viewing” (📖64), “Viewing Slideshows” (📖70), “Protecting Images” (📖72), “Erasing Images” (📖74), “Adding Images to the Print List (DPOF)” (📖131), “Adding Images to a Photobook” (📖133)

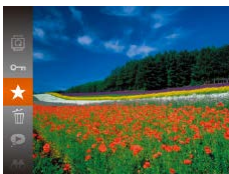

- Press the [Ⓜ] button, and then choose [★] in the menu (📖24).
- [Tagged as Favorite] is displayed.
- To untag the image, repeat this process and choose [★] again, and then press the [Ⓜ] button.

Using the Menu

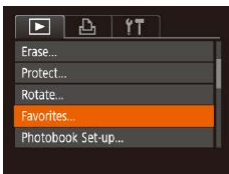

1 Choose [Favorites].

- Press the [MENU] button and choose [Favorites] on the [▶] tab (📖25).

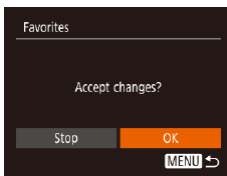

2 Choose an image.

- Press the [◀][▶] buttons to choose an image, and then press the [Ⓜ] button. [★] is displayed.
- To untag the image, press the [Ⓜ] button again. [★] is no longer displayed.
- Repeat this process to choose additional images.

3 Finish the setup process.

- Press the [MENU] button. A confirmation message is displayed.
- Press the [◀][▶] buttons to choose [OK], and then press the [Ⓜ] button.



- Images will not be tagged as favorites if you switch to Shooting mode or turn the camera off before finishing the setup process in step 3.

Before Use

Basic Guide

Advanced Guide

Camera Basics

Auto Mode /
Hybrid Auto Mode

Other Shooting Modes

P Mode

Playback Mode

Wi-Fi Functions

Setting Menu

Accessories

Appendix

Index

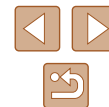

Editing Still Images

- Image editing (📖79 – 📖81) is only available when the memory card has sufficient free space.

Resizing Images

▶ Still Images ▶ Movies

Save a copy of images at a lower number of recording pixels.

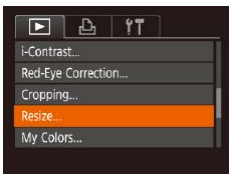

1 Choose [Resize].

- Press the [MENU] button and choose [Resize] on the [▶] tab (📖25).

2 Choose an image.

- Press the [◀][▶] buttons to choose an image, and then press the [Ⓜ] button.

3 Choose an image size.

- Press the [◀][▶] buttons to choose the size, and then press the [Ⓜ] button.
- [Save new image?] is displayed.

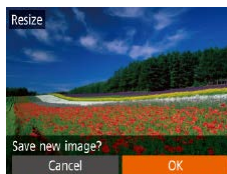

4 Save the new image.

- Press the [◀][▶] buttons to choose [OK], and then press the [Ⓜ] button.
- The image is now saved as a new file.

5 Review the new image.

- Press the [MENU] button. [Display new image?] is displayed.
- Press the [◀][▶] buttons to choose [Yes], and then press the [Ⓜ] button.
- The saved image is now displayed.

- Editing is not possible for images shot at a recording pixel setting of [S] (📖39).

- Images cannot be resized to a higher number of recording pixels.

Cropping

▶ Still Images ▶ Movies

You can specify a portion of an image to save as a separate image file.



1 Choose [Cropping].

- Press the [MENU] button, and then choose [Cropping] on the [▶] tab (📖25).

Before Use

Basic Guide

Advanced Guide

Camera Basics

Auto Mode / Hybrid Auto Mode

Other Shooting Modes

P Mode

Playback Mode

Wi-Fi Functions

Setting Menu

Accessories

Appendix

Index



2 Choose an image.

- Press the [◀][▶] buttons to choose an image, and then press the [Ⓜ] button.

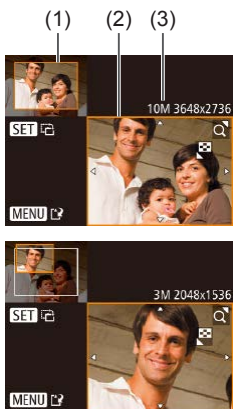

3 Adjust the cropping area.

- A frame is displayed around the portion of the image to be cropped (1).
- The original image is shown in the upper left, and a preview of the image as cropped (2) is shown in the lower right. You can also see the number of recording pixels after cropping (3).
- To resize the frame, move the zoom lever.
- To move the frame, press the [▲][▼][◀][▶] buttons.
- To change the frame orientation, press the [Ⓜ] button.
- Press the [MENU] button.

4 Save as a new image and review.

- Follow steps 4 – 5 in “Resizing Images” (📖79).



- Editing is not possible for images shot at a recording pixel setting of [S] (📖39) or resized to [S] (📖79).



- Images supported for cropping will have the same aspect ratio after cropping.
- Cropped images will have a lower number of recording pixels than uncropped images.

Changing Image Color Tones (My Colors)

▶ Still Images ▶ Movies

You can adjust image colors and then save the edited image as a separate file. For details on each option, see “Changing Image Color Tones (My Colors)” (📖56).

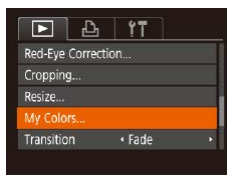

1 Choose [My Colors].

- Press the [MENU] button, and then choose [My Colors] on the [▶] tab (📖25).

2 Choose an image.

- Press the [◀][▶] buttons to choose an image, and then press the [Ⓜ] button.

3 Choose an option.

- Press the [◀][▶] buttons to choose an option, and then press the [Ⓜ] button.



4 Save as a new image and review.

- Follow steps 4 – 5 in “Resizing Images” (📖79).



- Image quality of pictures you repeatedly edit this way will be a little lower each time, and you may not be able to obtain the desired color.



- The color of images edited using this function may vary slightly from the color of images shot using My Colors (📖56).

Before Use

Basic Guide

Advanced Guide

Camera Basics

Auto Mode / Hybrid Auto Mode

Other Shooting Modes

P Mode

Playback Mode

Wi-Fi Functions

Setting Menu

Accessories

Appendix

Index



Correcting Image Brightness (i-Contrast)

► Still Images ► Movies

Excessively dark image areas (such as faces or backgrounds) can be detected and automatically adjusted to the optimal brightness. Insufficient overall image contrast is also automatically corrected, to make subjects stand out better. Choose from four correction levels, and then save the image as a separate file.

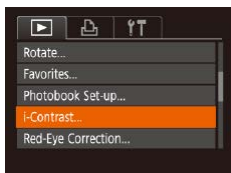

1 Choose [i-Contrast].

- Press the [MENU] button, and then choose [i-Contrast] on the [▶] tab (📖25).

2 Choose an image.

- Press the [◀][▶] buttons to choose an image, and then press the [⊕] button.

3 Choose an option.

- Press the [◀][▶] buttons to choose an option, and then press the [⊕] button.

4 Save as a new image and review.

- Follow steps 4 – 5 in “Resizing Images” (📖79).



- For some images, correction may be inaccurate or may cause images to appear grainy.
- Images may look grainy after repeated editing using this function.



- If [Auto] does not produce the expected results, try correcting images using [Low], [Medium], or [High].

Correcting Red-Eye

► Still Images ► Movies

Automatically corrects images affected by red-eye. You can save the corrected image as a separate file.

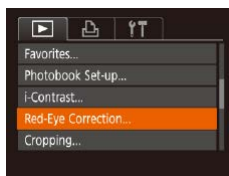

1 Choose [Red-Eye Correction].

- Press the [MENU] button, and then choose [Red-Eye Correction] on the [▶] tab (📖25).

2 Choose an image.

- Press the [◀][▶] buttons to choose an image.

3 Correct the image.

- Press the [⊕] button.
- Red-eye detected by the camera is now corrected, and frames are displayed around corrected image areas.
- Enlarge or reduce images as needed. Follow the steps in “Magnifying Images” (📖70).

Before Use

Basic Guide

Advanced Guide

Camera Basics

Auto Mode /
Hybrid Auto Mode

Other Shooting Modes

P Mode

Playback Mode

Wi-Fi Functions

Setting Menu

Accessories

Appendix

Index



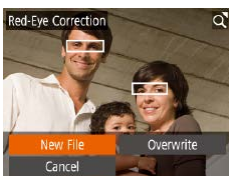

4 Save as a new image and review.

- Press the [▲][▼][◀][▶] buttons to choose [New File], and then press the [⊕] button.
- The image is now saved as a new file.
- Follow step 5 in “Resizing Images” (📖79).



- Some images may not be corrected accurately.
- To overwrite the original image with the corrected image, choose [Overwrite] in step 4. In this case, the original image will be erased.
- Protected images cannot be overwritten.

Editing Movies

▶ Still Images ▶ Movies

You can remove unneeded portions from the beginning and end of movies.



1 Choose [⊗].

- Following steps 1 – 5 in “Viewing” (📖64), choose [⊗] and press the [⊕] button.
- The movie editing panel and editing bar are now displayed.

(1)

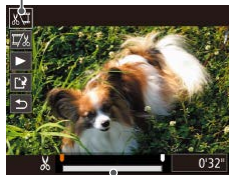

(2)

2 Specify portions to cut.

- (1) is the movie editing panel, and (2) is the editing bar.
- Press the [▲][▼] buttons to choose [⊗] or [⊗].
- To view the portions you can cut (identified by [⊗] on the screen), press the [◀][▶] buttons to move [⊗]. Cut the beginning of the movie (from [⊗]) by choosing [⊗], and cut the end of the movie by choosing [⊗].
- If you move [⊗] to a position other than a [⊗] mark, in [⊗] the portion before the nearest [⊗] mark on the left will be cut, while in [⊗] the portion after the nearest [⊗] mark on the right will be cut.

Before Use
Basic Guide
Advanced Guide
Camera Basics
Auto Mode / Hybrid Auto Mode
Other Shooting Modes
P Mode
Playback Mode
Wi-Fi Functions
Setting Menu
Accessories
Appendix
Index



3 Review the edited movie.

- Press the [▲][▼] buttons to choose [▶], and then press the [⏻] button. The edited movie is now played.
- To edit the movie again, repeat step 2.
- To cancel editing, press the [▲][▼] buttons to choose [↶]. Press the [⏻] button, press the [◀][▶] buttons to choose [OK], and then press the [⏻] button again.

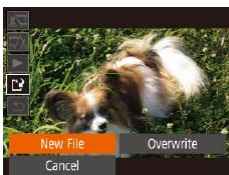

4 Save the edited movie.

- Press the [▲][▼] buttons to choose [↶], and then press the [⏻] button.
- Press the [▲][▼][◀][▶] buttons to choose [New File], and then press the [⏻] button.
- The movie is now saved as a new file.



- To overwrite the original movie with the cut one, choose [Overwrite] in step 4. In this case, the original movie will be erased.
- If the memory card lacks sufficient space, only [Overwrite] will be available.
- Movies may not be saved if the battery pack runs out while saving is in progress.
- When editing movies, you should use a fully charged battery pack.

Editing Digest Movies

▶ Still Images ▶ Movies

Individual chapters (clips) (📖30) recorded in [M] mode can be erased, as needed. Be careful when erasing clips, because they cannot be recovered.



1 Select the clip to erase.

- Follow steps 1 – 2 in “Viewing Short Movies Created When Shooting Still Images (Digest Movies)” (📖66) to play a movie created in [M] mode, and then press the [⏻] button to access the movie control panel.
- Press the [◀][▶] buttons to choose [◀] or [▶], and then press the [⏻] button.

2 Choose [🗑️].

- Press the [◀][▶] buttons to choose [🗑️], and then press the [⏻] button.
- The selected clip is played back repeatedly.

3 Confirm erasure.

- Press the [◀][▶] buttons to choose [OK], and then press the [⏻] button.
- The clip is erased, and the short movie is overwritten.

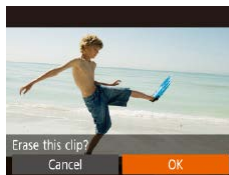

- [🗑️] is not displayed if you select a clip when the camera is connected to a printer.

Before Use

Basic Guide

Advanced Guide

Camera Basics

Auto Mode /
Hybrid Auto Mode

Other Shooting Modes

P Mode

Playback Mode

Wi-Fi Functions

Setting Menu

Accessories

Appendix

Index



Viewing Albums (Story Highlights)

► Still Images ► Movies

You can choose themes such as a date to create an album of automatically selected images that match the theme. These images are combined into a slideshow that can be saved as a short movie of about 2 – 3 minutes.

Before using this feature, make sure the battery pack is fully charged. Creating albums also requires free space on the memory card. As a guideline, use a memory card with a capacity of 16 GB or higher, and ensure at least 1 GB of free space.

Choosing Themes for Albums

Press the [▲] button to access the home screen and choose themes for the camera to use when selecting album elements. Note that the camera is more likely to add images tagged as favorites (📖78) to albums.

Date	Creates an album of images shot on the same day. Images are selected from those shot on the same day as the image displayed before you access the home screen.
Event	A good choice for albums of vacations, parties, or other events. Images are selected from those shot during the event before and after the image displayed before you access the home screen.
Custom	Includes images based on your specified image or shooting date.



1 Choose an image.

- Choose an image in single-image display.
- Themes available in step 3 will vary depending on image shooting date.

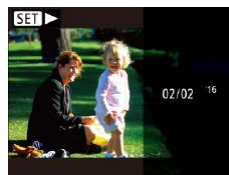
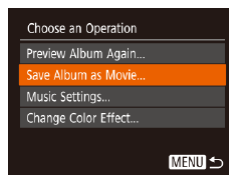
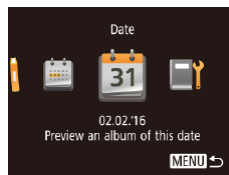

2 Access the home screen.

- Press the [▲] button.
- After [Busy] is displayed, the home screen is displayed.

3 Preview an album.

- Press the [◀][▶] buttons to choose [Date] or [Event] as the album theme, and then press the [📖] button.
- After [Loading] is displayed for a few seconds, the album is played.

4 Save the album.

- Press the [▲][▼] buttons to choose [Save Album as Movie], and then press the [📖] button.
- Once the album is saved, [Saved] is displayed.

5 Play the album (📖64).



- Albums can include following images captured by the camera.
 - Still images
 - Digest movies (📖30), except compressed movies

Before Use

Basic Guide

Advanced Guide

Camera Basics

Auto Mode / Hybrid Auto Mode

Other Shooting Modes

P Mode

Playback Mode

Wi-Fi Functions

Setting Menu

Accessories

Appendix

Index





- Albums cannot be saved unless there is enough space on the memory card.
- You can specify the color effect in step 4 by choosing [Change Color Effect] and pressing the [OK] button. To preview how the album looks with your selected effect applied, choose [Preview Album Again] on the screen in step 4 after pressing the [Left] [Right] buttons to choose a color effect and pressing the [OK] button.
- To play saved albums, choose [List of Albums] on the Story Highlights home screen, press the [OK] button, choose a listed album, and press the [OK] button again.

Adding Background Music to Albums

► Still Images ► Movies

Choose from three kinds of background music to play during album playback.

1 Create the album.

- Follow steps 1 – 3 in “Viewing Albums (Story Highlights)” (84) to create an album.

2 Configure background music settings.

- On the screen in step 4 of “Viewing Albums (Story Highlights)” (84), choose [Music Settings].
- Press the [Up] [Down] buttons to choose an item. Press the [OK] button, and then press the [Up] [Down] buttons to choose the desired option (25).

3 Save the album.

- Follow step 4 in “Viewing Albums (Story Highlights)” (84) to save albums.

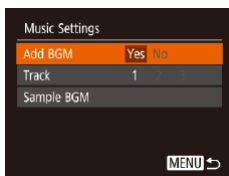

- Once albums are saved, background music cannot be added later. Background music in albums cannot be removed or changed.
- Chapters of albums with background music cannot be edited (83).
- Movie audio is not played if you add background music to the album.



- If you prefer not to add background music, set [Add BGM] to [No] on the screen in step 3.
- To listen to a sample of the background music selected in [Track], choose [Sample BGM] on the screen in step 3 and press the [OK] button.

Creating Your Own Albums

► Still Images ► Movies

Create your own albums by choosing desired images.

1 Choose to create a Custom album.

- Following steps 1 – 3 in “Viewing Albums (Story Highlights)” (84), choose [Custom] and press the [OK] button.

2 Choose a selection method.

- Choose [Image Selection] or [Date Selection], and then press the [OK] button.

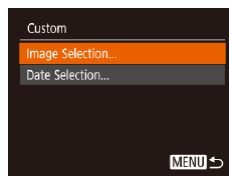

- Before Use
- Basic Guide
- Advanced Guide
 - Camera Basics
 - Auto Mode / Hybrid Auto Mode
 - Other Shooting Modes
 - P Mode
 - Playback Mode
 - Wi-Fi Functions
 - Setting Menu
 - Accessories
 - Appendix
- Index



3 Choose album elements.

- Once you select the elements for your album and press the [OK] button, your selected elements are labeled with [✓].
- Press the [MENU] button after you are finished selecting still images or digest movies in [Image Selection], or dates in [Date Selection].
- Press the [◀][▶] buttons to choose [Preview], and then press the [OK] button.

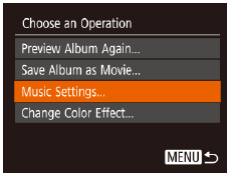

4 Choose background music.

- When the screen at left is displayed, choose [Music Settings]. Add background music as described in “Adding Background Music to Albums” (85), and then press the [MENU] button.



5 Choose a color effect.

- On the screen in step 4 of “Viewing Albums (Story Highlights)” (84), choose [Change Color Effect].
- Press the [◀][▶] buttons to choose a color effect, and then press the [OK] button.

6 Save the album.

- Follow step 4 in “Viewing Albums (Story Highlights)” (84) to save albums.



- Up to 40 files can be selected if you choose [Image Selection]. The second time you create a custom album, [Select images based on previous settings?] is displayed. To use previously selected images as the basis, choose [Yes]. The previous images are labeled with [✓], and multiple images are displayed at once.
- Up to 15 dates can be selected if you choose [Date Selection].
- The color effect may not be applied to some images.

Before Use
Basic Guide
Advanced Guide
Camera Basics
Auto Mode / Hybrid Auto Mode
Other Shooting Modes
P Mode
Playback Mode
Wi-Fi Functions
Setting Menu
Accessories
Appendix
Index

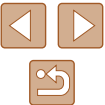

Wi-Fi Functions

Send images wirelessly from the camera to a variety of compatible devices, and use the camera with Web services



- Before using Wi-Fi, be sure to read “Wi-Fi (Wireless LAN) Precautions” (p.155).

Available Wi-Fi Features

You can send and receive images and control the camera remotely by connecting it to these devices and services via Wi-Fi.

- **Smartphones and Tablets**
Send images to smartphones and tablet computers that have Wi-Fi functions. You can also shoot remotely and geotag your shots from a smartphone or tablet.
For convenience in this manual, smartphones, tablets, and other compatible devices are collectively referred to as “smartphones”.
- **Computer**
Use software to save camera images to a computer connected via Wi-Fi.
- **Web Services**
Add your account information to the camera for CANON iMAGE GATEWAY online photography service or other Web services to send camera images to the services. Unsent images on the camera can also be sent to a computer or Web service via CANON iMAGE GATEWAY.
- **Printers**
Send images wirelessly to a PictBridge-compatible printer (supporting DPS over IP) to print them.
- **Another Camera**
Send images wirelessly between Wi-Fi-compatible Canon cameras.

- Before Use
- Basic Guide
- Advanced Guide
 - Camera Basics
 - Auto Mode / Hybrid Auto Mode
 - Other Shooting Modes
 - P Mode
 - Playback Mode
 - Wi-Fi Functions
 - Setting Menu
 - Accessories
 - Appendix
- Index

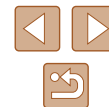

Sending Images to a Smartphone

There are several ways to connect the camera to a smartphone and send images.

- Connect via NFC (📖88)
Simply touch an NFC-compatible Android smartphone (OS version 4.0 or later) against the camera to connect the devices.
- Connect via the Wi-Fi menu (📖91)
You can connect the camera to a smartphone as you would connect it to a computer or other device. Multiple smartphones can be added.

Before connecting to the camera, you must install the free dedicated Camera Connect app on the smartphone. For details on this application (supported smartphones and included functions), refer to the Canon website.



- Canon Wi-Fi-compatible camera users who connect their camera to a smartphone via Wi-Fi should consider switching from the CameraWindow mobile app to the Camera Connect mobile app.

Sending Images to an NFC-Compatible Smartphone

Use an Android (OS version 4.0 or later) smartphone's NFC to simplify the process of installing Camera Connect and connecting to the camera. Operation when devices are initially connected via NFC varies depending on the camera mode when the devices are touched together.

- If the camera is off or in Shooting mode when the devices are touched together, you can choose and send images on the image selection screen. Once the devices are connected, you can also shoot remotely and geotag your shots (📖110). It's easy to reconnect to recent devices, which are listed in the Wi-Fi menu.
- If the camera is in Playback mode when the devices are touched together, you can choose and send images from the index display shown for image selection.

Follow the instructions in the following section for NFC-initiated connection to a camera that is off or in Shooting mode.

Connecting via NFC When Camera Is Off or in Shooting Mode

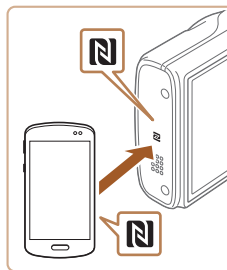

1 Install Camera Connect.

- Activate NFC on the smartphone and touch the devices' N-Marks (N) together to start Google Play on the smartphone automatically. Once the Camera Connect download page is displayed, download and install the app.

Before Use

Basic Guide

Advanced Guide

Camera Basics

Auto Mode /
Hybrid Auto Mode

Other Shooting Modes

P Mode

Playback Mode

Wi-Fi Functions

Setting Menu

Accessories

Appendix

Index



2 Establish the connection.

- Make sure the camera is off or in Shooting mode.
- Touch the N-Mark (N) on the smartphone with Camera Connect installed against the camera's N-Mark.
- The camera starts up automatically.
- If the [Device Nickname] screen is displayed, press the [▲][▼] buttons to choose [OK], and then press the [MENU] button.

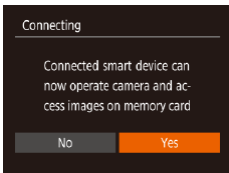
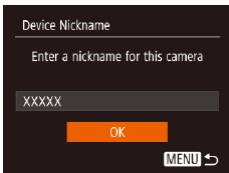

3 Adjust the privacy setting.

- After this screen is displayed, press the [◀][▶] buttons to choose [Yes], and then press the [MENU] button.
- You can now use the smartphone to browse, import, or geotag images on the camera or shoot remotely.



4 Send an image.

- Press the [▲][▼][◀][▶] buttons to choose [Select and send], and then press the [MENU] button.
- Press the [▲][▼] buttons to choose [Select], and then press the [MENU] button.
- Press the [▲][▼][◀][▶] buttons to choose an image to send, press the [MENU] button to mark it as selected ([✓]), and then press the [MENU] button.
- Press the [◀][▶] buttons to choose [OK], and then press the [MENU] button.
- Press the [▲][▼][◀][▶] buttons to choose [Send], and then press the [MENU] button.
- [Transfer completed] is displayed after the image is sent, and the image transfer screen is displayed again.
- To end the connection, press the [MENU] button, press the [◀][▶] buttons on the confirmation screen to choose [OK], and then press the [MENU] button. You can also use the smartphone to end the connection.

Before Use
Basic Guide
Advanced Guide
Camera Basics
Auto Mode / Hybrid Auto Mode
Other Shooting Modes
P Mode
Playback Mode
Wi-Fi Functions
Setting Menu
Accessories
Appendix
Index

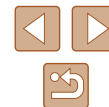



- When using NFC, keep the following points in mind.
 - Avoid strong impact between the camera and smartphone. This may damage the devices.
 - Depending on the smartphone, the devices may not recognize each other immediately. In this case, try holding the devices together in slightly different positions. If connection is not established, keep the devices together until the camera screen is updated.
 - If you attempt connection when the camera is off, a message may be displayed on the smartphone reminding you to turn on the camera. If so, turn the camera on and touch the devices together again.
 - Do not place other objects between the camera and smartphone. Also, note that camera or smartphone covers or similar accessories may block communication.
- All images in the camera can be viewed from the connected smartphone when you choose [Yes] in step 3. To keep camera images private, so that they cannot be viewed from the smartphone, choose [No] in step 3.
- Once you have registered a smartphone, you can change privacy settings for it on the camera (📖111).



- Connections require that a memory card be in the camera.
- You can also change the camera nickname on the screen in step 2 (📖89).
- Not all NFC-compatible smartphones have an N-Mark (N). For details, refer to the smartphone user manual.
- You can also send multiple images at once and change the image size before sending (📖105).
- You can send the current image by choosing [Send this image] on the screen in step 4.
- To disable NFC connections, choose MENU (📖25) ▶ [🔧] tab ▶ [Wireless settings] ▶ [Wi-Fi Settings] ▶ [NFC] ▶ [Off].

Connecting via NFC When Camera Is in Playback Mode



- Press the [▶] button to turn the camera on.
- Touch the smartphone with Camera Connect installed (📖88) against the camera's N-Mark (N).
- Press the [▲][▼][◀][▶] buttons to choose an image to send, and then press the [☑] button. [✓] is displayed.
- To cancel selection, press the [⊗] button again. [✓] is no longer displayed.
- Repeat this process to choose additional images.
- After you finish choosing images, press the [MENU] button.
- Press the [◀][▶] buttons to choose [OK], and then press the [☑] button.
- Press the [▲][▼][◀][▶] buttons to choose [Send], and then press the [☑] button.
- The images are now sent.



- If during connection a message on the camera requests you to enter the nickname, follow step 2 in "Sending Images to an NFC-Compatible Smartphone" (📖88) to enter it.
- The camera does not keep a record of smartphones you connect to via NFC in Playback mode.
- You can preset images to transfer at your desired size (📖105).

Before Use
Basic Guide
Advanced Guide
Camera Basics
Auto Mode / Hybrid Auto Mode
Other Shooting Modes
P Mode
Playback Mode
Wi-Fi Functions
Setting Menu
Accessories
Appendix
Index

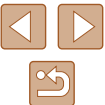

Adding a Smartphone

These steps show how to use the camera as an access point, but you can also use an existing access point (📖93).



1 Install Camera Connect.

- For an iPhone or iPad, find Camera Connect in the App Store and download and install the app.
- For Android smartphones, find Camera Connect in Google Play and download and install the app.

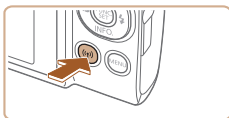

2 Access the Wi-Fi menu.

- Press the [(Wi-Fi)] button.
- If the [Device Nickname] screen is displayed, choose [OK].

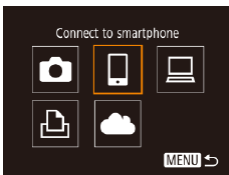

3 Choose [OK].

- Press the [▲][▼][◀][▶] buttons to choose [OK], and then press the [(Wi-Fi)] button.

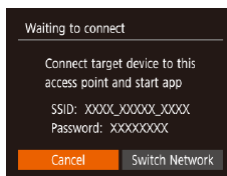
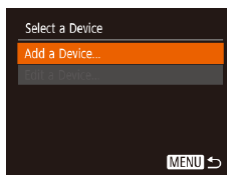

4 Choose [Add a Device].

- Press the [▲][▼] buttons to choose [Add a Device], and then press the [(Wi-Fi)] button.

- The camera SSID and password are displayed.

5 Connect the smartphone to the network.

- In the smartphone's Wi-Fi setting menu, choose the SSID (network name) displayed on the camera to establish a connection.
- In the password field, enter the password displayed on the camera.

6 Start Camera Connect.

- Start Camera Connect on the smartphone.

7 Select the camera to connect to.

- On the camera selection screen displayed on the smartphone, choose the camera to begin pairing.

Before Use
Basic Guide
Advanced Guide
Camera Basics
Auto Mode / Hybrid Auto Mode
Other Shooting Modes
P Mode
Playback Mode
Wi-Fi Functions
Setting Menu
Accessories
Appendix
Index

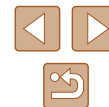

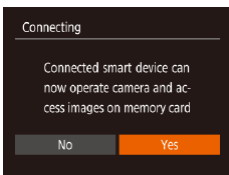

8 Adjust the privacy setting.

- Press the [◀][▶] buttons to choose [Yes], and then press the [OK] button.
- You can now use the smartphone to browse, import, or geotag images on the camera or shoot remotely.



9 Send an image.

- Press the [▲][▼][◀][▶] buttons to choose [Select and send], and then press the [OK] button.
- Press the [▲][▼] buttons to choose [Select], and then press the [OK] button.
- Press the [▲][▼][◀][▶] buttons to choose an image to send, press the [OK] button to mark it as selected ([✓]), and then press the [MENU] button.
- Press the [◀][▶] buttons to choose [OK], and then press the [OK] button.
- Press the [▲][▼][◀][▶] buttons to choose [Send], and then press the [OK] button.
- [Transfer completed] is displayed after the image is sent, and the image transfer screen is displayed again.
- To end the connection, press the [MENU] button, press the [◀][▶] buttons on the confirmation screen to choose [OK], and then press the [OK] button. You can also use the smartphone to end the connection.
- To add multiple smartphones, repeat the above procedure starting from step 1.



- All images in the camera can be viewed from the connected smartphone when you choose [Yes] in step 8. To keep camera images private, so that they cannot be viewed from the smartphone, choose [No] in step 8.
- Once you have registered a smartphone, you can change privacy settings for it on the camera (111).



- Connections require that a memory card be in the camera.
- Once you have connected to devices via the Wi-Fi menu, recent destinations will be listed first when you access the Wi-Fi menu. You can easily connect again by pressing the [▲][▼] buttons to choose the device and then pressing the [OK] button. To add a new device, display the device selection screen by pressing the [◀][▶] buttons, and then configure the setting.
- If you prefer not to display recent target devices, choose MENU (25) ▶ [↑] tab ▶ [Wireless settings] ▶ [Wi-Fi Settings] ▶ [Target History] ▶ [Off].
- To connect without entering a password in step 5, choose MENU (25) ▶ [↑] tab ▶ [Wireless settings] ▶ [Wi-Fi Settings] ▶ [Password] ▶ [Off]. [Password] is no longer displayed on the SSID screen (in step 4).
- You can also send multiple images at once and change the image size before sending (105).
- You can send the current image by choosing [Send this image] on the screen in step 9.

Before Use
Basic Guide
Advanced Guide
Camera Basics
Auto Mode / Hybrid Auto Mode
Other Shooting Modes
P Mode
Playback Mode
Wi-Fi Functions
Setting Menu
Accessories
Appendix
Index

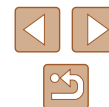

Using Another Access Point

When connecting the camera to a smartphone through the Wi-Fi menu, you can also use an existing access point.

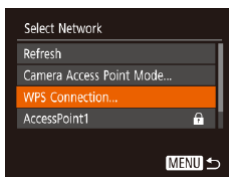
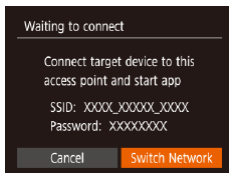

1 Prepare for the connection.

- Access the [Waiting to connect] screen by following steps 1 – 4 in “Adding a Smartphone” (91).

2 Connect the smartphone to the access point.

3 Choose [Switch Network].

- Press the [◀][▶] buttons to choose [Switch Network], and then press the [⊕] button.
- A list of detected access points will be displayed.

4 Connect to the access point.

- For WPS-compatible access points, connect to the access point as described in steps 5 – 8 in “Using WPS-Compatible Access Points” (96).
- For non-WPS access points, follow steps 2 – 4 in “Connecting to Listed Access Points” (98) to connect to the access point.



5 Select the camera to connect to.

- On the camera selection screen displayed on the smartphone, choose the camera to begin pairing.

6 Configure the privacy settings and send images.

- Follow steps 8 – 9 in “Adding a Smartphone” (91) to configure the privacy settings and send images.

Previous Access Points

You can reconnect to any previous access points automatically by following step 4 in “Adding a Smartphone” (91).

- To use the camera as an access point, choose [Switch Network] on the screen displayed when you establish a connection, and then choose [Camera Access Point Mode].
- To switch access points, choose [Switch Network] on the screen displayed when you establish a connection, and then follow the procedure in “Using Another Access Point” (93) from step 4.

Before Use
Basic Guide
Advanced Guide
Camera Basics
Auto Mode / Hybrid Auto Mode
Other Shooting Modes
P Mode
Playback Mode
Wi-Fi Functions
Setting Menu
Accessories
Appendix
Index



Saving Images to a Computer

Preparing to Register a Computer

For details on computers that you can connect the camera to via Wi-Fi, system requirements, and other compatibility information (including support in new operating systems), visit the Canon website.



- Windows 7 Starter and Home Basic editions are not supported.
- Windows 7 N (European version) and KN (South Korean version) require a separate download and installation of Windows Media Feature Pack.

For details, check the following website.

<http://go.microsoft.com/fwlink/?LinkId=159730>

Installing the Software

Windows 7 and Mac OS X 10.8 are used here for the sake of illustration.

1 Download the software.

- With a computer connected to the Internet, access <http://www.canon.com/icpd/>.
- Access the site for your country or region.
- Download the software.



2 Install the software.

- Click [Easy Installation] and follow the on-screen instructions to complete the installation process.
- Installation may take some time, depending on computer performance and the Internet connection.
- Click [Finish] or [Restart] on the screen after installation.



- Internet access is required, and any ISP account charges and access fees must be paid separately.



- To uninstall the software, follow these steps.
 - Windows: Select [Start] menu ► [All Programs] ► [Canon Utilities], and then choose the software for uninstallation.
 - Mac OS: In the [Canon Utilities] folder within the [Applications] folder, drag the folder of the software for uninstallation to the Trash, and then empty the Trash.

Before Use

Basic Guide

Advanced Guide

Camera Basics

Auto Mode /
Hybrid Auto Mode

Other Shooting Modes

P Mode

Playback Mode

Wi-Fi Functions

Setting Menu

Accessories

Appendix

Index



■ Configuring the Computer for a Wi-Fi Connection (Windows Only)

On a computer running Windows, configure the following settings before connecting the camera to the computer wirelessly.



1 Confirm that the computer is connected to an access point.

- For instructions on checking your network connection, refer to the computer user manual.

2 Configure the setting.

- Click in the following order: [Start] menu ► [All Programs] ► [Canon Utilities] ► [CameraWindow] ► [Wi-Fi connection setup].
- In the application that opens, follow the on-screen instructions and configure the setting.



- The following Windows settings are configured when you run the utility in step 2.
 - Turn on media streaming.
This will enable the camera to see (find) the computer to access via Wi-Fi.
 - Turn on network discovery.
This will enable the computer to see (find) the camera.
 - Turn on ICMP (Internet Control Message Protocol).
This allows you to check the network connection status.
 - Enable Universal Plug & Play (UPnP).
This will enable network devices to detect each other automatically.
- Some security software may prevent you from completing the settings as described here. Check the settings of your security software.

Saving Images to a Connected Computer

Connect to your access point via Wi-Fi as follows.
Also refer to the access point user manual.

■ Confirming Access Point Compatibility

Confirm that the Wi-Fi router or base station conforms to the Wi-Fi standards in “Camera” (📖 149).
Connection methods vary depending on whether the access point supports Wi-Fi Protected Setup (WPS, 📖 96) or not (📖 98). For non-WPS access points, check the following information.

- Network name (SSID/ESSID)
The SSID or ESSID for the access point you use. Also called the “access point name” or “network name”.
- Network authentication / data encryption (encryption method / encryption mode)
The method for encrypting data during wireless transmission. Check which security setting is used: WPA2-PSK (AES), WPA2-PSK (TKIP), WPA-PSK (AES), WPA-PSK (TKIP), WEP (open system authentication), or no security.
- Password (encryption key / network key)
The key used when encrypting data during wireless transmission. Also called the “encryption key” or “network key”.
- Key index (transmit key)
The key set when WEP is used for network authentication / data encryption. Use “1” as the setting.



- If system administrator status is needed to adjust network settings, contact the system administrator for details.
- These settings are very important for network security. Exercise adequate caution when changing these settings.

Before Use

Basic Guide

Advanced Guide

Camera Basics

Auto Mode / Hybrid Auto Mode

Other Shooting Modes

P Mode

Playback Mode

Wi-Fi Functions

Setting Menu

Accessories

Appendix

Index





- For information on WPS compatibility and for instructions on checking settings, refer to the access point user manual.
- A router is a device that creates a network (LAN) structure for connecting multiple computers. A router that contains an internal Wi-Fi function is called a “Wi-Fi router”.
- This guide refers to all Wi-Fi routers and base stations as “access points”.
- If you use MAC address filtering on your Wi-Fi network, be sure to add the camera’s MAC address to your access point. You can check your camera’s MAC address by choosing MENU (p.25) ► [F1] tab ► [Wireless settings] ► [Wi-Fi Settings] ► [Check MAC Address].

Using WPS-Compatible Access Points

WPS makes it easy to complete settings when connecting devices over Wi-Fi. You can use either Push Button Configuration Method or PIN Method for settings on a WPS supported device.

1 Confirm that the computer is connected to an access point.

- For instructions on checking the connection, refer to the device and access point user manuals.

2 Access the Wi-Fi menu.

- Press the [WPS] button.

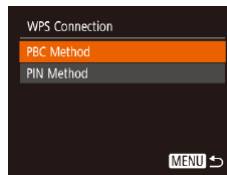
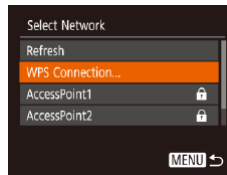
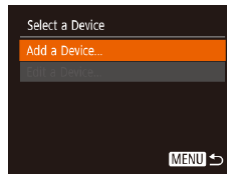
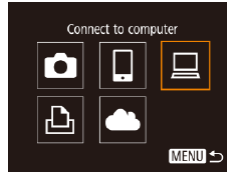
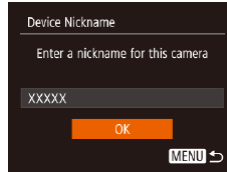
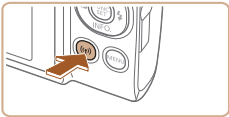

- If the [Device Nickname] screen is displayed, press the [▲][▼] buttons to choose [OK], and then press the [WPS] button.

3 Choose [Laptop].

- Press the [▲][▼][◀][▶] buttons to choose [Laptop], and then press the [WPS] button.

4 Choose [Add a Device].

- Press the [▲][▼] buttons to choose [Add a Device], and then press the [WPS] button.

5 Choose [WPS Connection].

- Press the [▲][▼] buttons to choose [WPS Connection], and then press the [WPS] button.

6 Choose [PBC Method].

- Press the [▲][▼] buttons to choose [PBC Method], and then press the [WPS] button.

Before Use
Basic Guide
Advanced Guide
Camera Basics
Auto Mode / Hybrid Auto Mode
Other Shooting Modes
P Mode
Playback Mode
Wi-Fi Functions
Setting Menu
Accessories
Appendix
Index

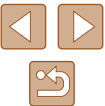

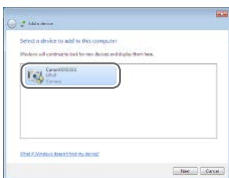
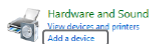
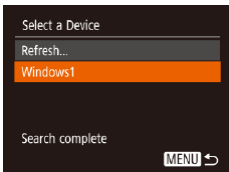
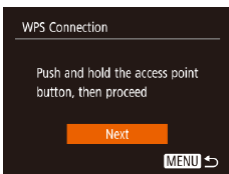

7 Establish the connection.

- On the access point, hold down the WPS connection button for a few seconds.
- On the camera, press the button to go to the next step.
- The camera connects to the access point and lists devices connected to it on the [Select a Device] screen.

8 Choose the target device.

- Press the buttons to choose the target device name, and then press the button.

9 Install a driver (first Windows connection only).

- When this screen is displayed on the camera, click the Start menu on the computer, click [Control Panel], and then click [Add a device].
- Double-click the connected camera icon.
- Driver installation will begin.
- After driver installation is complete, and the camera and computer connection is enabled, the AutoPlay screen will be displayed. Nothing will be displayed on the camera screen.

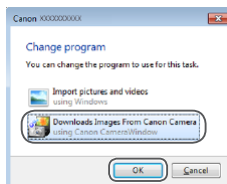

10 Display CameraWindow.

- Windows: Access CameraWindow by clicking [Downloads Images From Canon Camera].
- Mac OS: CameraWindow is automatically displayed when a Wi-Fi connection is established between the camera and computer.

11 Import images.

- Click [Import Images from Camera], and then click [Import Untransferred Images].
- Images are now saved to the Pictures folder on the computer, in separate folders named by date.
- Click [OK] in the screen that is displayed after image import is complete.
- To view images you save to a computer, use preinstalled or commonly available software compatible with images captured by the camera.

Before Use
Basic Guide
Advanced Guide
Camera Basics
Auto Mode / Hybrid Auto Mode
Other Shooting Modes
P Mode
Playback Mode
Wi-Fi Functions
Setting Menu
Accessories
Appendix
Index

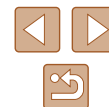



- Once you have connected to devices via the Wi-Fi menu, recent destinations will be listed first when you access the Wi-Fi menu. You can easily connect again by pressing the [▲][▼] buttons to choose the device and then pressing the [ⓘ] button. To add a new device, display the device selection screen by pressing the [◀][▶] buttons, and then configure the setting.
- If you prefer not to display recent target devices, choose MENU (📖25) ▶ [Y] tab ▶ [Wireless settings] ▶ [Wi-Fi Settings] ▶ [Target History] ▶ [Off].
- You can also change the camera nickname on the screen in step 2 (📖96).
- When the camera is connected to a computer, the camera screen is blank.
- Mac OS: If CameraWindow is not displayed, click the [CameraWindow] icon in the Dock.
- To disconnect from the camera, turn off the camera.
- If you chose [PIN Method] in step 6, a PIN code will be displayed on the screen. Be sure to set this code in the access point. Choose a device in the [Select a Device] screen. For further details, refer to the user manual included with your access point.

Connecting to Listed Access Points

1 View the listed access points.

- View the listed networks (access points) as described in steps 1 – 4 of “Using WPS-Compatible Access Points” (📖96).

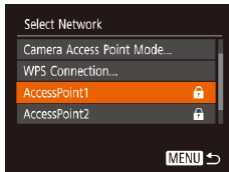

2 Choose an access point.

- Press the [▲][▼] buttons to choose a network (access point), and then press the [ⓘ] button.

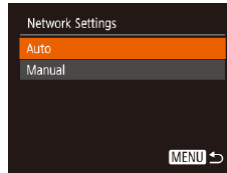
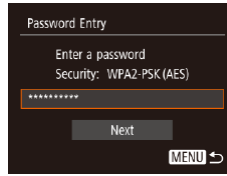

- To determine the access point password, check on the access point itself or refer to the user manual.
- If no access points are detected even after you choose [Refresh] in step 2 to update the list, choose [Manual Settings] in step 2 to complete access point settings manually. Follow on-screen instructions and enter an SSID, security settings, and a password.
- When you use an access point that you have already connected to for connecting to another device, [*] is displayed for the password in step 3. To use the same password, press the [▲][▼] buttons to choose [Next], and then press the [ⓘ] button.

3 Enter the access point password.

- Press the [ⓘ] button to access the keyboard, and then enter the password (📖26).
- Press the [▲][▼] buttons to choose [Next], and then press the [ⓘ] button.

4 Choose [Auto].

- Press the [▲][▼] buttons to choose [Auto], and then press the [ⓘ] button.
- To save images to a connected computer, follow the procedure from step 8 in “Using WPS-Compatible Access Points” (📖96).

Before Use

Basic Guide

Advanced Guide

Camera Basics

Auto Mode /
Hybrid Auto Mode

Other Shooting Modes

P Mode

Playback Mode

Wi-Fi Functions

Setting Menu

Accessories

Appendix

Index



Previous Access Points

You can reconnect to any previous access points automatically by following step 4 in “Using WPS-Compatible Access Points” (📖96).

- To connect to a device via an access point, confirm that the target device is already connected to the access point, and then follow the procedure from step 8 in “Using WPS-Compatible Access Points” (📖96).
- To switch access points, choose [Switch Network] on the screen displayed when you establish a connection, and then either follow the procedure in “Using WPS-Compatible Access Points” (📖96) from step 5 or the procedure in “Connecting to Listed Access Points” (📖98) from step 2.

Sending Images to a Registered Web Service

Registering Web Services

Use a smartphone or computer to add to the camera Web services that you want to use.

- A smartphone or computer with a browser and Internet connection is required to complete camera settings for CANON iMAGE GATEWAY and other Web services.
- Check the CANON iMAGE GATEWAY website for details on browser (Microsoft Internet Explorer, etc.) requirements, including settings and version information.
- For information on countries and regions where CANON iMAGE GATEWAY is available, visit the Canon website (<http://www.canon.com/cig/>).
- You must have an account with Web services other than CANON iMAGE GATEWAY if you desire to use them. For further details, check the websites for each Web service you want to register.
- Separate ISP connection and access point fees may be applicable.



- CANON iMAGE GATEWAY also provides user guides for downloading.

Before Use

Basic Guide

Advanced Guide

Camera Basics

Auto Mode /
Hybrid Auto Mode

Other Shooting Modes

P Mode

Playback Mode

Wi-Fi Functions

Setting Menu

Accessories

Appendix

Index



Registering CANON iMAGE GATEWAY

Link the camera and CANON iMAGE GATEWAY by adding CANON iMAGE GATEWAY as a destination Web service on the camera. Note that you will need to enter an email address used on your computer or smartphone to receive a notification message for completing linkage settings.

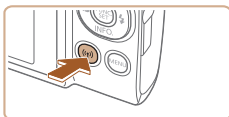

1 Access the Wi-Fi menu.

- Press the **[Wi-Fi]** button.
- If the [Device Nickname] screen is displayed, press the **[▲]**/**[▼]** buttons to choose [OK], and then press the **[☑]** button.

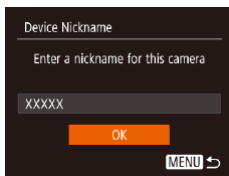

2 Choose [Cloud].

- Press the **[▲]**/**[▼]**/**[◀]**/**[▶]** buttons to choose **[Cloud]**, and then press the **[☑]** button.

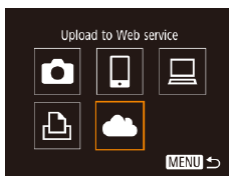

3 Accept the agreement to enter an email address.

- Read the agreement displayed, press the **[◀]**/**[▶]** buttons to choose [I Agree], and then press the **[☑]** button.

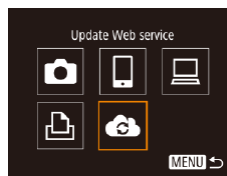
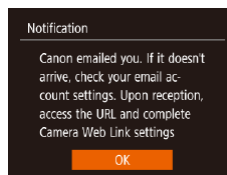
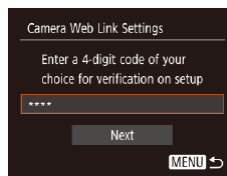
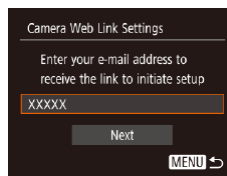
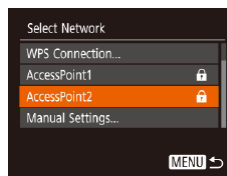
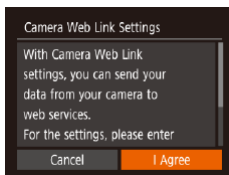

4 Establish a connection with an access point.

- Connect to the access point as described in steps 5 – 7 in “Using WPS-Compatible Access Points” (p.96) or in steps 2 – 4 in “Connecting to Listed Access Points” (p.98).

5 Enter your email address.

- Once the camera is connected to CANON iMAGE GATEWAY via the access point, a screen is displayed for entering an email address.
- Enter your email address, press the **[▲]**/**[▼]** buttons to choose [Next], and then press the **[☑]** button.

6 Enter a four-digit number.

- Enter a four-digit number of your choice, press the **[▲]**/**[▼]** buttons to choose [Next], and then press the **[☑]** button.
- You will need this four-digit number later when setting up linkage with CANON iMAGE GATEWAY in step 8.

7 Check for the notification message.

- Once information has been sent to CANON iMAGE GATEWAY, you will receive a notification message at the email address entered in step 5.
- Press the **[☑]** button on the next screen, which indicates that notification has been sent.
- **[Cloud]** now changes to **[Cloud with checkmark]**.

Before Use
Basic Guide
Advanced Guide
Camera Basics
Auto Mode / Hybrid Auto Mode
Other Shooting Modes
P Mode
Playback Mode
Wi-Fi Functions
Setting Menu
Accessories
Appendix
Index





8 Access the page in the notification message and complete camera link settings.

- From a computer or smartphone, access the page linked in the notification message.
- Follow the instructions to complete the settings on the camera link settings page.

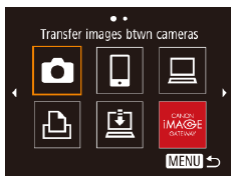

9 Complete CANON iMAGE GATEWAY settings on the camera.

- Press the [▲][▼][◀][▶] buttons to choose [☁], and then press the [ⓘ] button.
- Press the [📖] (108) and CANON iMAGE GATEWAY are now added as destinations.
- You can add other Web services, as needed. In this case, follow the instructions from step 2 in “Registering Other Web Services” (101).



- Make sure initially that your computer or smartphone mail application is not configured to block email from relevant domains, which may prevent you from receiving the notification message.



- You can also change the camera nickname on the screen in step 1 (112).
- Once you have connected to devices via the Wi-Fi menu, recent destinations will be listed first when you access the menu. Press the [◀][▶] buttons to access the device selection screen and then configure the setting.

Registering Other Web Services

You can also add Web services besides CANON iMAGE GATEWAY to the camera.



1 Log in to CANON iMAGE GATEWAY and access the camera link settings page.

- From a computer or smartphone, access <http://www.canon.com/cig/> to visit CANON iMAGE GATEWAY.



2 Configure the Web service you want to use.

- On the computer or smartphone, display the Web service settings screen.
- Follow the on-screen instructions to complete settings for Web services you want to use.

3 Choose [☁].

- Press the [ⓘ] button.
- Press the [▲][▼][◀][▶] buttons to choose [☁], and then press the [ⓘ] button.
- The Web service settings are now updated.

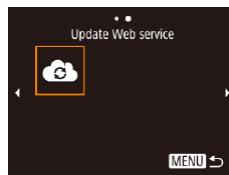

- If any configured settings change, follow these steps again to update the camera settings.

Before Use
Basic Guide
Advanced Guide
Camera Basics
Auto Mode / Hybrid Auto Mode
Other Shooting Modes
P Mode
Playback Mode
Wi-Fi Functions
Setting Menu
Accessories
Appendix
Index

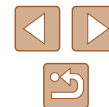

Uploading Images to Web Services

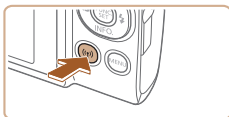

1 Access the Wi-Fi menu.

- Press the **[Wi-Fi]** button.

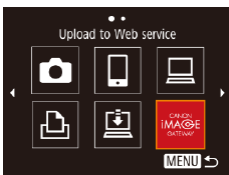

2 Choose the destination.

- Press the **[▲][▼][◀][▶]** buttons to choose the icon of the Web service to connect to, and then press the **[Wi-Fi]** button.
- If multiple recipients or sharing options are used with a Web service, choose the desired item on the **[Select Recipient]** screen by pressing the **[▲][▼]** buttons, and then press the **[Wi-Fi]** button.

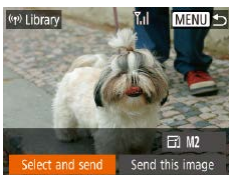

3 Send an image.

- Press the **[▲][▼][◀][▶]** buttons to choose **[Select and send]**, and then press the **[Wi-Fi]** button.
- Press the **[▲][▼]** buttons to choose **[Select]**, and then press the **[Wi-Fi]** button.
- Press the **[▲][▼][◀][▶]** buttons to choose an image to send, press the **[Wi-Fi]** button to mark it as selected (**[✓]**), and then press the **[MENU]** button.
- Press the **[◀][▶]** buttons to choose **[OK]**, and then press the **[Wi-Fi]** button.
- Press the **[▲][▼][◀][▶]** buttons to choose **[Send]**, and then press the **[Wi-Fi]** button.
- When uploading to YouTube, read the terms of service, choose **[I Agree]**, and press the **[Wi-Fi]** button.

- Press the **[Wi-Fi]** button to return to the playback screen once **[OK]** is displayed after the image is sent.



- Connections require that a memory card with saved images be in the camera.
- You can also send multiple images at once, resize images, and add comments before sending (105).
- You can send the current image by choosing **[Send this image]** on the screen in step 3.
- To view images uploaded to CANON IMAGE GATEWAY on a smartphone, try the dedicated Canon Online Photo Album app. Download and install the Canon Online Photo Album app for iPhones or iPads from the App Store or for Android devices from Google Play.

Before Use

Basic Guide

Advanced Guide

Camera Basics

Auto Mode /
Hybrid Auto Mode

Other Shooting Modes

P Mode

Playback Mode

Wi-Fi Functions

Setting Menu

Accessories

Appendix

Index

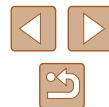

Printing Images Wirelessly from a Connected Printer

Connect the camera to a printer via Wi-Fi to print as follows. These steps show how to use the camera as an access point, but you can also use an existing access point (📖93).

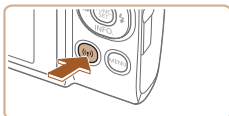

1 Access the Wi-Fi menu.

- Press the [Wi-Fi] button.



2 Choose [Print].

- Press the [▲][▼][◀][▶] buttons to choose [Print], and then press the [OK] button.

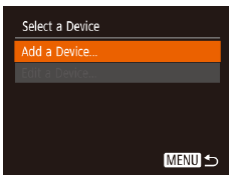

3 Choose [Add a Device].

- Press the [▲][▼] buttons to choose [Add a Device], and then press the [OK] button.

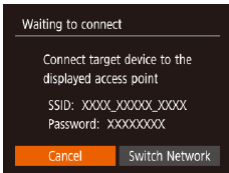

- The camera SSID and password are displayed.

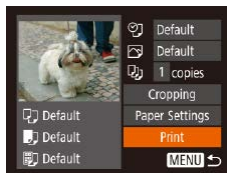
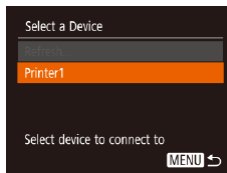

4 Connect the printer to the network.

- In the printer's Wi-Fi setting menu, choose the SSID (network name) displayed on the camera to establish a connection.
- In the password field, enter the password displayed on the camera.

5 Choose the printer.

- Press the [▲][▼] buttons to choose the printer name, and then press the [OK] button.

6 Choose an image to print.

- Press the [◀][▶] buttons to choose an image.
- Press the [OK] button, choose [Print], and press the [OK] button again.
- Press the [▲][▼] buttons to choose [Print], and then press the [OK] button.
- For detailed printing instructions, see "Printing Images" (📖127).
- To end the connection, press the [▲] button, press the [◀][▶] buttons on the confirmation screen to choose [OK], and then press the [OK] button.

Before Use
Basic Guide
Advanced Guide
Camera Basics
Auto Mode / Hybrid Auto Mode
Other Shooting Modes
P Mode
Playback Mode
Wi-Fi Functions
Setting Menu
Accessories
Appendix
Index

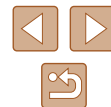



- Connections require that a memory card with saved images be in the camera.
- Once you have connected to devices via the Wi-Fi menu, recent destinations will be listed first when you access the Wi-Fi menu. You can easily connect again by pressing the [▲][▼] buttons to choose the device and then pressing the [Ⓜ] button. To add a new device, display the device selection screen by pressing the [◀][▶] buttons, and then configure the setting.
- If you prefer not to display recent target devices, choose MENU (📖25) ▶ [Y] tab ▶ [Wireless settings] ▶ [Wi-Fi Settings] ▶ [Target History] ▶ [Off].
- To connect without entering a password in step 4, choose MENU (📖25) ▶ [Y] tab ▶ [Wireless settings] ▶ [Wi-Fi Settings] ▶ [Password] ▶ [Off]. [Password] is no longer displayed on the SSID screen (in step 3).
- To use another access point, follow steps 3 – 4 in "Using Another Access Point" (📖93).

Sending Images to Another Camera

Connect two cameras via Wi-Fi and send images between them as follows.

- Only Canon-brand cameras equipped with a Wi-Fi function can be connected to wirelessly. You cannot connect to a Canon-brand camera that does not have a Wi-Fi function, even if it supports Eye-Fi/FlashAir cards.

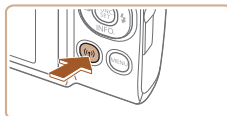

1 Access the Wi-Fi menu.

- Press the [Wi-Fi] button.

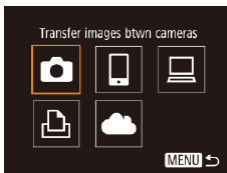

2 Choose [Camera].

- Press the [▲][▼][◀][▶] buttons to choose [Camera], and then press the [Ⓜ] button.

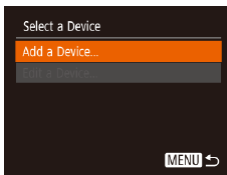

3 Choose [Add a Device].

- Press the [▲][▼] buttons to choose [Add a Device], and then press the [Ⓜ] button.
- Follow steps 1 – 3 on the target camera too.
- Camera connection information will be added when [Start connection on target camera] is displayed on both camera screens.

Before Use
Basic Guide
Advanced Guide
Camera Basics
Auto Mode / Hybrid Auto Mode
Other Shooting Modes
P Mode
Playback Mode
Wi-Fi Functions
Setting Menu
Accessories
Appendix
Index

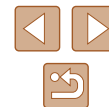



4 Send an image.

- Press the [▲][▼][◀][▶] buttons to choose [Select and send], and then press the [☺] button.
- Press the [▲][▼] buttons to choose [Select], and then press the [☺] button.
- Press the [▲][▼][◀][▶] buttons to choose an image to send, press the [☺] button to mark it as selected ([✓]), and then press the [MENU] button.
- Press the [◀][▶] buttons to choose [OK], and then press the [☺] button.
- Press the [▲][▼][◀][▶] buttons to choose [Send], and then press the [☺] button.
- [Transfer completed] is displayed after the image is sent, and the image transfer screen is displayed again.
- To end the connection, press the [MENU] button, press the [◀][▶] buttons on the confirmation screen to choose [OK], and then press the [☺] button.



- Connections require that a memory card be in the camera.
- Once you have connected to devices via the Wi-Fi menu, recent destinations will be listed first when you access the Wi-Fi menu. You can easily connect again by pressing the [▲][▼] buttons to choose the device and then pressing the [☺] button. To add a new device, display the device selection screen by pressing the [◀][▶] buttons, and then configure the setting.
- If you prefer not to display recent target devices, choose MENU (📖25) ▶ [↑] tab ▶ [Wireless settings] ▶ [Wi-Fi Settings] ▶ [Target History] ▶ [Off].
- You can also send multiple images at once and change the image size before sending (📖105).
- You can send the current image by choosing [Send this image] on the screen in step 4.

Image Sending Options

You can choose multiple images to send at once and change the image recording pixel setting (size) before sending. Some Web services also enable you to annotate the images you send.

Sending Multiple Images

On the image transfer screen, specify a range of images to send, or send only images tagged as favorites.

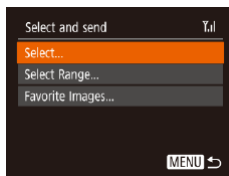
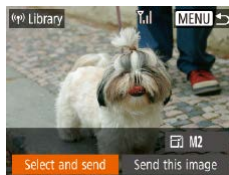

1 Choose [Select and send].

- On the image transfer screen, press the [◀][▶] buttons to choose [Select and send], and then press the [☺] button.

2 Choose a selection method.

- Press the [▲][▼] buttons to choose a selection method.

Selecting a Range

1 Choose [Select Range].

- Following step 2 in “Sending Multiple Images” (📖105), choose [Select Range] and press the [☺] button.

Before Use

Basic Guide

Advanced Guide

Camera Basics

Auto Mode /
Hybrid Auto Mode

Other Shooting Modes

P Mode

Playback Mode

Wi-Fi Functions

Setting Menu

Accessories

Appendix

Index



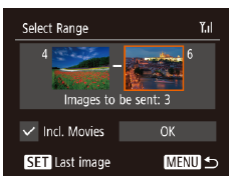

2 Choose images.

- Follow steps 2 – 3 in “Selecting a Range” (📖 73) to specify images.
- To include movies, press the [▲][▼][◀][▶] buttons to choose [Incl. Movies], and then press the [⊕] button to mark the option as selected (✓).
- Press the [▲][▼][◀][▶] buttons to choose [OK], and then press the [⊕] button.

3 Send the images.

- Press the [◀][▶] buttons to choose [Send], and then press the [⊕] button.

📌 Sending Favorite Images

Send only images tagged as favorites (📖 78).

1 Choose [Favorite Images].

- Following step 2 in “Sending Multiple Images” (📖 105), choose [Favorite Images] and press the [⊕] button.
- An image selection screen for favorites is displayed. If you prefer not to include an image, choose the image and press the [⊖] button to remove (✓).
- Press the [MENU] button.
- Press the [◀][▶] buttons to choose [OK], and then press the [⊕] button.

2 Send the images.

- Press the [◀][▶] buttons to choose [Send], and then press the [⊕] button.



- In step 1, [Favorite Images] is not available unless you have tagged images as favorites.

Notes on Sending Images

- Depending on the condition of the network you are using, it may take a long time to send movies. Be sure to keep an eye on the camera battery level.
- Web services may limit the number of images or length of movies you can send.
- When sending movies to smartphones, note that the supported image quality varies depending on the smartphone. For details, refer to the smartphone user manual.
- On the screen, wireless signal strength is indicated by the following icons:
 [📶] high, [📶] medium, [📶] low, [📶] weak
- Sending images to Web services will take less time when resending images you have already sent that are still on the CANON IMAGE GATEWAY server.

Before Use
Basic Guide
Advanced Guide
Camera Basics
Auto Mode / Hybrid Auto Mode
Other Shooting Modes
P Mode
Playback Mode
Wi-Fi Functions
Setting Menu
Accessories
Appendix
Index

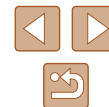

Choosing the Number of Recording Pixels (Image Size)

On the image transfer screen, choose [F] by pressing the [▲][▼] buttons, and then press the [Ⓜ] button. On the screen displayed, choose the recording pixel setting (image size) by pressing the [▲][▼] buttons, and then press the [Ⓜ] button.

- To send images at original size, select [No] as the resizing option.
- Choosing [M2] will resize images that are larger than the selected size before sending.
- Movies cannot be resized.



- Image size can also be configured in MENU (25) ► [↑] tab ► [Wireless settings] ► [Wi-Fi Settings] ► [Resize for Sending].

Adding Comments

Using the camera, you can add comments to images that you send to e-mail addresses, social networking services, etc. The number of characters and symbols that can be entered may differ depending on the Web service.

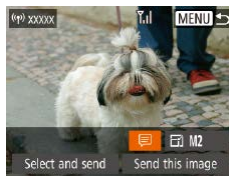

1 Access the screen for adding comments.

- On the image transfer screen, choose [F] by pressing the [▲][▼][◀][▶] buttons, and then press the [Ⓜ] button.

2 Add a comment (26).

3 Send the image.



- When a comment is not entered, the comment set in CANON iIMAGE GATEWAY is automatically sent.
- You can also annotate multiple images before sending them. The same comment is added to all images sent together.

Before Use

Basic Guide

Advanced Guide

Camera Basics

Auto Mode / Hybrid Auto Mode

Other Shooting Modes

P Mode

Playback Mode

Wi-Fi Functions

Setting Menu

Accessories

Appendix

Index

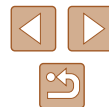

Sending Images Automatically (Image Sync)

Images on the memory card that have not been transferred already can be sent to a computer or Web services via CANON iMAGE GATEWAY. Note that images cannot be sent only to Web services.

Initial Preparations

Preparing the Camera

Register [📱] as the destination. On the destination computer, you will install and configure Image Transfer Utility, free software compatible with Image Sync.



1 Add [📱] as a destination.

- Add [📱] as a destination, as described in “Registering CANON iMAGE GATEWAY” (📖100).
- To include a Web service as the destination, log in to CANON iMAGE GATEWAY (📖100), select your camera model, access the Web service settings screen, and choose the destination Web service in Image Sync settings. For details, refer to CANON iMAGE GATEWAY Help.

2 Choose the type of images to send (only when sending movies with images).

- Press the [MENU] button, choose [Wireless settings] on the [🔑] tab, and then choose [Wi-Fi Settings] (📖25).
- Press the [▲][▼] buttons to choose [Image Sync], and then press the [◀][▶] buttons to choose [Stills/Movies].

Preparing the Computer

Install and configure the software on the destination computer.



1 Install Image Transfer Utility.

- Install Image Transfer Utility on a computer connected to the Internet (📖94).
- Image Transfer Utility can also be downloaded from the Image Sync settings page of CANON iMAGE GATEWAY (📖108).

2 Register the camera.

- Windows: In the taskbar, right-click [🌐], and then click [Add new camera].
- Mac OS: In the menu bar, click [🌐], and then click [Add new camera].
- A list of cameras linked to CANON iMAGE GATEWAY is displayed. Choose the camera from which images are to be sent.
- Once the camera is registered and the computer is ready to receive images, the icon changes to [📱].

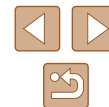

Before Use
Basic Guide
Advanced Guide
Camera Basics
Auto Mode / Hybrid Auto Mode
Other Shooting Modes
P Mode
Playback Mode
Wi-Fi Functions
Setting Menu
Accessories
Appendix
Index



Sending Images

Images sent from the camera are automatically saved to the computer. If the computer that you intend to send images to is turned off, the images will be stored temporarily on the CANON iIMAGE GATEWAY server. Stored images are regularly erased, so make sure to turn on the computer and save the images.

1 Send images.

- Follow steps 1 – 2 in “Uploading Images to Web Services” (📖102) and choose .
- Sent images are labeled with a  icon.

2 Save the images to the computer.

- Images are automatically saved to the computer when you turn it on.
- Images are automatically sent to Web services from the CANON iIMAGE GATEWAY server, even if the computer is off.



- When sending images, you should use a fully charged battery pack.



- Even if images were imported to the computer through a different method, any images not sent to the computer via CANON iIMAGE GATEWAY will be sent to the computer.
- Sending is faster when the destination is a computer on the same network as the camera, because images are sent via the access point instead of CANON iIMAGE GATEWAY. Note that images stored on the computer are sent to CANON iIMAGE GATEWAY, so the computer must be connected to the Internet.

Viewing Images Sent via Image Sync on a Smartphone

By installing the Canon Online Photo Album (Canon OPA) app, you can use your smartphone to view and download images sent via Image Sync while they are stored temporarily on the CANON iIMAGE GATEWAY server.

In preparation, enable smartphone access as follows.

- Make sure you have completed the settings described in “Preparing the Computer” (📖108).
- Download and install the Canon Online Photo Album app for iPhones or iPads from the App Store or for Android devices from Google Play.
- Log in to CANON iIMAGE GATEWAY (📖100), select your camera model, access the Web service settings screen, and enable viewing and downloading from a smartphone in the Image Sync settings. For details, refer to CANON iIMAGE GATEWAY Help.



- Once images stored temporarily on the CANON iIMAGE GATEWAY server have been deleted, they can no longer be viewed.
- Images you sent before enabling smartphone viewing and downloading in Image Sync settings cannot be accessed this way.



- For Canon Online Photo Album instructions, refer to Canon Online Photo Album Help.

Before Use

Basic Guide

Advanced Guide

Camera Basics

Auto Mode /
Hybrid Auto Mode

Other Shooting Modes

P Mode

Playback Mode

Wi-Fi Functions

Setting Menu

Accessories

Appendix

Index



Using a Smartphone to View Camera Images and Control the Camera

You can do the following with the dedicated smartphone app Camera Connect.

- Browse images on the camera and save them to the smartphone
- Geotag images on the camera (📖110)
- Shoot remotely (📖110)



- In camera settings, the smartphone must be allowed to view camera images (📖91, 📖111).

Geotagging Images on the Camera

GPS data recorded on a smartphone using the dedicated Camera Connect application can be added to images on the camera. Images are tagged with information including the latitude, longitude, and elevation.



- Before shooting, make sure the date and time and your home time zone are set correctly, as described in “Setting the Date and Time” (📖17). Also follow the steps in “World Clock” (📖115) to specify any shooting destinations in other time zones.
- Others may be able to locate or identify you by using location data in your geotagged still images or movies. Be careful when sharing these images with others, as when posting images online where many others can view them.

Shooting Remotely

As you check a shooting screen on your smartphone, you can use it to shoot remotely.

1 Secure the camera.

- Once remote shooting begins, the camera lens will come out. Lens motion from zooming may also move the camera out of position. Keep the camera still by mounting it on a tripod or taking other measures.

2 Connect the camera and smartphone (📖91).

- In the privacy settings, choose [Yes].

3 Choose remote shooting.

- In Camera Connect on the smartphone, choose remote shooting.
- The camera lens will come out. Keep your fingers away from the lens, and make sure no objects will obstruct it.
- Once the camera is ready for remote shooting, a live image from the camera will be displayed on the smartphone.
- At this time, a message is displayed on the camera, and all operations except pressing the power button are disabled.

4 Shoot.

- Use the smartphone to shoot.

Before Use

Basic Guide

Advanced Guide

Camera Basics

Auto Mode /
Hybrid Auto Mode

Other Shooting Modes

P Mode

Playback Mode

Wi-Fi Functions

Setting Menu

Accessories

Appendix

Index





- The camera works in [P] mode during remote shooting. However, some FUNC. and MENU settings you have configured in advance may be changed automatically.
- Movie shooting is not available.



- Any jerky subject motion shown on the smartphone due to the connection environment will not affect recorded images.
- No AF frames are displayed. Capture a test image to check the focus.
- Captured images are not transferred to the smartphone. Use the smartphone to browse and import images from the camera.

Editing or Erasing Wi-Fi Settings

Edit or erase Wi-Fi settings as follows.

Editing Connection Information

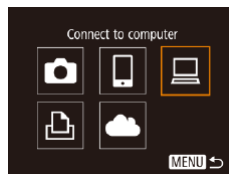

1 Access the Wi-Fi menu and choose a device to edit.

- Press the [W] button.
- Press the [◀][▶] buttons to access the device selection screen, press the [▲][▼][◀][▶] buttons to choose the icon of a device to edit, and then press the [OK] button.

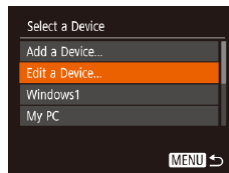

2 Choose [Edit a Device].

- Press the [▲][▼] buttons to choose [Edit a Device], and then press the [OK] button.

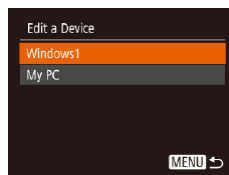

3 Choose the device to edit.

- Press the [▲][▼] buttons to choose the device to edit, and then press the [OK] button.

4 Choose the item to edit.

- Press the [▲][▼] buttons to choose the item to edit, and then press the [OK] button.
- The items you can change depend on the device or service.

Before Use

Basic Guide

Advanced Guide

Camera Basics

Auto Mode / Hybrid Auto Mode

Other Shooting Modes

P Mode

Playback Mode

Wi-Fi Functions

Setting Menu

Accessories

Appendix

Index



Configurable Items	Connection				
					Web Services
[Change Device Nickname] (📖112)	○	○	○	○	–
[View Settings] (📖91)	–	○	–	–	–
[Erase Connection Info] (📖112)	○	○	○	○	–

○ : Configurable – : Not configurable

Changing a Device Nickname

You can change the device nickname (display name) that is displayed on the camera.

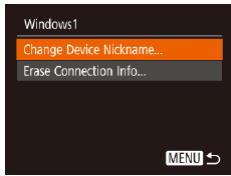

- Following step 4 in “Editing Connection Information” (📖111), choose [Change Device Nickname] and press the [MENU] button.
- Select the input field and press the [MENU] button. Use the keyboard displayed to enter a new nickname (📖26).

Erasing Connection Information

Erase connection information (information about devices that you have connected to) as follows.

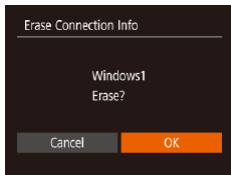

- Following step 4 in “Editing Connection Information” (📖111), choose [Erase Connection Info] and press the [MENU] button.
- After [Erase?] is displayed, press the [◀][▶] buttons to choose [OK], and then press the [MENU] button.
- The connection information will be erased.

Changing the Camera Nickname

Change the camera nickname (displayed on connected devices) as desired.

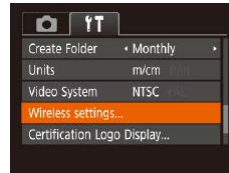

1 Choose [Wireless settings].

- Press the [MENU] button and choose [Wireless settings] on the [↑] tab (📖25).

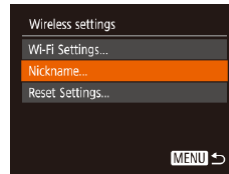

2 Choose [Nickname].

- Press the [▲][▼] buttons to choose [Nickname], and then press the [MENU] button.

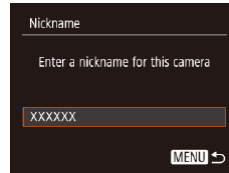

3 Change the nickname.

- Press the [MENU] button to access the keyboard (📖26), and then enter a nickname.



- A message is displayed if the nickname you enter begins with a symbol or space. Press the [MENU] button and enter a different nickname.
- You can also change the nickname from the [Device Nickname] screen displayed when you first use Wi-Fi. In this case, select the text box, press the [MENU] button to access the keyboard, and then enter a new nickname.

Before Use
Basic Guide
Advanced Guide
Camera Basics
Auto Mode / Hybrid Auto Mode
Other Shooting Modes
P Mode
Playback Mode
Wi-Fi Functions
Setting Menu
Accessories
Appendix
Index



Returning the Wi-Fi Settings to Default

Return the Wi-Fi settings to default if you transfer ownership of the camera to another person, or dispose of it.

Resetting the Wi-Fi settings will also clear all Web service settings. Be sure that you want to reset all Wi-Fi settings before using this option.

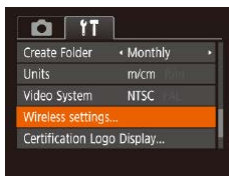

1 Choose [Wireless settings].

- Press the [MENU] button and choose [Wireless settings] on the [Wi-Fi] tab (125).

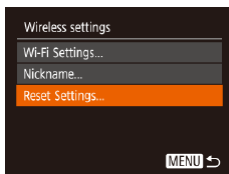

2 Choose [Reset Settings].

- Press the [▲][▼] buttons to choose [Reset Settings], and then press the [OK] button.

3 Restore the default settings.

- Press the [◀][▶] buttons to choose [OK], and then press the [OK] button.
- The Wi-Fi settings are now reset.



- To reset other settings (aside from Wi-Fi) to defaults, choose [Reset All] on the [Wi-Fi] tab (120).

Before Use

Basic Guide

Advanced Guide

Camera Basics

Auto Mode /
Hybrid Auto Mode

Other Shooting Modes

P Mode

Playback Mode

Wi-Fi Functions

Setting Menu

Accessories

Appendix

Index

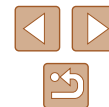

Setting Menu

Customize or adjust basic camera functions for greater convenience

Adjusting Basic Camera Functions

MENU (📖25) functions on the (📷) tab can be configured. Customize commonly used functions as desired, for greater convenience.

Silencing Camera Operations

Silence camera sounds and movies as follows.

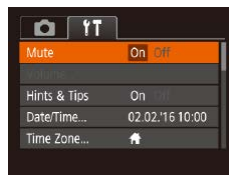

- Choose [Mute], and then choose [On].



- Operation can also be silenced by holding down the [▼] button as you turn the camera on.
- Sound is not played during movies (📖64) if you mute camera sounds. To restore sound during movies, press the [▲] button. Adjust volume with the [▲][▼] buttons, as needed.

Adjusting the Volume

Adjust the volume of individual camera sounds as follows.



- Choose [Volume], and then press the (🔊) button.
- Choose an item, and then press the [◀][▶] buttons to adjust the volume.

Before Use

Basic Guide

Advanced Guide

Camera Basics

Auto Mode /
Hybrid Auto Mode

Other Shooting Modes

P Mode

Playback Mode

Wi-Fi Functions

Setting Menu

Accessories

Appendix

Index



Hiding Hints and Tips

Hints and tips are normally shown when you choose FUNC. (📖24) or MENU (📖25) items. If you prefer, you can deactivate this information.

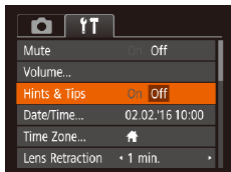

- Choose [Hints & Tips], and then choose [Off].

Date and Time

Adjust the date and time as follows.

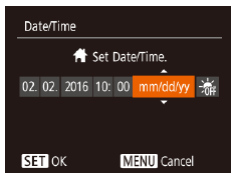

- Choose [Date/Time], and then press the [⊙] button.
- Press the [◀][▶] buttons to choose an item, and then press the [▲][▼] buttons to adjust the setting.

World Clock

To ensure that your shots will have the correct local date and time when you travel abroad, simply register the destination in advance and switch to that time zone. This convenient feature eliminates the need to change the Date/Time setting manually.

Before using the world clock, be sure to set the date and time and your home time zone, as described in “Setting the Date and Time” (📖17).

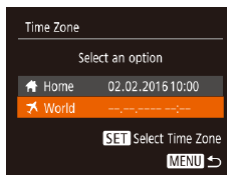

1 Specify your destination.

- Choose [Time Zone], and then press the [⊙] button.
- Press the [▲][▼] buttons to choose [✈ World], and then press the [⊙] button.
- Press the [◀][▶] buttons to choose the destination.
- To set daylight saving time (1 hour ahead), choose [☀] by pressing the [▲][▼] buttons, and then choose [☀] by pressing the [◀][▶] buttons.
- Press the [⊙] button.

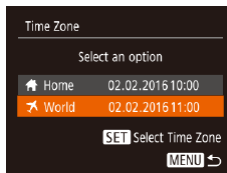

2 Switch to the destination time zone.

- Press the [▲][▼] buttons to choose [✈ World], and then press the [MENU] button.
- [✈] is now shown on the shooting screen (📖140).



- Adjusting the date or time while in [✈] mode (📖18) will automatically update your [🏠 Home] time and date.

Before Use

Basic Guide

Advanced Guide

Camera Basics

Auto Mode /
Hybrid Auto Mode

Other Shooting Modes

P Mode

Playback Mode

Wi-Fi Functions

Setting Menu

Accessories

Appendix

Index



Lens Retraction Timing

The lens is normally retracted for safety about one minute after you press the [▶] button in Shooting mode (122). To have the lens retracted immediately after you press the [▶] button, set the retraction timing to [0 sec.].

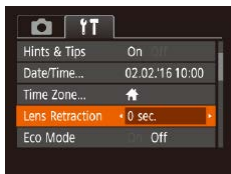

- Choose [Lens Retraction], and then choose [0 sec.].

Using Eco Mode

This function allows you to conserve battery power in Shooting mode. When the camera is not in use, the screen quickly darkens to reduce battery consumption.

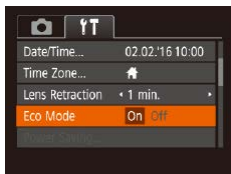

1 Configure the setting.

- Choose [Eco Mode], and then choose [On].
- [ECO] is now shown on the shooting screen (140).
- The screen darkens when the camera is not used for approximately two seconds; approximately ten seconds after darkening, the screen turns off. The camera turns off after approximately three minutes of inactivity.

2 Shoot.

- To activate the screen and prepare for shooting when the screen is off but the lens is still out, press the shutter button halfway.

Power-Saving Adjustment

Adjust the timing of automatic camera and screen deactivation (Auto Power Down and Display Off, respectively) as needed (123).

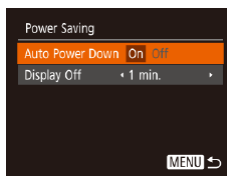

- Choose [Power Saving], and then press the [P] button.
- After choosing an item, press the [◀][▶] buttons to adjust it as needed.



- To conserve battery power, you should normally choose [On] for [Auto Power Down] and [1 min.] or less for [Display Off].



- The [Display Off] setting is applied even if you set [Auto Power Down] to [Off].
- These power-saving functions are not available when you have set Eco mode (116) to [On].

Before Use

Basic Guide

Advanced Guide

Camera Basics

Auto Mode /
Hybrid Auto Mode

Other Shooting Modes

P Mode

Playback Mode

Wi-Fi Functions

Setting Menu

Accessories

Appendix

Index

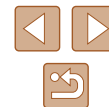

Screen Brightness

Adjust screen brightness as follows.

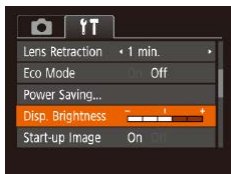

- Choose [Disp. Brightness], and then press the [◀][▶] buttons to adjust the brightness.



- For maximum brightness, press and hold the [▼] button for at least one second when the shooting screen is displayed or when in single-image display. (This will override the [Disp. Brightness] setting on the [↑] tab.) To restore the original brightness, press and hold the [▼] button again for at least one second or restart the camera.

Hiding the Start-Up Screen

If you prefer, you can deactivate display of the start-up screen normally shown when you turn the camera on.



- Choose [Start-up Image], and then choose [Off].

Formatting Memory Cards

Before using a new memory card or a card formatted in another device, you should format the card with this camera.

Formatting erases all data on a memory card. Before formatting, copy images on the memory card to a computer, or take other steps to back them up.

1 Access the [Format] screen.

- Choose [Format], and then press the [Ⓜ] button.

2 Choose [OK].

- Press the [▲][▼] buttons to choose [Cancel], press the [◀][▶] buttons to choose [OK], and then press the [Ⓜ] button.

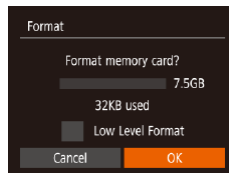

3 Format the memory card.

- To begin the formatting process, press the [▲][▼] buttons to choose [OK], and then press the [Ⓜ] button.
- When formatting is finished, [Memory card formatting complete] is displayed. Press the [Ⓜ] button.

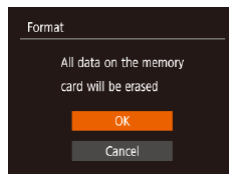

- Formatting or erasing data on a memory card only changes file management information on the card and does not erase the data completely. When transferring or disposing of memory cards, take steps to protect personal information if necessary, as by physically destroying cards.

Before Use

Basic Guide

Advanced Guide

Camera Basics

Auto Mode /
Hybrid Auto Mode

Other Shooting Modes

P Mode

Playback Mode

Wi-Fi Functions

Setting Menu

Accessories

Appendix

Index





- The total card capacity indicated on the formatting screen may be less than the advertised capacity.

Low-Level Formatting

Perform low-level formatting in the following cases: [Memory card error] is displayed, the camera is not working correctly, card image reading/writing is slower, continuous shooting is slower, or movie recording suddenly stops. Low-level formatting erases all data on a memory card. Before low-level formatting, copy images on the memory card to a computer, or take other steps to back them up.

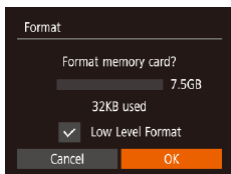

- On the screen in step 2 of “Formatting Memory Cards” (📖 117), press the [▲][▼] buttons to choose [Low Level Format], and then press the [◀][▶] buttons to select this option. A [✓] icon is displayed.
- Follow steps 2 – 3 in “Formatting Memory Cards” (📖 117) to continue with the formatting process.



- Low-level formatting takes longer than “Formatting Memory Cards” (📖 117), because data is erased from all storage regions of the memory card.
- You can cancel low-level formatting in progress by choosing [Stop]. In this case, all data will be erased, but the memory card can be used normally.

File Numbering

Your shots are automatically numbered in sequential order (0001 – 9999) and saved in folders that store up to 2,000 images each. You can change how the camera assigns file numbers.

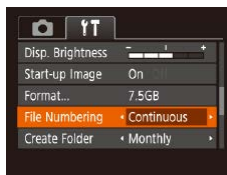

- Choose [File Numbering], and then choose an option.

Continuous	Images are numbered consecutively (until the 9999th shot is taken/saved) even if you switch memory cards.
Auto Reset	Image numbering is reset to 0001 if you switch memory cards, or when a new folder is created.



- Regardless of the option selected in this setting, shots may be numbered consecutively after the last number of existing images on newly inserted memory cards. To start saving shots from 0001, use an empty (or formatted, 📖 117) memory card.

Before Use

Basic Guide

Advanced Guide

Camera Basics

Auto Mode /
Hybrid Auto Mode

Other Shooting Modes

P Mode

Playback Mode

Wi-Fi Functions

Setting Menu

Accessories

Appendix

Index



Date-Based Image Storage

Instead of saving images in folders created each month, you can have the camera create folders each day you shoot to store shots taken that day.



- Choose [Create Folder], and then choose [Daily].
- Images will now be saved in folders created on the shooting date.

Metric / Non-Metric Display

Change the unit of measurement shown in GPS elevation information (110), the zoom bar (28), and elsewhere from m/cm to ft/in as needed.



- Choose [Units], and then choose [ft/in].

Checking Certification Logos

Some logos for certification requirements met by the camera can be viewed on the screen. Other certification logos are printed in this guide, on the camera packaging, or on the camera body.

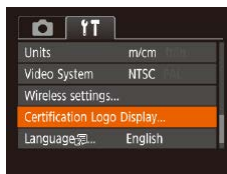

- Choose [Certification Logo Display], and then press the [MENU] button.

Display Language

Change the display language as needed.



- Choose [Language], and then press the [MENU] button.
- Press the [▲][▼][◀][▶] buttons to choose a language, and then press the [MENU] button.





- You can also access the [Language] screen in Playback mode by pressing and holding the [MENU] button and immediately pressing the [MENU] button.

Before Use
Basic Guide
Advanced Guide
Camera Basics
Auto Mode / Hybrid Auto Mode
Other Shooting Modes
P Mode
Playback Mode
Wi-Fi Functions
Setting Menu
Accessories
Appendix
Index



Adjusting Other Settings

The following settings can also be adjusted on the  tab.

- [Video System]  123
- [Wireless settings]  87



Restoring Default Camera Settings

If you accidentally change a setting, you can restore default camera settings.





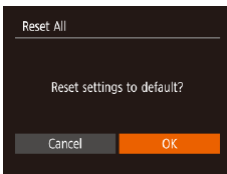

1 Access the [Reset All] screen.

- Choose [Reset All], and then press the  button.

2 Restore default settings.

- Press the   buttons to choose [OK], and then press the  button.
- Default settings are now restored.



- The following functions are not restored to default settings.
 -  tab settings [Date/Time]  115), [Time Zone]  115), [Language]  119), and [Video System]  123)
 - Custom white balance data you have recorded  56)
 - Shooting Mode
 - Wi-Fi settings  87)

Before Use

Basic Guide

Advanced Guide

Camera Basics

Auto Mode /
Hybrid Auto Mode

Other Shooting Modes

P Mode

Playback Mode

Wi-Fi Functions

Setting Menu

Accessories

Appendix

Index

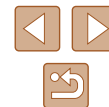

Accessories

Enjoy the camera in more ways with optional Canon accessories and other compatible accessories sold separately

System Map

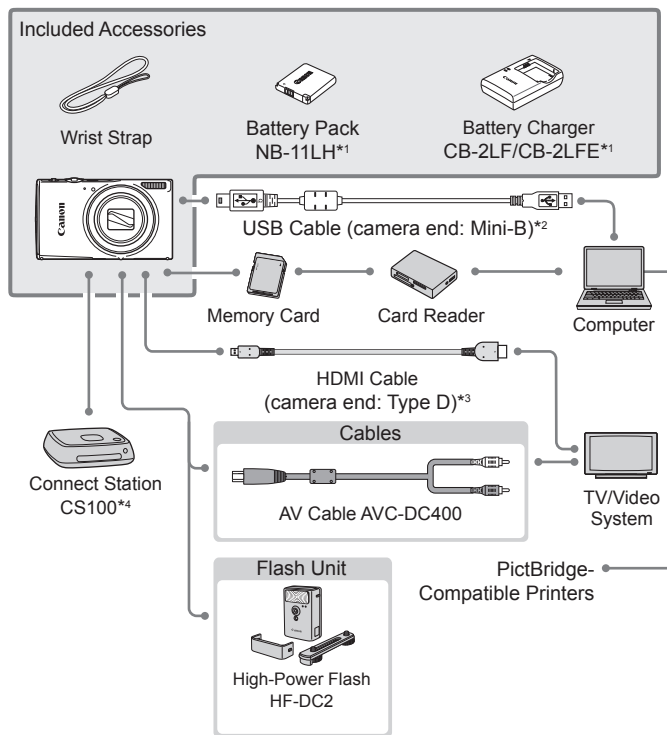

*1 Also available for purchase separately.

*2 A genuine Canon accessory is also available (Interface Cable IFC-400PCU).

*3 Use a commercially available cable no longer than 2.5 m (8.2 ft.).

*4 Use the latest firmware.

- Before Use
- Basic Guide
- Advanced Guide
 - Camera Basics
 - Auto Mode / Hybrid Auto Mode
 - Other Shooting Modes
 - P Mode
 - Playback Mode
 - Wi-Fi Functions
 - Setting Menu
 - Accessories
 - Appendix
- Index

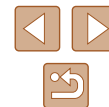

Use of genuine Canon accessories is recommended.

This product is designed to achieve excellent performance when used with genuine Canon accessories. Canon shall not be liable for any damage to this product and/or accidents such as fire, etc., caused by the malfunction of non-genuine Canon accessories (e.g., a leakage and/or explosion of a battery pack). Please note that this warranty does not apply to repairs arising out of the malfunction of non-genuine Canon accessories, although you may request such repairs on a chargeable basis.

Optional Accessories

The following camera accessories are sold separately. Note that availability varies by area, and some accessories may no longer be available.

Power Supplies

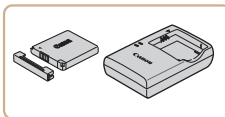

Battery Pack NB-11LH

- Rechargeable lithium-ion battery

Battery Charger CB-2LF/CB-2LFE

- Charger for Battery Pack NB-11LH.



- The battery pack includes a convenient cover which you can attach to know the charge status at a glance. Attach the cover so that ▲ is visible on a charged battery pack, and attach it so that ▲ is not visible on an uncharged battery pack.
- Battery Pack NB-11L is also supported.

Flash Unit

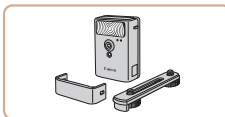

High-Power Flash HF-DC2

- External flash for illuminating subjects that are out of range of the built-in flash.

Before Use

Basic Guide

Advanced Guide

Camera Basics

Auto Mode /
Hybrid Auto Mode

Other Shooting Modes

P Mode

Playback Mode

Wi-Fi Functions

Setting Menu

Accessories

Appendix

Index



Other Accessories

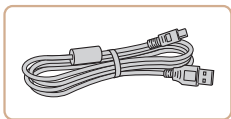

Interface Cable IFC-400PCU

- For connecting the camera to a computer or printer.

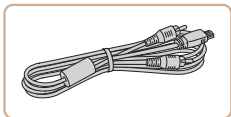

AV Cable AVC-DC400

- Connect the camera to a TV to enjoy playback on the larger TV screen.

Printers

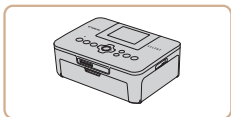

Canon-Brand PictBridge-Compatible Printers

- Even without using a computer, you can print images by connecting the camera directly to a printer. For details, visit your nearest Canon retailer.

Photo and Movie Storage

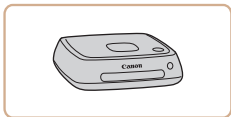

Connect Station CS100

- A media hub for storing camera images, viewing on a connected TV, printing wirelessly on a Wi-Fi-compatible printer, sharing over the Internet, and more.

Using Optional Accessories

Playback on a TV

► Still Images ► Movies

By connecting the camera to a TV, you can view your shots on the larger screen of the TV.

For details on connection or how to switch inputs, refer to the TV manual.



- Some information may not be displayed when viewing images on a TV (p.141).

Playback on a High-Definition TV

You can view your shots on a TV by connecting the camera to an HDTV with a commercially available HDMI cable (not exceeding 2.5 m / 8.2 ft., with a Type D terminal on the camera end). Movies shot at an image quality of [E-FHD] or [E-HD] can be viewed in high definition.

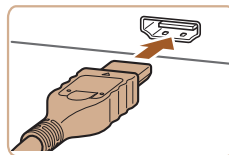

1 Make sure the camera and TV are off.

2 Connect the camera to the TV.

- On the TV, insert the cable plug fully into the HDMI input as shown.

Before Use

Basic Guide

Advanced Guide

Camera Basics

Auto Mode /
Hybrid Auto Mode

Other Shooting Modes

P Mode

Playback Mode

Wi-Fi Functions

Setting Menu

Accessories

Appendix

Index



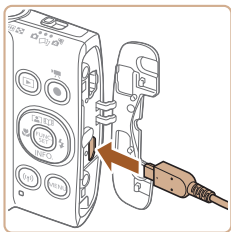

- On the camera, open the terminal cover and insert the cable plug fully into the camera terminal.

3 Turn the TV on and switch to external input.

- Switch the TV input to the external input you connected the cable to in step 2.



4 Turn the camera on.

- Press the **[▶]** button to turn the camera on.
- Images from the camera are now displayed on the TV. (Nothing is displayed on the camera screen.)
- When finished, turn off the camera and TV before disconnecting the cable.



- Camera operating sounds are not played while the camera is connected to an HDTV.

■ Playback on a Standard-Definition TV

Connecting the camera to a TV with the AV Cable AVC-DC400 (sold separately) enables you to view your shots on the larger screen of the TV as you control the camera.

1 Make sure the camera and TV are off.

2 Connect the camera to the TV.

- On the TV, insert the cable plugs fully into the video inputs as shown.

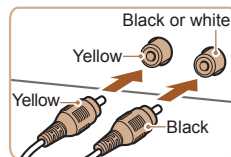

- On the camera, open the terminal cover and insert the cable plug fully into the camera terminal.

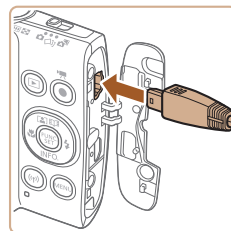

3 Display images.

- Follow steps 3 – 4 in “Playback on a High-Definition TV” (123) to display images.



- Correct display is not possible unless the camera video output format (NTSC or PAL) matches the TV format. To change the video output format, press the **[iMENU]** button and choose [Video System] on the **[Y↑]** tab. (For Japan, choose [NTSC].)



- When the camera and TV are connected, you can also shoot while previewing shots on the larger screen of the TV. To shoot, follow the same steps as when using the camera screen. However, AF-Point Zoom (140) is not available.

Before Use
Basic Guide
Advanced Guide
Camera Basics
Auto Mode / Hybrid Auto Mode
Other Shooting Modes
P Mode
Playback Mode
Wi-Fi Functions
Setting Menu
Accessories
Appendix
Index

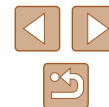

Using the Software

To utilize the features of the following software, download the software from the Canon website and install it on your computer.

- CameraWindow
 - Import images to your computer
- Image Transfer Utility
 - Set up Image Sync (📖108) and receive images
- Map Utility
 - Use a map to view GPS information that has been added to images



- To view and edit images on a computer, use preinstalled or commonly available software compatible with images captured by the camera.

Computer Connections via a Cable

Checking Your Computer Environment

For detailed software system requirements and compatibility information (including support in new operating systems), visit the Canon website.

Installing the Software

Windows 7 and Mac OS X 10.8 are used here for the sake of illustration.

1 Download the software.

- With a computer connected to the Internet, access <http://www.canon.com/icpd/>.
- Access the site for your country or region.
- Download the software.



2 Install the software.

- Click [Easy Installation] and follow the on-screen instructions to complete the installation process. Installation may take some time, depending on computer performance and the Internet connection.
- Click [Finish] or [Restart] on the screen after installation.



- Internet access is required, and any ISP account charges and access fees must be paid separately.



- To uninstall the software, follow these steps.
 - Windows: Select [Start] menu ► [All Programs] ► [Canon Utilities], and then choose the software for uninstallation.
 - Mac OS: In the [Canon Utilities] folder within the [Applications] folder, drag the folder of the software for uninstallation to the Trash, and then empty the Trash.

Before Use

Basic Guide

Advanced Guide

Camera Basics

Auto Mode /
Hybrid Auto Mode

Other Shooting Modes

P Mode

Playback Mode

Wi-Fi Functions

Setting Menu

Accessories

Appendix

Index



Saving Images to a Computer

Using a USB cable (sold separately; camera end: Mini-B), you can connect the camera to the computer and save images to the computer.

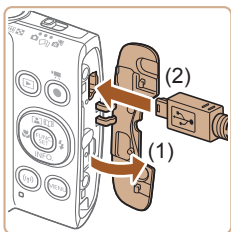

1 Connect the camera to the computer.

- With the camera turned off, open the cover (1). With the smaller plug of the USB cable in the orientation shown, insert the plug fully into the camera terminal (2).

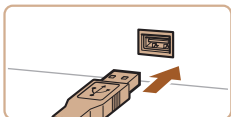

- Insert the larger plug of the USB cable in the computer's USB port. For details about USB connections on the computer, refer to the computer user manual.



2 Turn the camera on to access CameraWindow.

- Press the [▶] button to turn the camera on.
- Mac OS: CameraWindow is displayed when a connection is established between the camera and computer.
- Windows: Follow the steps introduced below.
- In the screen that is displayed, click the change program link of [📷].

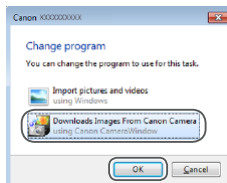

- Choose [Downloads Images From Canon Camera] and then click [OK].

- Double-click [📷].

3 Save the images to the computer.

- Click [Import Images from Camera], and then click [Import Untransferred Images].
- Images are now saved to the Pictures folder on the computer, in separate folders named by date.
- After images are saved, close CameraWindow, press the [▶] button to turn the camera off, and unplug the cable.
- To view images you save to a computer, use preinstalled or commonly available software compatible with images captured by the camera.

Before Use
Basic Guide
Advanced Guide
Camera Basics
Auto Mode / Hybrid Auto Mode
Other Shooting Modes
P Mode
Playback Mode
Wi-Fi Functions
Setting Menu
Accessories
Appendix
Index

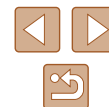



- Windows 7: If the screen in step 2 is not displayed, click the  icon in the taskbar.
- Mac OS: If CameraWindow is not displayed after step 2, click the [CameraWindow] icon in the Dock.
- Although you can save images to a computer simply by connecting your camera to the computer without using the software, the following limitations apply.
 - It may take a few minutes after you connect the camera to the computer until camera images are accessible.
 - Images shot in vertical orientation may be saved in horizontal orientation.
 - Image protection settings may be cleared from images saved to a computer.
 - Some problems may occur when saving images or image information, depending on the operating system version, the software in use, or image file sizes.

Printing Images

Your shots can easily be printed by connecting the camera to a printer. On the camera, you can specify images to set up batch printing, prepare orders for photo development services, and prepare orders or print images for photobooks.

A Canon SELPHY CP series compact photo printer is used here for the sake of illustration. Screens displayed and available functions vary by printer. Also refer to the printer manual for additional information.

Easy Print

► Still Images ► Movies

Print your shots by connecting the camera to a PictBridge-compatible printer with a USB cable (sold separately; camera end: Mini-B).

1 Make sure the camera and printer are off.

2 Connect the camera to the printer.

- Open the terminal cover. Holding the smaller cable plug in the orientation shown, insert the plug fully into the camera terminal.
- Connect the larger cable plug to the printer. For other connection details, refer to the printer manual.

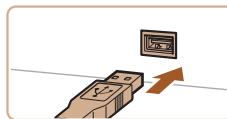
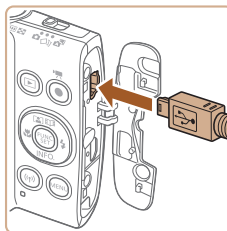

Before Use

Basic Guide

Advanced Guide

Camera Basics

Auto Mode /
Hybrid Auto Mode

Other Shooting Modes

P Mode

Playback Mode

Wi-Fi Functions

Setting Menu

Accessories

Appendix

Index





3 Turn the printer on.

4 Turn the camera on.

- Press the [▶] button to turn the camera on.

5 Choose an image.

- Press the [◀][▶] buttons to choose an image.

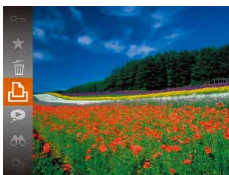

6 Access the printing screen.

- Press the [Ⓜ] button, choose [▶], and press the [Ⓜ] button again.

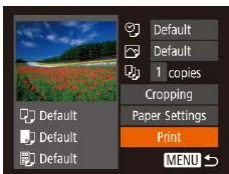

7 Print the image.

- Press the [▲][▼] buttons to choose [Print], and then press the [Ⓜ] button.
- Printing now begins.
- To print other images, repeat the above procedures starting from step 5 after printing is finished.
- When you are finished printing, turn the camera and printer off and disconnect the cable.



- For Canon-brand PictBridge-compatible printers (sold separately), see "Printers" (123).

Configuring Print Settings

▶ Still Images ▶ Movies

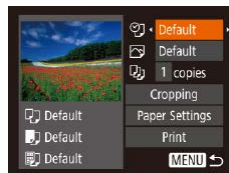

1 Access the printing screen.

- Follow steps 1 – 6 in "Easy Print" (127) to access this screen.

2 Configure the settings.

- Press the [▲][▼] buttons to choose an item, and then press the [◀][▶] buttons to choose an option.

🗨️	Default	Matches current printer settings.
	Date	Prints images with the date added.
	File No.	Prints images with the file number added.
	Both	Prints images with both the date and file number added.
🖨️	Off	–
	Default	Matches current printer settings.
	Off	–
	On	Uses information from the time of shooting to print under optimal settings.
	Red-Eye1	Corrects red-eye.
📄	No. of Copies	Choose the number of copies to print.
Cropping	–	Specify a desired image area to print (129).
Paper Settings	–	Specify the paper size, layout, and other details (129).

Before Use

Basic Guide

Advanced Guide

Camera Basics

Auto Mode / Hybrid Auto Mode

Other Shooting Modes

P Mode

Playback Mode

Wi-Fi Functions

Setting Menu

Accessories

Appendix

Index



Cropping Images before Printing

By cropping images before printing, you can print a desired image area instead of the entire image.

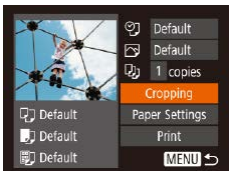

1 Choose [Cropping].

- After following step 1 in “Configuring Print Settings” (128) to access the printing screen, choose [Cropping] and press the [OK] button.
- A cropping frame is now displayed, indicating the image area to print.

2 Adjust the cropping frame as needed.

- To resize the frame, move the zoom lever.
- To move the frame, press the [▲][▼][◀][▶] buttons.
- To rotate the frame, press the [⊞] button.
- Press the [MENU] button, press the [▲][▼] buttons to choose [OK], and then press the [⊞] button.

3 Print the image.

- Follow step 7 in “Easy Print” (127) to print.



- Cropping may not be possible at small image sizes, or at some aspect ratios.
- Dates may not be printed correctly if you crop images shot with [Date Stamp] selected.

Choosing Paper Size and Layout before Printing

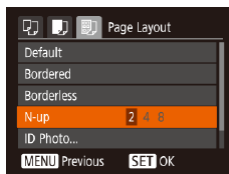
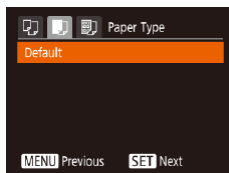
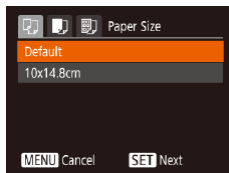
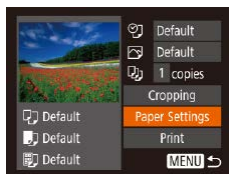

1 Choose [Paper Settings].

- After following step 1 in “Configuring Print Settings” (128) to access the printing screen, choose [Paper Settings] and press the [OK] button.

2 Choose a paper size.

- Press the [▲][▼] buttons to choose an option, and then press the [OK] button.

3 Choose a type of paper.

- Press the [▲][▼] buttons to choose an option, and then press the [OK] button.

4 Choose a layout.

- Press the [▲][▼] buttons to choose an option.
- When choosing [N-up], press the [◀][▶] buttons to specify the number of images per sheet.
- Press the [OK] button.

5 Print the image.

Before Use

Basic Guide

Advanced Guide

Camera Basics

Auto Mode /
Hybrid Auto Mode

Other Shooting Modes

P Mode

Playback Mode

Wi-Fi Functions

Setting Menu

Accessories

Appendix

Index



Available Layout Options

Default	Matches current printer settings.
Bordered	Prints with blank space around the image.
Borderless	Borderless, edge-to-edge printing.
N-up	Choose how many images to print per sheet.
ID Photo	Prints images for identification purposes. Only available for images with a recording pixel setting of L and an aspect ratio of 4:3.
Fixed Size	Choose the print size. Choose from 3.5 x 5 in., postcard, or wide-format prints.

Printing ID Photos

1 Choose [ID Photo].

- Following steps 1 – 4 in “Choosing Paper Size and Layout before Printing” (129), choose [ID Photo] and press the [OK] button.

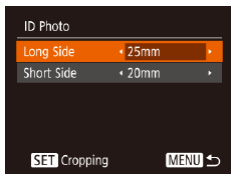

2 Choose the long and short side length.

- Press the [▲][▼] buttons to choose an item. Choose the length by pressing the [◀][▶] buttons, and then press the [OK] button.



3 Choose the printing area.

- Follow step 2 in “Cropping Images before Printing” (129) to choose the printing area.

4 Print the image.

Printing Movie Scenes

▶ Still Images ▶ Movies

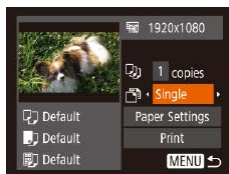

1 Access the printing screen.

- Follow steps 1 – 6 in “Easy Print” (127) to choose a movie. This screen is displayed.

2 Choose a printing method.

- Press the [▲][▼] buttons to choose [Single], and then press the [◀][▶] buttons to choose the printing method.

3 Print the image.

Movie Printing Options

Single	Prints the current scene as a still image.
Sequence	Prints a series of scenes, a certain interval apart, on a single sheet of paper. You can also print the folder number, file number, and elapsed time for the frame by setting [Caption] to [On].



- To cancel printing in progress, press the [OK] button, choose [OK], and then press the [OK] button again.
- After displaying a scene to print as described in steps 2 – 5 of “Viewing” (64), you can also access the screen in step 1 here by pressing the [◀][▶] buttons to choose [Single] in the movie control panel and then pressing the [OK] button.

Before Use
Basic Guide
Advanced Guide
Camera Basics
Auto Mode / Hybrid Auto Mode
Other Shooting Modes
P Mode
Playback Mode
Wi-Fi Functions
Setting Menu
Accessories
Appendix
Index



Adding Images to the Print List (DPOF)

► Still Images ► Movies

Batch printing (132) and ordering prints from a photo development service can be set up on the camera. Choose up to 998 images on a memory card and configure relevant settings, such as the number of copies, as follows. The printing information you prepare this way will conform to DPOF (Digital Print Order Format) standards.

Configuring Print Settings

Specify the printing format, whether to add the date or file number, and other settings as follows. These settings apply to all images in the print list.

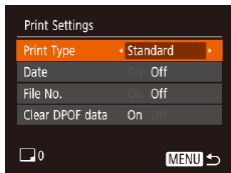

- Press the [MENU] button, and then choose [Print Settings] on the [P] tab. Choose and configure items as desired (25).

Print Type	Standard	One image is printed per sheet.
	Index	Smaller versions of multiple images are printed per sheet.
	Both	Both standard and index formats are printed.
Date	On	Images are printed with the shooting date.
	Off	–
File No.	On	Images are printed with the file number.
	Off	–
Clear DPOF data	On	All image print list settings are cleared after printing.
	Off	–



- Not all of your DPOF settings may be applied in printing by the printer or photo development service, in some cases.
- [!] may be displayed on the camera to warn you that the memory card has print settings that were configured on another camera. Changing the print settings using this camera may overwrite all previous settings.



- Specifying [Index] will prevent you from choosing [On] for both [Date] and [File No.] at the same time.
- Index printing is not available on some Canon-brand PictBridge-compatible printers (sold separately).
- The date is printed in a format matching setting details in [Date/Time] on the [P] tab (17).

Setting Up Printing for Individual Images

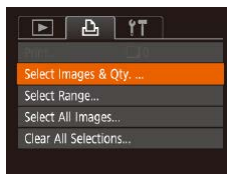

1 Choose [Select Images & Qty.].

- Press the [MENU] button, choose [Select Images & Qty.] on the [P] tab, and then press the [OK] button.

2 Choose an image.

- Press the [Left][Right] buttons to choose an image, and then press the [OK] button.
- You can now specify the number of copies.
- If you specify index printing for the image, it is labeled with a [✓] icon. To cancel index printing for the image, press the [OK] button again. [✓] is no longer displayed.

Before Use

Basic Guide

Advanced Guide

Camera Basics

Auto Mode / Hybrid Auto Mode

Other Shooting Modes

P Mode

Playback Mode

Wi-Fi Functions

Setting Menu

Accessories

Appendix

Index





3 Specify the number of prints.

- Press the [▲][▼] buttons to specify the number of prints (up to 99).
- To set up printing for other images and specify the number of prints, repeat steps 2 – 3.
- Printing quantity cannot be specified for index prints. You can only choose which images to print, by following step 2.
- When finished, press the [MENU] button to return to the menu screen.

Setting Up Printing for a Range of Images



- Following step 1 in “Setting Up Printing for Individual Images” (131), choose [Select Range] and press the [OK] button.
- Follow steps 2 – 3 in “Selecting a Range” (73) to specify images.
- Press the [▲][▼] buttons to choose [Order], and then press the [OK] button.

Setting Up Printing for All Images

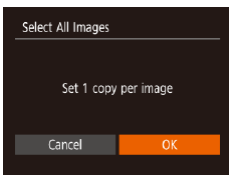

- Following step 1 in “Setting Up Printing for Individual Images” (131), choose [Select All Images] and press the [OK] button.
- Press the [◀][▶] buttons to choose [OK], and then press the [OK] button.

Clearing All Images from the Print List

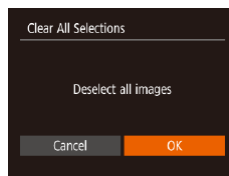

- Following step 1 in “Setting Up Printing for Individual Images” (131), choose [Clear All Selections] and press the [OK] button.
- Press the [◀][▶] buttons to choose [OK], and then press the [OK] button.

Printing Images Added to the Print List (DPOF)

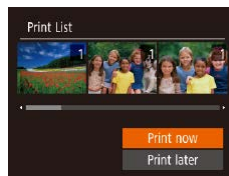

- When images have been added to the print list (131 – 132), this screen is displayed after you connect the camera to a PictBridge-compatible printer. Press the [▲][▼] buttons to choose [Print now], and then simply press the [OK] button to print the images in the print list.
- Any DPOF print job that you temporarily stop will be resumed from the next image.

Before Use
Basic Guide
Advanced Guide
Camera Basics
Auto Mode / Hybrid Auto Mode
Other Shooting Modes
P Mode
Playback Mode
Wi-Fi Functions
Setting Menu
Accessories
Appendix
Index



Adding Images to a Photobook

► Still Images ► Movies

Photobooks can be set up on the camera by choosing up to 998 images on a memory card and importing them into the software on your computer, where they are stored in their own folder. This is convenient when ordering printed photobooks online or printing photobooks with your own printer.

Choosing a Selection Method

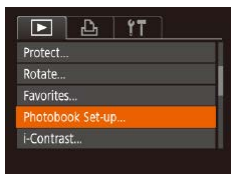

- Press the [MENU] button, choose [Photobook Set-up] on the [▶] tab, and then choose how you will select images.



- [!] may be displayed on the camera to warn you that the memory card has print settings that were configured on another camera. Changing the print settings using this camera may overwrite all previous settings.

Adding Images Individually

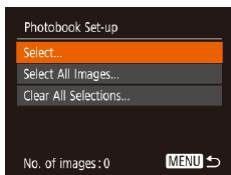

1 Choose [Select].

- Following the procedure in “Choosing a Selection Method” (133), choose [Select] and press the [OK] button.



2 Choose an image.

- Press the [◀][▶] buttons to choose an image, and then press the [OK] button.
- [✓] is displayed.
- To remove the image from the photobook, press the [OK] button again. [✓] is no longer displayed.
- Repeat this process to specify other images.
- When finished, press the [MENU] button to return to the menu screen.

Adding All Images to a Photobook

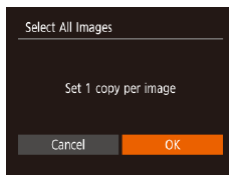

- Following the procedure in “Choosing a Selection Method” (133), choose [Select All Images] and press the [OK] button.
- Press the [◀][▶] buttons to choose [OK], and then press the [OK] button.

Removing All Images from a Photobook

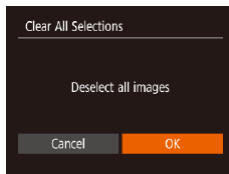

- Following the procedure in “Choosing a Selection Method” (133), choose [Clear All Selections] and press the [OK] button.
- Press the [◀][▶] buttons to choose [OK], and then press the [OK] button.

Before Use

Basic Guide

Advanced Guide

Camera Basics

Auto Mode /
Hybrid Auto Mode

Other Shooting Modes

P Mode

Playback Mode

Wi-Fi Functions

Setting Menu

Accessories

Appendix

Index



Appendix

Helpful information when using the camera

Troubleshooting

If you think there is a problem with the camera, first check the following. If the items below do not solve your problem, contact a Canon Customer Support Help Desk.

Power

Nothing happens when the power button is pressed.

- Confirm that the battery pack is charged (📖16).
- Confirm that the battery pack is inserted facing the correct way (📖16).
- Confirm that the memory card/battery cover is fully closed (📖16).
- Dirty battery terminals reduce battery performance. Try cleaning the terminals with a cotton swab and reinserting the battery pack a few times.

The battery pack runs out of power quickly.

- Battery performance decreases at low temperatures. Try warming the battery pack a little by putting it in your pocket, for example, ensuring that the terminals do not touch any metal objects.
- Dirty battery terminals reduce battery performance. Try cleaning the terminals with a cotton swab and reinserting the battery pack a few times.
- If these measures do not help and the battery pack still runs out of power soon after charging, it has reached the end of its life. Purchase a new battery pack.

The lens is not retracted.

- Do not open the memory card/battery cover while the camera is on. Close the cover, turn the camera on, and then turn it off again (📖16).

The battery pack is swollen.

- Battery swelling is normal and does not pose any safety concerns. However, if battery swelling prevents the battery pack from fitting in the camera, contact a Canon Customer Support Help Desk.

Display on a TV

Camera images look distorted or are not displayed on a TV (📖123).

Before Use

Basic Guide

Advanced Guide

Camera Basics

Auto Mode /
Hybrid Auto Mode

Other Shooting Modes

P Mode

Playback Mode

Wi-Fi Functions

Setting Menu

Accessories

Appendix

Index



Shooting

Cannot shoot.

- In Playback mode (📖64), press the shutter button halfway (📖23).

Strange display on the screen under low light (📖24).

Strange display on the screen when shooting.

- Note that the following display problems are not recorded in still images but are recorded in movies.
 - The screen may flicker and horizontal banding may appear under fluorescent or LED lighting.

No date stamp is added to images.

- Configure the [Date Stamp] (📖) setting (📖37). Note that date stamps are not added to images automatically, merely because you have configured the [Date/Time] setting (📖17).
- Date stamps are not added in shooting modes (📖145) in which [Date Stamp] (📖) cannot be configured (📖37).

⚡ flashes on the screen when the shutter button is pressed, and shooting is not possible (📖31).

📷 is displayed when the shutter button is pressed halfway (📖31).

- Set [IS Mode] to [Continuous] (📖41).
- Set the flash mode to ⚡ (📖62).
- Increase the ISO speed (📖55).
- Mount the camera on a tripod or take other measures to keep it still. Additionally, you should set [IS Mode] to [Off] when using a tripod or other means to secure the camera (📖41).

Shots are out of focus.

- Press the shutter button halfway to focus on subjects before pressing it all the way down to shoot (📖23).
- Make sure subjects are within focusing range (📖150).
- Set [AF-assist Beam] to [On] (📖42).
- Confirm that unneeded functions such as macro are deactivated.

No AF frames are displayed and the camera does not focus when the shutter button is pressed halfway.

- To have AF frames displayed and the camera focus correctly, try composing the shot with higher-contrast subject areas centered before you press the shutter button halfway. Otherwise, try pressing the shutter button halfway repeatedly.

Subjects in shots look too dark.

- Set the flash mode to ⚡ (📖62).
- Adjust brightness by using exposure compensation (📖54).
- Adjust contrast by using i-Contrast (📖55, 📖81).
- Use spot metering (📖54).

Subjects look too bright, highlights are washed-out.

- Set the flash mode to ☀️ (📖37).
- Adjust brightness by using exposure compensation (📖54).
- Use spot metering (📖54).
- Reduce the lighting on subjects.

Shots look too dark despite the flash firing (📖31).

- Shoot within flash range (📖149).
- Increase the ISO speed (📖55).

Subjects in flash shots look too bright, highlights are washed-out.

- Shoot within flash range (📖149).
- Set the flash mode to ☀️ (📖37).

White spots appear in flash shots.

- This is caused by light from the flash reflecting off dust or airborne particles.

Shots look grainy.

- Lower the ISO speed (📖55).
- High ISO speeds in some shooting modes may cause grainy images (📖46).

Subjects are affected by red-eye.

- Set [Red-Eye Lamp] to [On] (📖42) to light the red-eye reduction lamp (📖4) for flash shots. Note that while the red-eye reduction lamp is lit (for about one second), it is not possible to shoot, because the lamp is counteracting red-eye. For best results, have subjects look at the red-eye reduction lamp. Also try increasing the lighting in indoor scenes and shooting at closer range.
- Edit images using red-eye correction (📖81).

Recording to the memory card takes too long, or continuous shooting is slower.

- Use the camera to perform low-level formatting of the memory card (📖118).

Shooting settings or FUNC. menu settings are not available.

- Available setting items vary by shooting mode. Refer to "Functions Available in Each Shooting Mode", "FUNC. Menu", and "Shooting Tab" (📖142 – 📖145).

Before Use

Basic Guide

Advanced Guide

Camera Basics

Auto Mode /
Hybrid Auto Mode

Other Shooting Modes

P Mode

Playback Mode

Wi-Fi Functions

Setting Menu

Accessories

Appendix

Index



Shooting Movies

The elapsed time shown is incorrect, or recording is interrupted.

- Use the camera to format the memory card, or switch to a card that supports high-speed recording. Note that even if the elapsed time display is incorrect, the length of movies on the memory card corresponds to the actual recording time (📖117, 📖151).

[!] is displayed and shooting stops automatically.

- The camera's internal memory buffer filled up as the camera could not record to the memory card quickly enough. Try one of the following measures.
 - Use the camera to perform low-level formatting of the memory card (📖118).
 - Lower the image quality (📖39).
 - Switch to a memory card that supports high-speed recording (📖151).

Zooming is not possible.

- Zooming is not possible when shooting movies in **[📷]** mode (📖48).

Subjects look distorted.

- Subjects that pass in front of the camera quickly may look distorted. This is not a malfunction.

Playback

Playback is not possible.

- Image or movie playback may not be possible if a computer is used to rename files or alter the folder structure.

Playback stops, or audio skips.

- Switch to a memory card that you have performed low-level formatting on with the camera (📖118).
- There may be brief interruptions when playing movies copied to memory cards that have slow read speeds.
- When movies are played on a computer, frames may be dropped and audio may skip if computer performance is inadequate.

Sound is not played during movies.

- Adjust the volume (📖114) if you have activated **[Mute]** (📖114) or the sound in the movie is faint.
- No sound is played for movies shot in **[📷]** mode (📖48) because audio is not recorded in this mode.

Cannot access the Story Highlights home screen by pressing the **[▲]** button.

- Home screen display is not possible when connected to a printer. Disconnect the camera from the printer.
- Home screen display is not possible during Wi-Fi connections. End the Wi-Fi connection.

Memory Card

The memory card is not recognized.

- Restart the camera, with the memory card in it (📖22).

Computer

Cannot transfer images to a computer.

- When attempting to transfer images to the computer via a cable, try reducing the transfer speed as follows.
 - Press the **[▶]** button to enter Playback mode. Hold the **[MENU]** button down as you press the **[▲]** and **[📷]** buttons at the same time. On the next screen, press the **[◀][▶]** buttons to choose **[B]**, and then press the **[📷]** button.

Before Use

Basic Guide

Advanced Guide

Camera Basics

Auto Mode /
Hybrid Auto Mode

Other Shooting Modes

P Mode

Playback Mode

Wi-Fi Functions

Setting Menu

Accessories

Appendix

Index

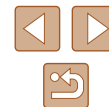

Wi-Fi

Cannot access the Wi-Fi menu by pressing the **[Wi-Fi]** button.

- The Wi-Fi menu cannot be accessed while the camera is connected to a printer or computer via a cable. Disconnect the cable.

Cannot add a device/destination.

- A total of 20 items of connection information can be added to the camera. Erase unneeded connection information from the camera first, and then add new devices/destinations (111).
- Use a computer or smartphone to register Web services (99).
- To add a smartphone, first install the dedicated application Camera Connect on your smartphone (88).
- To add a computer, first install the software CameraWindow on your computer. Also check your computer and Wi-Fi environment and settings (94, 95).
- Do not use the camera near sources of Wi-Fi signal interference, such as microwave ovens, Bluetooth devices, or other equipment operating on the 2.4 GHz band.
- Bring the camera closer to the other device you are trying to connect to (such as the access point), and make sure there are no objects between the devices.

Cannot connect to the access point.

- Confirm that the access point channel is set to a channel supported by the camera (149). Note that instead of auto channel assignment, it is advisable to specify a supported channel manually.

Cannot send images.

- The destination device has insufficient storage space. Increase the storage space on the destination device and resend the images.
- The write-protect switch of the memory card in the destination camera is set to the locked position. Slide the write-protect switch to the unlocked position.
- Images are not sent to CANON iMAGE GATEWAY or other Web services if you move or rename image files or folders on the computer that received images sent using Image Sync via an access point (108). Before moving or renaming these image files or folders on the computer, make sure the images have already been sent to CANON iMAGE GATEWAY or other Web services.

Cannot resize images for sending.

- Images cannot be resized to be bigger than the recording pixel setting of their original size.
- Movies cannot be resized.

Images take a long time to send./The wireless connection is disrupted.

- Multiple images may take a long time to send. Try resizing the image to reduce sending time (107).
- Movies may take a long time to send.
- Do not use the camera near sources of Wi-Fi signal interference, such as microwave ovens, Bluetooth devices, or other equipment operating on the 2.4 GHz band. Note that images may take a long time to send even when **[Wi-Fi]** is displayed.
- Bring the camera closer to the other device you are trying to connect to (such as the access point), and make sure there are no objects between the devices.

No notification message is received on a computer or smartphone after adding CANON iMAGE GATEWAY to the camera.

- Make sure the email address you entered is correct, and try adding the destination again.
- Check the email settings on the computer or smartphone. If they are configured to block email from certain domains, you may not be able to receive the notification message.

Want to erase Wi-Fi connection information before disposing of the camera or giving it to someone else.

- Reset the Wi-Fi settings (113).

Before Use
Basic Guide
Advanced Guide
Camera Basics
Auto Mode / Hybrid Auto Mode
Other Shooting Modes
P Mode
Playback Mode
Wi-Fi Functions
Setting Menu
Accessories
Appendix
Index

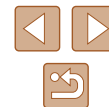

On-Screen Messages

If an error message is displayed, respond as follows.

Shooting or Playback

No memory card

- The memory card may be inserted facing the wrong way. Reinsert the memory card facing the correct way (16).

Memory card locked

- The write-protect switch of the memory card is set to the locked position. Switch the write-protect switch to the unlocked position (16).

Cannot record!

- Shooting was attempted without a memory card in the camera. To shoot, insert a memory card facing the correct way (16).

Memory card error (118)

- If the same error message is displayed even after you have formatted a supported memory card (2) and have inserted it facing the correct way (16), contact a Canon Customer Support Help Desk.

Insufficient space on card

- There is not enough free space on the memory card to shoot (28, 44, 53) or edit images (79). Either erase unneeded images (74) or insert a memory card with enough free space (16).

Charge the battery (16)

No Image.

- The memory card does not contain any images that can be displayed.

Protected! (72)

Unidentified Image/Incompatible JPEG/Image too large./Cannot play back MOV

- Unsupported or corrupt images cannot be displayed.
- It may not be possible to display images that were edited or renamed on a computer, or images shot with another camera.

Cannot magnify!/Cannot play back this content in Smart Shuffle/Cannot rotate/Cannot modify image/Cannot modify/Unselectable image.

- The following functions may be unavailable for images that were renamed or already edited on a computer, or images shot with another camera. Note that starred (*) functions are not available for movies. Magnify* (70), Smart Shuffle* (71), Rotate* (76), Favorites (78), Edit* (79), Print List* (131), and Photobook Set-up* (133).

Invalid selection range

- When specifying a range for image selection (73, 76, 132), you attempted to choose an initial image that was after the final image, or vice-versa.

Exceeded selection limit

- More than 998 images were selected for Print List (131) or Photobook Set-up (133). Choose 998 images or less.
- Print List (131) or Photobook Set-up (133) settings could not be saved correctly. Reduce the number of selected images and try again.
- You attempted to choose more than 500 images in Protect (72), Erase (74), Favorites (78), Print List (131), or Photobook Set-up (133).

Naming error!

- The folder could not be created or images could not be recorded, because the highest supported folder number (999) for storing images on the card has been reached and the highest supported image number (9999) for images in folders has been reached. On the (F) tab, change [File Numbering] to [Auto Reset] (118), or format the memory card (117).

Lens Error

- This error may occur if the lens is held while it is moving, or when the camera is used in dusty or sandy locations.
- Frequent display of this error message may indicate camera damage. In this case, contact a Canon Customer Support Help Desk.

A camera error was detected (*error number*)

- If this error message is displayed immediately after a shot, the image may not have been saved. Switch to Playback mode to check for the image.
- Frequent display of this error message may indicate camera damage. In this case, write down the error number (*Exx*) and contact a Canon Customer Support Help Desk.

Before Use

Basic Guide

Advanced Guide

Camera Basics

Auto Mode /
Hybrid Auto Mode

Other Shooting Modes

P Mode

Playback Mode

Wi-Fi Functions

Setting Menu

Accessories

Appendix

Index



File Error

- Correct printing (📖127) may not be possible for photos from other cameras or images that have been altered using computer software, even if the camera is connected to the printer.

Print error

- Check the paper size setting (📖129). If this error message is displayed when the setting is correct, restart the printer and complete the setting on the camera again.

Ink absorber full

- Contact a Canon Customer Support Help Desk to request assistance with ink absorber replacement.

Wi-Fi

Connection failed

- No access points were recognized. Check the access point settings (📖95).
- A device could not be found. Turn the camera off and on again, and retry the connection.
- Check the device you want to connect to and make sure it is ready for connection.

Cannot determine access point

- The WPS buttons on numerous access points were pressed simultaneously. Try reconnecting again.

No access points found

- Check to make sure that the access point is turned on.
- When connecting to an access point manually, make sure that you entered the correct SSID.

Incorrect password/Incorrect Wi-Fi security settings

- Check the access point security settings (📖95).

IP address conflict

- Reset the IP address so that it does not conflict with another.

Disconnected/Receiving failed/Sending failed

- You may be in an environment where Wi-Fi signals are obstructed.
- Avoid using the camera's Wi-Fi function around microwave ovens, Bluetooth devices, and other devices that operate on the 2.4 GHz band.
- Bring the camera closer to the other device you are trying to connect to (such as the access point), and make sure there are no objects between the devices.
- Check the connected device to make sure it is not experiencing errors.

Sending failed

Memory card error

- If the same error message is displayed even when you have inserted a formatted memory card facing the correct way, contact a Canon Customer Support Help Desk.

Receiving failed

Insufficient space on card

- There is not enough free space on the memory card in the target camera to receive images. Erase images to create space on the memory card, or insert a memory card with sufficient space.

Receiving failed

Memory card locked

- The write-protect switch of the memory card in the camera to receive the images is set to the locked position. Slide the write-protect switch to the unlocked position.

Receiving failed

Naming error!

- When the highest folder number (999), and the highest image number (9999) have been reached on the receiving camera, images cannot be received.

Insufficient space on server

- Delete unnecessary images uploaded to CANON iMAGE GATEWAY to create space.
- Save the images sent via Image Sync (📖108) to your computer.

Check network settings

- Check to make sure your computer can connect to the Internet with the current network settings.

Before Use

Basic Guide

Advanced Guide

Camera Basics

Auto Mode / Hybrid Auto Mode

Other Shooting Modes

P Mode

Playback Mode

Wi-Fi Functions

Setting Menu

Accessories

Appendix

Index

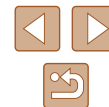

On-Screen Information

Shooting (Information Display)

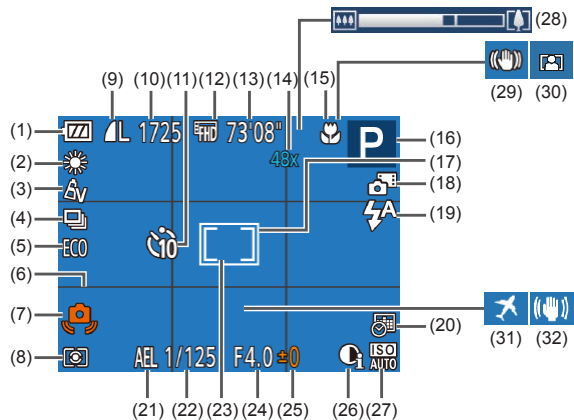

- (1) Battery level (140)
- (2) White balance (56)
- (3) My Colors (56)
- (4) Drive mode (38)
- (5) Eco mode (116)
- (6) Grid lines (40)
- (7) Camera shake warning (31)
- (8) Metering method (54)
- (9) Still image compression (63), Recording pixel setting (39)
- (10) Recordable shots (151)*
- (11) Self-timer (36)
- (12) Movie quality (39)
- (13) Remaining time (151)
- (14) Zoom magnification (34), Digital tele-converter (59)
- (15) Focus range (58)
- (16) Shooting mode (142), Scene icon (32)
- (17) AF frame (59)
- (18) Hybrid Auto mode (30)
- (19) Flash mode (62)

- (20) Date stamp (37)
- (21) AE lock (54)
- (22) Shutter speed
- (23) Spot AE point frame (54)
- (24) Aperture value
- (25) Exposure compensation level (54)
- (26) i-Contrast (55)
- (27) ISO speed (55)
- (28) Zoom bar (28)
- (29) IS mode icon (33)
- (30) Auto Zoom (35)
- (31) Time zone (115)
- (32) Image stabilization (41)

* In [] mode, indicates the number of shots available.

Battery Level

An on-screen icon or message indicates the battery charge level.

Display	Details
	Sufficient charge
	Slightly depleted, but sufficient
	Nearly depleted—charge the battery pack soon
[Charge the battery]	Depleted—charge the battery pack immediately

- Before Use
- Basic Guide
- Advanced Guide
 - Camera Basics
 - Auto Mode / Hybrid Auto Mode
 - Other Shooting Modes
 - P Mode
 - Playback Mode
 - Wi-Fi Functions
 - Setting Menu
 - Accessories
 - Appendix
- Index



Playback (Detailed Information Display)

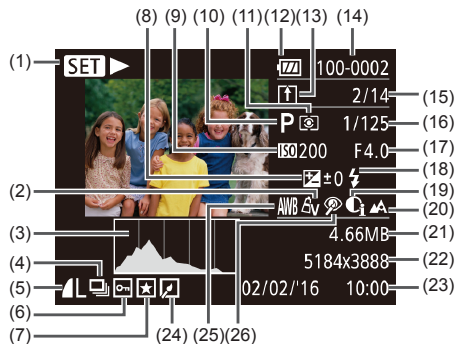

- | | |
|---|---|
| (1) Movie playback (📖64), Linked digest movie playback (📖67), Group playback (📖69) | (12) Battery level (📖140) |
| (2) My Colors (📖56), Creative Shot effect (📖44) | (13) Image Sync (📖108) |
| (3) Histogram (📖66) | (14) Folder number - File number (📖118) |
| (4) Group playback (📖69), Digest movies (📖66) | (15) Current image no. / Total no. of images |
| (5) Compression (image quality) (📖63) / Recording pixel setting (📖39), MP4 (movies) | (16) Shutter speed (still images), Image quality / Frame rate (movies) (📖39) |
| (6) Protection (📖72) | (17) Aperture value |
| (7) Favorites (📖78) | (18) Flash (📖62) |
| (8) Exposure compensation level (📖54) | (19) i-Contrast (📖55, 📖81) |
| (9) ISO speed (📖55), Playback speed (📖48) | (20) Focus range (📖58) |
| (10) Shooting mode (📖142) | (21) File size |
| (11) Metering method (📖54) | (22) Still images: Recording pixel setting (📖151)
Movies: Playback time (📖151) |
| | (23) Shooting date/time (📖17) |

(24) Image editing (📖79)

(26) Red-eye correction (📖81)

(25) White balance (📖56)



- Some information may not be displayed when viewing images on a TV (📖123).

Summary of Movie Control Panel

The following operations are available on the movie control panel, accessed as described in "Viewing" (📖64).

	Exit
	Play
	Slow Motion (Press the [◀][▶] buttons to adjust the playback speed. No sound is played.)
	Skip Backward* or Previous Clip (📖83) (To continue skipping backward, keep holding down the [📄] button.)
	Previous Frame (For fast-rewind, keep holding down the [📄] button.)
	Next Frame (For fast-forward, keep holding down the [📄] button.)
	Skip Forward* or Next Clip (📖83) (To continue skipping forward, keep holding down the [📄] button.)
	Erase Clip (displayed when a digest movie is selected, 📖83)
	Edit (📖82)
	Shown when the camera is connected to a PictBridge-compatible printer (📖127).

* Displays the frame approx. 4 sec. before or after the current frame.



- During movie playback, you can skip back or forward (or to the previous or next clip) by pressing the [◀][▶] buttons.

Before Use

Basic Guide

Advanced Guide

Camera Basics

Auto Mode / Hybrid Auto Mode

Other Shooting Modes

P Mode

Playback Mode

Wi-Fi Functions

Setting Menu

Accessories

























Appendix

Index



Functions and Menu Tables

Functions Available in Each Shooting Mode

Function	Shooting Mode																			
			AUTO	P																
Exposure Compensation (📖54)	–	–	–	○	○	○	○	○	○	○	○	○	○	○	○	○	○	○	○	○
Flash (📖62)																				
	○	○	○	○	○	○	○	○	–	○	○	○	○	○	○	○	○	○	○	–
	–	–	–	○	○	○	○	○	–	○	–	○	○	○	○	○	○	○	○	–
	*1	–	*1	○	–	–	–	–	–	*1	–	–	–	–	–	–	–	–	–	–
	○	○	○	○	○	○	○	○	○	○	○	○	○	○	○	○	○	○	○	○
Focus Range (📖58)																				
	○	○	○	○	○	○	○	○	○	○	○	○	○	○	○	○	○	○	○	○
	–	–	–	○	○	–	–	–	○	○	○	○	○	○	○	○	○	○	○	–
Tracking AF Subject Selection (📖60)	–	–	–	○	○	–	–	–	○	–	○	–	–	–	○	○	○	○	○	–
Change Shooting Display (📖24)	○	–	○	○	○	–	–	–	○	○	○	–	–	–	○	○	○	○	○	○

*1 Not available, but switches to  in some cases.

○ Available or set automatically. – Not available.

- Before Use
- Basic Guide
- Advanced Guide
 - Camera Basics
 - Auto Mode / Hybrid Auto Mode
 - Other Shooting Modes
 - P Mode
 - Playback Mode
 - Wi-Fi Functions
 - Setting Menu
 - Accessories
 - Appendix
 - Index

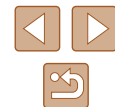

FUNC. Menu

		Shooting Mode																			
Function																					
Light Metering (📖54)																					
		○	○	○	○	○	○	○	○	○	○	○	○	○	○	○	○	○	○	○	○
		-	-	-	○	-	-	-	-	-	-	-	-	-	-	-	-	-	-	-	-
My Colors (📖56)																					
		○	○	○	○	○	○	○	○	○	○	○	○	○	○	○	○	○	○	○	○
	△ V △ W △ Se*1 △ W*1 △ P △ L △ D △ B △ G △ R △ C*2	-	-	-	○	-	○	○	○	-	-	-	-	-	-	-	-	-	-	-	-
White Balance (📖56)																					
		○	○	○	○	○	○	○	○	○	○	○	○	○	○	○	○	○	○	○	○
		-	-	-	○	-	○	○	○	○	-	○	-	-	-	-	-	-	-	-	○
ISO Speed (📖55)																					
	AUTO	○	○	○	○	○	○	○	○	○	○	○	○	○	○	○	○	○	○	○	○
	80 / 100 / 200 / 400 / 800 / 1600 / 3200	-	-	-	○	-	-	-	-	-	-	-	-	-	-	-	-	-	-	-	-
Self-Timer (📖36)																					
		○	○	○	○	○	○	○	○	○	○	○	○	○	○	○	○	○	○	○	○
		○	○	○	○	○	-	-	-	-	○	○	○	○	○	○	○	○	○	○	○
Self-Timer Settings (📖36)																					
	Delay*3	○	○	○	○	○	-	-	-	-	○	○	○	○	○	○	○	○	○	○	○
	Shots*4	-	-	○	○	○	-	-	-	-	○	○	○	○	○	○	○	○	○	○	○
Drive Mode (📖38)																					
		○	○	○	○	○	○	○	○	-	○	○	○	○	○	○	○	○	○	○	○
		-	-	○	○	○	-	-	-	○	-	○	○	○	○	○	○	○	○	○	-

*1 White balance is not available.

*2 Set in a range of 1 – 5: contrast, sharpness, color saturation, red, green, blue, and skin tone.

*3 Cannot be set to 0 seconds in modes without selection of the number of shots.

*4 One shot (cannot be modified) in modes without selection of the number of shots.

○ Available or set automatically. – Not available.

- Before Use
- Basic Guide
- Advanced Guide
 - Camera Basics
 - Auto Mode / Hybrid Auto Mode
 - Other Shooting Modes
 - P Mode
 - Playback Mode
 - Wi-Fi Functions
 - Setting Menu
 - Accessories
 - Appendix
- Index



Shooting Mode																			
Function																			
Still Image Aspect Ratio (38)	16:9 3:2 4:3 1:1	-	-	○	○	○	○	○	○	-	-	-	-	*1	-	○	○	○	○
Recording pixels (39)	L	○	○	○	○	○	○	○	○	-	○	-	○	○	○	○	○	○	○
	M1 M2	-	-	○	○	○	○	○	○	-	-	-	-	-	-	-	-	-	○
	M	-	-	-	-	-	-	-	○	-	○	-	-	-	-	-	-	-	-
	S	-	-	○	○	○	○	○	○	-	-	-	-	-	-	-	-	-	○
Compression (63)		-	-	-	○	-	-	-	-	-	-	-	-	-	-	-	-	-	-
		○	○	○	○	○	○	○	○	○	○	○	○	○	○	○	○	○	○
Movie Quality (39)	FRD	○	○	○	○	○	○	○	○	○	○	○	○	-	○	○	○	○	○
	HD EVGA	○	○	○	○	○	○	○	○	○	○	○	○	*2	○	○	○	○	○
Auto Zoom (35)		○	-	○	-	-	-	-	-	-	-	-	-	-	-	-	-	-	-

*1 Only [4:3] and [16:9] are available.

*2 Synchronizes with the aspect ratio setting and is automatically set (48).

○ Available or set automatically. - Not available.

- Before Use
- Basic Guide
- Advanced Guide
 - Camera Basics
 - Auto Mode / Hybrid Auto Mode
 - Other Shooting Modes
 - P Mode
 - Playback Mode
 - Wi-Fi Functions
 - Setting Menu
 - Accessories
 - Appendix
- Index



Shooting Tab

		Shooting Mode										Camera Mode									
		📷	📷	AUTO	P	📷	📷	📷	📷	📷	📷	📷	📷	📷	📷	📷	📷	📷	📷	📷	
Function																					
AF Frame Size (📖59)																					
Face AiAF		○	○	○	○	○	○	○	○	○	○	○	○	○	○	○	○	○	○	○	
Tracking AF		-	-	-	○	○	-	-	-	○	-	○	-	-	-	○	○	○	-	○	
Center		-	-	-	○	○	-	-	-	○	-	○	○	-	○	○	○	○	○	○	
AF Frame Size (📖59)*1																					
Normal		-	-	-	○	○	-	-	-	○	-	○	○	-	○	○	○	○	-	○	
Small		-	-	-	○	○	-	-	-	○	-	○	-	-	○	○	○	○	-	○	
Digital Zoom (📖34)																					
Standard		○	-	○	○	○	○	○	○	-	-	-	-	-	-	-	-	-	○	○	
Off		○	○	○	○	○	○	○	○	○	○	○	○	○	○	○	○	○	○	○	
1.6x/2.0x		-	-	-	○	-	-	-	-	-	-	-	-	-	-	-	-	-	-	-	
AF-Point Zoom (📖40)																					
On		-	○	○	○	○	○	○	○	○	-	○	-	-	-	○	○	○	-	○	
Off		○	○	○	○	○	○	○	○	○	○	○	○	○	○	○	○	○	○	○	
Servo AF (📖61)																					
On		-	-	-	○	○	-	-	-	-	-	○	-	-	-	○	○	○	-	-	
Off		○	○	*2	○	○	○	○	○	○	○	○	○	○	○	○	○	○	○	○	
Continuous AF (📖62)																					
On		○	○	○	○	○	○	○	○	○	○	-	○	○	○	○	○	○	-	○	
Off		-	-	-	○	○	-	-	-	-	○	○	○	○	○	○	○	○	○	○	

*1 Available when the AF frame is set to [Center].

*2 [On] when subject movement is detected in [AUTO] mode.

○ Available or set automatically. - Not available.

Before Use

Basic Guide

Advanced Guide

Camera Basics

Auto Mode /
Hybrid Auto Mode

Other Shooting Modes

P Mode

Playback Mode

Wi-Fi Functions

Setting Menu

Accessories

Appendix

Index



Shooting Mode				AUTO	P														
Function																			
AF-assist Beam (42)																			
On		O	O	O	O	O	O	O	O	O	O	O	O	O	O	O	O	O	O
Off		O	O	O	O	O	-	O	O	O	O	O	O	O	O	O	O	O	O
Flash Settings (42)																			
Red-Eye Lamp	On/Off	O	O	O	O	O	O	O	-	O	O	O	O	O	O	O	O	O	O
i-Contrast (55)																			
Auto		O	-	O	O	-	-	-	-	O	-	O	-	-	-	-	-	-	-
Off		-	O	-	O	O	O	O	O	-	O	-	O	O	O	O	O	O	O
Review image after shooting (43)																			
Display Time	Off/Quick	O	-	O	O	O	O	O	O	O	O	O	O	O	O	O	O	O	O
	2 sec./4 sec./8 sec./Hold	O	O	O	O	O	O	O	O	O	O	O	O	O	O	O	O	O	O
Display Info	Off	O	O	O	O	O	O	O	O	O	O	O	O	O	O	O	O	O	O
	Detailed	O	-	O	O	O	O	O	O	O	O	O	O	O	O	O	O	O	O
Grid Lines (40)																			
On/Off		O	O	O	O	O	O	O	O	O	O	O	O	O	O	O	O	O	O
IS Settings (41)																			
IS Mode	Off	O	O	O	O	O	O	O	O	-	O	O	O	O	O	O	O	O	O
	Continuous	O	O	O	O	O	O	O	O	O	O	O	O	O	O	O	O	O	O
	Shoot Only	-	-	-	O	O	O	O	O	-	O	O	O	O	O	O	O	O	O
Dynamic IS	1	O	O	O	O	O	O	O	O	O	O	-	O	O	O	O	O	O	O
	2	O	O	O	O	O	O	O	O	O	-	O	O	O	O	O	O	O	O
Date Stamp (37)																			
Off		O	O	O	O	O	O	O	O	O	O	O	O	O	O	O	O	O	O
Date/Date & Time		O	-	O	O	O	O	O	O	-	-	-	-	-	-	-	-	-	O
Digest Type (30)																			
Include Stills/No Stills		O	-	-	-	-	-	-	-	-	-	-	-	-	-	-	-	-	-

O Available or set automatically. - Not available.

- Before Use
- Basic Guide
- Advanced Guide
 - Camera Basics
 - Auto Mode / Hybrid Auto Mode
 - Other Shooting Modes
 - P Mode
 - Playback Mode
 - Wi-Fi Functions
 - Setting Menu
 - Accessories
 - Appendix
- Index



Set Up Tab

Item	Reference Page
Mute	114
Volume	114
Hints & Tips	115
Date/Time	17
Time Zone	115
Lens Retraction	116
Eco Mode	116
Power Saving	23, 116
Disp. Brightness	117
Start-up Image	117
Format	117
File Numbering	118
Create Folder	119
Units	119
Video System	123
Wireless settings	87
Certification Logo Display	119
Language	19
Reset All	120

Playback Tab

Item	Reference Page
Album Playback	84
List/Play Digest Movies	67
Slideshow	70
Erase	74
Protect	72
Rotate	76
Favorites	78
Photobook Set-up	133
i-Contrast	81
Red-Eye Correction	81
Cropping	79
Resize	79
My Colors	80
Transition	64
Scroll Display	64
Group Images	69
Auto Rotate	77
Resume	64

Before Use

Basic Guide

Advanced Guide

Camera Basics

Auto Mode /
Hybrid Auto Mode

Other Shooting Modes

P Mode

Playback Mode

Wi-Fi Functions

Setting Menu

Accessories

Appendix

Index



Print Tab

Item	Reference Page
Print	–
Select Images & Qty.	📖 131
Select Range	📖 132
Select All Images	📖 132
Clear All Selections	📖 132
Print Settings	📖 131

Playback Mode FUNC. Menu

Item	Reference Page
Rotate	📖 76
Protect	📖 72
Favorites	📖 78
Erase	📖 74
Print	📖 127
Group Playback	📖 69
Play Movie	📖 64
Play Linked Digest Movie	📖 67
Smart Shuffle	📖 71
Image Search	📖 68
Slideshow	📖 70

Handling Precautions

- The camera is a high-precision electronic device. Avoid dropping it or subjecting it to strong impact.
- Never bring the camera near magnets, motors, or other devices that generate strong electromagnetic fields, which may cause malfunction or erase image data.
- If water droplets or dirt adheres to the camera or screen, wipe with a dry soft cloth, such as an eyeglass cloth. Do not rub hard or apply force.
- Never use cleaners containing organic solvents to clean the camera or screen.
- Use a blower brush to remove dust from the lens. If cleaning is difficult, contact a Canon Customer Support Help Desk.
- To prevent condensation from forming on the camera after sudden temperature changes (when the camera is transferred from cold to warm environments), put the camera in an airtight, resealable plastic bag and let it gradually adjust to the temperature before removing it from the bag.
- If condensation does form on the camera, stop using it immediately. Continuing to use the camera in this state may damage it. Remove the battery pack and memory card, and wait until the moisture has evaporated before resuming use.
- Store unused battery packs in a plastic bag or other container. To maintain battery performance if you will not use the battery pack for some time, about once a year charge it and then use the camera until it runs out of power before storing the battery pack.

Before Use

Basic Guide

Advanced Guide

Camera Basics

Auto Mode /
Hybrid Auto Mode

Other Shooting Modes

P Mode

Playback Mode

Wi-Fi Functions

Setting Menu

Accessories

Appendix

Index



Specifications

Camera

Image Sensor

Camera Effective Pixels
(Image processing may cause
a decrease in the number of pixels.) Approx. 20.2 megapixels
Total Pixels Approx. 21.1 megapixels
Image Size 1/2.3 type

Lens

Focal Length
(35mm film equivalent) 4.5 – 54.0 mm (25 – 300 mm)
Zoom Magnification 12×

Digital Zoom

Magnification Approx. 4×
Max. Magnification
(digital x optical zoom) Approx. 48×
Focal Length
(max. telephoto, 35mm film equivalent) Equivalent to approx. 1200 mm

Screen (Monitor)

Type TFT color liquid crystal
Screen Size 3.0 type
Effective Pixels Approx. 461,000 dots

Continuous Shooting (CIPA compliant)

Speed
(Varies depending on the subject,
zoom position, and other shooting factors,
as well as memory card brands.) Normal Continuous Shooting in
Auto/P modes:
Approx. 2.5 shots/sec.
Normal Continuous High-Speed
Burst mode: Approx. 7.2 shots/sec.

Built-in Flash

Flash Range (Wide angle end) 50 cm – 4.0 m (1.6 – 13 ft.)
Flash Range (Telephoto end) 1.0 – 2.0 m (3.3 – 6.6 ft.)

Shutter Speed

Auto Mode (automatic settings) 1 – 1/2000 sec.
Range in all shooting modes
Max. 15 sec.
Min. 1/2000 sec.
Speed (unit: sec.) Long Shutter Mode
15, 13, 10, 8, 6, 5, 4, 3.2, 2.5, 2,
1.6, 1.3, 1

Aperture

F Number 3.6 / 10 (W)
7.0 / 20 (T)

AF

AF Frame Face Detect AiAF (number of AF
frames: max. 9), Tracking AF,
Center

File Format Design rule for Camera File
system (DCF) compliant; DPOF
(version 1.1) compatible

Data Type (Still Images)

Image File Format Exif 2.3 (DCF 2.0)
Image Type JPEG

Data Type (Movies)

Recording Format MP4
Video MPEG-4 AVC/H.264
Audio MPEG-4 AAC-LC (Monaural)

Power Supply

Battery Pack NB-11LH

Before Use

Basic Guide

Advanced Guide

Camera Basics

Auto Mode /
Hybrid Auto Mode

Other Shooting Modes

P Mode

Playback Mode

Wi-Fi Functions

Setting Menu

Accessories

Appendix

Index



Interface	
Wired	Hi-Speed USB (Mini-B) Analog Audio Output (Monaural) Analog Video Output (NTSC/PAL) HDMI (D-Type HDMI Connector)
Wireless	Wi-Fi Specifications: IEEE 802.11b/g/n Frequency: 2.4 GHz Channels: 1 – 11 Security: WEP, WPA-PSK (AES/ TKIP), WPA2-PSK (AES/TKIP) NFC
Operating Environment	
Temperatures	0 – 40 °C (32 – 104 °F)
Dimensions (CIPA compliant)	
(WxHxD)	99.6 x 58.0 x 22.8 mm (3.92 x 2.28 x 0.90 in.)
Weight (CIPA compliant)	
Including Battery Pack, Memory Card	Approx. 147 g (approx. 5.19 oz.)
Camera Body Only	Approx. 130 g (approx. 4.59 oz.)

Number of Shots/Recording Time, Playback Time

Number of Shots (CIPA compliant)	Approx. 180 shots
Number of Shots in Eco Mode	Approx. 265 shots
Movie Recording Time (CIPA compliant)*1	Approx. 40 minutes
Movie Recording Time (Continuous Shooting)*2	Approx. 1 hour, 10 minutes
Playback Time*3	Approx. 4 hours

*1 Total time when shooting repeatedly under the following conditions:



- In [AUTO] mode, with all other settings set to defaults
- With recording, stopping, zooming, and turning the camera on and off

*2 Total time when shooting repeatedly under the following conditions:

- In [AUTO] mode, with all other settings set to defaults
- Automatically stop/resume after the time or capacity per recording is reached

*3 Time when playing back a slideshow of still images.

Shooting Range

Shooting Mode	Focus Range	Maximum Wide Angle (AAA)	Maximum Telephoto (L)
AUTO	–	1 cm (0.4 in.) – infinity	1.0 m (3.3 ft.) – infinity
Other modes		5 cm (2.0 in.) – infinity	1.0 m (3.3 ft.) – infinity
		1 – 50 cm (0.4 in. – 1.6 ft.)	–
		3.0 m (9.8 ft.) – infinity	3.0 m (9.8 ft.) – infinity

Before Use

Basic Guide

Advanced Guide

Camera Basics

Auto Mode /
Hybrid Auto Mode

Other Shooting Modes

P Mode

Playback Mode

Wi-Fi Functions

Setting Menu

Accessories

Appendix









Index



Number of Shots per Memory Card



The number of shots at an aspect ratio (📖38) of 4:3 per memory card is as follows. Note that the number of shots available varies by aspect ratio.

Number of shots per 16 GB memory card (approx. shots)

L		1766
		2980
M1		3546
		5925
M2		9344
		16755
M		10798
S		53992
		80988

- The values in the table are based on Canon measurement conditions and may change depending on the subject, memory card and camera settings.

Recording Time per Memory Card

Pixels	Recording Time per 16 GB Memory Card (Approx.)	Single Clip Recording Time (Approx.)
 (1920 x 1080)	1 hr. 8 min. 34 sec.	29 min. 59 sec.
 (1280 x 720)	3 hr. 58 min. 1 sec.	29 min. 59 sec.
 (640 x 480)	8 hr. 25 min. 48 sec.	1 hr.

- The values in the table are based on Canon measurement conditions and may change depending on the subject, memory card and camera settings.
- Recording times for individual movies are based on memory cards rated at an SD speed class of 10. Recording may stop when cards rated at lower speed classes are used. Recording will also stop automatically when the file size reaches 4 GB, or when the card becomes full.

Before Use
Basic Guide
Advanced Guide
Camera Basics
Auto Mode / Hybrid Auto Mode
Other Shooting Modes
P Mode
Playback Mode
Wi-Fi Functions
Setting Menu
Accessories
Appendix
Index



Battery Pack NB-11LH

Type: Rechargeable lithium-ion battery
Nominal Voltage: 3.6 V DC
Nominal Capacity: 800 mAh
Charging Cycles: Approx. 300 times
Operating Temperatures: 0 – 40 °C (32 – 104 °F)

Battery Charger CB-2LF/CB-2LFE

Rated Input: 100 – 240 V AC (50/60 Hz)
Rated Output: 4.2 V DC, 0.41 A
Charging Time: Approx. 2 hours, 20 minutes
Operating Temperatures: 5 – 40 °C (41 – 104 °F)

- Size, weight, and number of shots available are based on measurement guidelines of the Camera & Imaging Products Association (CIPA).
- Under some shooting conditions, the number of shots and recording time may be less than mentioned above.
- Number of shots/time with a fully charged battery pack.

Before Use

Basic Guide

Advanced Guide

Camera Basics

Auto Mode /
Hybrid Auto Mode

Other Shooting Modes

P Mode

Playback Mode

Wi-Fi Functions

Setting Menu

Accessories

Appendix

Index



Index

A

Accessories 122
AE lock 54
AF frames 59
Aspect ratio 38
AUTO mode (shooting mode) 19, 28
AV cable 123, 124

B

Batteries → Date/time (date/time battery)
 Power saving 23
Battery charger 2, 122
Battery pack
 Charging 16
 Eco mode 116
 Level 140
 Power saving 23
Black and white images 57

C

Camera
 Reset all 120
Camera access point mode 93
Camera Connect 88
CameraWindow 94, 125
CANON iMAGE GATEWAY 87, 99
Center (AF frame mode) 61
Clock 27
Color (white balance) 56
Compression ratio (image quality) 63
Connecting via an access point 95

Continuous shooting
 High-speed burst (shooting mode) 52
Creative shot 44
Cropping 79, 129
Custom white balance 56

D

Date/time
 Adding date stamps 37
 Changing 18
 Date/time battery 18
 Settings 17
 World clock 115
Defaults → Reset all
Digital tele-converter 59
Digital zoom 34
Display language 19
DPOF 131

E

Eco mode 116
Editing
 Cropping 79
 i-Contrast 81
 My Colors 80
 Red-eye correction 81
 Resizing images 79
Editing or erasing connection information 111
Erasing 74
Error messages 138
Exposure
 Compensation 54

F

Face AiAF (AF frame mode) 59
Face self-timer (shooting mode) 51
Favorites 78
File numbering 118
Fireworks (shooting mode) 46
Fish-eye effect (shooting mode) 47
Flash
 Deactivating flash 37, 63
 On 62
 Slow synchro 62
Focusing
 AF frames 59
 AF-point zoom 40
 Servo AF 61
Focus lock 61
Focus range
 Macro 58
FUNC. menu
 Basic operations 24
 Table 143, 148

G

Grid lines 40

H

Handheld nightscene (shooting mode) 46
HDMI cable 123
High-speed burst (shooting mode) 52
Hybrid Auto (shooting mode) 30

I

i-Contrast 55, 81
Image quality → Compression ratio (image quality)

Images

 Display period 43
 Erasing 74
 Playback → Viewing
 Protecting 72
Image stabilization 41
Image Sync 108
Indicator 27
ISO speed 55

L

Lamp 42
Long shutter (shooting mode) 52
Low light (shooting mode) 46

M

Macro (focus range) 58
Magnified display 70
Memory cards 2
 Recording time 151
Menu
 Basic operations 25
 Table 142
Metering method 54
Miniature effect (shooting mode) 48
Monochrome (shooting mode) 49
Movies
 Editing 82
 Image quality (recording pixels/frame rate) 39
 Recording time 151
My Colors 56, 80

P

P (shooting mode) 53
Package contents 2
Photobook set-up 133
PictBridge 123, 127

Before Use
Basic Guide
Advanced Guide
Camera Basics
Auto Mode / Hybrid Auto Mode
Other Shooting Modes
P Mode
Playback Mode
Wi-Fi Functions
Setting Menu
Accessories
Appendix
Index

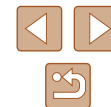

Playback → Viewing
Portrait (shooting mode) 46
Poster effect (shooting mode) 47
Power 122 → Battery charger,
→ Battery pack
Power saving 23
Printing 127
Program AE 53
Protecting 72

R
Recording pixels (image size) 39
Red-eye correction 81
Remote shooting 110
Reset all 120
Resizing images 79
Rotating 76

S
Saving images to a computer 94, 126
Screen
 Display language 19
 Icons 140, 141
 Menu → FUNC. menu, Menu
SD/SDHC/SDXC memory cards
→ Memory cards
Searching 68
Self-timer 36
 2-second self-timer 36
 Customizing the self-timer 36
 Face self-timer (shooting mode)
 51
 Wink self-timer (shooting mode)
 50

Sending images 105
Sending images to a computer 94
Sending images to another camera
104
Sending images to a printer 103
Sending images to a smartphone 88
Sending images to Web services 99
Sepia tone images 57
Servo AF 61
Shooting
 Shooting date/time → Date/time
 Shooting information 140
Slideshow 70
Smart Shuffle 71
Smart Shutter (shooting mode) 50
Smile (shooting mode) 50
Software
 Installation 94
 Saving images to a computer
 94, 126
Sounds 114
Story Highlights 84
Strap 2, 15
Super vivid (shooting mode) 47

T
Terminal 124, 127
Toy camera effect (shooting mode)
49
Tracking AF 60
Traveling with the camera 115
Troubleshooting 134
TV display 123

V
Viewing 21
 Image search 68
 Index display 67
 Magnified display 70
 Single-image display 21
 Slideshow 70
 Smart Shuffle 71
 TV display 123

W
White balance (color) 56
Wi-Fi functions 87
Wi-Fi menu 91
Wink self-timer (shooting mode) 50
World clock 115

Z
Zoom 20, 29, 34

Before Use
Basic Guide
Advanced Guide
Camera Basics
Auto Mode / Hybrid Auto Mode
Other Shooting Modes
P Mode
Playback Mode
Wi-Fi Functions
Setting Menu
Accessories
Appendix
Index



Wi-Fi (Wireless LAN) Precautions

- Countries and Regions Permitting WLAN Use
 - Use of WLAN is restricted in some countries and regions, and illegal use may be punishable under national or local regulations. To avoid violating WLAN regulations, visit the Canon website to check where use is allowed.
Note that Canon cannot be held liable for any problems arising from WLAN use in other countries and regions.
- Doing any of the following may incur legal penalties:
 - Altering or modifying the product
 - Removing the certification labels from the product
- According to foreign exchange and foreign trade law regulations, export permission (or service transaction permission) from the Japanese government is necessary to export strategic resources or services (including this product) outside Japan.
- Because this product includes American encryption software, it falls under U.S. Export Administration Regulations, and cannot be exported to or brought into a country under U.S. trade embargo.
- Be sure to make notes of the wireless LAN settings you use. The wireless LAN settings saved to this product may change or be erased due to incorrect operation of the product, the effects of radio waves or static electricity, or accident or malfunction. Be sure to make notes of wireless LAN settings as a precaution. Please note that Canon accepts no responsibility for direct or indirect damages or loss of earnings resulting from a degradation or disappearance of content.
- When transferring this product to another person, disposing of it, or sending it for repair, be sure to note the wireless LAN settings and reset the product to its default settings (erase settings) if necessary.
- Canon will not make compensation for damages resulting from loss or theft of the product.
Canon accepts no responsibility for damages or loss resulting from unauthorized access or use of target devices registered on this product due to loss or theft of the product.

- Be sure to use the product as directed in this guide. Be sure to use the wireless LAN function of this product within the guidelines noted in this guide. Canon accepts no responsibility for damages or loss if the function and product are used in ways other than as described in this guide.
- Do not use the wireless LAN function of this product near medical equipment or other electronic equipment. Use of the wireless LAN function near medical equipment or other electronic equipment may affect operation of those devices.

Radio Wave Interference Precautions

- This product may receive interference from other devices that emit radio waves. To avoid interference, be sure to use this product as far away as possible from such devices, or avoid using the devices at the same time as this product.

Security Precautions

Because Wi-Fi uses radio waves to transmit signals, security precautions more stringent than when using a LAN cable are required. Keep the following points in mind when using Wi-Fi.

- Only use networks you are authorized to use. This product searches for Wi-Fi networks in the vicinity and displays the results on the screen. Networks you are not authorized to use (unknown networks) may also be displayed. However, attempting to connect to or using such networks could be regarded as unauthorized access. Be sure to use only networks you are authorized to use, and do not attempt to connect to other unknown networks.

Before Use

Basic Guide

Advanced Guide

Camera Basics

Auto Mode /
Hybrid Auto Mode

Other Shooting Modes

P Mode

Playback Mode

Wi-Fi Functions

Setting Menu

Accessories

Appendix

Index



If security settings have not been properly set, the following problems may occur.

- **Transmission monitoring**
Third parties with malicious intent may monitor Wi-Fi transmissions and attempt to acquire the data you are sending.
- **Unauthorized network access**
Third parties with malicious intent may gain unauthorized access to the network you are using to steal, modify, or destroy information. Additionally, you could fall victim to other types of unauthorized access such as impersonation (where someone assumes an identity to gain access to unauthorized information) or springboard attacks (where someone gains unauthorized access to your network as a springboard to cover their tracks when infiltrating other systems).

To prevent these types of problems from occurring, be sure to thoroughly secure your Wi-Fi network.

Only use this camera's Wi-Fi function with a proper understanding of Wi-Fi security, and balance risk and convenience when adjusting security settings.



The camera can print to PictBridge-compatible printers via Wi-Fi. PictBridge technical standards make it easy to connect digital cameras, printers, and other devices directly. Additionally, a new standard called DPS over IP enables PictBridge connections in network environments, and the camera is also compatible with this standard.

Trademarks and Licensing

- Microsoft and Windows are trademarks or registered trademarks of Microsoft Corporation in the United States and/or other countries.
- Macintosh and Mac OS are trademarks of Apple Inc., registered in the U.S. and other countries.
- App Store, iPhone, and iPad are trademarks of Apple Inc.
- The SDXC logo is a trademark of SD-3C, LLC.
- HDMI, the HDMI logo and High-Definition Multimedia Interface are trademarks or registered trademarks of HDMI Licensing, LLC.
- Wi-Fi®, Wi-Fi Alliance®, WPA™, WPA2™ and Wi-Fi Protected Setup™ are trademarks or registered trademarks of the Wi-Fi Alliance.
- The N-Mark is a trademark or registered trademark of NFC Forum, Inc. in the United States and in other countries.
- All other trademarks are the property of their respective owners.
- This device incorporates exFAT technology licensed from Microsoft.
- This product is licensed under AT&T patents for the MPEG-4 standard and may be used for encoding MPEG-4 compliant video and/or decoding MPEG-4 compliant video that was encoded only (1) for a personal and non-commercial purpose or (2) by a video provider licensed under the AT&T patents to provide MPEG-4 compliant video. No license is granted or implied for any other use for MPEG-4 standard.

Before Use
Basic Guide
Advanced Guide
Camera Basics
Auto Mode / Hybrid Auto Mode
Other Shooting Modes
P Mode
Playback Mode
Wi-Fi Functions
Setting Menu
Accessories
Appendix
Index

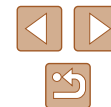

Disclaimer

- Unauthorized reproduction of this guide is prohibited.
- All measurements based on Canon testing standards.
- Information subject to change without notice, as are product specifications and appearance.
- Illustrations and screenshots in this guide may differ slightly from the actual equipment.
- The above items notwithstanding, Canon cannot be held liable for any loss arising from the use of this product.

Before Use

Basic Guide

Advanced Guide

Camera Basics

Auto Mode /
Hybrid Auto Mode

Other Shooting Modes

P Mode

Playback Mode

Wi-Fi Functions

Setting Menu

Accessories

Appendix

Index

