

**Canon**

**Exif Print**

**PictBridge**

Photo All-in-One

# **PIXMA MP960**

## **Quick Start Guide**



# Getting Help from Canon

## Help Us Help You Better

**Before you contact Canon, please record the following information.**

Serial Number (located on the inside of the product): \_\_\_\_\_

Model Number (located on the front of the product): \_\_\_\_\_

Setup CD-ROM number (located on the CD-ROM): \_\_\_\_\_

Purchase Date: \_\_\_\_\_

## Customer Technical Support Sequence\*

### 1. Internet — [www.canontechsupport.com](http://www.canontechsupport.com)

For quick and comprehensive self-help in an intuitively guided interactive troubleshooting environment, the place to start is our helpful tech support web site. In addition, the latest driver downloads, answers to frequently asked questions, product information, and “where to buy” instructions are found here.

### 2. Email Tech Support — [www.canontechsupport.com](http://www.canontechsupport.com)

For individual attention to a special issue, try emailing our friendly technical support representatives, specially trained to communicate quick, easy, and logical solutions to your inquiries within 24 hours.

### 3. Toll-Free Live Tech Support — (1-800-828-4040)

This option provides live telephone technical support, free of service charges, Monday-Saturday (excluding holidays), during your product's 1 year limited warranty period. Telephone Device for the Deaf (TDD) support is available at (1-866-251-3752).

### 4. Extended Service and Support — [www.canonesp.com](http://www.canonesp.com)

Canon CarePAK Extended Service Plan is a cost-attractive and easy-to-use extended service program that provides up to three full years of service and support coverage at a very attractive price. CarePAK offers toll-free Canon technical support and includes Canon's superb InstantExchange product replacement program. For further information about extending your Canon service and support, call (1-800-385-2155), or visit our Web site at [www.canonesp.com](http://www.canonesp.com). CarePAK must be purchased during your product's warranty period.

For more information and updated program specifics, please visit our web site at [www.canontechsupport.com](http://www.canontechsupport.com).

\* Support program specifics are subject to change without notice.

**Canon**

# **PIXMA MP960**

**Photo All-in-One**

**Quick Start Guide**

## Copyright

This manual is copyrighted by Canon U.S.A., Inc. with all rights reserved. Under the copyright laws, this manual may not be reproduced in any form, in whole or in part, without the prior written consent of Canon U.S.A., Inc.

© 2006 Canon U.S.A., Inc.

## Disclaimer

Canon U.S.A., Inc. has reviewed this manual thoroughly in order that it will be an easy-to-use guide to your Canon PIXMA MP960 Photo All-in-One. All statements, technical information and recommendations in this manual and in any guides or related documents are believed reliable, but the accuracy and completeness thereof are not guaranteed or warranted, and they are not intended to be, nor should they be understood to be, representation or warranties concerning the products described.

Specifications are subject to change without notice.

As an ENERGY STAR® Partner, Canon Inc. has determined that this product meets the ENERGY STAR guidelines for efficiency.



The International ENERGY STAR® Office Equipment Program is a global program that promotes energy saving through the use of computer and other office equipment. The program backs the development and dissemination of products with functions that effectively reduce energy consumption. It is an open system in which business can participate voluntarily. The targeted products are office equipment such as computers, monitors, printers, faxes and copiers.

Their standards and logos are uniform among participating nations.

All information regarding non-Canon products was compiled from publicly available information. No representation is made regarding the accuracy thereof.

## About Consumables

Consumables (ink tanks / FINE Cartridges) are available for 5 years after production has stopped.

## Trademarks

- Microsoft and Windows are either registered trademarks or trademarks of Microsoft Corporation in the U.S. and/or other countries.
- Macintosh and Mac are trademarks of Apple Computer, Inc., registered in the U.S. and other countries.
- Photo Rag is a trademark of Hahnemühle FineArt GmbH.
- SmartMedia is a trademark of Toshiba Corporation.
- MEMORY STICK, Memory Stick PRO, MEMORY STICK Duo and Memory Stick Pro Duo are trademarks of Sony Corporation.
- xD-Picture Card is a trademark of Fuji Photo Film Co., Ltd.
- MultiMediaCard is a trademark of the MultiMediaCard Association.
- SD card and miniSD Card are trademarks of SD Association.
- Bluetooth is a trademark of Bluetooth SIG, Inc., U.S.A. and are licensed to Canon Inc.

Canon U.S.A., Inc.  
One Canon Plaza  
Lake Success, NY 11042

# Table of Contents

<b>Before Printing</b> .....	<b>2</b>	Cannot Install the MP Drivers.....	76
Basic Operation for the Operation Panel.....	2	Cannot Connect to Computer Properly.....	77
Turning the Machine On and Off.....	4	Print Results Not Satisfactory.....	78
Handling the Original Document.....	6	Printing Does Not Start.....	82
Loading Printing Paper.....	8	Paper Does Not Feed Properly.....	84
Changing the Paper and Print Settings.....	22	Paper Jams.....	85
<b>Printing from Your Computer</b> .....	<b>27</b>	Error Message Appears on the Screen.....	88
Printing with Windows.....	27	Cannot Print Properly from a Digital Camera.....	91
Printing with Macintosh.....	28	Cannot Print Properly from a Photo Index Sheet.....	92
<b>Scanning Images</b> .....	<b>29</b>	Cannot Scan Films.....	93
Scanning Methods.....	29	<b>Appendix</b> .....	<b>94</b>
<b>Copying</b> .....	<b>30</b>	Reading the On-screen Manuals.....	94
Making Copies.....	30	Specifications.....	95
Using Other Copy Functions.....	31	<b>Safety Precautions</b> .....	<b>98</b>
<b>Printing from a Memory Card</b> .....	<b>32</b>	Legal Limitations on Use of Your Product and Use of Images.....	101
Memory Cards Supported by This Machine.....	32	Users in the U.S.A.....	102
Inserting the Memory Card.....	33	<b>Index</b> .....	<b>106</b>
Removing the Memory Card.....	34		
Printing Photographs Stored on a Memory Card.....	34		
Using Other Printing Functions.....	35		
Using Useful Display Functions.....	35		
Printing Using the Photo Index Sheet.....	36		
<b>Photo Printing from Photo or Film</b> .....	<b>37</b>		
Scanning a Photo.....	37		
Scanning a Film.....	37		
Printing Scanned Photographs.....	41		
Using Other Useful Printing Functions.....	42		
Using Useful Display Functions.....	42		
<b>Printing Photographs Directly from a Compliant Device</b> .....	<b>43</b>		
Printing from a PictBridge Compliant Device.....	43		
<b>Routine Maintenance</b> .....	<b>50</b>		
Replacing an Ink Tank.....	50		
Keeping the Best Printing Results.....	55		
When Printing Becomes Faint or Colors Are Incorrect.....	56		
Printing the Nozzle Check Pattern.....	57		
Examining the Nozzle Check Pattern.....	58		
Print Head Cleaning.....	60		
Print Head Deep Cleaning.....	62		
Aligning the Print Head.....	64		
Cleaning Your Machine.....	68		
<b>Troubleshooting</b> .....	<b>71</b>		
Error Message Is Displayed on the LCD.....	72		
LCD Cannot Be Seen At All.....	74		
An Unintended Language Is Displayed on the LCD.....	75		

# Before Printing

## Basic Operation for the Operation Panel

- (A) HOME button
- (B) Easy-Scroll Wheel
- (C) OK button

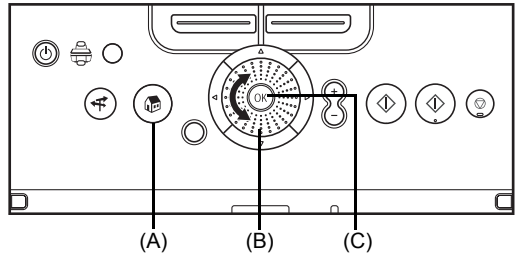

### ■ Easy-Scroll Wheel

Turn the **Easy-Scroll Wheel** left or right to select the setting item. The selected item is highlighted or surrounded by a frame. You can also use the ▲, ▼, ◀ or ▶ button to select the setting items.

### ■ HOME button

This section describes the procedure to display each mode from the **HOME** screen.

#### 1 Display the **HOME** screen.

- (1) Press the **HOME** button.  
The **HOME** screen will be displayed.



#### 2 Select the mode.

- (1) Turn the **Easy-Scroll Wheel** to select the mode, then press the **OK** button.  
Example: Select **Memory card**.  
The selected mode screen will be appeared.

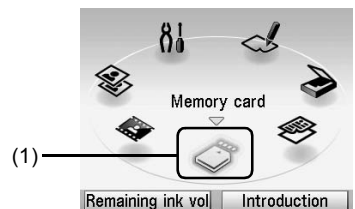

#### Note

When you select a mode and press the Function button (**f2/Introduction**), the instructions for the selected mode are displayed.

You can select the following modes on the **HOME** screen:

- Copy:** You can copy in various layouts. See "Copying" on page 30.
- Scan:** You can save the scanned data to a connected computer using the Operation Panel. See "Scanning Images" on page 29.
- Photo index sheet:** You can easily print the photos from a memory card using the Photo Index Sheet. See "Printing Using the Photo Index Sheet" on page 36.

- Settings:** You can perform the maintenance or change the various settings of the machine. See "When Printing Becomes Faint or Colors Are Incorrect" on page 56, "Cleaning Your Machine" on page 68, or "Changing the Machine Settings" in the *User's Guide* on-screen manual.
- Easy photo reprint:** You can scan printed photos and then print them. See "Photo Printing from Photo or Film" on page 37.
- Film print:** You can scan the image data on the 35 mm film strips and slides and then print them. See "Photo Printing from Photo or Film" on page 37.
- Memory card:** Print the photo data stored in a memory card of a digital camera. See "Printing from a Memory Card" on page 32.

## ■ Other Buttons

- (A) **NAVI** button
- (B) Function buttons

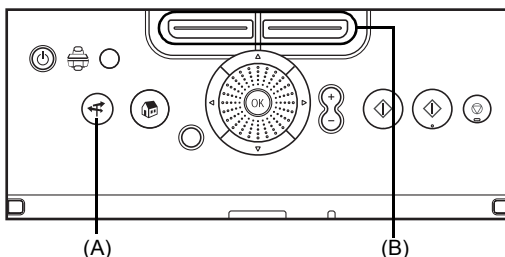

### ● NAVI Button

You can easily reach the function that you want to perform. Select what you want to do on the navigation menu, then press the **OK** button.

### ● Function Buttons

Two Function buttons enable you to select menus displayed at the bottom of the LCD.

The screen that appears when you press a Function button depends on the screen that is displayed and which Function button you press.

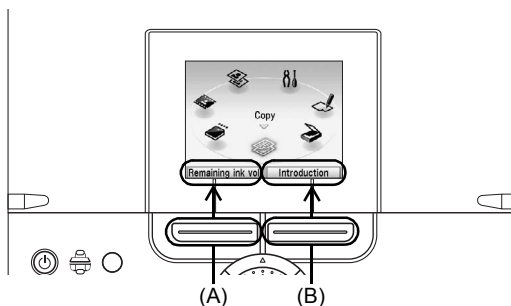

(A) Function button (**f1**): When you press the Function button (**f1/Remaining ink vol**) on the **HOME** screen, the remaining ink volume screen is displayed.

(B) Function button (**f2**): When you press the Function button (**f2/Introduction**) on the **HOME** screen, the introductions for the selected mode functions are displayed.

When you press them on screens other than the **HOME** screen, an operation procedure or menus is displayed.

# Turning the Machine On and Off

---

Turn on the machine before printing.

## ■ Turning on the Machine

Before turning on the machine, confirm the following.

- The Print Head and ink tanks are set into place.

If you are using the machine connected to a computer, confirm also the following.

- The machine is connected to your computer (or a compatible device).
- The MP Drivers are installed.

---

### Note

If preparatory operations above are not complete, follow the *Easy Setup Instructions* to complete them.

---

- 1 Open the Operation Panel and press the **ON/OFF** button to turn on the machine.

The **POWER** lamp flashes blue, and changes to steady, non-flashing light.

---

### Important

If the **ALARM** lamp lights up or flashes orange and an error message is displayed on the LCD, see "Error Message Is Displayed on the LCD" on page 72.

---

- 2 If you are using the machine connected to a computer, turn on your computer.

## ■ Turning off the Machine

- 1 To turn off the machine, press the **ON/OFF** button.

When the **POWER** lamp stops flashing, the machine is turned off.

---

### Important

#### About the Power Plug

When removing the power plug after turning off the machine, be sure to confirm that the **POWER** lamp is not lit. If the power plug is removed from the wall outlet with the **POWER** lamp still lit or flashing blue, the machine may become unable to print.

See "Keeping the Best Printing Results" on page 55.

---

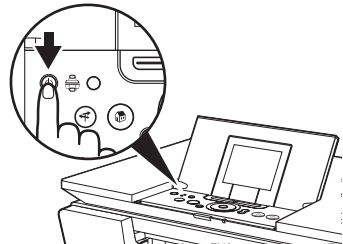
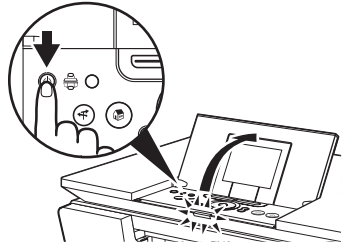



- **Setting the Power Save Mode**

The machine enters Power save mode if not operated for a certain interval. In the Power save mode, the internal fluorescent lamp is turned off, and only the **POWER** lamp stay lit. You can configure the interval that the machine waits before entering Power save mode. See "Other Settings" in "Changing the Machine Settings" of *User's Guide* on-screen manual.

When you try to copy or scan, the machine will exit from Power save mode.

If you use the machine frequently, we recommend that you set the Power save transfer time to 1 hour or 4 hours.

- **The Screen-saver Mode**

The LCD goes out if the machine is not operated for 5 minutes. Press any button to restore the display. You cannot change the wait time before the LCD goes out.

# Handling the Original Document

This section describes how to load the original document on the Platen Glass.

## ■ Original Document Requirements

The original documents you load on the Platen Glass for copying or scanning must meet these requirements:

<b>Document type</b>	<ul style="list-style-type: none"><li>● Paper documents</li><li>● Photographs</li><li>● Books</li><li>● Films</li></ul> <p>* For details on positive and negative 35 mm film strips and 35 mm slides, see “Photo Printing from Photo or Film” on page 37.</p>
<b>Size (W x L)</b>	Max. 8.5 x 11.7 inches / 216 x 297 mm
<b>Thickness</b>	Max. 0.98 inches / 25 mm

## ■ Loading Original Documents

Load originals to copy or scan on the Platen Glass. For details on how to load a photo, see “Scanning a Photo” on page 37. For details on how to load a film, see “Scanning a Film” on page 37.

### Note

Make sure any glue, ink, correction fluid, or the like on the original document is completely dry before loading it on the Platen Glass.

## 1 Load the original document on the Platen Glass.

- (1) Lift the Document Cover.
- (2) Load the original on the Platen Glass.  
Place the original face down on the Platen Glass.

Align the upper left corner of your original with the alignment mark on the upper left corner of the Platen Glass.

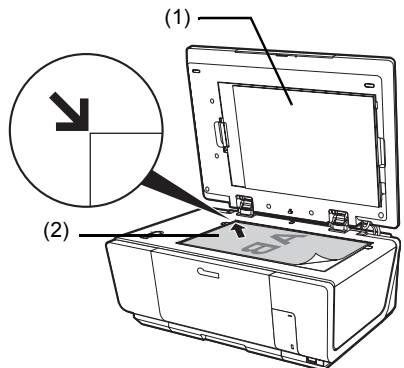

---

**Important**

- Do not place any objects weighing more than 4.4 lb / 2 kg on the Platen Glass.
- Do not press or put weight on the original with pressure exceeding 4.4 lb / 2 kg. Doing so may cause the scanner to malfunction or the Platen Glass to break.

**Note**

- The machine cannot scan the area within about 0.04 inches / 1 mm from the rear edge, and within about 0.04 inches / 1 mm from the left edge of the Platen Glass.
- You can also scan in originals that are up to 0.98 inches / 25 mm thick, such as books. Set them on the Platen Glass in the same way as paper documents.

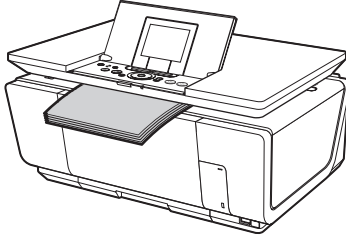

- 
- 2** Gently close the Document Cover.

# Loading Printing Paper

This section describes how to load printing paper in the Auto Sheet Feeder and the Cassette.

## ■ Paper Handling

### ● Recommended Paper and Requirements

Media Type	Model <sup>*1</sup>	Paper Support Load Limit		Machine Setting for Media Type
		Auto Sheet Feeder	Cassette	
Plain Paper	—	0.52 inches / 13 mm	0.52 inches / 13 mm	Plain paper
Envelopes <sup>*2</sup>	—	10 envelopes	5 envelopes	—
High Resolution Paper <sup>*2</sup>	HR-101N	80 sheets (A4, Letter)	80 sheets (A4, Letter)	—
Super White Paper	SW-201	0.52 inches / 13 mm (A4, Letter)	0.52 inches / 13 mm (A4, Letter)	Plain paper
Glossy Photo Paper	GP-401	10 sheets (A4, Letter), 20 sheets (4" x 6" / 101.6 x 152.4 mm, Credit card)	10 sheets (A4, Letter), 20 sheets (4" x 6" / 101.6 x 152.4 mm), Not loadable (Credit card) <sup>*3</sup>	Glossy Photo Paper
Glossy Photo Paper "Everyday Use"	GP-501	10 sheets (A4), 20 sheets (4" x 6" / 101.6 x 152.4 mm)	10 sheets (A4), 20 sheets (4" x 6" / 101.6 x 152.4 mm)	Glossy Photo Paper
Matte Photo Paper	MP-101	10 sheets (A4, Letter), 20 sheets (4" x 6" / 101.6 x 152.4 mm)	10 sheets (A4, Letter), 20 sheets (4" x 6" / 101.6 x 152.4 mm)	Matte Photo Paper
Photo Paper Glossy	GP-502	10 sheets (Letter), 20 sheets (4" x 6" / 101.6 x 152.4 mm)	10 sheets (Letter), 20 sheets (4" x 6" / 101.6 x 152.4 mm)	Glossy Photo Paper
Photo Paper Plus Glossy <sup>*4</sup>	PP-101	10 sheets (A4, Letter, 5" x 7" / 127.0 x 177.8 mm), 20 sheets (4" x 6" / 101.6 x 152.4 mm)	10 sheets (A4, Letter, 5" x 7" / 127.0 x 177.8 mm), 20 sheets (4" x 6" / 101.6 x 152.4 mm)	Photo Plus Glossy
Photo Paper Plus Double Sided <sup>*2, *4</sup>	PP-101D	10 sheets (A4, Letter, 5" x 7" / 127.0 x 177.8 mm)	10 sheets (A4, Letter, 5" x 7" / 127.0 x 177.8 mm)	—
Photo Paper Plus Semi-gloss <sup>*4</sup>	SG-101, SG-201	10 sheets (A4, Letter), 10 sheets (8" x 10" / 203.2 x 254.0 mm) <sup>*5</sup> , 20 sheets (4" x 6" / 101.6 x 152.4 mm)	10 sheets (A4, Letter), 10 sheets (8" x 10" / 203.2 x 254.0 mm) <sup>*5</sup> , 20 sheets (4" x 6" / 101.6 x 152.4 mm)	Photo Plus Glossy
Photo Paper Pro <sup>*4</sup>	PR-101	10 sheets (A4, Letter, 8" x 10" / 203.2 x 254.0 mm), 20 sheets (4" x 6" / 101.6 x 152.4 mm, Wide)	10 sheets (A4, Letter, 8" x 10" / 203.2 x 254.0 mm), 20 sheets (4" x 6" / 101.6 x 152.4 mm, Wide)	Photo Paper Pro
Photo Stickers <sup>*6, *9</sup>	PS-101	1 sheet	Not loadable <sup>*3</sup>	Photo Plus Glossy
Fine Art Paper "Photo Rag" <sup>*2, *7, *8</sup>	FA-PR1	1 sheet (A4, Letter) <sup>*3</sup>	Not loadable	—
T-Shirt Transfers <sup>*2</sup>	TR-301	1 sheet	1 sheet	—

Paper with a Model Number is Canon specialty media.

You may not be able to purchase some Canon genuine papers depending on your country.

- \*1 Paper is not sold in the US by Model Number. Purchase paper by name.
- \*2 Available only when printing from your computer.
- \*3 Feeding this paper from the Cassette can damage the machine. Load in the Auto Sheet Feeder.
- \*4 When loading a stack of paper, the printed side may become marked when it is fed in. In this case, load paper one sheet at a time.
- \*5 SG-201 only
- \*6 You can specify the print setting easily by using the Easy-Photo Print provided with the *Setup CD-ROM*.
- \*7 Canon genuine paper is produced and stored to get optimum printing quality. We recommend using Canon genuine paper.
- \*8 If you are using this paper, you cannot print in the 1.38 inches / 35 mm margin on the top and bottom edges. If you choose a special paper size for Fine Art Paper in the printer driver, a limit is set to prevent printing in the 1.38 inches / 35 mm margin on the top and bottom edges of the paper.

We recommend checking the area being printed in the preview screen before printing. Refer to the *Printer Driver Guide* on-screen manual.

- \*9 When copying printed photos onto sticker paper, be sure to select **Sticker print** in **Easy photo reprint** mode. Refer to "Printing on a Sticker (Sticker Print)" in "Using Other Useful Printing Functions" of the *User's Guide* on-screen manual.

When copying photos onto sticker paper from a film, be sure to select **Sticker print** in **Film print** mode. Refer to "Printing on a Sticker (Sticker Print)" in "Using Other Useful Printing Functions" of the *User's Guide* on-screen manual.

When printing photos stored in a memory card to sticker paper, be sure to select **Sticker print** in the Memory card mode. Refer to "Printing on Stickers (Sticker Print)" in "Using Other Useful Printing Functions" of the *User's Guide* on-screen manual.

When printing photos saved on your mobile phone to sticker paper, select **Stickers** for paper size in **Wireless print settings**. Refer to "Setting Items" in "Setting the Page Size, Media Type, and Layout When Printing from a Mobile Phone" of the *User's Guide* on-screen manual.

- To specify the page size and media type when printing from your computer, refer to the *Printer Driver Guide* on-screen manual.
- To specify the page size and media type when printing photos saved on mobile phones, refer to "Setting the Page Size, Media Type, and Layout When Printing from a Mobile Phone" in the *User's Guide* on-screen manual.

---

#### **Note**

For a detailed description of printing media types, refer to "Printing Media" in the *User's Guide* on-screen manual.

---

## ● Media Types You Cannot Use

Do not use the following types of paper. Using such paper will not only produce unsatisfactory results, but can also cause the machine to jam or malfunction. Additionally, when printing on A5 or smaller sized paper, do not use paper thinner than a post card, including plain paper or notepad paper cut to a small size.

- Folded, curled, or wrinkled paper
- Damp paper
- Paper that is too thin (weighing less than 17 lb / 64 gsm)
- Paper that is too thick (non-Canon genuine paper weighing more than 28 lb / 105 gsm)
- Picture postcards
- Postcards affixed with photos or stickers
- Envelopes with double flaps
- Envelopes with sticker flaps
- Envelopes with an embossed or treated surface
- Any type of paper with holes
- Paper that is not rectangular
- Paper bound with staples or glue
- Paper with adhesives
- Paper decorated with glitter, etc.

## ● Photo Paper Pro Guidelines

- Do not touch the print surface until the ink is dry (approximately 30 minutes). Colors in dark images may appear indistinct at first, but will become clearer after approximately 30 minutes.
- Images may become smudged if you place printouts in an album before the ink is completely dry. We recommend to allow the ink to dry for 24 hours before placing your printouts in an album.
- Do not attempt to dry the ink with a hair dryer or by exposing printouts to direct sunlight.
- Do not store or display printouts in hot or humid conditions. Never expose them to heat or direct sunlight.
- Store printouts in photo albums, photo frames, or presentation binders to protect them from direct exposure to air or sunlight.
- Do not mount printouts in an adhesive-type album as you may not be able to remove them. Note that some types of clear plastic folders and albums may cause the edges of the paper to turn yellow.

## ■ Using Specialty Media

Canon recommends that you use Canon genuine media to ensure optimal print quality.

### ● Photo Quality Media

- Glossy Photo Paper
- Matte Photo Paper
- Photo Paper Plus Double Sided
- Photo Paper Plus Glossy
- Photo Paper Plus Semi-gloss
- Photo Paper Pro
- Fine Art Paper "Photo Rag™"
- Photo Stickers



### ● Media Suited for Business Documents

- High Resolution Paper



## ■ Using the Auto Sheet Feeder and the Cassette

This machine offers two paper sources to load printing paper; the Auto Sheet Feeder, found at the top of the machine, and the Cassette, found at the front of the machine.

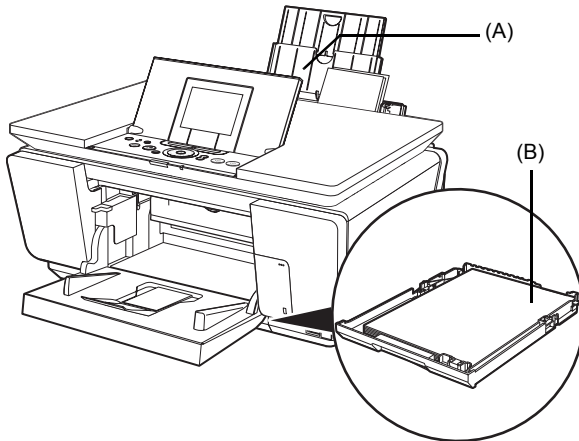

(A) Auto Sheet Feeder

(B) Cassette

## ● When Printing for the First Time

At purchase, the machine is set to feed from the Auto Sheet Feeder.

If you are printing without changing paper source settings, load paper in the Auto Sheet Feeder.

---

### Note

For details on loading paper, see “Loading Paper in the Auto Sheet Feeder” on page 17.

---

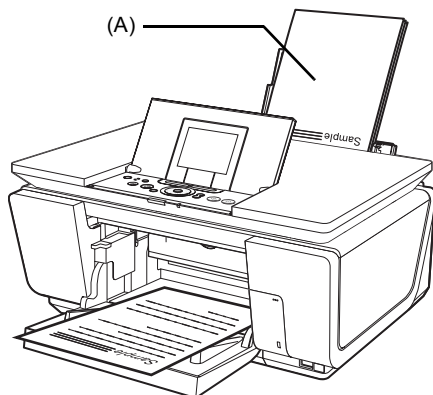

(A) Load plain paper in the Auto Sheet Feeder.

## ● To Change the Paper Source

The **Auto Sheet Feeder** lamp lights up when feeding from the Auto Sheet Feeder, and the **Cassette** lamp lights up when feeding from the Cassette.

Before you print, make sure that the paper source selection matches the paper source where you actually loaded paper.

To change the paper source, simply press the **Paper Feed Switch**.

For details, see “Changing the Paper Source” on page 15.

---

### Note

You can also select the paper source using the printer driver. For details on paper source selection using the printer driver, refer to the *Printer Driver Guide* on-screen manual.

---

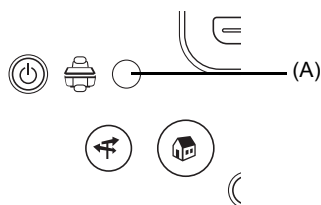

(A) Press to change the paper source



## ■ Paper Source Selection Scenarios

Deciding on the usage of the two paper sources to print with minimum reloading of paper depends mainly on the variety of the type of paper you use regularly.

### ● If you print regularly on photo paper as well as on plain paper

If you use photo paper as much as plain paper, you can load photo paper in the Auto Sheet Feeder and plain paper in the Cassette. This way, you can switch the paper source according to the type of paper just by pressing the **Paper Feed Switch**.

You can also specify the type and size of paper to be fed from the Cassette using the printer driver. You can print more efficiently by specifying the type of paper you use regularly this way, since the paper source will be switched automatically to the Cassette for this paper.

---

#### Note

- Some types and sizes of paper are not loadable in the Cassette and requires the use of the Auto Sheet Feeder. See “Paper Handling” on page 8. For details on loading paper, see “Loading Paper” on page 16.
  - For details on printer driver settings, refer to the *Printer Driver Guide* on-screen manual.
- 

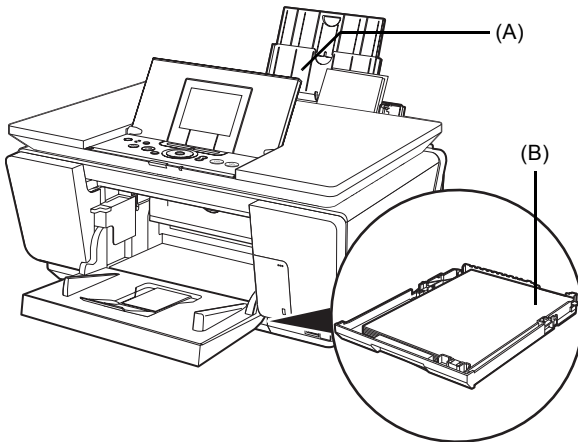

(A) Auto Sheet Feeder: Load paper of various types and sizes, including photo paper.

(B) Cassette: Load paper you use most regularly, such as plain paper.

● **If you print mainly on plain paper**

You can load plain paper of the same size in both paper sources, and set the printer driver to automatically switch the paper source when either paper source runs out of paper during printing.

---

 **Note**

- For details on how to load paper, see “Loading Paper” on page 16.
  - For details on printer driver settings, refer to the *Printer Driver Guide* on-screen manual.
- 

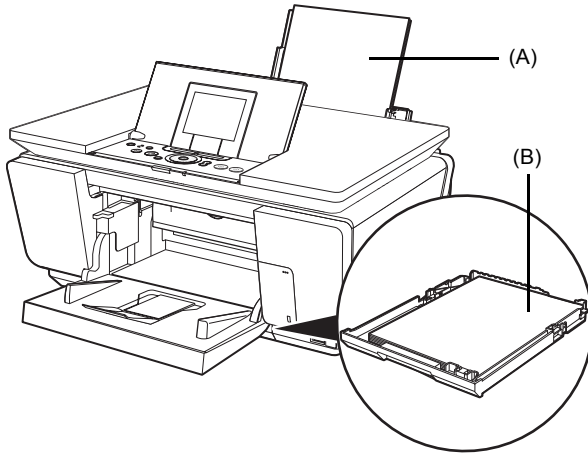

(A) Auto Sheet Feeder: Load plain paper

(B) Cassette: Load plain paper

## ■ Changing the Paper Source

Before printing, confirm that the location where you have loaded paper is selected as the paper source. Press the **Paper Feed Switch** to change the paper source.

---

### ⚠ Important

#### When Printing from Your Computer

- If **Paper Feed Switch** is not selected for **Paper Source** in the printer driver, the **Paper Feed Switch** on the machine will be disabled when printing. Confirm the setting in the printer driver. See "Printing with Windows" on page 27 or "Printing with Macintosh" on page 28.
  - If a setting other than **Paper Feed Switch** is selected for **Paper Source** in the printer driver, the printer driver settings takes precedence when printing. For details on paper source selection using the printer driver, refer to the *Printer Driver Guide* on-screen manual.
- 

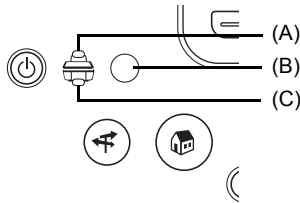

(A) **Auto Sheet Feeder** lamp

(B) **Paper Feed Switch**

(C) **Cassette** lamp

---

### 📖 Note

Press the **Paper Feed Switch** to select the paper source so that the **Auto Sheet Feeder** lamp is lit when feeding from the Auto Sheet Feeder, and the **Cassette** lamp is lit when feeding from the Cassette.

---

## ■ Loading Paper

### ● Important

- If you cut plain paper to 4" x 6" / 101.6 x 152.4 mm, 5" x 7" / 127.0 x 177.8 mm, or 2.13" x 3.39" / 54.0 x 86.0 mm (credit card-size) for a trial print, it can cause paper jams.
- You cannot print on postcards affixed with photos or stickers.
- Always load paper in portrait orientation (A). Loading paper in landscape orientation (B) can cause the paper to be jammed.

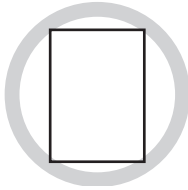

(A)

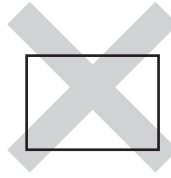

(B)

### 📖 Note

- For details on the specialty media Canon provides for use with its various printers, refer to "Printing Media" in the *User's Guide* on-screen manual.
- For detailed instructions on how to load specialty media into the machine, refer to "Printing Media" in the *User's Guide* on-screen manual.

### When Printing on Plain Paper

- You can use general copy paper or Canon's Super White Paper. When printing on both sides, we recommend Canon's Super White Paper Double-Sided.  
Paper size:
    - Standard sizes: A4, B5, A5, Letter, and Legal (Auto Sheet Feeder only)
    - Non-standard sizes for the Auto Sheet Feeder: 2.13" x 3.39" to 8.5" x 23" / 54.0 x 86.0 mm to 215.9 x 584.2 mm
    - Non-standard sizes for the Cassette: 3.5" x 5" to 8.5" x 11.69" / 89.0 x 127.0 mm to 215.9 x 297.0 mmPaper weight: 17 to 28 lb / 64 to 105 gsm (non-Canon genuine plain paper)  
\*However, you can use art paper that is not produced by Canon that is up to 53 lb / 200 gsm (only in the Auto Sheet Feeder).  
Do not use paper heavier than this (except for supported Canon genuine paper), as it could jam in the machine.
  - You can load up to 150 sheets of plain paper (17 lb / 64 gsm, 0.52 inches / 13 mm in height). However, proper feeding of paper may not be possible at this maximum capacity depending on the type of paper or environmental conditions (either very high or low temperature and humidity). In such cases, reduce the sheets of paper you load at a time to around half (around 0.2 inches / 5 mm in paper stack height).
  - Do not stack more than 50 sheets in the Paper Output Tray.
- ### When Printing on 5" x 7", 4" x 6", or 2.13" x 3.39" (Credit Card-sized) paper
- Load 2.13" x 3.39" (credit card-sized) paper only in the Auto Sheet Feeder.
  - You can load up to 20 sheets of 4" x 6" or 2.13" x 3.39" (credit card-sized) paper and 10 sheets of 5" x 7" paper.
  - We recommend using genuine Canon photo media when printing photographs.  
Refer to "Printing Media" in the *User's Guide* on-screen manual.

## ● Loading Paper in the Auto Sheet Feeder

- 1 Flatten the four corners of the paper before loading it.

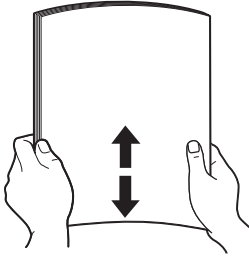

### Note

- Align the edges of paper neatly before loading. Loading paper without aligning the edges may cause paper jams.
- If paper is curled, hold the opposing curled corners and gently bend them in the opposite direction until the paper becomes completely flat. See “Paper is curled.” on page 81.
- To avoid curling, handle paper as follows.
  - Put unused paper back into the package and keep them on a level surface.
  - Take out only the necessary number of sheets from the package, just before printing.

- 2 Prepare to load paper.

- (1) Open the Sheet Feeder Cover and pull out the Paper Support.
- (2) Open the Paper Output Tray. Put your finger on the top of the Paper Output Tray and open it gently.
- (3) Open the Output Tray Extension.
- (4) Press the **Paper Feed Switch** so that the **Auto Sheet Feeder lamp (A)** lights.

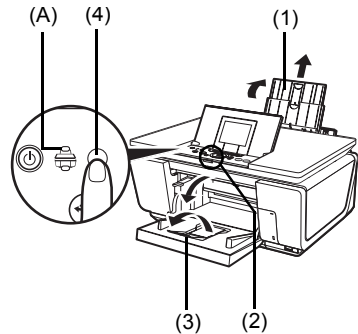

### Note

You can also select the paper source with the printer driver.  
For details, refer to the *Printer Driver Guide* on-screen manual.

### 3 Load the paper.

- (1) Load the paper in the Auto Sheet Feeder with the print side facing UP.
- (2) Align the paper stack against the Cover Guide on the right side of the Paper Support.

#### Note

Make sure that the Cover Guide is set upright when you load paper in the Auto Sheet Feeder.

- (3) Pinch the Paper Guide and slide it against the left side of the paper stack.

#### Note

When performing copy direct printing without using a computer, select the page size selected in **Page size** in each menu. For details on settings in each menu, see "Changing the Paper and Print Settings" on page 22.

When using the machine connected to a computer, select the page size of the loaded paper in **Page Size** in the printer driver.

For details on printer driver settings, see "Printing with Windows" on page 27 or "Printing with Macintosh" on page 28.

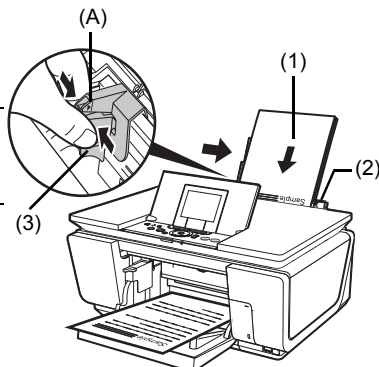

Do not load higher than the Load Limit Mark (A).

### ● Loading Paper in the Cassette

Some types and sizes of paper are not loadable in the Cassette and requires the use of the Auto Sheet Feeder. If you intend to use only the Cassette, check for any usage restrictions in advance. See "Paper Handling" on page 8.

#### Important

- Do not leave photo paper, such as Photo Paper Pro, in the Cassette for a long time. This may cause paper discoloration due to natural aging.
- If you load photo paper such as Photo Paper Pro in the Cassette, you may get roller traces on the print surface. To avoid this, load paper in the Auto Sheet Feeder.

### 1 Flatten the four corners of the paper before loading it.

See "Flatten the four corners of the paper before loading it." on page 17.

### 2 Prepare to load paper.

- (1) Pull out the Cassette from the machine.

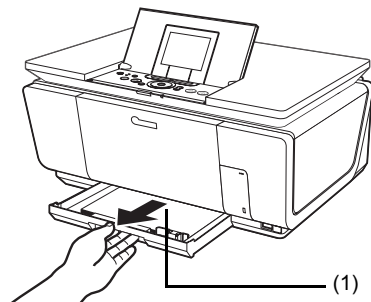

### 3 Load the paper with the print side facing DOWN.

- (1) Load the paper in the Cassette with the print side facing DOWN and the leading edge to the far side.
- (2) Align the paper stack against the right side of the Cassette.
- (3) Slide the paper guides to fit to the loaded paper stack.

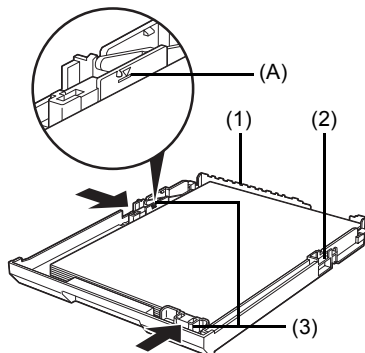

Do not load higher than the Load Limit Mark (A).

### 4 Insert the Cassette into the machine.

- (1) Insert the Cassette into the machine. Push the Cassette all the way into the machine.

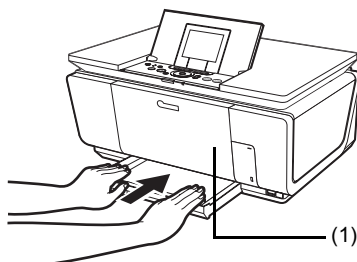

### 5 Prepare the Paper Output Tray.

- (1) Open the Paper Output Tray. Put your finger on the top of the Paper Output Tray and open it gently.
- (2) Open the Output Tray Extension.
- (3) Press the **Paper Feed Switch** so that the **Cassette lamp (A)** lights.

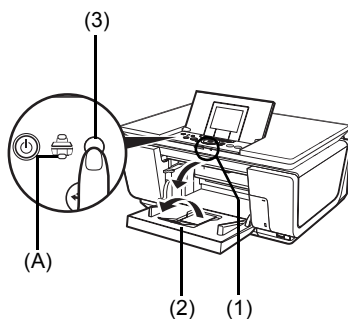

#### Note

- When performing copy direct printing without using a computer, select the page size selected in **Page size** in each mode. For details on settings in each mode, see "Changing the Paper and Print Settings" on page 22.

When using the machine connected to a computer, select the page size of the loaded paper in **Page Size** in the printer driver.

For details on printer driver settings, see "Printing with Windows" on page 27 or "Printing with Macintosh" on page 28.

- You can also select the paper source with the printer driver. For details, refer to the *Printer Driver Guide* on-screen manual.

## ■ Loading Envelopes

Use either European DL or US Comm. Env. #10-sized envelope.

---

### ● Important

- You need to print from the computer to print on envelopes.
  - Do not use envelopes with embossed or treated surfaces, a double flap, pressure seals, or sticker flaps.
  - Select either **DL Env.** or **Comm. Env. #10** in the printer driver according to the envelope size you are using. If you do not, the address will be printed in the wrong direction.
- 

## ● Loading Envelopes in the Auto Sheet Feeder

- 1 Load the envelope against the Cover Guide (the right side of the Paper Support).

Load with the front face UP and the rear flaps DOWN on the left.

A maximum of 10 envelopes can be loaded at once.

---

### ● Important

Make sure that the Cover Guide is set upright when you load paper in the Auto Sheet Feeder.

---

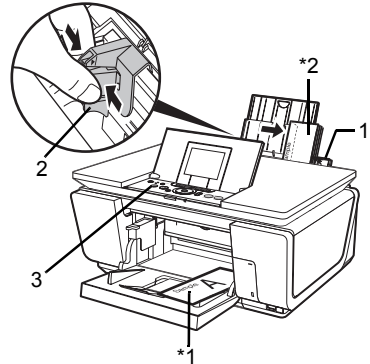

\*1 Printing orientation

\*2 Make sure the flaps are folded.

- 2 Pinch the Paper Guide and slide it against the left side of the envelope.

- 3 Press the **Paper Feed Switch** so that the **Auto Sheet Feeder** lamp lights up.

- 4 In the printer driver, select **Envelope** in **Media Type**, and then select **DL Env.** or **Comm. Env. #10** in **Page Size**.

For details on printer driver settings, see "Printing with Windows" on page 27 or "Printing with Macintosh" on page 28.



## ● Loading Envelopes in the Cassette

- 1 Align the envelope stack against the right side of the Cassette.

Load with the front face DOWN. The flap of the envelope will appear facing UP on the left side.

A maximum of 5 envelopes can be loaded at once.

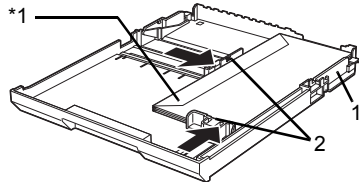

\*1 Make sure the flaps are folded.

- 2 Slide the Paper Guides against the side of the envelope.

- 3 Press the **Paper Feed Switch** so that the **Cassette** lamp lights up.

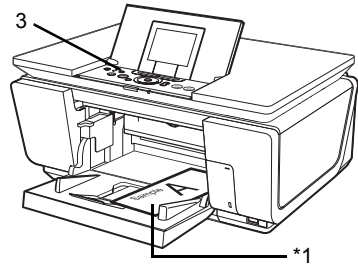

\*1 Printing orientation

- 4 In the printer driver, select **Envelope** in **Media Type**, and then select **DL Env.** or **Comm. Env. #10** in **Page Size**.

For details on printer driver settings, see "Printing with Windows" on page 27 or "Printing with Macintosh" on page 28.

# Changing the Paper and Print Settings

This section describes the Settings screen that can be specified on the Operation Panel when copying, or when printing from a memory card, printed photo or film.

## ■ Setting Items in Each Mode

Items in each mode are as follows.

When you select the item to set and press the **OK** button, a screen with various settings is displayed.

---

### Note

Depending on the functions, some setting items cannot be specified in combination.

---

## ● Copy Mode

This section describes paper and print settings for Copy mode.

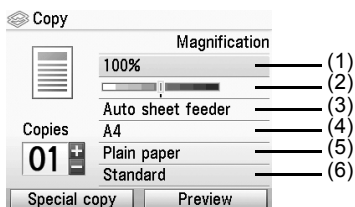

You can specify the paper settings for printing or print quality.

---

### Note

Paper size, media type, and print quality settings are specified for the paper source selected by the **Paper Feed Switch**. Confirm the selected paper source.

---

(1) You can specify the reduction or enlargement method.  
Fit-to-page, Zoom (25 - 400%), 100%, Preset ratio

(2) You can specify the intensity.

Turn the **Easy-Scroll Wheel** clockwise to increase intensity or counterclockwise to decrease it. You can also use the ◀ or ▶ button to make settings.

Press the Function button (**f2/Switch auto/man**) in the intensity screen to automatically match the intensity to the original on the Platen Glass and then print the image. See "Function Buttons" on page 3.

The slide bar for the intensity adjustment on the LCD changes to **Auto** when it is done.

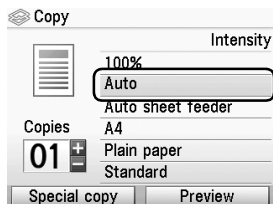

---

### Important

While **Auto** is selected, you can not change the intensity by using the **Easy-Scroll Wheel**. Press the Function button (**f2/Switch auto/man**) to enable manual intensity settings again and then specify the intensity. See "Function Buttons" on page 3.

---

- (3) Select the paper source.  
Before printing, confirm that the location where you have loaded paper is selected as the paper source. Press the **OK** button to change the paper source.
  - (4) Specify the page size.  
Credit card, A5, B5, A4, 8.5" x 11" (215 x 279), 5" x 7" (127 x 177.8), 4" x 6" (101.6 x 152.4)
- 

### Important

**Credit card** can be selected when the Auto Sheet Feeder is selected as the paper source.

#### Note

Some of these options are not available depending on the country of purchase.

---

- (5) Specify the media type.  
Glossy Photo Paper, Matte Photo Paper, Photo Plus Glossy, Plain paper, Photo Paper Pro
  - (6) Adjust print quality according to the original.  
Fast (speed-priority), Standard, High(quality-priority)
- 

#### Note

- **Fast (speed-priority)** can be selected when **Plain paper** is selected as the media type.
  - If you used **Fast (speed-priority)** with media type set to **Plain paper** and the quality is not as good as expected, select **Standard** or **High(quality-priority)** and try copying again.
  - Select **High(quality-priority)** to copy in grayscale. Grayscale renders tones in a range of grays instead of black or white.
-

## ● Memory Card, Easy Photo Reprint, and Film Print Modes

This section describes the paper and print settings for Memory card, Easy photo reprint, and Film print modes.

### Print Settings Confirmation Screen

You can specify the paper settings for printing or print quality.

---

#### Note

Paper size, media type, and print quality settings are specified for the paper source selected by the **Paper Feed Switch**. Confirm the selected paper source.

---

Example: Screens displayed in **Select and print** in the **Memory card** mode, the **Easy photo reprint** mode, or the **Film print** mode

See “Printing Photographs Stored on a Memory Card” on page 34 or “Printing Scanned Photographs” on page 41.

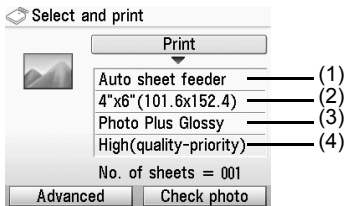

**(1)** Select the paper source.

Before printing, confirm that the location where you have loaded paper is selected as the paper source. Press the **OK** button to change the paper source.

**(2)** Select the page size.

Credit card, A4, 8.5" x 11" (215 x 279), 8" x 10" (203.2 x 254.0)\*, 5" x 7" (127 x 177.8), 4" x 6" (101.6 x 152.4), Wide 4" x 7.1" (101 x 180)

---

#### Important

**Credit card** can be selected when the Auto Sheet Feeder is selected as the paper source.

#### Note

Some of these options are not available depending on the country of purchase.

---

**(3)** Select the media type.

Glossy Photo Paper, Matte Photo Paper, Photo Plus Glossy, Plain paper\*, Photo Paper Pro

**(4)** Select the print quality.

Standard, High(quality-priority)

\* Can be selected only in Memory card mode.

## Advanced Print Settings Screen

When you press the Function button (**f1/Advanced**) in the print settings confirmation screen, the advanced print settings screen is displayed. See “Function Buttons” on page 3.

You can optimize photos and advanced print settings with the functions below.

Memory card mode

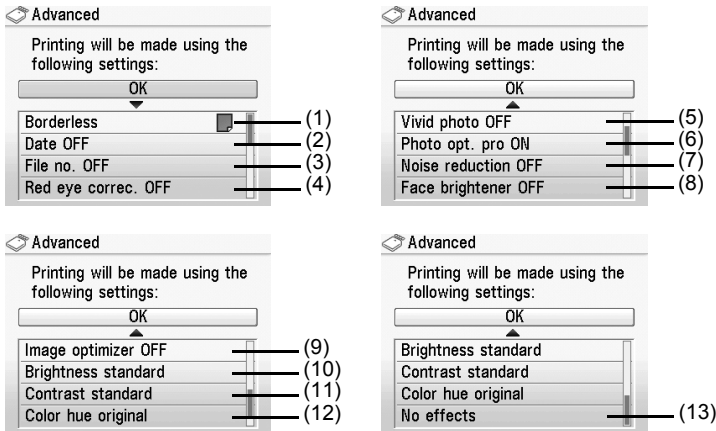

Easy photo reprint and Film print modes

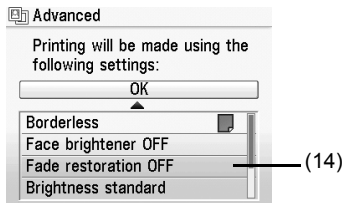

- (1) Select bordered or borderless print.  
Bordered, Borderless

### Note

When **Plain paper** is selected in **Media type**, bordered printing will be performed even if you select **Borderless**.

- (2) Activate/deactivate to print the shooting date on a photo.\*<sup>1</sup>  
Print the shooting date on a photo.  
Date OFF, Date ON
- (3) Activate/deactivate to print the file no. on a photo.\*<sup>1</sup>  
Print the file no. on a photo.  
File no. OFF, File no. ON

### Note

It is not possible to print both the shooting date and the file no. under the following conditions:

- **Layout print** is selected as a print function in the **Memory card** mode, and/or
- **Credit card** is selected in Page size.

Under these conditions, even if both **Date ON** and **File no. ON** are set, only the shooting date will be printed. If you want to print the file no., select **Date OFF**.

- (4) Activate/deactivate Red eye correction.\*<sup>1</sup>  
Corrects red eyes in portraits caused by flash photography.  
Red eye correc. OFF, Red eye correc. ON
  - (5) Activate/deactivate Vivid photo function.\*<sup>1</sup>  
Makes green and blue more lively.  
Vivid photo OFF, Vivid photo ON
  - (6) Activate/deactivate the Photo Optimizer pro function.\*<sup>1</sup>  
Automatically optimizes brightness and tone of a photo.  
Photo opt. pro OFF, Photo opt. pro ON
  - (7) Activate/deactivate the Noise reduction function.\*<sup>1</sup>  
Reduces the noise on blue areas like the sky as well as on black areas.  
Noise reduction OFF, Noise reduction ON
  - (8) Activate/deactivate Face brightener function.  
Brightens a darkened face on the photo taken against the light.  
Face brightener OFF, Face brightener ON
  - (9) Activate/deactivate Image optimizer function.\*<sup>1</sup>  
Corrects and smooths the jagged contours for printing.  
Image optimizer OFF, Image optimizer ON
  - (10) Adjust brightness.  
Brightness -2, Brightness -1, Brightness standard, Brightness +1, Brightness +2
  - (11) Adjust contrast.  
Contrast -2, Contrast -1, Contrast standard, Contrast +1, Contrast +2
  - (12) Adjust color hue.  
Color hue red +2, Color hue red +1, Color hue original, Color hue yellow +1, Color hue yellow +2
  - (13) Activate/deactivate Effects\*<sup>1</sup>  
Applies special effects to the photo, such as printing in sepia tones or with a sketch illustration like effect.  
No effects, Effect: Sepia, Simulate illustration
  - (14) Activate/deactivate Fade restoration\*<sup>2</sup>  
Corrects the color when printing photos that have faded or color cast over time.  
Fade restoration OFF, Fade restoration ON
- \*1 Can be selected only in Memory card mode.
- \*2 Can be selected only in Easy photo reprint or Film print mode.

# Printing from Your Computer

This section describes procedure for basic printing.

## Printing with Windows

- 1 Turn on the machine and load the paper in the machine.  
See “Turning the Machine On and Off” on page 4 and “Loading Printing Paper” on page 8.
- 2 Make sure that the proper paper source is selected.  
See “Changing the Paper Source” on page 15.
- 3 Create a document or open a file to print using an appropriate application software.
- 4 Select **Print** on the application software’s **File** menu.
- 5 Make sure that **Canon MP960 Printer** is selected, and click **Preferences** (or **Properties**).

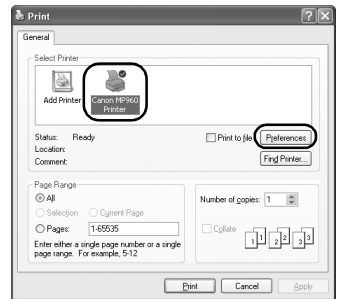

- 6 Specify the required settings and click **OK**.  
Make sure that **Paper Feed Switch** is selected in **Paper Source**.

### Note

For details on other printer driver functions, click **Help** or **Instructions** to view the online help or the *Printer Driver Guide* on-screen manual. **Instructions** is only displayed when the on-screen manuals are installed.

- 7 Click **Print** (or **OK**).

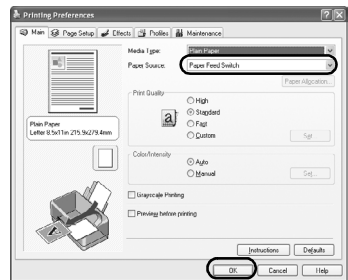

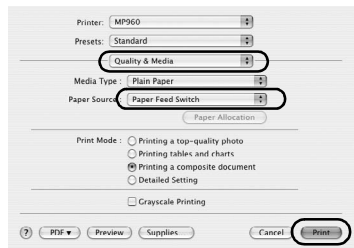
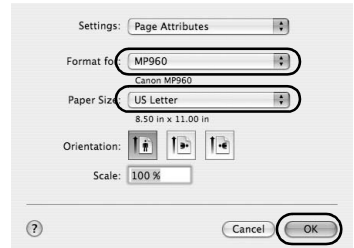

# Printing with Macintosh

- 1 Turn on the machine and load the paper in the machine.  
See “Turning the Machine On and Off” on page 4 and “Loading Printing Paper” on page 8.
- 2 Make sure that the proper paper source is selected.  
See “Changing the Paper Source” on page 15.
- 3 Create a document or open a file to print using an appropriate application software.
- 4 Select **Page Setup** on the application software’s **File** menu.
- 5 Confirm that **MP960** is selected in **Format for**.
- 6 Select the desired paper size in **Paper Size**.
- 7 Click **OK**.
- 8 Select **Print** on the application software’s **File** menu.
- 9 Select **Quality & Media** in the pop-up menu.
- 10 Specify the required settings.  
Make sure that **Paper Feed Switch** is selected in **Paper Source**.



## Note

For details on other printer driver functions, click  to view the *Printer Driver Guide* on-screen manual. If the on-screen manuals are not installed, the *Printer Driver Guide* on-screen manual is not displayed even if  is clicked.

- 11 Click **Print**.



# Scanning Images

You can scan images from the machine to a computer without printing them and save them in popular file formats, such as JPEG, TIFF, bitmaps, or PDF. If you are scanning printed text, you can use the OCR (Optical Character Recognition) software to convert it to text data.

## Scanning Methods

---

### ■ Scanning Using the MP Navigator

Using MP Navigator, you can scan originals loaded on the Platen Glass and view images saved on your computer or on a memory card. Scanned documents can be previewed and be easily printed and edited according to your needs.

You can use the bundled software applications to edit or print the document you have scanned.

For detailed operations of the MP Navigator, refer to the *Scanning Guide* on-screen manual.

### ■ Scanning Using the Operation Panel of the Machine

- 1 Turn on the machine.  
See “Turning the Machine On and Off” on page 4.
- 2 Load the original document on the Platen Glass.  
See “Handling the Original Document” on page 6, and on setting a photo, see “Scanning a Photo” on page 37.
- 3 Select Scan on the **HOME** screen.  
See “Basic Operation for the Operation Panel” on page 2.
- 4 Select the scan operation, then press the **OK** button.
- 5 Press the **Color** or **Black** button.  
The operation to be performed after scanning the original depends on the scan operation setting you have selected in step 4. For details on how to modify the operation settings, refer to the *Scanning Guide* on-screen manual.

### ■ Scanning from an Application Software

You can scan an image from a TWAIN- or WIA- (Windows® XP only) compliant application software and handle the scanned image in the application software. For detailed operations, refer to the *Scanning Guide* on-screen manual.

# Copying

## Making Copies

---

This section describes the basic procedure to make copies.

- 1** Turn on the machine.  
See “Turning the Machine On and Off” on page 4.
- 2** Select **Copy** on the **HOME** screen.  
See “Basic Operation for the Operation Panel” on page 2.
- 3** Load paper.  
See “Loading Printing Paper” on page 8.
- 4** Make sure that the proper paper source is selected.  
See “Changing the Paper Source” on page 15.
- 5** Specify copy settings.

- (1) Confirm the page size, media type, or other settings. To change the settings, select the item and press the **OK** button.
- (2) Use the **+** or **-** button to specify the number of copies.

- 6** Load the original on the Platen Glass.  
See “Loading Original Documents” on page 6.

- 7** Press the **Color** button for color copying, or the **Black** button for black & white copying.

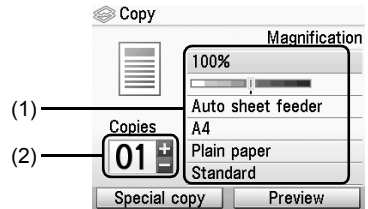

# Using Other Copy Functions

---

## **Reduced/Enlarged Copy**

Reduces or enlarges copies.

## **Two-sided copy**

Copies two original pages onto the sides of a single sheet of paper.

## **Borderless copy**

Copies color images so that they fill the entire page without borders.

## **2-on-1 copy**

Copies two original pages onto a single sheet of paper by reducing each image.

## **4-on-1 copy**

Copies four original pages onto a single sheet of paper by reducing each image. Four different layouts are available.



## **Image repeat**



Copies an image multiple times onto a single page. For the number of times to repeat the image, you can select from Auto layout or the machine's pre-defined settings.

# Printing from a Memory Card

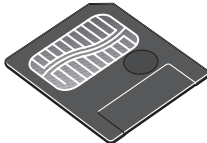
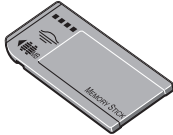
## Memory Cards Supported by This Machine

The following memory cards are compatible with this machine.

Memory cards that can be directly inserted into the Card Slot:	
	<ul style="list-style-type: none"><li>● Compact Flash (CF) Card Supports Type I/II (3.3 V)</li><li>● Microdrive</li></ul>
	<ul style="list-style-type: none"><li>● SmartMedia Supports 3.3 V card only 1 MB and 2 MB cards are not supported</li></ul>
	<ul style="list-style-type: none"><li>● MEMORY STICK</li><li>● MEMORY STICK PRO</li></ul>
	<ul style="list-style-type: none"><li>● SD Secure Digital memory card</li><li>● MultiMediaCard (ver.3.31)</li></ul>

Memory cards that can be inserted in the Card Slot using the adapter:	
	xD-Picture Card <sup>*1</sup>
	<ul style="list-style-type: none"><li>● MEMORY STICK Duo<sup>*2</sup></li><li>● MEMORY STICK PRO Duo<sup>*2</sup></li></ul>
	Mini SD Card <sup>*2</sup>

\*1 Requires purchase of a separate compact flash card adapter for xD-Picture cards.

\*2 Use the special adapter provided with the card.

# Inserting the Memory Card

- 1 Turn on the machine.  
See "Turning the Machine On and Off" on page 4.
- 2 Open the Card Slot Cover.  
Push the upper right-hand corner of the Card Slot Cover as illustrated and open it.

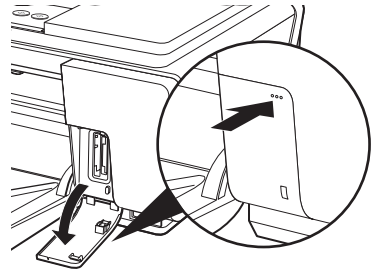

- 3 Insert one and only one memory card into the Card Slot.

Card Type	Inserting Card
<ul style="list-style-type: none"> <li>● Compact Flash (CF) card</li> <li>● Microdrive</li> <li>● xD-Picture card*</li> </ul>	<p data-bbox="852 639 1022 687">Insert into the left Card Slot.</p> <p data-bbox="852 711 941 735">Lights up</p>
<ul style="list-style-type: none"> <li>● SmartMedia</li> </ul>	<p data-bbox="852 831 997 879">Insert into the right Card Slot.</p> <p data-bbox="852 903 941 927">Lights up</p>
<ul style="list-style-type: none"> <li>● MEMORY STICK</li> <li>● MEMORY STICK PRO</li> <li>● MEMORY STICK Duo*</li> <li>● MEMORY STICK PRO Duo*</li> <li>● SD Secure Digital memory card</li> <li>● MiniSD Card*</li> <li>● MultiMediaCard (ver.3.31)</li> </ul>	<p data-bbox="852 991 1022 1070">Insert into the center part of the right Card Slot.</p> <p data-bbox="852 1094 941 1118">Lights up</p>

\* Be sure to attach the memory card to the special adapter before inserting it into the Card Slot.

- 4 Confirm that the **Access** lamp has lit up.
- 5 Close the Card Slot Cover.

## Removing the Memory Card

---

- 1 Open the Card Slot Cover.  
Push the upper right-hand corner of the Card Slot Cover and open it.  
See "Inserting the Memory Card" on page 33.
- 2 Make sure that the **Access** lamp is not flashing, then remove the memory card.
- 3 Close the Card Slot Cover.

## Printing Photographs Stored on a Memory Card

---

- 1 Prepare for printing.
  - (1) Turn on the machine.  
See "Turning the Machine On and Off" on page 4.
  - (2) Load paper.  
See "Loading Printing Paper" on page 8.
  - (3) Make sure that the proper paper source is selected.  
See "Changing the Paper Source" on page 15.
- 2 Insert the memory card.
  - (1) Select **Memory card** on the **HOME** screen.  
See "Basic Operation for the Operation Panel" on page 2.
  - (2) Insert the memory card into the Card Slot.  
See "Inserting the Memory Card" on page 33.
- 3 Select the print menu.
  - (1) Select **Select and print**, then press the **OK** button.
  - (2) Confirm the paper size, media type, and other settings, select **Next**, and then press the **OK** button. To change the settings, select the item and press the **OK** button.
- 4 Select the photo to print and specify the number of copies for each photo.
  - (1) Use the **Easy-Scroll Wheel** or the ◀ or ▶ button to display a photo to print.
  - (2) Use the + or - button to specify the number of copies.
  - (3) Repeat steps (1) and (2) to specify the number of copies for each photo.
  - (4) Press the **OK** button.

## 5 Start printing.

- (1) Confirm the print setting. To change the settings, select the item and press the **OK** button.
- (2) Confirm the total number of copies for the selected photos.
- (3) Confirm the selected photos and number of copies for each photo.
- (4) Change the advanced print settings.
- (5) Press the **Color** button.  
The specified number of copies of each photo will be printed.

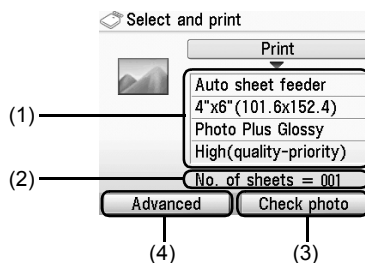

## Using Other Printing Functions

### Layout print

Prints photos your pasted in the specified layout.

### Sticker print

Prints your favorite photo with a frame on Canon Photo Stickers.

### DPOF print

Prints according to the Digital Print Order Format (DPOF) settings on your digital camera, if you have specified them.

### Captured info print

Prints information on photographs at the time of its shooting (Exif info) in the margin of Photo index print or selected individual photos.

### Photo index print

Prints an index of all the photos saved on a memory card.

### Print all photos

Prints all photos saved on the memory card.

## Using Useful Display Functions

### Change display

The display method of a photograph can be changed.

### Trimming

Edits images displayed on the LCD by cropping them.

### Search

When there are a lot of photos saved on the memory card, displays and prints only photos shot on the specified date or within the specified range of dates.

# Printing Using the Photo Index Sheet

- 1 Turn on the machine, and load A4 or Letter-sized paper.  
See “Turning the Machine On and Off” on page 4 and “Loading Printing Paper” on page 8.
- 2 Make sure that the proper paper source is selected.  
See “Changing the Paper Source” on page 15.
- 3 Select **Photo index sheet** on the **HOME** screen.  
See “Basic Operation for the Operation Panel” on page 2.
- 4 Select **Index sheet print**, then press the **OK** button.
- 5 Insert a memory card into the Card Slot.  
See “Inserting the Memory Card” on page 33.
- 6 Select a range of images to include in the Photo Index Sheet, then press the **OK** button.
- 7 Press the **Color** button.
- 8 Fill in the appropriate circles in the Photo Index Sheet.
- 9 Load the type of paper you selected in the Photo Index Sheet.  
See “Loading Printing Paper” on page 8.
- 10 Select **Scan sheet and print**, then press the **OK** button.
- 11 Place the Photo Index Sheet face-down on the Platen Glass, then press the **OK** button.

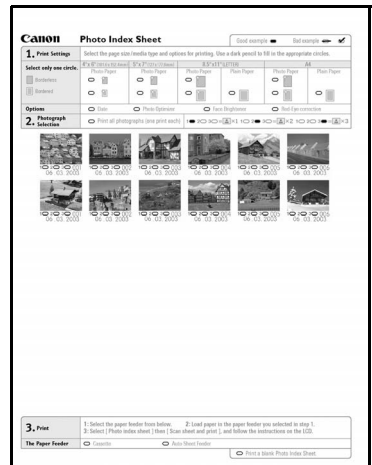



# Photo Printing from Photo or Film

You can scan photos and 35 mm film into and then print them from the machine. For film, both film strips (six connected frames per strip after regular developing) and slides (one frame per mounted slide) are supported. Various effects can be applied to the images before printing them.

## Scanning a Photo

---

- 1 Turn on the machine.  
See "Turning the Machine On and Off" on page 4.
- 2 Select **Easy photo reprint** on the **HOME** screen.  
See "Basic Operation for the Operation Panel" on page 2.
- 3 Lift the Document Cover and load the photos on the Platen Glass.  
Place the photos face down on the Platen Glass as follows.

4"x 6" / 101.6 x 152.4 mm or  
5"x 7" / 127 x 177.8 mm originals

Credit card-sized originals

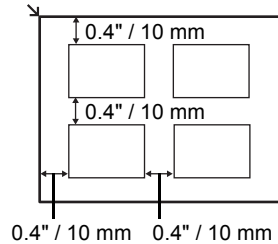
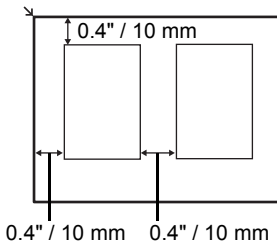

- 4 Gently close the Document Cover and press the **OK** button.

## Scanning a Film

---

- 1 Turn on the machine.  
See "Turning the Machine On and Off" on page 4.
- 2 Display the **Film print** screen.  
See "Basic Operation for the Operation Panel" on page 2.
- 3 Select the type of film to scan, then press **OK**.

- 4 Remove the FAU Protective Sheet from the Document Cover and then remove the film guide for film strip from the back of the FAU Protective Sheet.

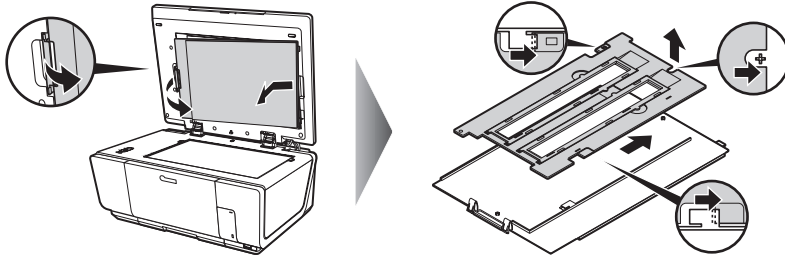

**Note**

Before scanning 35 mm slides, prepare the film guide for slides provided with the machine.

- 5 Mount film in the appropriate film guide.  
For a 35 mm film strip, see "Mounting a 35 mm Film Strip" on page 38.  
For 35 mm slides, see "Mounting 35 mm Slides" on page 40.
- 6 Gently close the Document Cover and press the **Color** button.

■ **Mounting Films**

● **Mounting a 35 mm Film Strip**

- (1) On the film guide, open the film holder.  
Gently squeeze in the edges of the film holder to release it.
- (2) Mount the film in the film guide with the front side (the side showing the correct image) face down, with the frame order running from left to right and with the tip of the film set under the tabs of the film guide. Position the film in the film guide so that the white line marks of the film guide do not obscure the film frames.
- (3) Squeeze the film holder inward lightly and close it completely.

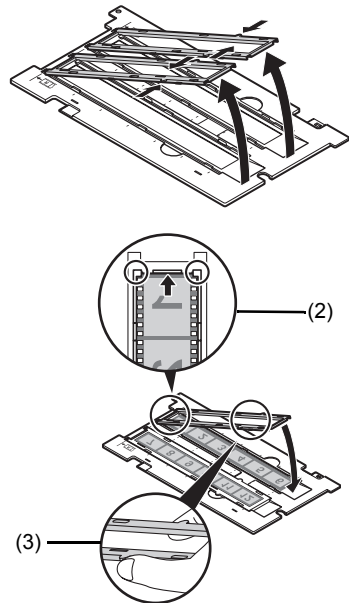

---

**Note**

- If the film holder will not close properly, reposition the film so that its perforations are set properly in the film guide slots, and try again.
  - Make sure that all the protrusions on the outer edges of the film holder fit into the slots in the film guide when closing the film holder. If the film holder does not close completely, press the whole film holder gently downward.
- 

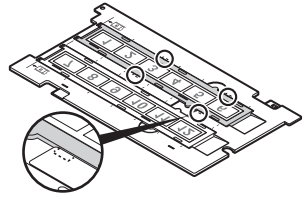

**Mounting a film strip that is shorter than the film guide**

When a film strip that is shorter than the film guide is mounted, parts of the images around the blank area may appear pale. In this case, set the Filler Sheet for film strip (A) over the blank area to shield it before scanning.

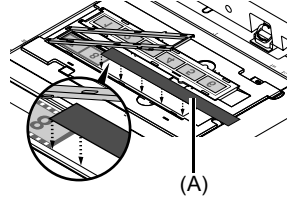

**Setting the Filler Sheet for film strip**

- Mounting a film strip in positions 1 to 4 of the film guide:  
Set the Filler Sheet for film strip (A) over the blank area (positions 7 to 12) to shield it as illustrated. You do not have to shield position 5 or 6, even though there is no film mounted in it.
- Mounting a film strip in positions 1 to 9 of the film guide:  
Set the Filler Sheet for film strip (A) over the blank area (positions 10 to 12) to shield it as illustrated.  
Load the film guide on the Platen Glass as is, even though the Filler Sheet sticks out of the film guide.

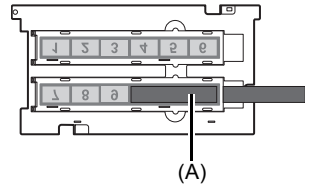
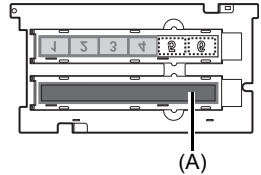

- (4) With the mark  $\mathcal{R}$  on the film guide facing up, align the film guide with the indentations on the right and left sides of the Platen Glass.
- (5) Confirm that the front side of the film (the side showing the correct image) faces down.

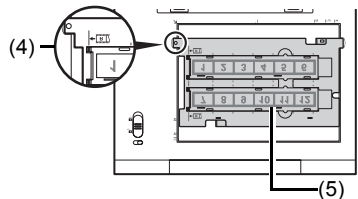

---

**Note**

Labels attached to areas of the film without images may be interpreted as images and be included in the scan.

---

● **Mounting 35 mm Slides**

(1) Load the film guide with its sides to the right and left grooves of the Platen Glass.

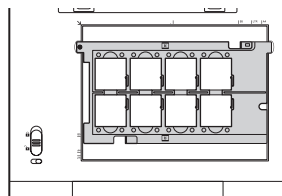

(2) Mount the slides in the film guide with the front side (the side showing the correct image) face down, the frame order running from left to right, and with the image upside down. Load the slides, making sure they are not loose in the film guide.

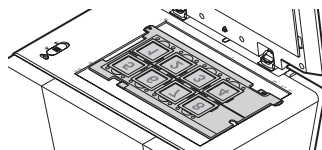

 **Note**

Mount the slides in numerical order from the left side (1 to 4, and 5 to 8) making sure blank areas between the slides.

**Blank areas on the film guide**

If there is a blank area on the film guide, parts of the images around this area may appear pale. In this case, set the Filler Sheet for slides (B) over the blank area (positions 5 to 8) to shield it.

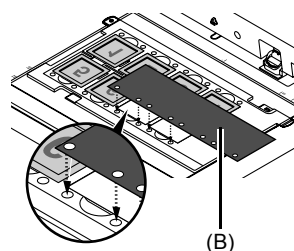

**Setting the Filler Sheet for slides**

● Mounting slides in positions 1 to 3 of the film guide:  
Set the Filler Sheet for slides (B) over the blank area (positions 5 to 8) to shield it as illustrated. You do not have to shield position 4, even though there is no slide mounted in it.

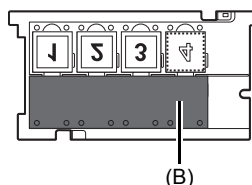

● Mounting slides in positions 1 to 6 of the film guide:  
Set the Filler Sheet for slides (B) over the blank area (positions 7 to 8) to shield it as illustrated. Load the film guide on the Platen Glass as is, even though the Filler Sheet sticks out of the film guide.

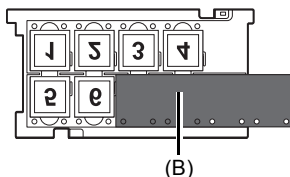

---

## Note

- Film is scanned in the order from left to right.
- Mount the slides in the film guide with the upper edge of the photograph towards you to prevent the scanned photographs from being displayed upside down on the LCD. Depending on the model or brand of your camera, the scanning order may differ from the frame order of the film.

### scanning order

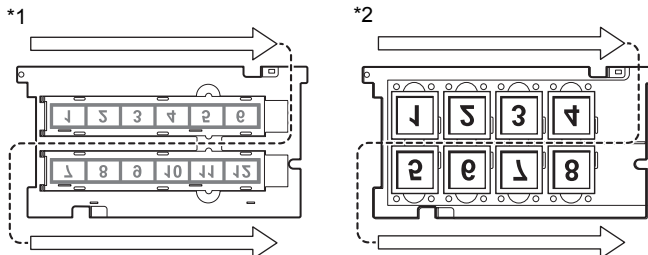

\*1 35 mm film strip

\*2 35 mm slide

---

## Printing Scanned Photographs

---

- 1 Prepare for printing.
  - (1) Load paper.  
See "Loading Printing Paper" on page 8.
  - (2) Scan a photo.  
See "Scanning a Photo" on page 37 or "Scanning a Film" on page 37.
  - (3) Make sure that the proper paper source is selected.  
See "Changing the Paper Source" on page 15.
- 2 Select the print menu.
  - (1) Select **Select and print**, then press the **OK** button.
  - (2) Confirm the paper size, media type, and other settings, then select **Next**, and then press the **OK** button. To change the settings, select the item and press the **OK** button.
- 3 Select the photo to print and specify the number of copies for each photo.
  - (1) Use the **Easy-Scroll Wheel** or the ◀ or ▶ button to display a photo to print.
  - (2) Use the + or - button to specify the number of copies.
  - (3) Repeat steps (1) and (2) to specify the number of copies for each photo.
  - (4) Press the **OK** button.

## 4 Start printing.

- (1) Confirm the print setting. To change the settings, select the item and press the **OK** button.
- (2) Confirm the total number of copies for selected photos.
- (3) Change the advanced print settings.
- (4) Press the **Color** button to print in color, or the **Black** button to print in black & white. The specified number of copies of each photo will be printed.

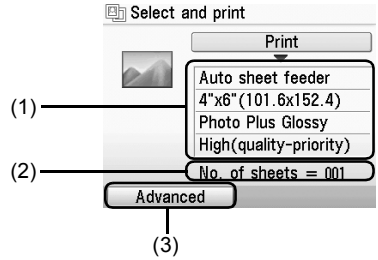

## Using Other Useful Printing Functions

---

### Sticker print

Prints your favorite photo on Canon Photo Stickers to create your own stickers.

### Print all photos

Prints all scanned photos.

## Using Useful Display Functions

---

### Change display

The display method of a photograph can be changed.

### Trimming

Edits images displayed on the LCD by cropping them.

# Printing Photographs Directly from a Compliant Device

## Printing from a PictBridge Compliant Device

---

You can connect a PictBridge compliant device such as a digital camera, camcorder, or mobile phone and print recorded images directly without using a computer.

---

### Note

- PictBridge is an industry standard enabling a range of digital photo solutions, including the direct printing of photos from a digital still camera, camcorder or mobile phone\* without the need to use a computer. A device can be connected to this machine for direct printing regardless of the manufacturer or the model as long as it complies with the PictBridge standard.
  - You can select the images to print and specify various print settings from your camera or mobile phone.  
\* PictBridge compatible digital still cameras, digital camcorders, and camera-equipped mobile phones are hereafter collectively referred to as "PictBridge compliant device".
- 



A device with this mark is PictBridge-compatible.

### ■ Connecting a PictBridge Compliant Device

To connect a PictBridge compliant device to this machine, use a USB cable recommended by the device's manufacturer.

---

### Caution

Do not connect any equipment other than PictBridge compliant devices or optional Bluetooth Units BU-20 to the Direct Print Port of the machine. If you do so, electric shock, fire, or damage to the device could result.

### Note

When printing photos with the digital device connected to the machine, we recommend the use of the AC adapter supplied with the device. If you are using the device battery, be sure to charge it fully.

---

## 1 Set up the machine.

Refer to the *Easy Setup Instructions* to set up the machine and make it ready for printing.

---

### Note

The Print Head cannot be aligned using the controls of the PictBridge compliant device. If Print Head alignment is not yet performed and the MP Drivers are not installed in the computer, be sure to align the Print Head. See "Aligning the Print Head" on page 64.

---

## 2 Turn on the machine and load the paper in the machine.

See "Turning the Machine On and Off" on page 4 and "Loading Printing Paper" on page 8.

### 3 Connect the PictBridge compliant device to the machine.

---

#### Note

Depending on the model or brand of your device, you may have to select a print mode compliant with PictBridge before connecting the device. You may also have to turn on the device or select Play mode manually after connecting the device to the machine.

Perform necessary operations on the PictBridge compliant device before connecting it to this machine according to instructions given in the device's instruction manual.

---

- (1) Make sure that the PictBridge compliant device is turned off.
- (2) Connect the PictBridge compliant device to the machine using a USB cable recommended by the manufacturer of the device.  
The device turns on automatically.  
If your device does not turn on automatically, turn it on manually.
- (3) Set up the PictBridge compliant device for direct printing.

 will appear on the LCD of the device when the machine is correctly connected.

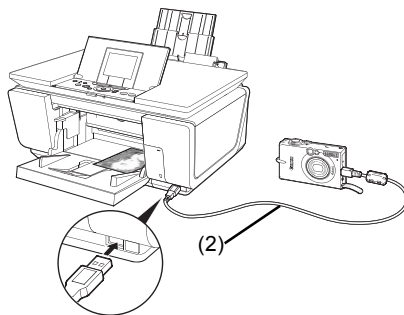

#### Note

If  does not appear, see “Cannot Print Properly from a Digital Camera” on page 91.

---



## ■ Printing Photographs Directly from a PictBridge Compliant Device

When operating the device, be sure to follow the instructions given in the instruction manual of your PictBridge compliant device. This section describes the page size, media type, layout, image optimization modes, and date printing mode that can be set on a PictBridge compliant device connected to the machine.

## ● Confirming or Changing PictBridge Print Settings from Your Camera

To change the page size or media type, operate the device to select the PictBridge print setup mode and confirm or change the settings.

### About the Settings Explained Below

Some setting items explained below may not be available on some devices. In this case, the **Default** setting explained below is applied for the setting item.

\* In the following description, names of settings items are given according to those used in Canon-brand PictBridge compliant devices. Setting item names may be different depending on the brand or model of your device.

The settings below can be changed in the **PictBridge settings** screen on the machine when a PictBridge compliant device is connected. However, changes can be made in the **PictBridge settings** screen on the machine only when the corresponding items below are in the Default setting items (the setting to follow that of the machine) on the PictBridge compliant device.

See “Confirming or Changing PictBridge Print Settings on the Machine” on page 48.

PictBridge compliant device setting items	Machine setting on the Print Setting screen
Paper size: Default	You can change the following settings on the <b>PictBridge settings</b> screen: <b>Page size, Media type, Bordered/Borderless</b> For the setting items, see “Setting items” on page 48.
Paper type: Default	
Layout: Default	
Image optimize: Default	You can change the following settings on the <b>PictBridge settings</b> screen: <b>Photo opt.pro, Vivid photo, Face brightener, Noise reduction, Image optimizer, Red eye correc., Brightness, Contrast, Color hue, Effects</b> For the setting items, see “Setting items” on page 48.

## ● Printable Image Data Format

This machine prints images taken with a DCF<sup>®</sup> (Design rule for Camera File system)-compatible digital camera\*, as well as PNG files.

\* Exif2.21 compliant

## ● Paper Size and Paper Type Settings

If these settings are set to **Default** (the setting to follow that of the machine) on the PictBridge compliant device, the **Page size** and the **Media type** settings specified in the **PictBridge settings** of the machine are applied.

The following sizes and types of printing paper can be loaded according to the **Paper size** and **Paper type** settings.

Paper Size Setting	Paper Type Setting	Loadable Paper* <sup>6</sup>
10 x 15 cm/4" x 6"	Photo	Photo Paper Plus Glossy
	Fast Photo	Photo Paper Pro
	Photo	Photo Paper Plus Semi-gloss
	Photo	Glossy Photo Paper
		Glossy Photo Paper "Everyday Use"
		Photo Paper Glossy
	Photo Stickers* <sup>1, *5</sup>	
13 x 18 cm/5" x 7" <sup>*2</sup>	Photo	Photo Paper Plus Glossy
A4* <sup>3, *4</sup>	Photo	Photo Paper Plus Glossy
	Fast Photo	Photo Paper Pro
	Photo	Photo Paper Plus Semi-gloss
	Photo	Glossy Photo Paper
	Photo	Glossy Photo Paper "Everyday Use"
8.5" x 11" (Letter)* <sup>3, *4</sup>	Photo	Photo Paper Plus Glossy
	Fast Photo	Photo Paper Pro
	Photo	Photo Paper Plus Semi-gloss
	Photo	Glossy Photo Paper
	Photo	Photo Paper Glossy
5.4 x 8.6 cm/Credit card	Photo	Glossy Photo Paper
20 x 25 cm/8" x 10" <sup>*7</sup>	Fast Photo	Photo Paper Pro
10.1 x 18 cm/4" x 7.1" <sup>*2</sup>	Fast Photo	Photo Paper Pro

\*1 Exclusively used to print photo stickers. When printing on sticker paper, select **10 x 15 cm/4" x 6"** in **Paper size**.

\*2 Can be selected only on certain Canon-brand PictBridge compatible devices.

\*3 **Plain Paper** can be selected for **Paper type** only when **Paper size** is set to **A4** or **8.5" x 11" (Letter)**. When **Paper type** is set to **Plain Paper**, borderless printing will be disabled even when **Layout** is set to **Borderless**.

\*4 You can print in 4-up layout when **Paper size** is set to **A4** or **8.5" x 11" (Letter)**.

\*5 Feeding this paper from the Cassette can damage the machine. Load in the Auto Sheet Feeder.

\*6 You may not be able to purchase some Canon genuine papers depending on your country.

\*7 When printing on Photo Paper Plus Semi-gloss 8" x 10" / 203.2 x 254.0 mm (SG-201), select **20 x 25 cm/8" x 10"** for **Paper size** and **Default** for **Paper type**.

\* Select **Photo Plus Glossy** for **Media type** in the **PictBridge settings** screen on the machine.

See "Confirming or Changing PictBridge Print Settings on the Machine" on page 48.

## ● Layout and Trimming Settings

If **Layout** is set to **Default** (the setting to follow that of the machine) on the PictBridge compliant device, the print setting specified in the **PictBridge settings** of the machine is applied. The setting on the PictBridge compliant device is applied for **Trimming**.

When printing onto Photo Stickers (PS-101), select **N-up** for **Layout**, then select **16-up**.

- \* Some PictBridge compliant devices may display the Layout option 2-up, 4-up, 9-up, and 16-up. In this case always select **16-up**.
- \* If there are no options on the PictBridge compliant device that correspond to **16-up**, printing on stickers is not possible.
- \* When printing on Photo Stickers (PS-101), do not set **Layout** to **Borderless**.

## ● Image Optimize Setting

If **Image optimize** is set to **Default** (the setting to follow that of the machine) on the PictBridge compliant device, the print setting specified in the **PictBridge settings** of the machine is applied. For details on the setting, see “Confirming or Changing PictBridge Print Settings from Your Camera” on page 45.

If you are using a Canon-brand PictBridge compatible device, additional options of **VIVID**, **NR**, **Face**, or **Red eye** may be available, depending on the model.

- \* **VIVID** prints green and blue portions of photos more vividly.  
**NR** (Noise Reduction) reduces noise in blue portions, such as the sky, and dark portions.  
**Face** corrects the contrast of backlit images.  
**Red eye** corrects red eyes.

## ● Date/File No. Print Setting

You cannot change this setting on this machine. The setting on the PictBridge compliant device is applied.

If the images already have dates superimposed when shot, set this PictBridge setting item to **Off**. If you select **Date**, **File No.**, or **Both**, the date and/or file number will be printed over the date printed by the camera's function.

## ● Other Settings

The following additional options are available for Canon-brand PictBridge-compliant devices, depending on the model. For details, refer to your Canon-brand PictBridge compliant device's instruction manual.

### Shooting Info (Exif Data)

You can print shooting Info (Exif Data) on photos in list format, or in the margins of specified photos. In **Layout** select the item with the “i” icon.

### 35 mm Film Style Layout (Contact Printing Layout)

You can print selected photos or index-specified photos in 35 mm film style layout (contact printing layout).

In **Layout** select the item with the film icon.

---

### Note

- Never disconnect the USB cable during printing unless when explicitly allowed to by the PictBridge compliant device.  
When disconnecting the USB cable between the PictBridge compliant device and machine, follow the instructions given in the device's instruction manual.
  - You cannot set or do the following by operating on the PictBridge compatible device.
    - Print quality setting
    - Machine maintenance
-

## ● Confirming or Changing PictBridge Print Settings on the Machine

You can confirm and change the print settings such as media type and size that are preset to the machine and applied to PictBridge printing.

### ● Displaying the PictBridge Settings Screen and Specifying the Settings

- (1) Turn on the machine.  
See "Turning the Machine On and Off" on page 4.
- (2) Select **Settings** on the **HOME** screen.  
See "Basic Operation for the Operation Panel" on page 2.
- (3) Select **Device settings**, then press the **OK** button.
- (4) Select **PictBridge settings**, then press the **OK** button.
- (5) Select the item to set, then press the **OK** button.
- (6) Select the item, then press the **OK** button.
- (7) Confirm the print settings, select **Next** and then press the **OK** button.
- (8) Repeat steps (5) and (6) to specify the item.
- (9) After finishing all settings you need, select **OK** and then press the **OK** button.

### ● Setting items

#### **Page size**

Select the page size, when printing directly from a PictBridge compliant device.

#### **Media type**

Select the media type, when printing directly from a PictBridge compliant device.

#### **Print quality**

Select the print quality, when printing directly from a PictBridge compliant device.

#### **Bordered/Borderless**

Select bordered or borderless print.

#### **Photo opt.pro**

Activate/deactivate the Photo Optimizer pro function.

Automatically optimizes brightness and tone of a photo.

#### **Vivid photo**

Activate/deactivate Vivid photo function.

Makes green and blue more lively.

#### **Face brightener**

Activate/deactivate Face brightener function.

Brightens a darkened face on the photo taken against the light.

#### **Noise reduction**

Activate/deactivate the Noise reduction function.

Reduces the noise on blue areas like the sky as well as on black areas.

#### **Image optimizer**

Activate/deactivate Image optimizer function.

Corrects and smooths the jagged contours for printing.

#### **Red eye correc.**

Activate/deactivate Red eye correction.

Corrects red eyes in portraits caused by flash photography.

#### **Brightness**

Adjust brightness.

**Contrast**

Adjust contrast.

**Color hue**

Adjust color hue.

**Effects**

Applies special effects to the photo, such as printing in sepia tones or with a sketch illustration like effect.

# Routine Maintenance

## Replacing an Ink Tank

When ink runs out, replace the ink tank. The machine will not print if the wrong type of ink tank is used, or if it is installed in the incorrect position.

The machine uses the following ink tanks.

Black: CLI-8BK



Cyan: CLI-8C

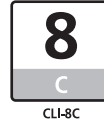
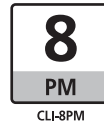

Photo Cyan: CLI-8PC



Photo Magenta: CLI-8PM



Black: PGI-5BK







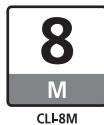

Yellow: CLI-8Y



Magenta: CLI-8M



### Note

- Be sure to install the ink tanks in the correct order. The proper arrangement from the left is Black , Photo Cyan , Black , Magenta , Cyan , Photo Magenta , Yellow .
- If printing becomes faint or white streaks appear despite sufficient ink levels, see “When Printing Becomes Faint or Colors Are Incorrect” on page 56.

### Getting the Ink Level Information

You can confirm the ink level in each ink tank by the ink lamps. Open the Scanning Unit (Printer Cover) of the machine to confirm how the ink lamps light or flash.

**Ink is low:**



The ink lamp flashes slowly (at around 3-second intervals). You can continue printing for a while, but we recommend you to have a replacement ink tank available.

**Ink is out:**



The ink lamp flashes quickly (at around 1-second intervals). Replace the ink tank with a new one.

\* If an ink tank related error message is displayed on the LCD, an ink tank error has occurred and the machine is unable to print. For details, see “Error Message Is Displayed on the LCD” on page 72.

## ■ Knowing When to Replace Ink Tank

Identify the empty ink tank on the LCD and replace it.

### If the “!” symbol is displayed above an ink tank

If the machine detects low ink when you start printing, the “!” symbol is displayed on the LCD. Obtain a replacement tank as soon as possible.

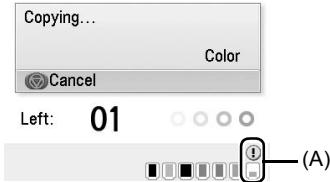

(A) Ink tanks with low ink

### If the “X” symbol is displayed above an ink tank

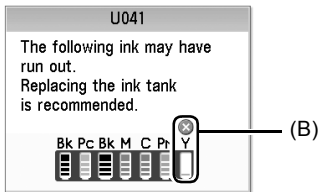

(B) Ink tanks that may have run out of ink.

- Ink may have run out. Replacing the ink tank is recommended.
- Press the **Stop/Reset** button to cancel printing. Replace the ink tank with a new one.
- If printing is in progress and you want to continue printing, press the **OK** button with the ink tank installed. Then printing can continue. Replacing the ink tank is recommended after the printing. The machine may be damaged if printing is continued under the ink out condition.

### If an empty ink tank is displayed distinctly from other ink tanks

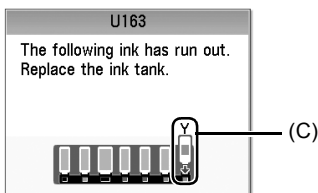

(C) Ink tanks with no ink

- Ink has run out. Replace the ink tank.  
Printing under the current condition may damage the machine.
- If you want to continue printing in this condition, you need to release the function for detecting the remaining ink level. Press and hold the **Stop/Reset** button for at least 5 seconds, and then release it.

\* With this operation, releasing the function for detecting the remaining ink level is memorized. Please be advised that Canon shall not be liable for any malfunction or trouble which may be caused by continuation of printing under the ink out condition.

## ■ Replacing Ink Tanks

When ink tanks run out of ink, replace them using the following steps.

### Important

#### Handling Ink

- To maintain optimal printing quality, we recommend the use of specified Canon brand ink tanks. Refilling ink is not recommended.
- Once you remove an ink tank, replace it immediately. Do not leave the machine with ink tanks removed.
- Replace empty tanks with new ones. Inserting partially used ink tanks may cause the nozzles to clog. Furthermore, with such tanks, the machine will not be able to inform you when to replace the tanks properly.
- Once an ink tank has been installed, do not remove it from the machine and leave it out in the open. This will cause the ink tank to dry out, and the machine may not operate properly when it is reinstalled. To maintain optimal printing quality, use an ink tank within six months of first use.
- Color ink may be consumed even when printing a black-and-white document or when black-and-white printing is specified.  
Color ink is also consumed in Print Head Cleaning and Print Head Deep Cleaning, which may be necessary to maintain the machine's performance. When an ink tank is out of ink, replace it immediately with a new one.

### 1 Open the Paper Output Tray.

(1) Put your finger on the top of the Paper Output Tray and open it gently.

### 2 Make sure that the machine is turned on, and raise the Scanning Unit (Printer Cover) until it stops.

The Print Head Holder moves to the center.

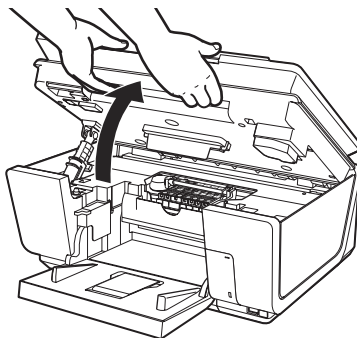

#### Caution

- Do not hold the LCD or the Operation Panel.
- If the Document Cover is opened, you cannot open the Scanning Unit (Printer Cover). Be sure to open the Scanning Unit (Printer Cover) and the Document Cover at the same time.

#### Important

If the Scanning Unit (Printer Cover) is left open for more than 10 minutes, the Print Head Holder moves to the right. Close and reopen the Scanning Unit (Printer Cover) to return the holder to the center.

### 3 Open the Inner Cover.

#### Caution

- Do not hold the Print Head Holder to stop or move it.
- Do not touch the metallic parts inside the machine.

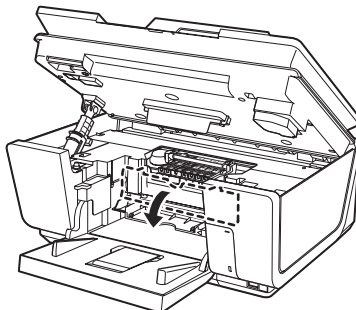



## 4 Remove the ink tank whose lamp is flashing fast.

(1) Push the tab and remove the ink tank.

### Important

- Handle ink tanks carefully to avoid staining clothing or the surrounding area.
- Discard empty ink tanks according to the local laws and regulations regarding disposal of consumables.

### Note

- Do not remove more than one ink tank at a time. Be sure to replace ink tanks one by one when replacing more than one ink tank.
- For details on ink lamp flashing speeds, see "Getting the Ink Level Information" on page 50.

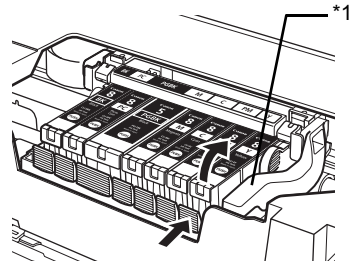

\*1 Do NOT touch the Print Head Lock Lever; remove only the ink tank.

## 5 Prepare the replacement tank.

(1) Remove the new ink tank from its packaging, then pull the orange tape in the direction of the arrow (A) so that the protective film does not remain on the air hole (B). Then remove the film completely (C).

### Important

Make sure that all the orange tape has been peeled off along the perforation. If part of the orange tape is remaining, ink may leak out when you remove the protective cap and may not eject properly when printing.

(2) Remove the orange protective cap from the bottom of the ink tank.  
Discard the cap once it is removed.

### Important

- Be sure to remove the clear film from the ink tank in the exact order shown in step 5-(1), as failure to follow this step may cause the ink to leak and stain your clothes and hands.
- Do not squeeze the side of ink tanks as this may cause the ink to leak out and stain your clothes and hands.
- Do not re-attach the protective cap once you have removed it. Discard it according to the local laws and regulations regarding disposal of consumables.
- Do not touch the open ink port once the protective cap is removed, as this may prevent the ink from being ejected properly.
- Be careful not to stain your clothes and hands with ink on the removed protective cap.

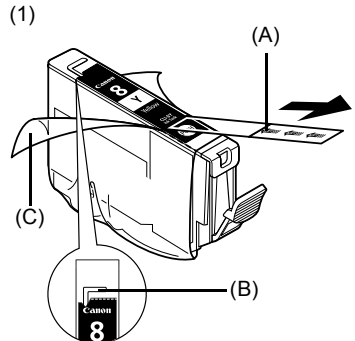

(2)

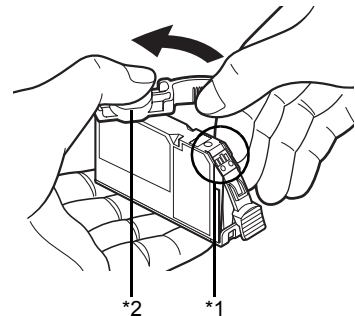

\*1 Do not touch the electrical contacts on the ink tank. Doing so can cause the machine to malfunction or become unable to print.

\*2 Carefully hold the protective cap when removing it to prevent the ink from staining your fingers.

## 6 Install the ink tank.

- (1) Insert the front end of the ink tank into the Print Head.
- (2) Press on the  mark on the ink tank until the ink tank snaps firmly into place.
- (3) Make sure that the ink lamp lights up red.

### Important

The machine cannot be used unless all the ink tanks are installed.

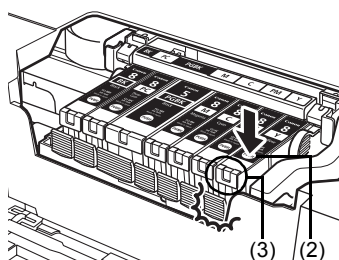
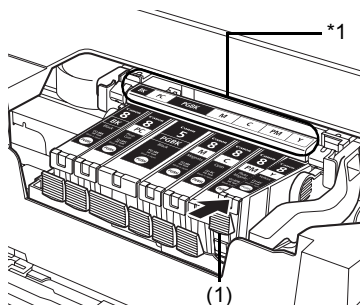

\*1 Make sure the position of the tank matches the label.

## 7 Close the Inner Cover.

### Note

Make sure that the Inner Cover is closed. Printing will not start with the Inner Cover open since paper can not be fed properly.

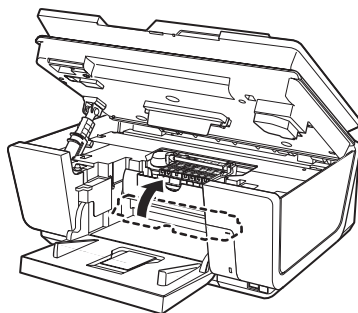

## 8 Gently close the Scanning Unit (Printer Cover).

### Caution

- Be sure to hold the Scanning Unit (Printer Cover) firmly using both hands, and be careful not to get your fingers caught.
- Do not hold the LCD or the Operation Panel.

### Note

- If the error message is still displayed after the Scanning Unit (Printer Cover) is closed, see "Error Message Is Displayed on the LCD" on page 72.
- When you start printing after replacing the ink tank, Print Head Cleaning is performed automatically. Do not perform any other operations until Print Head Cleaning finishes.

# Keeping the Best Printing Results

---

To avoid drying of the Print Head and clogging of the nozzles, note the following.

## ■ When You Turn Off the Machine

Follow the procedure below to turn off the machine.

- (1) Press the **ON/OFF** button to turn off the machine.
- (2) Confirm that the **POWER** lamp has gone out.  
This takes a few seconds or as long as around 30 seconds.
- (3) Unplug the power cord from the wall outlet.  
If you are using a power outlet strip, you can switch it off instead.

When you press the **ON/OFF** button to turn off the machine, the machine automatically puts a protective cap on the Print Head to prevent the ink from drying. If you remove the power cord or switch off the power outlet strip before the **POWER** lamp goes out, this capping will not be done properly, causing the Print Head to dry and clog.

## ■ When You Are Not Using the Machine for a Long Time

When you are not using the machine for a long time, print or copy in both black & white and in color, or perform Print Head Cleaning, about once a month to prevent degradation of the Print Head.

Numerous nozzles are installed in the Print Head for high-precision printing. Just as the uncapped tip of a ballpoint pen or marker becomes dry and unusable if it is not used for a long period of time, the print head nozzles become blocked by dried ink. Periodically printing or cleaning the Print Head can prevent this blockage.

---

### Note

- If the printed area is traced with a highlight pen or paint-stick or stained with water or sweat, ink may blur depending on the paper.
  - If the print head nozzles get clogged, printouts will become faint or particular colors will not be printed properly. For details, see "When Printing Becomes Faint or Colors Are Incorrect" on page 56.
-

# When Printing Becomes Faint or Colors Are Incorrect

When printing becomes faint or colors are incorrect even if ink remains in the ink tanks, the print head nozzles are probably clogged. Print the nozzle check pattern to confirm the condition of the nozzles and then perform Print Head Cleaning.

If the ruled lines are shifted after running print head maintenance, align the Print Head.

## Note

### Before performing maintenance

- Open the Scanning Unit (Printer Cover) and make sure that all lamps for the ink tanks are lit red.
  - If any one of the lamps is flashing slowly, the associated ink tank is running low. You can continue printing for a while, but we recommend you to have a replacement ink tank available.
  - If any one of the lamps is flashing fast, the associated ink tank is empty. Replace the ink tank. See “Replacing Ink Tanks” on page 52.
- If an ink lamp is flashing fast even though ink remains in that ink tank, it is inserted in the wrong position. Make sure that the ink tank of the correct color is inserted in each position, matching the label. See “Replacing an Ink Tank” on page 50.
- If the ink lamp is not lit, the tank is not set properly. Press the  mark on the ink tank until the tank clicks into place. Make sure that all packaging material is peeled off the ink tank. See “Prepare the replacement tank.” on page 53.
- Increase the **Print Quality** setting in the printer driver settings. See “Print Results Not Satisfactory” on page 78.

## Step 1

See “Printing the Nozzle Check Pattern” on page 57.

If lines are missing or if white streaks appear



## Step 2

See “Print Head Cleaning” on page 60.

If the problem is not resolved after performing Print Head Cleaning twice



## Step 3

See “Print Head Deep Cleaning” on page 62.



After cleaning the Print Head, print and examine the nozzle check pattern.

## Note

If Print Head Deep Cleaning does not resolve the problem, the Print Head may be damaged. Contact your Canon service representative.

## ● If the Ruled Lines Are Shifted

### Step 1

See “Aligning the Print Head” on page 64.

# Printing the Nozzle Check Pattern

Print the nozzle check pattern to determine whether the ink ejects properly from the Print Head.

## Note

Make sure that the Inner Cover is closed.

- 1 Make sure that the machine is turned on, then load a sheet of A4 or Letter-sized plain paper in the Auto Sheet Feeder or the Cassette.
- 2 Open the Paper Output Tray, and then open the Output Tray Extension.
  - (1) Put your finger on the top of the Paper Output Tray and open it gently.
  - (2) Open the Output Tray Extension.
- 3 Press the **Paper Feed Switch** to select the paper source where you have loaded paper.
- 4 Print the nozzle check pattern.

- (1) Select **Settings** on the **HOME** screen.  
See “Basic Operation for the Operation Panel” on page 2.
- (2) Select **Maintenance**, then press the **OK** button.  
The Maintenance screen is displayed.
- (3) Select **Nozzle check pattern** and then press the **OK** button.  
The pattern print confirmation screen is displayed.

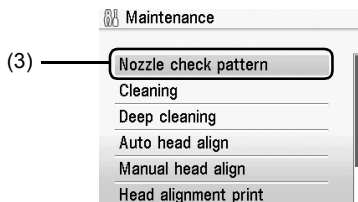

- (4) Select **Yes** and then press the **OK** button.  
The nozzle check pattern is printed, and the pattern confirmation screens are displayed alternately.

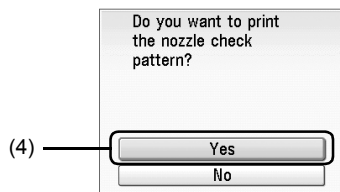

- 5 Examine the pattern and take the appropriate action.  
See “Examining the Nozzle Check Pattern” on page 58.

# Examining the Nozzle Check Pattern

Follow the procedure below to examine the nozzle check pattern, and perform cleaning if necessary.

**Note**

If the ink level is low, the nozzle check pattern is not printed correctly. Replace the relevant ink tank. See “Replacing an Ink Tank” on page 50.

**1** Check the nozzle check pattern you printed.

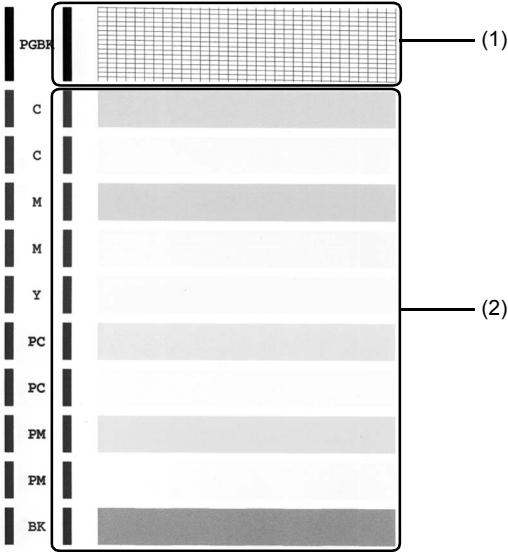

(1) Check if lines in this pattern are missing.



(A)

(B)

(A) Good

(B) Lines are missing

(2) Check if there are white streaks in this pattern.



(A)

(B)

(A) Good

(B) White streaks present

**2** The confirmation screens for white streaks and missing lines are displayed alternately. Select the pattern that is closer to the nozzle check pattern that you printed.

- If There Are No Missing Lines and No White Streaks

(1) Select **All A** and press the **OK** button.  
The LCD returns to the Maintenance screen.

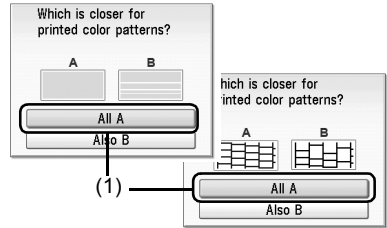

- If Lines Are Missing or White Streaks Are Present

(1) Select **Also B** and press the **OK** button.  
The cleaning confirmation screen is displayed.

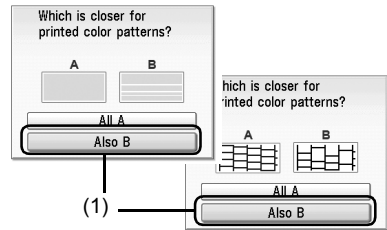

(2) Select **Yes** and press the **OK** button to start Print Head Cleaning.  
See "Print Head Cleaning" on page 60.

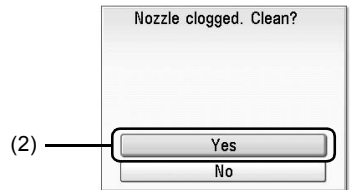

# Print Head Cleaning

Clean the Print Head if lines are missing or if white streaks appear in the printed nozzle check pattern. Cleaning unclogs the nozzles and restores the print head condition. Note that cleaning the Print Head causes used ink to be absorbed in the ink absorber. Cleaning the Print Head consumes ink, so perform Print Head Cleaning only when necessary.

## Note

Make sure that the Inner Cover is closed.

- 1 Make sure that the machine is turned on, then load a sheet of A4 or Letter-sized plain paper in the Auto Sheet Feeder or the Cassette.
- 2 Open the Paper Output Tray, and then open the Output Tray Extension.
  - (1) Put your finger on the top of the Paper Output Tray and open it gently.
  - (2) Open the Output Tray Extension.
- 3 Press the **Paper Feed Switch** to select the paper source where you have loaded paper.
- 4 Start Print Head Cleaning.

- (1) Select **Settings** on the **HOME** screen.  
See "Basic Operation for the Operation Panel" on page 2.
- (2) Select **Maintenance**, then press the **OK** button.  
The Maintenance screen is displayed.
- (3) Select **Cleaning**, then press the **OK** button.  
The confirmation screen is displayed.

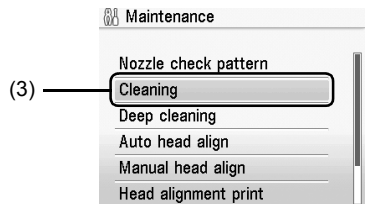

- (4) Select **Yes**, then press the **OK** button.  
Print Head Cleaning starts.  
Do not perform any other operations until Print Head Cleaning finishes. This takes about 1 minute.  
The pattern print confirmation screen is displayed.
- (5) Select **Yes**, then press the **OK** button.  
The nozzle check pattern is printed.





**5** Check the print head condition with the printed nozzle check pattern, and take appropriate action.

See “Examining the Nozzle Check Pattern” on page 58.

---

 **Note**

If the problem is not resolved after performing steps 4 and 5 twice, try **Print Head Deep Cleaning**. See “Print Head Deep Cleaning” on page 62.

---

# Print Head Deep Cleaning

If print quality does not improve by standard Print Head Cleaning, try Print Head Deep Cleaning, which is a more powerful process. Note that cleaning the Print Head causes used ink to be absorbed in the ink absorber. Print Head Deep Cleaning consumes more ink than standard Print Head Cleaning, so perform this procedure only when necessary.

## Note

Make sure that the Inner Cover is closed.

- 1 Make sure that the machine is turned on, then load a sheet of A4 or Letter-sized plain paper in the Auto Sheet Feeder or the Cassette.
- 2 Open the Paper Output Tray, and then open the Output Tray Extension.
  - (1) Put your finger on the top of the Paper Output Tray and open it gently.
  - (2) Open the Output Tray Extension.
- 3 Press the **Paper Feed Switch** to select the paper source where you have loaded paper.
- 4 Start Print Head Deep Cleaning.
  - (1) Select **Settings** on the **HOME** screen.  
See "Basic Operation for the Operation Panel" on page 2.
  - (2) Select **Maintenance**, then press the **OK** button.  
The Maintenance screen is displayed.
  - (3) Select **Deep cleaning**, then press the **OK** button.  
The confirmation screen is displayed.

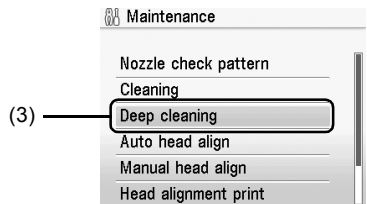

- (4) Select **Yes**, then press the **OK** button.  
Print Head Deep Cleaning starts.  
Do not perform any other operations until Print Head Deep Cleaning finishes. This takes about 1 minute 30 seconds.

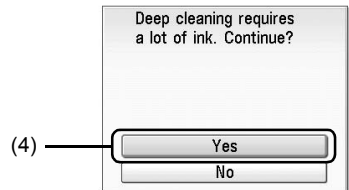

## **5** Check the condition of the Print Head.

- (1)** Print the nozzle check pattern to check the print head condition.  
See "Printing the Nozzle Check Pattern" on page 57.  
If a particular color is not printed properly, replace the ink tank of that color.  
See "Replacing an Ink Tank" on page 50.
- (2)** If the print head nozzles are still not clean, turn off the machine and perform another Print Head Deep Cleaning after 24 hours.
- (3)** If this does not solve the problem, the Print Head may be damaged. Contact your Canon service representative.

# Aligning the Print Head

If ruled lines are printed misaligned or print results are otherwise unsatisfactory, adjust the print head position.

## Note

Make sure that the Inner Cover is closed.

## Automatic Print Head Alignment

### Note

You cannot feed paper from the Cassette when performing Automatic Print Head Alignment. Always load paper in the Auto Sheet Feeder.

- 1 Make sure that the machine is turned on, and then load a sheet of A4 or Letter-sized plain paper in the Auto Sheet Feeder.
- 2 Open the Paper Output Tray, and then open the Output Tray Extension.
  - (1) Put your finger on the top of the Paper Output Tray and open it gently.
  - (2) Open the Output Tray Extension.
- 3 Adjust the print head position.
  - (1) Select **Settings** on the **HOME** screen.  
See "Basic Operation for the Operation Panel" on page 2.
  - (2) Select **Maintenance**, then press the **OK** button.  
The Maintenance screen is displayed.
  - (3) Select **Auto head align**, then press the **OK** button.  
The confirmation screen is displayed.

### Note

If you select **Head alignment print**, the machine exits the process after printing the current head position adjustment values.

- (4) Select **Yes**, then press the **OK** button.  
The print head is aligned automatically, and the print head pattern after the adjustment is printed out. This takes about 3 minutes 30 seconds.

### Note

- The print head alignment pattern is printed in black and blue.
- If adjustment was not done successfully, the "**Auto head align has failed.**" error message is displayed on the LCD. For details, see "Error Message Is Displayed on the LCD" on page 72.
- If results of Automatic Print Head Alignment are not satisfactory, perform Manual Print Head Alignment. For details, see "Manual Print Head Alignment" on page 65.

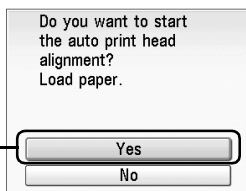
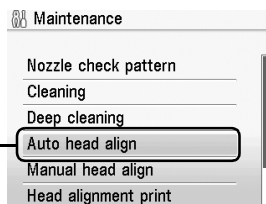

## ■ Manual Print Head Alignment

If the results of Automatic Print Head Alignment are not satisfactory, follow the procedure below to perform Manual Print Head Alignment.

For details on performing Automatic Print Head Alignment, see “Automatic Print Head Alignment” on page 64.

- 1 Make sure that the machine is turned on, and then load three sheets of A4 or Letter-sized plain paper in the Auto Sheet Feeder or the Cassette.

---

### Important

You cannot print the print head alignment pattern if paper of size other than A4 or Letter is loaded. Be sure to use A4 or Letter-sized plain paper.

---

- 2 Open the Paper Output Tray, and then open the Output Tray Extension.
  - (1) Put your finger on the top of the Paper Output Tray and open it gently.
  - (2) Open the Output Tray Extension.
- 3 Press the **Paper Feed Switch** to select the paper source where you have loaded paper.
- 4 Select **Settings** on the **HOME** screen.  
See “Basic Operation for the Operation Panel” on page 2.
- 5 Select **Maintenance**, then press the **OK** button.  
The Maintenance screen is displayed.
- 6 Select **Manual head align**, then press the **OK** button.  
Confirmation screen is displayed.

---

### Note

If you select **Head alignment print**, the machine exits the process after printing the current head position adjustment values.

---

- 7 Select **Yes**, then press the **OK** button.
- 8 When the Print Head alignment pattern is printed, select **Yes**, then press the **OK** button.

**9** Look at the printout. From the patterns, select the most even, least irregular patterns for each column and input their numbers. Press the **OK** button.

- (1) Select a column to input the pattern number.
- (2) Use the ◀ or ▶ button to input the number of the pattern.
- (3) Repeat the steps (1) and (2) until you finish inputting all pattern numbers, press the **OK** button.

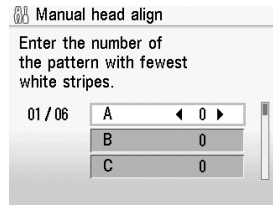
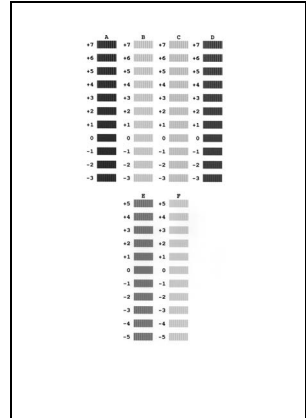

**10** When the confirmation message is displayed, press the **OK** button.

**11** Look at the printout. From the patterns, select the best patterns for each column and input their numbers. Press the **OK** button.

In the same way in step 9, input the numbers.

Columns G to J are striped vertically and column K is striped horizontally. For Column K, the best pattern will be smooth and have no streaks in the border indicated by the arrows.

**Note**

If it is difficult to pick the best pattern, pick the setting that produces the least noticeable vertical white streaks.

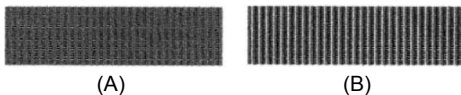

- (A) Less noticeable white streaks  
 (B) More noticeable white streaks

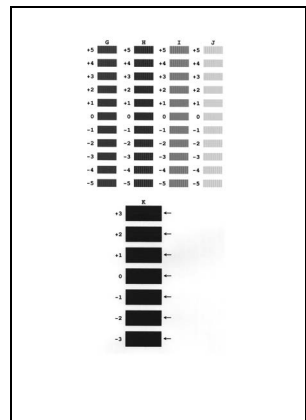

**12** When the confirmation message is displayed, press the **OK** button.

- 13** Look at the printout. From the patterns, select the most even patterns for each column and input their numbers. Press the **OK** button.  
In the same way in step 9, input the numbers.

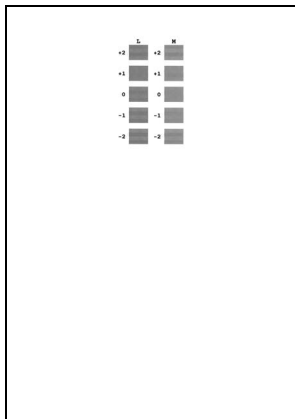

---

**Note**

When you turn off the machine, be sure to press the **ON/OFF** button on the machine. Otherwise, the settings made here will not be saved.

---

# Cleaning Your Machine

---

This section describes the cleaning procedure that is needed to maintain your machine.

---

## **Caution**

- Be sure to turn off the power and disconnect the power cord before cleaning the machine.
  - Do not use tissue paper, paper towels, or similar materials for cleaning. Paper tissue powders or fine threads may remain inside the machine and cause problems such as a blocked Print Head and poor printing results. Use a soft cloth to avoid scratching the components.
  - Never use volatile liquids such as thinners, benzene, acetone, or any other chemical cleaner to clean the machine; these can damage the machine's components.
- 

## ■ **Cleaning the Platen Glass and Document Cover**

Moisten a clean, soft, lint-free cloth and wring out excess water. With it, wipe the Platen Glass (A), the inner side of the Document Cover (white sheet) (B), and FAU lamp (C). Then wipe with another clean, soft, dry, lint-free cloth, making sure not to leave any residue, especially on the Platen Glass.

---

## **Important**

The sheet (B) is easily damaged, so wipe it gently.

---

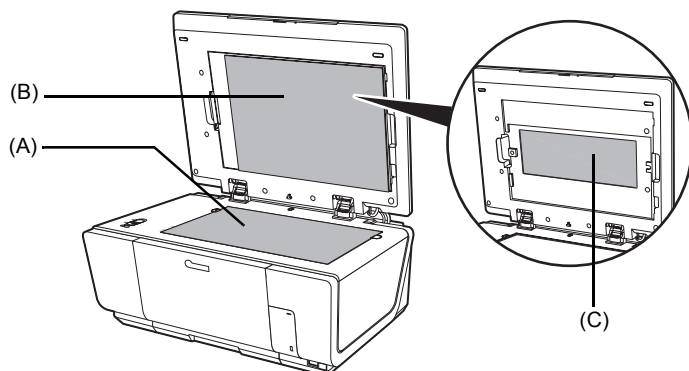

## ■ **Cleaning the Paper Feed Rollers (Roller Cleaning)**

Clean the paper feed rollers if paper is not fed properly. Cleaning the paper feed rollers will wear the rollers, so perform this only when necessary.

---

### **Note**

Make sure that the Inner Cover is closed.

---

- 1 Make sure that the machine is turned on, and then remove any paper from the Auto Sheet Feeder and Cassette.
  - 2 Press the **Paper Feed Switch** to select the paper source to clean.
-



### 3 Clean the paper feed rollers.

- (1) Select **Settings** on the **HOME** screen.  
See "Basic Operation for the Operation Panel" on page 2.  
The Settings screen is displayed.
- (2) Select **Maintenance**, then press the **OK** button.  
The Maintenance screen is displayed.
- (3) Select **Roller cleaning**, then press the **OK** button.  
The confirmation screen is displayed.
- (4) Select **Yes**, then press the **OK** button.  
The Paper Feed Rollers will rotate as they clean.

### 4 Repeat step 3 twice.

### 5 Open the Paper Output Tray, and then open the Output Tray Extension.

- (1) Put your finger on the top of the Paper Output Tray and open it gently.
- (2) Open the Output Tray Extension.

### 6 Load three or more sheets of A4 or Letter-sized plain paper in portrait orientation in the paper source you selected in step 2.

### 7 Repeat step 3 three times.

The paper cleans the inside of the machine as it feeds through the machine.

If there are no signs of improvement after performing cleaning three times, contact a Canon service representative.

## ■ Cleaning the Inside of the Machine (Bottom Plate Cleaning)

This section describes how to clean the inside of the machine. If the inside of the machine becomes dirty, printed paper may get dirty, so we recommend performing cleaning regularly.

---

#### **Note**

Make sure that the Inner Cover is closed.

---

- 1 Make sure that the machine is turned on, and then remove any paper from the Auto Sheet Feeder.
- 2 Open the Paper Output Tray, and then open the Output Tray Extension.
  - (1) Put your finger on the top of the Paper Output Tray and open it gently.
  - (2) Open the Output Tray Extension.
- 3 Fold a single sheet of A4 or Letter-sized plain paper in half widthwise, and then unfold the paper.

- 4 Load this and only this sheet of paper in the Auto Sheet Feeder with the open side to the front.

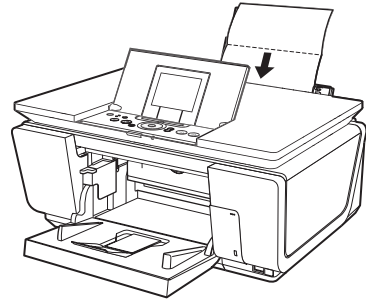

- 5 Perform bottom plate cleaning.

- (1) Select **Settings** on the **HOME** screen.  
See "Basic Operation for the Operation Panel" on page 2.  
The Settings screen is displayed.
- (2) Select **Maintenance**, then press the **OK** button.  
The Maintenance screen is displayed.
- (3) Select **Bottom plate cleaning**, then press the **OK** button.  
The confirmation screen is displayed.
- (4) Select **Yes**, then press the **OK** button.  
The paper cleans the inside of the machine as it feeds through the machine.  
If the ejected paper is smudged, clean the inside of the machine again.  
If the problem is not resolved after performing cleaning again, the protrusions inside the machine may be stained. Clean them according to instructions. See "Cleaning the Protrusions Inside the Machine" on page 70.

---

**Important**

- Even if the Cassette is selected as the paper source, paper will be fed from the Auto Sheet Feeder.
  - Do not perform any other operation while the bottom plate is being cleaned.
- 

■ **Cleaning the Protrusions Inside the Machine**

If protrusions inside the machine are stained, wipe off any ink from the protrusions using a cotton swab or the like.

---

**Important**

Before cleaning the inner parts, be sure to turn the machine off.

---

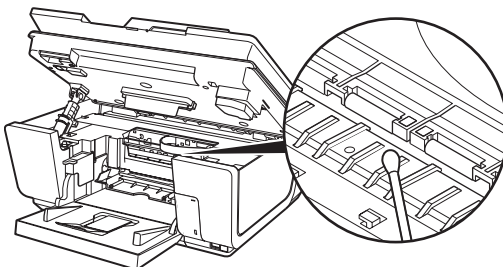

# Troubleshooting









This section describes troubleshooting tips for problems you may encounter when using the machine.

---

## Note

If you cannot find appropriate tips for your problem, refer to the on-screen manuals.

---

- “Error Message Is Displayed on the LCD” on page 72
- “LCD Cannot Be Seen At All” on page 74
- “An Unintended Language Is Displayed on the LCD” on page 75
- “Cannot Install the MP Drivers” on page 76
- “Cannot Connect to Computer Properly” on page 77
  - “Printing Speed Is Slow / USB 2.0 Hi-Speed Connection Does Not Work” on page 77
  -  “Hi-Speed USB Device Plugged into non-Hi-Speed USB Hub” or “This Device Can Perform Faster” Message Is Displayed (Windows XP Only)” on page 77
- “Print Results Not Satisfactory” on page 78
  - “Cannot Print to End of Job” on page 78
  - “Part of the Page Is Not Printed” on page 78
  - “Colors Are Unclear” on page 78
  - “Ink Does Not Come Out/Printing Does Not Start/Printing Is Blurred/Colors Are Wrong/Straight Lines Are Misaligned” on page 79
  - “White Streaks” on page 80
  - “Printed Paper Curls or Has Ink Blots” on page 80
  - “Printed Surface Is Scratched/Paper Is Smudged” on page 80
  - “Colors Are Uneven or Streaked” on page 82
  - “Printing Problems When Copying” on page 82
- “Printing Does Not Start” on page 82
- “Paper Does Not Feed Properly” on page 84
- “Paper Jams” on page 85
- “Error Message Appears on the Screen” on page 88
  -  “Writing Error/Output Error/Communication Error” on page 88
  - “Error Regarding Automatic Duplex Printing Is Displayed” on page 89
  -  “Error No.: 300 Is Displayed” on page 89
  -  “Error No.: 1700 Is Displayed” on page 90
  -  “Error No.: 1851 Is Displayed” on page 90
  -  “Error No.: 1856 Is Displayed” on page 90
  -  “Error No.: 2001 Is Displayed” on page 90
  -  “Error No.: 2500 Is Displayed” on page 90
- “Cannot Print Properly from a Digital Camera” on page 91
- “Cannot Print Properly from a Photo Index Sheet” on page 92
- “Cannot Scan Films” on page 93
  - “Cannot Obtain a Clean Scan or Colors Scan Incorrectly (Displayed Image Is Not Clear)” on page 93
  - “Frames Are Not Detected Correctly” on page 93

## If an Error Occurs When the Machine Is Connected to a Computer

When an error occurs in printing such as the machine is out of paper or paper is jammed, a troubleshooting message is displayed automatically. Take the appropriate action described in the message.

The message may vary depending on the version of your Windows operating system.

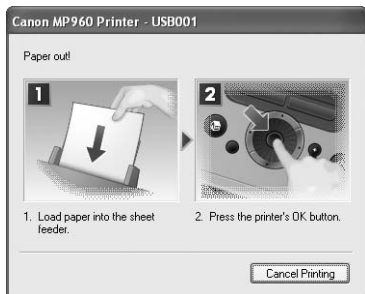

## Error Message Is Displayed on the LCD

If an error message is displayed on the LCD, take the corresponding action described below.

Message	Action
"There are no photos in memory card."	<ul style="list-style-type: none"> <li>There are no image data stored on the memory card that can be read by this machine.</li> <li>The machine may not recognize the file if the file name or the folder path contains certain characters. Use only alphanumeric characters.</li> <li>Photo data edited or processed on a computer must be printed from the computer.</li> </ul>
"The following ink may have run out. Replacing the ink tank is recommended." U041	<p>If the lamp on the ink tank is flashing, ink may have run out. Replacing the ink tank is recommended.</p> <p>If printing is in progress and you want to continue printing, press the <b>OK</b> button with the ink tank installed. Then printing can continue. Replacing the ink tank is recommended after the printing. The machine may be damaged if printing is continued under the ink out condition. See "Replacing an Ink Tank" on page 50.</p> <p><b>Note</b></p> <p>If multiple ink lamps are flashing red, check how fast they are flashing. Fast flashing (at about 1-second intervals) indicates the tank is empty. Slow flashing (at about 3-second intervals) indicates ink is low. For details on different flashing speeds, see "Getting the Ink Level Information" on page 50.</p>
"The following ink has run out. Replace the ink tank." U163	<p>Ink has run out. (The lamp on the ink tank flashes.)</p> <p>Replace the ink tank and close the Scanning Unit (Printer Cover). Printing under the current condition may damage the machine.</p> <p>If you want to continue printing in this condition, you need to release the function for detecting the remaining ink level. Press and hold the <b>Stop/Reset</b> button for at least 5 seconds, and then release it.</p> <p>* With this operation, releasing the function for detecting the remaining ink level is memorized. Please be advised that Canon shall not be liable for any malfunction or trouble which may be caused by continuation of printing under the ink out condition.</p> <p>See "Replacing an Ink Tank" on page 50.</p>

Message	Action
<p>"Print head is not installed. Install the print head." U051</p> <p>"The type of print head is incorrect. Install the correct print head." U052</p>	<p>Follow the directions given in the <i>Easy Setup Instructions</i> to install the Print Head.</p> <p>If the Print Head is already installed, remove the Print Head once and then reinstall it.</p> <p>If the error is not resolved, the Print Head may be damaged. Contact your Canon service representative.</p>
<p>"Inner cover is open. Close the inner cover and press OK."</p>	<p>If the Inner Cover is open when starting printing, close it and then press the <b>OK</b> button on the machine.</p> <p>Do not open or close the Inner Cover while printing, as this can damage the machine.</p>
<p>"Some ink tanks are not installed in place." U072</p> <p>"More than one ink tank of the following color is installed." U071</p>	<p>Possible causes are as follows:</p> <ul style="list-style-type: none"> <li>● Some ink tanks are not installed in the correct position.</li> <li>● More than one ink tanks of the same color are installed.</li> </ul> <p>Confirm that the ink tanks are installed in the appropriate positions. See "Replacing an Ink Tank" on page 50.</p>
<p>"The ink absorber is almost full. Press OK to continue printing. Contact the service center."</p>	<p>The machine has a built-in ink absorber to hold the ink used during Print Head Cleaning, for example.</p> <p>This error message indicates that the ink absorber is nearly full.</p> <p>Press the <b>OK</b> button to cancel the error so you can continue printing.</p> <p>However, because printing is disabled once the ink absorber becomes completely full and until the ink absorber is replaced, you are recommended to contact a Canon service representative as early as possible. (You will need to replace a particular part of the machine.)</p>
<p>"The device may be incompatible. Remove the device and check the manual supplied with the connected device."</p>	<p>Disconnect the cable connecting the machine and the device, and then reconnect it.</p> <p>Depending on the model or brand of your device, you may have to select a PictBridge-compliant print mode on the device before connecting it to the machine. You may also have to turn on the camera or select Play mode manually after connecting the device to the machine. Perform necessary operations according your device's instruction manual.</p> <p>If the error is still not resolved, there is a possibility that you are using a digital camera or digital video camcorder that is not supported by this machine. Use a digital camera or digital video camcorder compatible with this machine.</p>
<p>"Auto head align has failed. Press OK and repeat operation. &lt;See manual&gt;"</p>	<p>Possible causes are as follows:</p> <ul style="list-style-type: none"> <li>● Paper of size other than A4 or Letter is loaded in the Auto Sheet Feeder. <ul style="list-style-type: none"> <li>Press the <b>OK</b> button on the machine to dismiss the error message, then load a sheet of A4/Letter-sized paper in the Auto Sheet Feeder.</li> <li>Automatic Print Head Alignment cannot be performed using paper from the Cassette. For Automatic Print Head Alignment, always load paper in the Auto Sheet Feeder.</li> </ul> </li> <li>● Print Head nozzles are clogged. <ul style="list-style-type: none"> <li>Press the <b>OK</b> button to dismiss the error message, and print the nozzle check pattern to check the status of the Print Head. See "Printing the Nozzle Check Pattern" on page 57.</li> </ul> </li> <li>● The Paper Output Slot is exposed to strong light. <ul style="list-style-type: none"> <li>Press the <b>OK</b> button to dismiss the error message, and then adjust your operating environment and/or the position of the machine so that the Paper Output Slot is not exposed directly to strong light.</li> </ul> </li> </ul> <p>After carrying out the above measures, if the problem continues after aligning the Print Head again, press the <b>OK</b> button to dismiss the error message, and then perform Manual Print Head Alignment. For details on Manual Print Head Alignment, see "Manual Print Head Alignment" on page 65.</p>



Message	Action
<p>"The remaining level of the following ink cannot be correctly detected. Replace the ink tank." U130</p>	<p>The remaining ink level cannot be correctly detected. Replace the ink tank and close the Scanning Unit (Printer Cover). Printing with an ink tank that was once empty may damage the machine. If you want to continue printing in this condition, you need to release the function for detecting the remaining ink level. Press and hold the <b>Stop/Reset</b> button for at least 5 seconds, and then release it.</p> <p>* With this operation, releasing the function for detecting the remaining ink level is memorized. Please be advised that Canon shall not be liable for any machine malfunction or damage caused by refilled ink tanks. See "Replacing an Ink Tank" on page 50.</p>
<p>"The following ink tank cannot be recognized." U140 U150</p>	<ul style="list-style-type: none"> <li>● The ink tank is not compatible with this machine. (The lamp on the ink tank is off.) Install an appropriate ink tank. See "Replacing an Ink Tank" on page 50.</li> <li>● An Ink tank error has occurred. (The lamp on the ink tank is off.) Replace the ink tank. See "Replacing an Ink Tank" on page 50.</li> </ul>
<p>***** Error code"</p>	<p>Turn off the machine, and unplug the power cord of the machine from the power supply. After a while, plug the power cord of the machine back in, and then turn on the machine. If the same error occurs, contact a Canon service representative.</p>
<p>"Scanner is not operating correctly."</p>	<p>Turn off the machine, and unplug the power cord of the machine from the power supply. After a while, plug the power cord of the machine back in, and then turn on the machine. If the same error occurs, contact a Canon service representative.</p>
<p>"Release the scanner lock switch and turn the power off and back on."</p>	<p>The Scanner Lock Switch is not released. Slide the Scanner Lock Switch to the release position  and press the <b>ON/OFF</b> button to turn the machine off. Then, turn the power back on. If this error still remains, contact a Canon service representative.</p>
<p>"The card is currently write-enabled. Set to read-only mode before performing operation."</p>	<p>The Card Slot is set to <b>Read/write mode</b>. You cannot print in this mode. After writing on the memory card, set to <b>Read-only mode</b>.</p>

## LCD Cannot Be Seen At All



Cause	Action
<p>Cannot see the display on the LCD.</p>	<ul style="list-style-type: none"> <li>● If the <b>POWER</b> lamp is off The machine is not powered on. Connect the power cord and press the <b>ON/OFF</b> button. The machine will power on and the LCD will display a message.</li> <li>● If the <b>POWER</b> lamp is lit The LCD may be in the screen-saver mode. On the Operation Panel, press a button other than the <b>ON/OFF</b> button.</li> </ul>

## An Unintended Language Is Displayed on the LCD



---

Cause	Action
The language you want to be displayed is not selected.	<p>Select the language you want to be displayed according to the following procedure.</p> <ol style="list-style-type: none"><li data-bbox="415 256 1028 300">(1) Press the <b>HOME</b> button. Wait for about 5 seconds, select , and then press the <b>OK</b> button.</li><li data-bbox="415 300 1028 325">(2) Press the <b>▶</b> button to select , then press the <b>OK</b> button.</li><li data-bbox="415 325 1028 395">(3) Press the <b>▼</b> button four times, then press the <b>OK</b> button. If the Bluetooth unit is connected to the machine, press the <b>▼</b> button five times, and then press the <b>OK</b> button.</li><li data-bbox="415 395 1028 435">(4) Press the <b>▲</b> or <b>▼</b> button to select the language you want to be displayed, then press the <b>OK</b> button.</li></ol>

# Cannot Install the MP Drivers

Cause	Action
<p><b>Windows</b></p> <p>Unable to proceed beyond the <b>Printer Connection</b> screen.</p>	<p>If you were unable to proceed beyond the <b>Printer Connection</b> screen, follow the procedure below to reinstall the MP Drivers.</p>  <ol style="list-style-type: none"> <li>(1) Click <b>Cancel</b> on the <b>Printer Connection</b> screen.</li> <li>(2) Click <b>Start Over</b> on the <b>Installation Failure</b> screen.</li> <li>(3) Click <b>Back</b> on the screen that appears next.</li> <li>(4) Click <b>Exit</b> on the <b>Welcome</b> screen, then remove the CD-ROM.</li> <li>(5) Turn the machine off.</li> <li>(6) Restart the computer.</li> <li>(7) Make sure you have no application software running, including anti-virus software.</li> <li>(8) Follow the procedure described in the <i>Easy Setup Instructions</i> to reinstall the MP Drivers.</li> </ol>
<p>Installation does not start automatically when the <i>Setup CD-ROM</i> is inserted into your computer's disc drive.</p>	<p><b>Windows</b></p> <p>Click <b>Start &gt; My Computer</b> &gt; double-click the CD-ROM icon .</p> <p>In non-XP Windows, open the <b>My Computer</b> window and then double-click the CD-ROM icon .</p> <p><b>Note</b></p> <p>To use the Run command to start the setup program, specify your disc drive and then the name of the setup program, Msetup4.exe. The drive letter of the disc drive depends on your computer.</p> <p><b>Macintosh</b></p> <p>Double-click the CD-ROM icon on your desktop to start installation.</p> <p>If the CD-ROM icon is not displayed on the desktop, there may be a problem with the CD-ROM. Contact a Canon service representative.</p>
<p>Installation procedure not followed correctly.</p>	<p>Follow the procedure described in the <i>Easy Setup Instructions</i> for proper installation.</p> <p>If the drivers were not installed correctly, uninstall the MP Drivers, restart your computer, and then reinstall the drivers. Refer to the <i>Printer Driver Guide</i> on-screen manual.</p> <p><b>Windows</b></p> <p><b>Note</b></p> <p>If the installer was forced to be terminated due to an Windows error, the system may be in an unstable condition and you may not be able to install the drivers. Restart your computer before reinstalling.</p>



Cause	Action
The <i>Setup CD-ROM</i> is defective.	<p><b>Windows</b></p> <p>Click <b>Start</b>, select <b>My Computer</b>, and confirm that the CD-ROM icon  is visible.</p> <p>In non-XP Windows, double-click the <b>My Computer</b> icon and confirm that the CD-ROM icon  is visible in the window.</p> <p><b>Macintosh</b></p> <p>Confirm that the CD-ROM icon is displayed when you insert the CD-ROM.</p> <p>If the CD-ROM icon is not displayed, restart your computer. If the icon is still not displayed, try different disks and see if they are displayed. If other disks are displayed, there is a problem with the <i>Setup CD-ROM</i>. Contact a Canon service representative.</p>

## Cannot Connect to Computer Properly

### ■ Printing Speed Is Slow / USB 2.0 Hi-Speed Connection Does Not Work

Cause	Action
Your system environment is not fully compatible with USB 2.0 Hi-Speed.	<p>If your system environment is not fully compatible with USB 2.0 Hi-Speed, the machine will operate at a lower speed provided under USB 1.1. In this case, the machine operates properly but printing speed may slow down due to communication speed.</p> <p>Check the following to ensure that your system environment supports USB 2.0 Hi-Speed connection.</p> <ul style="list-style-type: none"> <li>● The USB port on your computer supports USB 2.0 Hi-Speed connection.</li> <li>● The USB cable, and the USB hub if you are using one, support USB 2.0 Hi-Speed connection. Be sure to use a certified USB 2.0 Hi-Speed cable. We recommend the cable to be no longer than around 10 feet (3 meters).</li> <li>● The operating system of your computer supports USB 2.0 Hi-Speed connection. Obtain and install the latest update for your computer.</li> <li>● The USB 2.0 Hi-Speed driver operates properly. Obtain the latest version of the USB 2.0 Hi-Speed driver compatible with your hardware and install it on your computer.</li> </ul> <p> <b>Important</b></p> <p>For details on USB 2.0 Hi-Speed of your system environment, contact the manufacturer of your computer, USB cable, or USB hub.</p>

### **Windows**

### ■ “Hi-Speed USB Device Plugged into non-Hi-Speed USB Hub” or “This Device Can Perform Faster” Message Is Displayed (Windows XP Only)

Cause	Action
The machine is connected to a computer that does not support USB 2.0 Hi-Speed.	Your system environment is not compatible with USB 2.0. See “Printing Speed Is Slow / USB 2.0 Hi-Speed Connection Does Not Work” on page 77.

# Print Results Not Satisfactory

## ■ Cannot Print to End of Job

Cause	Action
<p><b>Windows</b></p> <p>Size of the print data is extremely large (Windows XP/Windows 2000 only).</p>	<p>In Windows XP and Windows 2000, click <b>Print Options</b> on the <b>Page Setup</b> sheet. Then, select the <b>Reduce spool data size</b> check box in the displayed dialog.</p> <p>Selecting <b>Reduce spool data size</b> may reduce the print quality.</p>

## ■ Part of the Page Is Not Printed

Cause	Action
<p><b>Page Size</b> setting in the Operation Panel does not match the actual size of the paper loaded in the machine.</p>	<p>If the <b>Page Size</b> setting set in the Operation Panel does not match the actual size of the printing paper, part of the page may not be printed.</p> <p>Check the <b>Page Size</b> setting on the Operation Panel.</p>
<p>You are performing automatic duplex printing.</p>	<p>When performing automatic duplex printing, the printable area at the top of the page will be 0.08 inches / 2 mm narrower than the usual. For this reason, the bottom of the page may not be printed. To prevent this, select <b>Use reduced printing</b> from the printer driver.</p> <p><b>Important</b></p> <p>Reduced printing may affect the layout depending on your document.</p> <p><b>Windows</b></p> <p>(1) Open the printer properties dialog box.</p> <p>Refer to "Opening the Printer Properties Dialog Box Directly from the Start Menu" in "Opening the Printer Properties Dialog Box (Windows)" of the <i>User's Guide</i> on-screen manual.</p> <p>(2) Click <b>Print Area Setup</b> in the <b>Page Setup</b> sheet and select <b>Use reduced printing</b>.</p> <p><b>Macintosh</b></p> <p>(1) Open the <b>Print</b> dialog box.</p> <p>Refer to "Opening the Print Dialog Box" in "Opening the Page Setup and Print Dialog Box (Macintosh)" of the <i>User's Guide</i> on-screen manual.</p> <p>(2) Select <b>Duplex Printing &amp; Margin</b> in the pop-up menu.</p> <p>(3) Select <b>Automatic Duplex Printing</b> and click <b>Use reduced printing</b> in <b>Print Area</b>.</p>

## ■ Colors Are Unclear

Cause	Action
<p><b>Media Type</b> setting in the Operation Panel does not match the actual type of paper.</p>	<p>Check that the <b>Media Type</b> set in the Operation Panel matches the type of the loaded printing paper.</p> <p>If you are printing a photograph or an illustration, incorrect <b>Media Type</b> setting may reduce the quality of printout color. The quality of printout color may also be reduced in borderless printing depending on the Media Type setting.</p>

## ■ Ink Does Not Come Out/Printing Does Not Start/Printing Is Blurred/ Colors Are Wrong/Straight Lines Are Misaligned

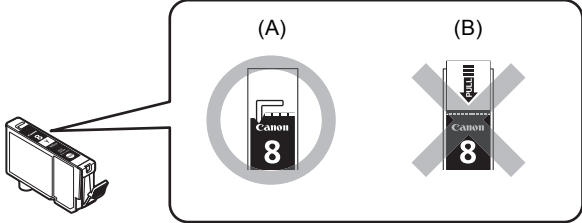
Cause	Action
Ink tank is empty.	<p>Open the Scanning Unit (Printer Cover) and check the ink lamps.</p> <p>If an ink lamp is flashing red slowly at about 3-second intervals, ink is running low. If an ink lamp is flashing red fast at about 1-second intervals or is not lit, the tank is empty.</p> <p>Replace the ink tank, and close the Scanning Unit (Printer Cover).</p> <p>See "Replacing an Ink Tank" on page 50.</p> <p><b>Note</b></p> <p>For details on different flashing speeds, see "Getting the Ink Level Information" on page 50.</p>
Ink tank is not installed securely. / Part of the orange tape is remaining.	<p>Open the Scanning Unit (Printer Cover) and check the ink lamps. If the ink lamp is not lit, press the  mark on the ink tank until it clicks into place. The ink lamp lights up red when the ink tank is fully inserted.</p> <p>Make sure all of the orange tape is peeled off the ink tank and the air hole is completely exposed, as illustrated in (A). If any orange parts are left as in (B), remove all of the orange parts.</p> <div data-bbox="412 587 994 810" style="text-align: center;">  </div> <p>(A) Correct L-shaped air hole.</p> <p>(B) Incorrect Part of the orange tape is remaining. Peel off the tape completely along the perforation.</p>
<b>Media Type</b> setting in the Operation Panel does not match the actual type of paper.	Make sure that the <b>Media Type</b> set in the Operation Panel matches the type of the loaded printing paper.
Print Head nozzles are clogged.	<p>Print the nozzle check pattern to check for uneven ink output.</p> <ul style="list-style-type: none"> <li>● <b>If the nozzle check pattern does not print out properly</b> Check if any of the missing colors are due to empty tanks. If there is plenty of ink and the machine does not print, clean the Print Head and then print the nozzle check pattern to check that ink is ejecting properly.</li> <li>● <b>If the problem is not resolved after performing Print Head Cleaning twice</b> Perform Print Head Deep Cleaning. If the problem is not resolved after performing Print Head Deep Cleaning, turn off the machine and perform Print Head Deep Cleaning again after 24 hours or later.</li> <li>● <b>If the problem is still not resolved after performing Print Head Deep Cleaning twice</b> The Print Head may be damaged. Contact your Canon service representative.</li> </ul> <p>For details on how to print the nozzle check pattern, how to clean the Print Head, and how to perform Print Head Deep Cleaning, see "When Printing Becomes Faint or Colors Are Incorrect" on page 56.</p>

Cause	Action
The media is loaded with the wrong side facing upwards.	Many types of paper are made to be printed on only a particular side of the paper. Printing on the wrong side may cause unclear prints or prints with reduced quality. Refer to "Printing Media" in the <i>User's Guide</i> on-screen manual.
Print Head is misaligned.	If you did not align the Print Head after installation, straight lines may be printed misaligned. Make sure to align the Print Head after you install it. See "Automatic Print Head Alignment" on page 64 and perform Automatic Print Head Alignment. If this does not solve the problem, see "Manual Print Head Alignment" on page 65 and perform Manual Print Head Alignment.
Print quality is not set appropriately.	In the Operation Panel, set <b>Print quality</b> in each mode to <b>High(quality-priority)</b> .

## ■ White Streaks

Cause	Action
<b>Media Type</b> setting in the Operation Panel does not match the actual type of paper.	Check that the <b>Media Type</b> set in the Operation Panel matches the type of the loaded printing paper.
Print quality is not set appropriately.	In the Operation Panel, set <b>Print quality</b> in each mode to <b>High(quality-priority)</b> . Especially when using coated (high-quality) paper, increasing the <b>Print quality</b> setting is effective in reducing white streaks.

## ■ Printed Paper Curls or Has Ink Blots

Cause	Action
Paper is too thin.	When printing data with high color saturation such as photographs or images in deep color, we recommend using Photo Paper Pro or other Canon specialty paper. See "Media Types You Cannot Use" on page 10.
<b>Media Type</b> setting in the Operation Panel does not match the actual type of paper.	Check that the <b>Media Type</b> set in the Operation Panel matches the type of the loaded printing paper.
Print quality is not set appropriately.	In the Operation Panel, set <b>Print quality</b> in each mode to <b>High(quality-priority)</b> . This will reduce blurs even when printing images with plenty of adjacent contrasting colors.

## ■ Printed Surface Is Scratched/Paper Is Smudged

Cause	Action
Paper Feed Roller is dirty.	If paper is not feeding properly, clean the Paper Feed Rollers. Cleaning the Paper Feed Rollers will wear the rollers, so perform this procedure only when necessary. For details on cleaning, see "Cleaning the Paper Feed Rollers (Roller Cleaning)" on page 68.
Inside of the machine is dirty.	When performing Two-sided copy, if the paper size specified using the Operation Panel does not match the actual size of paper loaded in the paper source, the inside will become stained with ink, causing printed paper to become smudged. Perform the Bottom Plate Cleaning to clean the inside of the machine. For details on cleaning, see "Cleaning the Inside of the Machine (Bottom Plate Cleaning)" on page 69.

Cause	Action
Printing on inappropriate type of paper.	<ul style="list-style-type: none"> <li>● Check to see if the paper you are printing on is not too thick or curled. See “Media Types You Cannot Use” on page 10.</li> <li>● When performing Borderless Printing, print quality may be reduced at the top and bottom edges of the paper. Make sure that the paper you are using is suitable for Borderless Printing. For details, refer to the <i>Printer Driver Guide</i> on-screen manual.</li> </ul>
Paper is curled.	<p>If you are using paper with either any of the corners or the whole printing surface curled, the paper may become dirty, not feed properly, or both. Use such paper after correcting paper curl as follows.</p> <p>(1) With the printing side (A) facing up, cover the paper with a fresh sheet of plain paper to avoid staining or scratching the surface.</p> <p>(2) Roll up the paper in a direction opposite to paper curl as seen below.</p> <div data-bbox="415 459 994 676" style="text-align: center;"> </div> <p>(3) Check to see that the paper curl is corrected to within approximately 0.08 to 0.2 inches / 2 to 5 mm (B) in height.</p> <div data-bbox="415 735 949 868" style="text-align: center;"> </div> <p>We recommend printing curl-corrected paper one sheet at a time.</p>
Printing on thick paper.	<p>Selecting the <b>Prevent paper abrasion</b> setting will widen the clearance between the Print Head and the loaded paper. If you notice abrasion even with the media type set correctly to match the loaded paper, set the machine to prevent paper abrasion.</p> <p>* Clear the <b>Prevent paper abrasion</b> check box once printing is complete, and then click <b>Send</b>.</p> <p><b>Windows</b></p> <p>Open the printer properties dialog box, and in <b>Custom Settings</b> in the <b>Maintenance</b> sheet, select the <b>Prevent paper abrasion</b> check box, and then click <b>Send</b>.</p> <p><b>Macintosh</b></p> <p>In the <b>Canon IJ Printer Utility</b>, select <b>Custom Settings</b> in the pop-up menu, select the <b>Prevent paper abrasion</b> check box, and then click <b>Send</b>.</p> <p>To open the printer properties dialog box (Windows), refer to “Opening the Printer Properties Dialog Box (Windows)” in the <i>User’s Guide</i> on-screen manual.</p> <p>To open the Canon IJ Printer Utility (Macintosh®), refer to “Opening the Canon IJ Printer Utility (Macintosh)” in the <i>User’s Guide</i> on-screen manual.</p> <p>When <b>Prevent paper abrasion</b> is selected, the setting is also applied to direct printing from a digital camera.</p> <p>When performing copy direct printing without using a computer, select <b>Print settings</b>, set <b>Prevent paper abrasion</b> to <b>ON</b>. For details on settings, refer to “Changing the Machine Settings” in the <i>User’s Guide</i> on-screen manual.</p>

Cause	Action
Media Type setting in the Operation Panel does not match the actual type of paper.	Check that the <b>Media Type</b> set in the Operation Panel matches the type of the loaded printing paper. If you notice abrasion even with the media type set correctly to match the loaded paper, set <b>Prevent paper abrasion</b> to <b>ON</b> in <b>Print settings</b> . Refer to "Changing the Machine Settings" in the <i>User's Guide</i> on-screen manual.
Printing graphics with <b>Intensity</b> setting set too high.	Especially if you are using plain paper to print images with high intensity, the paper may absorb too much ink and become wavy, causing paper abrasion. In this case, reduce the <b>Intensity</b> setting in the Operation Panel and try printing again.
Printing beyond the recommended printing area.	If you are printing beyond the recommended printing area of your printing paper, the lower edge of the paper may become stained with ink. Resize your original document in your application software. For details on recommended printing area, refer to "Printing Area" in the <i>User's Guide</i> on-screen manual.

## ■ Colors Are Uneven or Streaked



Cause	Action
Print quality is not set appropriately.	In the Operation Panel, set <b>Print quality</b> in each mode to <b>High(priority)</b> . Especially when printing a document that requires a lot of ink, increasing the <b>Print quality</b> setting is effective in reducing uneven colors.

## ■ Printing Problems When Copying

Cause	Action
The original document is not loaded correctly.	Check that the original is loaded correctly on the Platen Glass. See "Loading Original Documents" on page 6.
The print quality setting is not suitable for the original.	Set the print quality to suit the type of your document. See "Setting Items in Each Mode" on page 22.
The original document is not loaded with the side to be copied faced down.	When loading the original on the Platen Glass, the side to be copied should be faced down.
The original document is a printout from this machine.	Print quality may be reduced if you copy a printout. Instead of copying a printout, print the original directly either from the digital camera, memory card, or your computer.
The Platen Glass or the inner side of the Document Cover is dirty.	Clean the Platen Glass and the inner side of the Document Cover. See "Cleaning the Platen Glass and Document Cover" on page 68.

## Printing Does Not Start

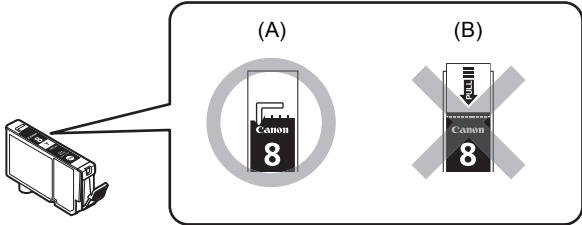
Cause	Action
Ink tank is empty.	Open the Scanning Unit (Printer Cover) and check the ink lamps. If an ink lamp is flashing red at about 1-second intervals, the tank is empty. Replace the ink tank, and close the Scanning Unit (Printer Cover). See "Replacing an Ink Tank" on page 50. If you want to continue printing, confirm the message displayed on the LCD and take the appropriate action. See "Error Message Is Displayed on the LCD" on page 72.  <b>Note</b> If multiple ink lamps are flashing, check how fast they are flashing. Fast flashing (at about 1-second intervals) indicates the tank is empty. Slow flashing (at about 3-second intervals) indicates ink is low. For details on different flashing speeds, see "Getting the Ink Level Information" on page 50.

Cause	Action
Ink tank not installed in proper position.	<p>Open the Scanning Unit (Printer Cover) and check the ink lamps.</p> <p>If there is still sufficient ink but its ink lamp is flashing red, an ink tank may be installed in a wrong position.</p> <p>Confirm that the ink tanks are installed in the appropriate positions. See "Replacing an Ink Tank" on page 50.</p>
Ink tank is not installed securely. / Part of the orange tape is remaining.	<p>Open the Scanning Unit (Printer Cover) and check the ink lamps.</p> <p>If the ink lamp is not lit, press the  mark on the ink tank until it clicks into place. The ink lamp lights up red when the ink tank is fully inserted.</p> <p>Make sure all of the orange tape is peeled off the ink tank and the air hole is completely exposed, as illustrated in (A). If any orange parts are left as in (B), remove all of the orange parts.</p> <div data-bbox="412 399 994 625" style="text-align: center;">  </div> <p>(A) Correct L-shaped air hole.</p> <p>(B) Incorrect Part of the orange tape is remaining. Peel off the tape completely along the perforation.</p>
Unnecessary print jobs are left in queue. / Computer problems.	<p>Restarting your computer may solve the problem.</p> <p>If there are any unnecessary print jobs, follow the procedure below to delete them.</p> <p><b>Windows</b></p> <p>(1) Open the printer properties dialog box. Refer to "Opening the Printer Properties Dialog Box Directly from the Start Menu" in "Opening the Printer Properties Dialog Box (Windows)" of the <i>User's Guide</i> on-screen manual.</p> <p>(2) Click the <b>Maintenance</b> tab and then <b>View Printer Status</b>.</p> <p>(3) Click <b>Display Print Queue</b>.</p> <p>(4) Select <b>Cancel All Documents (Purge Print Documents</b> in Windows Me or Windows 98) on the <b>Printer</b> menu. You may not be able to select individual print jobs in Windows XP or Windows 2000.</p> <p>(5) When the confirmation message is displayed, click <b>Yes</b>. The print jobs are deleted.</p> <p><b>Macintosh</b></p> <p>(1) Click the printer icon in the Dock to display the list of print jobs in progress. In Mac® OS X v.10.2.8, click the printer icon in the Dock to start up the <b>Print Center</b> and double-click the name of your machine in the <b>Printer List</b>.</p> <p>(2) Select the print job to delete and click . The print jobs are deleted.</p>

# Paper Does Not Feed Properly

Cause	Action
Printing on inappropriate type of paper.	Check to see if the paper you are printing on is not too thick or curled. See "Media Types You Cannot Use" on page 10.
Paper Feed Rollers are dirty.	If paper is not feeding properly, clean the Paper Feed Rollers. Cleaning the Paper Feed Rollers will wear the rollers, so perform this procedure only when necessary. For details on cleaning, see "Cleaning the Paper Feed Rollers (Roller Cleaning)" on page 68.
Paper not loaded properly.	Make sure of the following when you load paper in the machine. <ul style="list-style-type: none"> <li>● When loading two or more sheets of paper, align the edges of the sheets before loading.</li> <li>● Always load the paper in portrait orientation, either in the Auto Sheet Feeder or the Cassette, regardless of the printing orientation.</li> <li>● When loading paper in the Auto Sheet Feeder, load the paper with the print side facing UP. Align the right edge of the paper stack against the Cover Guide and slide the Paper Guide so that it just touches the left edge of the stack.</li> <li>● When loading paper in the Cassette, load the paper with the print side facing DOWN. Align the right edge of the paper stack against the right edge of the Cassette and slide the Paper Guide against the left edge of the stack.</li> </ul> For details on loading paper, see "Loading Paper" on page 16.
Paper source selection is inappropriate.	Make sure that the proper paper source is selected. If not, change the paper source using the <b>Paper Feed Switch</b> or the printer driver. For details, see "Changing the Paper Source" on page 15.   <b>Note</b> When printing from your computer, if a setting other than <b>Paper Feed Switch</b> is selected for <b>Paper Source</b> in the printer driver, the printer driver settings takes precedence when printing. For details on paper source selection using the printer driver, refer to the <i>Printer Driver Guide</i> on-screen manual.
Too much plain paper loaded.	You can load approximately up to 150 sheets of 17 lb / 64 gsm plain paper (0.52 inches / 13 mm in stack height). However, proper feeding of paper may not be possible at this maximum capacity depending on the type of paper or environmental conditions (either very high or low temperature and humidity). In such cases, reduce the sheets of paper you load at a time to around half (around 0.2 inches / 5 mm in paper stack height). For details on loading paper, see "Loading Paper" on page 16.
Foreign object in the Auto Sheet Feeder or Cassette.	Make sure that there are no foreign objects in the Auto Sheet Feeder or Cassette.
Envelopes not prepared or loaded properly.	When printing on envelopes, refer to "Envelopes" in the <i>User's Guide</i> on-screen manual, and prepare the envelopes before printing. Once you have prepared the envelopes, load them in the machine in portrait orientation. If the envelopes are placed in landscape orientation, they will not feed properly.
Inner Cover is not completely closed.	Close the Inner Cover completely. Paper does not feed properly if the Inner Cover is even slightly open.

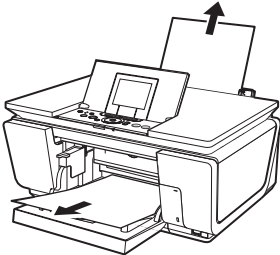

# Paper Jams

Cause	Action
<p>Paper jammed in the Paper Output Slot or the Auto Sheet Feeder.</p>	<p>Remove the paper following the procedure below.</p> <p>(1) Slowly pull the paper out, either from the Auto Sheet Feeder or from the Paper Output Slot, whichever is easier.</p>  <ul style="list-style-type: none"> <li>● If the paper tears and a piece remains inside the machine, open the Scanning Unit (Printer Cover) and remove it. After removing all paper, close the Scanning Unit (Printer Cover), turn the machine off, and turn it back on. * Be careful not to touch the components inside the machine.</li> <li>● If you cannot pull the paper out, turn the machine off and turn it back on. The paper will be ejected automatically.</li> </ul> <p>(2) Reload the paper in the machine, and press the <b>OK</b> button on the machine. If you turned off the machine in step 1, all print jobs in queue are canceled. Reprint if necessary.</p> <p><b>Note</b></p> <ul style="list-style-type: none"> <li>● For details on how to load paper, see "Loading Printing Paper" on page 8.</li> <li>● When reloading the paper in the machine, see "Paper Does Not Feed Properly" on page 84 to confirm that you are using the correct paper and are loading it into the machine correctly.</li> <li>● A5-sized paper are suited to print documents consisting mainly of text. We do not recommend using such paper to print documents with photos or graphics, since the printout may curl and cause paper exit jams.</li> </ul> <p>If you cannot remove the paper or the paper tears inside the machine, or if the paper jam error continues after removing the paper, contact your Canon service representative.</p>
<p>Landscape credit card-sized paper jammed inside the machine.</p>	<p>Do not load credit card-sized paper in the landscape orientation. Remove the paper following the procedure below.</p> <p>(1) Load a single sheet of the same paper in the Auto Sheet Feeder in portrait orientation. Do not load it in the landscape orientation.</p> <p>(2) Turn off the machine.</p> <p>(3) Turn on the machine. The paper is fed and then pushes out the jammed paper as it ejects.</p> <p>If you cannot remove the jammed paper or the paper jam error continues after removing the paper, contact your Canon service representative.</p>

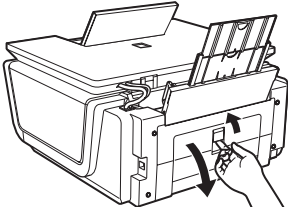
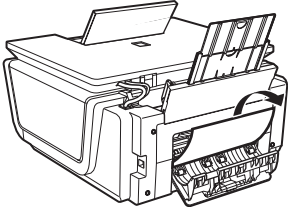
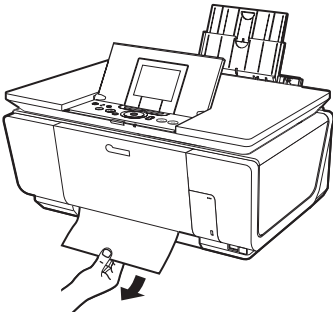
Cause	Action
<p>Landscape 4" x 6" / 101.6 x 152.4 mm paper loaded in the Cassette jammed inside the machine.</p>	<p>Always load 4" x 6" / 101.6 x 152.4 mm media in portrait orientation regardless of the printing orientation.</p> <p>Remove the paper following the procedure below.</p> <p>(1) Turn off the machine, and then open the Rear Cover.</p> <p>(2) Fold a piece of A4 or Letter-sized plain paper in four, push it in until it hits the jammed paper, then pull out the paper folded in four.</p> <p>(3) Close the Rear Cover, then turn on the machine.</p> <p>Wait until the jammed paper is automatically ejected.</p> <p>If you cannot remove the jammed paper or the paper jam error continues after removing the paper, contact your Canon service representative.</p>
<p>Paper jammed inside the machine at the transport unit.</p>	<p>Remove the paper following the procedure below.</p> <p>(1) Open the Rear Cover.</p>  <p>(2) If you can see the jammed paper, slowly pull the paper out.</p>  <ul style="list-style-type: none"> <li>● Be careful not to touch the components inside the machine.</li> <li>● If you cannot pull the paper out, turn the machine off and turn it back on. The paper will be ejected automatically.</li> </ul> <p>(3) Close the Rear Cover.</p> <p>(4) If you were not able to remove the paper out in step 2, remove the Cassette.</p> <p>(5) Slowly pull the jammed paper out.</p>  <p>(6) If any paper is sticking out of the Cassette, reload the paper in the Cassette.</p> <p>(7) Insert the Cassette into the machine again, and press the <b>OK</b> button on the machine.</p> <p>If you turned off the machine in step 2, all print jobs in queue are canceled. Reprint if necessary.</p>

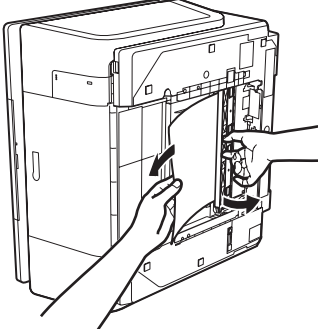
Cause	Action
<p>Paper jammed inside the machine at the transport unit. (Continued)</p>	<p><b>Note</b> When reloading the paper in the machine, see "Paper Does Not Feed Properly" on page 84 to confirm that you are using the correct paper and are loading it into the machine correctly. If you cannot remove the paper or if the paper tears inside the machine, or if the paper jam error continues after removing the paper, contact your Canon service representative.</p>
<p>Paper jammed inside the machine at the duplex transport section.</p>	<p>Remove the paper following the procedure below.</p> <p>(1) Remove the Cassette.</p> <p>If the paper is loaded in the Auto Sheet Feeder, remove the paper from the Auto Sheet Feeder and close the Paper Support.</p> <p>(2) Stand the machine with the left side down.</p> <p>(3) Slowly pull the jammed paper out while pulling the green cover toward you.</p>  <p><b>Caution</b> Set the machine back to its original position immediately after removing the jammed paper.</p> <p>(4) If any paper is sticking out of the Cassette, reload the paper in the Cassette. Reload paper in the Auto Sheet Feeder, if necessary.</p> <p>(5) Insert the Cassette into the machine.</p> <p>(6) Press the <b>OK</b> button on the machine.</p> <p><b>Note</b> When reloading the paper into the machine, see "Paper Does Not Feed Properly" on page 84 to confirm that you are using the correct paper and are loading it into the machine correctly. If you cannot remove a sheet of paper or a teared piece of paper inside the machine, or if the paper jam error continues after removing the paper, contact your Canon service representative.</p>



# Error Message Appears on the Screen



## ■ Writing Error/Output Error/Communication Error

Cause	Action
The machine is not ready.	Confirm that the <b>POWER</b> lamp is lit blue. If the <b>POWER</b> lamp is off, turn the machine on. While the <b>POWER</b> lamp is flashing blue, the machine is initializing. Wait until the <b>POWER</b> lamp stops flashing and remains lit blue. If the <b>ALARM</b> lamp is lit orange, an error may have occurred in the machine. For details on how to resolve the error, see "Error Message Is Displayed on the LCD" on page 72.
Paper is not loaded.	An out of paper error may have been left unattended for a period of time. Load paper and press the <b>OK</b> button. If paper is loaded, make sure that the paper source (the Auto Sheet Feeder or Cassette) is selected correctly. If the paper source is not selected correctly, press the <b>Paper Feed Switch</b> or use the printer driver to change the paper source.
Printer port setting does not match the computer's interface connecting the machine.	Check the printer port settings. <b>(1)</b> Click <b>Start &gt; Control Panel &gt; Printers and Other Hardware &gt; Printers and Faxes</b> . In non-XP Windows, click <b>Start &gt; Settings &gt; Printers</b> . <b>(2)</b> Click the <b>Canon MP960 Printer</b> icon. <b>(3)</b> Open the <b>File</b> menu and select <b>Properties</b> . <b>(4)</b> Click the <b>Ports</b> tab to confirm the port settings. Make sure that a port named <b>USBnnn (Canon MP960 Printer)</b> (where n is a number) is selected for <b>Print to the following port(s)</b> . In Windows Me or Windows 98, click the <b>Details</b> tab and make sure that <b>MPUSBPRNnn (Canon MP960 Printer)</b> is selected for <b>Print to the following port</b> . If the port setting is not correct, change the port setting according to the interface you are using, or reinstall the MP Drivers.
The machine is not connected properly.	Make sure that the printer cable is securely plugged in to the machine and the computer. <ul style="list-style-type: none"><li>● If you are using a relay device such as a USB hub, disconnect it, connect the machine directly to the computer, and try printing again. If printing starts normally, there is a problem with the relay device. Consult the reseller of the relay device for details.</li><li>● There could also be a problem with the USB cable. Replace the USB cable and try printing again.</li></ul>
MP Drivers are not installed properly.	The MP Drivers may not be installed properly. Uninstall them following the procedure described in the <i>Printer Driver Guide</i> on-screen manual and reinstall them following the procedure described in the <i>Easy Setup Instructions</i> .

## ■ Error Regarding Automatic Duplex Printing Is Displayed

Cause	Action
The correct media size is not selected in the MP Drivers.	<p>First, check the <b>Page Size</b> setting in the application software you are printing from.</p> <p>Then, check the <b>Page Size</b> setting on the <b>Page Setup</b> sheet in the printer properties dialog box (Windows) or the <b>Page Setup</b> dialog box (Macintosh). The page sizes that can be used for Automatic Duplex Printing are Letter, A4, B5, A5, and 5" x 7" / 127.0 x 177.8 mm. Check that the page size of the loaded paper is correct.</p> <p> <b>Note</b></p> <p>To switch to manual duplex printing, follow the procedure below.</p> <p> <b>Windows</b></p> <p>On the <b>Page Setup</b> sheet, clear the <b>Automatic</b> check box. Then try printing again.</p> <p> <b>Macintosh</b></p> <p>Manual duplex printing is not available.</p>

### Macintosh

## ■ Error No.: 300 Is Displayed

Cause	Action
The machine is not ready.	<p>Make sure that the machine is turned on, and that it is connected securely to the computer.</p> <p>If the <b>POWER</b> lamp is off, turn the machine on.</p> <p>While the <b>POWER</b> lamp is flashing blue, the machine is initializing. Wait until the <b>POWER</b> lamp stops flashing and remains lit blue.</p> <p>When the <b>ALARM</b> lamp is lit orange, an error may have occurred on the machine. For details on how to resolve the error, see "Error Message Is Displayed on the LCD" on page 72.</p>
Machine is not connected properly.	<p>Make sure that the USB cable is plugged in securely to the computer and the machine.</p> <ul style="list-style-type: none"> <li>● If you are using a relay device such as a USB hub, disconnect it, connect the machine directly to the computer, and try printing again. If printing starts normally, there is a problem with the relay device. Consult the reseller of the relay device for details.</li> <li>● There could also be a problem with the USB cable. Replace the USB cable and try printing again.</li> </ul>
Your machine is not selected in <b>Printer</b> on the <b>Print</b> dialog box.	<p>Select <b>MP960</b> in <b>Printer</b> on the <b>Print</b> dialog box.</p> <p>If <b>MP960</b> does not appear in <b>Printer</b>, follow the procedure below to check that the driver for your machine is installed to your computer.</p> <p>(1) Select <b>Print and Fax Preferences</b> from <b>Printer</b>.</p> <p style="padding-left: 20px;">In Mac OS X v.10.2.8 or 10.3.x, select <b>Edit Printer List</b> from <b>Printer</b>.</p> <p>(2) Check that <b>MP960</b> is displayed in the list of printers and that the check box is selected.</p> <p style="padding-left: 20px;">In Mac OS X v.10.2.8, check that <b>MP960</b> is displayed in <b>Printer List</b>.</p> <p>(3) If <b>MP960</b> is not displayed, click <b>Add(+)</b> to add the machine.</p> <p>If you cannot add the machine, follow the procedure described in the <i>Easy Setup Instructions</i> to reinstall the MP Drivers.</p>

## Macintosh

### ■ Error No.: 1700 Is Displayed

Cause	Action
The ink absorber is almost full.	The machine has a built-in ink absorber to hold the ink used during Print Head Cleaning, for example. This error message indicates that the ink absorber is nearly full. Press the <b>OK</b> button to cancel the error so you can continue printing. However, because printing is disabled once the ink absorber becomes completely full and until the ink absorber is replaced, you are recommended to contact a Canon service representative as early as possible. (You will need to replace a particular part of the machine.)

## Macintosh

### ■ Error No.: 1851 Is Displayed

Cause	Action
Inner Cover was open when you started printing.	Close Inner Cover, press the <b>OK</b> button on the machine. Printing will start again.

## Macintosh

### ■ Error No.: 1856 Is Displayed

Cause	Action
Inner Cover was opened while printing was in progress.	Close the Inner Cover, then press the <b>OK</b> button on the machine. A page of print data being sent at the time of the error will be erased, so print that page again.

## Macintosh

### ■ Error No.: 2001 Is Displayed

Cause	Action
No response from connected digital camera or video camcorder. / Connected digital camera or video camcorder connected is not compatible with this machine.	Disconnect the cable connecting the machine and the device, and then reconnect it. Depending on the model or brand of your device, you may have to select a PictBridge-compliant print mode on the device before connecting it to the machine. You may also have to turn on the camera or select Play mode manually after connecting the device to the machine. Perform necessary operations according your device's instruction manual before reconnecting it to the machine. If the error is still unresolved, there is a possibility that you are using a digital camera or digital video camcorder that is not supported by this machine. Use a digital camera or digital video camcorder compatible with this machine.

## Macintosh

### ■ Error No.: 2500 Is Displayed

Cause	Action
Automatic Print Head Alignment has failed.	See "Auto head align has failed. Press <b>OK</b> and repeat operation. <See manual>" in "Error Message Is Displayed on the LCD" on page 72.

# Cannot Print Properly from a Digital Camera

The following are the possible errors that may occur when printing directly from a digital still camera or digital video camcorder\*, and the actions to resolve them.

\* Hereafter, the digital still cameras and digital video camcorders are collectively referred to as "digital camera" or "camera".

## Note

- PictBridge compatible digital cameras can be connected to your machine for direct printing.
- This section describes errors that are indicated on Canon-brand PictBridge compatible cameras. The error messages and operations may vary depending on the camera you are using. If you are using a non-Canon PictBridge compatible camera and not sure how to dismiss the printer error message from the camera, check the error message displayed on the LCD and dismiss the error message. For details on dismissing an error message from the machine, see "Error Message Is Displayed on the LCD" on page 72.
- A communication time out occurs if printing takes a long time or if it takes too much time to send data. This may cancel printing. In such cases, disconnect the cable between the machine and the camera, and then reconnect it. Turn the camera on if it does not turn on automatically. If the problem is still not resolved, select a different photo and check if it can be printed.
- Your PictBridge compatible device may need to be switched to printing mode before it is connected to the machine, depending on the model of the camera. Also, it may need to be turned on manually or switched to playback mode after connected to the machine. Refer to your camera's instruction manual and take perform necessary operation before connection.
- The print head nozzles may be clogged if printing becomes faint or colors are incorrect. See "When Printing Becomes Faint or Colors Are Incorrect" on page 56.
- If the paper is curled or its surface is scratched during printing, make sure that you are using the correct type of paper. If the problem is not resolved by using the correct type of paper, turn on the Prevent paper abrasion function. See "Printing on thick paper." on page 81.
- For the errors indicated on the camera and their solution, also refer to your camera's instruction manual. For details on other troubles with a digital camera, contact the manufacturer of the camera.

Error Message On Camera	Action
"Printer in use"	The machine is busy, perhaps processing a print job from the computer. Wait until printing is complete. If the machine is warming up, wait until the warm-up is complete. When it is ready, the machine starts printing your print job automatically.
"No paper"	Load paper in the paper source, or press the <b>Paper Feed Switch</b> to select the paper source where you have loaded paper (the Auto Sheet Feeder or the Cassette), and select <b>Continue</b> <sup>1</sup> in the display on your camera.
"Paper Error"	<ul style="list-style-type: none"><li>● The page size that cannot be fed from the Cassette is selected. Load paper in the Auto Sheet Feeder, press the <b>Paper Feed Switch</b> to select the Auto Sheet Feeder as the paper source, and try printing again. For details, see "Changing the Paper Source" on page 15.</li><li>● If the Paper Output Tray is closed, open it. The machine resumes printing. If the Inner Cover is open, close it and select <b>Stop</b> in the display on your camera to stop printing.</li></ul>
"Paper jam"	Select <b>Stop</b> in the display on your camera to stop printing. Remove the jammed paper, load new paper, press the <b>OK</b> button on the machine, and reprint.
"Printer cover open"	Close the Scanning Unit (Printer Cover) on the machine.
"No Print Head"	The Print Head is not installed or is defective. Follow the directions described in the <i>Easy Setup Instructions</i> to install the Print Head. If the Print Head is already installed, remove the Print Head and then reinstall it. If the error is still not resolved, the Print Head may be damaged. Contact your Canon service representative.

Error Message On Camera	Action
"Waste tank (ink absorber <sup>*2</sup> ) full/ "ink absorber <sup>*2</sup> full"	This error message indicates that the ink absorber is nearly full. The machine has a built-in ink absorber to hold the ink used during Print Head Cleaning, for example. You can continue printing by selecting <b>Continue</b> <sup>*1</sup> on the display on your camera. However, because printing is disabled once the ink absorber becomes completely full and until the ink absorber is replaced, you are recommended to contact a Canon service representative as early as possible. (You will need to replace a particular part of the machine.)
"No ink"	An ink tank is not installed properly, or is out of ink. Confirm the error message displayed on the LCD and take the appropriate action to resolve the error. For details, see "Error Message Is Displayed on the LCD" on page 72.
"Ink Error"	An ink tank that was once empty is installed. Replace the ink tank and close the Scanning Unit (Printer Cover). Printing with an ink tank that was once empty may damage the machine. If you want to continue printing in this condition, you need to release the function for detecting the remaining ink level. Press and hold the <b>Stop/Reset</b> button for at least 5 seconds, and then release it.  * With this operation, releasing the function for detecting the remaining ink level is memorized. Please be advised that Canon shall not be liable for any machine malfunction or damage caused by refilled ink tanks. See "Replacing an Ink Tank" on page 50.
"Hardware Error"	An ink tank error has occurred. Replace the ink tank. See "Replacing an Ink Tank" on page 50.
"Printer error"	An error requiring servicing may have occurred. (Machine's <b>POWER</b> lamp flashes blue and <b>ALARM</b> lamp flashes orange alternately.) Disconnect the cable between the machine and the camera, turn off the machine, and unplug the power cord of the machine from the power supply. After a while, plug the power cord of the machine back in, turn on the machine, and then reconnect the camera to the machine. If the same error occurs, contact your Canon service representative.

\*1 To resume printing, you can also press the **OK** button on the machine instead of selecting **Continue** on the camera.

\*2 The ink absorber absorbs ink used during cleaning, for example. If this message appears, you will need to call for servicing to replace the absorber and to check the machine for proper operation.

## Cannot Print Properly from a Photo Index Sheet

Cause	Action
"Failed to scan Photo Index Sheet." is displayed.	<ul style="list-style-type: none"> <li>● Make sure the Photo Index Sheet is set in the correct position and orientation on the Platen Glass.</li> <li>● Make sure the Platen Glass and the Photo Index Sheet are not dirty.</li> <li>● Make sure all required circles on the Photo Index Sheet are filled in. If the filled circles on the sheet are not marked dark enough, the machine may not read the settings.</li> </ul> <p>Refer to "Printing by Using the Photo Index Sheet" in "Using Other Useful Printing Functions" of the <i>User's Guide</i> on-screen manual.</p>



# Cannot Scan Films

Cause	Action
Film guide not correctly placed on the Platen Glass.	Insert the film in the film guide supplied for this machine and place the guide in the correct position on the Platen Glass. For loading the film, see "Mounting Films" on page 38.
The Document Cover is not closed.	Close the Document Cover properly.
The FAU Protective Sheet is not removed.	Remove the FAU Protective Sheet from the Document Cover.
The Scanner Lock Switch is not released.	Slide the Scanner Lock Switch to the release position  and turn the machine off. Then, turn the power back on.

## ■ Cannot Obtain a Clean Scan or Colors Scan Incorrectly (Displayed Image Is Not Clear)

Cause	Action
Dust or dirt is stuck to the Platen Glass or the FAU Lamp.	Remove any dust and dirt from the Platen Glass and the FAU Lamp. See "Cleaning the Platen Glass and Document Cover" on page 68.
The original film is dirty.	Remove any dirt from the film.
The condition of the original film is poor (faded colors, etc.).	If you are scanning from a computer, in Image Settings the ScanGear's Advanced Mode, select <b>Fading Correction</b> or <b>Grain Correction</b> to scan with image correction. Refer to the <i>Scanning Guide</i> on-screen manual.  <b>Note</b> If there is no problem with the quality of the image seen on your computer screen, but the printout quality is unsatisfactory or has unwanted margin space, you need to adjust the print settings. Otherwise, it may be a machine problem. See "Print Results Not Satisfactory" on page 78.
The slide mount you are using is white and the reflection is affecting scan quality.	Use black mounts, or mask the slide mount with a black frame.
Light from the FAU lamp get in through the blank area.	Place the Filler Sheet over the blank area correctly to shield it.

## ■ Frames Are Not Detected Correctly

Cause	Action
Film is out of position.	Reposition the film in the film guide so that the white line marks of the guide do not obscure the film frames. For loading the film, see "Mounting Films" on page 38.  <b>Note</b> Repositioning the film may not resolve the problem, depending on the film. In this case, scan from the computer. For details, refer to the <i>Scanning Guide</i> on-screen manual.
The frame of a film is scanned on the edge of an image. / The edge of an image is missing.	Adjust <b>Film print cutting range</b> and rescan. See "Print Settings" in "Changing the Machine Settings" of the <i>User's Guide</i> on-screen manual.

# Appendix

## Reading the On-screen Manuals

---

Along with this *Quick Start Guide*, on-screen manuals are also supplied with your machine. For detailed instructions on installing the on-screen manuals, refer to your setup sheet.

You can view the on-screen manuals in the following way:

### Windows

To view the on-screen manual, double-click the **MP960 On-screen Manual** shortcut icon on the desktop, or click **Start > All Programs (or Programs) > Canon MP960 Manual > MP960 On-screen Manual**.

#### System Requirements

Browser: Windows HTML Help Viewer

---

#### Note

- Microsoft® Internet Explorer 5.0 or later must be installed.
  - The on-screen manual may not be displayed properly depending on your operating system or Internet Explorer version. We recommend that you keep your system up to date with Windows Update.
- 

### Macintosh

To view the on-screen manual, double-click the **MP960 On-screen Manual** alias on the desktop.

---

#### Note

##### Users in Asia

If you installed the *User's Guide* from the **Manual** folder in the *Setup CD-ROM*, open the folder in which you copied the *User's Guide* and double-click **top.htm**.

---

#### System Requirements

Browser: Help Viewer

---

#### Note

- The on-screen manual may not be displayed properly depending on your operating system. We recommend that you keep your system up to date.
  - We recommend using Safari as your Web browser to view the HTML format on-screen manuals. If Safari is not installed on your computer, download it from Apple Computer, Inc. website and install it.
-

# Specifications

## General Specifications

<b>Printing resolution (dpi)</b>	9600 (horizontal)* x 2400 (vertical) * Ink droplets can be placed with a pitch of 1/9600 inch at minimum.
<b>Print speed*</b> * Based on Canon standard pattern. Print speed may vary depending on system configuration, software, document complexity, print mode and page coverage.	Black printing (text pattern) Max Speed (Custom Setting 5): 30 ppm Standard: 14.9 ppm Color printing Max Speed (Custom Setting 5): 22 ppm Standard: 9.8 ppm
<b>Print width</b>	8 inches / 203.2 mm max. (for Borderless Printing: 8.5 inches / 216 mm)
<b>Acoustic noise level</b>	Approx. 33.2 dB (A) (when printing in the highest print quality mode on Photo Paper Pro)
<b>Operating environment</b>	Temperature: 5 to 35°C (41 to 95°F) Humidity: 10 to 90%RH (no condensation)
<b>Storage environment</b>	Temperature: 0 to 40°C (32 to 104°F) Humidity: 5 to 95% RH (no condensation)
<b>Power supply</b>	AC 100-240 V, 50/60 Hz
<b>Power consumption</b>	Printing (Copy): Approx. 24 W Standby (minimum): Approx. 1.7 W OFF: Approx. 0.9 W
<b>External dimensions (with the Paper Support and Paper Output Tray retracted)</b>	Approx. 18.5 (W) x 16.8 (D) x 8.9 (H) inches / Approx. 471 (W) x 428 (D) x 226 (H) mm
<b>Weight</b>	Approx. 12.0 kg (Approx. 26.5 lb.)
<b>Print Head</b>	Total 3,584 nozzles (C/M/Y/PC/PM/Dye Bk/BK: each 512 nozzles)

## Copy Specifications

<b>Copy speed</b> * Based on Canon standard pattern. Copy speed may vary depending on document complexity, copy mode, page coverage and the number of copies.	Black & white: Fast mode approx. 30 cpm Color: Fast mode approx. 22 cpm
<b>Multiple copy</b>	1 - 99 pages
<b>Intensity adjustment</b>	9 positions, Auto intensity (AE copy)
<b>Zoom</b>	25% - 400% (1% unit)

## Scan Specifications

<b>Scanner driver</b>	TWAIN / WIA (Windows XP only)
<b>Maximum scanning size</b>	A4/Letter, 8.5" x 11.7" / 216 x 297 mm
<b>Scanning resolution</b>	Optical resolution (horizontal x vertical) max: 4800 dpi x 4800 dpi Interpolated resolution max: 19200 dpi x 19200 dpi
<b>Gradation (Input/Output)</b>	48bit/8bit 48bit/24bit (RGB each 16bit/8bit)

## Camera Direct Print (PictBridge)

<b>Paper size</b>	<p>Default (Selections based on the machine setting)</p> <p>10 x 15 cm / 4" x 6" (Photo Paper Plus Glossy, Photo Paper Pro, Photo Paper Plus Semi-gloss, Glossy Photo Paper, Glossy Photo Paper "Everyday Use", Photo Paper Glossy, Photo Stickers<sup>1</sup>)</p> <p>13 x 18 cm / 5" x 7" (Photo Paper Plus Glossy)<sup>2</sup></p> <p>A4 / 8.5" x 11" (Photo Paper Plus Glossy A4/Letter, Photo Paper Pro A4/Letter, Photo Paper Plus Semi-gloss A4/Letter, Glossy Photo Paper A4/Letter, Glossy Photo Paper "Everyday Use" A4, Photo Paper Glossy Letter, Plain Paper A4/Letter)</p> <p>5.4 x 8.6 cm / Credit card (Glossy Photo Paper Card Size)</p> <p>20 x 25 cm / 8" x 10" (Photo Paper Pro)</p> <p>10.1 x 18 cm / 4" x 7.1" (Photo Paper Pro)<sup>2</sup></p> <p>*1 Canon-brand sticker. Printing on this paper is available only when the Layout function on your camera has a 16-up option. See "Recommended Paper and Requirements" on page 8.</p> <p>*2 If using a Canon PictBridge-compatible camera, you can select it.</p>
<b>Paper type</b>	<p>Default (Selections based on the machine setting), Photo (Photo Paper Plus Glossy, Glossy Photo Paper), Fast Photo (Photo Paper Pro), Plain Paper (A4/Letter only)</p>
<b>Layout</b>	<p>Default (Selections based on the machine setting), Borderless, Bordered, N-up (2, 4, 9, 16)<sup>1</sup>, 35-up<sup>2</sup></p> <p>*1 Layout compatible with Canon-brand sticker above. See "Recommended Paper and Requirements" on page 8.</p> <p>*2 Selected photos are printed in 35 mm film style layout (contact printing layout). This print setting is only available with certain Canon PictBridge-compliant devices. You can print shooting Info (Exif Data) on photos in list format, or in the margins of specified photos.</p> <p>Select Layout, then select the item displayed with the [i] icon. (Note that this print setting cannot be used for some models.) See "Recommended Paper and Requirements" on page 8.</p>
<b>Image optimize</b>	<p>Default (Selections based on the machine setting), On, Off, "VIVID"<sup>*</sup>, "NR" (Noise Reduction)<sup>*</sup>, "Face"<sup>*</sup>, "Red eye"<sup>*</sup></p> <p>* If using a Canon PictBridge-compatible camera, you can select it.</p>
<b>Print data &amp; file no.</b>	<p>Default (Off: No printing), Date, File No., Both, Off</p>
<b>Trimming</b>	<p>Default (Off: No trimming), On (follow camera's setting), Off</p>

## Minimum System Requirements<sup>\*1</sup>

Windows <sup>*2</sup>				
Interface	Operating System	Processor	RAM	Hard Disk Space <sup>4</sup>
USB 2.0 Hi-Speed	Windows XP SP1, SP2	Pentium III <sup>3</sup> (Celeron 566 MHz)	128 MB	550 MB
	Windows 2000 Professional SP4			
USB	Windows XP SP1, SP2	Pentium II 300 MHz <sup>3</sup>		
	Windows 2000 Professional SP2, SP3, SP4 Windows Millennium Edition Windows 98 <sup>5</sup> , 98 Second Edition			
Macintosh <sup>*2</sup>				
Interface	Operating System	Processor	RAM	Hard Disk Space <sup>4</sup>
USB 2.0 Hi-Speed	Mac OS X v.10.4	Intel processor PowerPC G3/ G4/G5	256 MB	450 MB
	Mac OS X v.10.2.8 - v.10.3		128 MB	

- \*1 Conform to the operating system's requirement when it is higher than this. For updated compatibility, visit our website.
  - \*2 Operation can only be guaranteed on a computer with built-in USB or USB 2.0 Hi-Speed port and pre-installed Windows XP, 2000, Me, 98, or Mac OS X v.10.2.8 - v.10.4.
  - \*3 Including compatible processors.
  - \*4 For bundled software installation.
  - \*5 ScanSoft OmniPage SE (OCR software) does not support Windows 98 first edition.
- CD-ROM drive
  - Display: Windows: 1024 x 768 Color 16 bit, Macintosh: 1024 x 768 Thousands Colors
  - Macintosh File System: Mac OS Extended (Journaled), Mac OS X Extended.

### Additional System Requirements for On-Screen Manuals

#### Windows

Browser: Windows HTML Help Viewer

Note: Microsoft Internet Explorer 5.0 or later must be installed. The on-screen manual may not be displayed properly depending on your operating system or Internet Explorer version. We recommend that you keep your system up to date with Windows Update.

#### Macintosh

Browser: Help Viewer

Note: The on-screen manual may not be displayed properly depending on your operating system. We recommend that you keep your system up to date.

# ▲ Safety Precautions

Please read the safety warnings and cautions provided in this manual to ensure that you use the machine safely. Do not attempt to use the machine in any way not described in this manual.

## ▲ Warning

This product emits low level magnetic flux. If you use a cardiac pacemaker and feel abnormalities, please move away from this product and consult your doctor.

## ▲ Warning

You may cause an electric shock, fire, or damage the machine if you ignore any of these safety precautions.

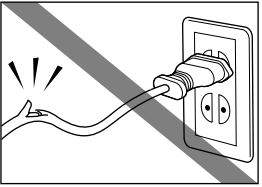
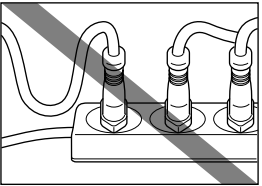
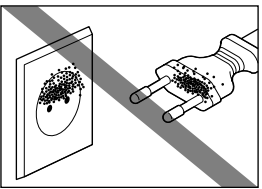
<b>Choosing a location</b>	Do not place the machine close to flammable solvents such as alcohol or thinners.	
<b>Power supply</b>	Never attempt to plug in or unplug the machine from the power supply when your hands are wet.	
	Always push the plug all the way into the power outlet.	
	Never damage, modify, stretch or excessively bend or twist the power cord. Do not place heavy objects on the power cord.	
	Never plug the machine into a power socket that is shared with other equipment (extension lead/cord, 2- or 3-way adapter, etc.).	
	Never use the machine if the power cord is bundled or knotted.	
	If you detect smoke, unusual smells or strange noises around the machine, immediately unplug the machine at the power supply and call for service.	
Periodically, unplug the machine and use a dry cloth to wipe off any dust or dirt collected on the plug and the power outlet. If the machine is placed at a location exposed to a lot of dust, smoke, or high humidity, the dust collected on the plug absorbs moisture and may cause insulation failure and fire.		
If you hear thunder, disconnect the power supply of the machine and refrain from using it. Leaving the machine plugged in may cause fire, electric shock, or damage to the machine, depending on the thunder storm.		

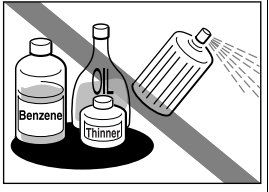
<b>Cleaning the machine</b>	<p>Use a damp cloth to clean the machine. Never use flammable solvents such as alcohol, benzene or thinners. If flammable solvents come in contact with electrical components inside the machine, it could cause a fire or electric shock.</p>	
	<p>Always unplug the machine from the power outlet before cleaning the machine. If you accidentally switch the machine on while cleaning it, you could injure yourself or damage the machine.</p>	
<b>Maintaining the machine</b>	<p>Do not attempt to disassemble or modify the machine. There are no user serviceable parts inside the machine. The machine contains high-voltage components. Never attempt any maintenance procedure not described in this guide.</p>	
<b>Working around the machine</b>	<p>Do not use highly flammable sprays near the machine. This could cause a fire or electric shock if the spray comes into contact with electrical components inside the machine.</p>	

**⚠ Caution**

You may cause injury or damage the machine if you ignore any of these safety precautions.

<b>Choosing a location</b>	<p>Do not install the machine in a location that is unstable or subject to excessive vibration.</p>
	<p>Do not install the machine in locations that are very humid or dusty, in direct sunlight, outdoors, or close to a heating source.</p>
	<p>To avoid the risk of fire or electric shocks, install the machine in a location with an ambient temperature range of 5°C to 35°C (41°F to 95°F) and humidity of 10% to 90% (condensation free).</p>
	<p>Do not place the machine on a thick rug or carpet.</p>
	<p>Do not place the machine with its back attached to the wall.</p>

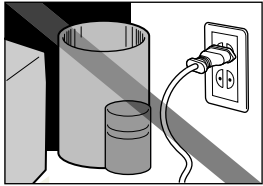
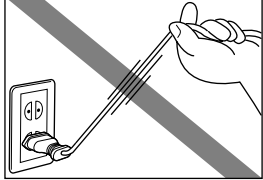
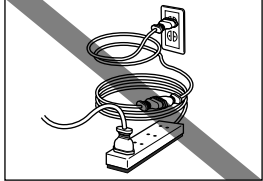
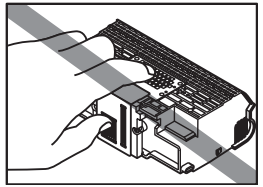
<b>Power supply</b>	<p>Ensure that the area around the power outlet is kept clear at all times so you can easily unplug the power cord if necessary.</p>	
	<p>Never remove the plug by pulling on the cord.</p>	
	<p>Do not use an extension lead/cord.</p>	
	<p>Never use a power supply source other than the one rated for the machine in the country of where you purchased the machine. AC 100-240 V, 50/60 Hz</p>	
<b>Working around the machine</b>	<p>Never put your hands or fingers in the machine while it is printing.</p> <p>Do not place any object on the machine.</p> <p>Do not place metal objects (paper clips, staples, etc.) or containers of flammable solvents (alcohol, thinners, etc.) on top of the machine.</p> <p>If any foreign object (metal or liquid) fall into the machine, unplug the power cord and call for service.</p> <p>Do not transport or store the machine on a slant, vertically or upside-down, as the ink may leak and damage the machine.</p> <p>When loading a thick book on the Platen Glass, do not press hard on the Document Cover. The Platen Glass may break and cause injury.</p>	
<b>Print Heads and ink tanks</b>	<p>For safety reasons, store Print Heads and ink tanks out of the reach of small children. If a child ingests any ink, consult a doctor immediately.</p> <p>Do not shake Print Heads or ink tanks. Ink may leak out and stain clothing or the surrounding area.</p> <p>Never touch the electrical contacts on a Print Head after printing. The metal parts may be very hot and could cause burns.</p>  <p>Do not throw ink tanks into fire.</p>	



# Legal Limitations on Use of Your Product and Use of Images

---

It may be unlawful to make copies of, scan, print, or use reproductions of the following documents. The list provided is non-exhaustive. When in doubt, check with a legal representative in your jurisdiction.

- Paper money
- Money orders
- Certificates of deposit
- Postage stamps (canceled or uncanceled)
- Identifying badges or insignias
- Selective service or draft papers
- Checks or drafts issued by governmental agencies
- Motor vehicle licenses and certificates of title
- Traveler's checks
- Food stamps
- Passports
- Immigration papers
- Internal revenue stamps (canceled or uncanceled)
- Bonds or other certificates of indebtedness
- Stock certificates
- Copyrighted works/works of art without permission of copyright owner

# Users in the U.S.A.

---

## ■ Regulatory Information

### FCC Notice (U.S.A. Only)

For 120V, 60Hz model

Model Number: K10290

This device complies with Part 15 of the FCC Rules. Operation is subject to the following two conditions: (1) This device may not cause harmful interference, and (2) this device must accept any interference received, including interference that may cause undesired operation.

Note: This equipment has been tested and found to comply with the limits for a Class B digital device, pursuant to Part 15 of the FCC Rules. These limits are designed to provide reasonable protection against harmful interference in a residential installation. This equipment generates, uses and can radiate radio frequency energy and, if not installed and used in accordance with the instructions, may cause harmful interference to radio communications.

However, there is no guarantee that interference will not occur in a particular installation. If this equipment does cause harmful interference to radio or television reception, which can be determined by turning the equipment off and on, the user is encouraged to try to correct the interference by one or more of the following measures:

- Reorient or relocate the receiving antenna.
- Increase the separation between the equipment and receiver.
- Connect the equipment into an outlet on a circuit different from that to which the receiver is connected.
- Consult the dealer or an experienced radio/TV technician for help.

Use of a shielded cable is required to comply with Class B limits in Subpart B of Part 15 of the FCC Rules.

Do not make any changes or modifications to the equipment unless otherwise specified in the manual. If such changes or modifications should be made, you could be required to stop operation of the equipment.

Canon U.S.A., Inc.  
One Canon Plaza  
Lake Success, NY 11042  
1-516-328-5600

## ■ Canon U.S.A., INC. LIMITED WARRANTY --- (USA Only)

The limited warranty set forth below is given by Canon U.S.A., Inc. ("Canon USA") with respect to the new or refurbished Canon-brand product ("Product") packaged with this limited warranty, when purchased and used in the United States only.

The Product is warranted against defects in materials and workmanship under normal use and service (a) for a period of one (1) year from the date of original purchase when delivered to you in new condition in its original container or (b) for 90 days from the date of original purchase for refurbished Products. Defective parts or a defective Product returned to a Canon USA repair facility or a Canon USA Authorized Service Facility ("ASF"), and proven to be defective upon inspection will be (a) repaired; (b) exchanged for new or comparable rebuilt, recovered, remanufactured, repaired and/or recycled parts or; (c) exchanged for a refurbished Product, as determined by the Canon USA repair facility or the ASF. Warranty repair or replacement shall not extend the original warranty period of the Product. A dated proof of purchase is required at the time of warranty service. A copy of your dated bill of sale will satisfy this requirement. This warranty does not cover any accessories, or any consumables, such as paper or ink cartridges, as to which there shall be no warranty or replacement.

This limited warranty shall only apply if the Product is used in conjunction with compatible computers, peripheral equipment and software. Canon USA shall have no responsibility for such items except for compatible Canon brand peripheral equipment covered by a separate warranty ("Separate Warranty"). Repairs of such Canon brand peripheral equipment shall be governed by the terms of the Separate Warranty. Non-Canon brand equipment and software that may be distributed with the Product are sold "as is" and without warranty of any kind by Canon USA, including any implied warranty regarding merchantability or fitness for a particular purpose, and all such warranties are disclaimed. The sole warranty, if any, with respect to such non-Canon brand items is given by the manufacturer or producer thereof.

This limited warranty covers all defects encountered in normal use of the Product and does not apply in the following cases:

- (a) Loss of or damage to the Product due to abuse, neglect, mishandling, improper packaging by you, alteration, accident, electrical current fluctuations, improper use, failure to follow operating or maintenance instructions in, or environmental conditions prescribed in, Canon USA's user's manual or other documentation, or services performed by someone other than a Canon USA repair facility or ASF. Without limiting the foregoing, dropping the Product, scratches, and abrasions will be presumed to have resulted from misuse, abuse or failure to operate the Product as set forth in the user's manual or other documentation for the Product.
- (b) Use of parts, media, software or supplies (other than those sold by Canon USA), including non-Canon ink cartridges or refilled ink cartridges, that cause damage to the Product or cause abnormally frequent service calls or service problems.
- (c) If the Product has had its serial number or dating defaced, altered or removed.

ANY SYSTEM SOFTWARE (WHETHER FACTORY LOADED ON THE PRODUCT OR CONTAINED ON THE SOFTWARE DISKETTES OR CD-ROMS ENCLOSED WITH, OR ACCOMPANYING, THE PRODUCT), AND ANY UTILITY SOFTWARE, DISTRIBUTED WITH OR FOR THE PRODUCT, IS SOLD "AS IS" AND WITHOUT WARRANTY BY CANON USA. THE SOLE WARRANTY WITH RESPECT TO SUCH SOFTWARE IS CONTAINED IN THE SOFTWARE MANUFACTURER'S LICENSE AGREEMENT DISTRIBUTED THEREWITH, INCLUDING ANY LIMITATIONS AND DISCLAIMERS THEREON. PLEASE CONTACT CANON USA IMMEDIATELY IF YOU HAVE NOT RECEIVED A COPY OF THE SOFTWARE MANUFACTURER'S LICENSE AGREEMENT.

NO IMPLIED WARRANTY, INCLUDING ANY IMPLIED WARRANTY OF MERCHANTABILITY OR FITNESS FOR A PARTICULAR PURPOSE, APPLIES TO THE PRODUCT AFTER THE APPLICABLE PERIOD OF THE EXPRESS LIMITED WARRANTY STATED ABOVE, AND NO OTHER EXPRESS WARRANTY OR GUARANTY, EXCEPT AS MENTIONED ABOVE, GIVEN BY ANY PERSON OR ENTITY WITH RESPECT TO THE PRODUCT SHALL BIND CANON USA, OR ITS ASF. (SOME STATES DO NOT ALLOW LIMITATIONS ON HOW LONG AN IMPLIED WARRANTY LASTS, SO THE ABOVE LIMITATION MAY NOT APPLY TO YOU.) CANON USA SHALL NOT BE LIABLE FOR LOSS OF REVENUES OR PROFITS, INCONVENIENCE, EXPENSE FOR SUBSTITUTE EQUIPMENT OR SERVICE, STORAGE CHARGES, LOSS OR CORRUPTION OF DATA, OR ANY OTHER SPECIAL, INCIDENTAL OR CONSEQUENTIAL DAMAGES CAUSED BY THE USE, MISUSE, OR INABILITY TO USE THE PRODUCT REGARDLESS OF THE LEGAL THEORY ON WHICH THE CLAIM IS BASED, AND EVEN IF CANON USA OR ITS ASF HAS BEEN ADVISED OF THE POSSIBILITY OF SUCH DAMAGES. NOR SHALL RECOVERY OF ANY KIND AGAINST CANON USA OR ITS ASF BE GREATER IN AMOUNT THAN THE PURCHASE PRICE OF THE PRODUCT CAUSING THE ALLEGED DAMAGE. WITHOUT LIMITING THE FOREGOING, YOU ASSUME ALL RISK AND LIABILITY FOR LOSS, DAMAGE OR INJURY TO YOU AND YOUR PROPERTY AND TO OTHERS AND THEIR PROPERTY ARISING OUT OF THE POSSESSION, USE, MISUSE, OR INABILITY TO USE THE PRODUCT SOLD BY CANON USA NOT CAUSED SOLELY AND DIRECTLY BY THE NEGLIGENCE OF CANON USA, OR ITS ASF. (SOME STATES DO NOT ALLOW THE EXCLUSION OR LIMITATION OF INCIDENTAL OR CONSEQUENTIAL DAMAGES, SO THE ABOVE EXCLUSION OR LIMITATION MAY NOT APPLY TO YOU.) THIS LIMITED WARRANTY SHALL NOT EXTEND TO ANYONE OTHER THAN THE ORIGINAL PURCHASER OF THE PRODUCT OR THE PERSON FOR WHOM IT WAS PURCHASED AS A GIFT, AND STATES YOUR EXCLUSIVE REMEDY.

Canon USA offers a range of customer technical support\* options:

- Interactive troubleshooting, e-mail technical support, the latest driver downloads and answers to frequently asked questions ([www.canontechsupport.com](http://www.canontechsupport.com))
- Toll-free live technical support Monday-Saturday (excluding holidays) at 1-800-828-4040
- Telephone Device for the Deaf (TDD-1-866-251-3752)
- Repair or Exchange Service Options:  
In the event service is required for the Product during the limited warranty period, Canon USA offers two hardware support options:

#### **Authorized Service Facility Carry-In / Mail-In Service**

Canon USA's Carry-In/Mail-In Service provides repair or exchange, at Canon USA's option, through Canon USA's Authorized Service Facility (ASF) network. The name and telephone number of the ASF(s) near you may be obtained from Canon USA's Web site at [www.canontechsupport.com](http://www.canontechsupport.com) or by calling the Canon USA Customer Care Center at 1-800-828-4040, or any time while speaking to a technical support person. A Product covered by this limited warranty will be repaired or exchanged, as determined by Canon USA, and returned without charge by the ASF.

#### **InstantExchange Service \*\***

A Canon Customer Care Center or ASF technician will attempt to diagnose the nature of the problem and, if possible, correct it over the telephone. If the problem cannot be corrected over the telephone, and you elect the InstantExchange option, a reference number will be issued to you. You will be asked for the Product serial number and other information pertaining to your defective Product and for a ship-to location for the replacement Product (must include street address).

The Canon USA repair facility will ship out the replacement Product, via 2nd day Air freight service, prepaid by Canon USA. After receipt of the replacement Product (with instructions and a prepaid waybill), follow the enclosed instructions on how to ship the defective Product to the Canon USA repair facility. The defective Product must be returned in the shipping carton in which the replacement Product was packed and include the reference number, A COPY OF YOUR DATED PROOF OF PURCHASE (BILL OF SALE), and a complete explanation of the problem. DO NOT INCLUDE ANY OTHER ITEMS WITH THE DEFECTIVE PRODUCT IN THE RETURN SHIPPING CARTON, AND BE SURE TO RETAIN YOUR PRINTHEAD AND INK CARTRIDGE(S) AND TANK(S).

InstantExchange Service expedites, usually by the second business day, the exchange of a defective Product with a replacement Product, which will normally be shipped the same day if your request for this service is by 3 p.m. E.T. Monday through Friday, except holidays (three (3) business day InstantExchange Service for Alaska and Hawaii). Canon USA does not guarantee expedited shipping service in the event of the occurrence of factors beyond its reasonable control. The replacement Product you receive may be a refurbished or reconditioned unit and will be covered for the balance of the period remaining on your original limited warranty. NOTE THAT BY USING THIS SERVICE YOU WILL KEEP THE REPLACEMENT PRODUCT THAT IS SENT TO YOU. CANON USA WILL RETAIN THE DEFECTIVE PRODUCT THAT YOU ORIGINALLY PURCHASED, WHICH SHALL BECOME THE PROPERTY OF CANON USA. InstantExchange warranty program service is available only during the express limited-warranty period for your Product and only in the continental United States, Alaska and Hawaii during such period.

This limited warranty gives you specific legal rights, and you may also have other rights, which vary from state to state.

\* Support program specifics are subject to change without notice.

\*\* InstantExchange warranty service is subject to the availability of refurbished or new replacement units.

**Canon U.S.A., Inc.**  
**One Canon Plaza**  
**Lake Success, NY 11042**  
**USA**

©2006 Canon U.S.A., Inc. Canon is a registered trademark of Canon Inc. in the United States and may also be a registered trademark in other countries.

## ■ **Mercury Legislation**

 LAMP(S) INSIDE THIS PRODUCT CONTAIN MERCURY AND MUST BE RECYCLED OR DISPOSED OF ACCORDING TO LOCAL, STATE OR FEDERAL LAWS

# Index

## A

Appendix 94

## B

Before Printing 2

## C

Changing the Paper and Print Settings 22  
copy mode 22  
Memory card, easy photo reprint, and film print modes 24

Cleaning

inside 69  
platen glass and document cover 68  
roller 68

CLI-8BK Black 50

CLI-8C Cyan 50

CLI-8M Magenta 50

CLI-8PC Photo Cyan 50

CLI-8PM Photo Magenta 50

CLI-8Y Yellow 50

Copying 30

## E

Easy-Scroll Wheel 2

## F

Function Buttons 3

## H

HOME button 2

## L

Legal Limitations on Use of Your Product and Use of Images 101

Loading Original Documents 6

Loading Printing Paper

Auto Sheet Feeder 17

Cassette 18

Envelopes 20

recommended paper and requirements 8

## M

Media

cannot use 10  
specialty 11

Media Type 8

Memory Card

inserting 33

removing 34

supported by this machine 32

## N

NAVI Button 3

Nozzle Check Pattern

examining 58

printing 57

## P

PGI-5BK Black 50

Photo Printing from Photo or Film 37

scanning a film 37

scanning a photo 37

select and print 41

Print Head

automatic print head alignment 64

cleaning 60

deep cleaning 62

manual print head alignment 65

Printing from a Memory Card 32

Photo Index Sheet 36

select and print 34

Printing from Your Computer 27

Macintosh 28

Windows 27

Printing Photographs Directly from a Compliant

Device 43

connecting 43

PictBridge 45

## R

Replacing Ink Tanks 52

ink level information 50

knowing when to replace ink tank 51

Routine Maintenance 50

replacing ink tanks 52

## S

Safety Precautions 98

Scanning Images 29

Specialty Media 11

Specifications

copy 95

general 95

PictBridge 96

scan 95

System Requirements 96

## T

Troubleshooting 71

Turning off the Machine 4

Turning on the Machine 4

## U

Users in the U.S.A.

Canon U.S.A., Inc. Limited Warranty - U.S. Only

102









## This product uses the following copyrighted software:

exit.c Copyright © 1990 The Regents of the University of California.  
All rights reserved.

Redistribution and use in source and binary forms are permitted provided that the above copyright notice and this paragraph are duplicated in all such forms and that any documentation, advertising materials, and other materials related to such distribution and use acknowledge that the software was developed by the University of California, Berkeley. The name of the University may not be used to endorse or promote products derived from this software without specific prior written permission.

THIS SOFTWARE IS PROVIDED "AS IS" AND WITHOUT ANY EXPRESS OR IMPLIED WARRANTIES, INCLUDING, WITHOUT LIMITATION, THE IMPLIED WARRANTIES OF MERCHANTABILITY AND FITNESS FOR A PARTICULAR PURPOSE.

environ.c Copyright © 1995, 1996 Cygnus Support.  
All rights reserved.

Redistribution and use in source and binary forms are permitted provided that the above copyright notice and this paragraph are duplicated in all such forms and that any documentation, advertising materials, and other materials related to such distribution and use acknowledge that the software was developed at Cygnus Support, Inc. Cygnus Support, Inc. may not be used to endorse or promote products derived from this software without specific prior written permission.

THIS SOFTWARE IS PROVIDED "AS IS" AND WITHOUT ANY EXPRESS OR IMPLIED WARRANTIES, INCLUDING, WITHOUT LIMITATION, THE IMPLIED WARRANTIES OF MERCHANTABILITY AND FITNESS FOR A PARTICULAR PURPOSE.

impure.c Copyright © 1994, 1997 Cygnus Solutions.  
string.h All rights reserved.  
\_ansi.h

Redistribution and use in source and binary forms are permitted provided that the above copyright notice and this paragraph are duplicated in all such forms and that any documentation, advertising materials, and other materials related to such distribution and use acknowledge that the software was developed at Cygnus Solutions. Cygnus Solutions may not be used to endorse or promote products derived from this software without specific prior written permission.  
THIS SOFTWARE IS PROVIDED "AS IS" AND WITHOUT ANY EXPRESS OR IMPLIED WARRANTIES, INCLUDING, WITHOUT LIMITATION, THE IMPLIED WARRANTIES OF MERCHANTABILITY AND FITNESS FOR A PARTICULAR PURPOSE.

# Ordering Information

For additional supplies, use the following descriptions and order numbers.

<b>Description</b>	<b>Order #</b>
<b>Ink Tanks</b>	
PGI-5 Black	0628B002
CLI-8 Black	0620B002
CLI-8 Cyan	0621B002
CLI-8 Magenta	0622B002
CLI-8 Yellow	0623B002
CLI-8 Photo Cyan	0624B002
CLI-8 Photo Magenta	0625B002
<b>Canon Specialty Papers</b>	
Photo Paper Plus Glossy (4" x 6" / 20 sheets)	7980A007
Photo Paper Plus Glossy (4" x 6" / 50 sheets)	7980A012
Photo Paper Plus Glossy (4" x 6" / 120 sheets)	7980A022
Photo Paper Plus Glossy (5" x 7" / 20 sheets)	7980A019
Photo Paper Plus Glossy (8.5" x 11" / 20 sheets)	7980A006
Photo Paper Plus Double Sided (5" x 7" / 10 sheets)	9981A006
Photo Paper Plus Double Sided (8.5" x 11" / 10 sheets)	9981A005
Photo Paper Plus Double Sided Album Kit (5" x 7")	0041B005
Photo Paper Plus Double Sided Album Kit (8.5" x 11")	0041B006
Photo Paper Pro for Borderless Printing (4" x 6" / 20 sheets)	1029A014
Photo Paper Pro for Borderless Printing (4" x 6" / 75 sheets)	1029A027
All Occasion Photo Cards (4" x 8" / 50 sheets)	1029A055
Photo Paper Pro (8.5" x 11" / 15 sheets)	1029A004
Photo Paper Pro (8.5" x 11" / 30 sheets)	1029A028
Photo Paper Pro (8" x 10" / 20 sheets)	1029A059
Fine Art Photo Rag (8.5" x 11" / 20 sheets)	0587B005
Matte Photo Paper (4" x 6" / 120 sheets)	7981A014
Matte Photo Paper (8.5" x 11" / 50 sheets)	7981A004
Photo Paper Glossy (4" x 6" / 50 sheets)	0775B021
Photo Paper Glossy (4" x 6" / 100 sheets)	0775B022
Photo Paper Glossy (8.5" x 11" / 50 sheets)	0775B023
Photo Paper Glossy (8.5" x 11" / 100 sheets)	0775B024
Glossy Photo Paper Credit Card Size	9157A023
Photo Stickers	0001C001
High Resolution Paper (8.5" x 11" / 100 sheets)	1033A011

Call **1-800-OK-CANON** to locate a dealer near you, or visit the Canon eStore at [www.estore.usa.canon.com](http://www.estore.usa.canon.com).



© 2006 Canon U.S.A., Inc. Canon is a registered trademark of Canon Inc. in the United States and may be a registered trademark or trademarks in other countries. All other product and brand names are trademarks of their respective owners. As an ENERGY STAR® partner, Canon U.S.A., Inc. has determined that this product meets the ENERGY STAR® guidelines for energy efficiency.

The following ink tanks are compatible with this product.

