



MG5500 series Online Manual

Troubleshooting

Contents

Troubleshooting.	7
Problems with Network Communication.	8
Problems with the Machine While Using with Network.	9
The Machine Stopped Working Suddenly.	10
Ink Remaining Level Is Not Displayed on Printer Status Monitor of the Machine.	12
Printing Speed Is Slow.	13
Cannot Use the Machine on Replacing an Access Point or Changing Its settings.	14
Cannot Detect a Machine on a Network.	15
Cannot Detect the Machine When Setting up Network Communication.	16
Cannot Detect the Machine during Wireless LAN Setup: Check 1.	17
Cannot Detect the Machine during Wireless LAN Setup: Check 2.	18
Cannot Detect the Machine during Wireless LAN Setup: Check 3.	19
Cannot Detect the Machine during Wireless LAN Setup: Check 4.	20
Cannot Detect the Machine during Wireless LAN Setup: Check 5.	21
Cannot Detect the Machine during Wireless LAN Setup: Check 6.	22
The Machine Cannot Be Detected in the Wireless LAN.	23
Other Problems with Network.	25
Forgot an Access Point Name, SSID, or a Network Key.	26
The Message Is Displayed on the Computer Screen During Setup.	27
The Admin Password Set to the Machine Was Forgotten.	28
Checking Information about the Network.	29
Packets Are Sent Steadily.	31
How to Restore the Machine's Network Settings to Factory Default.	32
Problems with Printing.	33
Printing Does Not Start.	34
Paper Jams.	36
Paper Does Not Feed Properly/"No Paper" Error Occurs.	37
Cannot Print Properly with Automatic Duplex Printing.	39
Copying/Printing Stops Before It Is Completed.	40
Problems with Printing Quality.	41
Print Results Not Satisfactory.	42
Cannot Print to End of Job.	44
Part of the Page Is Not Printed.	45
No Printing Results/Printing Is Blurred/Colors Are Wrong/White Streaks.	46
Lines Are Misaligned.	49

Line Does Not Print or Prints Partially.	50
Image Does Not Print or Prints Partially.	51
Printed Paper Curls or Has Ink Blots.	52
Paper Is Smudged/Printed Surface Is Scratched.	53
Back of the Paper Is Smudged.	57
Vertical Lines Are Printed on the Sides of the Printout.	58
Colors Are Uneven or Streaked.	59
Ink Is Not Ejected.	61
Problems with Scanning.	62
Problems with Scanning.	63
Scanner Does Not Work.	64
ScanGear (Scanner Driver) Does Not Start.	65
Error Message Appears and the ScanGear (Scanner Driver) Screen Does Not Appear.	66
Cannot Scan Multiple Items at One Time.	67
Cannot Scan Properly with Auto Scan.	68
Slow Scanning Speed.	69
"There is not enough memory." Message Is Displayed.	70
Computer Stops Operating during Scanning.	71
Scanner Does Not Work after Upgrading Windows.	72
Scanned Image Does Not Open.	74
Scan Results Not Satisfactory.	75
Scan Quality (Image Displayed on the Monitor) Is Poor.	76
Scanned Image Is Surrounded by Extra White Areas.	78
Cannot Scan at the Correct Size.	79
Position or Size of the Image Cannot be Detected Correctly When Scanning from the Operation Panel.	80
Item Is Placed Correctly, but the Scanned Image Is Slanted.	81
Scanned Image Is Enlarged (Reduced) on the Computer Monitor.	82
Software Problems.	83
The E-mail Client You Want to Use Does Not Appear in the Screen for Selecting an E-mail Client	84
Problems with the Machine.	85
The Machine Cannot Be Powered On.	86
The Machine Turns Off Unintendedly.	87
Cannot Connect to Computer with a USB Cable Properly.	88
Cannot Communicate with the Machine with USB Connection.	89
LCD Cannot Be Seen At All.	90
An Unintended Language Is Displayed on the LCD.	91
Print Head Holder Does Not Move to the Position for Replacing.	92

Printer Status Monitor Is Not Displayed.	93
Problems with Installation/Downloading.	94
Cannot Install the MP Drivers.	95
Easy-WebPrint EX Does Not Start Up or Easy-WebPrint EX Menu Does Not Appear.	97
How to Update MP Drivers in Network Environment.	98
Uninstalling IJ Network Tool.	99
About Errors/Messages Displayed.	100
If an Error Occurs.	101
A Message Is Displayed.	102
If You Cannot Resolve the Problem.	107
Support Code List.	108
Support Code List (When Paper Is Jammed).	110
1300.	111
1303.	113
1304.	115
Paper Is Jammed inside the Machine.	118
In Other Cases.	121
1003.	122
1200.	123
1250.	124
1310.	125
1401.	126
1403.	127
1405.	128
1410.	129
1411.	130
1412.	131
1413.	132
1414.	133
1600.	134
1660.	135
1680.	136
1681.	137
1684.	138

1688.	139
1689.	140
1700.	141
1701.	142
1712.	143
1713.	144
1714.	145
1715.	146
1890.	147
2100.	148
2101.	149
2102.	150
2103.	151
2700.	152
2900.	153
4100.	154
4103.	155
5011.	156
5012.	157
5100.	158
5200.	159
5400.	160
5B00.	161
5B01.	162
5B12.	163
5B13.	164
5B14.	165
5B15.	166
6000.	167
6500.	168
6502.	169
6800.	170
6801.	171
6900.	172

6901.....	173
6902.....	174
6910.....	175
6911.....	176
6930.....	177
6931.....	178
6932.....	179
6933.....	180
6936.....	181
6937.....	182
6938.....	183
6940.....	184
6941.....	185
6942.....	186
6943.....	187
6944.....	188
6945.....	189
6946.....	190
B200.....	191
C000.....	192

Troubleshooting

- ➔ [The Machine Cannot Be Powered On](#)
- ➔ [Printing Does Not Start](#)
- ➔ [Paper Does Not Feed Properly/"No Paper" Error Occurs](#)
- ➔ [Print Results Not Satisfactory](#)
- ➔ [Ink Is Not Ejected](#)
- ➔ [Paper Jams](#)
- ➔ [If an Error Occurs](#)

Search Each Function

- ➔ [Problems with Network Communication](#)
- ➔ [Problems with Printing](#)
- ➔ [Problems with Printing Quality](#)
- ➔ [Problems with Scanning](#)
- ➔ [Problems with the Machine](#)
- ➔ [Problems with Installation/Downloading](#)
- ➔ [About Errors/Messages Displayed](#)
- ➔ [If You Cannot Resolve the Problem](#)

Problems with Network Communication

- ➔ [Problems with the Machine While Using with Network](#)
- ➔ [Cannot Detect a Machine on a Network](#)
- ➔ [Other Problems with Network](#)

Problems with the Machine While Using with Network

- ➔ [The Machine Stopped Working Suddenly](#)
- ➔ [Ink Remaining Level Is Not Displayed on Printer Status Monitor of the Machine](#)
- ➔ [Printing Speed Is Slow](#)
- ➔ [Cannot Use the Machine on Replacing an Access Point or Changing Its settings](#)

The Machine Stopped Working Suddenly

➔ [Cannot Communicate with the Machine After the Network Settings Are Changed](#)

➔ [Cannot Communicate with the Machine over the Wireless LAN](#)

➔ [Cannot Print or Scan from a Computer Connected to the Network](#)

Cannot Communicate with the Machine After the Network Settings Are Changed

Wait until the IP address is assigned to the computer. You may need to restart your computer.

Search for the printer again after confirming a valid IP address is assigned to the computer.

Cannot Communicate with the Machine over the Wireless LAN

Check1 Make sure that the machine is turned on.

Check2 Make sure that the network settings in the machine are identical with those of the access point.

Refer to the instruction manual provided with the access point or contact its manufacturer to check the access point settings, and then modify the machine settings.

➔ [How to Set a WEP/WPA/WPA2 Key](#)

Check3 Make sure that the machine is not placed as far away from the access point.

The access point is located indoors within the effective range for wireless communication. Locate the machine within 164 ft. / 50 m from the access point.

Check4 Make sure that there is no obstruction.

Wireless communication between different rooms or floors is generally poor. Adjust the location of the devices.

Check5 Make sure that there is no source of radio wave interference in your vicinity.

There may be a device such as a microwave oven using the same frequency bandwidth as the wireless station. Place the wireless devices as far away from the interference source as possible.

Check6 Make sure that the network settings of the computer are correct.

For the procedures to connect a network device to the computer and set them up, refer to the instruction manual of your network device or contact its manufacturer.

Check7 Make sure that the radio status is good and adjust the installation positions while monitoring the radio status with IJ Network Tool.

➔ [Monitoring Wireless Network Status](#)

Check8 Make sure that the valid wireless channel is used.

The wireless channel to be used may be limited depending on wireless network devices installed in the computer. Refer to the instruction manual provided with your computer or your wireless network device to specify the valid wireless channel.

Check9 Make sure that the channel set to the access point is valid to communicate with the computer, confirmed in Check 8.

If not, change the channel set to the access point.

Check10 Make sure that the firewall of the security software is disabled.

If the firewall function of your security software is turned on, a message may appear warning that Canon software is attempting to access the network. If the warning message appears, set the security software to always allow access.

If using any programs that switch the network environment, check their settings. Some programs will enable a firewall by default.

Check11 When using a router, connect the printer and computer to the LAN side (same network segment).

If the problem is not resolved, perform setup with the Setup CD-ROM or perform it according to the instructions on our website.

- **For placement:**

Make sure that there is no barrier or obstacle between the access point and the machine.

Cannot Print or Scan from a Computer Connected to the Network

Check1 Make sure that the network settings of the computer are correct.

For the procedures to set up the computer, refer to the instruction manual of your computer or contact its manufacturer.

Check2 If the MP Drivers are not installed, install the MP Drivers.

Install the MP Drivers with the Setup CD-ROM or install them from our website.

Check3 When using wireless LAN, make sure that access control is not set to the access point.

For the procedures to connect an access point and set it up, refer to the instruction manual of your access point or contact its manufacturer.

Note

- To check the MAC address or the IP address of the computer, see [Checking the IP Address or the MAC Address of the Computer](#).

Ink Remaining Level Is Not Displayed on Printer Status Monitor of the Machine

Use the printer driver with bidirectional communication.

Select **Enable bidirectional support** in the **Ports** sheet of the properties dialog box of the printer driver.

➡ How to Open the Printer Driver Setup Window

Printing Speed Is Slow

Check1 The machine may be printing out or scanning a large job issued from another computer.

Check2 Make sure that the radio status is good and adjust the installation positions while monitoring the radio status with IJ Network Tool.

➔ Monitoring Wireless Network Status

Make sure that there is no barrier or obstacle between the access point and the machine. Wireless communication between different rooms or floors is generally poor. The metal, concrete, or timber including the metallic material, mud wall, or insulator may interrupt a wireless communication. If the machine cannot communicate with the computer over a wireless LAN for the wall material, place the machine and the computer in the same room or floor.

Check3 Make sure that there is no source of interference in your vicinity.

Since a device such as a microwave oven uses the same frequency bandwidth, it may cause interference. Place the wireless devices as far away from the source of interference as possible.

Cannot Use the Machine on Replacing an Access Point or Changing Its settings

When you replace an access point, perform network setup of the machine again.

Perform network setup again with the Setup CD-ROM or perform it again according to the instructions on our website.

If the problem is not resolved, see below.

➔ [Cannot Communicate with the Machine After Applying MAC/IP Address Filtering or Entering a WEP/WPA/WPA2 Key to the Access Point](#)

➔ [When Encryption Is Enabled, Cannot Communicate With the Machine After the Encryption Type Was Switched on the Access Point](#)

Cannot Communicate with the Machine After Applying MAC/IP Address Filtering or Entering a WEP/WPA/WPA2 Key to the Access Point

Check1 Confirm the access point setting.

Refer to the instruction manual provided with the access point or contact its manufacturer to confirm the access point setting. Make sure that the computer and the access point can communicate with each other under this setting.

Check2 If you are performing MAC address filtering or IP address filtering at the access point, confirm that the MAC address or IP address for both the computer or the network device and the printer are registered.

Check3 If you are using a WEP/WPA/WPA2 key, make sure that the key for the computer or the network device and the printer matches that set to the access point.

Besides the WEP key itself, the key length, key format, the key ID to use, and the authentication method must match among the machine, the access point, and the computer.

Normally, select **Auto** for the authentication method. If you want to specify the method manually, select **Open System** or **Shared Key** according to the setting of the access point.

➔ [How to Set a WEP/WPA/WPA2 Key](#)

When Encryption Is Enabled, Cannot Communicate With the Machine After the Encryption Type Was Switched on the Access Point

If the printer cannot communicate with the computer after the encryption type of the printer was switched, make sure that encryption types for the computer and the access point matches that set to the printer.

➔ [Cannot Communicate with the Machine After Applying MAC/IP Address Filtering or Entering a WEP/WPA/WPA2 Key to the Access Point](#)

Cannot Detect a Machine on a Network

- ➔ [Cannot Detect the Machine When Setting up Network Communication](#)
- ➔ [The Machine Cannot Be Detected in the Wireless LAN](#)

Cannot Detect the Machine When Setting up Network Communication

If the machine could not be detected on the network when setting up the network communication, confirm the network settings before redetecting the machine.

➡ [Cannot Detect the Machine during Wireless LAN Setup: Check 1](#)

▶▶▶ Note

- You can set up the network communication via USB. To set up via USB, select the **Set up the network connection via USB** check box on the **Check Printer Settings** screen and click **Next**.

Cannot Detect the Machine during Wireless LAN Setup: Check 1

Are the machine and network device (router, access point, etc.) turned on?

Make sure that the machine is turned on.

➡ Confirming that the Power Is On

Make sure that the network device (router, access point, etc.) is turned on.

If the machine or the network device is turned off:

Turn on the machine or the network device.

After turning on the machine or the network device, it may take some time until ready for use. After a while just turning on the machine or the network device, click **Redetect** on the **Check Printer Settings** screen.

When the machine is detected, follow the instructions on the screen to continue to set up the network communication.

If the machine and the network device are turned on:

If the machine and the network device are turned on or if the machine could not be detected after clicking **Redetect**, go to check 2.

➡ [Cannot Detect the Machine during Wireless LAN Setup: Check 2](#)

Cannot Detect the Machine during Wireless LAN Setup: Check 2

Is the wireless LAN setting of the machine enabled?

Make sure that the Wi-Fi lamp of the machine is lit blue.



If the Wi-Fi lamp is off:

The wireless LAN setting of the machine is not activated. Activate the wireless LAN setting of the machine.

After activating the wireless LAN setting, click **Back to Top** on the **Check Printer Settings** screen to try to set up the network communication from the beginning.

If the Wi-Fi lamp is lit:

Go to check 3.

➡ [Cannot Detect the Machine during Wireless LAN Setup: Check 3](#)

Cannot Detect the Machine during Wireless LAN Setup: Check 3

Is the machine connected to the access point?

By using the operation panel of the machine, make sure that the machine is connected to the access point.

Select **Setup** on the **HOME** screen, then select **Device settings > LAN settings > Confirm LAN settings > WLAN setting list**.

Make sure that **Connection** on the LCD is set to **Active**.

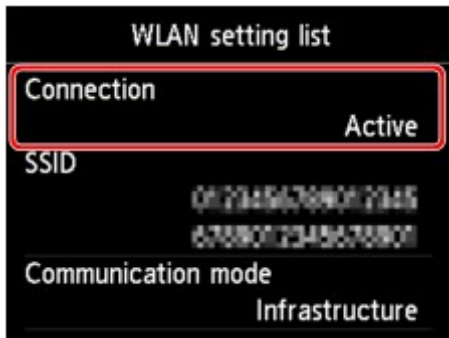

If Connection is set to Inactive:

The machine may be placed far away from the access point. Place the machine near the access point temporarily, then click **Redetect** on the **Check Printer Settings** screen.

When the machine is detected, follow the instructions on the screen to continue to set up the network communication.

If the machine cannot be detected, the machine is not connected to the access point. Connect the machine to the access point.

Click **Back to Top** on the **Check Printer Settings** screen to try to set up the network communication from the beginning.

If Connection is set to Active:

Go to check 4.

➡ [Cannot Detect the Machine during Wireless LAN Setup: Check 4](#)

Cannot Detect the Machine during Wireless LAN Setup: Check 4

Are the SSID of the access point connected to your computer and that of the machine the same?

You can confirm the SSID specified for the machine on the LCD.

Select **Setup** on the **HOME** screen, then select **Device settings** > **LAN settings** > **Confirm LAN settings** > **WLAN setting list**.

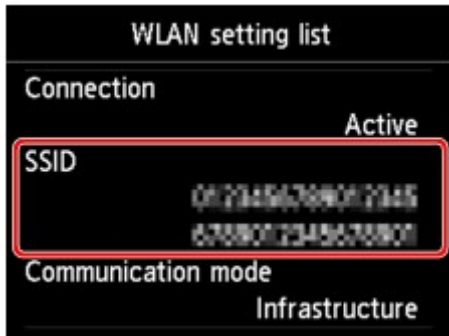

From your computer, you can confirm the SSID of the access point connected to your computer. In Windows 8, Windows 7, or Windows Vista, confirm the SSID from the wireless network communication icon of the notification area on the desktop.

➤➤ Note

- If the SSID of the access point is not displayed on your computer, check the settings of your computer.

If the SSID of the access point and that of the machine are different:

Click **Back to Top** on the **Check Printer Settings** screen to try to set up the network communication from the beginning. When you try to set up, specify the same SSID of the access point for the machine and your computer.

If the SSID of the access point and that of the machine are the same:

Go to check 5.

➡ [Cannot Detect the Machine during Wireless LAN Setup: Check 5](#)

Cannot Detect the Machine during Wireless LAN Setup: Check 5

Does the firewall function of your security software or operation system for computer interfere with setting up the network communication?

The firewall function of your security software or operation system for computer may limit communications between the machine and your computer. Confirm the setting of firewall function of your security software or operation system or the message appearing on your computer.

If the firewall function interferes with setting up:

- **When the message appears on your computer:**

If the message warning that Canon software is attempting to access the network appears on the computer, set the security software to allow access.

Then click **Redetect** on the **Check Printer Settings** screen.

When the machine is detected, follow the instructions on the screen to continue to set up the network communication.

- **When the message does not appear on your computer:**

Cancel to set up, then set the security software to allow Canon software* to access the network.

* On the Setup CD-ROM, select **win > Driver > DrvSetup**, then set the security software to allow the file **Setup.exe** or **Setup64.exe** to access the network.

After setting the security software, try to set up the network communication from the beginning.

▶▶ Note

- For the operation system firewall settings or the security software firewall settings, refer to the instruction manual of the computer or software, or contact its manufacturer.

If there is no problem with the firewall settings:

Go to check 6.

➡ [Cannot Detect the Machine during Wireless LAN Setup: Check 6](#)

Cannot Detect the Machine during Wireless LAN Setup: Check 6

Check the settings of the access point.

Check the settings of the access point for the network connection such as IP address filtering, MAC address filtering, or DHCP function.

For details on how to check the settings of the access point, refer to the instruction manual supplied with the access point or contact its manufacturer.

After checking the settings of the access point, click **Redetect** on the **Check Printer Settings** screen.

When the machine is detected, follow the instructions on the screen to continue to set up the network communication.

If the problem is not resolved, select the **Set up the network connection via USB** check box on the **Check Printer Settings** screen and click **Next** to set up the network communication via USB.

The Machine Cannot Be Detected in the Wireless LAN

Check1 Make sure that the machine is turned on.

Check2 Is **WLAN active/inactive** in **LAN settings** under **Device settings** set to **Disable LAN**?

Check3 When the machine is connected to the computer temporarily using a USB cable, make sure that the USB cable is connected properly.

When you set up the wireless LAN connection using a USB cable or change the wireless LAN settings using IJ Network Tool, connect the machine and the computer securely.

➔ Connecting the Machine to the Computer Using a USB Cable

Check4 Make sure that the machine setup is completed.

If not, perform setup with the Setup CD-ROM or perform it according to the instructions on our website.

Check5 When using IJ Network Tool, click **Update** to search for the printer again.

➔ Canon IJ Network Tool Screen

Check6 When searching for a printer over a network, make sure that the machine is associated with the port.

When **No Driver** is displayed under **Name** in IJ Network Tool, there is no association. Select **Associate Port** on the **Settings** menu, then associate the port with the printer.

➔ When the Printer Driver Is Not Associated with a Port

Check7 Make sure that the network settings in the printer are identical with those of the access point.

Refer to the instruction manual provided with the access point or contact its manufacturer to check the access point settings, and then modify the machine settings.

➔ [How to Set a WEP/WPA/WPA2 Key](#)

Check8 Make sure that there is no obstruction.

Wireless communication between different rooms or floors is generally poor. Adjust the location of the devices.

Check9 Make sure that the machine is not placed as far away from the access point.

The access point is located indoors within the effective range for wireless communication. Locate the machine within 164 ft. / 50 m from the access point.

Check10 Make sure that there is no source of radio wave interference in your vicinity.

There may be a device such as a microwave oven using the same frequency bandwidth as the wireless station. Place the wireless devices as far away from the interference source as possible.

Check11 Make sure that the network settings of the computer are correct.

Make sure that the computer can communicate with the printer and the access point over the wireless LAN.

Check12 Make sure that **Enable bidirectional support** is selected in the **Ports** sheet of the properties dialog box of the printer driver.

Check13 Make sure that the firewall of the security software is disabled.

If the firewall function of your security software is turned on, a message may appear warning that Canon software is attempting to access the network. If the warning message appears, set the security software to always allow access.

If using any programs that switch the network environment, check their settings. Some programs will enable a firewall by default.

Check14 When using a router, connect the printer and computer to the LAN side (same network segment).

If the problem is not resolved, perform setup with the Setup CD-ROM or perform it according to the instructions on our website.

Other Problems with Network

- ➔ [Forgot an Access Point Name, SSID, or a Network Key](#)
- ➔ [The Message Is Displayed on the Computer Screen During Setup](#)
- ➔ [The Admin Password Set to the Machine Was Forgotten](#)
- ➔ [Checking Information about the Network](#)
- ➔ [Packets Are Sent Steadily](#)
- ➔ [How to Restore the Machine's Network Settings to Factory Default](#)

Forgot an Access Point Name, SSID, or a Network Key

➔ [Cannot Connect with an Access Point to Which a WEP/WPA/WPA2 Key Is Set \(You Forgot the WEP/WPA/WPA2 Key\)](#)

➔ [How to Set a WEP/WPA/WPA2 Key](#)

Cannot Connect with an Access Point to Which a WEP/WPA/WPA2 Key Is Set (You Forgot the WEP/WPA/WPA2 Key)

For information on how to set up the access point, refer to the instruction manual provided with the access point or contact its manufacturer. Make sure that the computer and the access point can communicate with each other, then set up the machine to match the settings of the access point.

How to Set a WEP/WPA/WPA2 Key

Refer to the instruction manual provided with the access point or contact its manufacturer and check the access point settings. Make sure that the computer and the access point can communicate with each other, then set up the machine to match the settings of the access point.

- **When using WEP**

The key length, key format, the key to use (one of 1 to 4), and the authentication method must match among the access point, the printer, and the computer.

In order to communicate with an access point that uses automatically generated WEP keys, you must configure the machine to use the key generated by the access point by entering it in hexadecimal format.

Normally, select **Auto** for the authentication method. Otherwise, select **Open System** or **Shared Key** according to the setting of the access point.

When the **WEP Details** screen appears after clicking **Set** on the **Search** screen, follow the on-screen instructions and set the key length, the key format, the key number, and the authentication to enter a WEP key.

For details, see Changing the WEP Detailed Settings.

- **When using WPA or WPA2**

The authentication method, passphrase, and dynamic encryption type must match on the access point, the machine, and the computer.

Enter the passphrase configured on the access point (a sequence of between 8 and 63 alphanumeric characters, or a 64-character hexadecimal number).

Select either **TKIP (Basic Encryption)** or **AES (Secure Encryption)** for the dynamic encryption method.

For details, see Changing the WPA or WPA2 Detailed Settings.

Note

- This machine supports WPA-PSK (WPA-Personal) and WPA2-PSK (WPA2-Personal).

The Message Is Displayed on the Computer Screen During Setup

- ➔ [The Enter Password Screen Is Displayed During Setup](#)
- ➔ [The Screen for Setting the Encryption Is Displayed After Selecting the Access Point in the Search Screen](#)
- ➔ ["You are connecting the machine to the non encrypted wireless network" Is Displayed](#)

The Enter Password Screen Is Displayed During Setup

The following screen is displayed if an administrator password is set to the machine which has already been set up.



Enter the administrator password you have set.

- ➔ [Changing the Settings in the Admin Password Sheet](#)

The Screen for Setting the Encryption Is Displayed After Selecting the Access Point in the Search Screen

This screen is displayed automatically if the selected access point is encrypted. In this case, configure the details to use the same encryption settings set to the access point.

For information on the encryption settings, see [Changing the Settings in the Wireless LAN Sheet](#).

"You are connecting the machine to the non encrypted wireless network" Is Displayed

Security is not configured on the access point. The machine can still be used, so continue the setup procedure to complete it.

➔➔➔ Important

- If you connect to a network that is not protected with security measures, there is a risk of disclosing data such as your personal information to a third party.

The Admin Password Set to the Machine Was Forgotten

Initialize the LAN settings.

➡ [How to Restore the Machine's Network Settings to Factory Default](#)

After initializing the LAN settings, perform setup with the Setup CD-ROM or perform it according to the instructions on our website.

Checking Information about the Network

- ➔ [Checking the IP Address or the MAC Address of the Machine](#)
- ➔ [Checking the IP Address or the MAC Address of the Computer](#)
- ➔ [Checking If the Computer and the Machine, or Computer and the Access Point Can Communicate](#)
- ➔ [Checking the Network Setting Information](#)

Checking the IP Address or the MAC Address of the Machine

To check the IP address or the MAC address of the machine, display the network setting information using the operation panel of the machine or print out the network setting information of the machine.

- ➔ LAN settings
- ➔ Printing Out Network Setting Information

To display the network setting information using IJ Network Tool, select **Network Information** on the **View** menu.

- ➔ Canon IJ Network Tool Screen

Checking the IP Address or the MAC Address of the Computer

To check the IP address or MAC address assigned to the computer, follow the procedure below.

1. Select **Command Prompt** as shown below.
 - In Windows 8, select **Command Prompt** from the **Start** screen. If **Command Prompt** is not displayed on the **Start** screen, select the **Search** charm, then search for "**Command Prompt**".
 - In Windows 7, Windows Vista, or Windows XP, click **Start > All Programs > Accessories > Command Prompt**.

2. Enter "ipconfig/all" and press the **Enter** key.

The IP addresses and the MAC addresses of the network devices installed on your computer are displayed. When the network device is not connected to the network, the IP address is not displayed.

Checking If the Computer and the Machine, or Computer and the Access Point Can Communicate

To check that communication is available, perform the ping test.

1. Select **Command Prompt** as shown below.
 - In Windows 8, select **Command Prompt** from the **Start** screen. If **Command Prompt** is not displayed on the **Start** screen, select the **Search** charm, then search for "**Command Prompt**".
 - In Windows 7, Windows Vista, or Windows XP, click **Start > All Programs > Accessories > Command Prompt**.
2. Type the ping command and the IP address of the target printer or the target access point, and then press the **Enter** key.

ping XXX.XXX.XXX.XXX

"XXX.XXX.XXX.XXX" is the IP address of the target device.

If the communication is available, a message such as the following is displayed.

Reply from XXX.XXX.XXX.XXX: bytes=32 time=10ms TTL=255

When **Request timed out** is displayed, the communication is not available.

Checking the Network Setting Information

To check the IP address or the MAC address of the machine, display the network setting information using the operation panel of the machine or print out the network setting information of the machine.

➡ LAN settings

➡ Printing Out Network Setting Information

Packets Are Sent Steadily

While IJ Network Scanner Selector EX is enabled, it periodically transmits packets to check whether it can communicate with the machine over the network. When using the computer in a network environment other than the one used to set up the machine, disable IJ Network Scanner Selector EX.

To disable IJ Network Scanner Selector EX, right-click the  icon on the notification area on the desktop, then select **Disable Canon IJ Network Scanner Selector EX**.

How to Restore the Machine's Network Settings to Factory Default

Important

- Note that initialization erases all network settings on the machine, and printing or scanning operation from a computer over network may become impossible. To use the machine over network, perform setup with the Setup CD-ROM or perform it according to the instructions on our website.

Initialize the network setting using the operation panel of the machine.

➡ Reset setting

Problems with Printing

- ➔ [Printing Does Not Start](#)
- ➔ [Paper Jams](#)
- ➔ [Paper Does Not Feed Properly/"No Paper" Error Occurs](#)
- ➔ [Cannot Print Properly with Automatic Duplex Printing](#)
- ➔ [Copying/Printing Stops Before It Is Completed](#)

Printing Does Not Start

Check1 Make sure that the power plug is securely plugged in, then press the **ON** button to turn the machine on.

While the **POWER** lamp is flashing, the machine is initializing. Wait until the **POWER** lamp stops flashing and remains lit.

▶▶▶ Note

- When printing large data such as a photo or graphics, it may take longer to start printing. While the **POWER** lamp is flashing, the computer is processing data and sending it to the machine. Wait until printing starts.

Check2 Make sure that the machine is connected to your computer properly.

When the machine is connected to your computer with a USB cable, make sure that the USB cable is securely plugged in to the machine and the computer, then check the followings:

- If you are using a relay device such as a USB hub, disconnect it, connect the machine directly to the computer, and try printing again. If printing starts normally, there is a problem with the relay device. Consult the reseller of the relay device for details.
- There could also be a problem with the USB cable. Replace the USB cable and try printing again.

When you use the machine over LAN, make sure that the machine is set up to be used over network correctly.

Check3 Make sure that the front tray is open.

Check4 If you are printing from the computer and there are any unnecessary print jobs, delete them.

➔Deleting the Undesired Print Job

Check5 Make sure that your machine's name is selected in the Print dialog box.

The machine will not print properly if you are using a printer driver for a different printer.

Make sure that your machine's name is selected in the Print dialog box.

▶▶▶ Note

- To make the machine the one selected by default, select **Set as Default Printer**.

Check6 Configure the printer port appropriately.

Make sure that the printer port is configured appropriately.

1. Log on as a user account with administrator privilege.
2. Select items as shown below.
 - In Windows 8, select **Control Panel** from the **Settings** charm on **Desktop > Hardware and Sound > Devices and Printers**.
 - In Windows 7, select **Devices and Printers** from the **Start** menu.
 - In Windows Vista, select the **Start** menu > **Control Panel > Hardware and Sound > Printers**.
 - In Windows XP, select the **Start** menu > **Control Panel > Printers and Other Hardware > Printers and Faxes**.

3. Open the properties of the printer driver for the machine.

- In Windows 8 or Windows 7, right-click the "Canon XXX Printer" icon (where "XXX" is your machine's name), then select **Printer properties**.
- In Windows Vista or Windows XP, right-click the "Canon XXX Printer" icon (where "XXX" is your machine's name), then select **Properties**.

4. Click the **Ports** tab to confirm the port settings.

Make sure that a port named "USBnnn" (where "n" is a number) with "Canon XXX Printer" appearing in the **Printer** column is selected for **Print to the following port(s)**.

»» Note

- When the machine is used over LAN, the port name of the machine is displayed as "CNBJNP_XXXXXXXX". "XXXXXXXX" is the character string generated from the MAC address or a character string specified by the user when setting up the machine.

- If the setting is incorrect:

Reinstall the MP Drivers with the Setup CD-ROM or install them from our website.

- Printing does not start even though the machine is connected to the computer using a USB cable and the port named "USBnnn" is selected:

In Windows 8, select **My Printer** on the **Start** screen to start My Printer. If **My Printer** is not displayed on the **Start** screen, select the **Search** charm, then search for "My Printer".

Set the correct printer port on **Diagnose and Repair Printer**. Follow the on-screen instructions to set the correct printer port, then select your machine's name.

In Windows 7, Windows Vista, or Windows XP, click **Start** and select **All programs, Canon Utilities, Canon My Printer, Canon My Printer**, then select **Diagnose and Repair Printer**. Follow the on-screen instructions to set the correct printer port, then select your machine's name.

If the problem is not resolved, reinstall the MP Drivers with the Setup CD-ROM or install them from our website.

- Printing does not start even though the port named "CNBJNP_XXXXXXXX" is selected when the machine is used over LAN:

Launch IJ Network Tool, and select "CNBJNP_XXXXXXXX" as you confirmed in step 4, then associate the port with the printer using **Associate Port** in the **Settings** menu.

If the problem is not resolved, reinstall the MP Drivers with the Setup CD-ROM or install them from our website.

Check7 Is the size of the print data extremely large?

Click **Print Options** on the **Page Setup** sheet on the printer driver. Then, set **Prevention of Print Data Loss** in the displayed dialog to **On**.

* When **On** is selected for **Prevention of Print Data Loss**, print quality may be reduced.

Check8 Restart your computer if you are printing from the computer.

Paper Jams

When paper is jammed, a troubleshooting message is displayed automatically. Take the appropriate action described in the message.

- **When a Support Code and a message are displayed on the computer screen:**

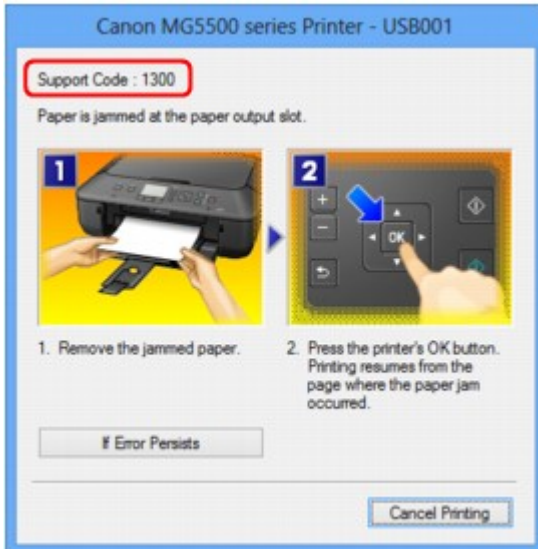

- **When a Support Code and a message are displayed on the LCD:**

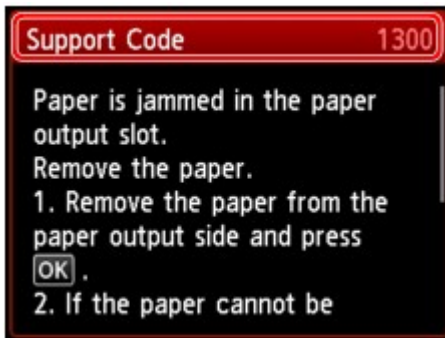

For details on how to remove the jammed paper, refer to [Support Code List \(When Paper Is Jammed\)](#).

▶▶▶ Note

- You can confirm the actions against errors with Support Codes on your computer or on the LCD by searching a Support Code.

➡ Click Here to Search

Paper Does Not Feed Properly/"No Paper" Error Occurs

Check1 Make sure that paper is loaded.

➔ Loading Paper

Check2 Make sure of the following when you load paper.

- When loading two or more sheets of paper, flip through the paper before loading.



- When loading two or more sheets of paper, align the edges of the sheets before loading.
- When loading two or more sheets of paper, make sure that the paper stack does not exceed the paper load limit.

However, proper feeding of paper may not be possible at this maximum capacity depending on the type of paper or environmental conditions (either very high or low temperature and humidity). In such cases, reduce the sheets of paper you load at a time to less than half of the paper load limit.

- Always load the paper in portrait orientation, regardless of the printing orientation.
- When you load the paper, load the paper with the print side facing DOWN and slide the paper guides to align with the both sides of the paper.

➔ Loading Paper

- When you load the paper, insert the paper stack until the leading edge touches the far end of the front tray.

Check3 Check to see if the paper you are printing on is not too thick or curled.

➔ Media Types You Cannot Use

Check4 Make sure of the following when you load Hagakis or envelopes.

- If a Hagaki is curled, it may not feed properly even though the paper stack does not exceed the paper load limit.

Load Hagakis with a zip code column toward the far end of the feeder.

- When printing on envelopes, refer to Loading Paper, and prepare the envelopes before printing.

Once you have prepared the envelopes, load them in portrait orientation. If the envelopes are placed in landscape orientation, they will not feed properly.

Check5 Is the feeder set properly?

Push the feeder so that the ▷ mark on the front tray aligns with the ◁ mark on the machine.

Check6 Confirm that the media type and the paper size settings correspond with the loaded paper.

Check7 If multiple sheets of plain paper is fed from the machine, select the setting for preventing double-feed of plain paper.

If multiple sheets of plain paper is fed from the machine, select the setting for preventing double-feed of plain paper using the operation panel or your computer.

* After printing is finished, disable the setting for preventing double-feed of plain paper; otherwise, the setting is applied from the next time.

- **To set by using the operation panel**

Press the **HOME** button, select **Setup, Device settings**, and **Print settings** in this order, and then set **Prevent paper double-feed** to **ON**.

➡ Changing the Machine Settings on the LCD

- **To set by using your computer**

Open the printer driver setup window, and in **Custom Settings** in the **Maintenance** sheet, select the **Prevent paper double-feed** check box, and then click **OK**.

To open the printer driver setup window, see How to Open the Printer Driver Setup Window.

▶▶▶ **Note**

- Printing speed will be reduced if Prevent paper double-feed function is enabled.

Check8 Clean the paper feed roller.

➡ Cleaning the Paper Feed Roller

▶▶▶ **Note**

- Cleaning the paper feed roller will wear the roller, so perform this procedure only when necessary.

If you cannot remove the paper or the paper tears inside the machine, or if the paper jam error continues after removing the paper, contact the service center.

Cannot Print Properly with Automatic Duplex Printing

Check1 Is the setting for automatic duplex printing selected?

Make sure that the **Duplex Printing** and **Automatic** check boxes are selected on the **Page Setup** sheet in the printer driver setup window.

➔ Duplex Printing

Check2 Make sure that the actual size of the paper is suitable for automatic duplex printing.

The sizes of media suitable for automatic duplex printing are A4 and Letter.

Load paper of suitable size, then press the **OK** button on the machine.

Check3 Make sure that the paper size setting is correct.

Make sure that the paper size setting matches the actual size of the paper with a size suitable for automatic duplex printing.

First, check the paper size setting in the application software you are printing from.

Then, check the **Page Size** setting on the **Page Setup** sheet in the printer driver setup window.

➔➔➔ Note

- Duplex printing may not be available depending on the version of the application software.

Check4 Make sure that the media type setting is correct.

Make sure that the media type setting matches the actual size of the paper with a size suitable for automatic duplex printing.

Make sure that the type of loaded paper is suitable for automatic duplex printing on the **Main** sheet in the printer driver setup window.

➔➔➔ Note

- To switch to manual duplex printing, follow the procedure below.

Open the printer driver setup window, clear the **Automatic** check box on the **Page Setup** sheet, and reprint.

When performing manual duplex printing, note the following.

- If you are printing three or more pages of a document with manual duplex printing, one side of all sheets of paper will be printed first. Turn over the paper and reload the paper in the machine, and then the reverse side of all sheets of paper will be printed. Be careful not to change the order of paper in the stack.
- The procedure for reversing the paper varies depending on the staple side and printing orientation. Follow the on-screen instructions.

Copying/Printing Stops Before It Is Completed

Check1 Is the paper loaded?

Make sure that paper is loaded.

If the machine has run out of paper, load paper.

Check2 Do the printing documents have lots of photographs or illustrations?

As printing large data such as photos or graphics takes time for the machine and the computer to process, the machine may appear to have stopped operating.

In addition, when printing data that uses a large amount of ink continuously on plain paper, the machine may pause temporarily. In either case, wait until the process is complete.

Note

- If you are printing a document with a large printing area or printing multiple copies of a document, printing may pause to allow the ink to dry.

Check3 Has the machine been printing continuously for a long period?

If the machine has been printing continuously for a long time, the print head or other parts around it may overheat. The machine may stop printing at a line break for a period of time and then resume printing.

In this case, wait for a while without operation. If the printing still does not resume, interrupt your print session at a convenient time and turn the machine off for at least 15 minutes.

Caution

- The print head and the surrounding area can become extremely hot inside the machine. Never touch the print head or nearby components.

Problems with Printing Quality

- ➔ [Print Results Not Satisfactory](#)
- ➔ [Ink Is Not Ejected](#)

Print Results Not Satisfactory

If the print result is not satisfactory due to white streaks, misaligned lines, or uneven colors, confirm the paper and print quality settings first.

Check1 Do the page size and media type settings match the size and type of the loaded paper?

When these settings are incorrect, you cannot obtain a proper print result.

If you are printing a photograph or an illustration, incorrect paper type settings may reduce the quality of the printout color.

Also, if you print with an incorrect paper type setting, the printed surface may be scratched.

In borderless printing, uneven coloring may occur depending on the combination of the paper type setting and the loaded paper.

The method of confirming the paper and print quality settings differs depending on what you do with your machine.

To copy by operating the machine	Confirm by using the operation panel on the machine. ➡ Setting Items
To copy photo by operating the machine	Confirm by using the operation panel on the machine. ➡ Copying Photos
To print photo on an online photo album by operating the machine	Confirm by using the operation panel on the machine. ➡ Printing Photos in Online Photo Album
To print from a computer	Confirm by using the printer driver. ➡ Printing with Easy Setup

Check2 Make sure that the appropriate print quality is selected referring to the table in Check 1.

Select a print quality option suitable for the paper and image for printing. If you notice blurs or uneven colors, increase the print quality setting and try printing again.

Check3 If the problem is not resolved, there may be other causes.

See also the sections below:

- ➡ [Cannot Print to End of Job](#)
- ➡ [Part of the Page Is Not Printed](#)
- ➡ [No Printing Results/Printing Is Blurred/Colors Are Wrong/White Streaks](#)
- ➡ [Lines Are Misaligned](#)
- ➡ [Line Does Not Print or Prints Partially](#)
- ➡ [Image Does Not Print or Prints Partially](#)
- ➡ [Printed Paper Curls or Has Ink Blots](#)
- ➡ [Paper Is Smudged/Printed Surface Is Scratched](#)
- ➡ [Back of the Paper Is Smudged](#)

➡ [Vertical Lines Are Printed on the Sides of the Printout](#)

➡ [Colors Are Uneven or Streaked](#)

Cannot Print to End of Job

Check1 Select the setting not to compress the printing data.

If you select the setting not to compress the printing data with an application software you are using, the printing result may be improved.

Click **Print Options** on the **Page Setup** sheet on the printer driver. Select the **Do not allow application software to compress print data** check box, then click **OK**.

* Deselect the check box after printing is complete.

Check2 Is the size of the print data extremely large?

Click **Print Options** on the **Page Setup** sheet on the printer driver. Then, set **Prevention of Print Data Loss** in the displayed dialog to **On**.

* When **On** is selected for **Prevention of Print Data Loss**, print quality may be reduced.

Check3 Is the space of your computer's hard disk sufficient?

Delete unnecessary files to free disk space.

Part of the Page Is Not Printed

Check When performing automatic duplex printing, the reason below is possible.

When performing automatic duplex printing, the printable area at the top of the page will be 0.08 inches / 2 mm narrower than the usual.

For this reason, the bottom of the page may not be printed. To prevent this, select the setting to reduce printing from the printer driver.

Important

- Reduced printing may affect the layout depending on your document.

Apply the print setting specified with the application software if the software has a enlarge/reduce printing function.

1. Open the printer driver setup window.
 - ➡ How to Open the Printer Driver Setup Window
2. Check the **Duplex Printing** check box in the **Page Setup** sheet.
3. Click **Print Area Setup**, then select **Use reduced printing**.

No Printing Results/Printing Is Blurred/Colors Are Wrong/White Streaks

❖ No Printing Results



❖ Printing Is Blurred

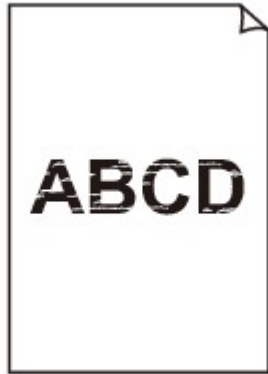

❖ Colors Are Wrong

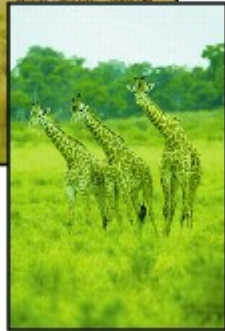

❖ White Streaks

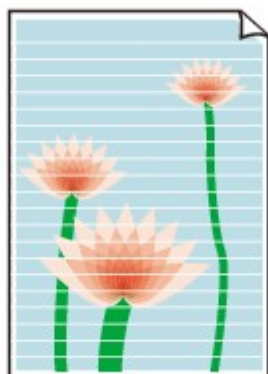

Check1 Did you confirm the paper and print quality settings?

➔ [Print Results Not Satisfactory](#)

Check2 Check the status of ink tanks. Replace the ink tank if the ink has run out.

➔ Replacing an Ink Tank

Check3 Is the orange tape or protective film remaining?

Make sure that all of the protective film is peeled off and the Y-shape air hole is exposed, as illustrated in (A).

If the orange tape is left as in (B), pull the orange tape and remove it.

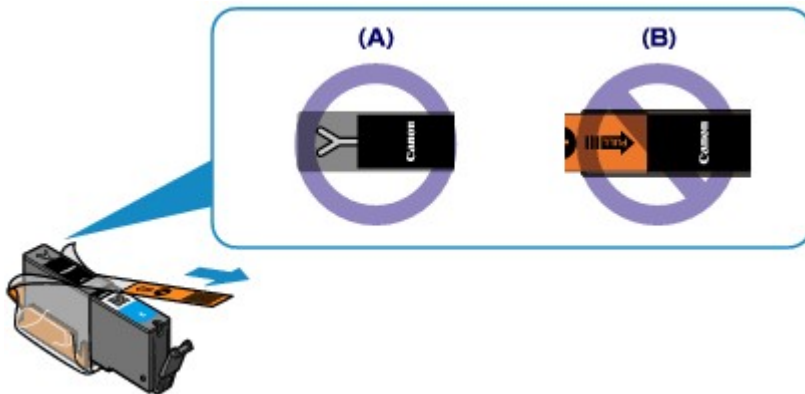

Check4 Print the Nozzle Check Pattern and perform any necessary maintenance operations such as Print Head Cleaning.

Print the Nozzle Check Pattern to determine whether the ink ejects properly from the print head nozzles.

Refer to *When Printing Becomes Faint or Colors Are Incorrect* for the Nozzle Check Pattern printing, Print Head Cleaning, and Print Head Deep Cleaning.

- If the Nozzle Check Pattern is not printed correctly:

Check to see if a particular color's ink tank is not empty.

If the Nozzle Check Pattern is not printed correctly though ink is sufficient, perform the Print Head Cleaning and try printing the Nozzle Check Pattern again.

- If the problem is not resolved after performing the Print Head Cleaning twice:

Perform the Print Head Deep Cleaning.

If the problem is not resolved after performing the Print Head Deep Cleaning, turn off the machine and perform another Print Head Deep Cleaning after 24 hours.

- If the problem is not resolved after performing the Print Head Deep Cleaning twice:

If Print Head Deep Cleaning does not resolve the problem, the print head may be damaged. Contact the service center.

Check5 When using paper with one printable surface, make sure that the paper is loaded with the printable side facing down.

Load paper with the printable side facing down.

Refer to the instruction manual supplied with the paper for detailed information on the printable side.

When copying, see also the sections below:

Check6 Is the platen glass dirty?

Clean the platen glass.

➔ Cleaning the Platen Glass and Document Cover

Check7 Make sure that the original is properly loaded on the platen glass.

➔ Loading Originals

Check8 Is the original loaded with the side to be copied facing down on the platen glass?

Check9 Did you copy a printout done by this machine?

If you use a printout done by this machine as the original, print quality may be reduced depending on the condition of the original.

Print from the machine directly, or reprint from the computer if you can reprint from it.

Lines Are Misaligned

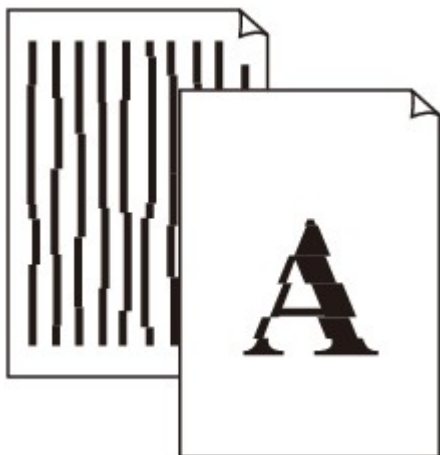

Check1 Did you confirm the paper and print quality settings?

➔ [Print Results Not Satisfactory](#)

Check2 Perform Print Head Alignment.

If printed lines are misaligned or print results are otherwise unsatisfactory, adjust the print head position.

➔ [Aligning the Print Head](#)

➤➤ Note

- If the problem is not resolved after performing the Print Head Alignment, perform Print Head Alignment manually referring to [Aligning the Print Head Position from Your Computer](#).

Check3 Increase the print quality and try printing again.

Increasing the print quality on the operation panel of the machine or in the printer driver may improve the print result.

Line Does Not Print or Prints Partially

Check1 Is the Page Layout Printing performed or the Binding margin function used?

When the Page Layout Printing or Binding margin function is being used, thin lines may not be printed. Try thickening the lines in the document.

Check2 Is the size of the print data extremely large?

Click **Print Options** on the **Page Setup** sheet on the printer driver. Then, set **Prevention of Print Data Loss** in the displayed dialog to **On**.

* When **On** is selected for **Prevention of Print Data Loss**, print quality may be reduced.

Image Does Not Print or Prints Partially

Check1 Select the setting not to compress the printing data.

If you select the setting not to compress the printing data with an application software you are using, the printing result may be improved.

Click **Print Options** on the **Page Setup** sheet on the printer driver. Select the **Do not allow application software to compress print data** check box, then click **OK**.

* Deselect the check box after printing is complete.

Check2 Is the size of the print data extremely large?

Click **Print Options** on the **Page Setup** sheet on the printer driver. Then, set **Prevention of Print Data Loss** in the displayed dialog to **On**.

* When **On** is selected for **Prevention of Print Data Loss**, print quality may be reduced.

Printed Paper Curls or Has Ink Blots

Printed Paper Has Ink Blots



Printed Paper Curls



Check1 Did you confirm the paper and print quality settings?

➔ [Print Results Not Satisfactory](#)

Check2 If the intensity is set high, reduce the intensity setting and try printing again.

If you are using plain paper to print images with high intensity, the paper may absorb too much ink and become wavy, causing paper abrasion.

- When printing from your computer
 - You can confirm the intensity using the printer driver.
 - ➔ [Adjusting Intensity](#)
- When copying
 - ➔ [Setting Items](#)

Check3 Is Photo Paper used for printing photographs?

When printing data with high color saturation such as photographs or images in deep color, we recommend using Photo Paper Plus Glossy II or other Canon speciality paper.

➔ [Media Types You Can Use](#)

Paper Is Smudged/Printed Surface Is Scratched

Paper Is Smudged

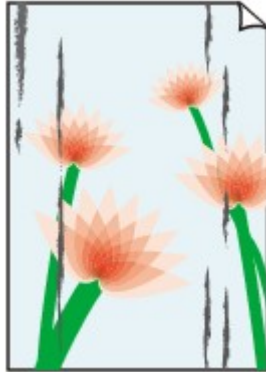
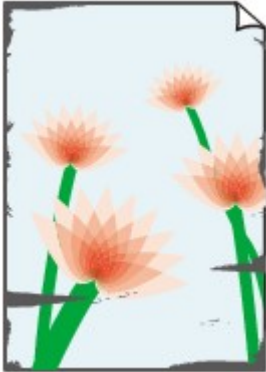

The Edges of Paper Are Smudged Printed Surface Is Smudged



Printed Surface Is Scratched

Check1 Did you confirm the paper and print quality settings?

➔ [Print Results Not Satisfactory](#)

Check2 Is the appropriate type of paper used? Check the followings:

- Check to see if the paper you are printing on is suitable for your printing purpose.
 - ➔ Media Types You Can Use
- When performing Borderless Printing, make sure that the paper you are using is suitable for Borderless Printing.

If the paper you are using is not suitable for Borderless Printing, the print quality may be reduced at the top and bottom edges of the paper.

➔ Printing Area

Check3 Load the paper after correcting its curl.

When using Photo Paper Plus Semi-gloss, even if the sheet is curled, load one sheet at a time as it is. If you roll up this paper to flatten, this may cause cracks on the surface of the paper and reduce the print quality.

We recommend putting unused paper back into the package and keeping it on a level surface.

- **For Plain Paper**

Turn the paper over and reload it to print on the other side.

- **For Other Paper**

If the curl on the four corners of the paper is more than 0.1 inch / 3 mm (A) in height, the paper may be smudged or may not be fed properly. In such cases, follow the procedure described below to correct the paper curl.



1. Roll up the paper in the opposite direction to the paper curl as shown below.

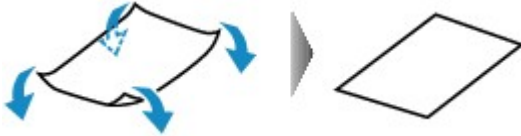

2. Check that the paper is now flat.

We recommend printing curl-corrected paper one sheet at a time.

▶▶▶ Note

- Depending on the media type, the paper may be smudged or may not be fed properly even if it is not curled inward. In such cases, follow the procedure described below to curl the paper outward within 0.1 inch / 3 mm (B) in height before printing. This may improve the print result.

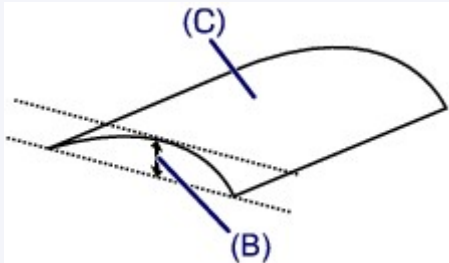

(C) Printing side

We recommend printing paper that has been curled outward one sheet at a time.

Check4 Adjust the setting to prevent paper abrasion.

Adjusting the setting to prevent paper abrasion will widen the clearance between the print head and the loaded paper. If you notice abrasion even with the media type set correctly to match the loaded paper, set the machine to prevent paper abrasion by using the operation panel or the computer.

Print speed may be reduced if you apply the setting to prevent paper abrasion setting.

* Readjust the setting not to prevent paper abrasion once printing is complete. If not, this setting remains enabled for all subsequent print jobs.

• To set by using the operation panel

Press the **HOME** button, select **Setup**, **Device settings**, and **Print settings** in this order, and then set **Prevent paper abrasion** to **ON**.

➡ Changing the Machine Settings on the LCD

• To set by using your computer

Open the printer driver setup window, and in **Custom Settings** in the **Maintenance** sheet, select the **Prevent paper abrasion** check box, and then click **OK**.

To open the printer driver setup window, see How to Open the Printer Driver Setup Window.

Check5 If the intensity is set high, reduce the intensity setting and try printing again.

If you are using plain paper to print images with high intensity, the paper may absorb too much ink and become wavy, causing paper abrasion.

- When printing from your computer

Reduce the intensity setting in the printer driver and try printing again.

1. Open the printer driver setup window.

➡ How to Open the Printer Driver Setup Window

2. On the **Main** sheet, select **Manual** for **Color/Intensity**, and then click **Set....**

3. Drag the **Intensity** slide bar on the **Color Adjustment** sheet to adjust the intensity.

- When copying

➡ Setting Items

Check6 Is printing performed beyond the recommended printing area?

If you are printing beyond the recommended printing area of your printing paper, the lower edge of the paper may become stained with ink.

Resize your original document in your application software.

➡ Printing Area

Check7 Is the platen glass dirty?

Clean the platen glass.

➡ Cleaning the Platen Glass and Document Cover

Check8 Is the paper feed roller dirty?

Clean the paper feed roller.

➡ Cleaning the Paper Feed Roller

▶▶▶ Note

- Cleaning the paper feed roller will wear the roller, so perform this procedure only when necessary.

Check9 Is the inside of the machine dirty?

When performing duplex printing, the inside of the machine may become stained with ink, causing the printout to become smudged.

Perform the Bottom Plate Cleaning to clean the inside of the machine.

➡ Cleaning the Inside of the Machine (Bottom Plate Cleaning)

▶▶▶ Note

- To prevent the inside of the machine from stains, set the paper size correctly.

Check10 Set the time to dry the printed surface longer.

Doing so gives the printed surface enough time to dry so that paper smudged and scratched are prevented.

1. Make sure that the machine is turned on.

2. Open the printer driver setup window.

➡ How to Open the Printer Driver Setup Window

3. Click the **Maintenance** tab and then **Custom Settings**.

4. Drag the **Ink Drying Wait Time** slide bar to set the wait time, and then click **OK**.
5. Confirm the message and click **OK**.

Back of the Paper Is Smudged

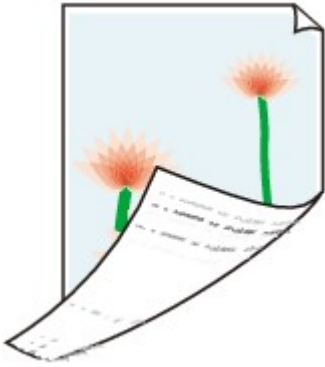

Check1 Did you confirm the paper and print quality settings?

➔ [Print Results Not Satisfactory](#)

Check2 Perform the Bottom Plate Cleaning to clean the inside of the machine.

➔ Cleaning the Inside of the Machine (Bottom Plate Cleaning)

▶▶▶ Note

- When performing borderless printing, duplex printing, or too much printing, the inside may become stained with ink.

Vertical Lines Are Printed on the Sides of the Printout

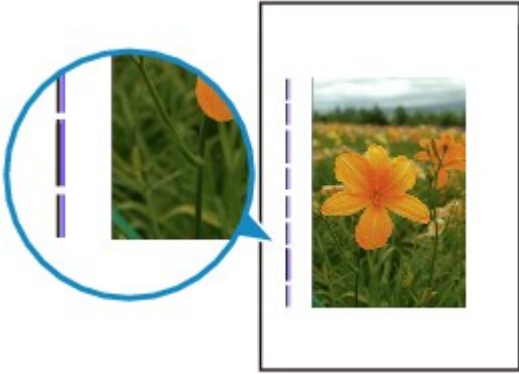

Check Is the size of the loaded paper correct?

The vertical lines may be printed in the margin if the size of the loaded paper is larger than that you have specified.

Set the paper size correctly according to the paper you loaded.

➔ [Print Results Not Satisfactory](#)

➔➔➔ **Note**

- The direction of the vertical line pattern may vary depending on the image data or the print setting.
- This machine performs automatic cleaning when necessary to keep printouts clean. A small amount of ink is ejected for cleaning.

Although ink is usually ejected on the ink absorber, it may be ejected on the paper if you load paper larger than that you have specified.

Colors Are Uneven or Streaked

Colors Are Uneven



Colors Are Streaked



Check1 Did you confirm the paper and print quality settings?

➔ [Print Results Not Satisfactory](#)

Check2 Print the Nozzle Check Pattern and perform any necessary maintenance operations such as Print Head Cleaning.

Print the Nozzle Check Pattern to determine whether the ink ejects properly from the print head nozzles.

Refer to When Printing Becomes Faint or Colors Are Incorrect for the Nozzle Check Pattern printing, Print Head Cleaning, and Print Head Deep Cleaning.

- If the Nozzle Check Pattern is not printed correctly:
Check to see if a particular color's ink tank is not empty.
If the Nozzle Check Pattern is not printed correctly though ink is sufficient, perform the Print Head Cleaning and try printing the Nozzle Check Pattern again.
- If the problem is not resolved after performing the Print Head Cleaning twice:
Perform the Print Head Deep Cleaning.
If the problem is not resolved after performing the Print Head Deep Cleaning, turn off the machine and perform another Print Head Deep Cleaning after 24 hours.
- If the problem is not resolved after performing the Print Head Deep Cleaning twice:

If Print Head Deep Cleaning does not resolve the problem, the print head may be damaged. Contact the service center.

Check3 Perform Print Head Alignment.

➔ Aligning the Print Head

➤➤➤ Note

- If the problem is not resolved after performing the Print Head Alignment, perform Print Head Alignment manually referring to Aligning the Print Head Position from Your Computer.

Ink Is Not Ejected

Check1 Has the ink run out?

Check the Support Code on the LCD and take the appropriate action to resolve the error.

➔ [Support Code List](#)

Check2 Is the orange tape or protective film remaining?

Make sure that all of the protective film is peeled off and the Y-shape air hole is exposed, as illustrated in (A).

If the orange tape is left as in (B), pull the orange tape and remove it.

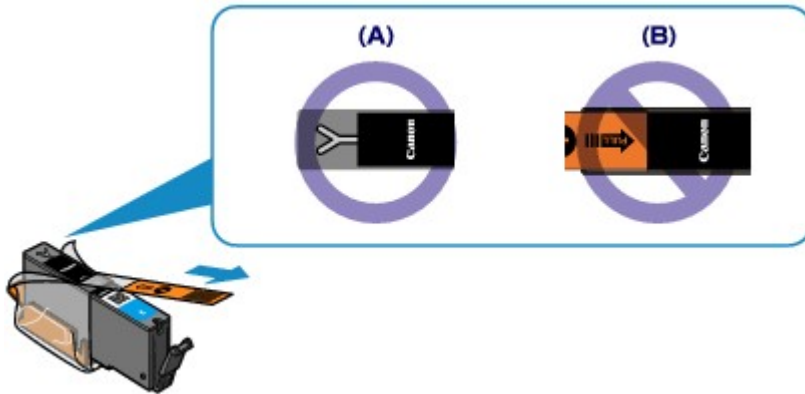

Check3 Are the print head nozzles clogged?

Print the Nozzle Check Pattern to determine whether the ink ejects properly from the print head nozzles.

Refer to When Printing Becomes Faint or Colors Are Incorrect for the Nozzle Check Pattern printing, Print Head Cleaning, and Print Head Deep Cleaning.

- If the Nozzle Check Pattern is not printed correctly:
Check to see if a particular color's ink tank is not empty.
If the Nozzle Check Pattern is not printed correctly though ink is sufficient, perform the Print Head Cleaning and try printing the Nozzle Check Pattern again.
- If the problem is not resolved after performing the Print Head Cleaning twice:
Perform the Print Head Deep Cleaning.
If the problem is not resolved after performing the Print Head Deep Cleaning, turn off the machine and perform another Print Head Deep Cleaning after 24 hours.
- If the problem is not resolved after performing the Print Head Deep Cleaning twice:
If Print Head Deep Cleaning does not resolve the problem, the print head may be damaged. Contact the service center.

Problems with Scanning

- ➔ [Problems with Scanning](#)
- ➔ [Scan Results Not Satisfactory](#)
- ➔ [Software Problems](#)

Problems with Scanning

- Scanner Does Not Work
- ScanGear (Scanner Driver) Does Not Start
- Error Message Appears and the ScanGear (Scanner Driver) Screen Does Not Appear
- Cannot Scan Multiple Items at One Time
- Cannot Scan Properly with Auto Scan
- Slow Scanning Speed
- "There is not enough memory." Message Is Displayed
- Computer Stops Operating during Scanning
- Scanner Does Not Work after Upgrading Windows
- Scanned Image Does Not Open

Scanner Does Not Work

Check 1: Make sure that your scanner or printer is turned on.

Check 2: Connect the USB cable to a different USB port on the computer.

Check 3: If the USB cable is connected to a USB hub, remove it from the USB hub and connect it to a USB port on the computer.

Check 4: Restart the computer.

ScanGear (Scanner Driver) Does Not Start

Check 1: Make sure that MP Drivers is installed.

If not installed, install MP Drivers from the Setup CD-ROM or the web page.

Check 2: Select your scanner or printer on the application's menu.

►► Important

- If your scanner or printer name is displayed multiple times, select the one that does not include WIA.

►► Note

- The operation may differ depending on the application.
- Use the WIA driver when scanning from a WIA-compliant application.
 - ➔ Scanning with WIA Driver

Check 3: Make sure that the application supports TWAIN.

You cannot start ScanGear (scanner driver) from applications not supporting TWAIN.

Check 4: Scan and save images with IJ Scan Utility and open the files in your application.

Error Message Appears and the ScanGear (Scanner Driver) Screen Does Not Appear

Check 1: Make sure that your scanner or printer is turned on.

Check 2: Turn off your scanner or printer, then reconnect the USB cable and replug the power cord.

Check 3: Connect the USB cable to a different USB port on the computer.

Check 4: If the USB cable is connected to a USB hub, remove it from the USB hub and connect it to a USB port on the computer.

Check 5: Make sure that MP Drivers is installed.

If not installed, install MP Drivers from the Setup CD-ROM or the web page.

Check 6: Select your scanner or printer on the application's menu.

►► Note

- The operation may differ depending on the application.

Check 7: Make sure that the application supports TWAIN.

You cannot start ScanGear (scanner driver) from applications not supporting TWAIN.

Check 8: Exit ScanGear if it is running on another application.

Cannot Scan Multiple Items at One Time

Check 1: Make sure that the items are placed correctly.

➔Placing Items (When Scanning from a Computer)

Check 2: Check if you can properly scan one item.

Some applications do not support multiple image scanning. In that case, scan each item individually.

Cannot Scan Properly with Auto Scan

Check 1: Make sure that the items are placed correctly.

➔Placing Items (When Scanning from a Computer)

Check 2: Multiple items scanning may not be supported.

Some applications do not support multiple image scanning. In that case, scan each item individually.

Slow Scanning Speed

Check 1: To view the image on a monitor, set the output resolution to around 150 dpi. To print, set it to around 300 dpi.

➔Resolution

Check 2: Set Fading Correction, Grain Correction, etc. to None.

Refer to "Image Settings" for your model from Home of the *Online Manual* for details.

Check 3: In IJ Scan Utility, deselect the Correct slanted text document / Detect the orientation of text document and rotate image checkbox and scan again.

➔Settings (Document Scan) Dialog Box

➔Settings (Custom Scan) Dialog Box

"There is not enough memory." Message Is Displayed

Check 1: Exit other applications and try again.

Check 2: Reduce the resolution or output size and scan again.

➔ Resolution

Computer Stops Operating during Scanning

Check 1: Restart the computer, reduce the output resolution in ScanGear (scanner driver) and scan again.

Refer to "Output Settings" for your model from Home of the *Online Manual* for details.

Check 2: Delete unnecessary files to obtain sufficient free hard disk space, then scan again.

Error message may appear if there is not enough hard disk space to scan and save, when the image size is too large (such as when scanning a large item at high resolution).

Check 3: In Folder to Save Temporary Files of IJ Scan Utility, specify a folder on a drive with sufficient free space.

➔ Settings (General Settings) Dialog Box

Check 4: Multiple devices may be connected to USB ports.

Disconnect devices other than your scanner or printer.

Scanner Does Not Work after Upgrading Windows

Check: Disconnect the USB cable, then uninstall (delete) and reinstall MP Drivers and IJ Scan Utility.

- **Step 1: Uninstall MP Drivers.**

Refer to "Deleting the Unnecessary MP Drivers" for your model from Home of the *Online Manual* for how to delete MP Drivers.

- **Step 2: Uninstall IJ Scan Utility.**

- **Windows 8:**

1. Click the **Settings** charm > **Control Panel** > **Programs** > **Uninstall a program**.
2. Double-click **Canon IJ Scan Utility**.
3. When a confirmation appears, click **Yes**.
4. When uninstallation is complete, click **OK**.
IJ Scan Utility is deleted.

»» Note

- In Windows 8, a confirmation/warning dialog box may appear when installing, uninstalling, or starting up software.
This dialog box appears when administrative rights are required to perform a task.
If you are logged on to an administrator account, follow the on-screen instructions.

- **Windows 7 / Windows Vista:**

1. From the **Start** menu, select **Control Panel** > **Programs** > **Uninstall a program**.
2. Double-click **Canon IJ Scan Utility**.
3. When a confirmation appears, click **Yes**.
4. When uninstallation is complete, click **OK**.
IJ Scan Utility is deleted.

»» Note

- In Windows 7 and Windows Vista, a confirmation/warning dialog box may appear when installing, uninstalling, or starting up software. This dialog box appears when administrative rights are required to perform a task. If you are logged on to an administrator account, follow the on-screen instructions.

- **Windows XP:**

1. From the **Start** menu, select **Control Panel > Add or Remove Programs**.
2. Select **Canon IJ Scan Utility**, then click **Change/Remove**.
3. When a confirmation appears, click **Yes**.
4. When uninstallation is complete, click **OK**.

IJ Scan Utility is deleted.

- **Step 3: Reinstall MP Drivers and IJ Scan Utility.**

Reinstall MP Drivers and IJ Scan Utility from the Setup CD-ROM or the web page.

Scanned Image Does Not Open

Check: If the data format is not supported by the application, scan the image again and select a popular data format such as JPEG when saving it.

Refer to the application's manual for details. If you have any questions, contact the manufacturer of the application.

Scan Results Not Satisfactory

- Scan Quality (Image Displayed on the Monitor) Is Poor
- Scanned Image Is Surrounded by Extra White Areas
- Cannot Scan at the Correct Size
- Position or Size of the Image Cannot be Detected Correctly When Scanning from the Operation Panel
- Item Is Placed Correctly, but the Scanned Image Is Slanted
- Scanned Image Is Enlarged (Reduced) on the Computer Monitor

Scan Quality (Image Displayed on the Monitor) Is Poor

Check 1: Increase the scanning resolution if the image is jagged.

➔Resolution

Check 2: Set the display size to 100 %.

Some applications do not display images clearly if the display size is too small.

Check 3: If moire (stripe pattern) appears, take the following measures and scan again.

- Set one of the following settings in the **Settings (Document Scan)** dialog box, **Settings (Custom Scan)** dialog box, or **Settings (Scan and Stitch)** dialog box of IJ Scan Utility, then scan from the IJ Scan Utility main screen.
 - Set **Select Source** to **Magazine** and set **Color Mode** to **Color**
 - Select the **Reduce moire** checkbox in **Image Processing Settings**
 - ➔Settings (Document Scan) Dialog Box
 - ➔Settings (Custom Scan) Dialog Box
 - ➔Settings (Scan and Stitch) Dialog Box
- On the **Basic Mode** tab of ScanGear (scanner driver), select **Magazine (Color)** in **Select Source**.
Refer to "Basic Mode Tab" for your model from Home of the *Online Manual* for details.
- On the **Advanced Mode** tab of ScanGear, set **Descreen** in **Image Settings** to **ON**.
Refer to "Image Settings" for your model from Home of the *Online Manual* for details.

»» Note

- If moire appears when you scan a digital print photo, take the above measures and scan again.

Check 4: Check the monitor's color depth.

Refer to Help of Windows or the monitor's manual for details on how to check the monitor's color depth.

Check 5: Clean the platen and document cover.

Check 6: If the document is in poor condition (dirty, faded, etc.), use Reduce Dust and Scratches, Fading Correction, Grain

Correction, etc. in Image Settings on the Advanced Mode tab of ScanGear.

Refer to "Image Settings" for your model from Home of the *Online Manual* for details.

Check 7: If the color tone of images is different from the original document, take the following measures and scan again.

- On the **Advanced Mode** tab of ScanGear, set **Image Adjustment** in **Image Settings** to **None**.

Refer to "Image Settings" for your model from Home of the *Online Manual* for details.

- On the **Color Settings** tab in the **Preferences** dialog box of ScanGear, set **Color Matching**.

Refer to "Color Settings Tab" for your model from Home of the *Online Manual* for details.

Scanned Image Is Surrounded by Extra White Areas

Check: Specify the scan area.



Click  (Auto Crop) in whole image view of ScanGear (scanner driver) to automatically display the cropping frame (scan area) according to the item size.

You can also manually specify the scan area in thumbnail view or when there are white margins along the item (for example, in photos), or when you want to create custom cropping frames.

➔ Adjusting Cropping Frames in the Image Stitch Window

Cannot Scan at the Correct Size

Check: Make sure that the items are placed correctly.

➔Placing Items (When Scanning from a Computer)

Position or Size of the Image Cannot be Detected Correctly When Scanning from the Operation Panel

Check 1: Make sure that the items are placed correctly.

➔ Placing Items (When Scanning from a Computer)

Check 2: Check that the settings match the item to be scanned.

If you cannot scan properly by automatically detecting the item type, specify the item type and size.

- **When Scanning from the Operation Panel**

Refer to "Setting Items on the Operation Panel of the Machine" for your model from Home of the *Online Manual* for details on the setting items when scanning from the operation panel.

- **When Scanning with IJ Scan Utility**

- ➔ Scanning Photos
- ➔ Scanning Documents
- ➔ Scanning with Favorite Settings

Item Is Placed Correctly, but the Scanned Image Is Slanted

Check: When Document or Magazine is selected for the item type, deselect the Correct slanted text document checkbox and scan the item again.

➔ Settings (Document Scan) Dialog Box

➔ Settings (Custom Scan) Dialog Box

Scanned Image Is Enlarged (Reduced) on the Computer Monitor

Check 1: Change the display setting in the application.

Refer to the application's manual for details. If you have any questions, contact the manufacturer of the application.

»» Note

- You cannot reduce the image size in Paint. To reduce the display size, open the images in an application.

Check 2: Change the resolution setting in ScanGear (scanner driver) and scan again.

The higher the resolution, the larger the resulting image will be.

➔ Resolution

Software Problems

- The E-mail Client You Want to Use Does Not Appear in the Screen for Selecting an E-mail Client

The E-mail Client You Want to Use Does Not Appear in the Screen for Selecting an E-mail Client

Check: Check that the e-mail client's MAPI is enabled.

Refer to the e-mail client's manual for how to set MAPI.

If the problem is not solved even when MAPI is enabled, select **None (Attach Manually)** in the screen for selecting an e-mail client, then manually attach the image to the outgoing e-mail.

Problems with the Machine

- ➔ [The Machine Cannot Be Powered On](#)
- ➔ [The Machine Turns Off Unintendedly](#)
- ➔ [Cannot Connect to Computer with a USB Cable Properly](#)
- ➔ [Cannot Communicate with the Machine with USB Connection](#)
- ➔ [LCD Cannot Be Seen At All](#)
- ➔ [An Unintended Language Is Displayed on the LCD](#)
- ➔ [Print Head Holder Does Not Move to the Position for Replacing](#)
- ➔ [Printer Status Monitor Is Not Displayed](#)

The Machine Cannot Be Powered On

Check1 Press the **ON** button.

Check2 Make sure that the power plug is securely plugged into the power cord connector of the machine, then turn it back on.

Check3 Unplug the machine from the power supply, then plug the machine back in and turn the machine back on after leaving it for at least 3 minutes.

If the problem is not resolved, contact the service center.

The Machine Turns Off Unintendedly

Check Deactivate the setting to turn the unit off automatically.

The machine turns off automatically according to the elapsed time you specified if you activate the setting to turn the unit off automatically.

If you do not want the machine to turn off automatically, open the printer driver setup window and in **Auto Power** under the **Maintenance** sheet, select **Disable** for **Auto Power Off**.

▶▶▶ Note

- You can activate the setting to turn the machine on/off automatically from the operation panel of the machine or ScanGear (scanner driver).
 - From the operation panel of the machine:
 - ➡ About ECO settings
 - From ScanGear (scanner driver):
 - ➡ Scanner Tab

Cannot Connect to Computer with a USB Cable Properly

Printing or Scanning Speed Is Slow/Hi-Speed USB Connection Does Not Work/"This device can perform faster" Message Is Displayed

If your system environment is not fully compatible with Hi-Speed USB, the machine will operate at a lower speed provided under USB 1.1. In this case, the machine operates properly but printing or scanning speed may slow down due to communication speed.

Check

Check the following to make sure that your system environment supports Hi-Speed USB connection.

- Does the USB port on your computer support Hi-Speed USB connection?
- Does the USB cable or the USB hub support Hi-Speed USB connection?

Be sure to use a certified Hi-Speed USB cable. We recommend that the cable is no longer than around 10 feet / 3 meters.

- Does the operating system of your computer support Hi-Speed USB connection?

Obtain and install the latest update for your computer.

- Does the Hi-Speed USB driver operate properly?

Obtain the latest version of the Hi-Speed USB driver compatible with your hardware and reinstall it on your computer.

Important

- For details on Hi-Speed USB of your system environment, contact the manufacturer of your computer, USB cable, or USB hub.

Cannot Communicate with the Machine with USB Connection

Check1 Make sure that the machine is turned on.

Check2 Make sure that the USB cable is connected properly.

See Connecting the Machine to the Computer Using a USB Cable to connect the USB cable properly.

Check3 Do not start up IJ Network Tool while printing.

Check4 Do not print while IJ Network Tool is running.

Check5 Make sure that **Enable bidirectional support** is selected in the **Ports** sheet of the properties dialog box of the printer driver.

➡ How to Open the Printer Driver Setup Window

LCD Cannot Be Seen At All

- **If the POWER lamp is off:**

The machine is not powered on. Connect the power cord and press the **ON** button.

- **If the POWER lamp is lit:**

The LCD may be in the screen-saver mode. Press one of the buttons on the operation panel.

An Unintended Language Is Displayed on the LCD

Select the language you want to be displayed according to the following procedure.

1. Press the **HOME** button and wait for about 5 seconds.



2. Select **Setup** on the **HOME** screen.

➔ LCD and Operation Panel



3. Select **Device settings**, then press the **OK** button.

4. Press the ▼ button 3 times, then press the **OK** button.

5. Use the ▲▼ button to select the language for the LCD, then press the **OK** button.

Print Head Holder Does Not Move to the Position for Replacing

Check1 Is the **POWER** lamp off?

Check if the **POWER** lamp is lit.

The print head holder will not move unless the power is on. If the **POWER** lamp is off, close the operation panel and turn the machine on.

While the **POWER** lamp is flashing, the machine is initializing. Wait until the **POWER** lamp stops flashing and remains lit, and then open the operation panel again.

Check2 Is an error message displayed on the LCD?

Close the operation panel, follow the Support Code (error number) displayed in the error message to resolve the error, and then reopen it. For details on how to resolve the error, refer to [Support Code List](#).

Check3 Has the operation panel been left open for 10 minutes or longer?

If the operation panel is left open for more than 10 minutes, the print head holder moves to the position to protect it to prevent the print head from drying out. Close and reopen the operation panel to return the print head holder to the position for replacing.

Check4 Has the machine been printing continuously for a long period?

Close the operation panel, wait a while, then reopen it.

If the machine has been printing continuously for a long time, the print head holder may not move to the position for replacing since the print head may overheat.

▶▶ Note

- Opening the operation panel while printing moves the print head holder to the position to protect it. Close the operation panel, and reopen it after printing finishes.

Printer Status Monitor Is Not Displayed

Check Is the printer status monitor enabled?

Make sure that **Enable Status Monitor** is selected on the **Option** menu of the printer status monitor.

1. Open the printer driver setup window.
 - ➡ How to Open the Printer Driver Setup Window
2. On the **Maintenance** sheet, click **View Printer Status**.
3. Select **Enable Status Monitor** on the **Option** menu if it is not selected.

Problems with Installation/Downloading

- ➔ [Cannot Install the MP Drivers](#)
- ➔ [Easy-WebPrint EX Does Not Start Up or Easy-WebPrint EX Menu Does Not Appear](#)
- ➔ [How to Update MP Drivers in Network Environment](#)
- ➔ [Uninstalling IJ Network Tool](#)

Cannot Install the MP Drivers

- If the installation does not start even after the Setup CD-ROM is inserted into your computer's disc drive:

Start the installation following the procedure below.

1. Select items as shown below.

- In Windows 8, select the **Explorer** icon in **Taskbar on Desktop**, then select **Computer** from the list on the left.
- In Windows 7 or Windows Vista, click **Start** then **Computer**.
- In Windows Vista, click **Start** then **Computer**.
- In Windows XP, click **Start** then **My Computer**.

2. Double-click the  **CD-ROM** icon on the displayed window.

If the contents of the CD-ROM are displayed, double-click **MSETUP4.EXE**.

If you cannot install the MP Drivers with the Setup CD-ROM, install them from our website.

»» Note

- If the CD-ROM icon is not displayed, try the following:
 - Remove the CD-ROM from your computer, then insert it again.
 - Restart your computer.

If the icon is not yet displayed, try different discs and see if they are displayed. If other discs are displayed, there is a problem with the Setup CD-ROM. In this case, contact the service center.

- If you are unable to proceed beyond the Printer Connection screen:

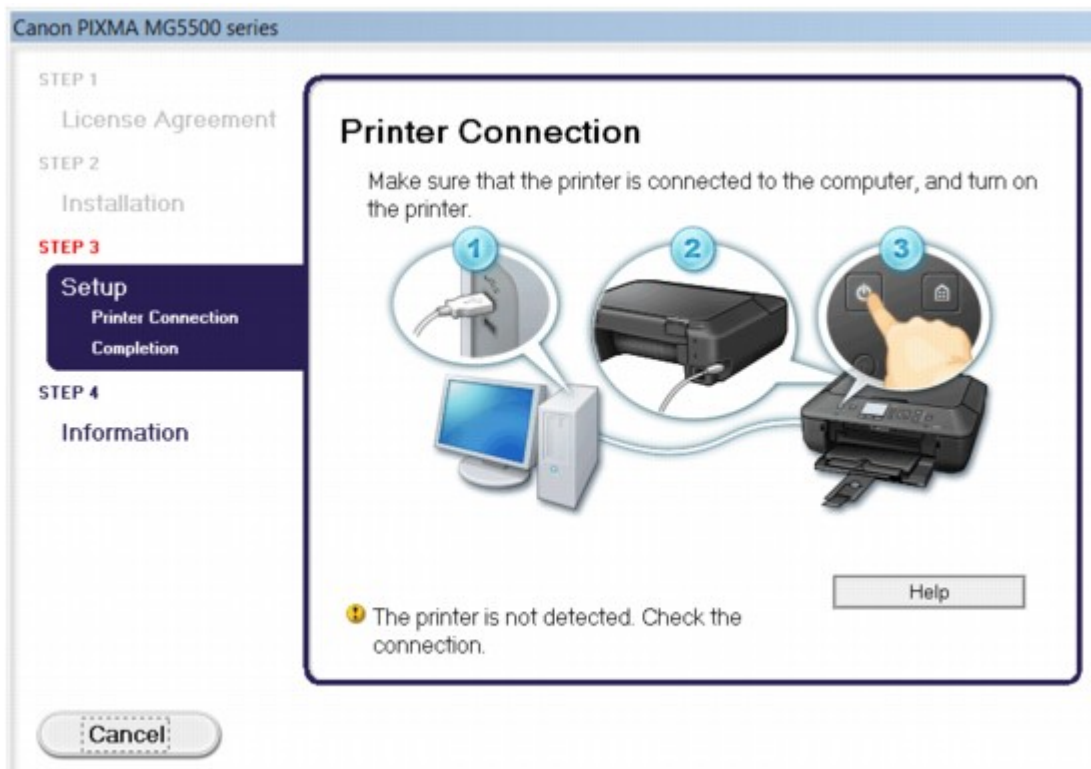

»» Note

- **The printer is not detected. Check the connection.** may be displayed depending on the computer you use.

Check1 Make sure that the USB cable is securely plugged in to the machine and the computer.

Check2 Follow the procedure below to connect the machine and the computer again.

1. Turn the machine off.
2. Unplug the USB cable from the machine and the computer, then connect it again.
3. Turn the machine on.

Check3 If you cannot resolve the problem, follow the procedure below to reinstall the MP Drivers.

1. Click **Cancel**.
2. Click **Start Over** on the **Installation Failure** screen.
3. Click **Exit** on the "PIXMA XXX" screen (where "XXX" is your machine's name), then remove the CD-ROM.
4. Turn the machine off.
5. Restart the computer.
6. Make sure that you have no application software running.
7. Insert the CD-ROM again, then install the MP Drivers.

• In other cases:

Reinstall the MP Drivers.

If the MP Drivers were not installed correctly, uninstall the MP Drivers, restart your computer, and then reinstall the MP Drivers.

➔ Deleting the Unnecessary MP Drivers

If you reinstall the MP Drivers, install the MP Drivers with the Setup CD-ROM or install them from our website.

»» Note

- If the installer was forced to be terminated due to a Windows error, the system may be in an unstable condition and you may not be able to install the drivers. Restart your computer before reinstalling.

Easy-WebPrint EX Does Not Start Up or Easy-WebPrint EX Menu Does Not Appear

If Easy-WebPrint EX does not start up or its menu does not appear on Internet Explorer, confirm the following.

Check1 Is **Canon Easy-WebPrint EX** displayed on the **Toolbars** menu in the Internet Explorer's **View** menu?

If **Canon Easy-WebPrint EX** is not displayed, Easy-WebPrint EX is not installed on your computer. Install the latest Easy-WebPrint EX onto your computer from our website.

Note

- If Easy-WebPrint EX is not installed on your computer, a message asking you to install it may be displayed on the notification area on the desktop. Click the message, then follow the instructions on the computer screen to install Easy-WebPrint EX.
- While the installation or download Easy-WebPrint EX is in progress, it is necessary to access the Internet.

Check2 Is **Canon Easy-WebPrint EX** selected on the **Toolbars** menu in the Internet Explorer's **View** menu?

If **Canon Easy-WebPrint EX** is not selected, Easy-WebPrint EX is disabled. Select **Canon Easy-WebPrint EX** to enable it.

How to Update MP Drivers in Network Environment

Download the latest MP Drivers in advance.

To obtain the latest MP Drivers, access our web site through the Internet and download the latest MP Drivers for your model.

After uninstalling the MP Drivers, install the latest MP Drivers according to the regular procedure. When the connection method selection screen is displayed, select **Use the printer with wireless LAN connection**. The machine will be detected automatically in the network.

After making sure that the machine is detected, install the MP Drivers following the on-screen instructions.

Note

- You can use the machine over a LAN without performing setup again.

Uninstalling IJ Network Tool

Follow the procedure below to uninstall IJ Network Tool from your computer.

»» Important

- Even if IJ Network Tool is uninstalled, you can print and scan from the computer over network. However, you cannot change the network settings over network.
- Log into a user account with administrator privilege.

1. Perform the procedure to uninstall IJ Network Tool.

- In Windows 8:
 1. Select **Control Panel** from the **Settings** charm on **Desktop > Programs > Programs and Features**.
 2. Select **Canon IJ Network Tool** from the program list, then click **Uninstall**.
If the **User Account Control** screen appears, click **Continue**.
- In Windows 7 or Windows Vista:
 1. Click **Start > Control Panel > Programs > Programs and Features**.
 2. Select **Canon IJ Network Tool** from the program list, then click **Uninstall**.
If the **User Account Control** screen appears, click **Continue**.
- In Windows XP:
 1. Click **Start > Control Panel > Add or Remove Programs**.
 2. Select **Canon IJ Network Tool** from the program list, then click **Remove**.

2. Click **Yes** when the confirmation message appears.

When the message prompting you to restart your computer is displayed, click **OK** to restart your computer.

About Errors/Messages Displayed

- ➔ [If an Error Occurs](#)
- ➔ [A Message Is Displayed](#)

If an Error Occurs

When an error occurs in printing such as the machine is out of paper or paper is jammed, a troubleshooting message is displayed automatically. Take the appropriate action described in the message.

When an error occurs, a Support Code (error number) is displayed on the computer screen or the LCD.

- **When a Support Code and a message are displayed on the computer screen:**

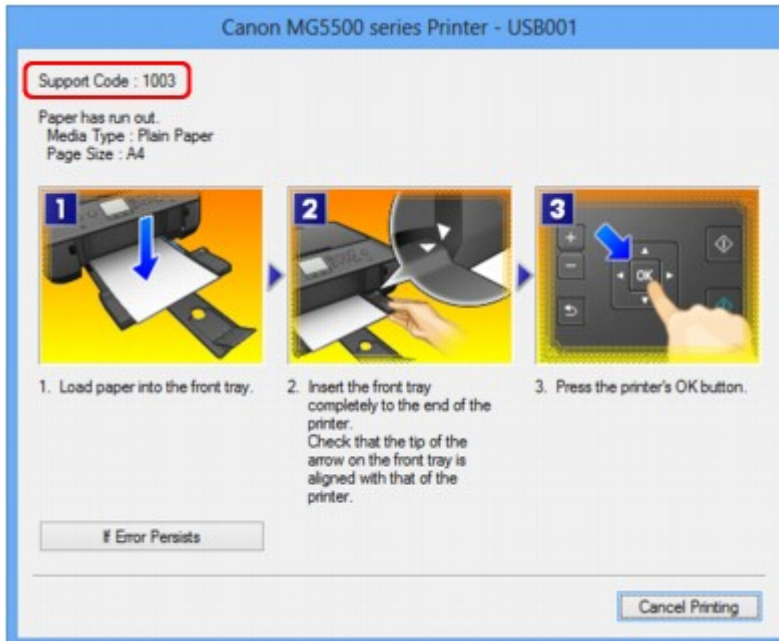

- **When a Support Code and a message are displayed on the LCD:**



For details on how to resolve errors with Support Codes, refer to [Support Code List](#).

▶▶▶ Note

- You can confirm the actions against errors with Support Codes on your computer or on the LCD by searching a Support Code.

➡ [Click Here to Search](#)

For details on how to resolve errors without Support Codes, see [A Message Is Displayed](#).

A Message Is Displayed

This section describes some of the errors or messages.

►► Note

- A Support Code (error number) is displayed on the computer or on the LCD for some error or message. For details on errors with Support Codes, refer to [Support Code List](#).

If a message is displayed on the LCD, see below.

- [A Message Is Displayed on the LCD](#)

If a message is displayed on the computer, see below.

- [Error Regarding Automatic Duplex Printing Is Displayed](#)
- [Error Regarding the Power Cord Being Unplugged Is Displayed](#)
- [Writing Error/Output Error/Communication Error](#)
- [Other Error Messages](#)
- [The Inkjet Printer/Scanner/Fax Extended Survey Program Screen Is Displayed](#)

A Message Is Displayed on the LCD

Confirm the message and take an appropriate action.

- **Power was not turned off correctly the last time. Press the  button when turning power off.**

The power cord may have been unplugged last while the machine was still on.

Press the **OK** button to dismiss the error.

►► Note

- See Notice for Unplugging the Power Cord for unplugging the power cord.

- **Cannot connect to the server. Please wait a while and try again.**

You cannot connect to the server due to some communication error. When you have tried to access a photo sharing site, it is possible that your photos have been deleted.

Press the **OK** button to dismiss the error, then try again after a while.

Error Regarding Automatic Duplex Printing Is Displayed

Check See [Cannot Print Properly with Automatic Duplex Printing](#) and take the appropriate action.

Error Regarding the Power Cord Being Unplugged Is Displayed

The power cord may have been unplugged while the machine was still on.

Check the error message that appears on the computer, then click **OK**.

The machine starts printing.

See Notice for Unplugging the Power Cord for unplugging the power cord.

Writing Error/Output Error/Communication Error

Check1 If the **POWER** lamp is off, make sure that the power plug is plugged in, then turn the machine on.

While the **POWER** lamp is flashing, the machine is initializing. Wait until the **POWER** lamp stops flashing and remains lit.

Check2 Make sure that the printer port is configured appropriately in the printer driver.

* In the following instructions, "XXX" signifies your machine's name.

1. Log on as a user account with administrator privilege.
2. Select items as shown below.
 - In Windows 8, select **Control Panel** from the **Settings** charm on **Desktop > Hardware and Sound > Devices and Printers**.
 - In Windows 7, select **Devices and Printers** from the **Start** menu.
 - In Windows Vista, select the **Start** menu > **Control Panel > Hardware and Sound > Printers**.
 - In Windows XP, select the **Start** menu > **Control Panel > Printers and Other Hardware > Printers and Faxes**.
3. Open the properties of printer driver for the machine.
 - In Windows 8 or Windows 7, right-click the "Canon XXX Printer" icon (where "XXX" is your machine's name), then select **Printer properties**.
 - In Windows Vista or Windows XP, right-click the "Canon XXX Printer" icon (where "XXX" is your machine's name), then select **Properties**.
4. Click the **Ports** tab to confirm the port settings.

Make sure that a port named "USBnnn" (where "n" is a number) with "Canon XXX Printer" appearing in the **Printer** column is selected for **Print to the following port(s)**.

➤➤ Note

- When the machine is used over LAN, the port name of the machine is displayed as "CNBJNP_XXXXXXXX". "XXXXXXXX" is the character string generated from the MAC address or a character string specified by the user when setting up the machine.

- If the setting is incorrect:
Reinstall the MP Drivers with the Setup CD-ROM or install them from our website.
- Printing does not start even though the machine is connected to the computer using a USB cable and the port named "USBnnn" is selected:

In Windows 8, select **My Printer** on the **Start** screen to start My Printer. If **My Printer** is not displayed on the **Start** screen, select the **Search** charm, then search for "My Printer".

Set the correct printer port on **Diagnose and Repair Printer**. Follow the on-screen instructions to set the correct printer port, then select your machine's name.

In Windows 7, Windows Vista, or Windows XP, click **Start** and select **All programs, Canon Utilities, Canon My Printer, Canon My Printer**, then select **Diagnose and Repair Printer**. Follow the on-screen instructions to set the correct printer port, then select your machine's name.

If the problem is not resolved, reinstall the MP Drivers with the Setup CD-ROM or install them from our website.

- Printing does not start even though the port named "CNBJNP_xxxxxxxx" is selected when the machine is used over LAN:

Launch IJ Network Tool, and select "CNBJNP_xxxxxxxx" as you confirmed in step 4, then associate the port with the printer using **Associate Port** in the **Settings** menu.

If the problem is not resolved, reinstall the MP Drivers with the Setup CD-ROM or install them from our website.

Check3 Make sure that the machine is connected to your computer properly.

When the machine is connected to your computer with a USB cable, make sure that the USB cable is securely plugged in to the machine and the computer, then check the followings:

- If you are using a relay device such as a USB hub, disconnect it, connect the machine directly to the computer, and try printing again. If printing starts normally, there is a problem with the relay device. Consult the reseller of the relay device for details.
- There could also be a problem with the USB cable. Replace the USB cable and try printing again.

When you use the machine over LAN, make sure that the machine is set up to be used over network correctly.

Check4 Make sure that the MP Drivers are installed correctly.

Uninstall the MP Drivers following the procedure described in [Deleting the Unnecessary MP Drivers](#), then reinstall the MP Drivers with the Setup CD-ROM or reinstall them from our website.

Check5 When the machine is connected to your computer with a USB cable, check the status of the device on your computer.

Follow the procedure below to check the status of the device.

1. Open the Device Manager on your computer as shown below.

If the **User Account Control** screen is displayed, follow the on-screen instructions.

- In Windows 8, select **Control Panel** from the **Settings** charm on **Desktop > Hardware and Sound > Device Manager**.
- In Windows 7 or Windows Vista, click **Control Panel, Hardware and Sound**, then **Device Manager**.
- In Windows XP, click **Control Panel, Performance and Maintenance, System**, then click **Device Manager** on the **Hardware** sheet.

2. Double-click **Universal Serial Bus controllers** then **USB Printing Support**.

If the **USB Printing Support Properties** screen is not displayed, make sure that the machine is correctly connected to the computer.

➔ **Check3** [Make sure that the machine is connected to your computer properly.](#)

3. Click the **General** tab and make sure that there is no indication of a problem with the device.

If a device error is displayed, refer to Windows help to resolve the error.

Other Error Messages

Check If an error message is displayed outside the printer status monitor, check the following:

- **"Could not spool successfully due to insufficient disk space"**

Delete any unnecessary files to increase the amount of free space on the disk.

- **"Could not spool successfully due to insufficient memory"**

Quit other running application softwares to increase available memory.

If you cannot print yet, restart your computer and retry printing.

- **"Printer driver could not be found"**

Uninstall the MP Drivers following the procedure described in Deleting the Unnecessary MP Drivers, then reinstall the MP Drivers with the Setup CD-ROM or reinstall them from our website.

- **"Could not print Application name - File name"**

Try printing again once the current job is complete.

The Inkjet Printer/Scanner/Fax Extended Survey Program Screen Is Displayed

If the Inkjet Printer/Scanner/Fax Extended Survey Program is installed, a confirmation screen asking for permission to send the printer and application software usage information will be displayed every month for about ten years.

Read the instructions on the screen and follow the procedure below.

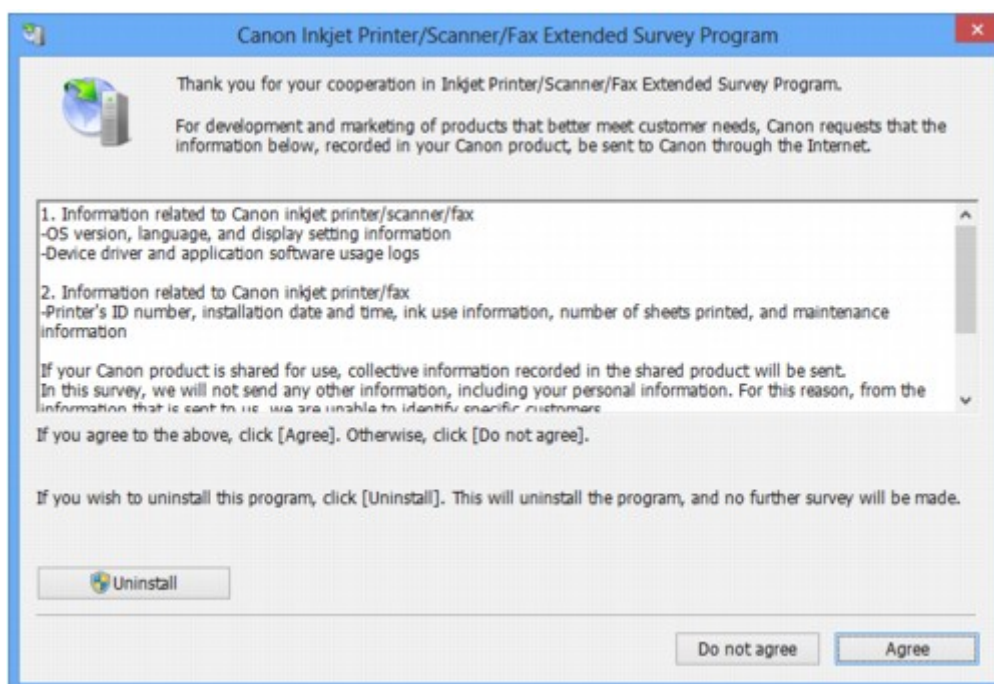

- **If you agree to participate in the survey program:**

Click **Agree**, then follow the on-screen instructions. The printer usage information will be sent via the Internet. If you have followed the on-screen instructions, the information will be sent automatically from the second time onward and the confirmation screen will not be displayed again.

►►► Note

- When the information is being sent, a caution screen such as an Internet security screen may be displayed. In this case, confirm that the program name is "IJPLMUI.exe", then allow it.
- If you deselect the **Send automatically from the next time** check box, the information will not be sent automatically from the second time onward and a confirmation screen will be displayed at the time of the next survey. To send the information automatically, see [Changing the confirmation screen setting](#).

- **If you do not agree to participate in the survey program:**

Click **Do not agree**. The confirmation screen will be closed, and the survey at that time is skipped. The confirmation screen will be displayed again one month later.

- **To uninstall the Inkjet Printer/Scanner/Fax Extended Survey Program:**

To uninstall the Inkjet Printer/Scanner/Fax Extended Survey Program, click **Uninstall**, then follow the on-screen instructions.

- **Changing the confirmation screen setting:**

1. Select items as shown below.

- In Windows 8, select **Control Panel** from the **Settings** charm on **Desktop > Programs > Programs and Features**.
- In Windows 7, or Windows Vista, select the **Start** menu > **Control Panel > Programs > Programs and Features**.
- In Windows XP, select the **Start** menu > **Control Panel > Add or Remove Programs**.

»»» Note

- In Windows 8, Windows 7 or Windows Vista, a confirmation/warning dialog box may appear when installing, uninstalling or starting up software.

This dialog box appears when administrative rights are required to perform a task.

If you are logged on to an administrator account, follow the on-screen instructions.

2. Select **Canon Inkjet Printer/Scanner/Fax Extended Survey Program**.

3. Select **Change**.

If you select **Yes** after you have followed the on-screen instructions, the confirmation screen will be displayed at the time of the next survey.

If you select **No**, the information will be sent automatically.

»»» Note

- If you select **Uninstall** (or **Remove** in Windows XP), the Inkjet Printer/Scanner/Fax Extended Survey Program is uninstalled. Follow the on-screen instructions.

If You Cannot Resolve the Problem

If you cannot resolve the problem with any of the workarounds in this chapter, please contact the seller of the machine or the service center.

Canon support staff are trained to be able to provide technical support to satisfy customers.

Caution

- If the machine emits any unusual sound, smoke, or odor, turn it off immediately. Unplug the power cord from the outlet and contact the seller or the service center. Never attempt to repair or disassemble the machine yourself.
- Attempts by customers to repair or take apart the machine will invalidate any warranty regardless of whether the warranty has expired.

Before contacting the service center, confirm the following:

- Product name:
 - * Your machine's name is located on the front cover of the setup manual.
- Serial number: please refer to the setup manual
- Details of the problem
- What you tried to solve the problem, and what happened

Support Code List

(MG5510, MG5520, MG5540, MG5550, MG5560, MG5570, MG5580)

The support code appears on the LCD and the computer screen when an error occurs.

"Support Code" means the error number and appears with an error message.

When an error occurs, check the support code displayed on the LCD or the computer screen and take the appropriate action.

Support Code Appears on the LCD and the Computer Screen

- **1000 to 1ZZZ**

[1003](#) [1200](#) [1250](#) [1300](#) [1303](#) [1304](#)

[1310](#) [1401](#) [1403](#) [1405](#) [1410](#) [1411](#)

[1412](#) [1413](#) [1414](#) [1600](#) [1660](#) [1680](#)

[1681](#) [1684](#) [1688](#) [1689](#) [1700](#) [1701](#)

[1712](#) [1713](#) [1714](#) [1715](#) [1890](#)

- **2000 to 2ZZZ**

[2100](#) [2101](#) [2102](#) [2103](#) [2700](#) [2900](#)

- **4000 to 4ZZZ**

[4100](#) [4103](#)

- **5000 to 5ZZZ**

[5011](#) [5012](#) [5100](#) [5200](#) [5400](#) [5B00](#)

[5B01](#) [5B12](#) [5B13](#) [5B14](#) [5B15](#)

- **6000 to 6ZZZ**

[6000](#) [6500](#) [6502](#) [6800](#) [6801](#) [6900](#)

[6901](#) [6902](#) [6910](#) [6911](#) [6930](#) [6931](#)

[6932](#) [6933](#) [6936](#) [6937](#) [6938](#) [6940](#)

[6941](#) [6942](#) [6943](#) [6944](#) [6945](#) [6946](#)

- **A000 to ZZZZ**

[B200](#) [C000](#)

About the support code for paper jam, you can also refer to [Support Code List \(When Paper Is Jammed\)](#).

Support Code List (When Paper Is Jammed)

If the paper is jammed, remove it following the procedure appropriate for each case.

- If you can see the jammed paper at the paper output slot:
 - ➡ [1300](#)
- If you cannot see the jammed paper at the paper output slot:
 - ➡ [1303](#)
- If the paper is jammed when automatic duplex printing:
 - ➡ [1304](#)
- If the paper tears and you cannot remove it from the paper output slot or from the transport unit:
 - ➡ [Paper Is Jammed inside the Machine](#)
- Cases other than above:
 - ➡ [In Other Cases](#)

1300

Cause

Paper is jammed in the paper output slot.

Action

If you can see the jammed paper at the paper output slot, remove the paper following the procedure below.

▶▶▶ Note

- If you need to turn off the machine to remove jammed paper during printing, press the **Stop** button to cancel print jobs before turning off the machine.

1. Pull the paper out slowly.

Hold the paper with your hands, then pull the paper out slowly not to tear it.



▶▶▶ Note

- If you cannot pull the paper out, turn the machine off and turn it back on. The paper may be ejected automatically.
- If you cannot pull the paper out from the paper output slot, try to pull the paper out from the transport unit.
➔ [1303](#)
- If the paper tears and you cannot remove the jammed paper from the paper output slot, remove the paper from inside the machine.
➔ [Paper Is Jammed inside the Machine](#)

2. Reload the paper, and press the machine's **OK** button.

If you turned off the machine in step 1, all print jobs in the queue are canceled. Reprint if necessary.

▶▶▶ Note

- When reloading the paper, confirm that you are using the paper suited for printing and are loading it correctly.
- We recommend you use paper other than A5 sized one to print documents with photos or graphics; otherwise, the printout may curl and cause paper exit jams.

If you cannot remove the paper or the paper tears inside the machine, or if the paper jam error continues after removing the paper, contact the service center.

1303

Cause

Paper is jammed inside the machine at the transport unit.

Action

If you cannot see the paper at the paper output slot, remove the paper from the transport unit.

Remove the paper following the procedure below.

▶▶▶ Note

- If you need to turn off the machine to remove jammed paper during printing, press the **Stop** button to cancel print jobs before turning off the machine.

1. Turn the machine off, then unplug the power cord.
2. Stand the machine with the right side facing down.

▶▶▶ Important

- When you stand the machine, confirm that the document cover is closed.
- Stand the machine on a wide and flat surface such as a desk.
- When you stand the machine, hold it securely and be careful not to hit it on a hard object.

3. Push the open lever to open the transport unit.

When you open the transport unit, support the machine with your hand so that it does not fall down.

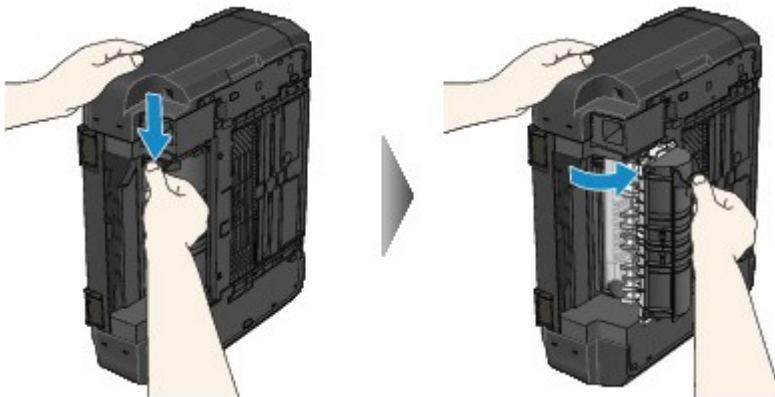

4. Pull out the jammed paper slowly.

When you pull the jammed paper, support the machine with your hand so that it does not fall down.

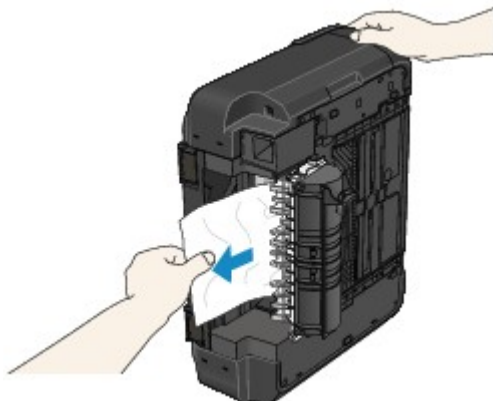

►►► **Note**

- If the paper is rolled up and it is difficult to remove, grasp the edges of the paper, then remove the jammed paper.
- If you cannot remove the jammed paper from the transport unit, close the transport unit, take back the machine in original position, then remove the paper from inside the machine.

➔ [Paper Is Jammed inside the Machine](#)

5. Close the transport unit.



►►► **Note**

- After you close the transport unit, take back the machine in original position at once.

6. Plug the machine back in and turn the machine back on.

All print jobs in the queue are canceled. Reprint if necessary.

If you cannot remove the paper or the paper tears inside the machine, or if the paper jam error continues after removing the paper, contact the service center.

1304

Cause

Paper is jammed when performing automatic duplex printing.

Action

If the paper is jammed when performing automatic duplex printing, remove the paper following the procedure below.

▶▶▶ Note

- If you need to turn off the machine to remove jammed paper during printing, press the **Stop** button to cancel print jobs before turning off the machine.

1. Pull the paper out slowly from the paper output slot.

Hold the paper with your hands, then pull the paper out slowly not to tear it.



2. Reload the paper, and press the machine's **OK** button.

If you were not able to remove the paper out in step 1:

Follow the procedure below to remove the paper from the transport unit.

3. Turn the machine off, then unplug the power cord.
4. Stand the machine with the right side facing down.

▶▶▶ Important

- When you stand the machine, confirm that the document cover is closed.
- Stand the machine on a wide and flat surface such as a desk.
- When you stand the machine, hold it securely and be careful not to hit it on a hard object.

5. Push the open lever to open the transport unit.

When you open the transport unit, support the machine with your hand so that it does not fall down.

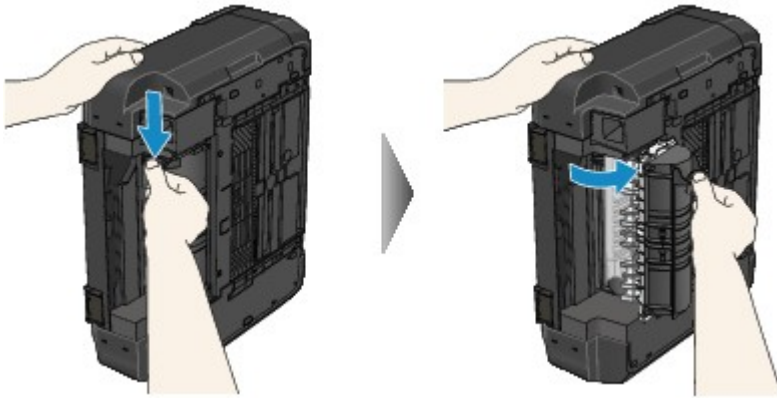

6. Pull out the jammed paper slowly.

When you pull the jammed paper, support the machine with your hand so that it does not fall down.

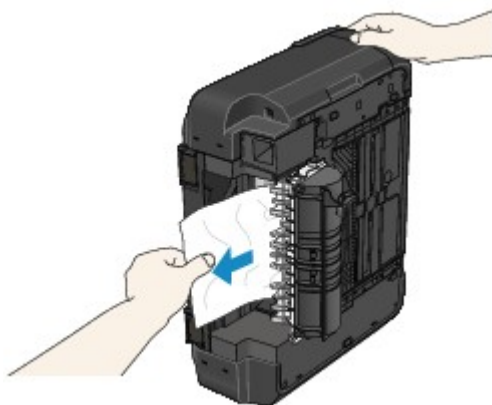

»» Note

- If the paper is rolled up and it is difficult to remove, grasp the edges of the paper, then remove the jammed paper.
- If you cannot remove the jammed paper from the transport unit, close the transport unit, take back the machine in original position, then remove the paper from inside the machine.

➔ [Paper Is Jammed inside the Machine](#)

7. Close the transport unit.

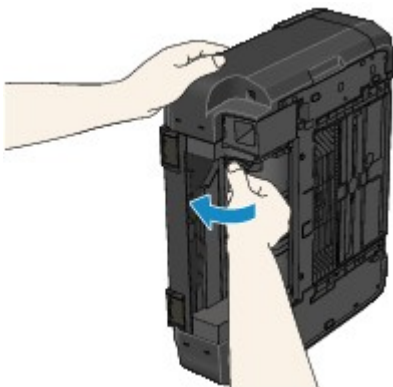

»» Note

- After you close the transport unit, take back the machine in original position at once.

8. Plug the machine back in and turn the machine back on.

All print jobs in the queue are canceled. Reprint if necessary.

If you cannot remove the paper or the paper tears inside the machine, or if the paper jam error continues after removing the paper, contact the service center.

Paper Is Jammed inside the Machine

If the jammed paper tears and you cannot remove the paper either from the paper output slot or from the transport unit, or if the jammed paper remains inside the machine, remove the paper following the procedure below.

▶▶▶ Note

- If you need to turn off the machine to remove jammed paper during printing, press the **Stop** button to cancel print jobs before turning off the machine.

1. Turn off the machine, and unplug the power cord of the machine from the power supply.
2. Lift up and open the operation panel until it stops.



▶▶▶ Important

- Do not touch the clear film (A) or the white belt (B).

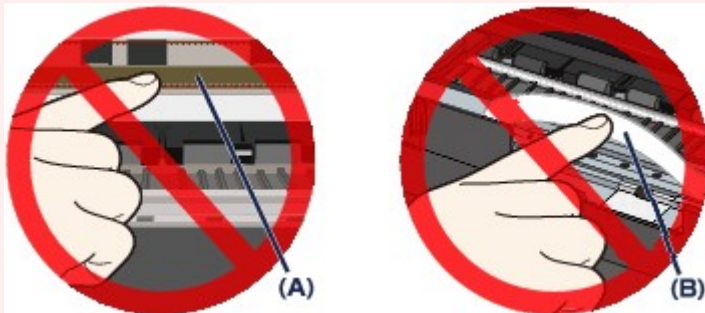

If the paper or your hands touch these parts and blot or scratch them, the machine can be damaged.

3. Make sure that the jammed paper is not under the print head holder.

If the jammed paper is under the print head holder, move the print head holder to the right edge or the left edge whichever is easier to remove the paper.

When you move the print head holder, hold the top of the print head holder and slide it slowly to the right edge or the left edge.



4. Hold the jammed paper with your hands.

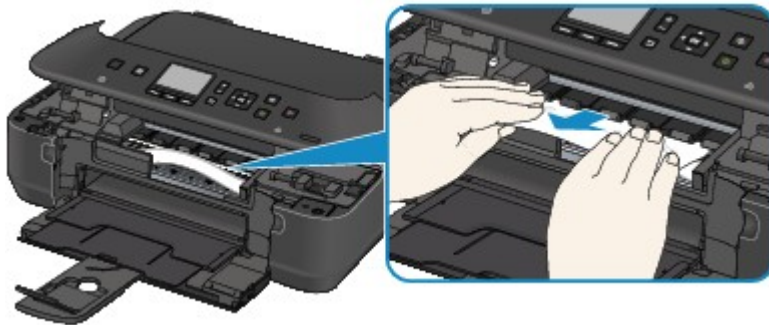

If the paper is rolled up, pull it out.

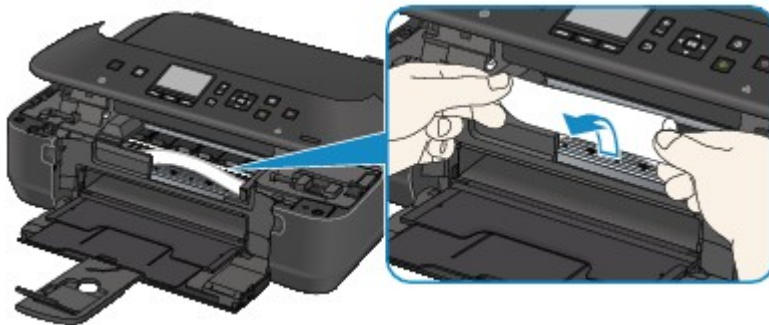

5. Pull the paper slowly not to tear it, then pull the paper out.

Keep an angle of the paper about 45 degrees and pull it slowly.

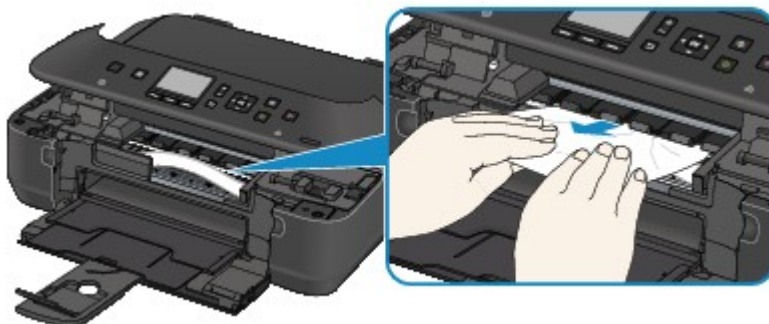

6. Make sure that all the jammed paper is removed.

If the paper is torn, a piece of paper may remain inside the machine. Check the following and remove the piece of paper if it remains.

- Does the piece of paper remain under the print head holder?
- Does the little piece of paper remain inside the machine?

- Does the piece of paper remain in the right side or the left side space (C) inside the machine?

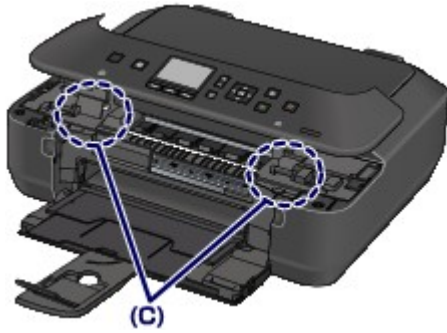

7. Close the operation panel slowly.

All print jobs in the queue are canceled. Reprint if necessary.

▶▶▶ Note

- When reloading the paper, confirm that you are using the paper suited for printing and are loading it correctly. If the message about paper jam is displayed on the LCD of the machine or on the computer screen when you resume printing after removing all the jammed paper, a piece of paper may remain inside the machine. In this case, confirm that no piece of paper remains inside the machine.

If you cannot remove the paper or the paper tears inside the machine, or if the paper jam error continues after removing the paper, contact the service center.

In Other Cases

Make sure of the following:

Check1 Are there any foreign objects around the paper output slot?

Check2 Is the paper curled?

Load the paper after correcting its curl.

1003

Cause

The machine is out of paper, or paper does not feed.

Action

Close the paper output tray, pull the feeder out, then load the paper.

When you load the paper, insert the paper stack until the leading edge touches the far end of the feeder.

After loading the paper, push the feeder so that the ▶ mark on the front tray aligns with the ◀ mark on the machine.

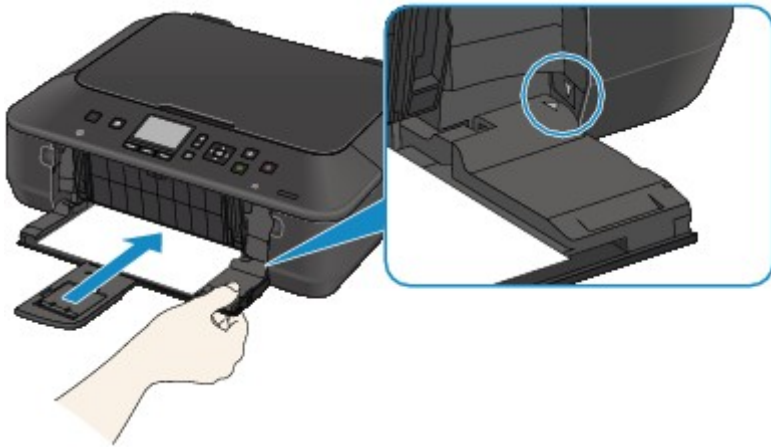

Open the paper output tray, then press the machine's **OK** button.

1200

Cause

The operation panel is open.

Action

Close the operation panel and wait for a while.

Do not close it while you are replacing an ink tank.

1250

Cause

The paper output tray is closed.

Action

Open the paper output tray to resume printing.

1310

Cause

The size of paper may not be compatible with automatic duplex printing.

Action

The sizes of media suitable for auto duplex printing are A4 and Letter. Make sure that the size of the paper loaded in the machine is correct. Pressing the **OK** button will eject the paper and restart printing from the front side of the next paper. The reverse side of the ejected sheet will not be printed.

1401

Cause

The print head may be damaged.

Action

Contact the service center.

1403

Cause

The print head may be damaged.

Action

Contact the service center.

1405

Cause

The print head may be damaged.

Action

Contact the service center.

1410

Cause

The ink tank cannot be recognized.

Action

Open the operation panel and replace the ink tank which lamp is off.

1411

Cause

The ink tank cannot be recognized.

Action

Open the operation panel and replace the ink tank which lamp is off.

1412

Cause

The ink tank cannot be recognized.

Action

Open the operation panel and replace the ink tank which lamp is off.

1413

Cause

The ink tank cannot be recognized.

Action

Open the operation panel and replace the ink tank which lamp is off.

1414

Cause

The ink tank cannot be recognized.

Action

Open the operation panel and replace the ink tank which lamp is off.

1600

Cause

If the lamp on the ink tank is flashing, ink may have run out.

Action

Replacing the ink tank is recommended.

If printing is in progress and you want to continue printing, press the machine's **OK** button with the ink tank installed. Then printing can continue. Replacing the ink tank is recommended after the printing. The machine may be damaged if printing is continued under the ink out condition.

▶▶ Note

- If multiple ink lamps are flashing red, check the status of each ink tank.

1660

Cause

The ink tank is not installed.

Action

Install the ink tank.

1680

Cause

Some ink tanks are not installed in the correct position. (The lamp on the ink tank flashes.)

Action

Confirm that the ink tanks are installed in the appropriate positions.

1681

Cause

More than one ink tanks of the same color are installed. (The lamp on the ink tank flashes.)

Action

Confirm that the ink tanks are installed in the appropriate positions.

1684

Cause

The ink tank cannot be recognized.

Action

Printing cannot be executed because the ink tank may not be installed properly or may not be compatible with this machine.

Install the appropriate ink tank.

If you want to cancel printing, press the machine's **Stop** button.

1688

Cause

The ink has run out. (The lamp on the ink tank flashes.)

Action

Replace the ink tank and close the operation panel.

Printing under the current condition may damage the machine.

If you want to continue printing in this condition, you need to release the function for detecting the remaining ink level. Press and hold the machine's **Stop** button for at least 5 seconds, and then release it.

With this operation, releasing the function for detecting the remaining ink level is memorized. Please be advised that Canon shall not be liable for any malfunction or trouble which may be caused by continuation of printing under the ink out condition.

▶▶ Note

- If the function for detecting the remaining ink level is disabled, the ink tank in gray is displayed on the LCD when checking the current ink level.

1689

Cause

Printer detected ink out condition (The lamp on the ink tank flashes).

Action

Replace the ink tank and close the operation panel.

An ink tank that was once empty is installed.

Printing under the ink out condition may damage the machine.

If you want to continue printing, you need to release the function for detecting the remaining ink level. To release this function, press and hold the machine's **Stop** button for at least 5 seconds, and then release it.

With this operation, releasing the function for detecting the remaining ink level is memorized. Please be advised that Canon shall not be liable for any malfunction or trouble caused by continuation of printing under the ink out condition or refilled ink tanks.

▶▶ Note

- If the function for detecting the remaining ink level is disabled, the ink tank in gray is displayed on the LCD when checking the current ink level.

1700

Cause

The ink absorber is almost full.

Action

Press the machine's **OK** button to continue printing. Contact the service center.

1701

Cause

The ink absorber is almost full.

Action

Press the machine's **OK** button to continue printing. Contact the service center.

1712

Cause

The ink absorber is almost full.

Action

Press the machine's **OK** button to continue printing. Contact the service center.

1713

Cause

The ink absorber is almost full.

Action

Press the machine's **OK** button to continue printing. Contact the service center.

1714

Cause

The ink absorber is almost full.

Action

Press the machine's **OK** button to continue printing. Contact the service center.

1715

Cause

The ink absorber is almost full.

Action

Press the machine's **OK** button to continue printing. Contact the service center.

1890

Cause

The protective material for the print head holder or the tape may remain attached to the holder.

Action

Open the operation panel, then confirm that the protective material or the tape does not remain attached to the print head holder.

If you find the protective material or the tape remains attached, remove it, then close the operation panel.



If the problem is not resolved, contact the service center.

2100

Cause

Paper larger than the paper size in the print settings is loaded.

Action

Check the size of the loaded paper, then press the machine's **OK** button.

The following screen is displayed on the LCD.

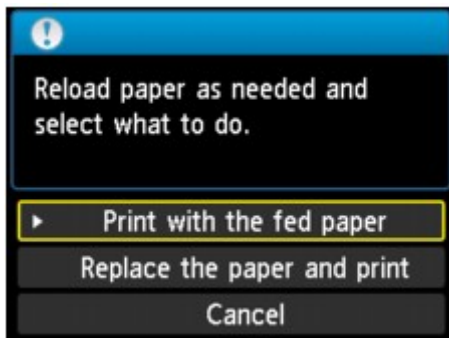

Reload paper as necessary, then select what to do.

»» Important

- When **Print with the fed paper** is selected, the machine does not detect the paper width for the current print job.

To disable the machine to detect the paper width for all subsequent print jobs, set the machine not to detect the paper width by using the operation panel, the printer driver, or Remote UI.

2101

Cause

Paper smaller than the paper size in the print settings is loaded.

Action

Check the size of the loaded paper, then press the machine's **OK** button.

The following screen is displayed on the LCD.

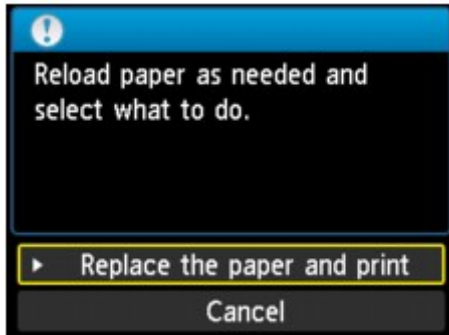

Reload paper as necessary, then select what to do.

2102

Cause

The machine has detected that the paper has been fed aligned to one side.

Action

Close the paper output tray, then pull the feeder out.

Load the paper into the center of the feeder, then slide the paper guides to align with the both edges of the paper stack.

After loading the paper, push the feeder so that the ▷ mark on the front tray aligns with the ◁ mark on the machine.

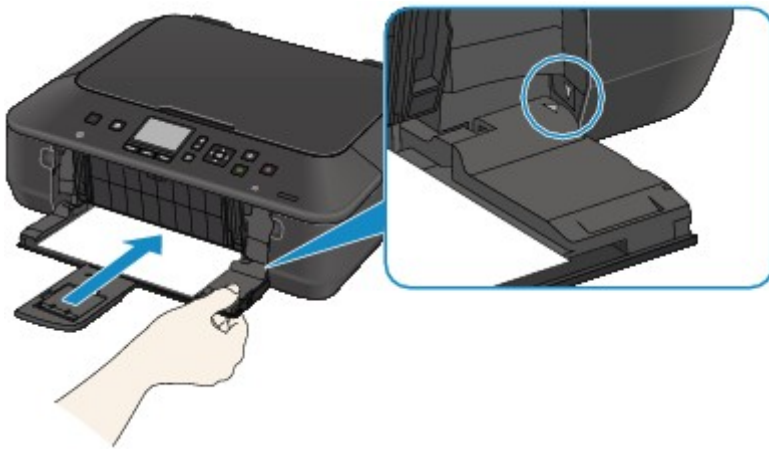

Open the paper output tray, then press the machine's **OK** button.

2103

Cause

The machine cannot detect the paper size.

Action

Press the machine's **Stop** button to dismiss the error, then try to print again.

If this error still occurs even after printing again, set the machine not to detect the paper width by using the operation panel, the printer driver, or Remote UI.

▶▶ Note

- Depending on the type of paper, the machine may not detect the paper width.

Additionally, if the operation panel is opened while printing is in progress, the machine may not detect the paper width.

2700

Cause

Some errors occurred while copying and a certain time passed.

Action

Press the **OK** button to dismiss the error, and try to copy again.

2900

Cause

Scanning the print head alignment sheet has failed.

Action

Press the **OK** button to dismiss the error, then take the actions described below.

- Make sure that the print head alignment sheet is set in the correct position and orientation on the platen glass.
- Make sure the platen glass and the print head alignment sheet are not dirty.
- Make sure the type and size of loaded paper is suitable for Automatic Print Head Alignment.
For Automatic Print Head Alignment, always load one sheet of A4 or Letter-sized plain paper.
- Make sure if print head nozzles are clogged.

Print the nozzle check pattern to check the status of the print head.

If the error is not resolved, perform Manual Print Head Alignment.

4100

Cause

The specified data cannot be printed.

Action

When you print the contents on CREATIVE PARK PREMIUM, confirm the message on the computer screen, make sure that genuine Canon ink tanks are installed properly for all colors, then start printing again.

4103

Cause

Cannot perform automatic duplex printing with the current paper size setting.

Action

Press the machine's **Stop** button, to cancel printing.

Then, change the paper size setting and print again.

5011

Cause

Printer error has occurred.

Action

Turn off the machine, and unplug the power cord of the machine from the power supply.

Plug the machine back in and turn the machine back on.

If the problem is not resolved, contact the service center.

5012

Cause

Printer error has occurred.

Action

Turn off the machine, and unplug the power cord of the machine from the power supply.

Plug the machine back in and turn the machine back on.

If the problem is not resolved, contact the service center.

5100

Cause

Printer error has occurred.

Action

Cancel printing, and turn off the machine. Then clear the jammed paper or protective material that is preventing the print head holder from moving, and turn on the machine again.

If the problem is not resolved, contact the service center.

►► Important

- When you clear the jammed paper or protective material that is preventing the print head holder from moving, be careful not to touch the components inside the machine. The machine may not print out properly if you touch it.

5200

Cause

Printer error has occurred.

Action

Turn off the machine, and unplug the power cord of the machine from the power supply.

Plug the machine back in and turn the machine back on.

If the problem is not resolved, contact the service center.

5400

Cause

Printer error has occurred.

Action

Turn off the machine, and unplug the power cord of the machine from the power supply.

Plug the machine back in and turn the machine back on.

If the problem is not resolved, contact the service center.

5B00

Cause

Printer error has occurred.

Action

Contact the service center.

5B01

Cause

Printer error has occurred.

Action

Contact the service center.

5B12

Cause

Printer error has occurred.

Action

Contact the service center.

5B13

Cause

Printer error has occurred.

Action

Contact the service center.

5B14

Cause

Printer error has occurred.

Action

Contact the service center.

5B15

Cause

Printer error has occurred.

Action

Contact the service center.

6000

Cause

Printer error has occurred.

Action

Turn off the machine, and unplug the power cord of the machine from the power supply.

Plug the machine back in and turn the machine back on.

If the problem is not resolved, contact the service center.

6500

Cause

Printer error has occurred.

Action

Turn off the machine, and unplug the power cord of the machine from the power supply.

Plug the machine back in and turn the machine back on.

If the problem is not resolved, contact the service center.

6502

Cause

Printer error has occurred.

Action

Turn off the machine, and unplug the power cord of the machine from the power supply.

Plug the machine back in and turn the machine back on.

If the problem is not resolved, contact the service center.

6800

Cause

Printer error has occurred.

Action

Turn off the machine, and unplug the power cord of the machine from the power supply.

Plug the machine back in and turn the machine back on.

If the problem is not resolved, contact the service center.

6801

Cause

Printer error has occurred.

Action

Turn off the machine, and unplug the power cord of the machine from the power supply.

Plug the machine back in and turn the machine back on.

If the problem is not resolved, contact the service center.

6900

Cause

Printer error has occurred.

Action

Turn off the machine, and unplug the power cord of the machine from the power supply.

Plug the machine back in and turn the machine back on.

If the problem is not resolved, contact the service center.

6901

Cause

Printer error has occurred.

Action

Turn off the machine, and unplug the power cord of the machine from the power supply.

Plug the machine back in and turn the machine back on.

If the problem is not resolved, contact the service center.

6902

Cause

Printer error has occurred.

Action

Turn off the machine, and unplug the power cord of the machine from the power supply.

Plug the machine back in and turn the machine back on.

If the problem is not resolved, contact the service center.

6910

Cause

Printer error has occurred.

Action

Turn off the machine, and unplug the power cord of the machine from the power supply.

Plug the machine back in and turn the machine back on.

If the problem is not resolved, contact the service center.

6911

Cause

Printer error has occurred.

Action

Turn off the machine, and unplug the power cord of the machine from the power supply.

Plug the machine back in and turn the machine back on.

If the problem is not resolved, contact the service center.

6930

Cause

Printer error has occurred.

Action

Turn off the machine, and unplug the power cord of the machine from the power supply.

Plug the machine back in and turn the machine back on.

If the problem is not resolved, contact the service center.

6931

Cause

Printer error has occurred.

Action

Turn off the machine, and unplug the power cord of the machine from the power supply.

Plug the machine back in and turn the machine back on.

If the problem is not resolved, contact the service center.

6932

Cause

Printer error has occurred.

Action

Turn off the machine, and unplug the power cord of the machine from the power supply.

Plug the machine back in and turn the machine back on.

If the problem is not resolved, contact the service center.

6933

Cause

Printer error has occurred.

Action

Turn off the machine, and unplug the power cord of the machine from the power supply.

Plug the machine back in and turn the machine back on.

If the problem is not resolved, contact the service center.

6936

Cause

Printer error has occurred.

Action

Turn off the machine, and unplug the power cord of the machine from the power supply.

Plug the machine back in and turn the machine back on.

If the problem is not resolved, contact the service center.

6937

Cause

Printer error has occurred.

Action

Turn off the machine, and unplug the power cord of the machine from the power supply.

Plug the machine back in and turn the machine back on.

If the problem is not resolved, contact the service center.

6938

Cause

Printer error has occurred.

Action

Turn off the machine, and unplug the power cord of the machine from the power supply.

Plug the machine back in and turn the machine back on.

If the problem is not resolved, contact the service center.

6940

Cause

Printer error has occurred.

Action

Turn off the machine, and unplug the power cord of the machine from the power supply.

Plug the machine back in and turn the machine back on.

If the problem is not resolved, contact the service center.

6941

Cause

Printer error has occurred.

Action

Turn off the machine, and unplug the power cord of the machine from the power supply.

Plug the machine back in and turn the machine back on.

If the problem is not resolved, contact the service center.

6942

Cause

Printer error has occurred.

Action

Turn off the machine, and unplug the power cord of the machine from the power supply.

Plug the machine back in and turn the machine back on.

If the problem is not resolved, contact the service center.

6943

Cause

Printer error has occurred.

Action

Turn off the machine, and unplug the power cord of the machine from the power supply.

Plug the machine back in and turn the machine back on.

If the problem is not resolved, contact the service center.

6944

Cause

Printer error has occurred.

Action

Turn off the machine, and unplug the power cord of the machine from the power supply.

Plug the machine back in and turn the machine back on.

If the problem is not resolved, contact the service center.

6945

Cause

Printer error has occurred.

Action

Turn off the machine, and unplug the power cord of the machine from the power supply.

Plug the machine back in and turn the machine back on.

If the problem is not resolved, contact the service center.

6946

Cause

Printer error has occurred.

Action

Turn off the machine, and unplug the power cord of the machine from the power supply.

Plug the machine back in and turn the machine back on.

If the problem is not resolved, contact the service center.

B200

Cause

An error requiring you to contact the service center has occurred.

Action

Turn off the machine, and unplug the power cord of the machine from the power supply.

Contact the service center.

C000

Cause

Printer error has occurred.

Action

Turn off the machine, and unplug the power cord of the machine from the power supply.

Plug the machine back in and turn the machine back on.

If the problem is not resolved, contact the service center.