



imageCLASS

MF249dw / MF246dn / MF237w / MF235

User's Guide

Contents

Important Safety Instructions	2
Installation	3
Power Supply	5
Handling	6
Maintenance and Inspections	9
Consumables	10
Basic Operations	14
Parts and Their Functions	17
Front Side	18
Back Side	20
Interior	22
Manual Feed Slot	23
Paper Drawer	24
Operation Panel	25
Display	28
Customizing the <Home> Screen	33
Using the Display	35
Entering Text	38
Placing Documents	41
Loading Paper	45
Loading Paper in the Paper Drawer	47
Loading Paper in the Manual Feed Slot	50
Loading Envelopes	52
Loading Preprinted Paper	54
Specifying Paper Size and Type	56
Registering a Custom Paper Size	58
Registering in the Address Book	60
Registering Destinations in the Address Book	61
Registering Destinations for One-Touch Dial	65
Registering Multiple Destinations for Group Dial	69
Adjusting the Volume	72
Entering Quiet Mode	74
Entering Sleep Mode	76
Copying	79
Basic Copy Operations	81
Canceling Copies	83
Various Copy Settings	85
Enlarging or Reducing	86
Selecting Document Type	87

Adjusting Density	88
Adjusting Sharpness	89
2-Sided Copying (MF249dw / MF246dn)	91
Copying Multiple Documents onto One Sheet (2 on 1/4 on 1)	94
Using the <Paper Save> Button	96
Copying Both Sides of an ID Card onto One Page	98
Collating Copies by Page	99
Changing Default Settings	100

Faxing 103

Configuring Initial Settings for Fax Functions 106

Deciding Which Fax Receive Mode to Use	107
Registering the Fax Number and Unit Name	108
Selecting the Receive Mode	110
Connecting the Telephone Line	112

Sending Faxes 114

Sending from Registered Destinations	120
Specifying from Address Book	121
Selecting Destinations Directly by Entering Coded Dial Numbers	124
Specifying Destinations with the One-Touch Buttons	127
Specifying Previously Used Destinations	130
Various Fax Settings	133
Adjusting Resolution	134
Adjusting Density	135
Adjusting Sharpness	136
Scanning 2-Sided Documents (MF249dw)	138
Changing Default Settings	139
Canceling Sending Faxes	140

Receiving Faxes 142

Sending and Receiving Faxes According to Your Purposes 146

Making a Call before Sending Faxes (Manual Sending)	147
Sending Faxes to Multiple Destinations Simultaneously (Sequential Broadcast)	148
Storing Received Faxes into Memory (Memory Reception)	150
Forwarding Received Faxes	154
Selecting a Document to Forward	155
Forwarding All the Received Documents Automatically (MF249dw / MF246dn)	157
Receiving Fax Information Services	161

Checking Status and Log for Sent and Received Documents 163

Importing/Exporting Address Book Data with the Supplied Software 165

Sending Faxes from Your Computer (PC Fax) 167

Sending PC Faxes	168
Attaching Cover Sheets to PC Faxes	171
Using Address Book for PC Faxes	175
Registering Destinations	178
Using Registered Destinations	182

Importing/Exporting Address Book Data from the Fax Driver	184
---	-----

Using the Machine as a Printer 189

Printing from a Computer	190
Printing a Document	191
Canceling Prints	195
Checking the Printing Status	198
Various Print Settings	199
Enlarging or Reducing	201
Switching 1-Sided and 2-Sided Printing (MF249dw / MF246dn)	203
Collating Printouts by Page	205
Printing Multiple Pages onto One Sheet	207
Printing Posters	209
Printing Booklet (MF249dw / MF246dn)	211
Printing Borders	213
Printing Dates and Page Numbers	214
Printing Watermarks	216
Selecting Document Type	218
Saving Toner	220
Combining and Printing Multiple Documents	222
Configuring Print Settings to Your Needs	226
Registering Combinations of Frequently Used Print Settings	227
Changing Default Settings	229

Using the Machine as a Scanner 232

Preparing to Use the Machine as a Scanner (MF249dw / MF246dn / MF237w)	233
Scanning from the Machine	234
Scanning Using the <Scan -> PC> Button	237
Scanning from a Computer	241
Scanning Using an Application	242
Configuring Scan Settings in ScanGear MF	244
Convenient Scanning with a Machine-Based Operation (MF249dw / MF246dn)	245
Sending Documents as E-Mails Directly from the Machine	246
Saving Documents Directly in Shared Folder	253
Canceling Sending Documents (E-Mail/Shared Folder)	256
Specifying Detailed Settings	258
Specifying a Scanning Size	260
Setting Color Mode	261
Selecting a File Format	262
Adjusting Density	264
Specifying Orientation of Your Document	265
Selecting Document Type	266
Scanning 2-Sided Documents (MF249dw)	267
Adjusting Sharpness	268
Adjusting Balance between File Size and Image Quality	270
Setting Gamma Values	271
Sending Using Registered Destinations (E-Mail/Shared Folder)	272

Specifying from Address Book	273
Selecting Destinations Directly by Entering Coded Dial Numbers	276
Specifying Destinations with the One-Touch Buttons	279
Specifying Previously Used Destinations	281
Changing Default Settings	284
Checking Status and Log for Sent Documents (E-Mail/Shared Folder)	286

Can Be Used Conveniently with a Mobile Device (MF249dw / MF246dn / MF237w) 289

Connecting to a Mobile Device	290
Make Direct Connection (Access Point Mode) (MF249dw / MF237w)	291
Making the Best Use of the Machine by Utilizing Applications	294
Using AirPrint	295
Printing with AirPrint	300
Scanning with AirPrint	303
Faxing with AirPrint	305
If AirPrint Cannot Be Used	307
Using Google Cloud Print	308
Managing the Machine Remotely	312

Network (MF249dw / MF246dn / MF237w) 314

Connecting to a Network	315
Selecting Wired LAN or Wireless LAN (MF249dw / MF237w)	317
Connecting to a Wired LAN	318
Connecting to a Wireless LAN (MF249dw / MF237w)	319
Setting Up Connection Using WPS Push Button Mode	321
Setting Up Connection Using WPS PIN Code Mode	323
Setting Up Connection by Selecting a Wireless Router	326
Setting Up Connection by Specifying Detailed Settings	329
Checking the SSID and Network Key	333
Setting IP Addresses	336
Setting IPv4 Address	337
Setting IPv6 Addresses	340
Viewing Network Settings	344
Configuring the Machine for Printing or Faxing from a Computer	347
Configuring Printing Protocols and WSD Functions	348
Configuring Printer Ports	351
Setting Up Print Server	354
Configuring Scan Settings (E-Mail/Shared Folders) (MF249dw / MF246dn)	357
Configuring Scan Settings (Sending E-Mail)	358
Configuring Basic E-Mail Settings	359
Configuring E-Mail Communication Settings	363
Configuring the Machine for Scanning to Shared Folders	367
Setting a Shared Folder as a Save Location	368
Configuring the Machine for Your Network Environment	372
Configuring Ethernet Settings	373

Changing the Maximum Transmission Unit	375
Setting a Wait Time for Connecting to a Network	376
Configuring DNS	377
Configuring SMB (MF249dw / MF246dn)	382
Configuring SNMP	384
Monitoring and Controlling the Machine with SNMP	386

Security 392

Protecting the Machine from Unauthorized Access	393
Preventing Unauthorized Access	394
Setting Access Privileges	396
Setting the System Manager PIN	397
Setting a Remote UI PIN (MF249dw / MF246dn / MF237w)	399
Restricting Communication by Using Firewalls (MF249dw / MF246dn / MF237w)	401
Specifying IP Addresses for Firewall Rules	402
Specifying MAC Addresses for Firewall Rules	406
Changing Port Numbers (MF249dw / MF246dn / MF237w)	409
Setting a Proxy (MF249dw / MF246dn / MF237w)	411
Restricting the Machine's Functions	413
Restricting Access to Address Book and Sending Functions	414
Setting a PIN for Address Book	415
Limiting Available Destinations	417
Prohibiting PC Faxing	418
Disabling Use of Previously Used Destinations	419
Checking Destinations before Sending Documents	420
Prohibiting Sequential Broadcasting	422
Disabling HTTP Communication (MF249dw / MF246dn / MF237w)	423
Disabling Remote UI (MF249dw / MF246dn / MF237w)	424
Implementing Robust Security Features (MF249dw / MF246dn / MF237w)	425
Enabling TLS Encrypted Communication for the Remote UI	426
Configuring IEEE 802.1X Authentication	429
Configuring Settings for Key Pairs and Digital Certificates	434
Generating Key Pairs	436
Using CA-issued Key Pairs and Digital Certificates	443
Verifying Key Pairs and Digital Certificates	446

Using Remote UI (MF249dw / MF246dn / MF237w) 449

Starting Remote UI	450
Remote UI Screens	452
Managing Documents and Checking the Machine Status	456
Setting Up Menu Options from Remote UI	461
Saving/Loading Address Book from Remote UI	463
Registering Address Book from Remote UI	467

Setting Menu List	472
Network Settings (MF249dw / MF246dn / MF237w)	473
Preferences	483
Timer Settings	488
Common Settings (MF249dw / MF246dn)	492
Copy Settings	494
Fax Settings	496
Scan Settings	507
Printer Settings	512
Adjustment/Maintenance	522
System Management Settings	528
Troubleshooting	538
Clearing Jams	540
When an Error Message Appears	548
When an Error Code Appears	558
Common Problems	564
Installation/Settings Problems	565
Copy/Printing Problems	569
Faxing/Telephone Problems	572
When You Cannot Print Properly	574
Printing Results Are Not Satisfactory	576
Paper Creases or Curls	581
Paper Is Fed Incorrectly	583
When a Problem Cannot Be Solved	585
Maintenance	587
Cleaning the Machine	588
Exterior	589
Platen Glass	590
Feeder	593
Fixing Assembly	594
Machine Interior	595
Replacing Toner Cartridges	597
Before Replacing the Toner Cartridge	600
How to Replace Toner Cartridges	602
Relocating the Machine	605
Printing Reports and Lists	607
TX Result Report	608
Communication Management Report	611
RX Result Report	613
Consumables Status Report	614
Eco Report	615

PCL Font List (MF249dw / MF246dn)	616
Address Book List	617
User Data List	619
Viewing the Counter Value	620
Initializing Settings	621
Initializing Menu	622
Initializing Address Book	624
Initialize Eco Report Counter	625
Initializing All Data/Settings	626

Appendix 628

Third Party Software (MF249dw / MF246dn / MF237w)	629
Feature Highlights	630
Going Green and Saving Money	631
Improving Efficiency	633
Going Digital	635
So Much More	638
Specifications	641
Machine Specifications	642
Wireless LAN Specifications (MF249dw / MF237w)	644
Document Type	645
Scan Area	646
Paper	647
Copy Specifications	649
Fax Specifications	650
Scanner Specifications	651
Printer Specifications	652
Specifications for E-Mail Sending (MF249dw / MF246dn)	653
Specifications for Scanning to Shared Folders (MF249dw / MF246dn)	654
Consumables	655
Manuals Included with the Machine	656
Using User's Guide	657
Screen Layout of User's Guide	658
Viewing User's Guide	662
Others	663
Basic Windows Operations	664
Notice	673

Important Safety Instructions

Important Safety Instructions	2
Installation	3
Power Supply	5
Handling	6
Maintenance and Inspections	9
Consumables	10

Important Safety Instructions

14L7-000

The content described in this chapter is for the prevention of damage to property and injury to users of the machine and others. Before using this machine, read this chapter and follow the instructions to properly use this machine. Do not perform any operations not described in this manual. Canon will not be responsible for any damages resulting from use not described in this manual, improper use, or repair/changes not performed by Canon or a third party authorized by Canon.

Installation

14L7-001

To use this machine safely and comfortably, carefully read the following precautions and install the machine in an appropriate location.

WARNING

Do not install in a location that may result in a fire or electrical shock

- A location where the ventilation slots are blocked (too close to walls, beds, rugs, or similar objects)
- A damp or dusty location
- A location exposed to direct sunlight or outdoors
- A location subject to high temperatures
- A location exposed to open flames
- Near alcohol, paint thinners or other flammable substances

Other warnings

- Do not connect unapproved cables to this machine. Doing so may result in a fire or electrical shock.
- Do not place necklaces and other metal objects or containers filled with liquid on the machine. If foreign substances come in contact with electrical parts inside the machine, it may result in a fire or electrical shock.
- When installing and removing the optional accessories, be sure to turn OFF the power, unplug the power plug, and then disconnect all the interface cables and power cord from the machine. Otherwise, the power cord or interface cables may be damaged, resulting in a fire or electrical shock.
- Do not use near any medical equipment. Radiowaves emitted from this machine may interfere with medical equipment, which may cause a malfunction and result in serious accidents.
- If any foreign substance falls into this machine, unplug the power plug from the AC power outlet and contact your local authorized Canon dealer.

CAUTION

Do not install in the following locations

The machine may drop or fall, resulting in injury.

- Unstable location
- Location exposed to vibrations



Other cautions

- When carrying this machine, follow the instructions in this manual. If carried improperly, it may fall, resulting in injury.
- When installing this machine, be careful not to get your hands caught between the machine and the floor or walls, or between the paper drawers. Doing so may result in injury.

IMPORTANT

Do not install in the following locations that may result in damage

- A location subject to dramatic changes in temperature or humidity
- A location near equipment that generates magnetic or electromagnetic waves
- A laboratory or location where chemical reactions occur
- A location exposed to corrosive or toxic gases
- A location that may warp from the weight of the machine or where the machine is liable to sink (a carpet, etc.)



Avoid poorly ventilated locations

This machine generates a slight amount of ozone, etc. during normal use. Although sensitivity to ozone, etc. may vary, this amount is not harmful. Ozone, etc. may be more noticeable during extended use or long production runs, especially in poorly ventilated rooms. It is recommended that the room where the machine operates be appropriately ventilated to maintain a comfortable working environment. Also avoid locations where people would be exposed to emissions from the machine.

Do not install in a location where condensation occurs

Water droplets (condensation) may form inside the machine when the room where the machine is installed is heated rapidly, and when the machine is moved from a cool or dry location to a hot or humid location. Using the machine under these conditions may result in paper jams, poor print quality, or damage to the machine. Let the machine adjust to the ambient temperature and humidity for at least 2 hours before use.

When using wireless LAN (MF249dw / MF237w)

- Set the machine at a distance of 50 m or less from the wireless LAN router.
- Do not set machine in a location where any object blocks communication. The signal may be degraded when passing through walls or floors.
- Keep the machine as far as possible from digital cordless phones, microwave ovens, or other equipment that emit radio waves.

In altitudes of above sea level 3,000 m or higher

Machines with a hard disk may not operate properly when used at high altitudes of about 3,000 meters above sea level, or higher.

Connecting the Telephone Line

This machine conforms to an analog telephone line standard. The machine can be connected to the public switched telephone network (PSTN) only.

If you connect the machine to a digital telephone line or a dedicated telephone line, it might impede proper operation of the machine and could be the cause of damage. Make sure to confirm a type of telephone line before connecting the machine.

Contact your optical fiber line or IP telephone line service providers if you want to connect the machine to those telephone lines.

Power Supply

14L7-002

This machine is compatible with voltages of 220 to 240 V, and electrical frequency of 50/60 Hz.

WARNING

- Use only a power supply that meets the specified voltage requirements. Failure to do so may result in a fire or electrical shock.
- Do not use power cords other than the one provided, as this may result in a fire or electrical shock.
- The provided power cord is intended for use with this machine. Do not connect the power cord to other devices.
- Do not modify, pull, forcibly bend, or perform any other act that may damage the power cord. Do not place heavy objects on the power cord. Damaging the power cord may result in a fire or electrical shock.
- Do not plug in or unplug the power plug with wet hands, as this may result in an electrical shock.
- Do not use extension cords or multi-plug power strips with the machine. Doing so may result in a fire or electrical shock.
- Do not wrap the power cord or tie it in a knot, as this may result in a fire or electrical shock.
- Insert the power plug completely into the AC power outlet. Failure to do so may result in a fire or electrical shock.
- Remove the power plug completely from the AC power outlet during a thunder storm. Failure to do so may result in a fire, electrical shock, or damage to the machine.

CAUTION

Install this machine near the power outlet and leave sufficient space around the power plug so that it can be unplugged easily in an emergency.

IMPORTANT

When connecting power

- Do not connect the machine to an uninterruptible power source.
- If plugging this machine into an AC power outlet with multiple sockets, do not use the remaining sockets to connect other devices.
- Do not connect the power cord into the auxiliary outlet on a computer.

Other precautions

Electrical noise may cause this machine to malfunction or lose data.

Handling

WARNING

- Immediately unplug the power plug from the AC power outlet and contact an authorized Canon dealer if the machine makes an unusual noise, emits an unusual smell, or emits smoke or excessive heat. Continued use may result in a fire or electrical shock.
- Do not disassemble or modify this machine. There are high-voltage and high-temperature components inside the machine which may result in a fire or electrical shock.



- Place the machine where children will not come in contact with the power cord and other cables or internal and electrical parts. Failure to do so may result in unexpected accidents.
- Do not use flammable sprays near this machine. If flammable substances come into contact with electrical parts inside this machine, it may result in a fire or electrical shock.
- When moving this machine, be sure to turn OFF the power of this machine and your computer, and then unplug the power plug and interface cables. Failure to do so may damage the power cord or interface cables, resulting in a fire or electrical shock.
- When plugging or unplugging a USB cable when the power plug is plugged into an AC power outlet, do not touch the metal part of the connector, as this may result in an electrical shock.

If you are using a cardiac pacemaker

This machine generates a low level magnetic flux. If you use a cardiac pacemaker and feel abnormalities, please move away from this machine and consult your physician immediately.

CAUTION

- Do not place heavy objects on this machine as they may fall, resulting in injury.
- For your safety, please unplug the power cord if the machine will not be used for a long period of time.
- Use caution when opening and closing covers to avoid injury to your hands.
- Keep hands and clothing away from the rollers in the output area. If the rollers catch your hands or clothing, this may result in personal injury.
- The inside of the machine and the output slot are very hot during and immediately after use. Avoid contact with these areas to prevent burns. Also, printed paper may be hot immediately after being output, so use caution when handling it. Failure to do so may result in burns.

CAUTION

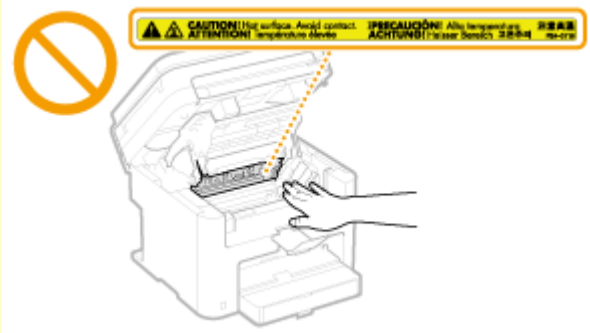

- When copying with a thick book placed on the platen glass, do not press the feeder forcefully. Doing so may damage the platen glass and result in injury.
- Be careful not to drop a heavy object, such as a dictionary, on the platen glass. Doing so may damage the platen glass and result in injury.

Laser beam

- If the laser beam should escape and enter your eyes, exposure may cause damage to your eyes.

IMPORTANT

When transporting the machine

To prevent damage to the machine during transport, perform the following.

- Remove the toner cartridges.
- Securely pack the machine in the original box with packing materials.

If the operating noise concerns you

- Depending on the use environment and operating mode, if the operating noise is of concern, it is recommended that the machine be installed in a place other than the office.

Other precautions

- Follow the instructions in the caution label attached to this machine.
- Avoid shaking or applying shock to this machine.
- Do not forcibly open and close doors, covers, and other parts. Doing so may result in damage to the machine.
- Do not touch the contacts (a). Doing so may result in damage to the machine.

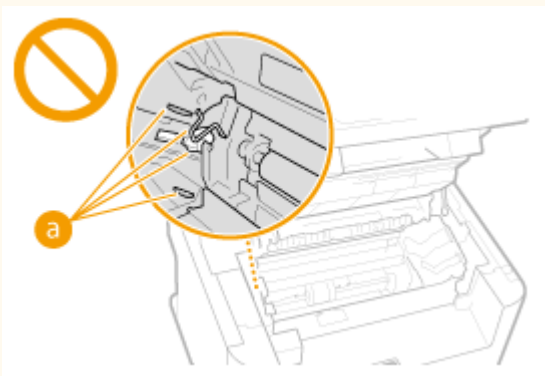

- Do not turn OFF the machine during printing. Also, do not open and close the cover and do not remove or insert paper during printing. Doing so can cause paper jams.
- Use a telephone cable with a length of 3 m or less.

Important Safety Instructions

- The display is a touch panel. Press gently to operate. Avoid pressing with a mechanical pencil, ballpoint pen, or other pointed object. Doing so may scratch or damage the touch panel's surface.

Maintenance and Inspections

14L7-004

Clean this machine periodically. If dust accumulates, the machine may not operate properly. When cleaning, be sure to observe the following. If a problem occurs during operation, see **▶Troubleshooting(P. 538)** . If the problem cannot be resolved or you feel the machine requires an inspection, see **▶When a Problem Cannot Be Solved(P. 585)** .

WARNING

- Before cleaning, turn OFF the power and unplug the power plug from the AC power outlet. Failure to do so may result in a fire or electrical shock.
- Unplug the power plug periodically and clean with a dry cloth to remove dust and grime. Accumulated dust may absorb humidity in the air and may result in a fire if it comes into contact with electricity.
- Use a damp, well wrung-out cloth to clean the machine. Dampen cleaning cloths with water only. Do not use alcohol, benzenes, paint thinners, or other flammable substances. Do not use tissue paper or paper towels. If these substances come into contact with electrical parts inside the machine, they may generate static electricity or result in a fire or electrical shock.
- Check the power cord and plug periodically for damage. Check the machine for rust, dents, scratches, cracks, or excessive heat generation. Use of poorly-maintained equipment may result in a fire or electrical shock.

CAUTION

- The inside of the machine has high-temperature and high-voltage components. Touching these components may result in burns. Do not touch any part of the machine that is not indicated in the manual.
- When loading paper or removing jammed documents or paper, be careful not to cut your hands with the edges of the paper.

IMPORTANT

When removing jammed paper or replacing toner cartridges, be careful not to get any toner on your hands or clothing. If toner gets on your hands or clothing, wash them immediately with cold water.

Consumables

14L7-005

WARNING

- Do not dispose of used toner cartridges in open flames. Also, do not store toner cartridges or paper in a location exposed to open flames. This may cause the toner to ignite, and result in burns or fire.
- If you accidentally spill or scatter toner, carefully gather the toner particles together or wipe them up with a soft, damp cloth in a way that prevents inhalation. Never use a vacuum cleaner that does not have safeguards against dust explosions to clean up spilled toner. Doing so may cause a malfunction in the vacuum cleaner, or result in a dust explosion due to static discharge.

If you are using a cardiac pacemaker

Toner cartridges generate a low level magnetic flux. If you use a cardiac pacemaker and feel abnormalities, please move away from toner cartridges and consult your physician immediately.

CAUTION

- Use caution not to inhale any toner. If you should inhale toner, consult a physician immediately.
- Use caution so that toner does not get into your eyes or mouth. If toner should get into your eyes or mouth, immediately wash with cold water and consult a physician.
- Use caution so that toner does not come into contact with your skin. If it should, wash with soap and cold water. If there is any irritation on your skin, consult a physician immediately.
- Keep the toner cartridges and other consumables out of the reach of small children. If toner is ingested, consult a physician or poison control center immediately.
- Do not disassemble or modify the toner cartridge. Doing so may cause the toner to scatter.
- Remove the sealing tape of the toner cartridge completely without using excessive force. Doing otherwise may cause the toner to scatter.

IMPORTANT

Handling the toner cartridge

- Hold the toner cartridge correctly as shown. Do not stand it up or turn it upside-down.

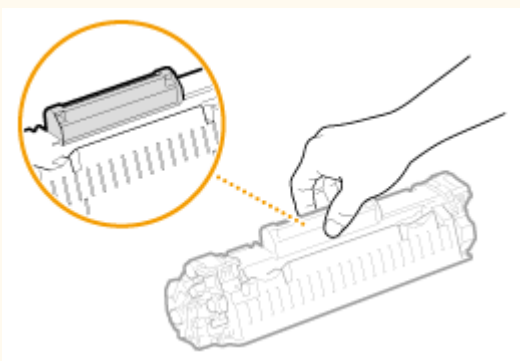

- Do not touch the toner cartridge memory (**a**) or the electrical contacts (**b**).

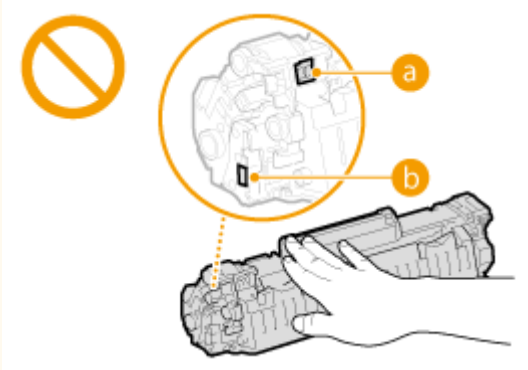

- Do not scratch the drum surface (c) or expose it to light.

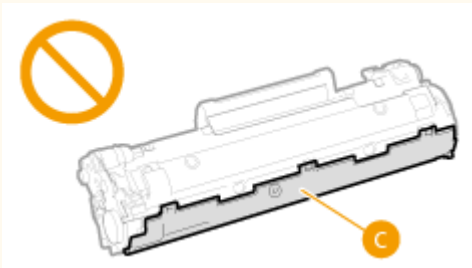

- Do not remove the toner cartridge from this machine or from the protective bag unnecessarily.
- The toner cartridge is a magnetic product. Keep it away from floppy disks, disk drives, and other devices that can be affected by magnetism. Failure to do so may result in data loss.

Storing the toner cartridge

- Store in the following environment to ensure safe and satisfactory use.
Storage temperature range: 0 to 35°C
Storage humidity range: 35 to 85% RH (relative humidity/no condensation)*
- Store without opening until the toner cartridge is to be used.
- When removing the toner cartridge from this machine for storage, place the removed toner cartridge into the original protective bag or wrap it with a thick cloth.
- When storing the toner cartridge, do not store it upright or upside down. The toner will solidify and may not return to its original condition even if it is shaken.

* Even within the storable humidity range, water droplets (condensation) may develop inside the toner cartridge if there is a difference of temperature inside and outside the toner cartridge. Condensation will adversely affect the print quality of toner cartridges.

Do not store the toner cartridge in the following locations

- Locations exposed to open flames
- Locations exposed to direct sunlight or bright light for five minutes or more
- Locations exposed to excessive salty air
- Locations where there are corrosive gases (i.e. aerosol sprays and ammonia)
- Locations subject to high temperature and high humidity
- Locations subject to dramatic changes in temperature and humidity where condensation may easily occur
- Locations with a large amount of dust
- Locations within the reach of children

Be careful of counterfeit toner cartridges

Please be aware that there are counterfeit Canon toner cartridges in the marketplace. Use of counterfeit toner cartridge may result in poor print quality or machine performance. Canon is not responsible for any malfunction, accident or damage caused by the use of counterfeit toner cartridge.

For more information, see canon.com/counterfeit.

Availability period of repairing parts and toner cartridges

The repairing parts and toner cartridges for the machine will be available for at least seven (7) years after production of this machine model has been discontinued.

Toner cartridge packing materials

- Save the protective bag for the toner cartridge. They are required when transporting this machine.
- The packing materials may be changed in form or placement, or may be added or removed without notice.
- Dispose of the removed sealing tape according to local regulations.

When disposing of a used toner cartridge

Place the toner container into its protective bag to prevent the toner from scattering, and then dispose of the toner cartridge according to local regulations.

Basic Operations

Basic Operations	14
Parts and Their Functions	17
Front Side	18
Back Side	20
Interior	22
Manual Feed Slot	23
Paper Drawer	24
Operation Panel	25
Display	28
Customizing the <Home> Screen	33
Using the Display	35
Entering Text	38
Placing Documents	41
Loading Paper	45
Loading Paper in the Paper Drawer	47
Loading Paper in the Manual Feed Slot	50
Loading Envelopes	52
Loading Preprinted Paper	54
Specifying Paper Size and Type	56
Registering a Custom Paper Size	58
Registering in the Address Book	60
Registering Destinations in the Address Book	61
Registering Destinations for One-Touch Dial	65
Registering Multiple Destinations for Group Dial	69
Adjusting the Volume	72
Entering Quiet Mode	74
Entering Sleep Mode	76

Basic Operations

14L7-006

This chapter describes basic operations, such as how to use the operation panel or how to load the paper and documents, that are frequently performed to use the functions of the machine.

■ Parts and Their Functions

This section describes the exterior and interior parts of the machine and their functions, as well as how to use the keys on the operation panel and how to view the display. ▶ **Parts and Their Functions(P. 17)**



■ Using the Display

This section describes how to toggle the display and select items. ▶ **Using the Display(P. 35)**

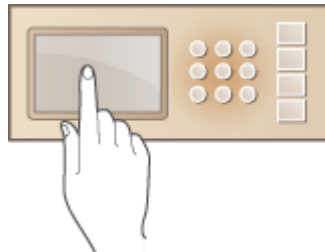

■ Entering Text

This section describes how to enter characters and numbers for registering destinations to the Address Book, sending faxes, etc. ▶ **Entering Text(P. 38)**

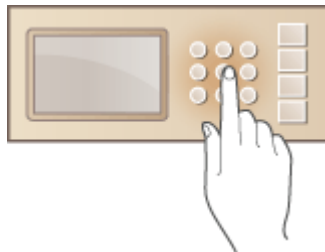

■ Placing Documents

This section describes how to place documents on the platen glass and in the feeder. ▶ **Placing Documents(P. 41)**



■ Loading Paper

This section describes how to load the paper into the paper drawer and manual feed slot. ▶ **Loading Paper(P. 45)**

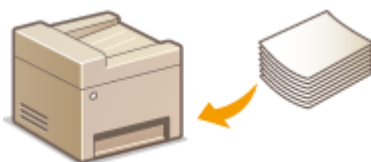

■ Registering in the Address Book

This section describes how to register destinations for sending faxes or scanned documents. ▶ **Registering in the Address Book(P. 60)**

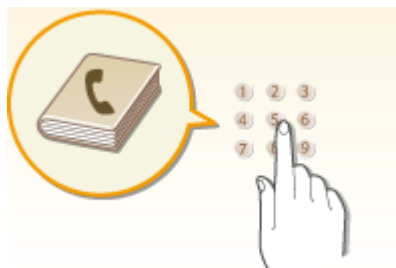

■ Adjusting the Volume

This section describes how to adjust the volume of various machine sounds, such as those produced when fax sending is complete or when an error occurs. ▶ **Adjusting the Volume(P. 72)**



■ Entering Quiet Mode

This section describes how to place the machine in quiet mode to reduce operation sound. ▶ **Entering Quiet Mode(P. 74)**



■ Entering Sleep Mode

This section describes how to set the sleep mode. ▶ **Entering Sleep Mode(P. 76)**



Parts and Their Functions

14L7-007

This section describes the parts of the machine (exterior, front and back side, and interior) and how they function. In addition to describing the parts of the machine used for such basic operations as placing documents, loading paper, and replacing the toner cartridges, this section also describes the keys on the operation panel and display. Read this section for tips on how to use the machine properly.



- ▶ **Front Side(P. 18)**
- ▶ **Back Side(P. 20)**
- ▶ **Interior(P. 22)**
- ▶ **Manual Feed Slot(P. 23)**
- ▶ **Paper Drawer(P. 24)**
- ▶ **Operation Panel(P. 25)**

Front Side

14L7-008

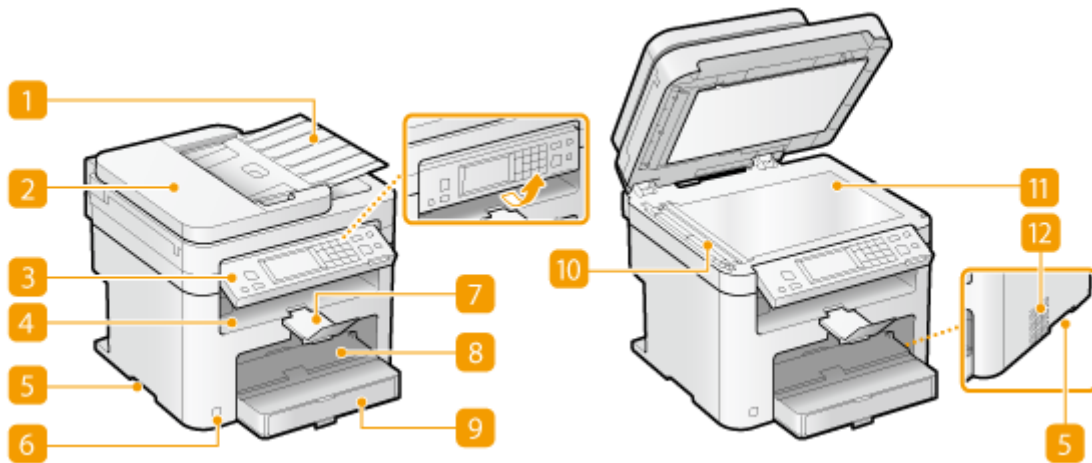

1 Document feeder tray

Open to load an original in the feeder. ▶ **Placing Documents(P. 41)**

2 Feeder

Automatically feeds documents into the machine for scanning. When two or more sheets are loaded in the feeder, documents can be scanned continuously. ▶ **Placing Documents(P. 41)**

3 Operation panel

The operation panel consists of keys such as the numeric keys and [Start] key, a display, and status indicators. You can perform all the operations and specify settings from the operation panel. You can move it up or down so it is easier to operate. ▶ **Operation Panel(P. 25)** ▶ **Display(P. 28)**

4 Output tray

Printed paper is output to the output tray.

5 Lift handles

Hold the lift handles when carrying the machine. ▶ **Relocating the Machine(P. 605)**

6 Power switch

Turns the power ON or OFF. To restart the machine, turn OFF the machine, wait for at least 10 seconds, and turn it back ON.

7 Paper stopper

Prevents paper that has been output after printing from falling.

8 Manual feed slot

Load the paper into the manual feed slot when you want to temporarily use a type of paper different from that which is loaded in the paper drawer. ▶ **Loading Paper in the Manual Feed Slot(P. 50)**

9 Paper drawer

Load the type of paper you frequently use into the paper drawer. ▶ **Loading Paper in the Paper Drawer(P. 47)**

10 Scanning area

Documents loaded in the feeder are automatically fed to the scanning area for scanning.

11 Platen glass

Place documents to scan on the platen glass. Also, use the platen glass to place thick or bound documents such as books when they cannot be loaded in the feeder. ▶ **Placing Documents(P. 41)**

12 Ventilation slots (MF249dw / MF246dn)

Air from inside the machine is vented out to cool down the inside of the machine. Note that placing objects in front of the ventilation slots prevents ventilation. ▶ **Installation(P. 3)**

Back Side

14L7-009

MF249dw / MF246dn

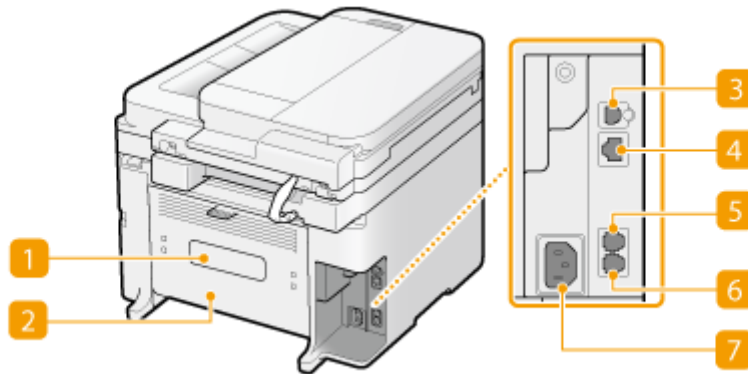

MF237w / MF235

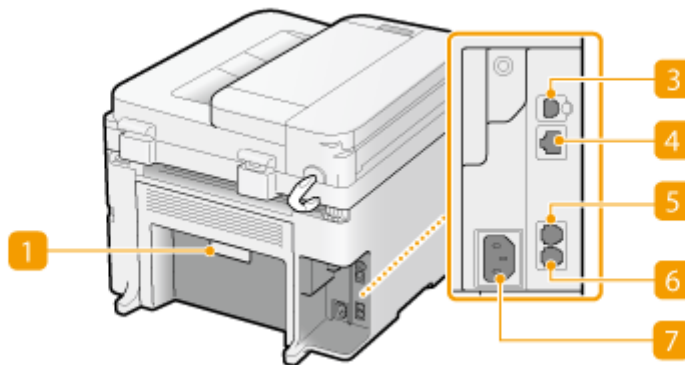

1 Rating label

The label shows the serial number, which is needed when making inquiries about the machine. ▶ **When a Problem Cannot Be Solved(P. 585)**

2 Rear cover

Open the rear cover when clearing paper jams. ▶ **Clearing Jams(P. 540)**

3 USB port

Connect a USB cable when connecting the machine and a computer. For connection steps, see "Getting Started". ▶ **Manuals Included with the Machine(P. 656)**

4 LAN port (MF249dw / MF246dn / MF237w)

Connect a LAN cable when connecting the machine to a wired LAN router, etc. For connection steps, see "Getting Started". ▶ **Manuals Included with the Machine(P. 656)**

5 External telephone jack

Connect an external telephone or the optional handset. ▶ **Connecting the Telephone Line(P. 112)**

6 Telephone line jack

Connect a telephone cable when connecting the machine to a telephone line. ▶ **Connecting the Telephone Line(P. 112)**

7 Power socket

Connect the power cord. For connection steps, see "Getting Started". ▶ **Manuals Included with the Machine(P. 656)**

Interior

14L7-00A

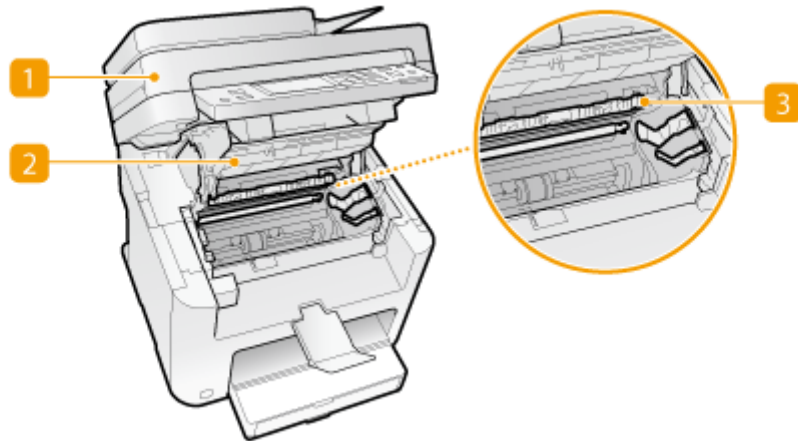

1 Operation panel

Lift this panel to replace the toner cartridges or clear paper jams. ▶ [How to Replace Toner Cartridges\(P. 602\)](#) ▶ [Clearing Jams\(P. 540\)](#)

2 Toner cover

Open this cover to replace the toner cartridges or clear paper jams. ▶ [How to Replace Toner Cartridges\(P. 602\)](#) ▶ [Clearing Jams\(P. 540\)](#)

3 Paper exit guide

Open this guide to clear paper jams. ▶ [Clearing Jams\(P. 540\)](#)

LINKS

▶ [How to Replace Toner Cartridges\(P. 602\)](#)

Manual Feed Slot

14L7-00C

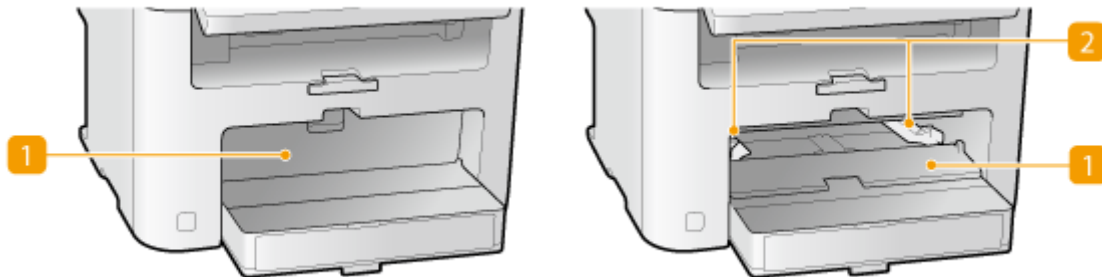

1 Manual feed cover

Open this slot to load paper in the manual feed slot.

2 Paper guides

Adjust the paper guides to exactly the width of the loaded paper to ensure that paper is fed straight into the machine.

LINKS

▶ [Loading Paper in the Manual Feed Slot\(P. 50\)](#)

Paper Drawer

14L7-00E

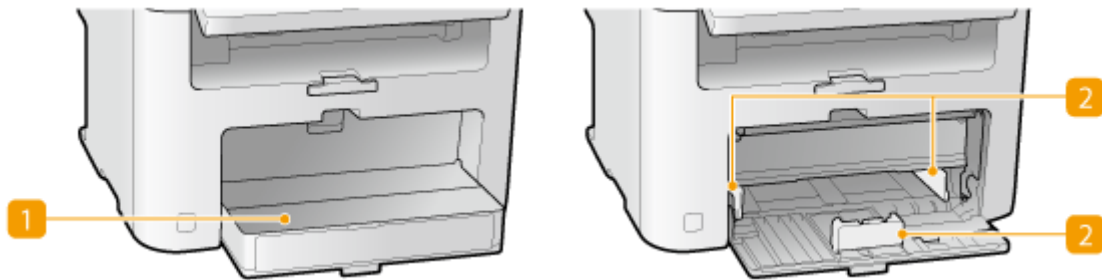

1 Dust cover

Open this cover to load paper in the paper drawer.

2 Paper guides

Adjust the paper guides to exactly the size of the loaded paper to ensure that paper is fed straight into the machine.

LINKS

▶ [Loading Paper in the Paper Drawer\(P. 47\)](#)

Operation Panel

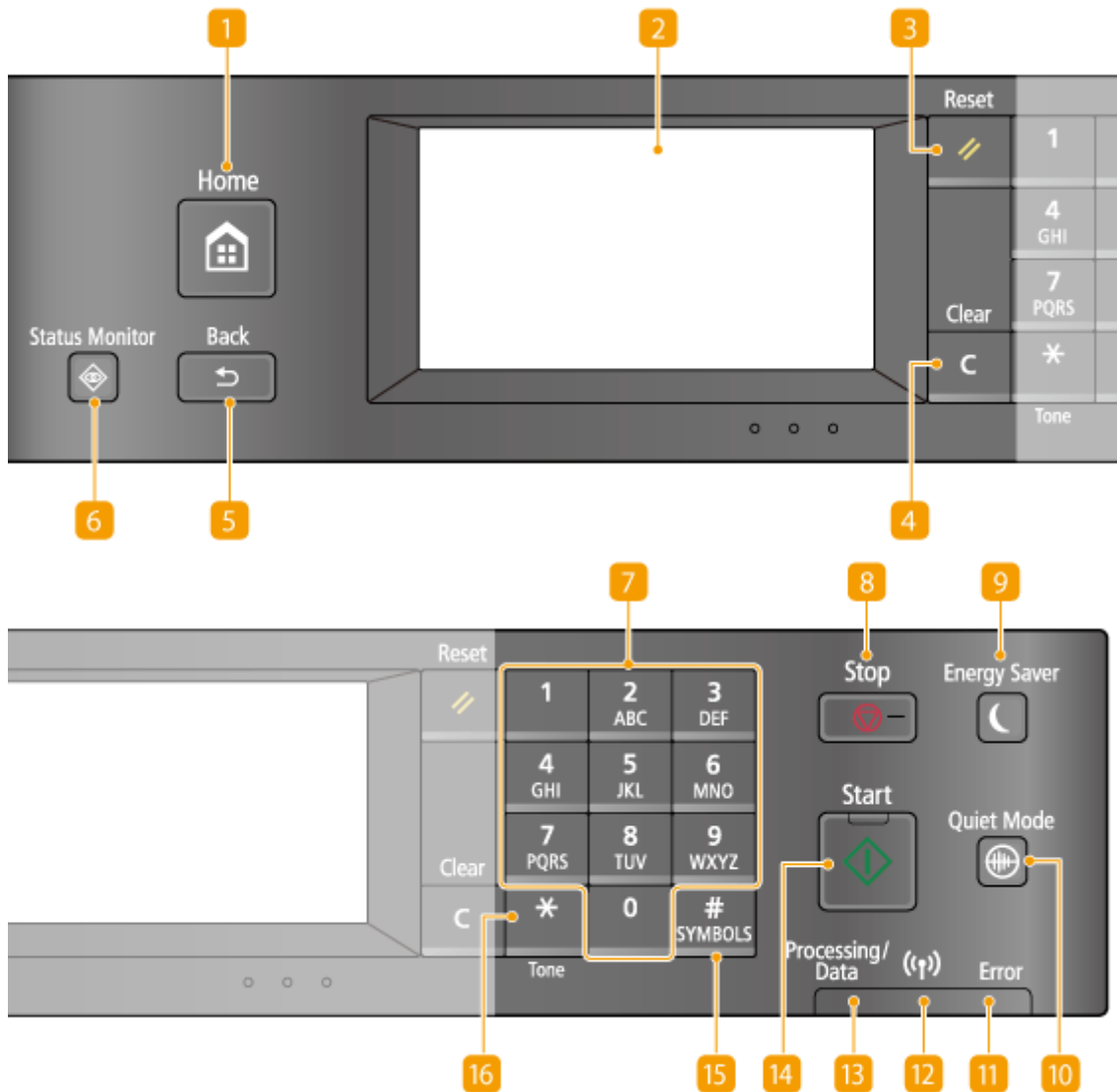

1 [Home] key

Press to display the <Home> Screen. ▶ **Customizing the <Home> Screen(P. 33)**

2 Display

You can view the progress of copy, fax, and other jobs and error statuses. The display is a touch panel, allowing you to operate the screen by touch to specify settings. ▶ **Display(P. 28)** ▶ **Using the Display(P. 35)**

3 [Reset] key

Press to cancel the settings and restore the previously specified settings.

4 [Clear] key

Press to delete the entered numbers and text.

5 [Back] key

Press to return to the previous screen. If you press this key when specifying settings, for example, the settings are not applied and the display returns to the previous screen.

6 [Status Monitor] key

Press to check the status of printing or faxing, to view the usage history, or to view the network settings such as the IP address of the machine. You can also check the status of the machine, such as the paper size and the amount remaining in the toner cartridges, or whether any errors occurred. ▶ **Display(P. 28)**

7 Numeric keys ([0]-[9] keys)

Press to enter numbers and text. ▶ **Entering Text(P. 38)**

8 [Stop] key

Press to cancel copying, faxing, and other operations.

9 [Energy Saver] key

Press to put the machine into sleep mode. The key lights up green when the machine is in sleep mode. Press the key again to exit sleep mode. ▶ **Entering Sleep Mode(P. 76)**

10 [Quiet Mode] key

Press to put the machine into quiet mode. While in quiet mode this key is lit in green. Press the key again to exit quiet mode. ▶ **Entering Quiet Mode(P. 74)**

11 [Error] indicator

Blinks or lights up when an error such as a paper jam occurs.

12 Wi-Fi indicator (MF249dw / MF237w)

Lights up when the machine is connected to wireless LAN.

13 [Processing/Data] indicator

Blinks while operations such as sending or printing are being performed. Lights up when there are documents waiting to be processed.

14 [Start] key

Press to scan or copy documents.

15 [#] key

Press to enter symbols such as "@" or "/".

16 [*] key

- Press to switch the type of text that is entered.
- Press to use tone dialing such as when receiving fax information services. ▶ **Receiving Fax Information Services(P. 161)**

LINKS

▶ **Using the Display(P. 35)**

Display

14L7-00H

The <Home> Screen for initiating operations and screens for specifying settings appear in the display. You can also view job progress and messages here. Touch the display to operate it.

<Home> Screen

The <Home> Screen is displayed when the power is turned ON or by pressing  on the operation panel. Use this screen to specify settings for and register functions.

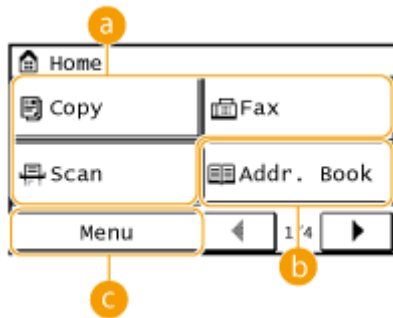

a Toggle functions

Switch to copy, fax, or scan functions. [▶ Copying\(P. 79\)](#) [▶ Faxing\(P. 103\)](#) [▶ Using the Machine as a Scanner\(P. 232\)](#)

b <Addr. Book>

Use this to register or edit the destinations for e-mails and faxes. You can also display a registered destination when sending an e-mail or fax. [▶ Registering in the Address Book\(P. 60\)](#)

c <Menu>

<Timer Settings>, <Preferences>, and many other machine settings start from this button. [▶ Setting Menu List\(P. 472\)](#)

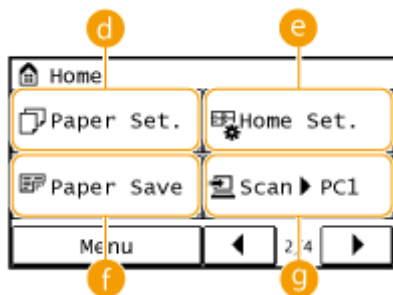

d <Paper Set.>

Select the paper for printing. This button is also used for specifying the size and type of paper loaded in the paper drawer and manual feed slot. [▶ Specifying Paper Size and Type\(P. 56\)](#)

e <Home Set.>

Allows you to change the order that <Home> Screen buttons are displayed in. [▶ Customizing the <Home> Screen\(P. 33\)](#)

f <Paper Save>

Settings are preregistered for economically copying 2 pages (or 4 pages) reduced on a single sheet. ▶ **Using the <Paper Save> Button(P. 96)**

g <Scan -> PC1> / <Scan -> PC2>

By registering scan settings beforehand, you can simply tap this button to start a scan. ▶ **Scanning Using the <Scan -> PC> Button(P. 237)**

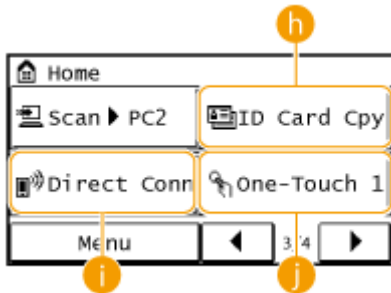
**h <ID Card Cpy>**

Settings are preregistered for copying the front and back sides of a driver's license or other ID card onto the same side of a page at actual size. ▶ **Copying Both Sides of an ID Card onto One Page(P. 98)**

i <Direct Conn> (MF249dw / MF237w)

Use this to establish a direct wireless connection to a mobile device. ▶ **Make Direct Connection (Access Point Mode) (MF249dw / MF237w)(P. 291)**

j <One-Touch 1> to <One-Touch 4>

If you register destinations beforehand as One-Touch Dial numbers, they can be quickly displayed. ▶ **Specifying Destinations with the One-Touch Buttons(P. 127)**

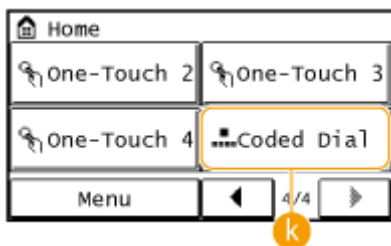
**k <Coded Dial>**

If you register destinations beforehand as coded dial numbers, they can be quickly displayed by simply entering a three-digit number. ▶ **Registering in the Address Book(P. 60)**

<Status Monitor> Screen

When you press , a screen is displayed that enables you to check the status of documents that are being printed, sent, or received, as well as the status of the machine (amount remaining in the toner cartridge, etc.) and the network setting information such as the IP address of the machine.

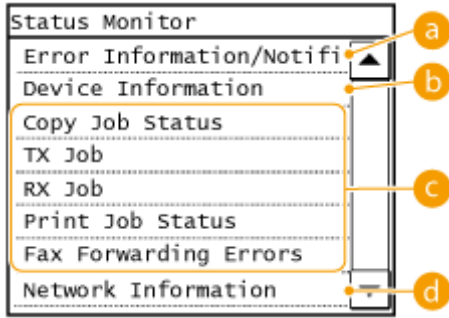

a <Error Information/Notification>

Displays the details of any errors that occurred. ▶ **When an Error Message Appears(P. 548)**

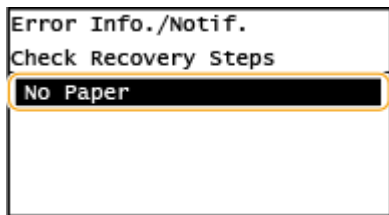

b <Device Information>

Displays the status of the machine, such as the paper size or the amount remaining in the toner cartridges.

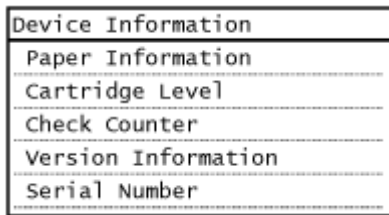

<Paper Information>

Displays the paper size specified in each paper source.

<Cartridge Level>

Displays the amount remaining in the toner cartridges. Other internal parts may reach the end of their lifetime before the toner runs out.

<Check Counter>

Displays the totals for printouts. ▶ **Viewing the Counter Value(P. 620)**

c Status of copy/print/send/receive jobs

Displays the current status of the selected item. The <Copy Job Status> screen is shown below as an example.

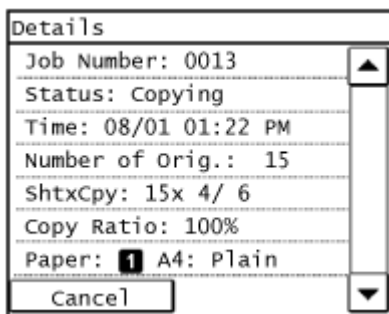

d <Network Information> (MF249dw / MF246dn / MF237w)

Displays the network settings such as the IP address of the machine and status such as the condition of wireless LAN communications.

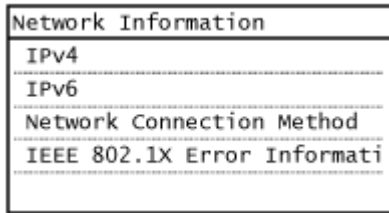

Viewing Network Settings(P. 344)

When a Message Is Displayed

Messages are displayed at the top of the screen in situations such as when end of toner cartridge lifetime is reached or when a cover is left open. The display alternates between showing the normal screen and the message.

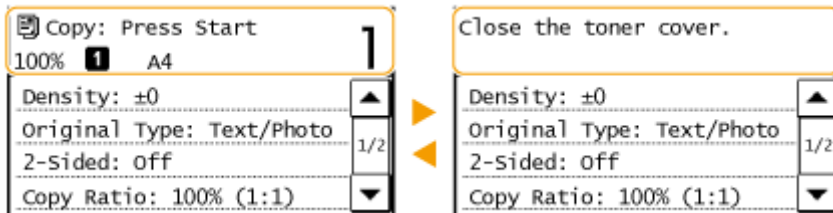

When an Error Message Appears(P. 548)

NOTE

When <You have notifications.> or <Tap Icon on Right ->> Is Displayed

Tap **i** to view the notification.

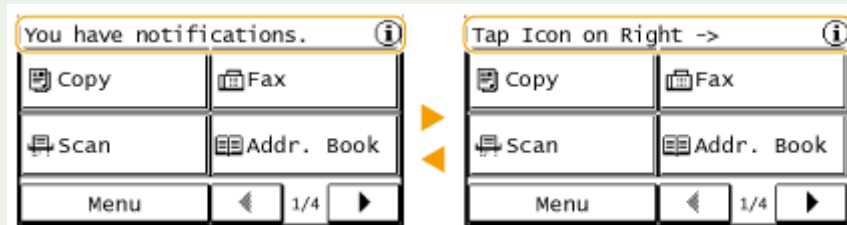

When an Error Occurs

In some cases when an error occurs, instructions on how to respond to the error are displayed. Follow the on-screen instructions to solve the problem. The screen displayed when a paper jam occurs is shown below as an example (**When an Error Message Appears(P. 548)**).

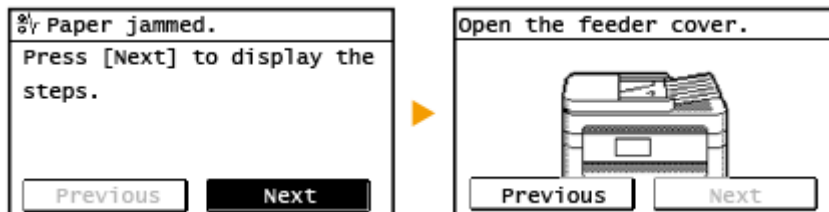

LINKS

Customizing the <Home> Screen(P. 33)

▶ **Using the Display(P. 35)**

Customizing the <Home> Screen

14L7-00J

You can change the order that buttons in the <Home> screen are displayed in according to your application or a preferred arrangement.

■ Changing the Home Screen Button Display Order

1 Press and tap <Home Set.>.

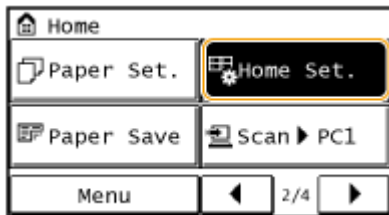

- If a screen appears prompting you to enter a PIN, enter the correct PIN using the numeric keys, and tap <Apply>. [▶ Setting the System Manager PIN\(P. 397\)](#)

2 Tap <Set Display Order>.

3 Tap the button to move.

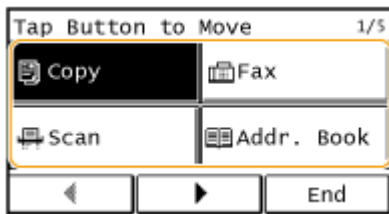

4 Tap <Previous> or <Next> to move the button, and tap <Apply>.

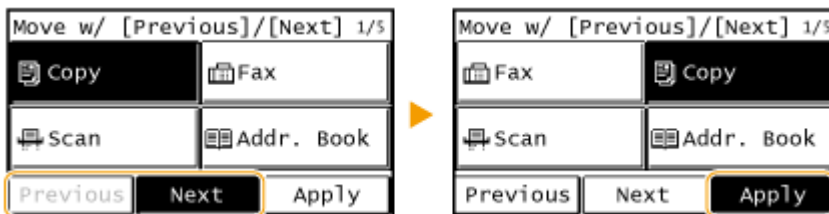



5 Repeat steps 3 and 4 to move all buttons you want to move.

6 Tap <End>.

■ To Insert Blanks in <Home> Screen

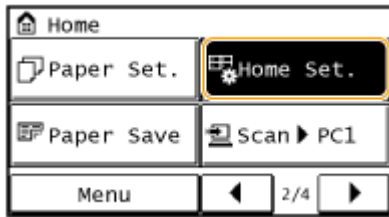
1 Press and tap <Home Set.>.



- If a screen appears prompting you to enter a PIN, enter the correct PIN using the numeric keys, and tap <Apply>.  **Setting the System Manager PIN(P. 397)**

2 Tap <Insert and Delete Blank>.

3 Tap the button where you want to insert a blank, and tap <Insert>.

- To delete an inserted blank, select the blank, tap <Delete>, and proceed to step 5.

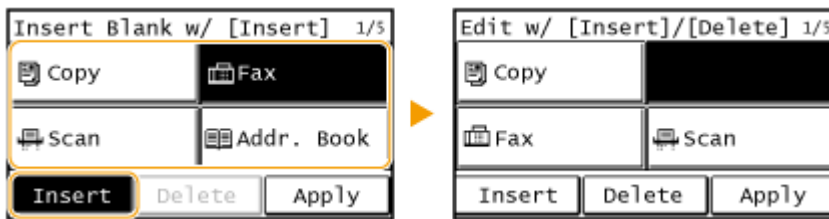

4 Tap <Apply>.

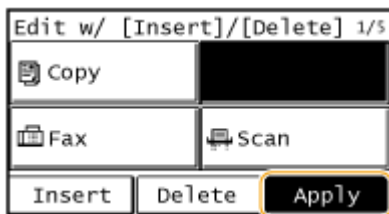

5 Tap <End>.

LINKS

-  **Display(P. 28)**

Using the Display

14L7-00K

The display is a touch panel, allowing you to operate directly on the screen.

IMPORTANT

Avoid the following actions.

The display may malfunction or be damaged.

- Pressing forcefully
- Pressing with pointed objects (fingernails, ballpoint pen, pencil, etc.)
- Operating with wet/soiled hands
- Operating the display while an object is placed on it

Tap

Touch the screen lightly and quickly. Use for selecting or finalizing items.

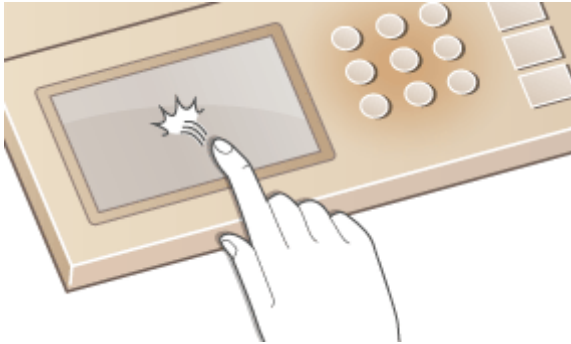

Long Touch

Keep finger held on the screen. When text cannot be completely displayed on one line ("..." appears), touch and hold the line to scroll all of the text. Also continuously increases/decreases the copy magnification.

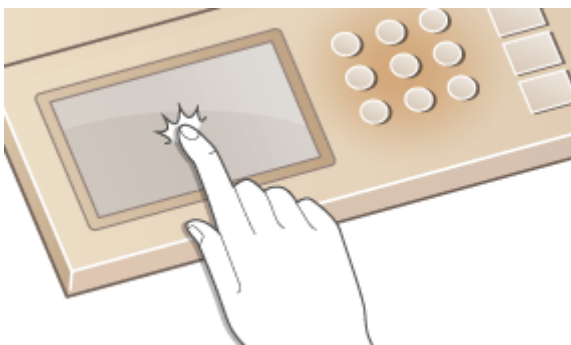

■ Selecting items

Tap an item name or button to make a selection.

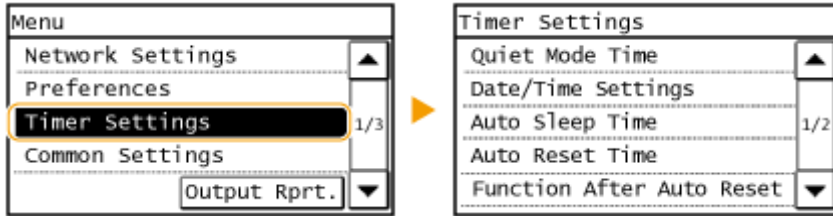

NOTE

If an item is mistakenly touched

Slide your finger away then release it from the screen to cancel the selection.

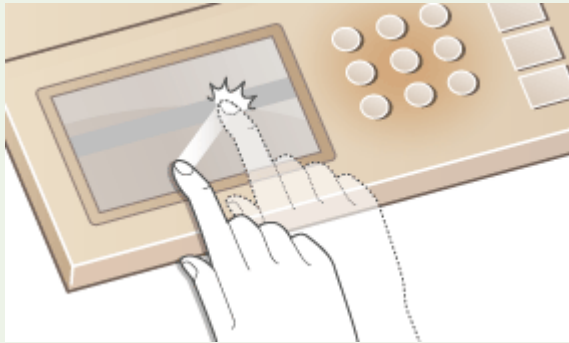

To return to the previous screen

Press  to return to the previous screen.

■ **Scrolling the screen**

The scroll bar is displayed on the screen when there is still information that is undisplayed. If the scroll bar is displayed, tap ▲ / ▼ to scroll the screen. The screen changes page by page, and the page number is displayed in the scroll bar.

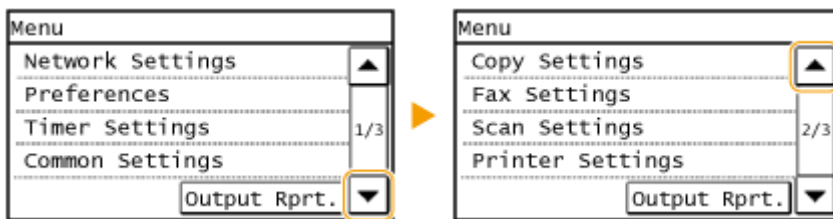

■ **Changing values and settings**

Changing values

Tap ▲ / ▼ to enter values. If an icon such as below is displayed at the upper left of the screen, you can enter values directly using the numeric keys.

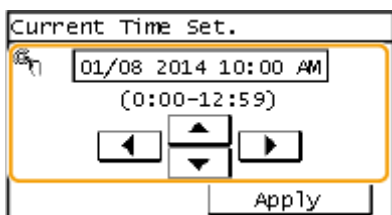

NOTE**To move the cursor**

When ◀ / ▶ is displayed, tap to move the cursor.

Changing setting values

To adjust a value on a scale, tap <-> / <+>.

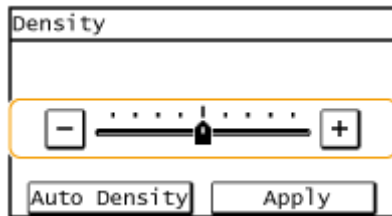
**TIPS**

- You can change a variety of display-related settings, such as the scrolling speed or display language:
 - ▶ **Display Settings(P. 485)**
- To change the screen that is automatically displayed when the machine remains idle for a specified length of time:
 - ▶ **Function After Auto Reset(P. 491)**

Entering Text

Use the display and numeric keys to enter text and values.

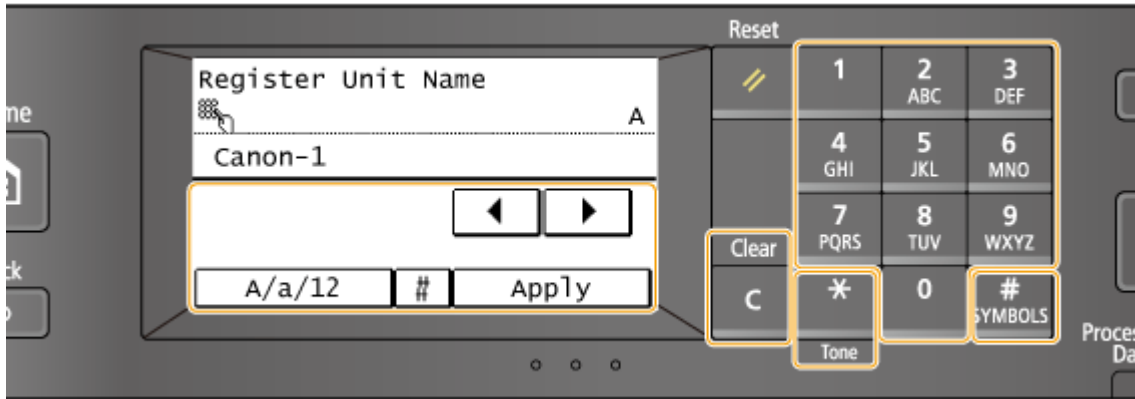

Switching the Type of Text

Tap <A/a/12> to switch the type of text that is entered. The currently selected type of text is indicated by the "A", "a", or "12" displayed above and to the right of the text input field.

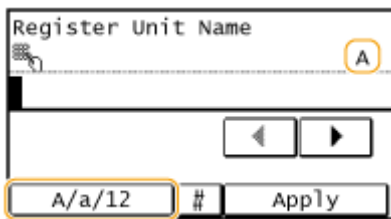









NOTE

You can also press  to switch the type of text.

Types of Text That Can Be Entered

Enter text with the numeric keys and the display. Text that can be entered is listed below.



Key	A	a	12
	@ . - _ /		1
	ABC	abc	2
	DEF	def	3
	GHI	ghi	4

	JKL	jkl	5
	MNO	mno	6
	PQRS	pqrs	7
	TUV	tuv	8
	WXYZ	wxyz	9
	(Not available)		0
	(space) - . * # ! " , ; : ^ ` _ = / ' ? \$ @ % & + \ ~ () [] { } < >	(Not available)	



NOTE

Press  or tap <#> when the type of text that is entered is <A> or <a> to display enterable symbols in the screen. Tap symbols to enter.

Deleting Text









One character is deleted each time  is pressed. Press and hold  to delete all of the entered text.

Moving the Cursor (Entering a Space)

Tap  or  to move the cursor. To enter a space, move the cursor to the end of the text, and tap .

Example of Entering Text and Numbers

Example: "Canon-1"

- 1** Tap <A/a/12> (or press ) repeatedly until <A> is selected.
- 2** Press  repeatedly until the letter "C" is selected.
- 3** Tap <A/a/12> (or press ) repeatedly until <a> is selected.
- 4** Press  repeatedly until the letter "a" is selected.
- 5** Press  repeatedly until the letter "n" is selected.
- 6** Press  repeatedly until the letter "o" is selected.
- 7** Press  repeatedly until the letter "n" is selected.
- 8** Press  repeatedly until the symbol "-" is selected.
- 9** Tap <A/a/12> (or press ) repeatedly until <12> is selected.

10 Press **1**.

11 Tap <Apply>.

Placing Documents

Place documents on the platen glass or in the feeder. Use the platen glass when scanning thick or bound documents such as books. You can load two or more sheets of documents in the feeder so that they can be scanned continuously. For information about the types of documents that can be placed on the platen glass or in the feeder, and information about the scannable area of a document, see [Document Type\(P. 645\)](#) or [Scan Area\(P. 646\)](#) .



▶ [Placing Documents on the Platen Glass\(P. 41\)](#)

▶ [Placing Documents in the Feeder\(P. 42\)](#)

IMPORTANT

Use documents that are completely dry

When placing documents, make sure that any glue, ink, or correction fluid on the documents has completely dried.

To avoid paper jams

Do not place the following types of documents in the feeder as this may cause paper jams:

- Wrinkled or creased paper
- Carbon paper or carbon-backed paper
- Curled or rolled paper
- Coated paper
- Torn paper
- Onion skin or thin paper
- Stapled or clipped documents
- Paper printed by a thermal transfer printer
- Transparencies



NOTE

To scan documents more accurately

Documents placed in the feeder are scanned while being fed into the machine. On the other hand, documents placed on the platen glass remain in a fixed position while they are scanned. To ensure more accurate scanning results, placing documents on the platen glass is recommended.

To scan tracing paper or transparencies

To scan transparent documents (for example, tracing paper or transparencies), place them on the platen glass.

Placing Documents on the Platen Glass

- 1 **Open the feeder.**

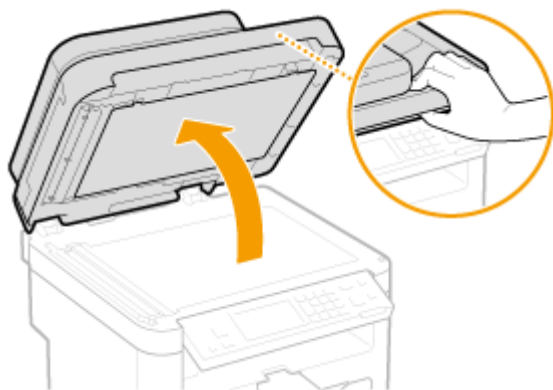

2 Place the document face down on the platen glass.

- Align the corner of the document with the top-left corner of the platen glass.

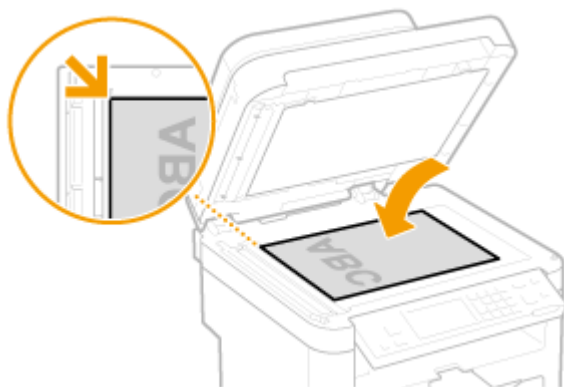

NOTE:

To scan transparent documents (for example, tracing paper or transparencies), cover them with plain white paper.

3 Gently close the feeder.

- The machine is ready to scan the document.
- When scanning is complete, remove the document from the platen glass.

Placing Documents in the Feeder

1 Open the document feeder tray.

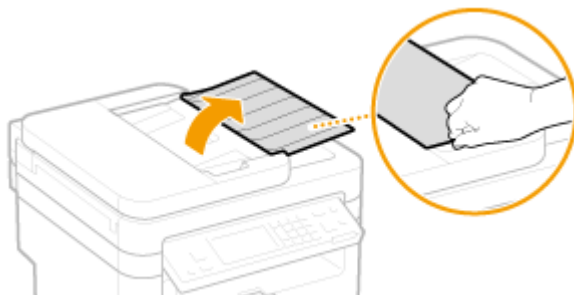

2 Spread the document guides apart.

- Slide the document guides outward until they are slightly farther apart than the actual document width.



3 Fan the document stack and align the edges.

- Fan the document stack in small batches, and align the edges by lightly tapping the stack on a flat surface a few times.



4 Place the document(s) face up in the feeder.

- Make sure that the document stack does not exceed the load limit guide (a).

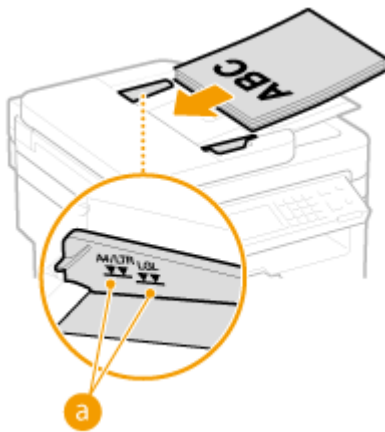

IMPORTANT:

- Do not load documents of various sizes at the same time.
- Up to 50 sheets* can be loaded at a time. If 50 or more sheets are loaded, scanning may stop or a paper jam may occur.

*For MF246dn / MF237w / MF235, up to 35 sheets.

5 Align the document guides against the edges of the document.

- Slide the document guides inward until they are aligned securely against the edges of the document.



- The machine is ready to scan the document.

IMPORTANT:

Align the document guides securely against the edges of the document

Document guides that are too loose or too tight can cause misfeeds or paper jam.

While documents are being scanned

Do not add or remove documents.

When scanning is complete

Remove the scanned documents from beneath the feeder to prevent paper jams.

Loading Paper

You can load the paper into the paper drawer or manual feed slot. Load the paper you usually use into the paper drawer. The paper drawer is convenient when using large amounts of paper. Use the manual feed slot when you temporarily use size or type of paper that is not loaded in the paper drawer. See **Paper(P. 647)** for available paper sizes.

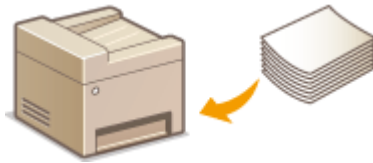

Paper Type and Setting for the Machine

See the table below to specify the paper settings according to the type and weight of the paper to load into the paper source. For more information about how to specify the paper settings on the machine, see **Specifying Paper Size and Type(P. 56)** . For the amount of paper that can be loaded in each paper source, see **Paper(P. 647)** .

Paper Type	Paper Weight	Paper Setting on the Machine
Plain paper	60 to 89 g/m ²	<Plain (60-89 g/m ²)>
		<Plain L (60-89 g/m ²)>*
Recycled paper	60 to 89 g/m ²	<Recycled (60-89 g/m ²)>
Color paper	60 to 89 g/m ²	<Color (60-89 g/m ²)>
Heavy paper	90 to 120 g/m ²	<Heavy 1 (90-120 g/m ²)>
	121 to 163 g/m ²	<Heavy 2 (121-163 g/m ²)>
Bond paper	60 to 90 g/m ²	<Bond 1 (60-90 g/m ²)>
	91 to 120 g/m ²	<Bond 2 (91-120 g/m ²)>
	121 to 163 g/m ²	<Bond 3 (121-163 g/m ²)>
Envelope	—	<Envelope>
Label	—	<Labels>
Index card	—	<Index Card>

* If set to <Plain (60-89 g/m²)> and that printout is curled, specify <Plain L (60-89 g/m²)> and print again.

IMPORTANT

Do not use the following types of paper:

- Wrinkled or creased paper
- Curled or rolled paper
- Torn paper
- Damp paper

- Very thin paper
- Paper printed by a thermal transfer printer
- Highly textured paper
- Glossy paper

Paper handling and storage

- Store the paper on a flat surface.
- Keep the paper wrapped in its original package to protect the paper from moisture or dryness.
- Do not store the paper in such a way that may cause it to curl or fold.
- Do not store the paper vertically or stack too much paper.
- Do not store the paper in direct sunlight, or in a place subject to high humidity, dryness, or drastic changes in temperature or humidity.

NOTE

When printing on paper that has absorbed moisture

Steam may emit from the paper output area, or water droplets may form on the back side of the operation panel or around the paper output area. There is nothing unusual about any of these occurrences, which occur when the heat generated from fixing toner on the paper causes moisture in the paper to evaporate (most likely to occur at low room temperatures).

LINKS

▶ Registering a Custom Paper Size(P. 58)

Loading Paper in the Paper Drawer

14L7-00U

Load the paper that you usually use in the paper drawer. When you want to print on paper that is not loaded in the paper drawer, load the paper in the manual feed slot. **▶ Loading Paper in the Manual Feed Slot (P. 50)**

IMPORTANT

Make sure to load paper in portrait orientation

Paper cannot be loaded in landscape orientation. Make sure to load the paper in portrait orientation.

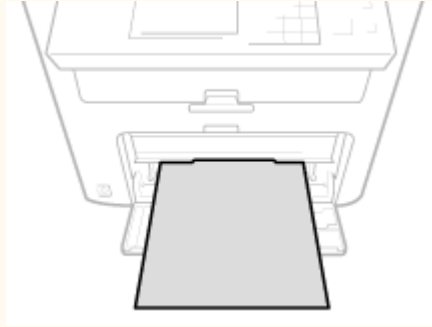

1 Lift the dust cover.

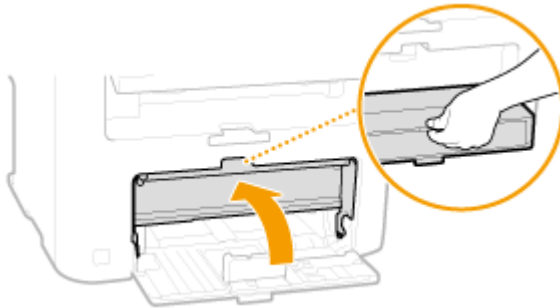

2 Slide the paper guides apart.

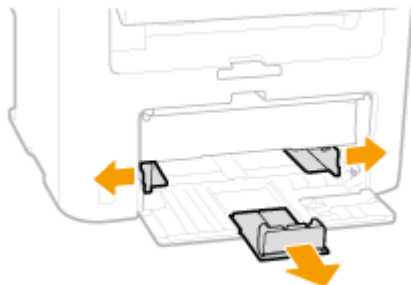

NOTE:

Size abbreviations on the paper guides

The abbreviations on the paper guides in the paper drawer indicate paper sizes as follows:

- LGL: Legal
- LTR: Letter
- STMT: Statement

- EXEC: Executive

3 Insert the paper into the paper drawer until the paper stops.

- Load the paper in portrait orientation (with the short edge toward the machine), with the print side face up. Paper cannot be loaded in landscape orientation.
- Fan the paper stack well, and tap it on a flat surface to align the edges.
- When you insert the paper with <Notify to Check Paper Settings> set to <On>, a confirmation screen is displayed. ▶ **Notify to Check Paper Settings(P. 486)**

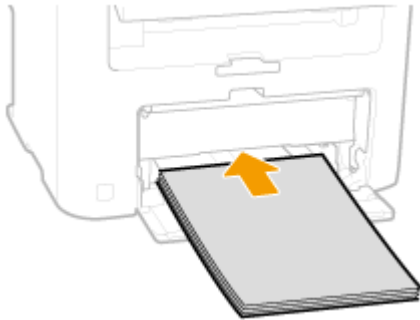

IMPORTANT:

Do not exceed the load limit guide when loading paper

Make sure that the paper stack does not exceed the load limit guide (a). Loading too much paper can cause paper jams.

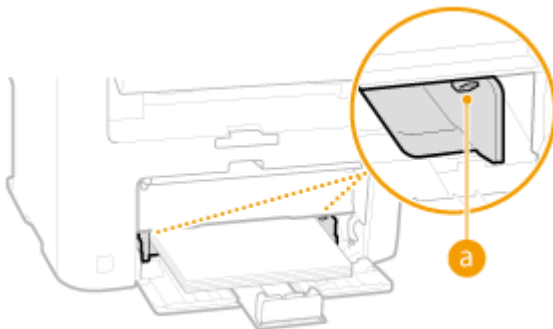

NOTE:

When loading envelopes or paper with a logo, see ▶ **Loading Envelopes(P. 52)** or ▶ **Loading Preprinted Paper(P. 54)** .

4 Align the paper guides against the edges of the paper.

- Move the paper guides in so they are exactly the width of the paper.



IMPORTANT:

Align the paper guides securely against the edges of the paper

Paper guides that are too loose or too tight can cause misfeeds or paper jams.

5 Lower the dust cover.

NOTE:

When Legal size paper is loaded

The paper guides at the rear edge of the paper will be extended. Open the dust cover extension, then lower the dust cover.

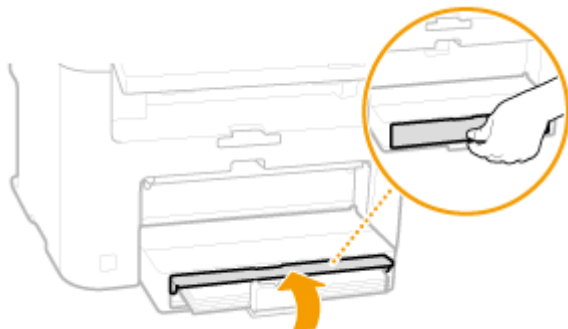

6 Pull out the paper stopper to open.

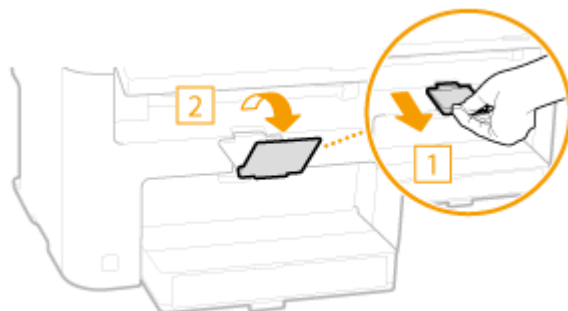

» Continue to » Specifying Paper Size and Type (P. 56)

IMPORTANT:

When changing the paper size or type

The factory default settings for paper size and type are <A4> and <Plain (60-89 g/m²)>, respectively. If you load a different size or type of paper into the machine, make sure to change the settings. If you do not change the settings, the machine cannot print properly.

Printing on the Back Side of Printed Paper (Manual 2-Sided Printing)

You can print on the back side of printed paper. Flatten any curls on the printed paper and insert it into the manual feed slot (» Loading Paper in the Manual Feed Slot (P. 50)), with the side to print face up (previously printed side face down).

- Load one sheet at a time per each print.
- You can use only the paper printed with this machine.
- You cannot print on the side that has previously been printed on.
- If you are using A5 paper, the reverse side may not be printed correctly.

LINKS

» Paper (P. 647)

Loading Paper in the Manual Feed Slot

14L7-00W

When you want to print on paper that is not loaded in the paper drawer, load the paper in the manual feed slot. Load the paper that you usually use in the paper drawer. **▶ Loading Paper in the Paper Drawer(P. 47)**

IMPORTANT

Make sure to load paper in portrait orientation

Paper cannot be loaded in landscape orientation. Make sure to load the paper in portrait orientation.

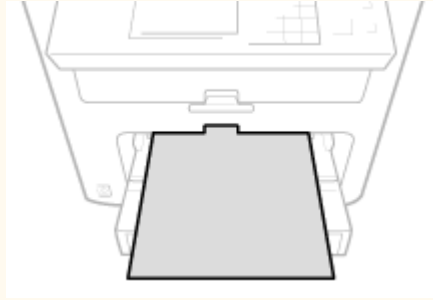

1 Open the manual feed cover.

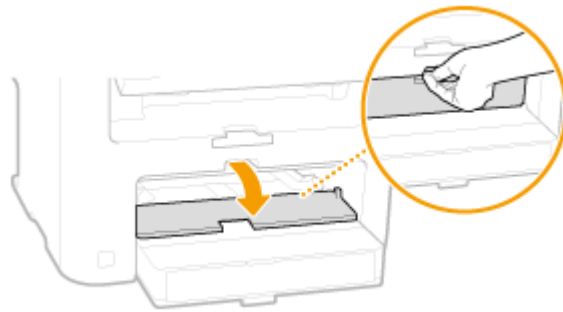

2 Spread the paper guides apart.

- Slide the paper guides outward.

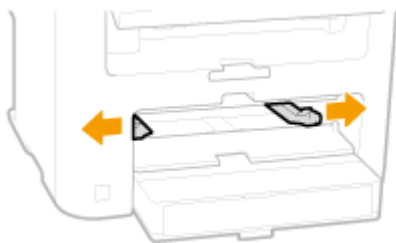

3 Insert the paper into the manual feed slot until the paper stops.

- Load the paper in portrait orientation (with the short edge toward the machine), with the print side face up. Paper cannot be loaded in landscape orientation.
- When you insert the paper with <Notify to Check Paper Settings> set to <On>, a confirmation screen is displayed. **▶ Notify to Check Paper Settings(P. 486)**

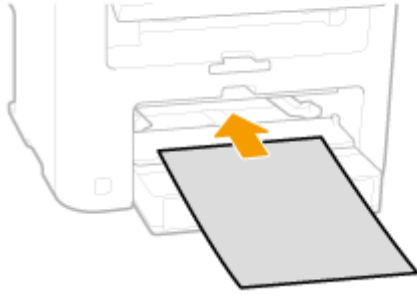

NOTE:

When loading envelopes or paper with a logo, see ▶**Loading Envelopes(P. 52)** or ▶**Loading Preprinted Paper(P. 54)** .

4 Align the paper guides against the edges of the paper.

- Slide the paper guides inward until they are aligned securely against the edges of the paper.

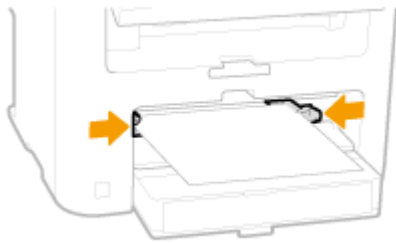

IMPORTANT:

Align the paper guides securely against the edges of the paper

Paper guides that are too loose or too tight can cause misfeeds or paper jams.

5 Pull out the paper stopper to open.

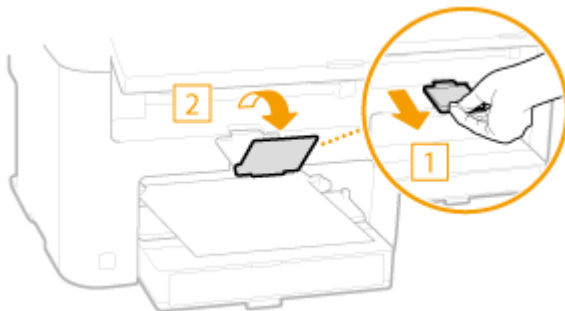

Continue to ▶**Specifying Paper Size and Type(P. 56)**

Loading Envelopes

14L7-00X

Make sure to flatten any curls on envelopes before loading them. Also pay attention to the orientation of envelopes and which side is face up.

▶ **Before Loading Envelopes(P. 52)**

▶ **Loaded Orientation(P. 53)**

NOTE

This section describes how to load envelopes in the orientation you want, as well as procedures that you need to complete before loading envelopes. For a description of the general procedure for loading envelopes in the paper drawer or manual feed slot, see ▶ **Loading Paper in the Paper Drawer(P. 47)** or ▶ **Loading Paper in the Manual Feed Slot(P. 50)** .

Before Loading Envelopes

Follow the procedure below to prepare the envelopes before loading.

NOTE

Only one envelope at a time can be loaded in the manual feed slot. Follow steps 1 to 4 in the procedure below to prepare the envelope for loading.

1 Close the flap of each envelope.



2 Flatten them to release any remaining air, and make sure that the edges are pressed tightly.



3 Loosen any stiff corners of the envelopes and flatten any curls.

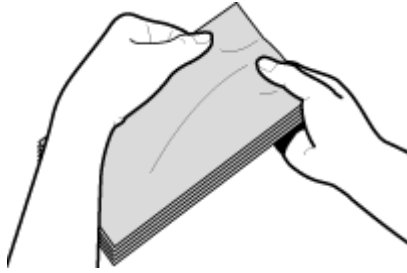

4 Align the edges of the envelope on a flat surface.

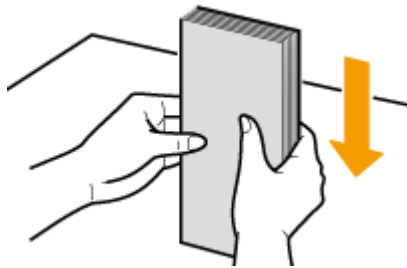

Loaded Orientation

Load the envelopes in portrait orientation, short edge first, with the non-glued side (front side) face up.

NOTE
Load envelopes in the same orientation for both the paper drawer and manual feed slot.

Load the envelopes so that their flaps are at the left.

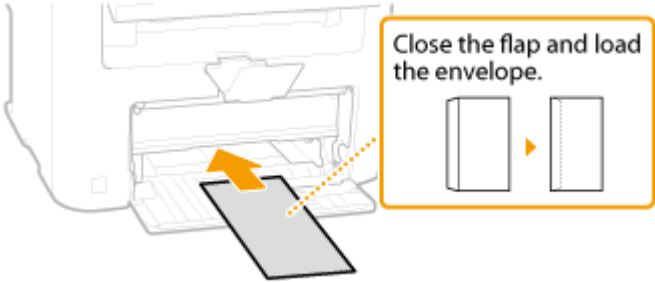

Loading Preprinted Paper

14L7-00Y

When you use paper that has been preprinted with a logo, pay attention to the orientation of the paper when loading. Load the paper properly so that printing is performed on the correct side of the paper with a logo.



- ▶ Making 1-Sided Printouts on Paper with Logos(P. 54)
- ▶ Making 2-Sided Printouts on Paper with Logos (MF249dw / MF246dn)(P. 55)

NOTE

This section mainly describes how to load preprinted paper with the proper facing and orientation. For a description of the general procedure for loading paper in the paper drawer or manual feed slot, see ▶ Loading Paper in the Paper Drawer(P. 47) or ▶ Loading Paper in the Manual Feed Slot(P. 50) .

Making 1-Sided Printouts on Paper with Logos

Load the paper with the logo side (the side to print the document) face up.

IMPORTANT

Load only one sheet of paper in the manual feed slot each time you print.

Printing on Paper with Logos in Portrait Orientation

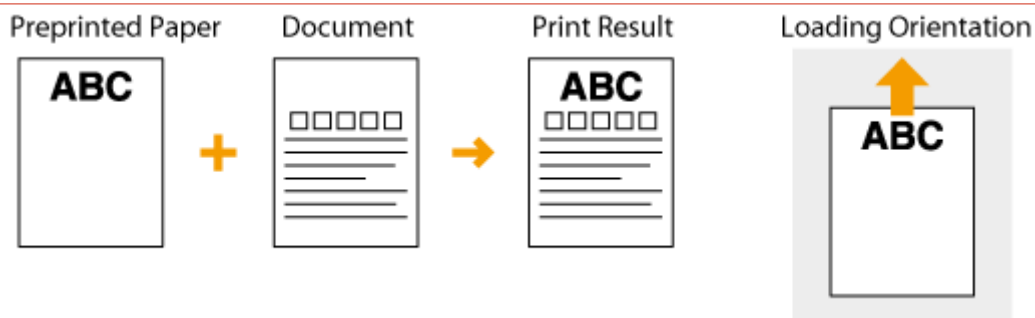

Printing on Paper with Logos in Landscape Orientation

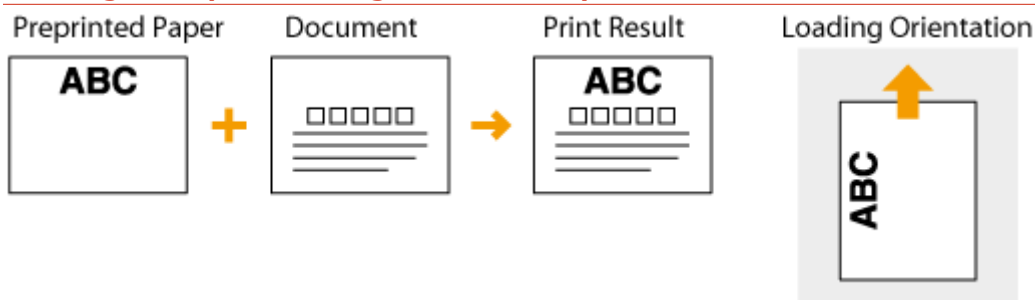

Making 2-Sided Printouts on Paper with Logos (MF249dw / MF246dn)

Load the paper with the front logo side (the side to print the first page of the document) face down.

Printing on Paper with Logos in Portrait Orientation

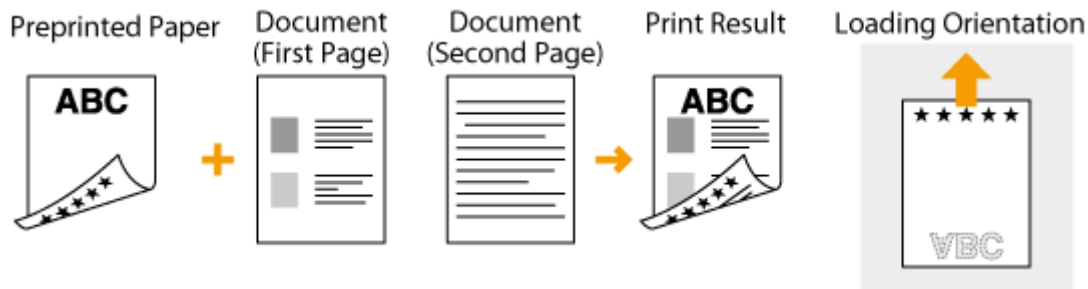

Printing on Paper with Logos in Landscape Orientation

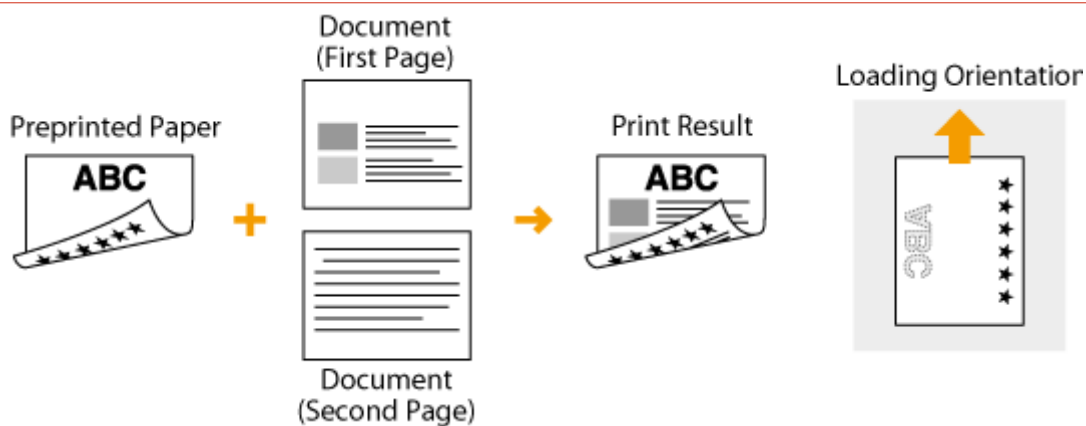

NOTE

The <Switch Paper Feed Method> setting (MF249dw / MF246dn)

When you print on preprinted paper, you need to change the facing of the paper to load each time you perform 1-sided and 2-sided printing. However, if <Switch Paper Feed Method> is set to <Print Side Priority>, the facing that you use for loading preprinted paper for 2-sided printing (logo side face down) can also be used for 1-sided printing. This setting is especially useful if you frequently perform both 1-sided and 2-sided printing. **Switch Paper Feed Method(P. 492)**

Specifying Paper Size and Type

14L7-010

You must specify the paper size and type settings to match the paper that is loaded. Make sure to change the paper settings when you load the paper that is different from the previously loaded paper.

IMPORTANT

If the setting does not match the size and type of loaded paper, a paper jam or printing error may occur.

- 1 Press  and tap <Paper Set.>.

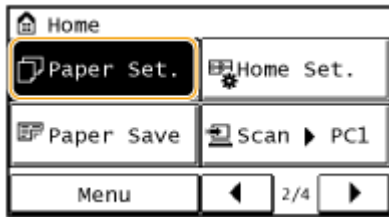

- 2 Tap <MP Tray> or <Drawer 1>.

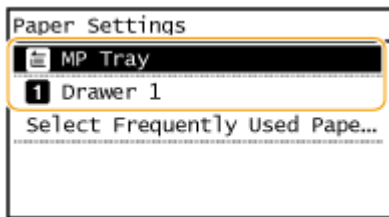

- 3 Select the loaded paper size.

- If the loaded paper size is not displayed, tap <Other Sizes>.

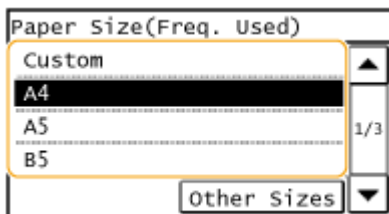

- 4 Select the loaded paper type.

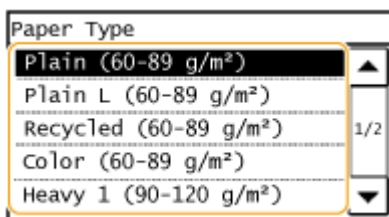

TIPS

When a frequently used paper size is known

You can set the machine to display only frequently used paper sizes in the selection screen.

- 1 Tap <Paper Set.>.

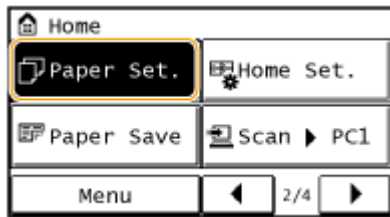

- 2 Tap <Select Frequently Used Paper Sizes>.
- 3 Tap <Multi-Purpose Tray> or <Drawer 1>.
- 4 Select and checkmark a frequently used paper size.

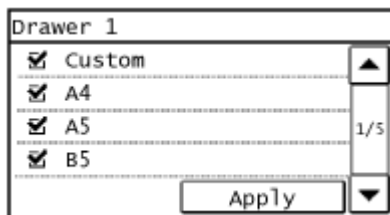

NOTE:

Uncheckmarked paper sizes are displayed in the <Paper Size (Other Sz.)> screen.

- 5 Tap <Apply>.

LINKS

- 🔗 [Loading Paper in the Paper Drawer\(P. 47\)](#)
- 🔗 [Paper\(P. 647\)](#)

Registering a Custom Paper Size

You can register one frequently used custom paper size each for the paper drawer and manual feed slot.

- 1 Press  and tap <Paper Set.>.

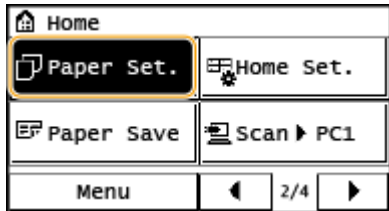

- 2 Tap <MP Tray> or <Drawer 1>.

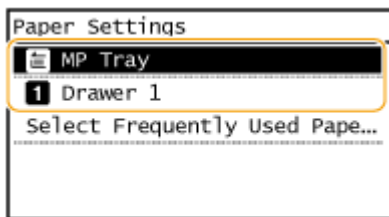

- 3 Tap <Custom>.

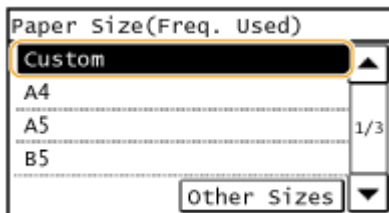

- 4 Specify the paper size.

- 1 Specify the length of the <X> (shorter) side.

- Tap <X>.
- Input the length of the <X> side using ▲ / ▼ or the numeric keys, and tap <Apply>.

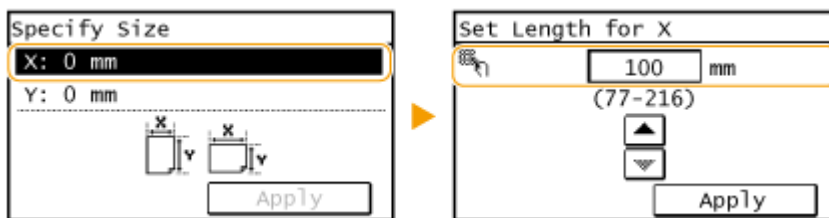

- 2 Specify the length of the <Y> (longer) side.

- Tap <Y>.
- Input the length of the <Y> side, and tap <Apply>.

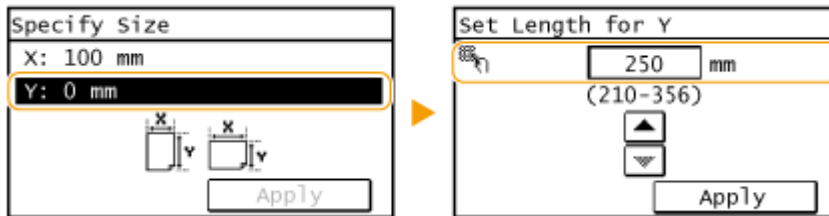

3 Tap <Apply>.

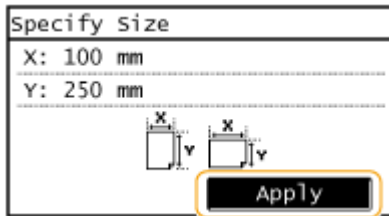

5 Select the paper type.

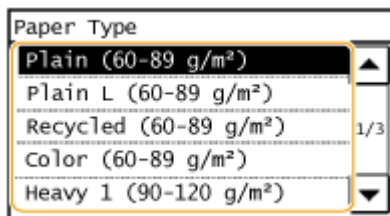

LINKS

- ▶ Loading Paper in the Paper Drawer(P. 47)
- ▶ Loading Paper in the Manual Feed Slot(P. 50)

Registering in the Address Book

14L7-012



You can register frequently used fax/scan destinations in the Address Book and easily select them when needed. You can register up to 104 destinations in the Address Book. Destinations can be searched alphabetically, from lists in the Address Book, or by entering three-digit numbers (coded dial numbers) ([▶Registering Destinations in the Address Book\(P. 61\)](#)). You can also specify destinations more quickly by using the following features.

■ One-Touch Dial

Registering a lot of addresses in the Address Book makes it difficult to find the destination you need. To avoid this situation, register frequently used destinations as One-Touch Dial numbers. This allows them to be displayed by the One-Touch buttons in the <Home> Screen. You can register up to 4 destinations for One-Touch Dial. [▶Registering Destinations for One-Touch Dial\(P. 65\)](#)

■ Group Dial

You can select multiple destinations that have already been registered and register them together as a group. You can send faxes or e-mails to multiple destinations at the same time. You can register up to 50 destinations for a group. Groups can also be registered in One-Touch Dial. [▶Registering Multiple Destinations for Group Dial\(P. 69\)](#)

NOTE

- Use the computer to register a shared folder as the destination for scans.
 - ▶[Setting a Shared Folder as a Save Location\(P. 368\)](#)
 - ▶[Registering Address Book from Remote UI\(P. 467\)](#)
- You can save the Address Book as a file on your computer (although you cannot use the computer to edit the Address Book). You can also import a saved Address Book from the computer to the machine. [▶Saving/ Loading Address Book from Remote UI\(P. 463\)](#)
- You can print a list of destinations registered in the Address Book.
 - ▶[Address Book List\(P. 617\)](#)
- Destinations for scans (e-mail addresses and shared folders) can be registered on the MF249dw / MF246dn only.

Registering Destinations in the Address Book

14L7-013

You can register up to 100 destinations for Coded Dial in the Address Book. You can edit or delete destinations that you have registered.

NOTE

- E-mail addresses can be registered as destinations on the MF249dw / MF246dn only.

1 Press and tap <Addr. Book>.

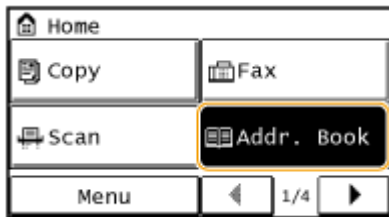

2 Tap <Regist Dest.>.

- If a screen appears prompting you to enter a PIN, enter the correct PIN using the numeric keys, and tap <Apply>. [▶Setting a PIN for Address Book\(P. 415\)](#)

3 Select <Coded Dial> ▶ Select type of address to register.

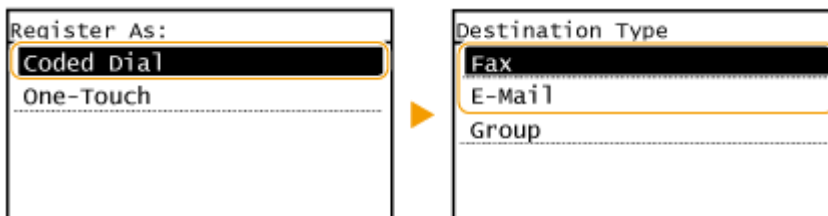

- According to the address being registered, tap <Fax>/<E-Mail>.

4 Tap <Name>.

- Registering <Name> is optional. If you register <Name>, the destination can be searched alphabetically.

5 Enter the name using the numeric keys, and tap <Apply>.

6 Tap <Fax Number> or <E-Mail Address>.

7 Enter the destination using the numeric keys, and tap <Apply>.

■ Making detailed settings (only when registered for fax)

After tapping <Details>, a screen similar to the following is displayed.

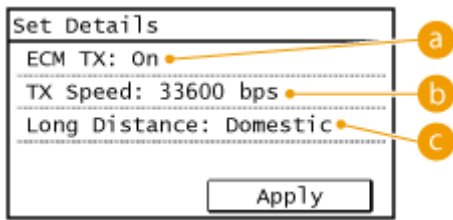

a <ECM TX>

If an error occurs in an image that is being sent, the error is checked and corrected to prevent an improper image from being sent when setting <On>.

b <TX Speed>

If it takes time for transmissions to start, such as when there is a poor telephone connection, you can adjust the transmission start speed downward incrementally starting from "33600 bps".

c <Long Distance>

Specify <International (1)> to <International (3)> according to the transmission conditions when registering overseas fax numbers.

NOTE

You can also make detailed settings for destinations from <Menu> ▶ <Fax Settings>. However, settings made from <Addr. Book> are enabled for the detailed settings of destinations registered in the Address Book.

8 Tap <Apply>.

- A three-digit number is automatically set to destinations. The number can be edited after it has been registered.

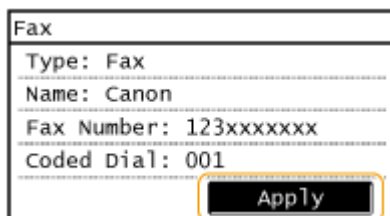

■ Editing the Content of Registered Destinations

After registering destinations, you can change the content of registered information. For example, you can change the fax number or name of a registered destination, change the type from fax number to e-mail, change the coded dial number, and so on.

1 Press and tap <Addr. Book>.

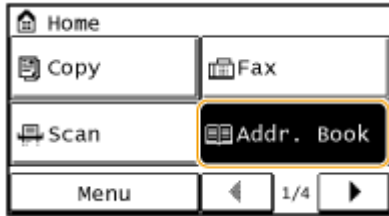

2 Tap <Details/Edit>.

3 Use ◀/▶ to select the tab containing the destination you want to edit, and tap the destination.

4 Tap <Edit>.

- If a screen appears prompting you to enter a PIN, enter the correct PIN using the numeric keys, and tap <Apply>. ▶ [Setting a PIN for Address Book\(P. 415\)](#)

5 Select the item you want to edit, perform editing, and then tap <Apply>.

6 Tap <Apply>.

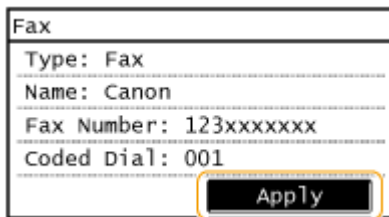

■ Deleting a Registered Destination

1 Press  and tap <Addr. Book>.

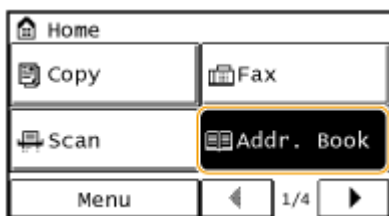

2 Tap <Details/Edit>.

3 Use ◀/▶ to select the tab containing the destination you want to delete, and tap the destination.

4 Tap <Delete>.

- If a screen appears prompting you to enter a PIN, enter the correct PIN using the numeric keys, and tap <Apply>. **▶Setting a PIN for Address Book(P. 415)**

5 Tap <Yes>.

Registering Destinations for One-Touch Dial

14L7-014

You can conveniently register frequently used destinations for One-Touch Dial. Destinations can be quickly displayed by tapping One-Touch buttons in the <Home> Screen. You can edit or delete destinations that you have registered. You can register up to 4 destinations for One-Touch Dial.

NOTE

- E-mail addresses can be registered as destinations on the MF249dw / MF246dn only.

1 Press and tap <Addr. Book>.

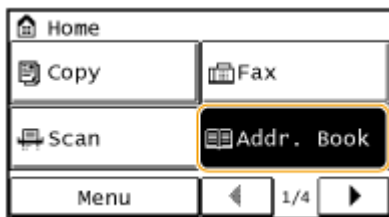

2 Tap <Regist Dest.>.

- If a screen appears prompting you to enter a PIN, enter the correct PIN using the numeric keys, and tap <Apply>. [▶Setting a PIN for Address Book\(P. 415\)](#)

3 Select <One-Touch> ▶ Select type of address to register.

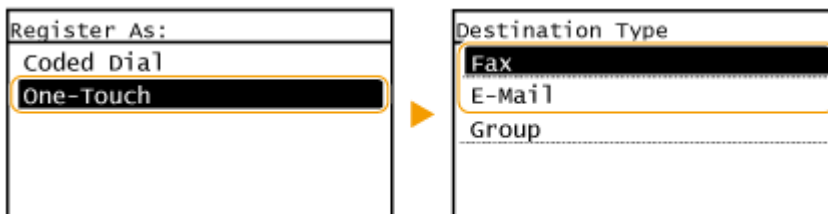

- According to the address being registered, tap <Fax>/<E-Mail>.

4 Tap the number to register.

- You can change this number to another number later.

5 Tap <Name>.

- Registering <Name> is optional. If you register <Name>, the destination can be searched alphabetically.

6 Enter the name using the numeric keys and tap <Apply>.

7 Tap <Fax Number> or <E-Mail Address>.

8 Enter the destination using the numeric keys and tap <Apply>.

■ Making detailed settings (only when registered for fax)

After tapping <Details>, a screen similar to the following is displayed.

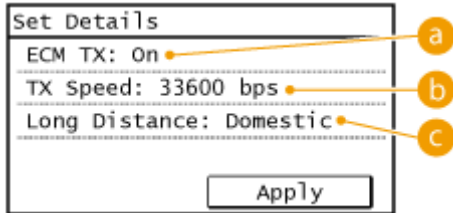

a <ECM TX>

If an error occurs in an image that is being sent, the error is checked and corrected to prevent an improper image from being sent when setting <On>.

b <TX Speed>

If it takes time for transmissions to start, such as when there is a poor telephone connection, you can adjust the transmission start speed downward incrementally starting from "33600 bps".

c <Long Distance>

Specify <International (1)> to <International (3)> according to the transmission conditions when registering overseas fax numbers.

NOTE

You can also make detailed settings for destinations from <Menu> ▶ <Fax Settings>. However, settings made from <Addr. Book> are enabled for the detailed settings of destinations registered in the Address Book.

9 Tap <Apply>.

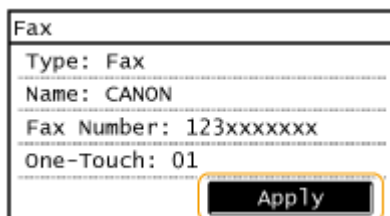

■ Editing the Content of Registered Destinations in One-Touch Dial

After registering destinations, you can change the content of registered information. For example, you can change the fax number or name of a registered destination, change the type from fax number to e-mail, change the numbers registered to One-Touch Dial, and so on.

1 Press and tap <Addr. Book>.

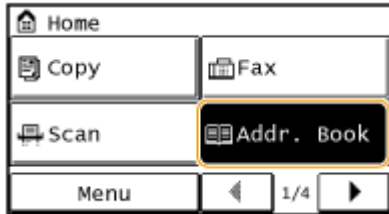

2 Tap <Details/Edit>.

3 Select <👉> using ◀/▶, and tap the destination you want to change.

4 Tap <Edit>.

- If a screen appears prompting you to enter a PIN, enter the correct PIN using the numeric keys, and tap <Apply>. ▶[Setting a PIN for Address Book\(P. 415\)](#)

5 Tap the item you want to edit, perform editing, and then tap <Apply>.

6 Tap <Apply>.

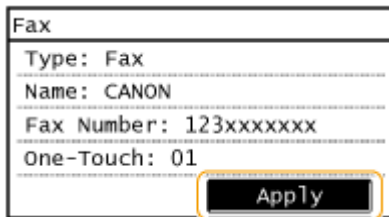

■ Deleting a Registered Destination

1 Press and tap <Addr. Book>.

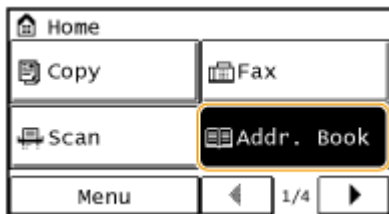

2 Tap <Details/Edit>.

3 Select <👉> using ◀/▶, and tap the destination you want to delete.

4 Tap <Delete>.

- If a screen appears prompting you to enter a PIN, enter the correct PIN using the numeric keys, and tap <Apply>.  **Setting a PIN for Address Book(P. 415)**

5 Tap <Yes>.

Registering Multiple Destinations for Group Dial

14L7-015

Multiple destinations can be combined into groups. After a group is registered, you can add or delete destinations.

NOTE

- Only destinations of the same type of address can be registered in the same group.
- Shared folders cannot be registered in a group as destinations.

1 Press and tap <Addr. Book>.

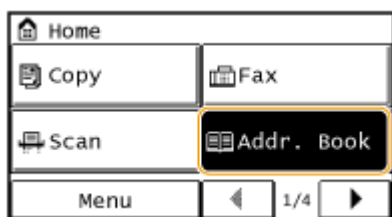

2 Tap <Regist Dest.>.

- If a screen appears prompting you to enter a PIN, enter the correct PIN using the numeric keys, and tap <Apply>. [▶Setting a PIN for Address Book\(P. 415\)](#)

3 Tap <Coded Dial>.

- Groups can also be registered in One-Touch Dial. Select <One-Touch> to register the group as a One-Touch Dial number.

4 Tap <Group>.

5 Tap <Name>.

- Registering <Name> is optional. If you register <Name>, the destination can be searched alphabetically.

6 Enter the name using the numeric keys, and tap <Apply>.

7 Tap <Number of Destinations>.

8 Tap <Add>.



9 Use ◀/▶ to select the tab and tap a destination you want to register.

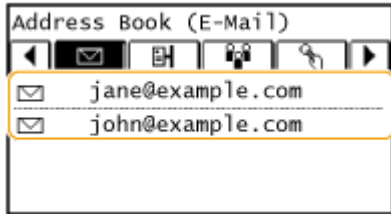

10 Tap <Add>.



11 Repeat steps 8 and 9 until you have registered all of the destinations that you want to register, and then tap <Apply>.

12 Tap <Apply>.

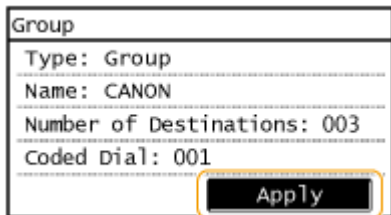

■ **Editing the Content of Registered Groups**

After registering destinations, you can change the content of groups such as names, destinations, and coded dial numbers.

1 Press 🏠 and tap <Addr. Book>.

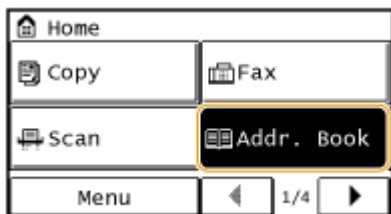

2 Tap <Details/Edit>.

3 Select <⌂> using ◀/▶, and tap the destination you want to change.

4 Tap <Edit>.

- If a screen appears prompting you to enter a PIN, enter the correct PIN using the numeric keys, and tap <Apply>. ▶[Setting a PIN for Address Book\(P. 415\)](#)

5 Select the item you want to edit, perform editing, and then tap <Apply>.

6 Tap <Apply>.

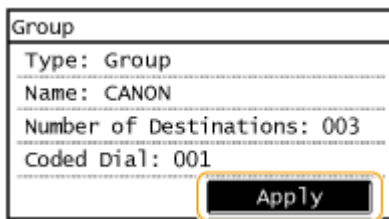

■ Deleting a Group

1 Press ⌂ and tap <Addr. Book>.

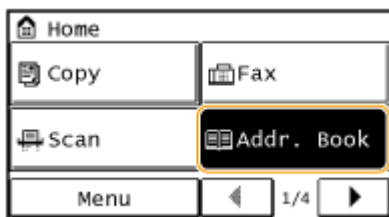

2 Tap <Details/Edit>.

3 Select <⌂> using ◀/▶, and tap the group you want to delete.

4 Tap <Delete>.

- If a screen appears prompting you to enter a PIN, enter the correct PIN using the numeric keys, and tap <Apply>. ▶[Setting a PIN for Address Book\(P. 415\)](#)

5 Tap <Yes>.

Adjusting the Volume

14L7-016

The machine produces sounds in a variety of situations, such as when fax sending is complete or when a paper jam or error occurs. You can set the volume of each of these sounds individually.

- 1** Press  and tap <Menu>.

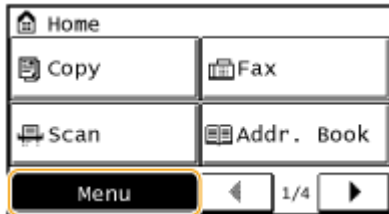

- 2** Tap <Preferences>.

- 3** Tap <Volume Settings>.

- 4** Select a setting.

Setting	Description	Procedure
<Fax Tone>	Sound produced during a fax transmission	<ul style="list-style-type: none"> Go to step 5.
<Ring Tone>	Sound produced when an incoming fax is received	
<TX Done Tone>	Sound produced when fax sending is complete	<ul style="list-style-type: none"> Go to step 5.
<RX Done Tone>	Sound produced when fax receiving is complete	
<Scanning Done Tone>	Sound produced when fax document scanning is complete	
<Entry Tone>	Confirmation sound each time a key on the operation panel or button on the display is pressed	<ul style="list-style-type: none"> Select <On> (produce a tone) or <Off> (not produce a tone).
<Invalid Entry Tone>	Sound produced when an invalid key operation is performed, such as when you enter a number outside the valid setting range	
<Warning Tone>	Sound produced when a paper jam or other error occurs	
<Job Done Tone>	Sound produced when an operation such as copying or scanning is complete	
<Energy Saver Alert>	Sound produced when the machine enters or exits sleep mode	

<Original in Feeder Detection Tone>	Sound produced when an original is loaded in the feeder	
-------------------------------------	---	--

5 Use  /  to set volume, tap <Apply>.

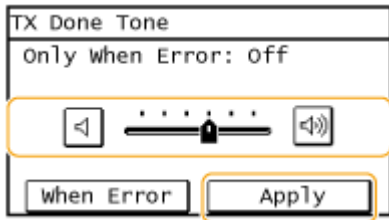

- Tap  and move the cursor all the way to the left to mute the sound.

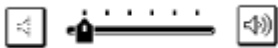

■ End sound only for error

- Tap <When Error> ► <On> ► <Apply>.

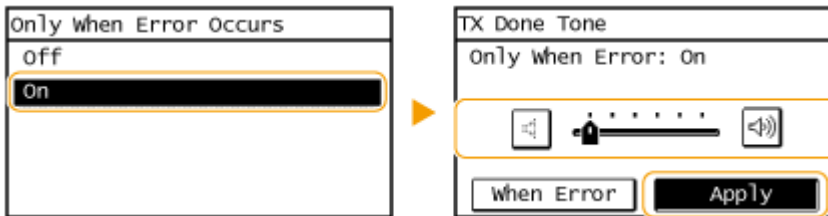

Entering Quiet Mode

14L7-017

The quiet mode function reduces the operation sound of the machine. For example, when using the machine at night, press  on the operation panel. With only this operation, you can easily minimize operation sound. You can also specify a time for the machine to automatically enter quiet mode.

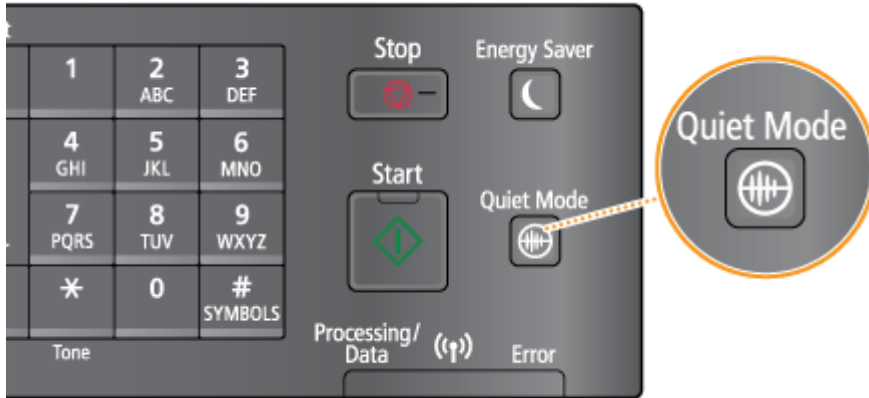

NOTE

When in quiet mode

When the machine enters quiet mode,  lights up green.

When quiet mode is enabled

- The operation of functions becomes slower.
- The volume of notifications such as <Entry Tone> and <Job Done Tone> is not lower. To adjust volume or mute sounds, see [▶ Adjusting the Volume \(P. 72\)](#) .

When the machine cannot enter quiet mode

- The machine is in Special Printing Mode
- A particular paper size or paper type is specified

Specifying a time for the machine to enter quiet mode

You can specify a time for the machine to enter or exit quiet mode automatically. For example, this is useful when wanting to reduce operation noise only for late-night operation.



<Menu> ▶ <Timer Settings> ▶ <Quiet Mode Time> ▶ Specify each setting ▶ <Apply>

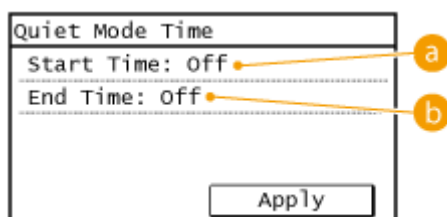

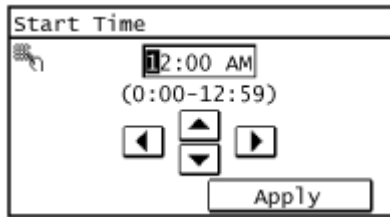

a <Start Time>

Specify a time for entering quiet mode. To set, tap <On> then specify the time.

**b <End Time>**

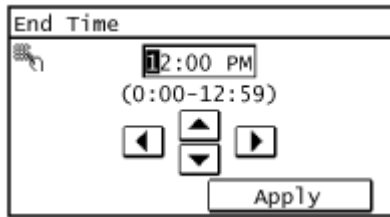
Specify a time for exiting quiet mode. To set, tap <On> then specify the time.

**Exiting Quiet Mode**

Press  to exit quiet mode.

Entering Sleep Mode

The sleep mode function reduces the amount of power consumed by the machine by disabling power flow to the operation panel. If no operations will be performed on the machine for a while, such as during a lunch break, you can save power simply by pressing  on the operation panel. You can also use the Auto Sleep Time setting to automatically put the machine into sleep mode if it remains idle for a specified length of time.



NOTE

When in sleep mode

When the machine enters sleep mode,  lights up green.

Situations in which the machine does not enter sleep mode

- When the machine is in operation
- When the [Processing/Data] indicator is lit up or blinking
- When documents are placed in the feeder
- When the machine is performing an operation such as adjustment or cleaning
- When a paper jam occurs
- When the receiver of the optional handset or an external telephone is off the hook
- When the menu screen is displayed
- When an error message is displayed on the screen (There are some exceptions. The machine sometimes enters sleep mode when error messages are displayed.)
- When the machine is waiting for a wireless LAN connection or Direct Connection

When You Want to Set the Auto Sleep Timer

The factory default settings for the amount of time that elapses before the machine enters auto sleep mode are listed below. We recommend using the factory default settings to save the most power. If you want to change the amount of time that elapses before the machine enters auto sleep mode, follow the procedure below.

- 1 minute (setting range is 1 to 30 minutes)



<Menu> ▶ <Timer Settings> ▶ <Auto Sleep Time> ▶ Set the amount of time that elapses before the machine automatically enters sleep mode ▶ <Apply>

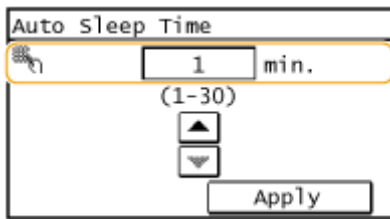

Exiting Sleep Mode

Press . You can also tap the display or press any key other than  to exit sleep mode.

NOTE

If the optional handset or an external telephone is connected, the machine exits sleep mode when you take the receiver off the hook.

Copying

Copying	79
Basic Copy Operations	81
Canceling Copies	83
Various Copy Settings	85
Enlarging or Reducing	86
Selecting Document Type	87
Adjusting Density	88
Adjusting Sharpness	89
2-Sided Copying (MF249dw / MF246dn)	91
Copying Multiple Documents onto One Sheet (2 on 1/4 on 1)	94
Using the <Paper Save> Button	96
Copying Both Sides of an ID Card onto One Page	98
Collating Copies by Page	99
Changing Default Settings	100

Copying

This chapter describes basic copy operations and various other useful functions, such as 2-sided copying and copying both sides of an ID card onto one page.

■ Using Basic Operations

- ▶ Basic Copy Operations(P. 81)
- ▶ Canceling Copies(P. 83)

■ Using Copy Settings to Suit Your Needs

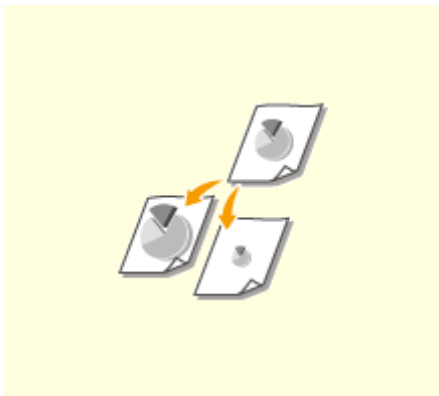

▶ Enlarging or Reducing(P. 86)

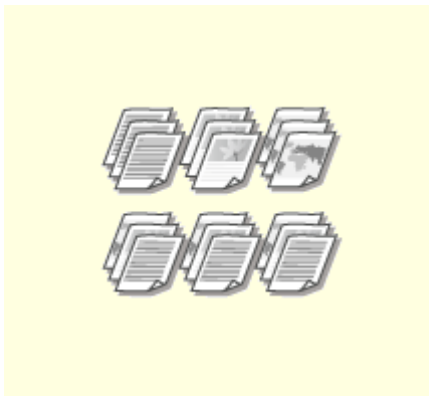

▶ Collating Copies by Page(P. 99)

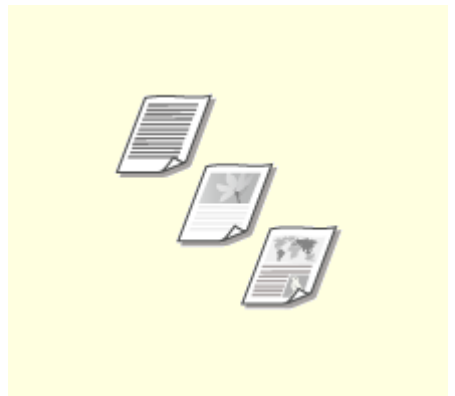

▶ Selecting Document Type(P. 87)

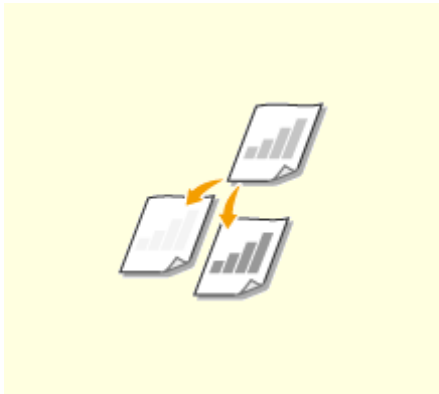

▶ Adjusting Density(P. 88)

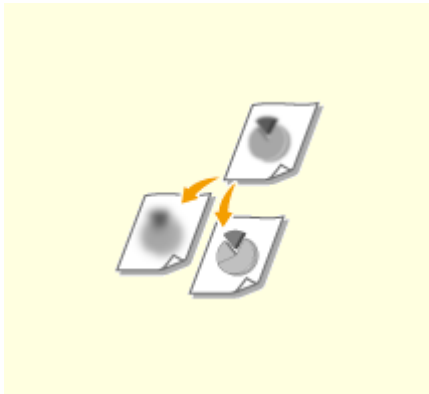

▶ Adjusting Sharpness(P. 89)



▶ 2-Sided Copying (MF249dw / MF246dn)(P. 91)

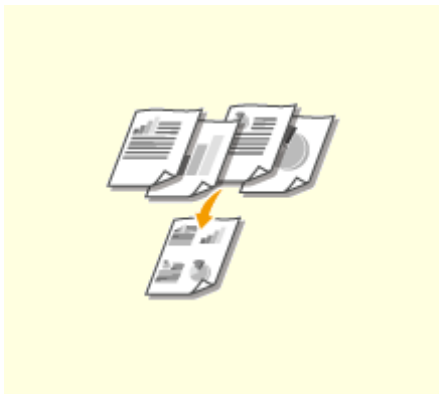

▶ **Copying Multiple Documents onto One Sheet (2 on 1/4 on 1)**
(P. 94)

▶ **Using the <Paper Save> Button(P. 96)**

▶ **Copying Both Sides of an ID Card onto One Page(P. 98)**

■ **Simplifying Your Frequent Copy Operations**

▶ **Changing Default Settings(P. 100)**

Basic Copy Operations

14L7-01C

1 Place the document(s). Placing Documents(P. 41)

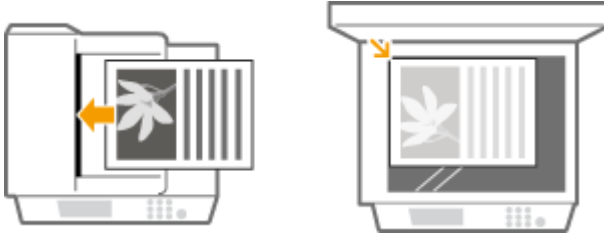

2 Press and tap <Copy>.

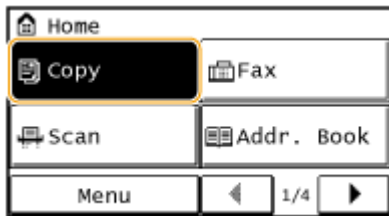

3 Enter the number of copies using the numeric keys.

- Enter a quantity from 1 to 999.
- Press to cancel the entered quantity.

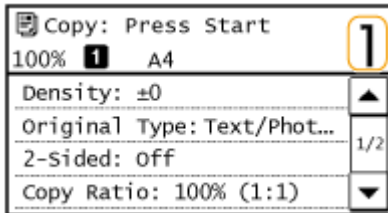

4 Specify the copy settings as necessary.

- Select the settings. Various Copy Settings(P. 85)

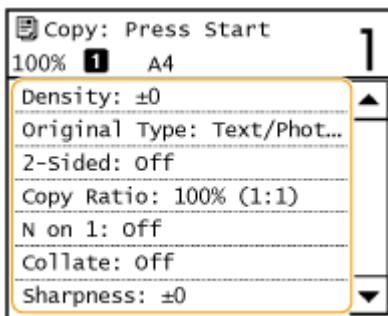

5 Press .

- Copying starts.
- If you want to cancel copying, tap <Cancel> ► <Yes>. **▶Canceling Copies(P. 83)**

■When placing documents in the feeder in step 1

The document is automatically scanned.

■When placing documents on the platen glass in step 1

Depending on the copy settings you made, the screen for selecting the document size is displayed when copying multiple documents. Follow the procedure below.

- 1 Select the document size.

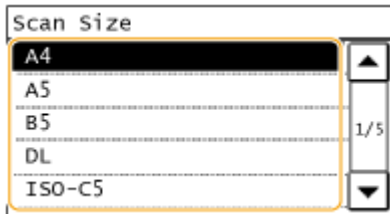

- 2 Place the next document on the platen glass, and press .
 - Repeat this step until you finish scanning the entire document.
- 3 Tap <Start Copy>.

NOTE:

- When the <Size/Settings Mismatch> message appears.
 - ▶When an Error Message Appears(P. 548)**

IMPORTANT



When copying documents with text or images that extend to the edges of the page

The edges of the document might not be copied. For more information about the scan margins, see **▶Scan Area(P. 646)** .

TIPS

- If you always want to make copies with the same settings:
 - ▶Changing Default Settings(P. 100)**

Canceling Copies

If you want to cancel copying immediately after pressing , tap <Cancel> on the screen or press  on the operation panel. You can also cancel copying after checking the copy status.

■ Tap <Cancel> on the Screen That is Displayed While Copying

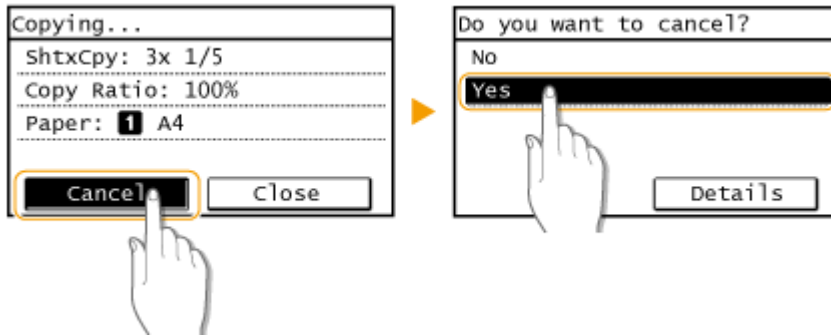

■ Press to Cancel

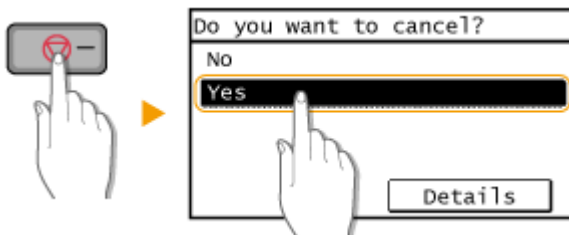

If the Screen Displays a List of Documents When is Pressed

Documents have been scanned and are waiting to be printed. Select the copy document to cancel.

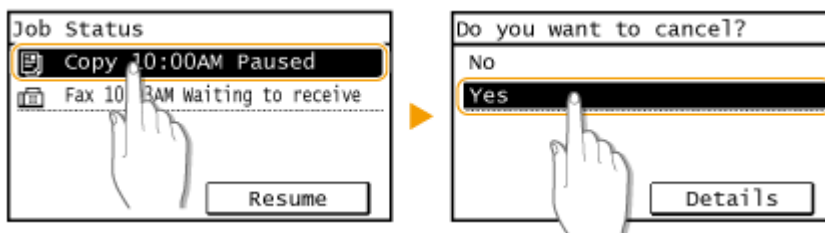

■ Use to Cancel

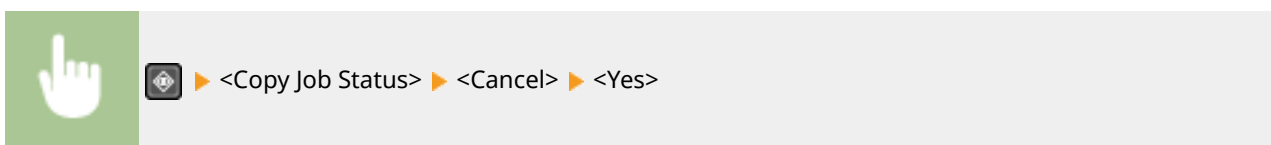

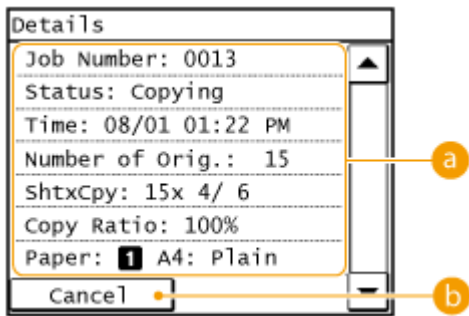

a Copy details

The number of copies, settings, and other details are displayed. If you only want to check the details without canceling copying, press  to return to the copy main screen.

b <Cancel>

Cancels copying.

LINKS

▶ Basic Copy Operations(P. 81)

Various Copy Settings

14L7-01F

A variety of settings are available to suit your needs, such as when you want to save paper or make your documents easier to read.

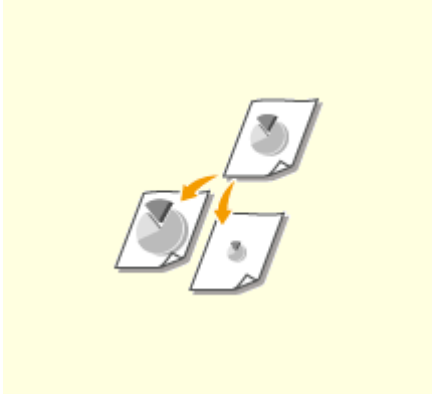

▶ **Enlarging or Reducing(P. 86)**



▶ **Selecting Document Type(P. 87)**

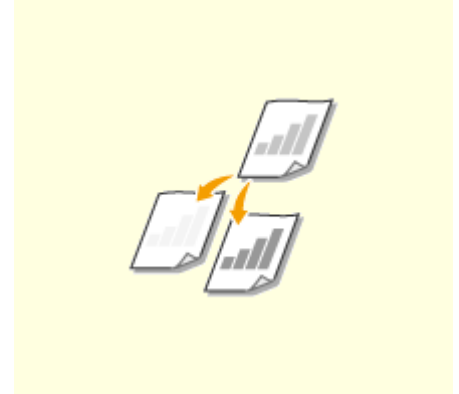

▶ **Adjusting Density(P. 88)**

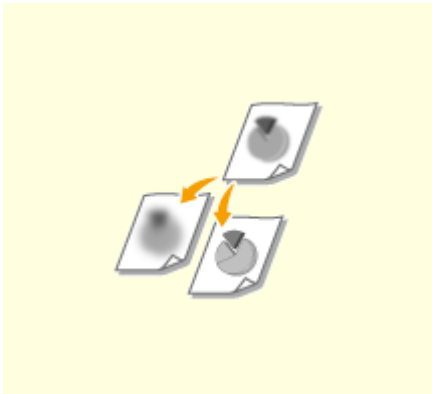

▶ **Adjusting Sharpness(P. 89)**



▶ **2-Sided Copying (MF249dw / MF246dn)(P. 91)**



▶ **Copying Multiple Documents onto One Sheet (2 on 1/4 on 1) (P. 94)**



▶ **Using the <Paper Save> Button(P. 96)**



▶ **Copying Both Sides of an ID Card onto One Page(P. 98)**



▶ **Collating Copies by Page(P. 99)**

Enlarging or Reducing



You can enlarge or reduce copies by using a preset copy ratio such as <A5->A4>, or by setting a custom copy ratio in increments of 1%.

 <Copy> ▶ <Copy Ratio> ▶ Select the copy ratio

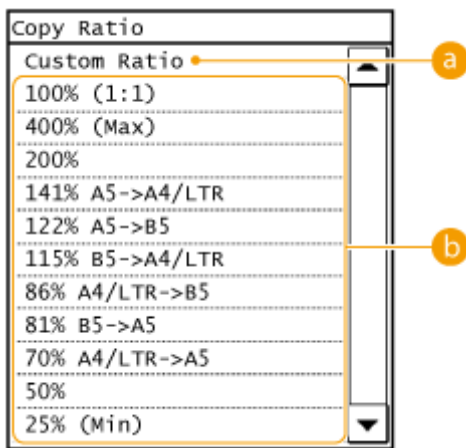

a <Custom Ratio>

Use ▲ / ▼ or the numeric keys to enter the copy ratio, and tap <Apply>. You can set any copy ratio from 25% to 400% in 1% increments.

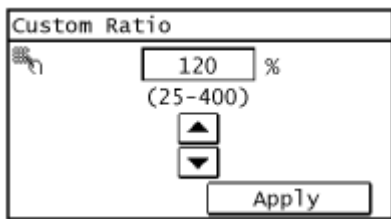

b Preset copy ratio

Select a copy ratio.

LINKS

▶ Basic Copy Operations(P. 81)

Selecting Document Type



You can select the optical image quality for the copy depending on the document type, such as text-only documents, documents with charts and graphs, or magazine photos.



<Copy> ► <Original Type> ► Select the document type

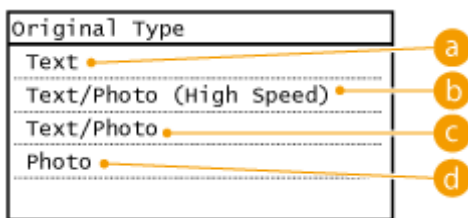

a <Text>

Suitable when copying documents that only contain text.

b <Text/Photo (High Speed)>

Suitable when copying documents that contain both text and photos. Priority is given to speed over image quality.

c <Text/Photo>

Suitable when copying documents that contain both text and photos.

d <Photo>

Suitable when copying documents that contain printed photos, such as magazines or pamphlets.

NOTE

If <Text/Photo (High Speed)>, <Text/Photo>, or <Photo> is selected and <Density> is set to <Auto Density>, it changes to Manual Density.

LINKS

▶ **Basic Copy Operations(P. 81)**

Adjusting Density

14L7-01K



You can adjust the density of the copy if the text or images in a document are too light or dark. You can also automatically set an optimal density for a document.



<Copy> ▶ <Density> ▶ Adjust the density ▶ <Apply>

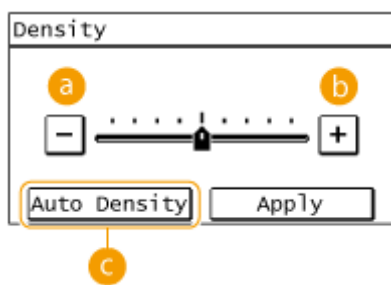

a <->

Decreases the density.

b <+>

Increases the density.

c <Auto Density>

An optimal density for the document is automatically set.

<Original Type> is automatically set to <Text>. (▶ **Selecting Document Type(P. 87)**)

LINKS

- ▶ **Basic Copy Operations(P. 81)**
- ▶ **Adjusting Sharpness(P. 89)**
- ▶ **Correct Density(P. 495)**

Adjusting Sharpness

14L7-01L



You can adjust sharpness of the copied image. Increase the sharpness to sharpen blurred text and lines, or decrease the sharpness to improve the appearance of magazine photos.

 <Copy> ▶ <Sharpness> ▶ Adjust the sharpness ▶ <Apply>

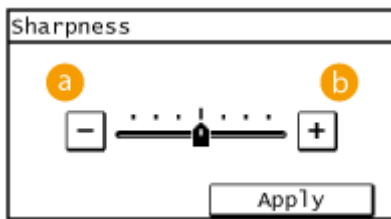

a <->

Decreases the sharpness, resulting in a softer image.

Example: If you want to improve the appearance of magazine photos

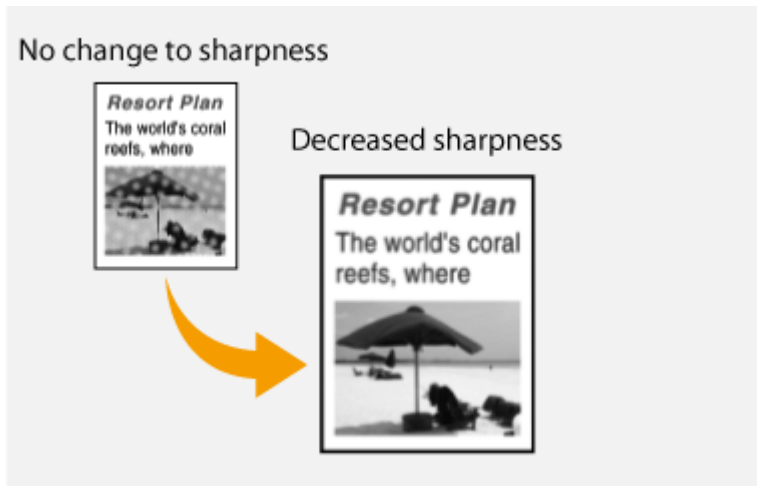

b <+>

Increases the image sharpness.

Example: If you want to sharpen text and lines written in pencil

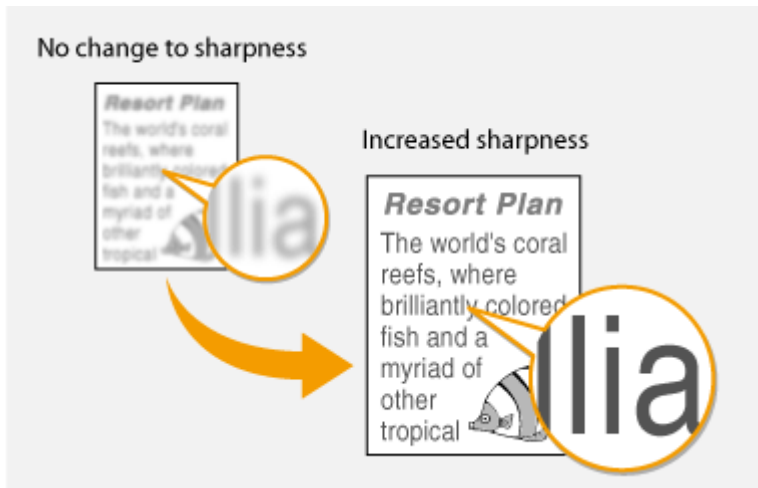

LINKS

- ▶ **Basic Copy Operations(P. 81)**
- ▶ **Adjusting Density(P. 88)**

2-Sided Copying MF249dw / MF246dn

14L7-01R



You can copy two pages of a document on both sides of the paper. You can also copy a two-sided document on both sides of the paper, or on two separate pages.

NOTE

- <2-Sided> may not be available with some sizes and types of paper.
▶ **Paper(P. 647)**
- <2-Sided> is not available when using <Paper Save> or <ID Card Copy>.

TIPS

Using the <Paper Save> enables you to combine 2-sided copying and <2 on 1>/<4 on 1>: ▶ **Using the <Paper Save> Button(P. 96)**



<Copy> ▶ <2-Sided> ▶ Select the type of 2-sided copying

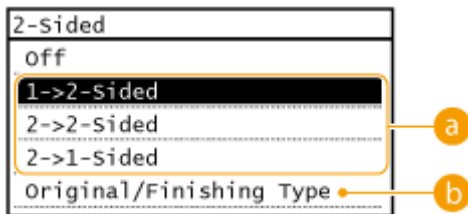

a Types of 2-sided copying

The illustration below shows the types of 2-sided copying.

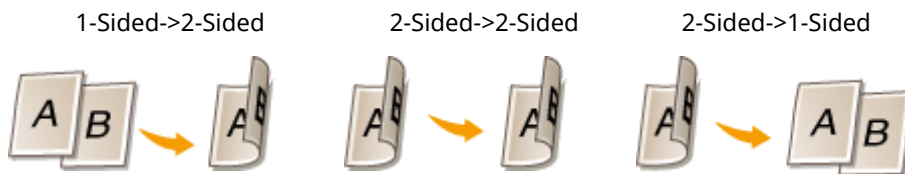

b <Original/Finishing Type>

Specify if you want to change the binding, such as when copying book-type documents in calendar-type format.

■ 1-Sided->2-Sided

- If you want to copy portrait-oriented documents in calendar-type format (short-edge binding)



 <Original/Finishing Type> ▶ <1->2-Sided> ▶ <Portrait> ▶ <Calendar Type>

- If you want to copy landscape-oriented documents in book-type format (short-edge binding)



 <Original/Finishing Type> ▶ <1->2-Sided> ▶ <Landscape> ▶ <Book Type>

■ 2-Sided->2-Sided (MF249dw)

- If you want to create copies with a different binding type than the original

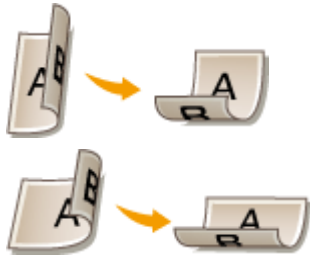

 <Original/Finishing Type> ▶ <2->2-Sided> ▶ Select the original orientation ▶ Select the original binding type ▶ Select the binding type for the finished copy, which is different from that of the original document

■ 2-Sided->1-Sided (MF249dw)

This setting enables you to align the direction of the output paper.

- When a 2-sided document is in portrait-oriented calendar-type format (short-edge binding)



 <Original/Finishing Type> ▶ <2->1-Sided> ▶ <Portrait> ▶ <Calendar Type>

- When a 2-sided document is in landscape-oriented book-type format (short-edge binding)





<Original/Finishing Type> ▶ <2->1-Sided> ▶ <Landscape> ▶ <Book Type>

LINKS

- ▶ **Basic Copy Operations(P. 81)**
- ▶ **Copying Multiple Documents onto One Sheet (2 on 1/4 on 1)(P. 94)**
- ▶ **Using the <Paper Save> Button(P. 96)**

Copying Multiple Documents onto One Sheet (2 on 1/4 on 1)

14L7-01S



You can copy two or four documents onto a single sheet at a reduced size. This decreases the number of pages, enabling you to save paper.

NOTE

- Using <2 on 1>/<4 on 1> reduces the copy ratio automatically (the copy ratio is displayed on the screen). You can increase or further reduce the copy ratio before pressing , but the edges of the document might not be copied if you increase it.
- <2 on 1>/<4 on 1> is not available when using <Paper Save> or <ID Card Copy>.
- When you copy multiple documents onto one page, margins may be created in the copied image.

TIPS

Using the <Paper Save> enables you to combine 2-sided copying and <2 on 1>/<4 on 1>:  **Using the <Paper Save> Button (P. 96)**



<Copy> ▶ <N on 1> ▶ Select <2 on 1> or <4 on 1> ▶ Select the document size on the <Scan Size> screen

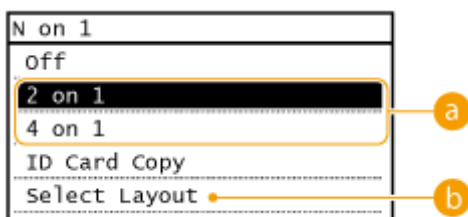

a <2 on 1>/<4 on 1>

Select <2 on 1> to copy two pages of documents onto a single sheet, or select <4 on 1> to copy four pages of documents onto a single sheet.

b <Select Layout>

Specify how to arrange the documents on the page.

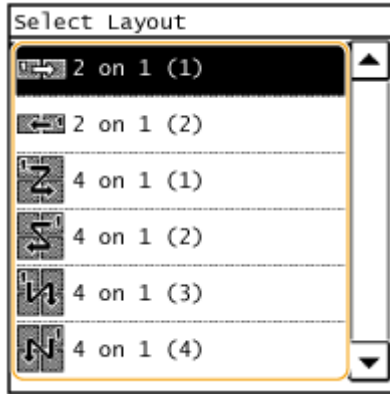

LINKS

- ▶ **Basic Copy Operations(P. 81)**
- ▶ **2-Sided Copying (MF249dw / MF246dn)(P. 91)**
- ▶ **Using the <Paper Save> Button(P. 96)**

Using the <Paper Save> Button

14L7-01U



You can use <2 on 1>/<4 on 1> to copy multiple documents onto a single sheet, and <2-Sided> to copy the document onto both sides of a page. Using <Paper Save> in the Home Screen, which combines these functions, makes it easier to save paper than when using the functions separately.

NOTE

- The 2-sided <Paper Save Copy> settings may not be available with some sizes and types of paper. **Paper(P. 647)**
- Using <Paper Save> reduces the copy ratio automatically (the copy ratio is displayed on the screen). You can increase or further reduce the copy ratio before pressing , but the edges of the document might not be copied if you increase it.
- <Paper Save> is not available when using <2-Sided>, <2 on 1>/<4 on 1>, or <ID Card Copy>.
- When you copy multiple documents onto one page, margins may be created in the copied image.





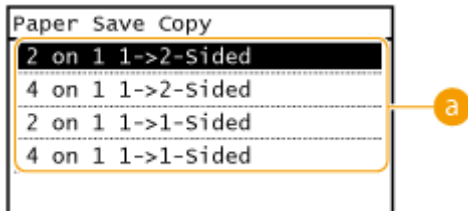

<Paper Save> ▶ Select the paper save copy setting ▶ Select the document size on the <Scan Size> screen







a Paper save copy settings

Select one of four setting combinations.

	Original (Portrait)	Copy
<2 on 1 1->2-Sided>*		
<4 on 1 1->2-Sided>*		

Copying

<2 on 1 1->1-Sided>		
<4 on 1 1->1-Sided>		

* MF249dw / MF246dn Only

LINKS

- ▶ **Basic Copy Operations(P. 81)**
- ▶ **2-Sided Copying (MF249dw / MF246dn)(P. 91)**
- ▶ **Copying Multiple Documents onto One Sheet (2 on 1/4 on 1)(P. 94)**

Copying Both Sides of an ID Card onto One Page

14L7-01W



You can use <ID Card Copy> to copy the front and back sides of a card onto the same side of a page. This function is useful when copying a driver's license or ID card.

NOTE

- All regular paper sizes can be used except Letter (Government), Legal (Government), and Envelope.
- <Copy Ratio> is automatically set to <Copy Ratio: 100% (1:1)>.
- <ID Card Copy> is not available when using <Paper Save>, <2-Sided>, or <2 on 1>/<4 on 1>.



Place the card ▶ <ID Card Copy> ▶  ▶ Turn the card over ▶ 

■ How to place the card

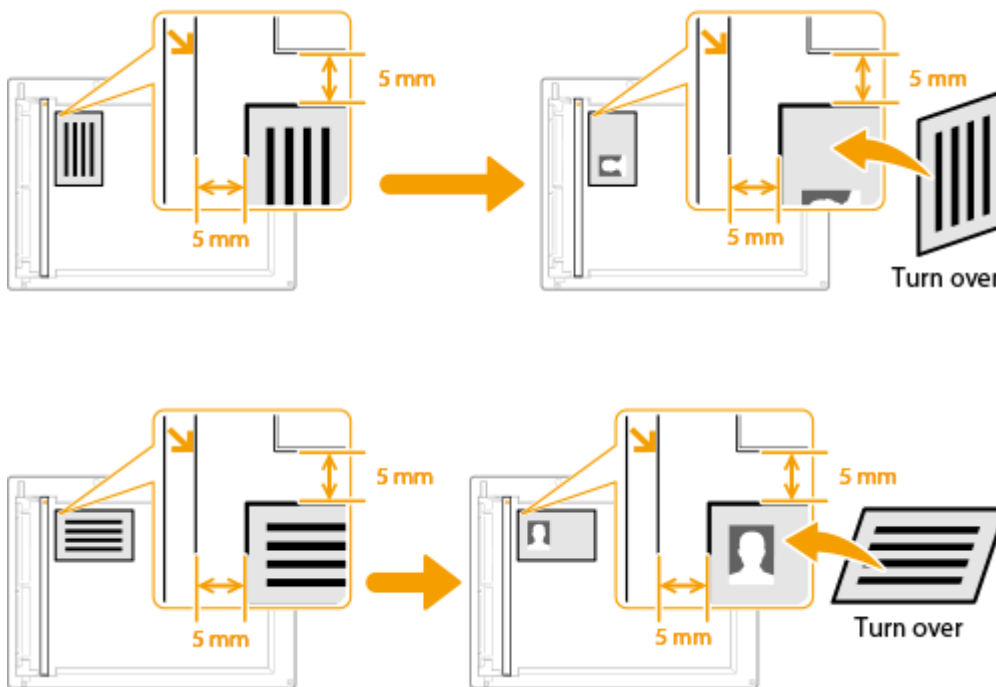

NOTE:

- When the <Size/Settings Mismatch> message appears.
 ▶ **When an Error Message Appears(P. 548)**

LINKS

- ▶ **Basic Copy Operations(P. 81)**

Collating Copies by Page

14L7-01X



When preparing multiple copies of multi-page documents, set <Collate> to <On> to collate copies in sequential page order. This function is useful when preparing handouts for meetings or presentations.

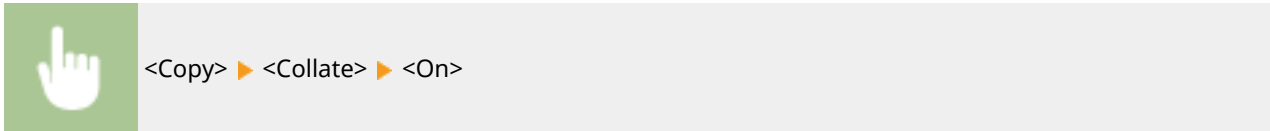

a <Off>

The copies are grouped by page and not collated. For example, if you are making three copies of a five-page document, the printouts will be arranged in the following page order: 1, 1, 1, 2, 2, 2, 3, 3, 3, 4, 4, 4, 5, 5, 5.



b <On>

The copies are grouped into complete sets in sequential page order. For example, if you are making three copies of a five-page document, the printouts will be arranged in the following page order: 1, 2, 3, 4, 5, 1, 2, 3, 4, 5, 1, 2, 3, 4, 5.



LINKS

▶ **Basic Copy Operations(P. 81)**

Changing Default Settings

The default settings are the settings that are displayed whenever you turn ON the machine, or when you press . If you change these default settings to match the operations that you perform frequently, you can eliminate the need to configure the same settings every time you make copies.



<Menu> ▶ <Copy Settings> ▶ <Change Default Settings> ▶ Select the setting ▶ Change the default value of the selected item ▶ <Apply> ▶ <Apply>

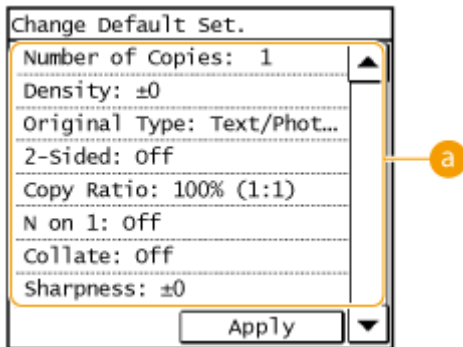

a Settings

Select the item you want to set, and change the default value.

LINKS

- ▶ **Basic Copy Operations(P. 81)**
- ▶ **Various Copy Settings(P. 85)**
- ▶ **Copy Settings(P. 494)**

Faxing

Faxing	103
Configuring Initial Settings for Fax Functions	106
Deciding Which Fax Receive Mode to Use	107
Registering the Fax Number and Unit Name	108
Selecting the Receive Mode	110
Connecting the Telephone Line	112
Sending Faxes	114
Sending from Registered Destinations	120
Specifying from Address Book	121
Selecting Destinations Directly by Entering Coded Dial Numbers	124
Specifying Destinations with the One-Touch Buttons	127
Specifying Previously Used Destinations	130
Various Fax Settings	133
Adjusting Resolution	134
Adjusting Density	135
Adjusting Sharpness	136
Scanning 2-Sided Documents (MF249dw)	138
Changing Default Settings	139
Canceling Sending Faxes	140
Receiving Faxes	142
Sending and Receiving Faxes According to Your Purposes	146
Making a Call before Sending Faxes (Manual Sending)	147
Sending Faxes to Multiple Destinations Simultaneously (Sequential Broadcast)	148
Storing Received Faxes into Memory (Memory Reception)	150
Forwarding Received Faxes	154
Selecting a Document to Forward	155
Forwarding All the Received Documents Automatically (MF249dw / MF246dn)	157
Receiving Fax Information Services	161
Checking Status and Log for Sent and Received Documents	163
Importing/Exporting Address Book Data with the Supplied Software	165
Sending Faxes from Your Computer (PC Fax)	167
Sending PC Faxes	168
Attaching Cover Sheets to PC Faxes	171
Using Address Book for PC Faxes	175
Registering Destinations	178

Faxing

Using Registered Destinations	182
Importing/Exporting Address Book Data from the Fax Driver	184

Faxing

This chapter describes fax settings, basic fax operations and various other useful functions to suit your needs, such as PC Fax to send documents directly from computers, Address Book to specify destinations easily, and Forwarding to receive faxes even when you are out of the office.

NOTE

- You need to complete some procedures before using fax functions. ▶ **Configuring Initial Settings for Fax Functions(P. 106)**
- You need to register destinations in the Address Book before using this feature. ▶ **Registering in the Address Book(P. 60)**

■ Specifying Fax Settings

▶ **Configuring Initial Settings for Fax Functions(P. 106)**

■ Using Basic Operations

▶ **Sending Faxes(P. 114)**

▶ **Canceling Sending Faxes(P. 140)**

▶ **Receiving Faxes(P. 142)**

■ Specifying Scanning Settings



▶ **Adjusting Resolution(P. 134)**



▶ **Adjusting Density(P. 135)**



▶ **Adjusting Sharpness(P. 136)**



▶ Scanning 2-Sided Documents
(MF249dw)(P. 138)

■ Specifying Destinations Simply and Quickly



▶ Specifying from Address Book(P. 121)



▶ Selecting Destinations Directly by Entering Coded Dial Numbers(P. 124)

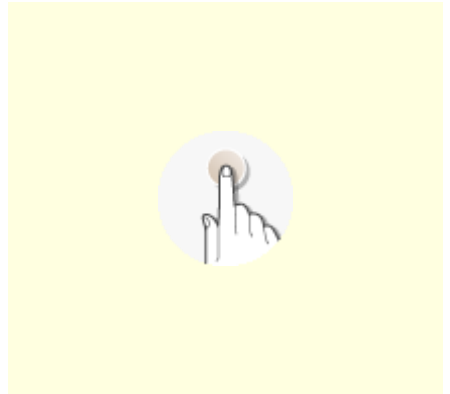

▶ Specifying Destinations with the One-Touch Buttons(P. 127)

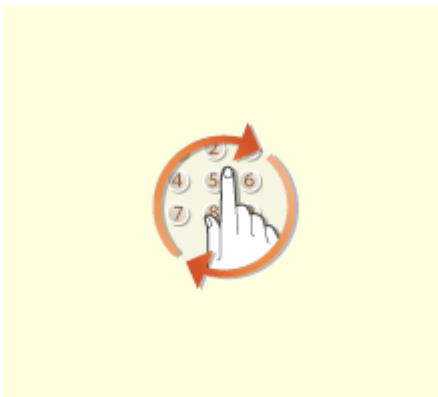

▶ Specifying Previously Used Destinations(P. 130)

■ Sending and Receiving According to Your Purposes

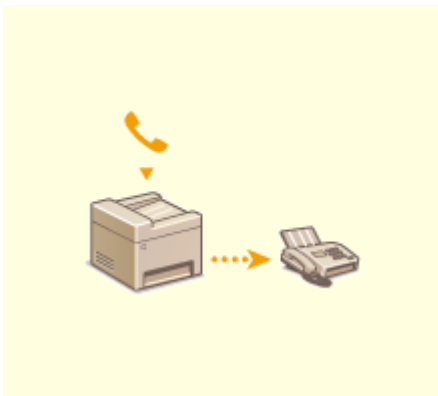

▶ Making a Call before Sending Faxes (Manual Sending)(P. 147)

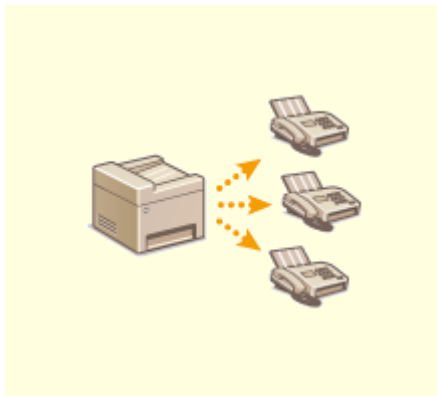

▶ Sending Faxes to Multiple Destinations Simultaneously (Sequential Broadcast)(P. 148)

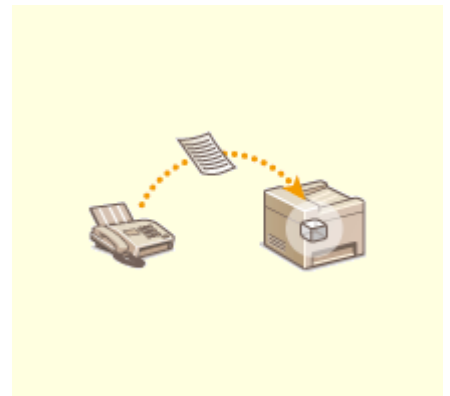

▶ Storing Received Faxes into Memory (Memory Reception) (P. 150)

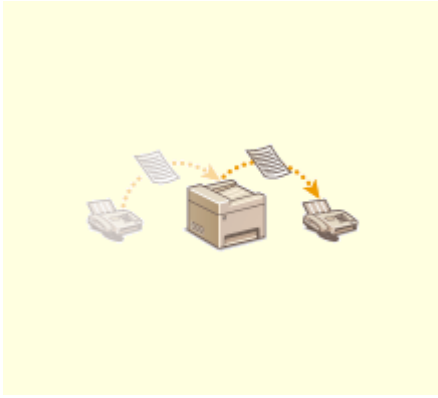

▶ Forwarding Received Faxes(P. 154)

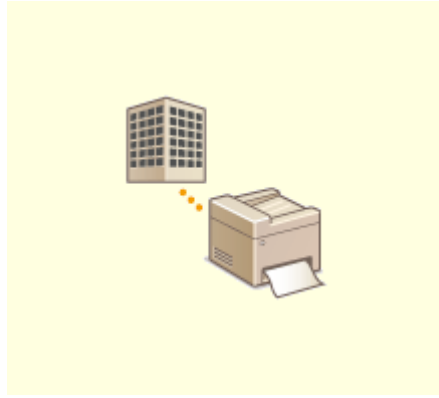

▶ Receiving Fax Information Services(P. 161)

■ Sending Faxes Directly from Your Computer

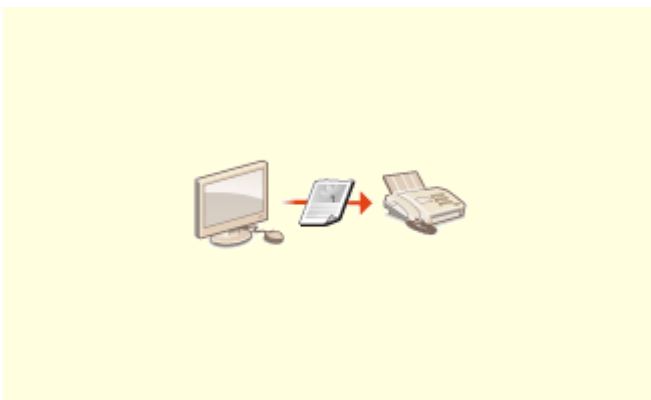

▶ Sending Faxes from Your Computer (PC Fax)(P. 167)

Configuring Initial Settings for Fax Functions



14L7-021

Follow steps 1 to 4 described below to configure the fax settings. First, determine which receive mode best suits your intended use, and then follow the on-screen instructions to configure the settings. For more information about a particular step, click on the link to go to the corresponding section.

Step 1**▶ Deciding Which Fax Receive Mode to Use(P. 107)****Step 2****▶ Registering the Fax Number and Unit Name(P. 108)****Step 3****▶ Selecting the Receive Mode(P. 110)****Step 4****▶ Connecting the Telephone Line(P. 112)**

Deciding Which Fax Receive Mode to Use

Before configuring the fax settings, determine which receive mode best suits your intended use.

Intended use	Receive mode
Use fax only/Never use telephone 	<Auto> This setting is for when you want to use the machine exclusively for receiving faxes, and you do not want to use the telephone or optional handset.
Mostly use telephone/Almost never use fax 	<Manual> Connect your telephone to the machine. This setting is for when you mostly want to use the telephone. You can receive incoming faxes manually.
Use both fax and telephone 	Use answering machine <Answering Machine> Connect your answering machine. Callers can record a message if they call while you are away from the telephone. The machine automatically receives incoming faxes.
	Use standard telephone <Fax/Tel (Auto Switch)> Connect your telephone. The machine automatically receives incoming faxes, and the telephone rings for incoming calls.

NOTE

- Depending on the type of telephone connected to it, the machine may not be able to send or receive faxes properly.
- You may be able to manually set a receive mode other than those described above, depending on your country or region.

▶ **Receiving Faxes(P. 142)**

» Continue to ▶ **Registering the Fax Number and Unit Name(P. 108)**

LINKS

▶ **Receiving Faxes(P. 142)**

Registering the Fax Number and Unit Name

14L7-023

Register the fax number and unit name of your machine. This information is printed at the top of each page sent from the machine.

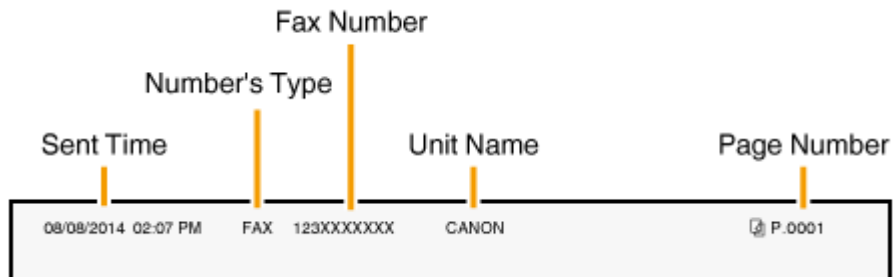

- 1 Press and tap <Menu>.

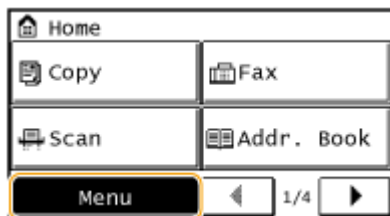

- 2 Tap <Fax Settings> ► <Fax Setup Guide>.

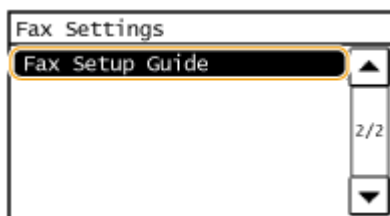

- 3 Tap <Set Up Now>.

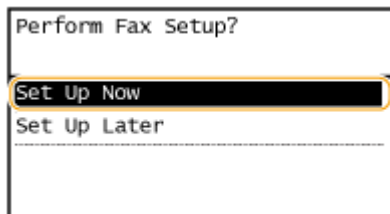

NOTE:

If you select <Set Up Later>, the receive mode is set to <Auto>.

- 4 Tap <Next>.

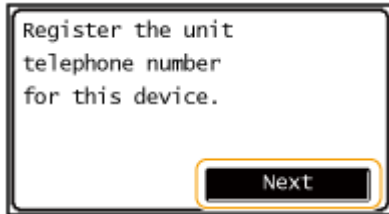

5 Enter the fax number using the numeric keys ([▶Entering Text\(P. 38\)](#)), and tap **<Apply>**.

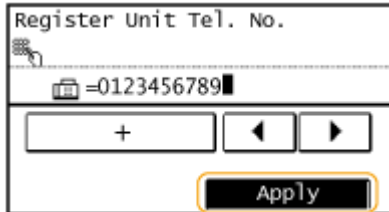

6 Tap **<Next>**.

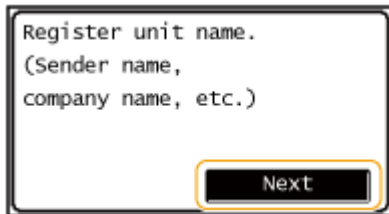

7 Enter the unit name (such as a user name or company name) ([▶Entering Text\(P. 38\)](#)), and tap **<Apply>**.

- Enter up to 24 alphanumeric characters.
- Tapping **<A/a/12>** toggles the input modes.

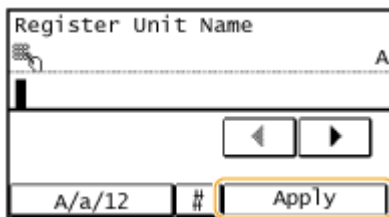

» Continue to [▶Selecting the Receive Mode\(P. 110\)](#)

LINKS

[▶Receiving Faxes\(P. 142\)](#)

Selecting the Receive Mode

Select the receive mode that suits your intended use beforehand (▶ **Deciding Which Fax Receive Mode to Use(P. 107)**).

1 Tap <Next>.

- The screen shown here is displayed after the unit name has been registered (▶ **Registering the Fax Number and Unit Name(P. 108)**).

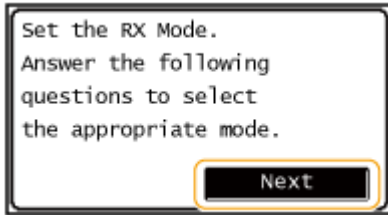

2 Select the receive mode that suits your intended use.

- Select the receive mode with tapping <Yes> or <No>.

NOTE:

You may be able to manually set a receive mode other than those described below, depending on your country or region. ▶ **Receiving Faxes(P. 142)**

■ To set the receive mode to <Auto>

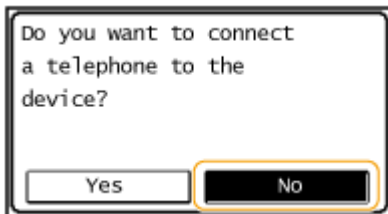

■ To set the receive mode to <Fax/Tel (Auto Switch)>

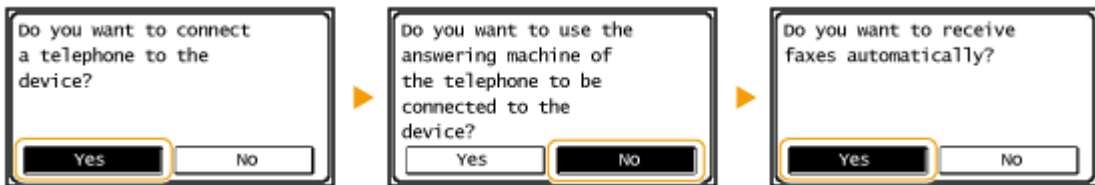

■ To set the receive mode to <Answering Machine>

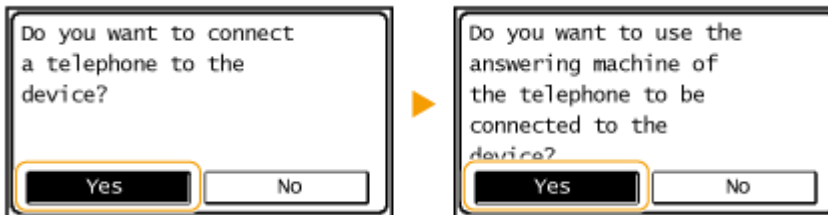

■ To set the receive mode to <Manual>

Faxing

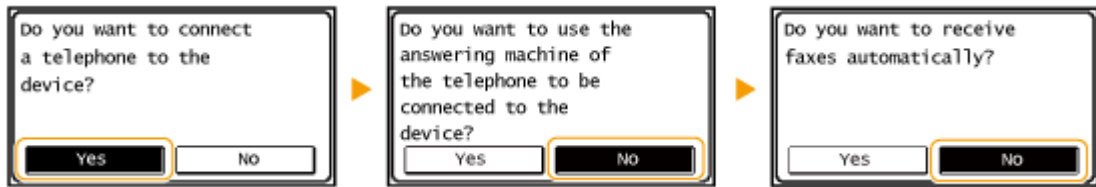

3 Tap <Apply>.

» Continue to [Connecting the Telephone Line\(P. 112\)](#)

LINKS

[Receiving Faxes\(P. 142\)](#)

Connecting the Telephone Line

Connect the telephone line to the machine.

1 Tap <Next>.

- One of the screens shown here is displayed after the receive mode has been set (**Selecting the Receive Mode(P. 110)**).

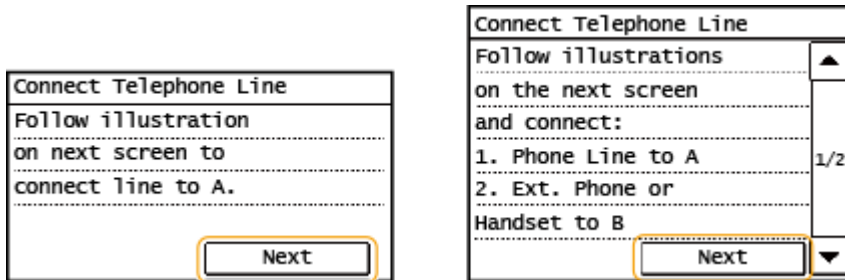

2 Connect the telephone line to the machine.

- Connect the telephone cable to the telephone line jack on the machine (**A**) and the telephone line jack on the wall.
- If you are using an optional handset or external telephone, connect it to the external telephone jack (**B**).

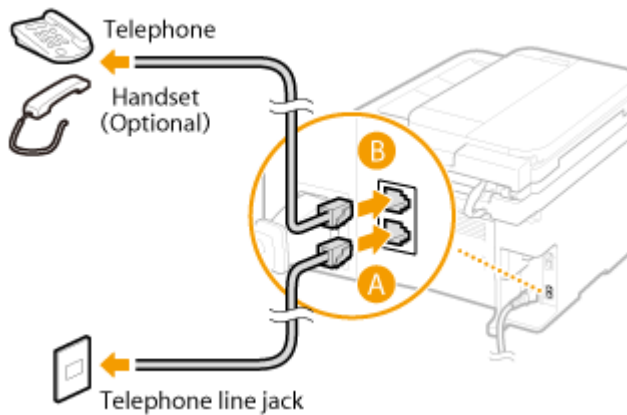

NOTE:

If you are connecting an external telephone with fax functions, set up the telephone to receive faxes manually.

3 Tap <Next> after the telephone line has been connected.

4 Tap <Yes>.

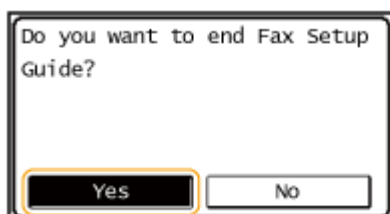

If the machine does not automatically set the type of telephone line

Follow the procedure below to set the type of telephone line. If you are not sure of the type of phone line you are using, contact your local telephone company. <Select Line Type> may not be available depending on the country where you are using the machine.



<Menu> ▶ <Fax Settings> ▶ <Basic Settings> ▶ <Select Line Type> ▶ Select the type of telephone line ▶ 

Select Line Type
Pulse
Tone

LINKS

- ▶ **Installation(P. 3)**
- ▶ **Sending Faxes(P. 114)**
- ▶ **Receiving Faxes(P. 142)**

Sending Faxes

14L7-026

IMPORTANT

To prevent missending of a fax, always press  first.

* Destinations set by the previous user may remain.

NOTE

You need to complete some procedures before using fax functions. [▶Configuring Initial Settings for Fax Functions\(P. 106\)](#)

1 Place the document(s). [▶Placing Documents\(P. 41\)](#)

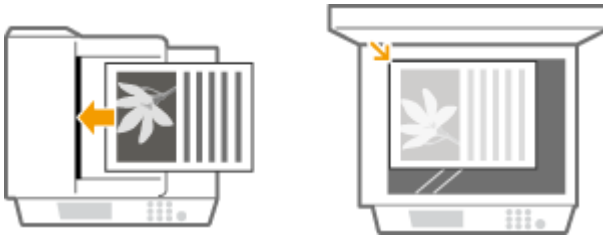

2 Press and tap <Fax>.

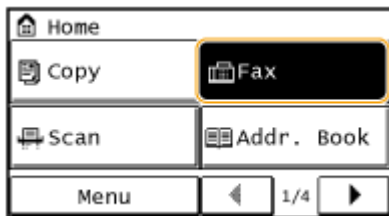

3 Specify a destination.

■Specifying destinations using the numeric keys

Enter the destination using the numeric keys, and tap <Apply>.

- If your machine is connected to a PBX (Private Branch Exchange), tap <R> before entering the destination. If <R> is not available, you need to register the R-key settings. [▶R-Key Setting \(P. 498\)](#)
- If you enter the wrong characters, press . (Press to delete each character one by one; press and hold to delete all the input characters at once.)

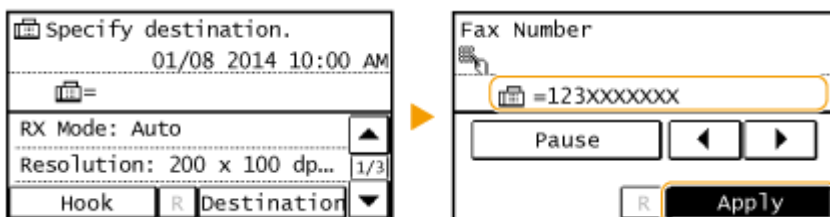

To send overseas

Enter the international access code, the country code, the area code, and the fax number to specify the destination.

- 1 Enter the international access code.

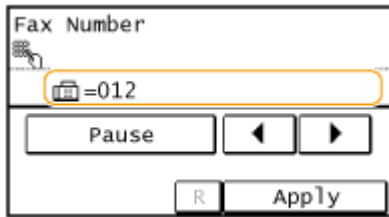

- 2 Tap <Pause>.

- <p> (pause) is inserted between numbers. In this case, 012 will be dialed first, then 2 seconds later, the next number will be dialed.

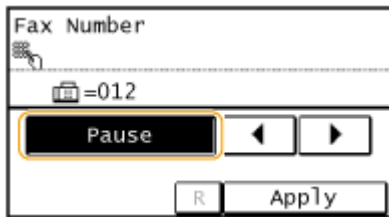

NOTE:

- Inputting pauses is optional; however, consecutive numbers that are input without pauses may not be recognized correctly.
- Pauses can be inserted continuously.
- One pause inserts 2 seconds of waiting time. This time can be changed as necessary. **▶Set Pause Time(P. 499)**

- 3 Enter the country code, the area code, and the fax number.

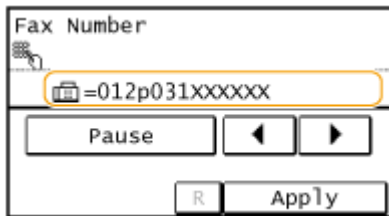

- 4 Tap <Pause> to insert a pause at the end of the fax number as necessary.

- The waiting time inserted here is fixed to 10 seconds. This time cannot be changed.

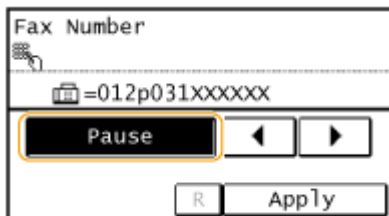

- 5 Tap <Apply>.

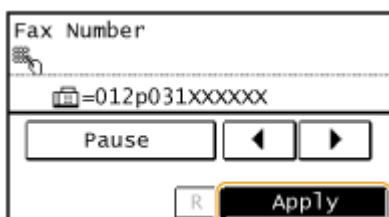

NOTE:

When <Confirm Entered Fax Number> is set to <On>, a screen appears that prompts you to enter the destination again (**▶Checking Destinations before Sending Documents(P. 420)**). Enter the same destination again for confirmation.

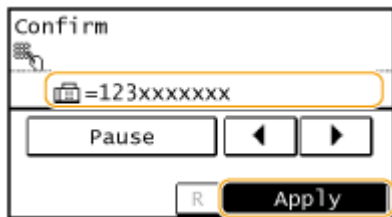

■Specifying Destinations from Address Book

1 Tap <Destination>.

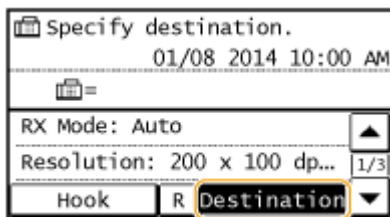

2 Tap <Specify from Address Book>.

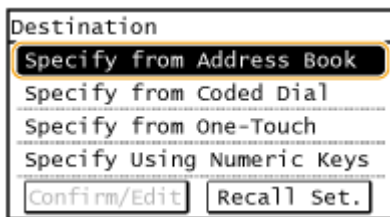

3 Use ◀/▶ to select tab.

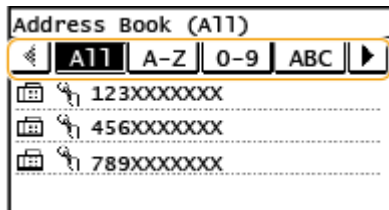

<All>

Displays all the destinations registered in the Address Book. For the marks beside the destinations, see the explanations below.

<A-Z>/<0-9>/<ABC> to <YZ>

Displays destinations with recipient names whose first characters correspond to the characters of the selected tab.

<☎>

Displays destinations for faxes.

<✉>

Displays destinations for sending e-mail. Do not use in this procedure.

▶Specifying from Address Book(P. 121)

<📁>

Displays destinations for shared folders. Do not use in this procedure.

▶Specifying from Address Book(P. 121)

<👤>

Displays a list of destinations registered in Group Dial.



Only destinations for one-touch dialing are displayed.

- 4 Select a destination.

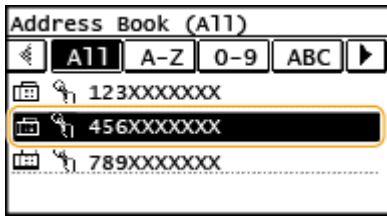

■ Specifying Destinations Entering Coded Dial Numbers Directly

- 1 Tap <Destination>.

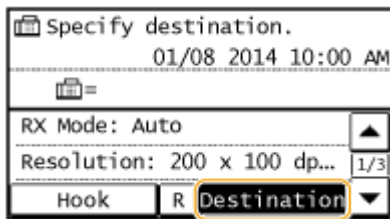

- 2 Tap <Specify from Coded Dial>.

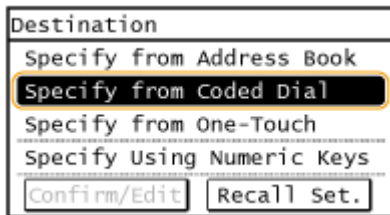

- 3 Use the numeric keys to enter a three-digit number (001 to 100).

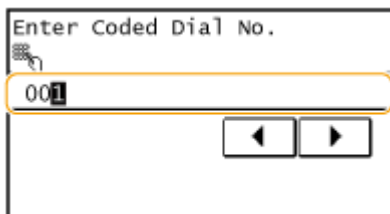

■ Specifying Destinations from One-Touch

- 1 Tap <Destination>.

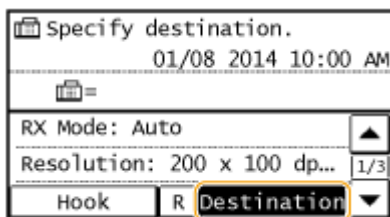

- 2 Tap <Specify from One-Touch>.

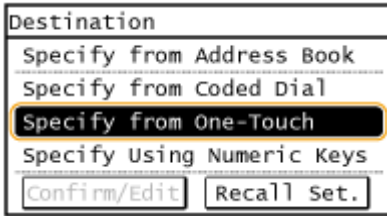

- 3 Select a destination.

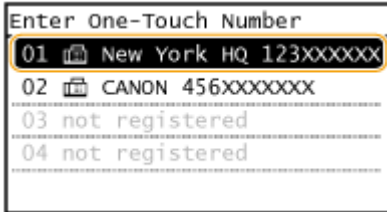

4 Specify the scanning settings as necessary.

- Select the settings. ▶ **Various Fax Settings(P. 133)**

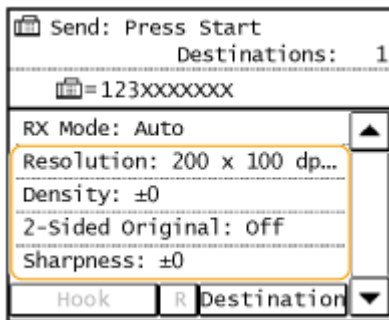

5 Press to start sending.

- Scanning starts.
- If you want to cancel sending, press  ▶ Tap <Yes>.

■ When placing documents in the feeder in step 1

When scanning is complete, the faxes are sent.

■ When placing documents on the platen glass in step 1

Follow the procedures below.

- 1 Select the document size.
 - When there is only one page to be scanned, proceed to step 3.
- 2 Place the next document on the platen glass, and press .
 - Repeat this step until you finish scanning all of the pages.
- 3 Tap <Start TX>.
 - The faxes are sent.

- If you always want to send faxes with the same settings:
 - ▶ **Changing Default Settings(P. 139)**
- If you want to sound an alarm when the handset is off the hook:
 - ▶ **Off-Hook Alarm (P. 497)**

LINKS

- ▶ **Canceling Sending Faxes(P. 140)**
- ▶ **Sending and Receiving Faxes According to Your Purposes(P. 146)**
- ▶ **Checking Status and Log for Sent and Received Documents(P. 163)**
- ▶ **Specifying from Address Book(P. 121)**
- ▶ **Selecting Destinations Directly by Entering Coded Dial Numbers(P. 124)**
- ▶ **Specifying Destinations with the One-Touch Buttons(P. 127)**

Sending from Registered Destinations

14L7-027

You can specify destinations by selecting them from the Address Book, coded dial numbers, or one-touch buttons, as well as by using the numeric keys. To use the Address Book, coded dial numbers, or one-touch buttons, you need to register destinations beforehand. You can also specify previously used destinations.



▶ **Specifying from Address Book(P. 121)**



▶ **Selecting Destinations Directly by Entering Coded Dial Numbers(P. 124)**



▶ **Specifying Destinations with the One-Touch Buttons(P. 127)**



▶ **Specifying Previously Used Destinations(P. 130)**

TIPS for Enhancing Security

- If you want to limit available destinations to ones from the Address Book or previously specified ones:
 - ▶ **Limiting Available Destinations(P. 417)**
- If you want to disable specifying previously used destinations:
 - ▶ **Disabling Use of Previously Used Destinations(P. 419)**

LINKS

- ▶ **Sending Faxes(P. 114)**
- ▶ **Registering in the Address Book(P. 60)**

Specifying from Address Book



The Address Book enables you to specify a destination by selecting from a list of registered destinations or by searching by name for destinations with recipient names.

NOTE

You need to register destinations in the Address Book before using this feature.

▶ **Registering in the Address Book(P. 60)**

1 Press and tap <Addr. Book>.

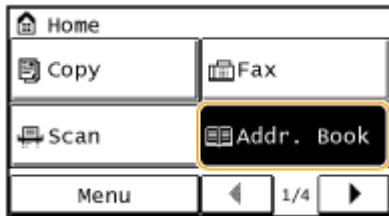

2 Use / to select a tab.

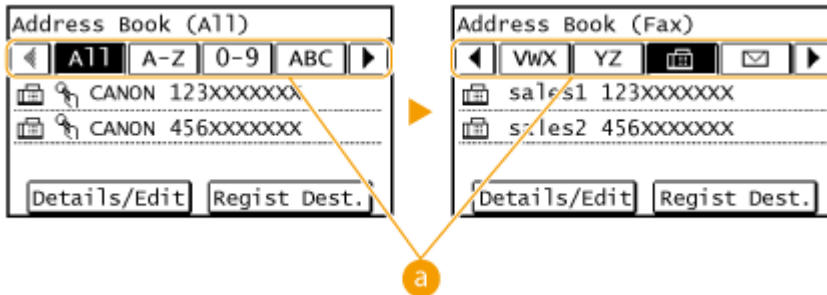

a <All>

Displays all the destinations registered in the Address Book.

<A-Z>/<0-9>/<ABC> to <YZ>

Displays destinations with recipient names whose first characters correspond to the characters of the selected tab.

< >

Displays destinations for faxes.

< >

Displays destinations for sending e-mail. Do not use in this procedure.

▶ **Specifying from Address Book(P. 273)**

< >

Displays destinations for shared folders. Do not use in this procedure.

▶ **Specifying from Address Book(P. 273)**

< >

Displays a list of destinations registered in Group Dial.



Only destinations for one-touch dialing are displayed.

3 Select a destination.

NOTE:

If you want to specify multiple destinations

- Repeat the following steps. You can specify up to 104 destinations.
<Destination> ▶ <Specify from Address Book> ▶ Select a tab ▶ Select a destination.
- To specify any additional destinations with the numeric keys, tap <Destination> ▶ <Specify Using Numeric Keys>.

4 Specify the scanning settings as necessary.

- Select the settings. ▶ **Various Fax Settings(P. 133)**

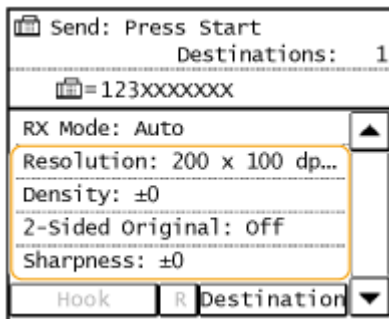

5 Press to start sending.

- Scanning starts.
- If you want to cancel sending, press ▶ Tap <Yes>.

■ To delete destinations

If you specified multiple destinations, you can delete destinations as necessary.

- 1 Select <Destination> ▶ <Confirm/Edit>.

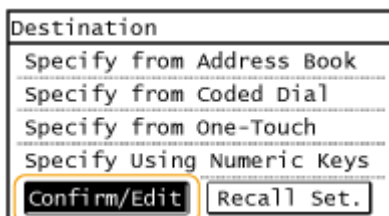

- 2 Select a destination you want to delete.



3 Tap <Remove> ► <Yes>.

- If you specified Group Dial in step 2, "XX destination(s)" is displayed. Tapping Number of Destinations displays destinations registered in the group.

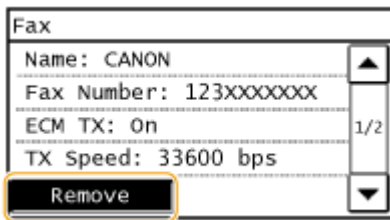

NOTE

If you want to easily and quickly delete destinations without displaying a list of destinations

Before tapping <Destination> in step 1, you can tap ◀ / ▶ to toggle the destinations you specified. Display a destination you want to delete, and press **C**.

LINKS

▶ **Sending Faxes(P. 114)**

▶ **Sending Faxes to Multiple Destinations Simultaneously (Sequential Broadcast)(P. 148)**

Selecting Destinations Directly by Entering Coded Dial Numbers



You can directly enter the three-digit number (coded dial number) for a destination to send a fax.

NOTE

You need to register destinations in the coded dial numbers before using this feature.

▶ **Registering Destinations in the Address Book(P. 61)**

1 Press and tap <Coded Dial>.

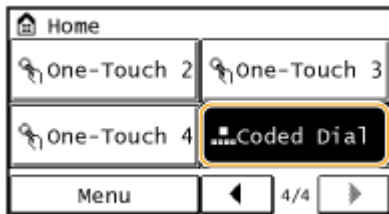

2 Use the numeric keys to enter a three-digit number (001 to 100), then tap <Apply>.

- If you enter the wrong characters, press . (Press to delete each character one by one; press and hold to delete all the input characters at once.)

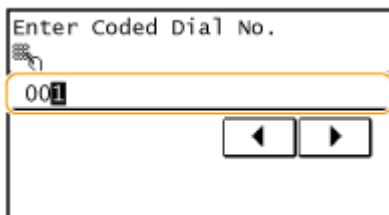

NOTE:

If a confirmation screen appears

When <One-Touch/Coded Dial TX Confirmation> is set to <On>, a screen is displayed that shows the destination and the name for the number. (For Group Dial, the group name and the number of destinations are shown.) Check the contents and if everything is correct, and tap <OK>. If destinations are incorrect, tap <Cancel> and re-enter the three-digit coded dial number. ▶ **Checking Destinations before Sending Documents(P. 420)**

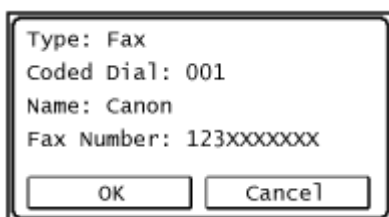

If you want to specify multiple destinations

- Repeat the following steps. You can specify up to 100 destinations.

<Destination> ▶ <Specify from Coded Dial> ▶ Enter a number.

- To specify any additional destinations with the numeric keys, tap <Destination> ▶ <Specify Using Numeric Keys>.

3 Specify the scanning settings as necessary.

- Select the settings. ▶ **Various Fax Settings(P. 133)**

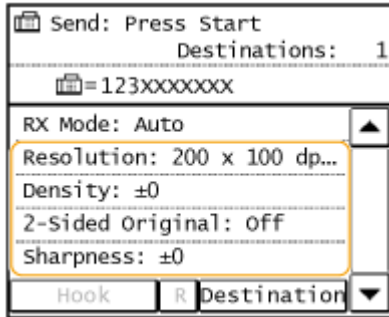

4 Press to start sending.

- Scanning starts.
- If you want to cancel sending, press  ▶ Tap <Yes>.

■ To delete destinations

If you specified multiple destinations, you can delete destinations as necessary.

- 1 Select <Destination> ▶ <Confirm/Edit>.

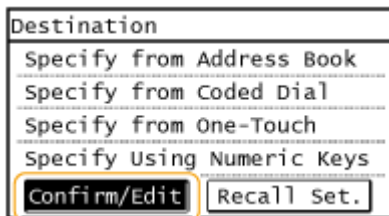

- 2 Select a destination you want to delete.



- 3 Tap <Remove> ▶ <Yes>.

- If you specified Group Dial in step 2, "XX destination(s)" is displayed. Tapping Number of Destinations displays destinations registered in the group.

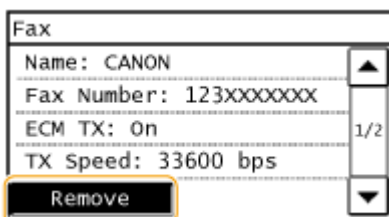

NOTE**If you want to easily and quickly delete destinations without displaying a list of destinations**

Before tapping <Destination> in step 1, you can tap ◀/▶ to toggle the destinations you specified. Display a destination you want to delete, and press .

LINKS

▶ **Sending Faxes(P. 114)**

▶ **Sending Faxes to Multiple Destinations Simultaneously (Sequential Broadcast)(P. 148)**

Specifying Destinations with the One-Touch Buttons

14L7-02A



Tap one-touch buttons in the <Home> Screen to specify destinations.

NOTE

You need to register destinations before using one-touch dialing.

▶ **Registering Destinations in the Address Book(P. 61)**

- 1 Press and tap any one of <One-Touch 1> to <One-Touch 4>.

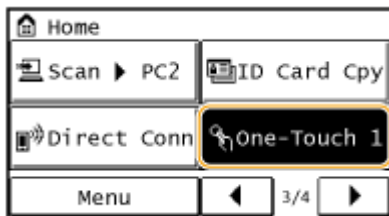

NOTE:

If a confirmation screen appears

If <One-Touch/Coded Dial TX Confirmation> is set to <On>, a confirmation screen appears with the destination and destination name registered to the one-touch button (if a destination registered for Group Dial, the group name and number of destinations appears). Confirm the destinations are correct, and tap <OK>. If destinations are incorrect, tap <Cancel> and tap the one-touch buttons again. ▶ **Checking Destinations before Sending Documents(P. 420)**

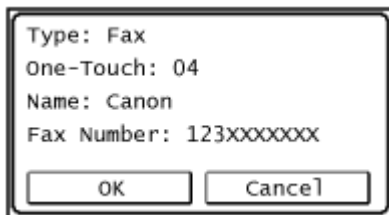

Selecting several destinations

Destinations can be added from the Address Book, coded dial numbers, one-touch dial numbers, numeric keys, and recall settings. Tap <Destination>.

- 2 Specify the scanning settings as necessary.

- Select the settings. ▶ **Various Fax Settings(P. 133)**

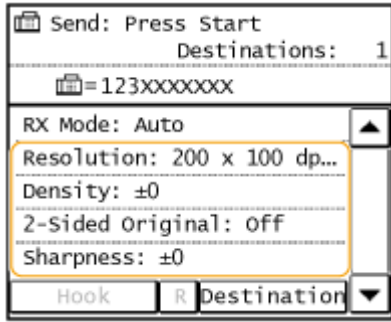

3 Press to start sending.

- Scanning starts.
- If you want to cancel sending, press  ▶ Tap <Yes>.

■ To delete destinations

If you specified multiple destinations, you can delete destinations as necessary.

- 1 Select <Destination> ▶ <Confirm/Edit>.

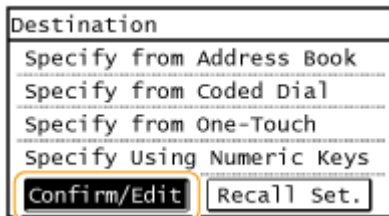

- 2 Select a destination you want to delete.



- 3 Tap <Remove> ▶ <Yes>.

- If you specified Group Dial in step 2, "XX destination(s)" is displayed. Tapping Number of Destinations displays destinations registered in the group.

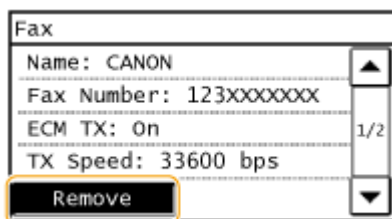

NOTE

If you want to easily and quickly delete destinations without displaying a list of destinations

Before tapping <Destination> in step 1, you can tap  /  to toggle the destinations you specified. Display a destination you want to delete, and press .

LINKS

 **Sending Faxes(P. 114)**

 **Sending Faxes to Multiple Destinations Simultaneously (Sequential Broadcast)(P. 148)**

Specifying Previously Used Destinations



You can select a destination from among the past three destinations.

IMPORTANT

- When <Restrict Resending from Log> is set to <On>, you cannot use this feature. **▶Disabling Use of Previously Used Destinations(P. 419)**
- Turning OFF the machine or setting <Restrict New Destinations> to <On> deletes the past destinations, and disables this feature. **▶Limiting Available Destinations(P. 417)**
- Destinations specified when sending a fax manually are not retained, and so do not appear in the past destinations. **▶Making a Call before Sending Faxes (Manual Sending)(P. 147)**

NOTE

When you specify a destination using this feature, any destinations that you have already specified are deleted.

1 Press and tap <Fax>.

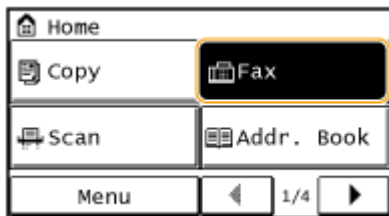

2 Select <Destination> ▶ <Recall Set.>.

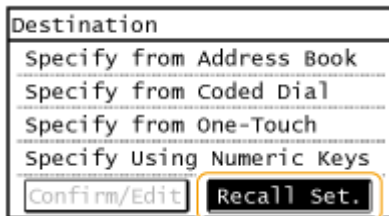

3 Select a destination.

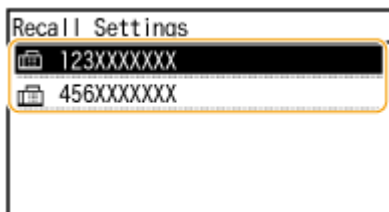

4 Specify the scanning settings as necessary.

- Select the settings. ▶ **Various Fax Settings(P. 133)**

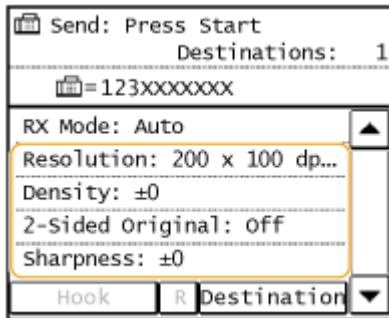

5 Press to start sending.

- Scanning starts.
- If you want to cancel sending, press  ▶ Tap <Yes>.

■ To delete destinations

If you specified multiple destinations, you can delete destinations as necessary.

- 1 Select <Destination> ▶ <Confirm/Edit>.

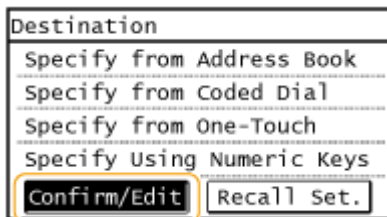

- 2 Select a destination you want to delete.



- 3 Tap <Remove> ▶ <Yes>.

- If you specified Group Dial in step 2, "XX destination(s)" is displayed. Tapping Number of Destinations displays destinations registered in the group.

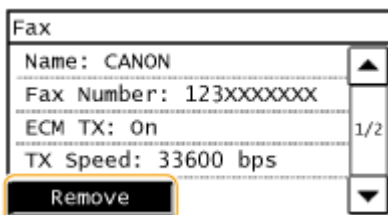

NOTE

If you want to easily and quickly delete destinations without displaying a list of destinations

Before tapping <Destination> in step 1, you can tap  /  to toggle the destinations you specified. Display a destination you want to delete, and press .

LINKS

 **Sending Faxes(P. 114)**

Various Fax Settings

14L7-02E

A variety of settings are available to suit your needs, for example, when you want to adjust density or enhance the clarity of an image.



▶ **Adjusting Resolution(P. 134)**



▶ **Adjusting Density(P. 135)**



▶ **Adjusting Sharpness(P. 136)**



▶ **Scanning 2-Sided Documents
(MF249dw)(P. 138)**

Adjusting Resolution

14L7-02F



You can select the resolution suitable for your document type. The higher the resolution is, the clearer the image becomes, but the longer it takes to send.



<Fax> ▶ <Resolution> ▶ Select the resolution

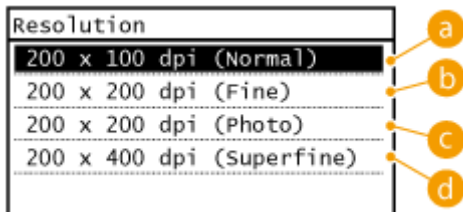

- a <200 x 100 dpi (Normal)>**
Suitable for documents that contain text only.
- b <200 x 200 dpi (Fine)>**
Suitable for documents that contain fine text.
- c <200 x 200 dpi (Photo)>**
Suitable for documents that contain photographs.
- d <200 x 400 dpi (Superfine)>**
Achieves an even finer resolution than Fine.

LINKS

🔗 **Sending Faxes(P. 114)**

Adjusting Density

14L7-02H



You can adjust the density of the fax if the text or images in a document are too light or dark.



<Fax> ▶ <Density> ▶ Adjust the density ▶ <Apply>

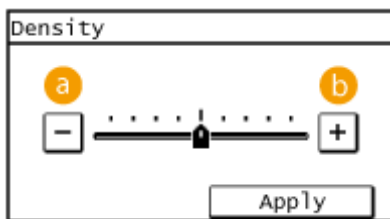

a <->

Decreases the density.

b <+>

Increases the density.

LINKS

▶ **Sending Faxes(P. 114)**

▶ **Adjusting Sharpness(P. 136)**

Adjusting Sharpness

14L7-02J



You can adjust sharpness of the image before sending. Increase the sharpness to sharpen blurred text and lines, or decrease the sharpness to improve the appearance of magazine photos.

 <Fax> ▶ <Sharpness> ▶ Adjust the sharpness ▶ <Apply>

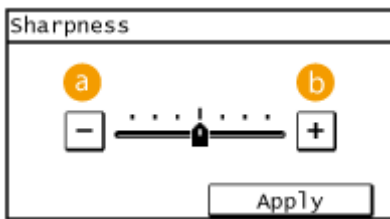

a <->

Decreases the sharpness, resulting in a softer image.

Example: If you want to improve the appearance of magazine photos

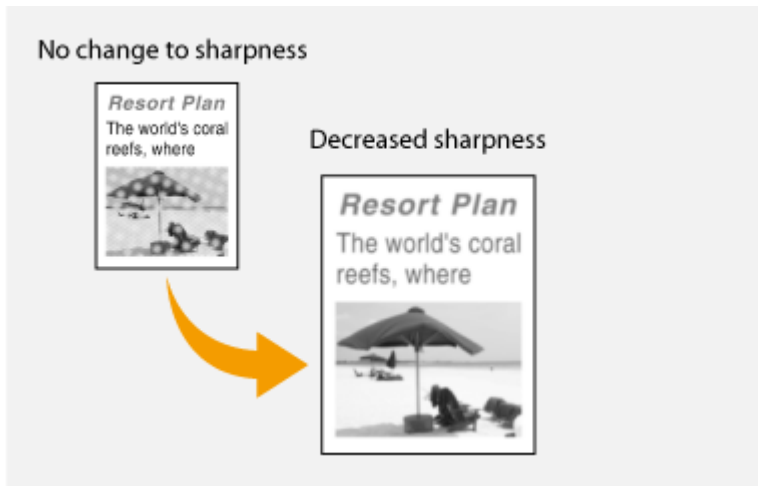

b <+>

Increases the image sharpness.

Example: If you want to sharpen text and lines written in pencil

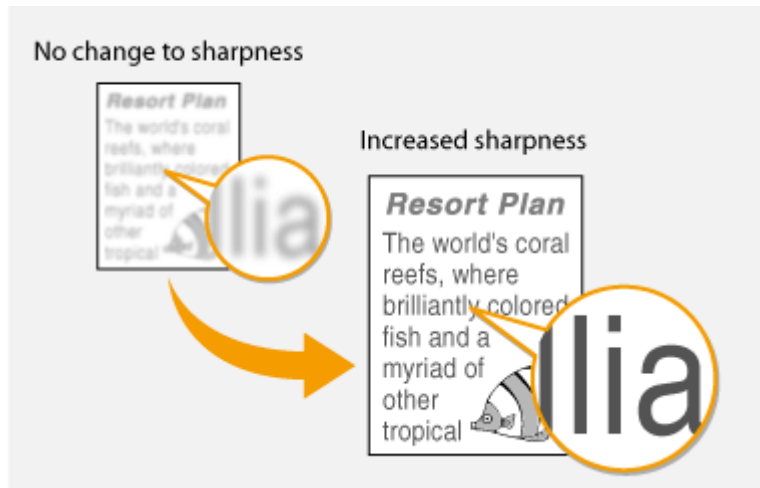

LINKS

- ▶ Sending Faxes(P. 114)
- ▶ Adjusting Density(P. 135)

Scanning 2-Sided Documents MF249dw

14L7-02K



The machine can automatically scan the front and back sides of documents in the feeder.

IMPORTANT

Place the documents in the feeder; the machine cannot scan both sides of documents automatically when the documents are placed on the platen glass or when the machine is set to Manual Sending.



<Fax> ▶ <2-Sided Original> ▶ Select <Book Type> or <Calendar Type>

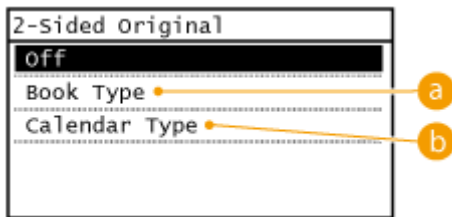

a <Book Type>

Select for documents whose images on the front and back sides face the same direction.

b <Calendar Type>

Select for documents whose images on the front and back sides face in opposite directions.

LINKS

🔗 [Sending Faxes\(P. 114\)](#)

🔗 [Making a Call before Sending Faxes \(Manual Sending\)\(P. 147\)](#)

Changing Default Settings

14L7-02L

The default settings are the settings that are displayed whenever you turn ON the machine, or when you press . If you change these default settings to match the operations that you perform frequently, you can eliminate the need to configure the same settings every time you send faxes.



<Menu> ▶ <Fax Settings> ▶ <TX Function Settings> ▶ <Change Default Settings> ▶ Select the setting ▶ Change the default value of the selected item ▶ <Apply> ▶ 

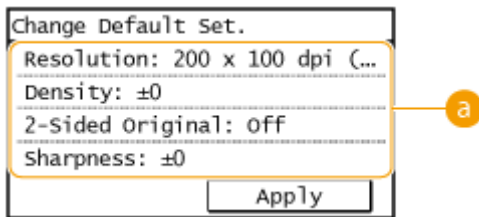



a Settings

Select the item you want to set, and change the default value.

LINKS

- ▶ **Sending Faxes**(P. 114)
- ▶ **Various Fax Settings**(P. 133)
- ▶ **Fax Settings** (P. 496)

Canceling Sending Faxes

If you want to cancel sending faxes immediately after pressing , tap <Cancel> on the display or press . You can also cancel sending faxes after checking the fax status.

■ Use <Cancel> to cancel

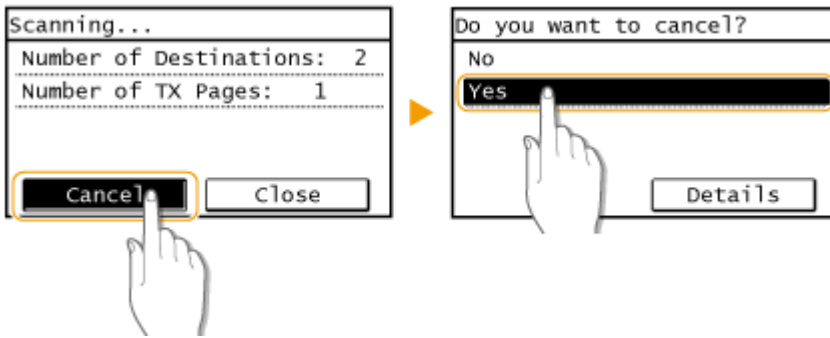

■ Press to cancel

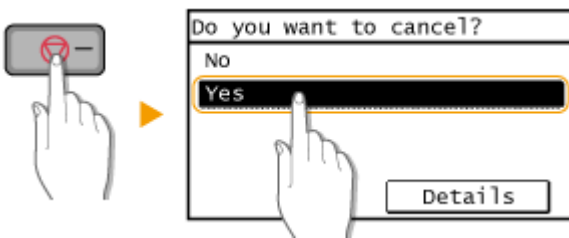

If the screen displays a list of documents when is pressed

Documents have been scanned and are waiting to be processed. Select the document to cancel.

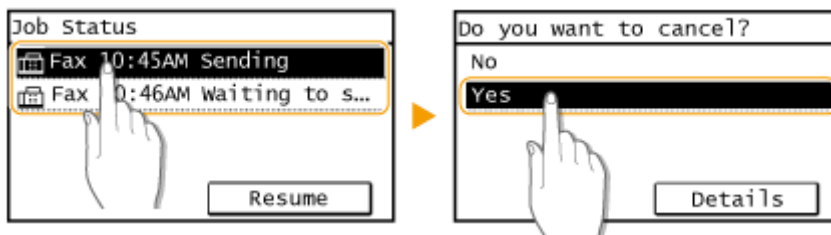

■ Use to cancel

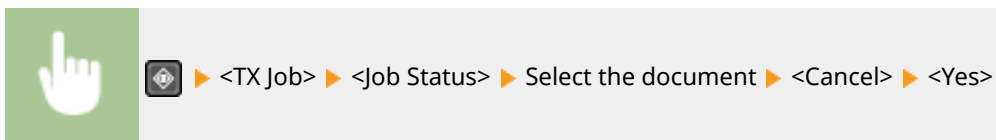

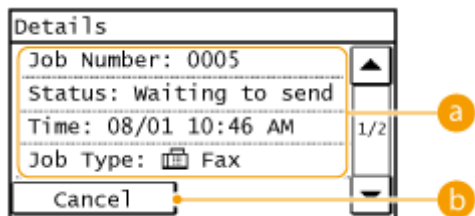

a Fax details

The number of sending document, settings, and other details are displayed. If you only want to check the details without sending, press  to return to the fax main screen.

b <Cancel>

Cancels sending.

LINKS

 [Sending Faxes\(P. 114\)](#)

 [Checking Status and Log for Sent and Received Documents\(P. 163\)](#)

Receiving Faxes

14L7-02S





This section describes the methods for receiving faxes and how to set up the machine to receive faxes. You need to complete some procedures for using fax functions before specifying the receiving settings. **▶Configuring Initial Settings for Fax Functions(P. 106)**

NOTE

The machine can print received fax documents on A4 or Letter size paper. If received fax documents are printed on other paper sizes, a portion of the page may not be printed or a page may be printed on two separate sheets of paper.

■ Methods for Receiving Faxes

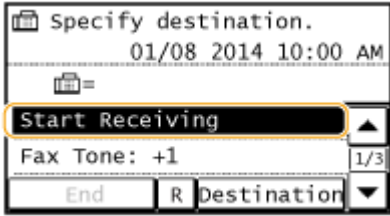
The machine provides the following receiving methods. Select the method that best suits your needs and then set it up by following the procedures in **▶Setting Up the Machine to Receive Faxes(P. 143)** .

<p><Auto></p> 	<p>Dedicated to receiving faxes The machine receives faxes automatically. Even if someone makes a call to you, you cannot talk to the caller.</p>
<p><Fax/Tel (Auto Switch)></p> 	<p>When the call is a fax The machine receives the fax automatically. When the call is a telephone call An incoming call rings. Pick up the handset to answer the call. NOTE: You need to connect your telephone or the optional handset to the machine beforehand.</p>
<p><Manual></p> 	<p>When the call is a fax An incoming call rings. Pick up the handset. If you hear a beep, tap <Start Receiving> to receive faxes.</p>  <p>When the call is a telephone call An incoming call rings. Pick up the handset. If you do not hear a beep, start your conversation. NOTE:</p> <ul style="list-style-type: none"> • You need to connect your telephone or the optional handset to the machine beforehand. • You can set the machine to automatically receive faxes when an incoming call rings within a specified timeframe. ▶Switch to Auto RX (P. 503)
<p><Answering Machine></p> 	<p>When the call is a fax After an incoming call rings, the machine receives the fax automatically. When the call is a telephone call The answering machine activates, enabling the caller to leave a message. If you pick up the handset before the answering machine starts recording a message, you can talk with the caller. NOTE:</p>

	<ul style="list-style-type: none"> • You need to connect your answering machine to the machine beforehand. • Set the answering machine to answer after a few rings. • We recommend that you add approximately 4 seconds of silence at the beginning of the message or set the maximum recording time to 20 seconds.
<p><Net Switch></p> 	<p>The machine distinguishes between fax and telephone calls. This mode is only available for Australia and New Zealand and requires subscription to a network switch service.</p> <p>NOTE: You need to connect your telephone to the machine beforehand.</p> <p>Telstra FaxStream. Duet (Only for Australia) In Australia, Telstra offers the FaxStream. Duet capability. If you subscribe to this service, your line is assigned two numbers: one for fax and one for phone. When the fax number is called, the network sends a specific ringing tone which your machine recognizes and automatically handles as a fax call. If the phone number is called, a different ringing tone is sent out from the network so that the call is handled as a voice call. This means that there is no switching delay at the caller's end. Contact Telstra for connection information.</p> <ul style="list-style-type: none"> • Triple ring (short-short-short) for fax receiving. <p>Three short rings, at regular intervals.</p> <ul style="list-style-type: none"> • Any ring except triple ring (depending on your switchboard) for telephone conversation. <p>NOTE: You need to subscribe to the FaxStream service beforehand.</p> <p>Telecom FaxAbility (Only for New Zealand) In New Zealand, Telecom N.Z. offers the FaxAbility capability. This service allows you to assign two numbers to your line: one for fax and one for telephone. When the fax number is called, the network sends a specific ring tone which your machine recognizes and automatically handles as a fax call. If the telephone number is called, a different ring tone is sent out from the network so that the call is handled as a voice call. This means that there is no switching delay at the caller's end. Contact Telecom for connection information.</p> <p>NOTE: You need to subscribe to the FaxAbility service beforehand.</p>

NOTE

- Depending on the type of telephone connected to it, the machine may not be able to send or receive faxes properly.
 - If you are connecting an external telephone with fax functions, set the telephone to not receive faxes automatically.
 - If you pick up the telephone handset and hear a beep, the call is a fax. You can receive the fax just by using the telephone to enter a specific ID number.
- ▶ **Using a Telephone to Receive Faxes (Remote Reception)(P. 145)**

■ **Setting Up the Machine to Receive Faxes**

1 Press  and tap **<Fax>**.

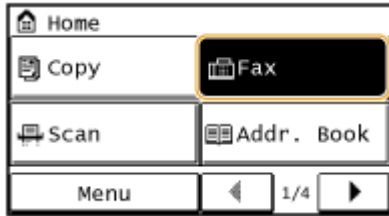

2 Tap <RX Mode>.

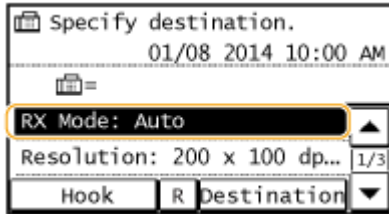

3 Select the receiving method.

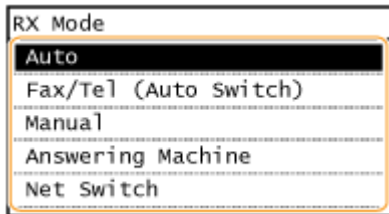

■ When selecting <Fax/Tel (Auto Switch)>

Specify the following three settings as necessary. When the setting is complete, tap <Apply>.

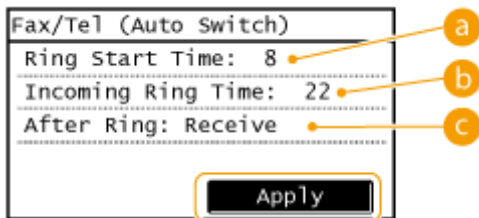

a <Ring Start Time>

Enables you to specify the duration during which the machine determines whether an incoming call is a fax or a telephone call. (Setting values: 4 to 30 seconds; default setting: 8 seconds)

b <Incoming Ring Time>

Enables you to specify the duration during which an incoming call rings for a telephone call. (Setting values: 15 to 300 seconds; default setting: 22 seconds)

c <After Ring>

Enables you to specify how the machine operates if you do not pick up the handset while an incoming call is ringing. Select <End> to disconnect the call or <Receive> to receive an incoming fax. (Default setting: <Receive>)

- If you want to print received documents on both sides of paper: [▶Print on Both Sides\(P. 504\)](#)
- If you want to print information, such as reception date and time, at the bottom of received documents: [▶RX Page Footer \(P. 505\)](#)
- If you want to continue printing even when the toner cartridge is low: [▶Continue Print. When Near Cart. Life End \(P. 506\)](#)

■ Using a Telephone to Receive Faxes (Remote Reception)

When you pick up the telephone and get a fax signal, you do not need to go to the machine to receive the fax. Just enter a specific ID number (default setting: 25) with the telephone, and you can start receiving the fax.

NOTE

When the telephone is not directly connected with the machine, the remote reception function is not available.

- 1 When an incoming call rings, pick up the telephone handset.**
- 2 If you hear a beep, enter the ID number for Remote Reception with the telephone.**
 - The ID number is set to 25 by default. You can change this number as necessary. [▶Remote RX\(P. 503\)](#)
- 3 Hang up the handset.**

LINKS

- ▶[Sending and Receiving Faxes According to Your Purposes\(P. 146\)](#)
- ▶[Checking Status and Log for Sent and Received Documents\(P. 163\)](#)

Sending and Receiving Faxes According to Your Purposes

14L7-02U

In addition to the basic sending and receiving methods, there are a variety of other methods to suit your purposes.

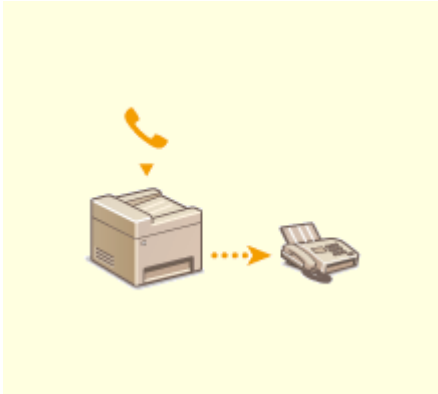

▶ **Making a Call before Sending Faxes (Manual Sending)(P. 147)**

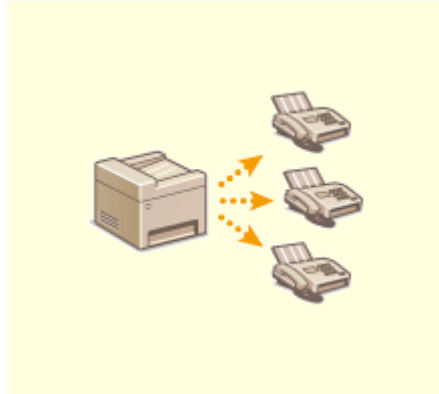

▶ **Sending Faxes to Multiple Destinations Simultaneously (Sequential Broadcast)(P. 148)**

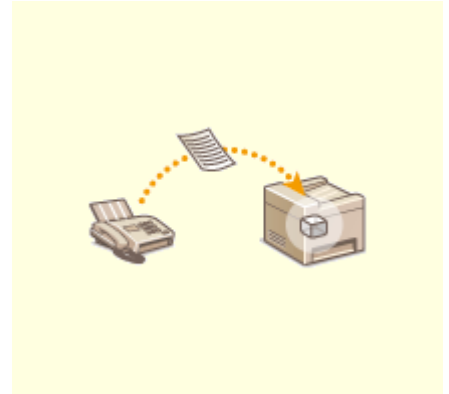

▶ **Storing Received Faxes into Memory (Memory Reception) (P. 150)**



▶ **Forwarding Received Faxes(P. 154)**

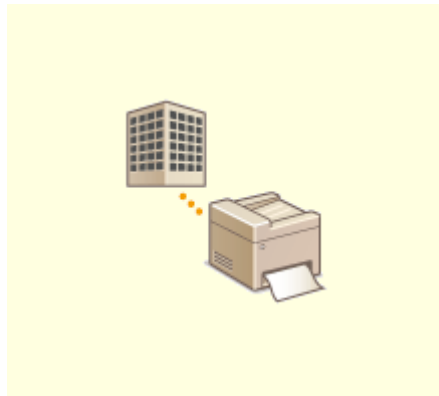

▶ **Receiving Fax Information Services(P. 161)**

LINKS

- ▶ **Sending Faxes(P. 114)**
- ▶ **Receiving Faxes(P. 142)**
- ▶ **Checking Status and Log for Sent and Received Documents(P. 163)**

Making a Call before Sending Faxes (Manual Sending)

14L7-02W



You can send faxes manually at the end of a phone conversation. When you hear a beep over the phone, it means the recipient is trying to receive your faxes. Press  to send your faxes.

NOTE

You need to connect your telephone or the optional handset to the machine beforehand.

1 Place the document(s). [Placing Documents\(P. 41\)](#)

- The machine cannot automatically scan both sides of the documents in Manual Sending.

2 Press and tap <Fax>.

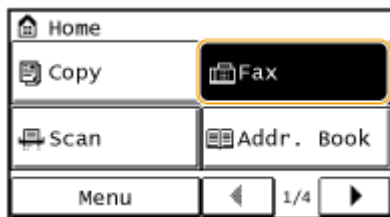

3 Specify the scanning settings as necessary. [Various Fax Settings\(P. 133\)](#)



4 Dial the recipient's fax number.

5 Ask the recipient to set their fax machine to receive your faxes.

- If you hear a beep, proceed to step 6.

6 Press , and hang up the handset.

LINKS

-  [Sending Faxes\(P. 114\)](#)
-  [Canceling Sending Faxes\(P. 140\)](#)
-  [Checking Status and Log for Sent and Received Documents\(P. 163\)](#)

Sending Faxes to Multiple Destinations Simultaneously (Sequential Broadcast)

14L7-02X

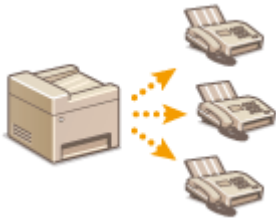

You can send faxes to up to 114 destinations at once. Use the numeric keys, the Address Book, coded dial numbers, or one-touch buttons to specify destinations.

IMPORTANT

When <Restrict Sequential Broadcast> is set to <Reject Sequential Broadcast>, you cannot use this feature.

▶ **Prohibiting Sequential Broadcasting(P. 422)**

NOTE

You need to register destinations in the Address Book or one-touch buttons before using this feature.

▶ **Registering in the Address Book(P. 60)**

▶ **Registering Destinations for One-Touch Dial(P. 65)**

1 Place the document(s). ▶ **Placing Documents(P. 41)**

2 Press  and tap <Fax>.

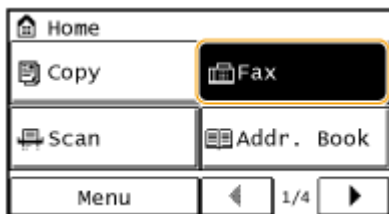

3 Specify the destination.

- To specify with the numeric keys, enter the fax number, and tap <Apply>. To specify any additional destinations, select <Destination> ▶ <Specify Using Numeric Keys> before repeating the same procedure.

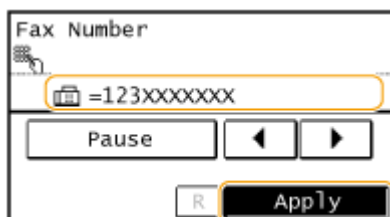

- To specify from the Address Book ▶ **Specifying from Address Book(P. 121)**

4 Specify the scanning settings as necessary.

- Select the settings. [▶Various Fax Settings\(P. 133\)](#)

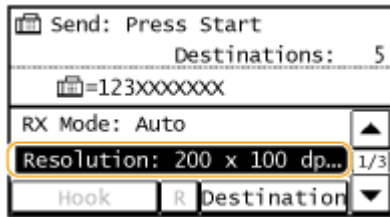

5 Press to start sending.

LINKS

- [▶Sending Faxes\(P. 114\)](#)
- [▶Canceling Sending Faxes\(P. 140\)](#)
- [▶Checking Status and Log for Sent and Received Documents\(P. 163\)](#)

Storing Received Faxes into Memory (Memory Reception)

14L7-02Y



You can store received faxes into memory, and then print them later. This feature can prevent unauthorized persons from seeing confidential documents unintentionally. You can also preview received documents using the Remote UI.

- ▶ **Storing Documents into Memory(P. 150)**
- ▶ **Printing Documents in Memory(P. 151)**
- ▶ **Checking/Deleting Documents in Memory(P. 151)**
- ▶ **Previewing Documents from the Remote UI(P. 152)**

NOTE

The documents in memory can be also forwarded to a destination. ▶ **Selecting a Document to Forward(P. 155)**

Storing Documents into Memory

To store received documents into memory, set <Memory Lock Settings> to <On>. You can also specify optional settings such as a time setting that specifies a period of time during the day in which received documents are stored in memory.



<Menu> ▶ <Fax Settings> ▶ <RX Function Settings> ▶ <Memory Lock Settings> ▶ <On> ▶ Specify each setting ▶ <Apply> ▶

- If a screen for entering a PIN is displayed, enter the PIN with the numeric keys and tap <Apply>. ▶ **Setting the System Manager PIN(P. 397)**

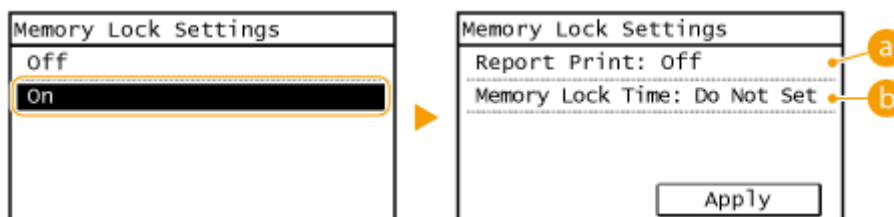

a <Report Print>

Enables you to print RX Result reports every time documents are stored into memory. To print reports, tap <On>. You also need to set <RX Result Report> to <On>. ▶ **RX Result Report(P. 613)**

b <Memory Lock Time>

Specify a period of time during the day in which received documents are stored in memory. If you do not set a period of time, the machine stores every document into memory when Memory Reception is turned on.

Printing Documents in Memory

To print received documents in memory, set <Memory Lock Settings> to <Off>. All the documents in memory are printed.

NOTE

- You cannot select a specific document for printing.
- If a time for the feature to deactivate has been specified, the documents are automatically printed at the specified time.



- If a screen for entering a PIN is displayed, enter the PIN with the numeric keys and tap <Apply>. **Setting the System Manager PIN(P. 397)**

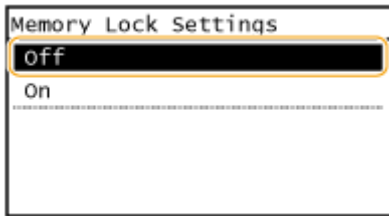

Checking/Deleting Documents in Memory

You can check detailed information about the documents stored in memory, including sender fax numbers and number of pages sent, and then delete unnecessary documents.

1 Press .

2 Tap <RX Job>.

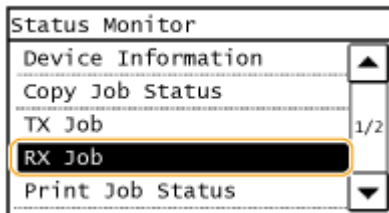

3 Tap <Job Status>.

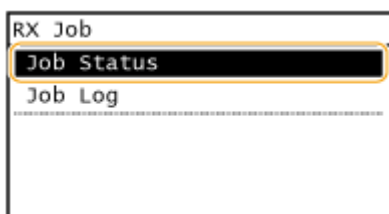

4 Select the document you want to check.

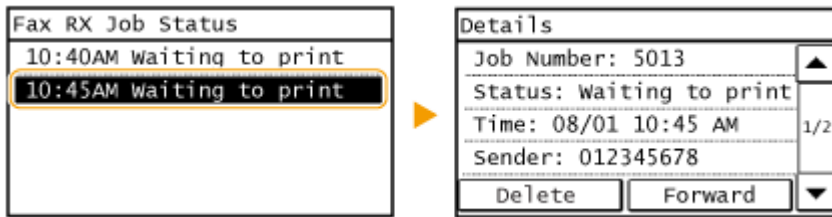

■ To delete the checked document

- 1 Tap <Delete>.

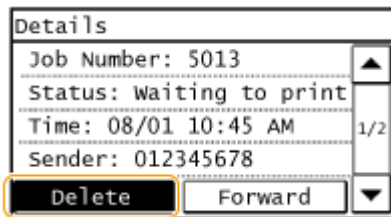

- 2 Tap <Yes>.

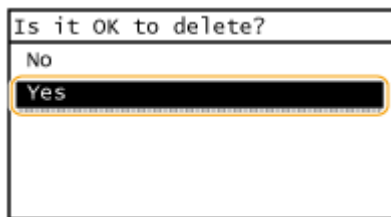

Previewing Documents from the Remote UI

From the Remote UI, you can check the content of documents saved in memory. This allows you to check whether the document is needed, and then delete it or print it.

NOTE

- You cannot select a specific document for printing.
- If a time for the feature to deactivate has been specified, the documents are automatically printed at the specified time.

- 1 Start the Remote UI and log on in System Manager Mode. Starting Remote UI(P. 450)
- 2 Click [Status Monitor/Cancel].

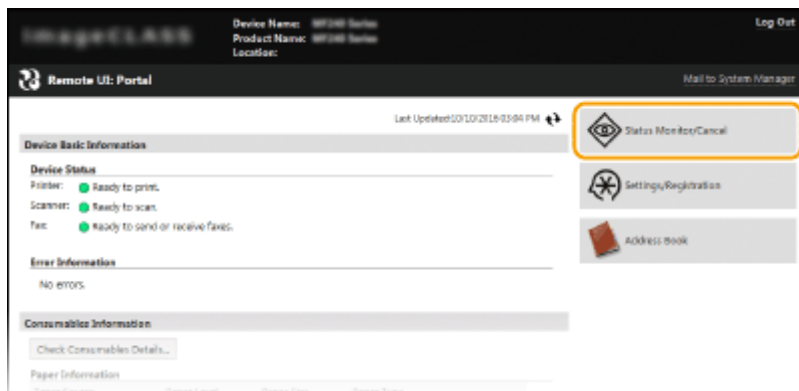

3 [RX] ▶ [Job Status] ▶ Click the document you want to check.

- Up to 3 pages starting from the top of a document can be previewed.
- Actual print results may be different from the document as previewed.

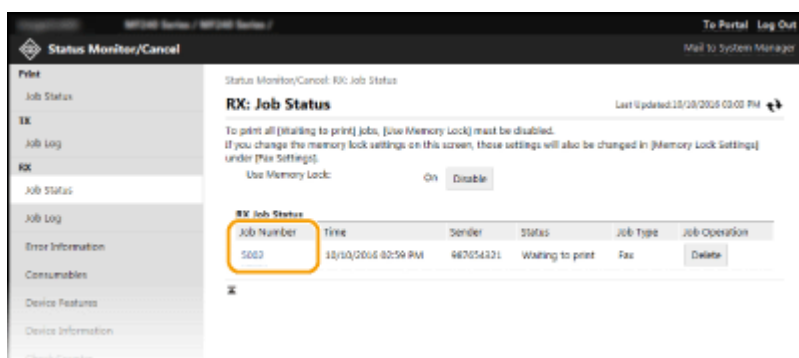

LINKS

- ▶ Receiving Faxes(P. 142)
- ▶ Checking Status and Log for Sent and Received Documents(P. 163)

Forwarding Received Faxes

14L7-030



You can forward received documents to other destinations. You can select a document from among all the documents received in memory for forwarding, or set the machine to automatically forward every received document to specified destinations.

NOTE

- Available destinations for forwarding are limited to the destinations registered in the Address Book. If no destinations are registered, register destinations in the Address Book before using this feature. ▶
Registering in the Address Book(P. 60)
- E-mail addresses and shared folders in computers can be specified as forwarding destinations on the MF249dw / MF246dn only.

Selecting a Document to Forward

14L7-031

The machine forwards the document that you select from among all the documents received in memory. To use this feature, first activate the Memory Reception feature. **▶ Storing Received Faxes into Memory (Memory Reception) (P. 150)**

NOTE

- As long as the Memory Reception feature is not deactivated, the documents in memory are not deleted even after they are forwarded; the same documents can be forwarded multiple times.
- Only fax numbers can be specified for forwarding destinations.

1 Press .

2 Tap <RX Job>.

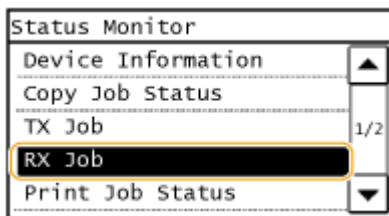

3 Tap <Job Status>.



4 Select the document you want to forward.

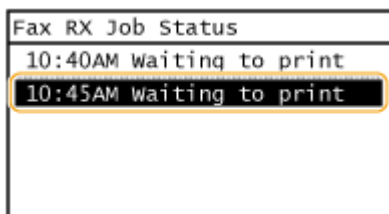

5 Tap <Forward>.

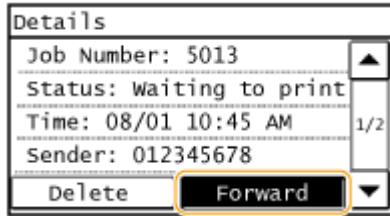

6 Select the forwarding destination from the Address Book.

- For instructions on how to use the Address Book, see [Specifying from Address Book\(P. 121\)](#) .

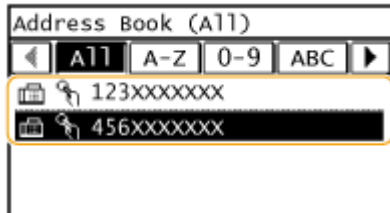

⇒ The document is forwarded to the specified destination.

Forwarding All the Received Documents Automatically

MF249dw / MF246dn

14L7-032

The machine can forward all the received documents to specified destinations. Even if you are out of the office, you can receive fax information anytime, anywhere.

- ▶ **Specifying Settings for Documents to be Forwarded Automatically(P. 157)**
- ▶ **Printing Documents to be Forwarded(P. 157)**
- ▶ **Printing/Resending/Deleting Documents that Failed to be Forwarded(P. 158)**

NOTE

- Only e-mail addresses and shared folders can be specified for forwarding destinations.
- Received documents are converted and sent as PDF files.

Specifying Settings for Documents to be Forwarded Automatically

While the Forwarding feature is activated, all the documents to be received are automatically forwarded.

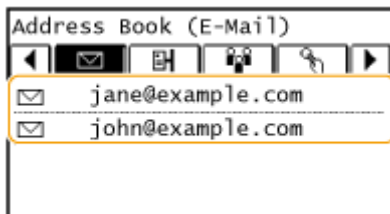
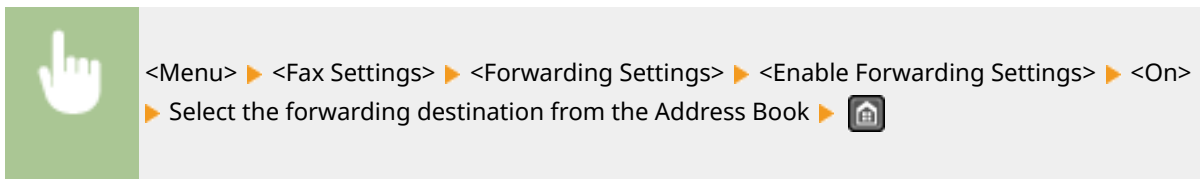

NOTE

- For instructions on how to use the Address Book, see ▶ **Specifying from Address Book(P. 121)** .

Printing Documents to be Forwarded

If you want to check the documents to be forwarded for yourself, you can set the machine to print the documents whenever they are forwarded, or to print only the documents that failed to be forwarded.

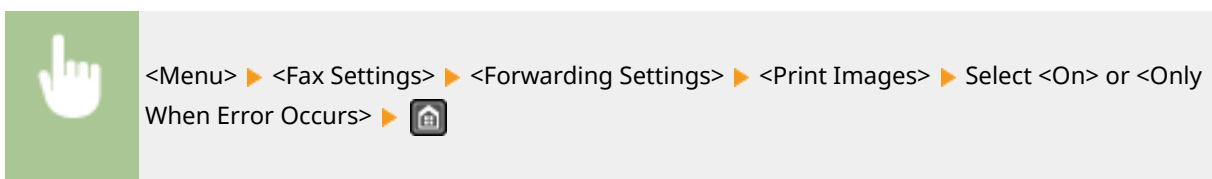

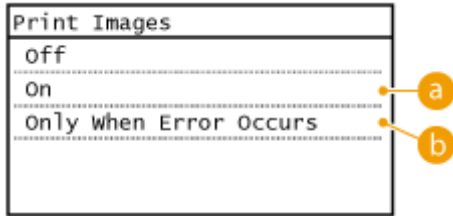

a <On>

Prints all the documents to be forwarded.

b <Only When Error Occurs>

Prints only the documents that failed to be forwarded.

Printing/Resending/Deleting Documents that Failed to be Forwarded

You can store documents that failed to be forwarded in memory, and print, resend, or delete them later.

■ **Storing Documents that Failed to be Forwarded in Memory**

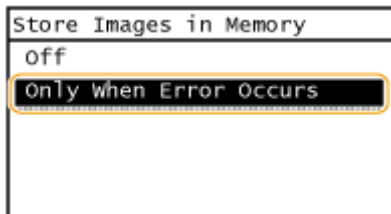
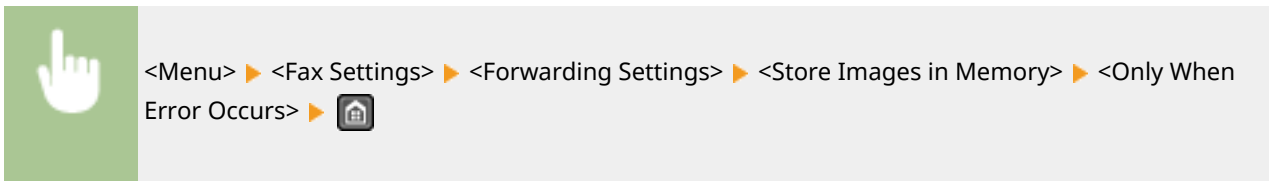

■ **Printing/Resending/Deleting Documents Stored in Memory**

1 Press .

2 Tap **<Fax Forwarding Errors>**.

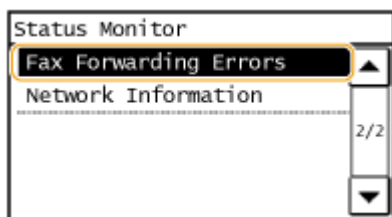

3 Select the document you want to check.

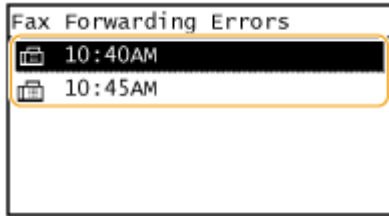

■ To print the checked document

- 1 Tap <Print/Fwd>.

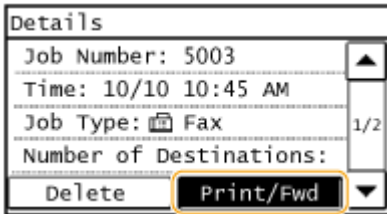

- 2 Tap <Print>.

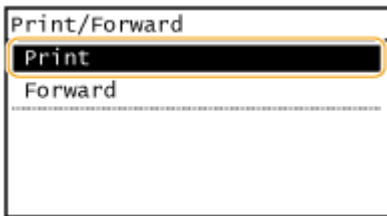

- 3 Tap <Yes>.

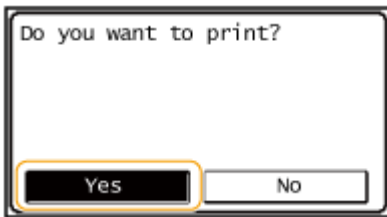

■ To resend the checked document

- 1 Tap <Print/Fwd>.

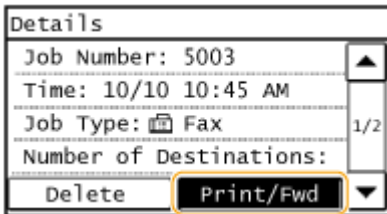

- 2 Tap <Forward>.

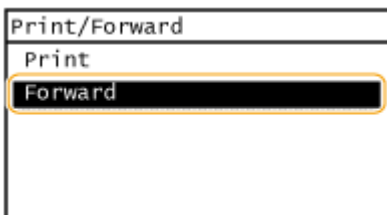

- 3 Select the forwarding destination from the Address Book.

- Only fax numbers can be specified for forwarding destinations.
- For instructions on how to use the Address Book, see [▶Specifying from Address Book\(P. 121\)](#) .

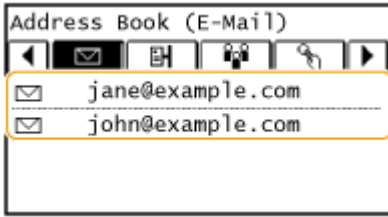

■To delete the checked document

- 1 Tap <Delete>.

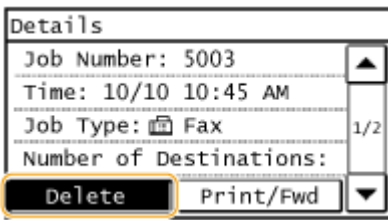

- 2 Tap <Yes>.

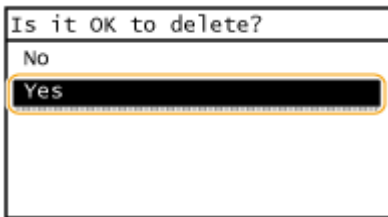

LINKS

- ▶Receiving Faxes(P. 142)
- ▶Checking Status and Log for Sent and Received Documents(P. 163)

Receiving Fax Information Services

14L7-033



Through fax information services, you can easily get a variety of helpful lifestyle and work information from companies and organizations. This section describes a typical procedure for receiving these services.

NOTE

Depending on the service, actual procedures may differ from the ones described below. Follow the procedures for the service you are using.

1 Press and tap <Fax>.

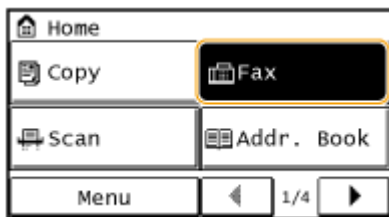

2 Tap <Hook>.

- If an external telephone or the optional handset is connected to the machine, you can pick up the handset instead of tapping <Hook>.

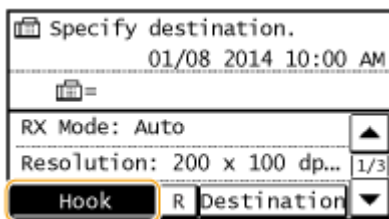

3 When you hear a dial tone, dial the information service.

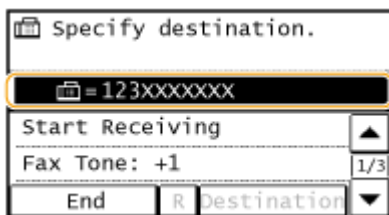

4 When the recorded message of the information service answers, press .

- This step is unnecessary if the machine is using a tone-dialing line.

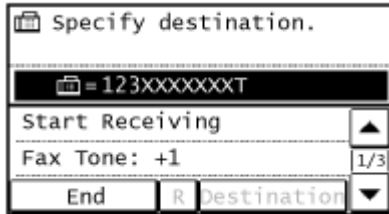

5 Use the numeric keys to enter the service number assigned for the information you want to receive.

- You can also use the keypad on the telephone to enter the information service number.

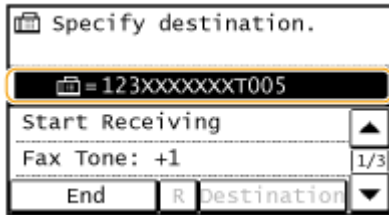

6 Tap <Start Receiving>.

- If you have picked up the handset, hang it up.

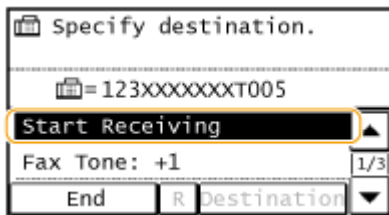

LINKS

- [Receiving Faxes\(P. 142\)](#)

Checking Status and Log for Sent and Received Documents

The statuses and communication logs for sent and received fax documents can be checked separately for sending and receiving. You can check detailed document information, including destinations and number of pages, and you can delete unnecessary documents.

IMPORTANT

When <Display Job Log> is set to <Off>, you cannot check the communication logs.

▶ [Display Job Log \(P. 532\)](#)

NOTE

The destinations in Manual Sending cannot be checked because they are not displayed.

1 Press .

2 Tap <TX Job> or <RX Job>.

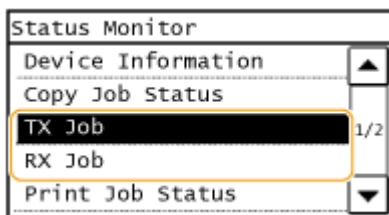

3 Check the statuses and communication logs for sent and received documents.

■ To check the statuses for sent and received documents

1 Tap <Job Status>.

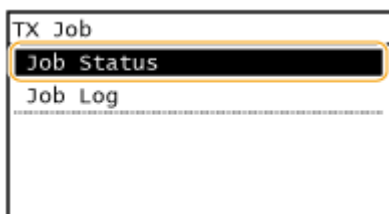

2 Select the document whose status you want to check.

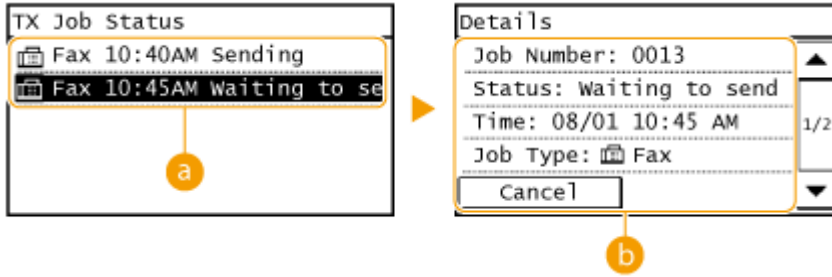

a <TX Job Status>/<Fax RX Job Status>

Displays a list of the documents that are being sent and received or are waiting to be processed.

b <Details>

Displays detailed information about the document selected from the list. If you specified multiple destinations, the number of specified destinations is displayed on the screen. To check the details of specified multiple destinations, tap <Destination>. If you find an unnecessary document, tap <Cancel> or <Delete>, and tap <Yes>.

■ To check the communication logs for sent and received documents

- 1 Tap <Job Log>.

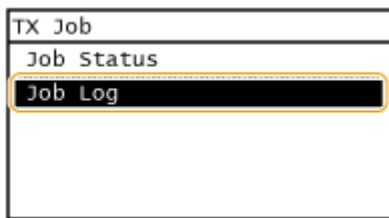

- 2 Select the document whose log you want to check.

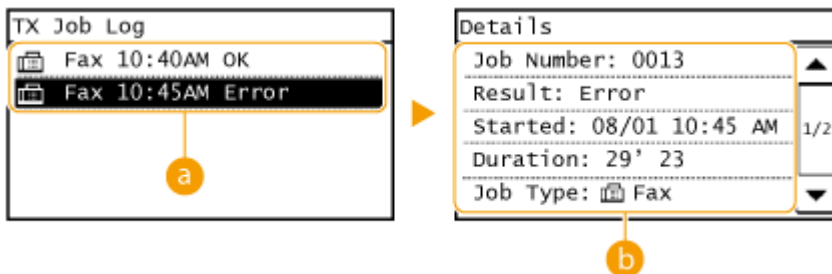

a <TX Job Log>/<Fax RX Job Log>

Displays a list of the documents that were sent and received. <OK> is displayed when a document was sent or received successfully, and <Error> is displayed when a document failed to be sent or received because it was canceled or there was some error.

b <Details>

Displays detailed information about the document selected from the list.

NOTE:

If the <Result> column shows a three-digit number

This number represents an error code. [▶ When an Error Code Appears\(P. 558\)](#)

LINKS

- ▶ [TX Result Report\(P. 608\)](#)
- ▶ [Communication Management Report\(P. 611\)](#)
- ▶ [RX Result Report\(P. 613\)](#)

Importing/Exporting Address Book Data with the Supplied Software

14L7-035

You can export Address Book data saved on the machine to a computer using the Address Book Import/Export Tool contained on the supplied DVD-ROM. The data can be re-imported, providing a secure backup in case Address Book data becomes erased due to repairs or maintenance.

NOTE

Use the Address Book Import/Export Tool with the machine and computer connected via a USB cable.

1 Press and tap <Menu>.

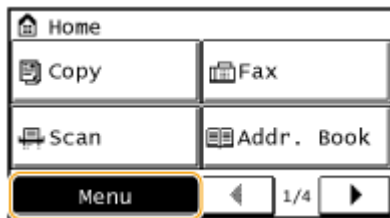

2 Tap <System Management Settings>.

- If a screen for entering a PIN is displayed, enter the PIN with the numeric keys and tap <Apply>.  **Setting the System Manager PIN(P. 397)**

3 Tap <Import/Export Address Book>.

4 Place the provided DVD-ROM in the PC.

- When the next screen appears, click [Exit].



5 [Start] ► [Computer] ► Right-click the DVD-ROM icon, and click [Open] in the pop-up menu.

6 Open the [AddressBookTool] folder, and double-click [AddressBookTool.exe].

7 Follow the on-screen instructions.

- To import Address Book data, click the [Import] tab.
- To export Address Book data, click the [Export] tab.

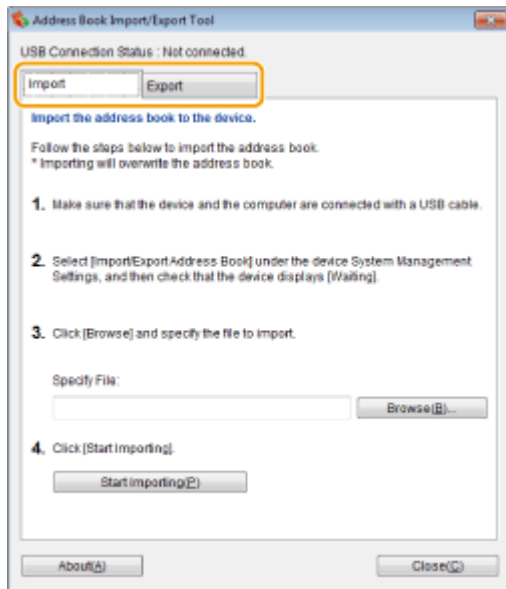

Sending Faxes from Your Computer (PC Fax)

14L7-036

You can send fax documents created on your computer application directly from your computer. This feature eliminates the need to print documents for faxing and saves paper. You need to complete some procedures, such as specifying the basic fax settings ([▶Configuring Initial Settings for Fax Functions\(P. 106\)](#)) and referring to the MF Driver Installation Guide to install the fax driver on your computer, before using this feature.



NOTE

- If you are a Mac OS user, see the Fax Driver's User's Guide for installing the fax driver and see the Fax Driver's Help for using fax functions.
- Depending on the operating system and the version of the fax driver you are using, the fax driver screens in this manual may differ from your screens.

About the Fax Driver Help

- Clicking [Help] on the fax driver screen displays the Help screen. On this screen you can see information that is not in the User's Guide, including information about driver features such as registering frequently used settings and how to set up those features.

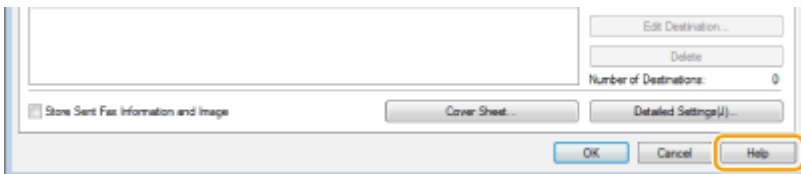

Sending PC Faxes

14L7-037

IMPORTANT

- When <Allow Fax Driver TX> is set to <Off> on the machine, you cannot send faxes from computers. **Prohibiting PC Faxing(P. 418)**

1 Open a document in an application and display the print dialog box.

- How to display the print dialog box differs for each application. For more information, see the instruction manual for the application you are using.

2 Select the fax driver for this machine, and click [Print].

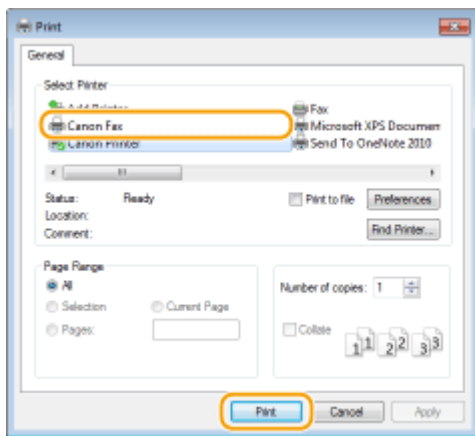

NOTE:

When sending from the Windows Store app in Windows 8/10/Server 2012

Display the charms on the right side of the screen and use the procedure shown below.

Windows 8/Server 2012

Tap or click [Devices] ► the fax driver for this machine ► [Print].

Windows 8.1/Server 2012 R2

Tap or click [Devices] ► [Print] ► the fax driver for this machine ► [Print].

Windows 10

Tap or click [Print] in the application menu ► the fax driver for this machine ► [Print].

- If you send faxes using this method, only a limited number of fax functions are available.
- If the message [The printer requires your attention. Go to the desktop to take care of it.] is displayed, go to the desktop and proceed to step 3. This message appears when the machine is set to display the user name during sending a fax and similar instances.

3 Specify the destination.

■ To specify only one destination

- 1 Click the [Enter Destination] tab.
- 2 Set the communication mode and fax number (or URI).

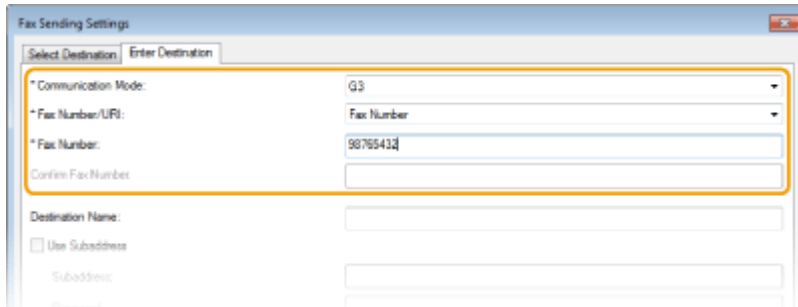

■ To specify multiple destinations at once

- 1 Click the [Select Destination] tab.
- 2 Click [Add Destination].

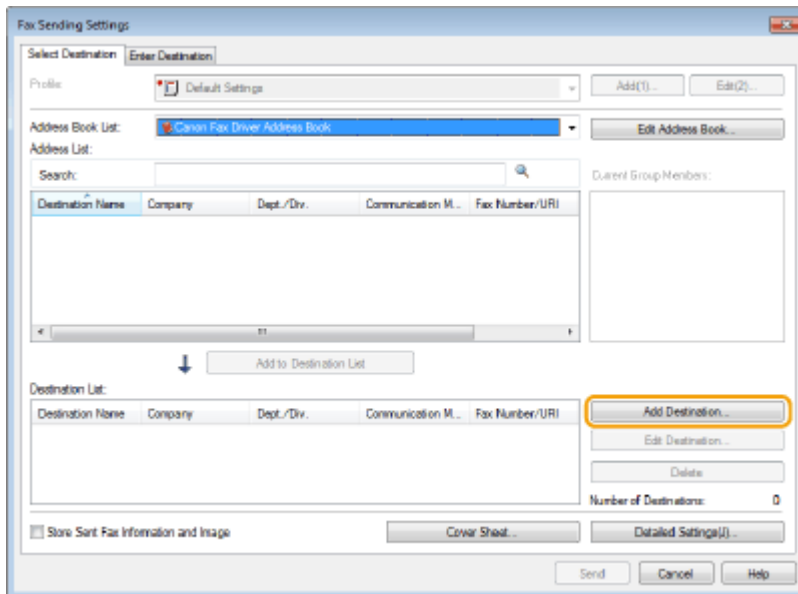

- 3 Set the communication mode and fax number (or URI), and click [OK].

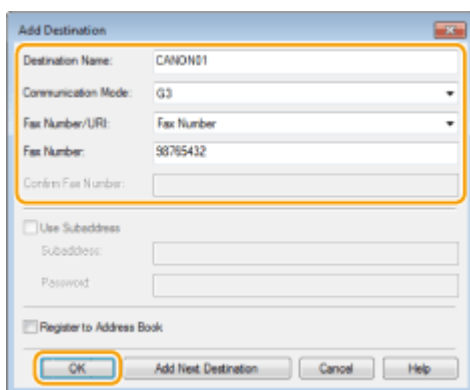

- 4 Repeat steps 2 and 3 to add concurrent destinations.
 - You can also add a destination by clicking [Add Next Destination] in step 3.
 - If you need to specify a number to dial an outside line, select [Detailed Settings] ► [Add Outside Dialing Prefix to G3/IP Fax Number] and enter the number in [Outside Dialing Prefix]. The specified number is added to the beginning of the fax number when the machine dials.

- To make it easier to specify destinations using the Address Book, see **▶Using Registered Destinations(P. 182)** .
- Selecting [Store Sent Fax Information and Image] enables you to store the logs for sending documents and check detailed information of a sent document along with its image, including destinations and number of pages. For more information, click [Help] on the fax driver screen.

NOTE:

- When the [Confirm Fax Number] or [Confirm URI] field is active, also enter the appropriate number in the field. The setting of whether to confirm entered numbers can be changed in the fax driver screen. For more information, click [Help] on the fax driver screen.

4 Attach a cover sheet to the document as necessary. ▶Attaching Cover Sheets to PC Faxes(P. 171)

5 Click [Send] to send the document.

Attaching Cover Sheets to PC Faxes

14L7-038

You can attach a cover sheet to the document you are sending. Select a cover sheet from three preset cover sheets in the fax driver, or create your own custom cover sheets. For more information, click [Help] on the fax driver screen.

1 Open a document in an application and display the print dialog box.

- How to display the print dialog box differs for each application. For more information, see the instruction manual for the application you are using.

2 Select the fax driver for this machine, and click [Print].

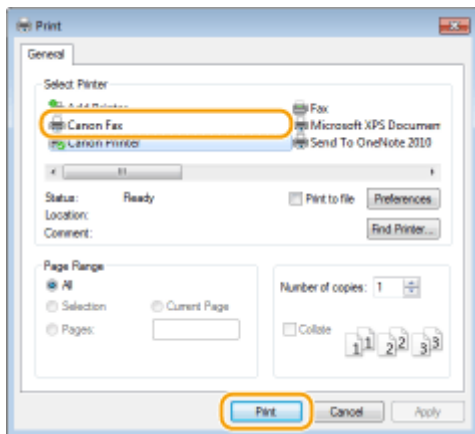

3 Click the [Cover Sheet] and specify each setting.

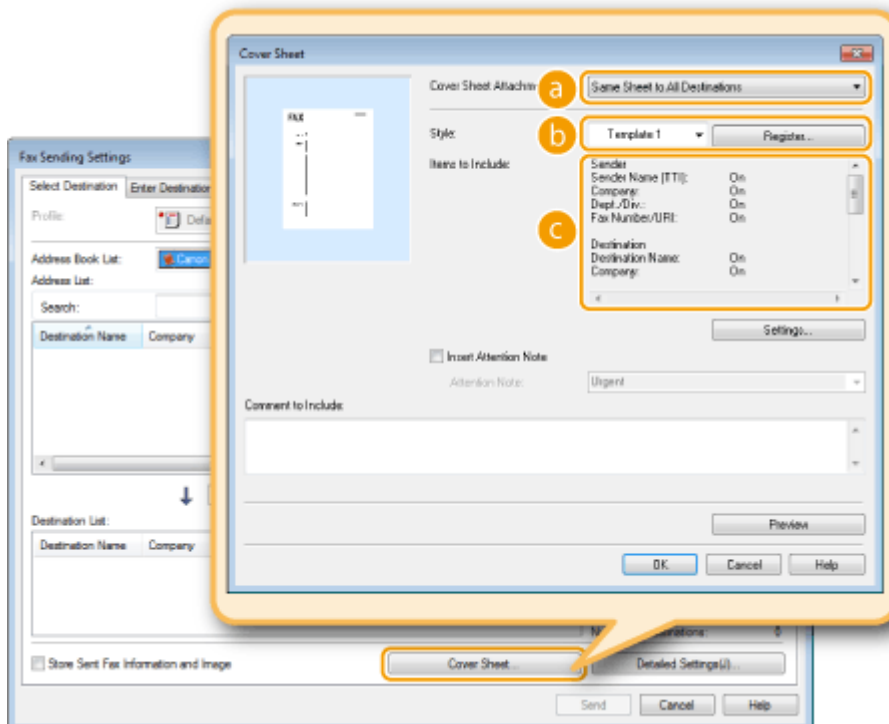

a [Cover Sheet Attachment]

Select [Different Sheet to Each Destination] or [Same Sheet to All Destinations].

b [Style]

Select a cover sheet from the three preset cover sheets ([Template 1] to [Template 3]). The layout of the selected cover sheet is displayed in the image on the left.

c [Items to Include]

Displays items that are to be included on a cover sheet. To change the items to be included, click [Settings].

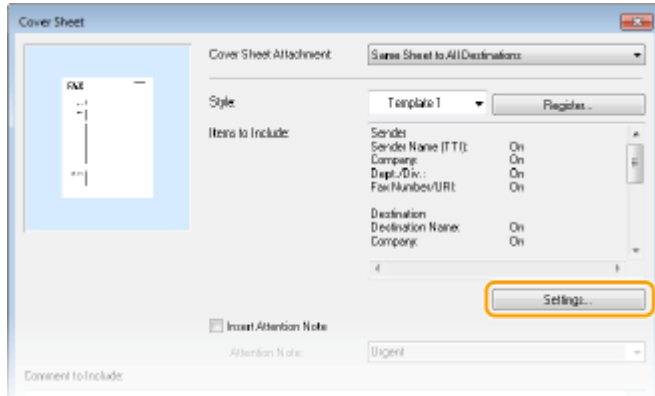

■ [Sender] tab

Select the sender items you want to include and enter the information.

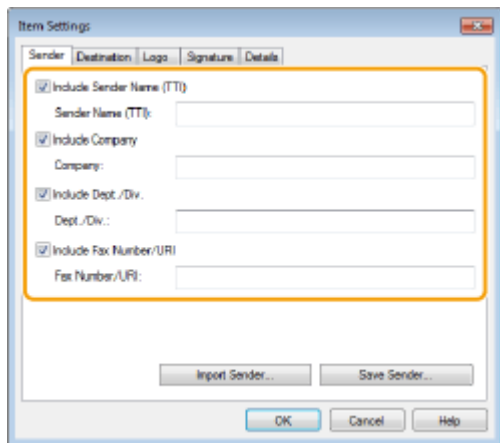

■ [Destination] tab

Select the destination items you want to include and enter the information. Destination names, company names, department names, and fax numbers specified in the [Select Destination]/[Enter Destination] tab ( **Sending PC Faxes(P. 168)**) are included on the cover sheet.

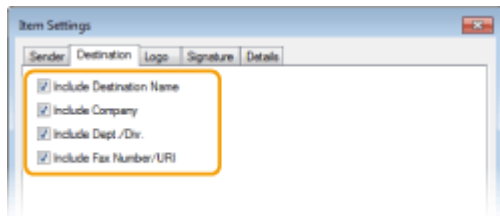

■ [Logo] tab/[Signature] tab

Specify each setting. The following screen shows an example for when the [Logo] tab is selected.

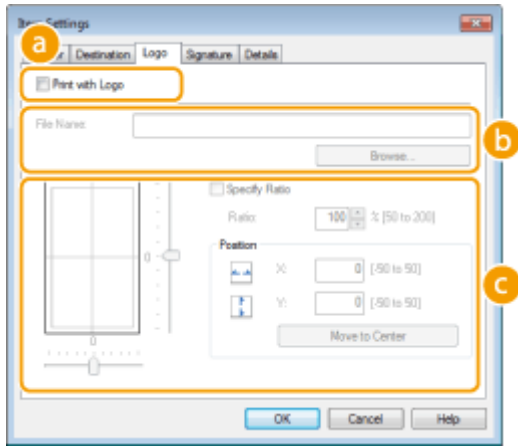

a With/without logos or signatures

Select [Print with Logo] or [Print with Signature] if you want to include logos or signatures on the cover sheet. Have the bitmap files for logos or signatures ready beforehand.

b Location of logos or signature files

Specify the location where logos or signatures files are saved. Click [Browse] to locate the file you are using for logos or signatures.

c Size and position of the specified logos or signatures

Adjust the size and position of the specified logos or signatures while checking the image displayed on the left.

■ [Details] tab

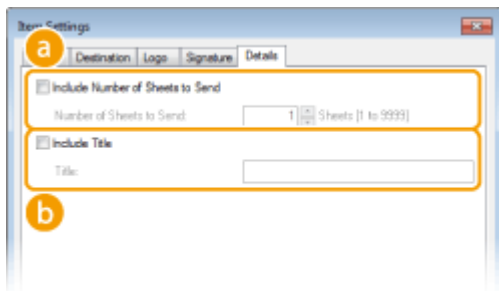

a [Include Number of Sheets to Send]

Select this check box if you want to include the number of sheets that you are going to send in the cover sheet and specify the number of sheets in [Number of Sheets to Send]. The number of sheets to send is not counted automatically. The value specified here is included in the cover sheet.

b [Include Title]

Select this check box if you want to add a title to the cover sheet and enter the title in [Title].

4 If you want to insert an attention note, select [Insert Attention Note] and select a note from the [Attention Note] drop-down list.

- Attention notes such as "Urgent" and "Confidential" are available. You can also enter characters directly in [Attention Note] instead of selecting a note from the list.
- You can also add comments in [Comment to Include].

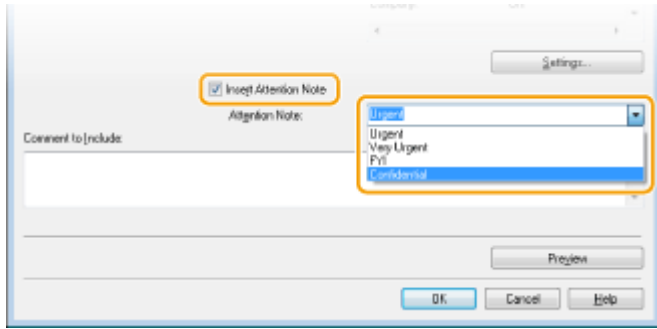

5 Click [Preview] to check the contents of the cover sheet, and if everything is correct, click [OK].

- To modify the contents, perform the steps from 3 again.

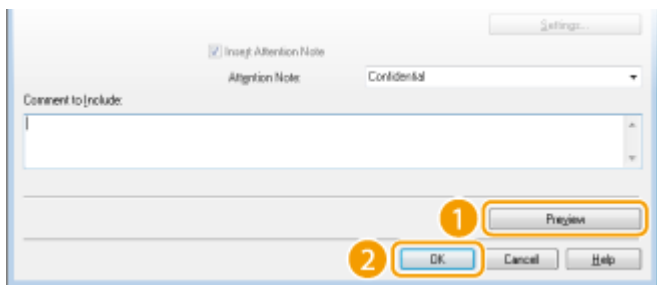

⇒ The specified cover sheet is attached to the fax when the fax is sent.

Using Address Book for PC Faxes

14L7-039



Once you register frequently used destinations for PC faxes in the Address Book, you can easily specify destinations whenever you send PC faxes. Also, Address Book data in CSV format created on applications such as Microsoft Excel can be imported into the machine, or the Address Book data can be exported to a file for use on other fax machines or applications.

■ Changing Location to Save Address Book Data

The location to save Address Book data can be changed to any arbitrary folder. You cannot use the Address Book if you do not have permission to access the folder where the Address Book is saved. In this case, change the save location of the Address Book.

1 Open the printer folder. ▶ **Displaying the Printer Folder(P. 664)**

2 Right-click the fax driver icon for this machine and click [Printing preferences].

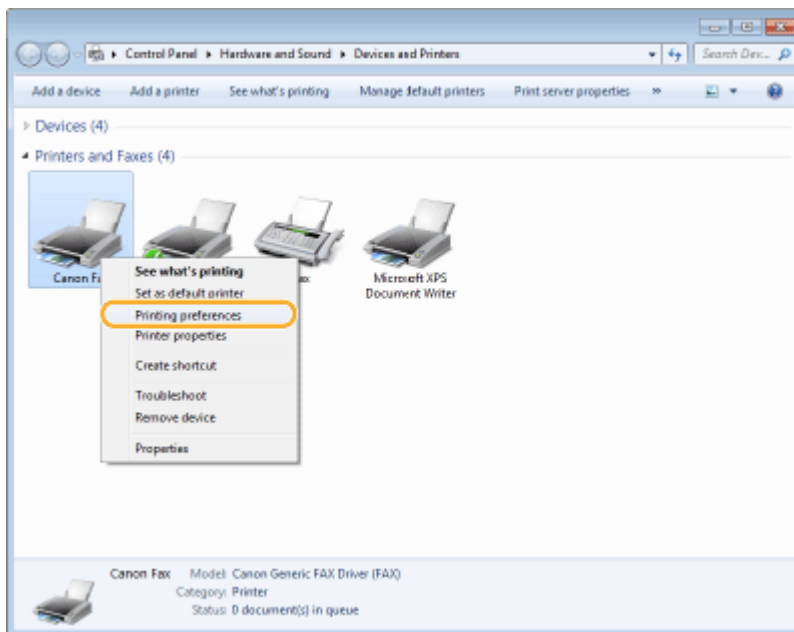

3 Click the [Select Destination] tab ▶ [Edit Address Book].

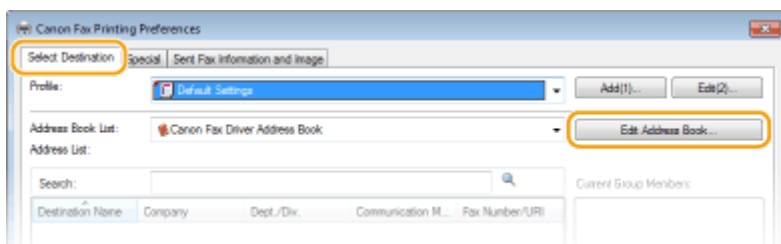

4 Click [Specify a Folder].

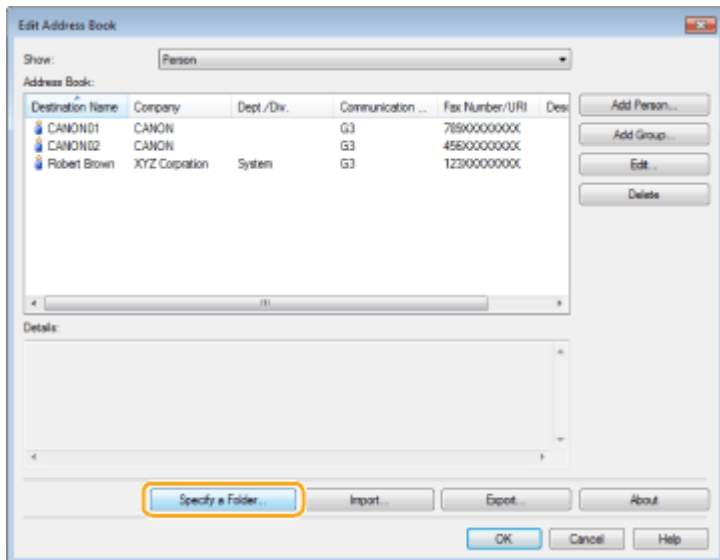

5 Specify the location to save the Address Book data, and click [OK].

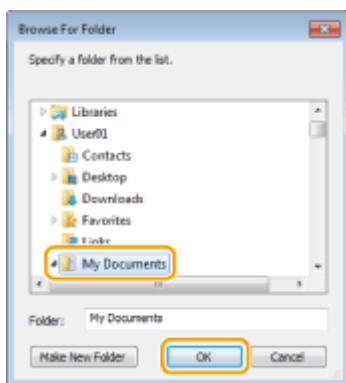

NOTE:

- Save the Address Book data in a folder, such as the [My Documents] folder, where you have write permission.

6 Click [New] or [Copy].

- To create a new and empty Address Book, click [New], and to just change the save location while keeping the present Address Book content as is, click [Copy].

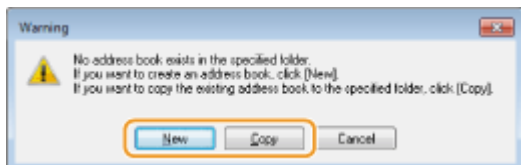

NOTE:

- Even if you change the Address Book save location, it does not result in deletion of the Address Book data in the original folder.
- If Address Book data already exists in the save location specified in step 5, the following message is displayed. If you want to use the existing Address Book, click [Use as-is], and if you want to overwrite it with the present Address Book, click [Overwrite].

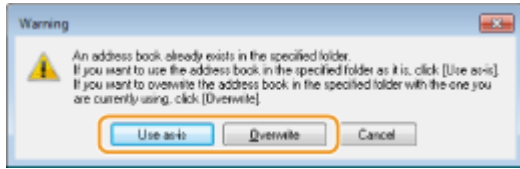

Registering Destinations

14L7-03A

This section describes how to register destinations in the Address Book for PC faxes. You can select single destinations from among those registered in the Address Book to make one group destination (Group Dial), which is useful when sending to multiple destinations at once.

▶ **Registering Destinations(P. 178)**

▶ **Registering Multiple Destinations as One Destination (Group Dial)(P. 180)**

NOTE

- A total of 6,000 destinations can be registered: 3,000 for single destinations and 3,000 for group destinations.
- You can select and combine registered group destinations and register them as separate group destinations.
- You cannot use the Address Book if you do not have permission to access the folder where the Address Book is saved. Log on as a user who has permission to access the folder, or change the save location of the Address Book. ▶ **Changing Location to Save Address Book Data(P. 175)**

Registering Destinations

1 Open the printer folder. ▶ **Displaying the Printer Folder(P. 664)**

2 Right-click the fax driver icon for this machine and click [Printing preferences].

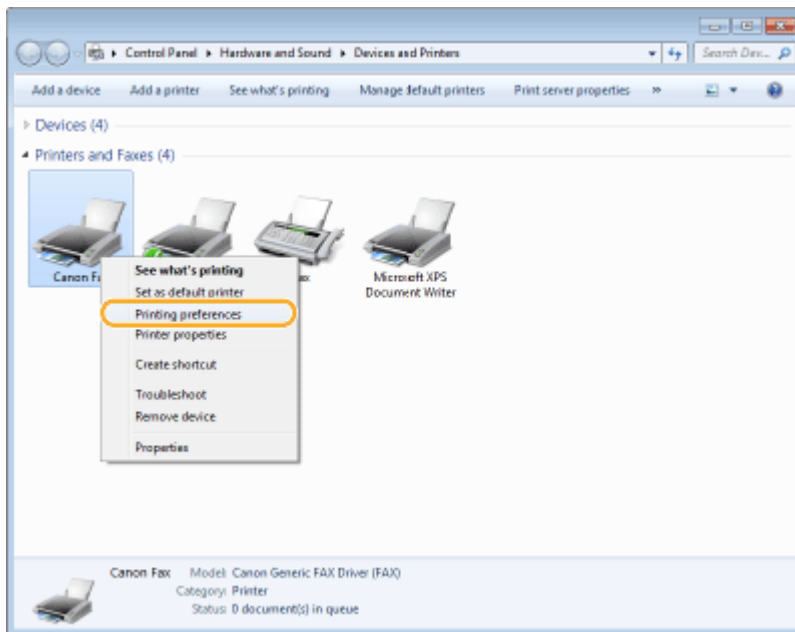

3 Click the [Select Destination] tab ▶ [Edit Address Book].

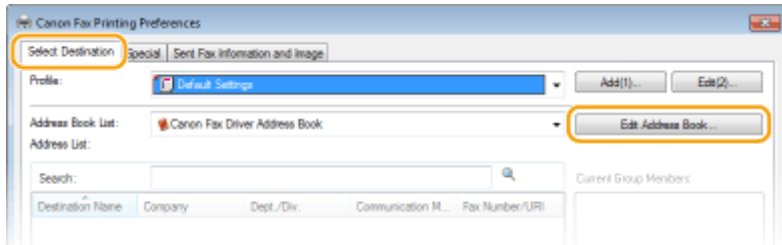

4 Click [Add Person].

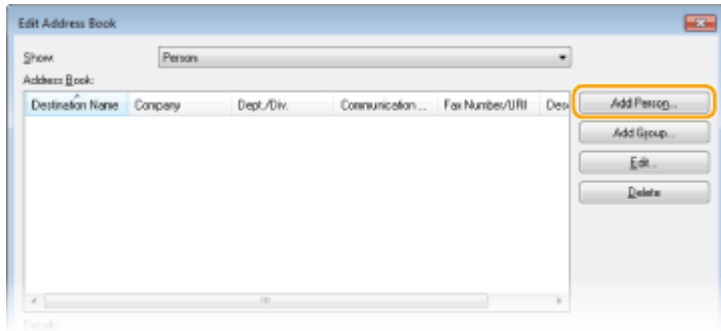

NOTE:

- To change or delete registered destinations, select a destination from [Address Book], and click [Edit] or [Delete].

5 Specify each setting and click [OK].

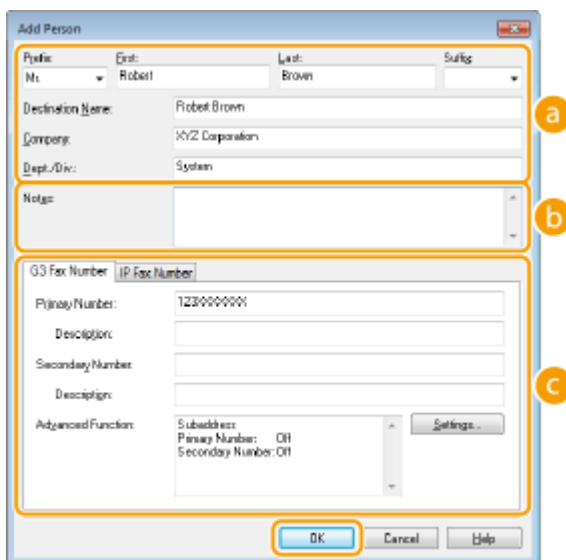

a Address

Enter the recipient name, company name, and department name.

b [Notes]

Enter comments as necessary.

c Fax Number

Enter the fax number(s). Hyphens can be inserted between numbers as necessary. If you want to add explanations of the uses for the fax numbers, such as "Home" or "Office", enter them in [Description].

Registering Multiple Destinations as One Destination (Group Dial)

1 Open the printer folder. ▶ **Displaying the Printer Folder(P. 664)**

2 Right-click the fax driver icon for this machine and click [Printing preferences].

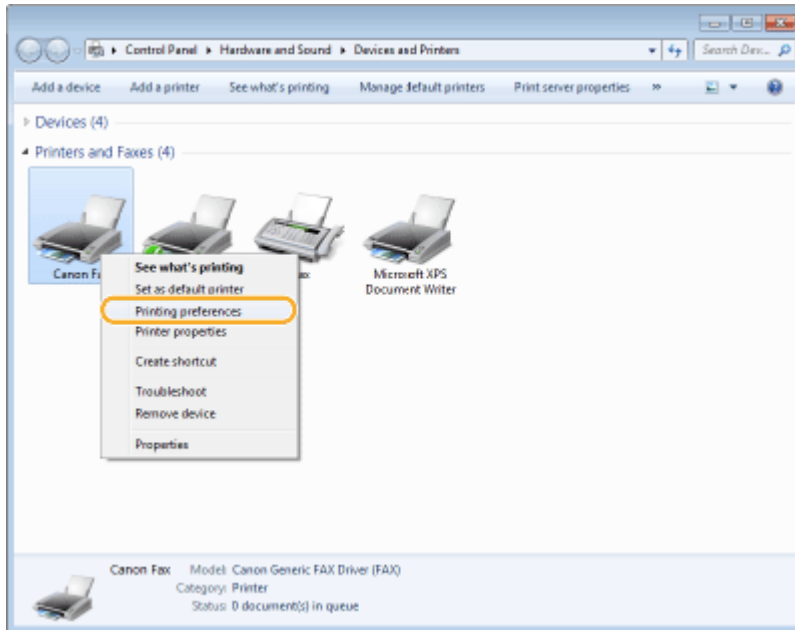

3 Click the [Select Destination] tab ▶ [Edit Address Book].

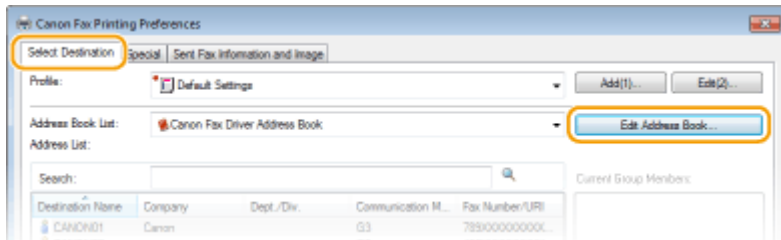

4 Click [Add Group].

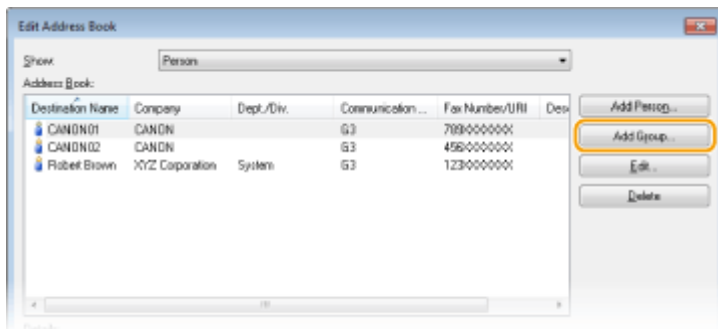

NOTE:

- To change or delete registered destinations, select a destination from [Address Book], and click [Edit] or [Delete].

5 Specify each setting and click [OK].

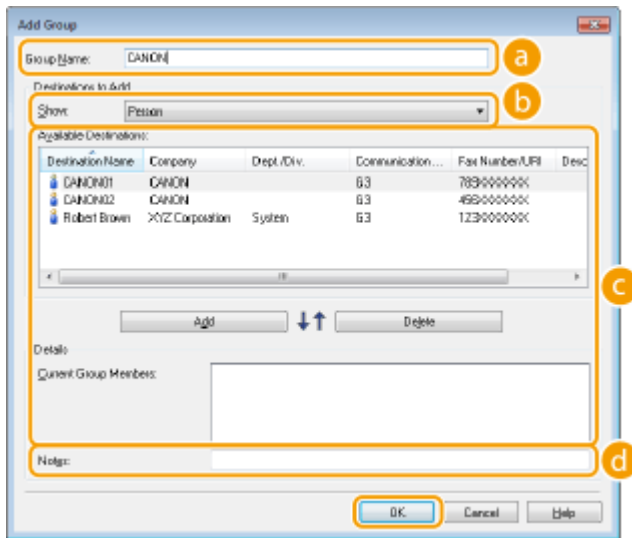

a [Group Name]

Enter a group name such as "Sales Department 1."

b [Show]

Select the type of the destinations to display in [Available Destinations], from which you can select the destinations to register in Group Dial.

[Person]

Displays single destinations.

[Group]

Displays group destinations.

[All]

Displays all the destinations registered in the Address Book.

c [Available Destinations]

Select the destinations to register in Group Dial, and click [Add]. The selected destinations are displayed in [Current Group Members].

NOTE:

- To select multiple destinations, click the destinations while holding down [SHIFT] key or [CTRL] key.
- To delete a destination from [Current Group Members], select a destination and click [Delete].

d [Notes]

Enter comments as necessary.

Using Registered Destinations

14L7-03C

This section describes how to specify destinations registered in the Address Book. ► **Registering Destinations(P. 178)**

NOTE

- You cannot use the Address Book if you do not have permission to access the folder where the Address Book is saved. Log on as a user who has permission to access the folder, or change the save location of the Address Book. ► **Changing Location to Save Address Book Data(P. 175)**

1 Open a document in an application and display the print dialog box.

- How to display the print dialog box differs for each application. For more information, see the instruction manual for the application you are using.

2 Select the fax driver for this machine, and click [Print].

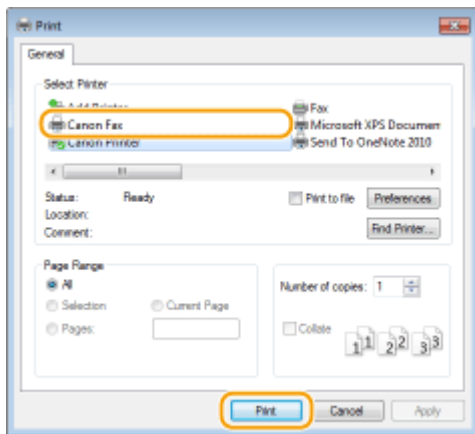

3 Click the [Select Destination] tab ► select the Address Book from [Address Book List].

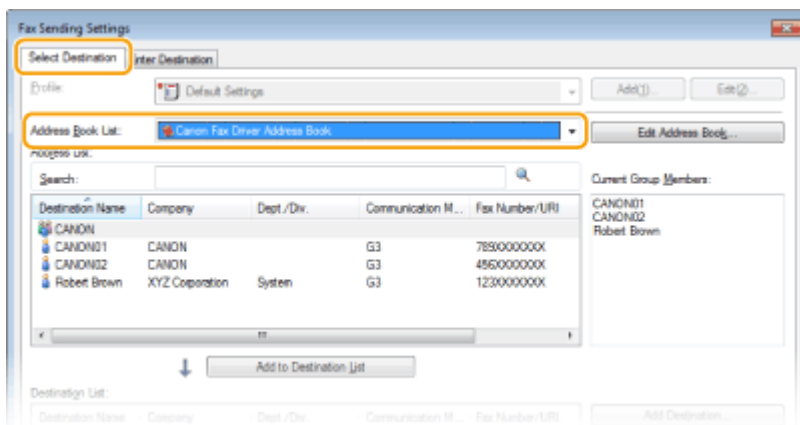

4 Select a destination and click [Add to Destination List].

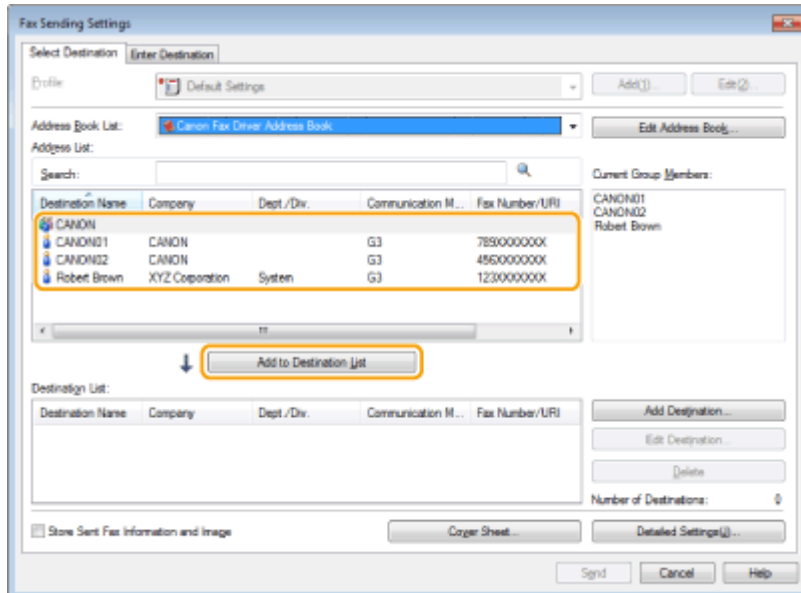

- To specify multiple destinations, repeat step 4.

NOTE:

- You can search for destinations with [Address List].
- Clicking [Edit Address Book] allows you to edit the Address Book.

Importing/Exporting Address Book Data from the Fax Driver

14L7-03E

Address Book data in CSV format created on applications such as Microsoft Excel can be imported into the machine, or the Address Book data can be exported to a file for use on other fax machines or applications.

- ▶ **Importing Address Book Data(P. 184)**
- ▶ **Exporting Address Book Data(P. 185)**

Importing Address Book Data

The file formats that can be read into the fax driver are the following three: CSV file (*.csv), Canon Address Book file (*.abk), and device configuration information file (*.dcm).

- 1 Open the printer folder. ▶ Displaying the Printer Folder(P. 664)**
- 2 Right-click the fax driver icon for this machine and click [Printing preferences].**

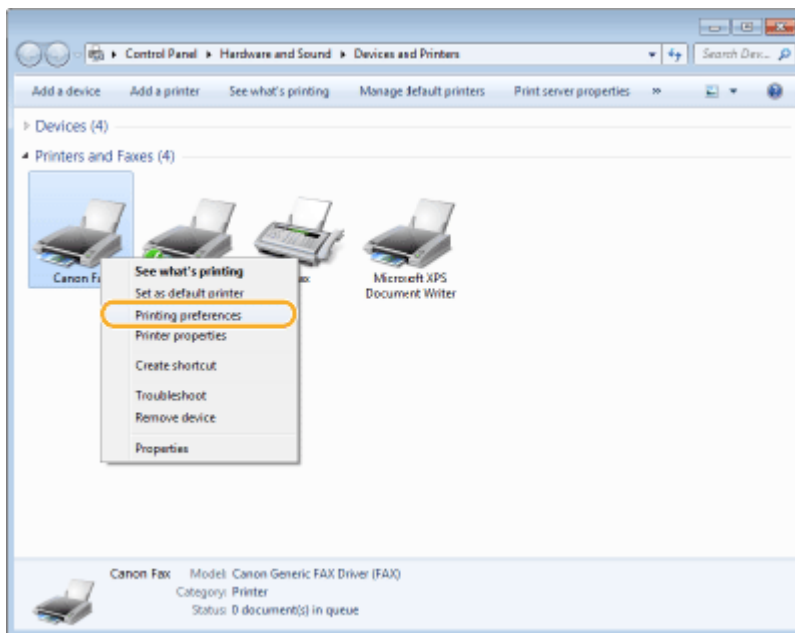

- 3 Click the [Select Destination] tab ▶ [Edit Address Book].**

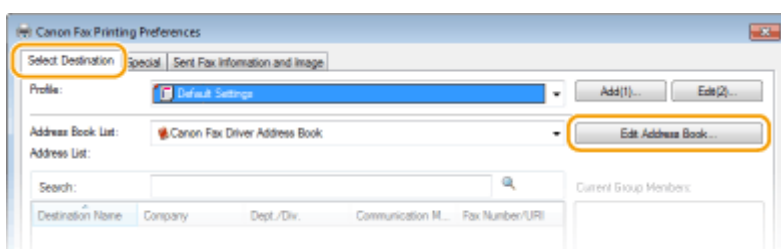

- 4 Click [Import].**

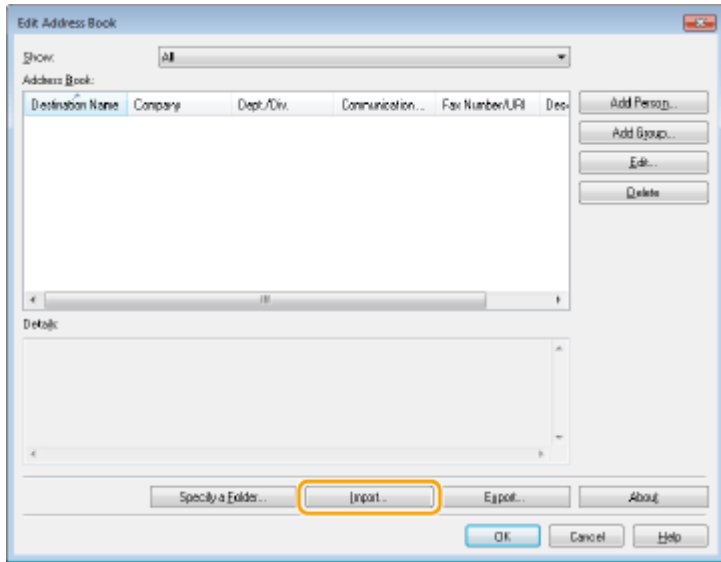

5 Select the file to import and click [Open].

- For a CSV file, specify the separators used in the file.

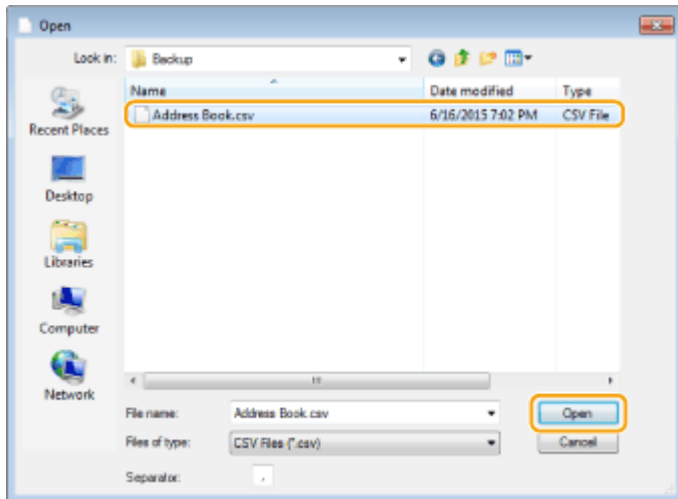

⇒ The destinations imported from the file are displayed in [Address Book].

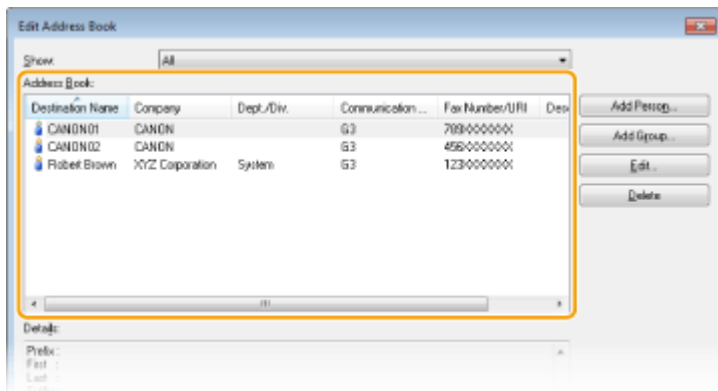

Exporting Address Book Data

The file formats that can be written out from the fax driver are the following two: CSV file (*.csv) and Canon Address Book file (*.abk).

1 Open the printer folder. ▶ **Displaying the Printer Folder(P. 664)**

2 Right-click the fax driver icon for this machine and click [Printing preferences].

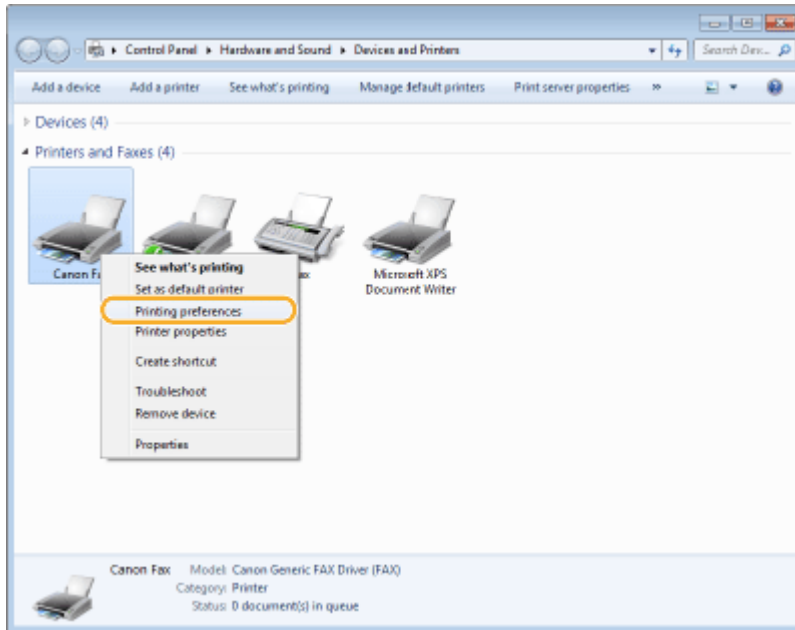

3 Click the [Select Destination] tab ▶ [Edit Address Book].

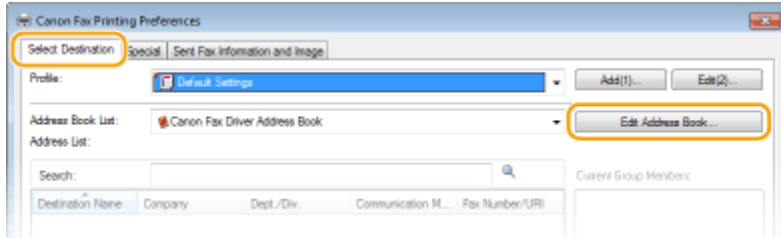

4 Click [Export].

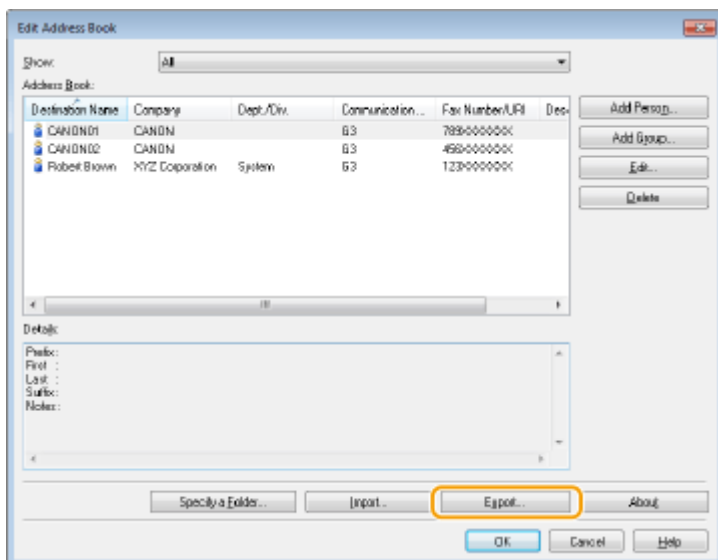

NOTE:

- If you have selected [Protect with Password when Exporting Address List] in the dialog box that is displayed when [Security Settings] of the [Special] tab is clicked, a dialog box for entering a password is displayed when you click [Export]. For more information, click [Help] on the fax driver screen.

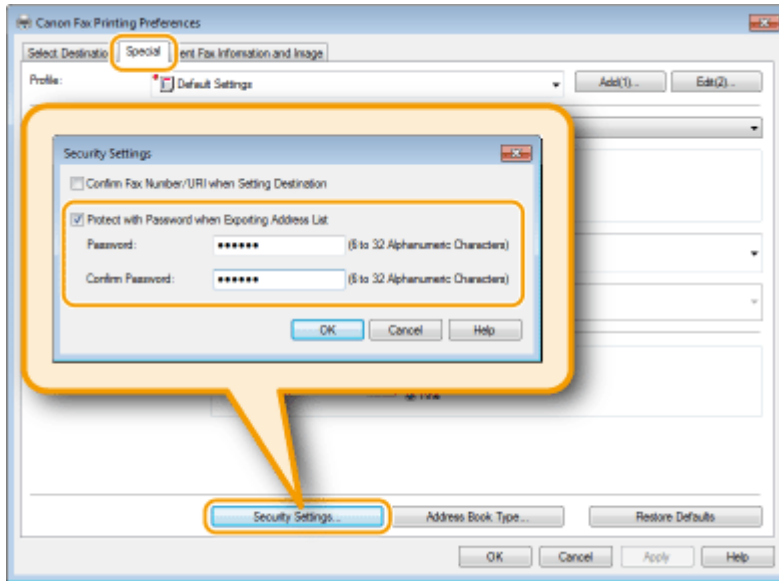

5 Specify the location to save the file, the file name, and the file format, and then click [Save].

- For a CSV file, specify the separators used in the file.

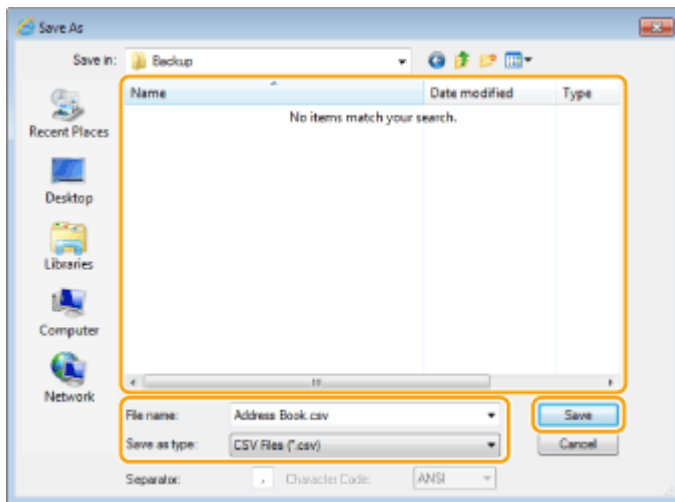

⇒ The Address Book data is exported to the specified location.

Using the Machine as a Printer

Using the Machine as a Printer	189
Printing from a Computer	190
Printing a Document	191
Canceling Prints	195
Checking the Printing Status	198
Various Print Settings	199
Enlarging or Reducing	201
Switching 1-Sided and 2-Sided Printing (MF249dw / MF246dn)	203
Collating Printouts by Page	205
Printing Multiple Pages onto One Sheet	207
Printing Posters	209
Printing Booklet (MF249dw / MF246dn)	211
Printing Borders	213
Printing Dates and Page Numbers	214
Printing Watermarks	216
Selecting Document Type	218
Saving Toner	220
Combining and Printing Multiple Documents	222
Configuring Print Settings to Your Needs	226
Registering Combinations of Frequently Used Print Settings	227
Changing Default Settings	229

Using the Machine as a Printer

14L7-03F

There are many ways to use the machine as a printer. You can print documents on your computer by using the printer driver, or print from mobile devices. Make full use of the print functions to suit your needs.

■ Printing from a Computer

You can print a document made on your computer by using the printer driver. ▶ **Printing from a Computer(P. 190)**

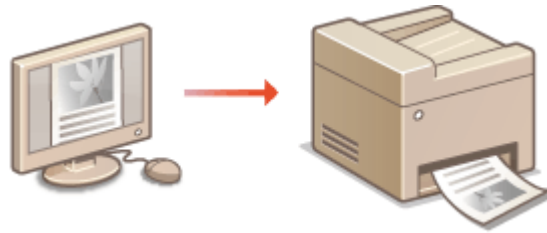

Printing from Mobile Devices

- Linking mobile devices such as smartphones or tablets to this machine provides a quick and easy way to print photos and web pages. The machine also supports Google Cloud Print™.

▶ **Can Be Used Conveniently with a Mobile Device (MF249dw / MF246dn / MF237w)(P. 289)**

▶ **Using Google Cloud Print(P. 308)**

Printing from a Computer

14L7-03H

You can print a document made with an application on your computer by using the printer driver. There are useful settings on the printer driver, such as enlarging/reducing and 2-sided printing, that enable you to print your documents in various ways. Before you can use this function, you need to complete some procedures, such as installing the printer driver on your computer. For more information, see "MF Driver Installation Guide".

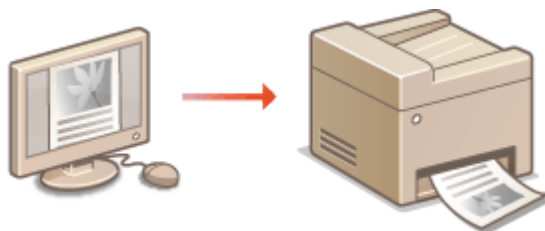

About the Printer Driver Help

Clicking [Help] on the printer driver screen displays the Help screen. On this screen, you can see the detailed descriptions that are not in the User's Guide.

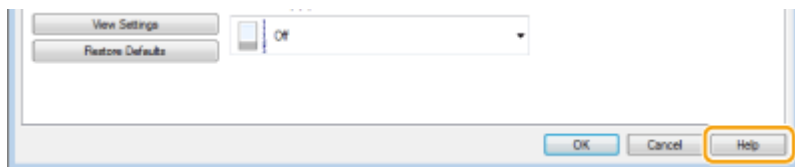

NOTE

- If you are a Mac OS user, see Printer Driver's User's Guide for installing the printer drivers and Printer Driver's Help for using print functions.
- Depending on the operating system and the type or version of the printer driver you are using, the printer driver screens in this manual may differ from your screens.
- If you are using the MF249dw / MF246dn, you can use the PCL6 printer driver as well as the UFR II LT printer driver. The available print settings vary depending on the printer driver. For more information, click [Help] on each printer driver screen.

Printing a Document

14L7-03J

This section describes how to print a document on your computer by using the printer driver.

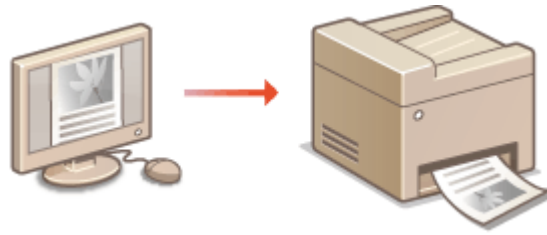

NOTE

Paper settings on the machine

- Normally, it is necessary to specify the paper size and type for the paper loaded in each paper source before proceeding to printing. ➤ **Specifying Paper Size and Type(P. 56)**

1 Open a document in an application and display the print dialog box.

- How to display the print dialog box differs for each application. For more information, see the instruction manual for the application you are using.

2 Select the printer driver for this machine, and click [Preferences] or [Properties].

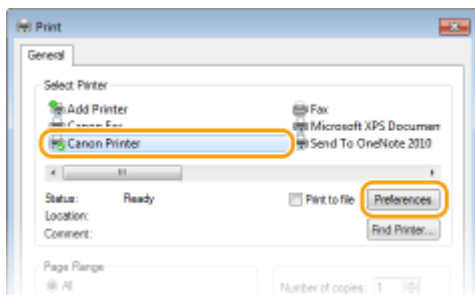

- The screen that is displayed differs depending on the application you are using.

3 Specify the paper size.

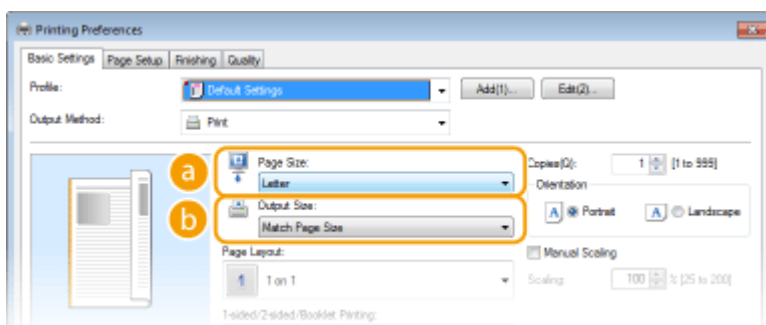

a [Page Size]

Select the size of a document made in the application.

b [Output Size]

Select the size of paper on which the document will be actually printed. If the selected size differs from the one specified in [Page Size], the document is printed enlarged/reduced automatically according to the selected size. ▶ **Enlarging or Reducing(P. 201)**

TIPS**Clickable UI**

- You can easily specify the page layout, binding position, etc. intuitively on the preview image. For more information, click [Help] on the printer driver screen.

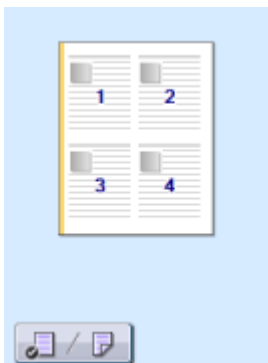
**4 In the [Page Setup] tab, select the paper type.**

- Set [Paper Type] according to the type of paper to be used in the printing. ▶ **Loading Paper(P. 45)**

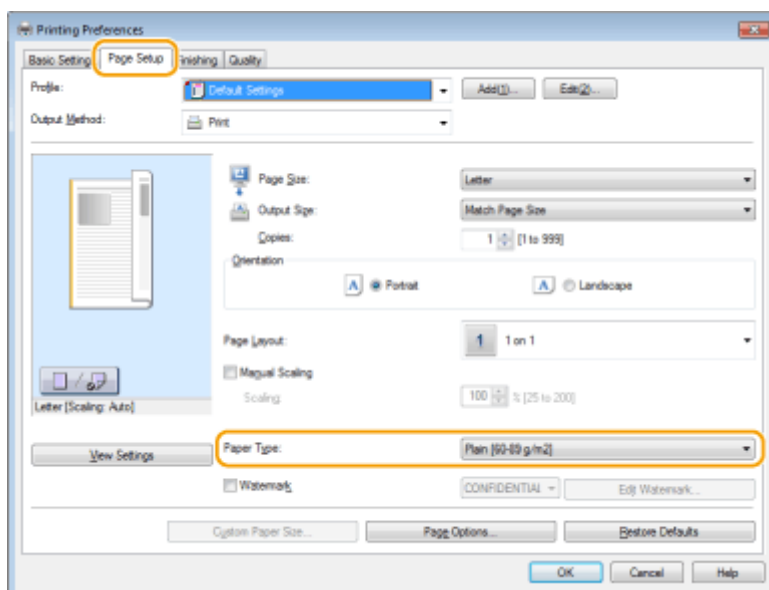
**5 Specify other print settings as necessary. ▶ Various Print Settings(P. 199)****NOTE:**

- You can register the settings you specified in this step as a "profile" and use the profile whenever you print. You can eliminate the need to specify the same settings every time you print. ▶ **Registering Combinations of Frequently Used Print Settings(P. 227)**

6 Click [OK].

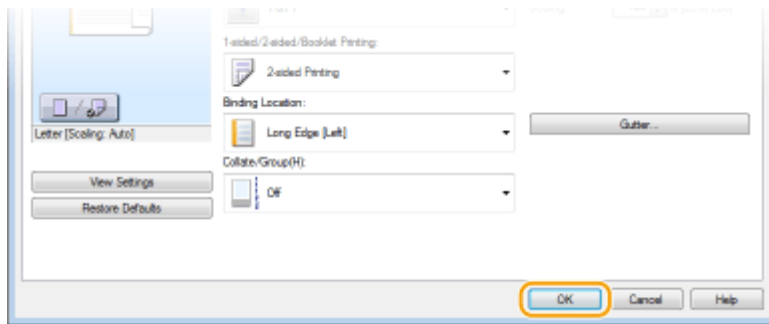

7 Click [Print] or [OK].

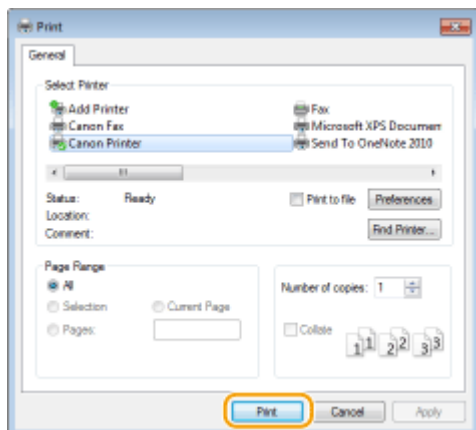

⇒ Printing starts. On some applications, a screen like shown below appears.

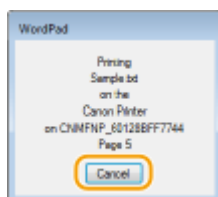

- To cancel printing, click [Cancel] when the screen shown above is displayed. After the screen disappears or if the screen is not displayed, you can cancel printing in other ways. ▶ **Canceling Prints(P. 195)**

NOTE

When printing from the Windows Store app in Windows 8/10/Server 2012

Display the charms on the right side of the screen and use the procedure shown below.

Windows 8/Server 2012

Tap or click [Devices] ▶ the printer driver for this machine ▶ [Print].

Windows 8.1/Server 2012 R2

Tap or click [Devices] ▶ [Print] ▶ the printer driver for this machine ▶ [Print].

Windows 10

Tap or click [Print] in the application menu ▶ the printer driver for this machine ▶ [Print].

- If you print using this method, only a limited number of print settings are available.
- If the message [The printer requires your attention. Go to the desktop to take care of it.] is displayed, go to the desktop and follow the instructions in the displayed dialog box. This message appears when the machine is set to display the user name during printing and similar instances.

LINKS

▶ **Managing Documents and Checking the Machine Status(P. 456)**

Canceling Prints

14L7-03K

You can cancel printing from your computer or on the operation panel of the machine.

- ▶ From a Computer(P. 195)
- ▶ From the Operation Panel(P. 196)

From a Computer

You can cancel printing from the printer icon displayed on the system tray on the desktop.

1 Double-click the printer icon.



NOTE:

When the printer icon is not displayed

- Open the printer folder (▶ [Displaying the Printer Folder\(P. 664\)](#)), right-click the printer driver icon for this machine, and click [See what's printing] (or double-click the icon of the printer driver for the machine).

2 Select the document you want to cancel, and click [Document] ▶ [Cancel].

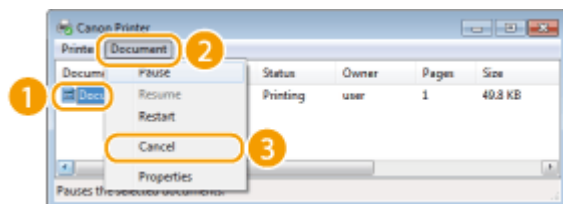

3 Click [Yes].

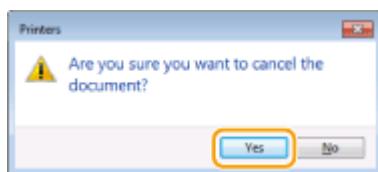

⇒ Printing of the selected document is canceled.

NOTE

- Several pages may be output after you cancel printing.

TIPS

Canceling from the Remote UI



- You can cancel printing from the [Job Status] page on the Remote UI: ▶ [Checking Current Status of Print Documents\(P. 456\)](#)

Canceling from an application

- On some applications, a screen like shown below appears. You can cancel printing by clicking [Cancel].



From the Operation Panel

Cancel printing using  or .

- Press  to Cancel

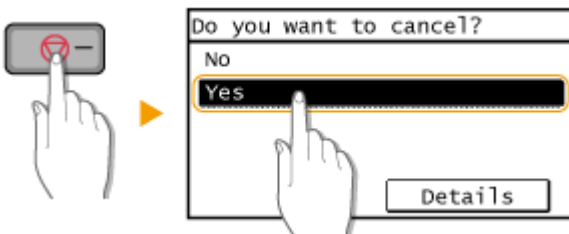

If the Screen Displays a List of Documents When is Pressed

Tap the document to cancel.

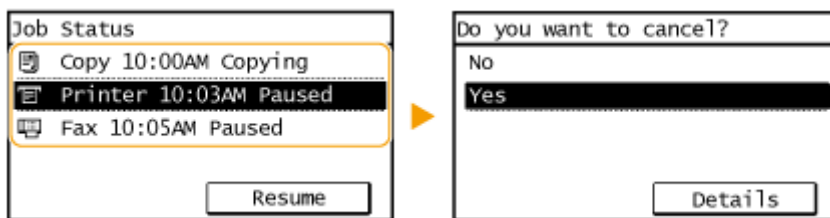

- Check the Print Job Status before Canceling

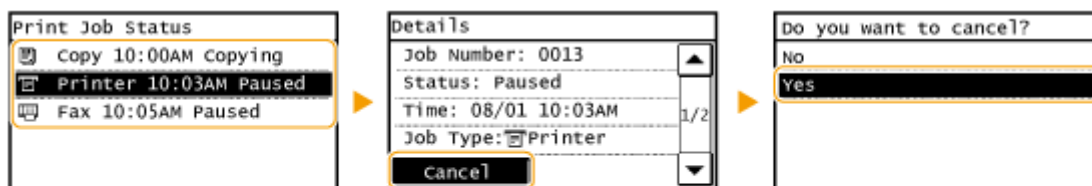
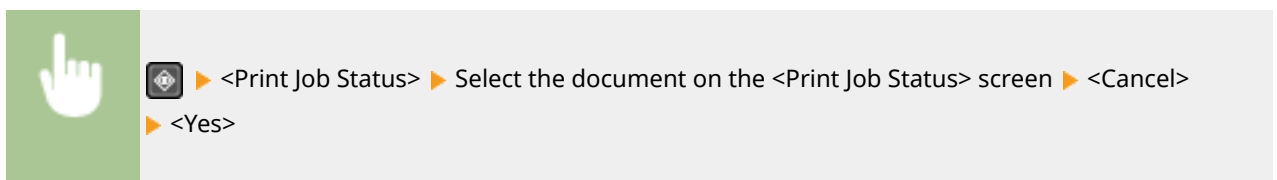

NOTE

- Several pages may be output after you cancel printing.

LINKS

[▶ Printing a Document\(P. 191\)](#)

[▶ Checking the Printing Status\(P. 198\)](#)

Checking the Printing Status

14L7-03L

You can check the current print statuses.

Useful in the Following Cases

- When your documents are not printed for a long time, you may want to see the waiting list of the documents waiting to be printed.
- When you cannot find your printouts that you thought had been printed, you may want to see whether an error has occurred.

1 Press .

2 Tap <Print Job Status>.

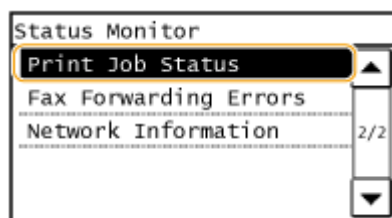

3 Select the document to check.

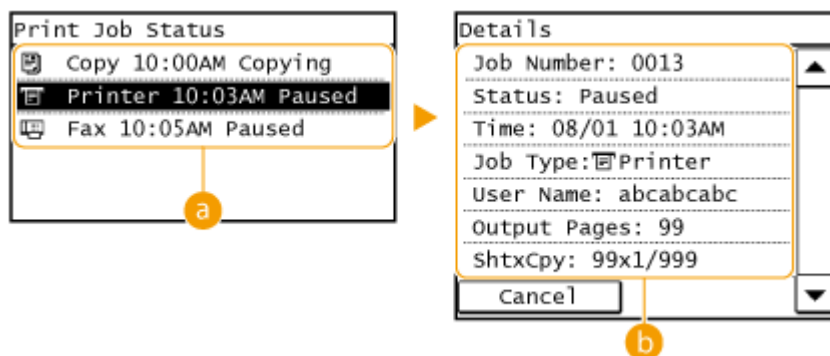

a <Print Job Status>

Displays a list of the documents that are being processed or are waiting to be processed.

b <Details>

Displays detailed information about the document selected from the list.

LINKS

 [Printing a Document\(P. 191\)](#)

 [Canceling Prints\(P. 195\)](#)

Various Print Settings

14L7-03R

There are a variety of settings to suit your needs, such as Enlarged/Reduced and 2-sided Printing.



▶ **Enlarging or Reducing(P. 201)**



▶ **Switching 1-Sided and 2-Sided Printing (MF249dw / MF246dn) (P. 203)**



▶ **Collating Printouts by Page(P. 205)**



▶ **Printing Multiple Pages onto One Sheet(P. 207)**

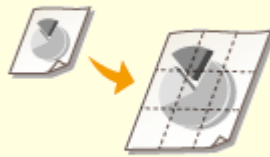

▶ **Printing Posters(P. 209)**



▶ **Printing Booklet (MF249dw / MF246dn)(P. 211)**



▶ **Printing Borders(P. 213)**



▶ **Printing Dates and Page Numbers(P. 214)**



▶ **Printing Watermarks(P. 216)**

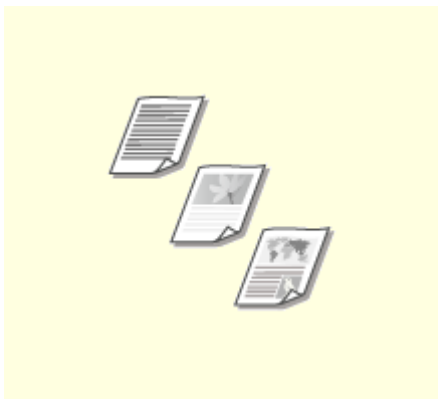

▶ **Selecting Document Type(P. 218)**

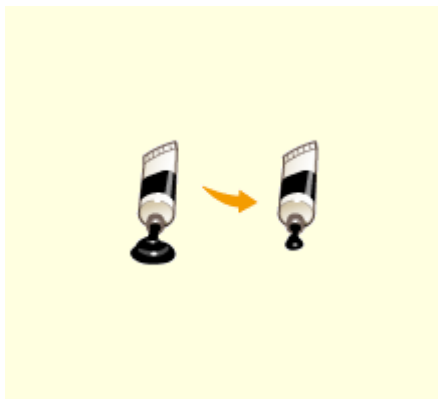

▶ **Saving Toner(P. 220)**

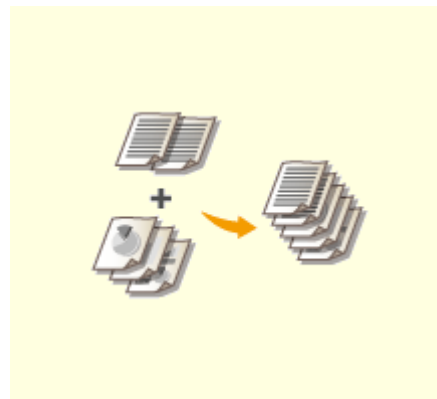

▶ **Combining and Printing Multiple Documents(P. 222)**

Enlarging or Reducing

14L7-03S



You can make enlarged or reduced printouts by using a preset print ratio, such as A5 to A4, or a custom print ratio that you set in increments of 1%.

Setting Print Ratio by Specifying the Original Document and Paper Size (Preset Ratio)

The print ratio is automatically set based on the document and paper size you have specified.



[Basic Settings] tab ► Select the document size in [Page Size] ► Select the paper size in [Output Size] ► [OK]

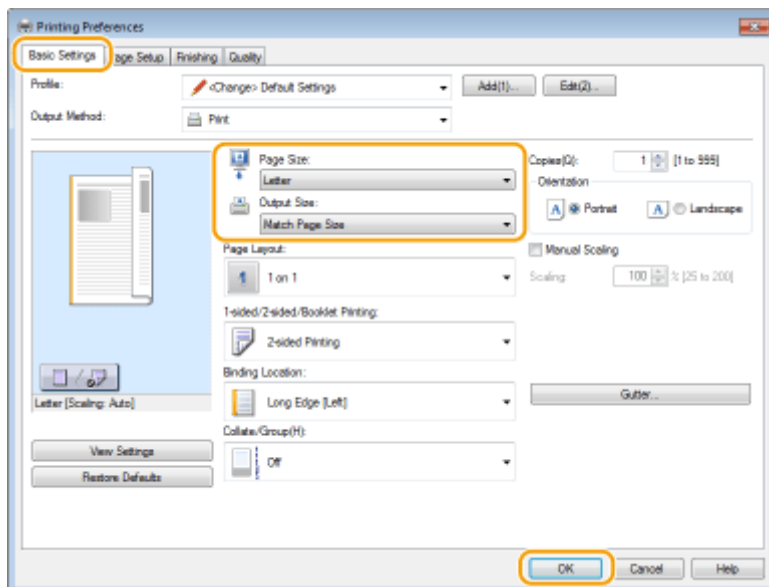

Specifying Print Ratio in Increments of 1%



[Basic Settings] tab ► Select the [Manual Scaling] check box ► Enter the print ratio in [Scaling] ► [OK]

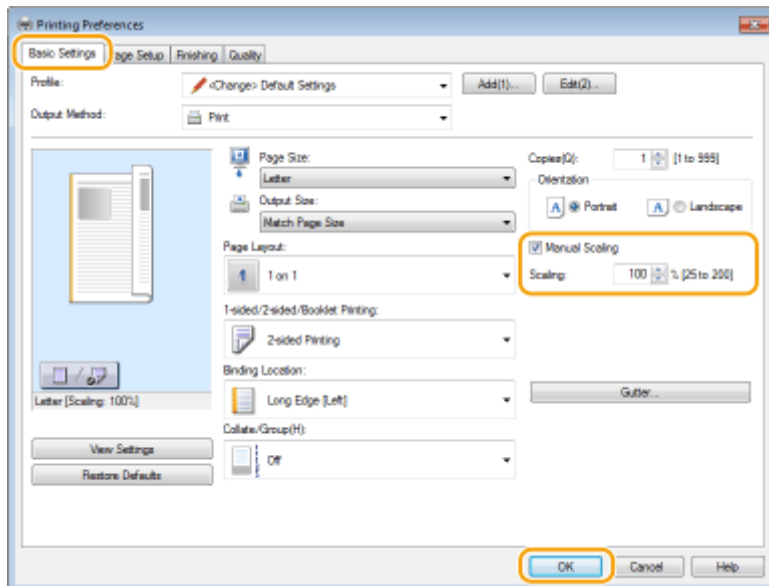

NOTE

- Depending on the selected paper size, you may not be able to set the optimum enlarging/reducing ratio. For example, there may be large blank spaces on your printout, or portions of the document that are missing.
- The enlarging/reducing settings on some applications have priority over those on the printer driver.

LINKS

▶ **Printing a Document(P. 191)**

Switching 1-Sided and 2-Sided Printing MF249dw / MF246dn

14L7-03U



You can make both 1-sided and 2-sided printouts. The default setting is [2-sided Printing]. Change the setting as necessary.

NOTE

- 2-sided printing may not be available with some sizes and types of paper. ▶ **Paper(P. 647)**



[Basic Settings] tab ▶ Select [1-sided Printing] or [2-sided Printing] in [1-sided/2-sided/Booklet Printing] ▶ Select the position to bind in [Binding Location] ▶ [OK]

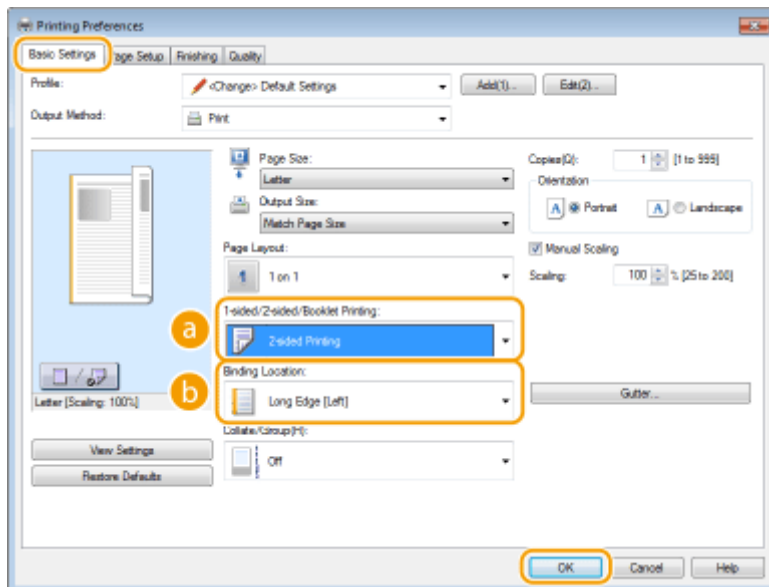

a [1-sided/2-sided/Booklet Printing]

Select [1-sided Printing] or [2-sided Printing].

NOTE:

- For [Booklet Printing], see ▶ **Printing Booklet (MF249dw / MF246dn)(P. 211)** .

b [Binding Location]

Specify the position to bind the printouts with a binding tool such as a stapler. Printing orientation will be changed depending on the specified binding position. To specify the margin width for the binding position, click [Gutter].

[Long Edge [Left]]

Prints images in such a way that the printed pages are opened horizontally when bound.



[Short Edge [Top]]

Prints images in such a way that the printed pages are opened vertically when bound.



[Gutter]

Specify a binding margin.



LINKS

- ▶ **Printing a Document(P. 191)**
- ▶ **Printing Multiple Pages onto One Sheet(P. 207)**
- ▶ **Printing Booklet (MF249dw / MF246dn)(P. 211)**

Collating Printouts by Page

14L7-03W



When printing copies of multi-page documents, select [Collate] to print complete sets in sequential page order. This function is useful when preparing handouts for meetings or presentations.



[Basic Settings] tab ► Select [Collate] or [Group] in [Collate/Group] ► [OK]

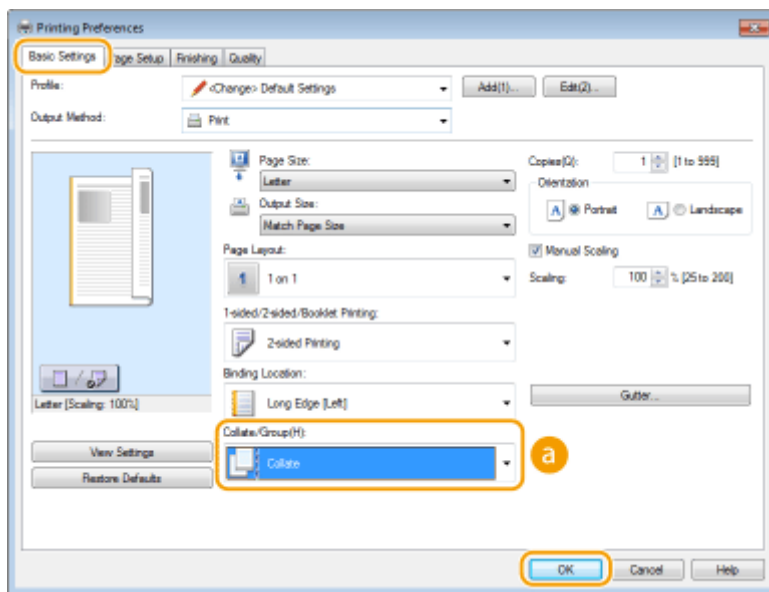

a [Collate/Group]

Specify the sorting method of the printouts when printing multiple-page documents.

[Collate]

The printouts are grouped into complete sets in sequential page order. For example, if you are printing three copies of a five-page document, the printouts will be arranged in the following page order: 1, 2, 3, 4, 5, 1, 2, 3, 4, 5, 1, 2, 3, 4, 5.



[Group]

The printouts are not collated. For example, if you are printing three copies of a five-page document, the printouts will be arranged in the following page order: 1, 1, 1, 2, 2, 2, 3, 3, 3, 4, 4, 4, 5, 5, 5.



NOTE:

- If you select [Off], whether the printouts are collated or not depends on the setting made on the application.

LINKS

▶ Printing a Document(P. 191)

Printing Multiple Pages onto One Sheet

14L7-03X



You can print multiple pages onto a single sheet. For example, you can print four or nine pages onto a single sheet by using [4 on 1] or [9 on 1]. Use this function if you want to save paper or to view your document in thumbnails.

NOTE

- To save more paper, combine this setting with 2-sided printing. **Switching 1-Sided and 2-Sided Printing (MF249dw / MF246dn)(P. 203)**



[Basic Settings] tab ▶ In [Page Layout], select the number of pages to print onto a single sheet ▶ In [Page Order], select the page distribution layout ▶ [OK]

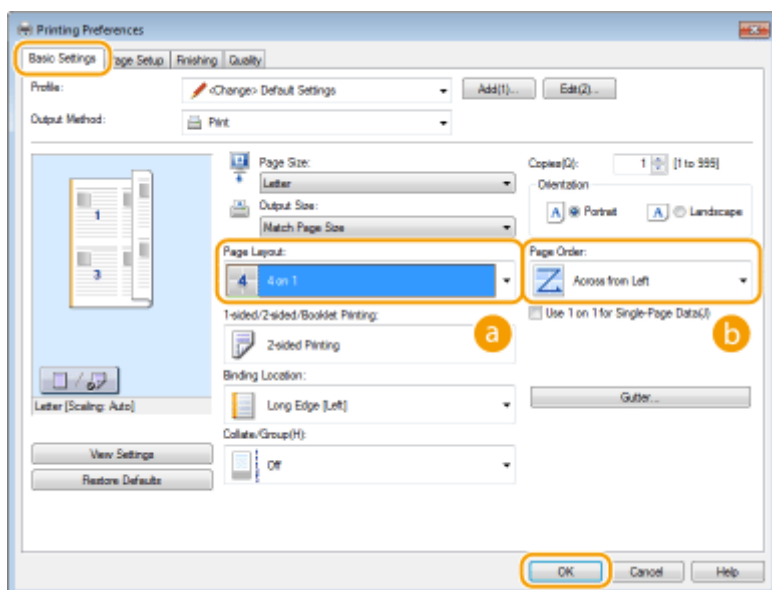

a [Page Layout]

Select the number of pages to print onto a single sheet from [1 on 1] to [16 on 1]. For example, to print 16 pages onto a single sheet, select [16 on 1].



NOTE:

- For options such as [Poster [2 x 2]], see **Printing Posters(P. 209)** .
- Printing may not be performed properly if you combine this setting with an application setting for collating printouts.

b [Page Order]

Select a page distribution layout. For example, if you select [Across from Left], the first page is printed on the top left, and then the rest of the pages are arranged rightward.



LINKS

- ▶ **Printing a Document(P. 191)**
- ▶ **Switching 1-Sided and 2-Sided Printing (MF249dw / MF246dn)(P. 203)**

Printing Posters

14L7-03Y

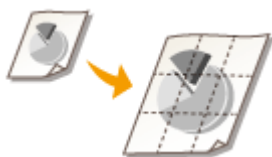

You can print one page of a document onto multiple pages. For example, if you make a one-page A4-size document nine times larger, you will have a poster 3x3 A4 size sheets large after you print the document and paste it together.



[Basic Settings] tab ► In [Page Layout], select the dimensions of your poster (for example, [Poster [2 x 2]]) ► [OK]

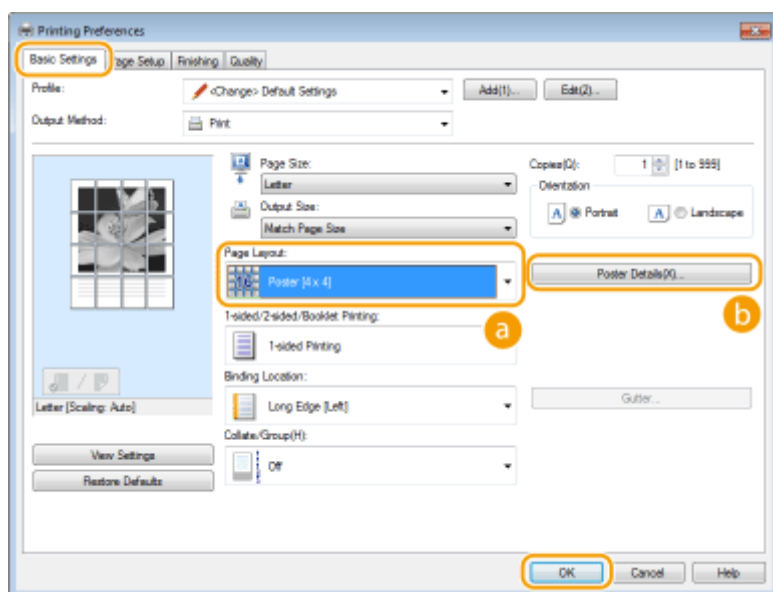

a [Page Layout]

Select the layout for poster printing. There are four size settings: [Poster [1 x 2]], [Poster [2 x 2]], [Poster [3 x 3]], and [Poster [4 x 4]].

NOTE:

- Poster size settings cannot be selected when 2-sided printing is enabled. Select [1-sided Printing] in [1-sided/2-sided/Booklet Printing], and then select a poster size setting.

b [Poster Details]

The screen below appears.

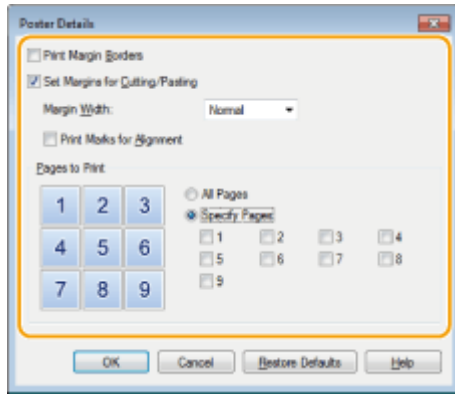

[Print Margin Borders]

Borders are printed on each page. The borders are helpful if you want to paste the printouts together or cut off the margins.

[Set Margins for Cutting/Pasting]

Prints margins to allow cutting or pasting. To print markings so that margins can be easily identified, select the [Print Marks for Alignment] check box.

[Pages to Print]

- [All Pages]: Carry out poster printing for all pages.
- [Specify Pages]: Carry out poster printing only for specified pages.

LINKS

▶ **Printing a Document(P. 191)**

▶ **Enlarging or Reducing(P. 201)**

Printing Booklet MF249dw / MF246dn

14L7-040



You can print two pages of a document on both sides of paper and then fold your printed pages in half to make a booklet. The printer driver controls the print order in such a way that the page numbers are correctly arranged.

NOTE

- Booklet printing may not be available with some sizes and types of paper. The paper that is available for 2-sided printing is also available for booklet printing. See [▶ Paper\(P. 647\)](#) .



[Basic Settings] tab ▶ Select [Booklet Printing] in [1-sided/2-sided/Booklet Printing] ▶ Click [Booklet] to specify detailed settings as necessary ▶ [OK] ▶ [OK]

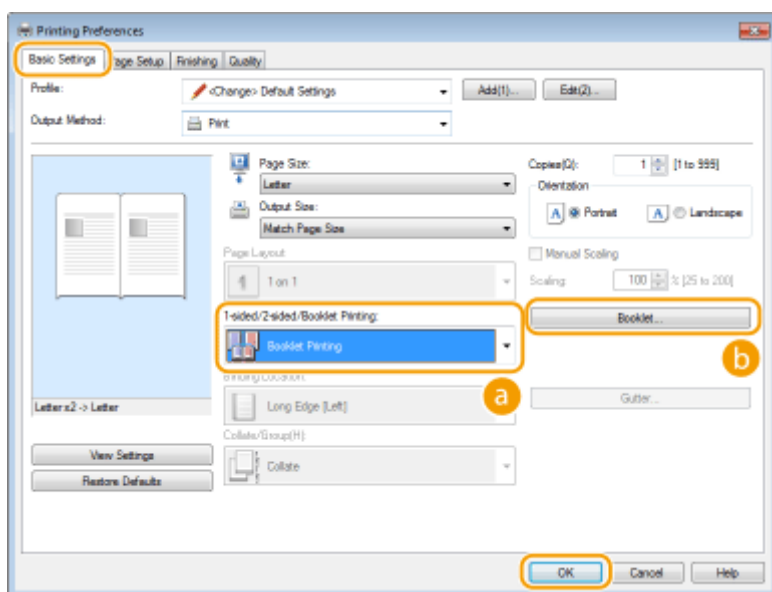

a [1-sided/2-sided/Booklet Printing]

Select [Booklet Printing].

NOTE:

- For [1-sided Printing] and [2-sided Printing], see [▶ Switching 1-Sided and 2-Sided Printing \(MF249dw / MF246dn\)\(P. 203\)](#) .

b [Booklet]

The screen below is displayed.

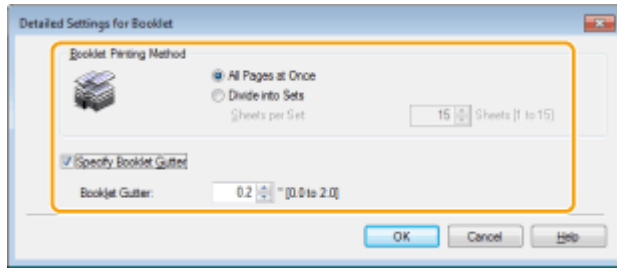

[Booklet Printing Method]

- [All Pages at Once]: Prints all of the pages at once as a single bundle so that you can make a booklet just by folding the printed pages in half.
- [Divide into Sets]: Prints as multiple bundles divided by the number of the pages specified on [Sheets per Set]. Bind each bundle, and then combine them as one booklet. Select this option when the document has so many pages that you cannot bind them all into a single booklet.

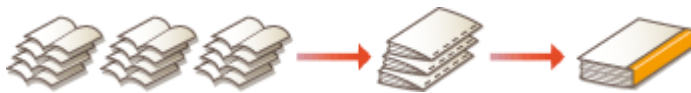

[Specify Booklet Gutter]

If you are using a stapler or other binding tools, specify the margin width for binding your booklet. Select the [Specify Booklet Gutter] check box and specify the margin width in [Booklet Gutter].

LINKS

▶ **Printing a Document(P. 191)**

Printing Borders

14L7-041



You can add borders, such as broken lines or double lines, in the margins of printouts.



[Page Setup] tab ▶ Click [Page Options] ▶ Select the border type in [Edging] ▶ [OK] ▶ [OK]

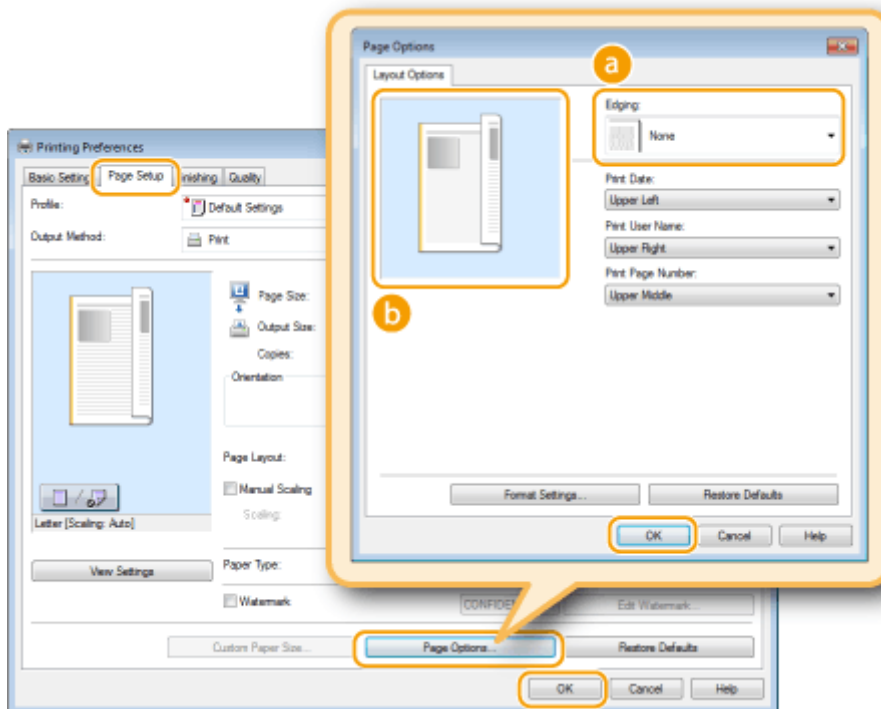

a [Edging]

Select the border type.

b Preview

Displays a preview with the selected border.

LINKS

- ▶ [Printing a Document\(P. 191\)](#)
- ▶ [Printing Dates and Page Numbers\(P. 214\)](#)
- ▶ [Printing Watermarks\(P. 216\)](#)

Printing Dates and Page Numbers

14L7-042



You can print the information such as dates or page numbers, and you can specify where to print this information on the document (upper-left, lower-right, etc.).



[Page Setup] tab ▶ Click [Page Options] ▶ Select the print position of the print date, user name or page number ▶ [OK] ▶ [OK]

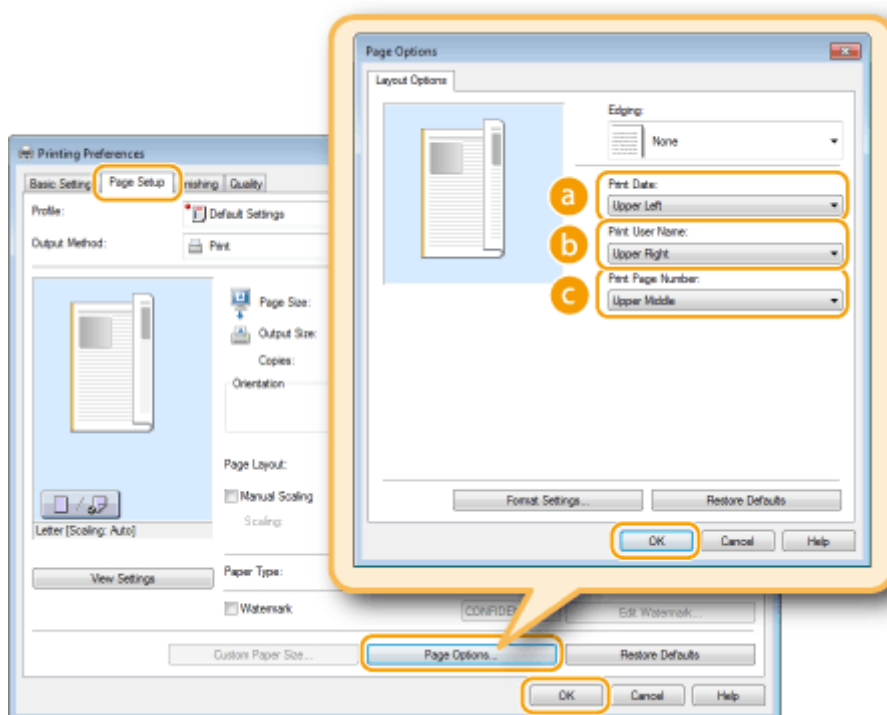

a [Print Date]

Specify the position to print the print date.

b [Print User Name]

Specify the position to print the user name (logon name) for the computer used to print the document.

c [Print Page Number]

Specify the position to print the page number.

Changing the Print Format of Dates and Page Numbers

- You can change formatting details such as font and font size when printing dates, logon names, or page numbers. Click [Format Settings] on the [Page Options] screen shown above to specify the details.

LINKS

- ▶ **Printing a Document(P. 191)**
- ▶ **Printing Borders(P. 213)**
- ▶ **Printing Watermarks(P. 216)**

Printing Watermarks

14L7-043



You can print watermarks such as "COPY" or "CONFIDENTIAL" over the document. You can create new watermarks or use pre-registered watermarks.



[Page Setup] tab ▶ Select the [Watermark] check box ▶ Select a watermark from the drop-down list
▶ [OK]

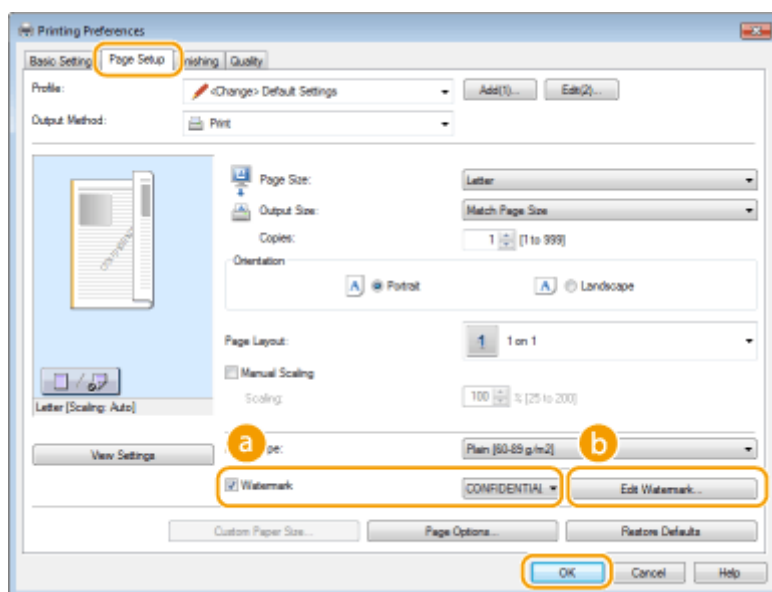

a [Watermark]

Select the [Watermark] check box to display the list of the watermarks in the drop-down list. Select a watermark from the menu.

b [Edit Watermark]

Displays the screen to create or edit watermarks.

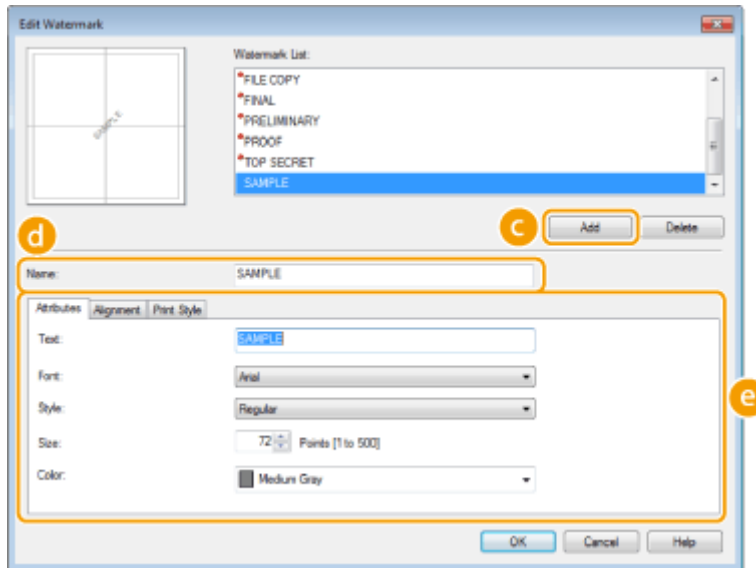

c [Add]

Click to create a new watermark. Up to 50 watermarks can be registered.

d [Name]

Enter the created watermark name.

e [Attributes]/[Alignment]/[Print Style]

Click each tab to specify the text, color, or print position of the watermark. For more information, click [Help] on the printer driver screen.

LINKS

- ▶ **Printing a Document(P. 191)**
- ▶ **Printing Borders(P. 213)**
- ▶ **Printing Dates and Page Numbers(P. 214)**

Selecting Document Type

14L7-044



You can specify the document type to ensure optimal image quality. There are different settings for photo documents, documents that have charts or graphs, and documents that have design drawings with fine lines.



[Quality] tab ▶ Select the document type in [Objective] ▶ [OK]

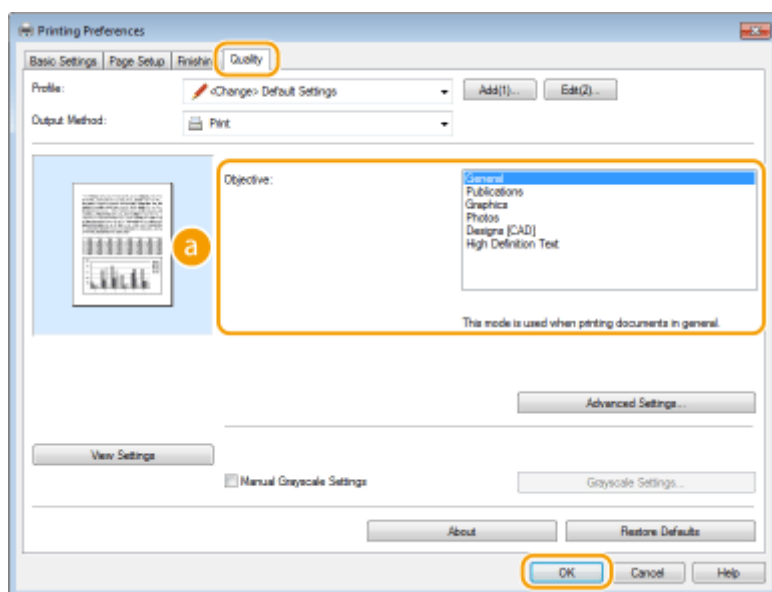

a [Objective]

Select an option that suits the document type or purpose of printing. For example, select [General] for general use, or select [Photos] when you want to print photo images in optimal print quality.

[General]

A versatile option that is suitable when printing most documents.

[Publications]

Suitable when printing documents that have a mix of photo images, charts, and graphs.

[Graphics]

Suitable when printing documents that have charts or graphs.

[Photos]

Suitable when printing photo images.

[Designs [CAD]]

Suitable when printing design drawings that have many fine lines.

[High Definition Text]

Suitable when printing documents that have small characters.

NOTE:

- To specify detailed settings for each item selected on [Objective], click [Advanced Settings]. For more information, click [Help] on the printer driver screen.

LINKS

 **Printing a Document(P. 191)**

Saving Toner

14L7-045



You can set the printer driver to print documents using less toner.

IMPORTANT

- When the toner save setting is enabled, fine lines and portions with lighter print density may become blurred.



[Quality] tab ▶ Select the document type in [Objective] ▶ Click [Advanced Settings] ▶ Select [Toner Save] in the [Advanced Settings] screen ▶ Select [On] from the drop-down list ▶ [OK] ▶ [OK]

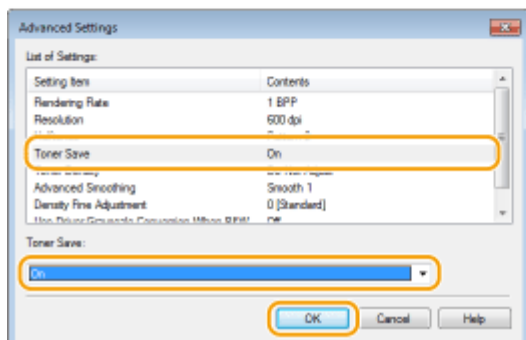
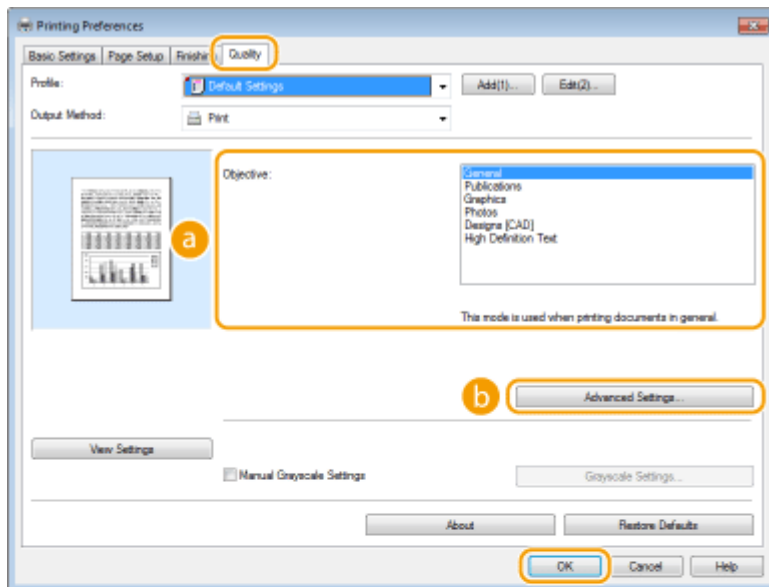

a [Objective] ▶ Selecting Document Type(P. 218)

Select the document type for which you want to enable the toner save setting.

b [Advanced Settings]

A screen with settings is displayed. Click [Toner Save] and select [On] from the drop-down list on the bottom of the screen.

NOTE:

- You can specify whether to enable the toner save setting for each document type. Specify the toner save setting for each document type listed in [Objective].
- In the [Advanced Settings] screen, you can specify various print settings other than toner save settings. For more information, click [Help] on the printer driver screen.

LINKS

▶ Printing a Document(P. 191)

Combining and Printing Multiple Documents

14L7-046



By using Canon PageComposer, you can combine multiple documents into one print job and print the job with specified print settings. This function, for example, enables you to combine documents made with different applications and print all of the pages in the same paper size.

1 Open a document in an application and display the print dialog box.

- How to display the print dialog box differs for each application. For more information, see the instruction manual for the application you are using.

2 Select the printer driver for this machine, and click [Preferences] or [Properties].

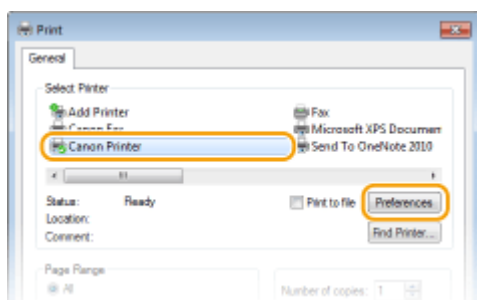

3 Select [Edit and Preview] in [Output Method].

- Click [OK] on the [Information] pop-up screen.
- Click [OK] at the bottom of the screen.

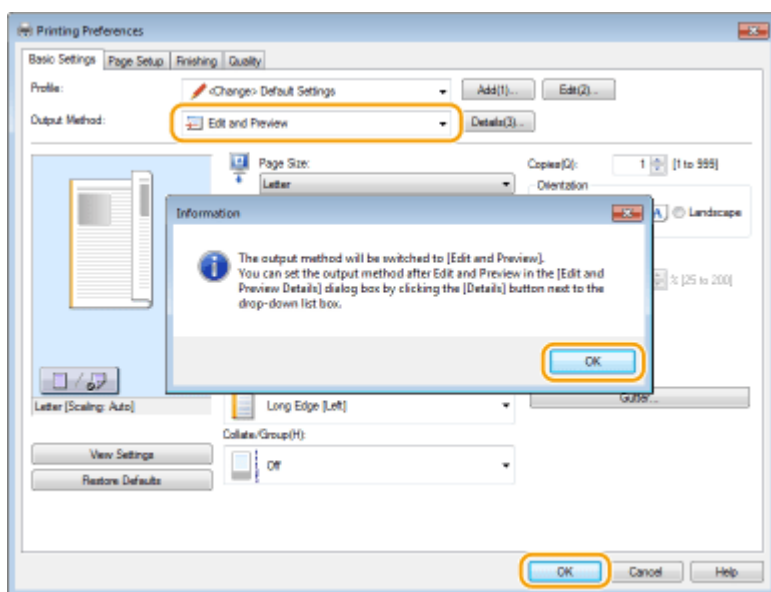

4 Click [Print] or [OK].

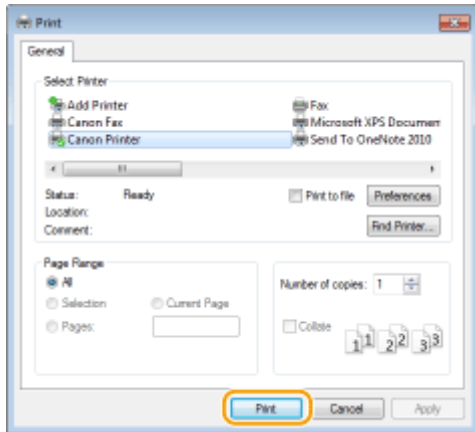

⇒ The Canon PageComposer starts. Printing does not start in this step.

5 Repeat steps 1 to 4 for the documents you want to combine.

⇒ The documents are added to the Canon PageComposer.

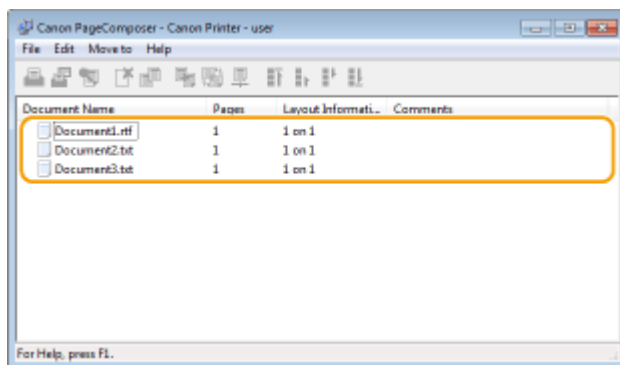

6 From the [Document Name] list, select the documents to combine, and click .

- To select multiple documents, click the documents while holding down [SHIFT] key or [CTRL] key.

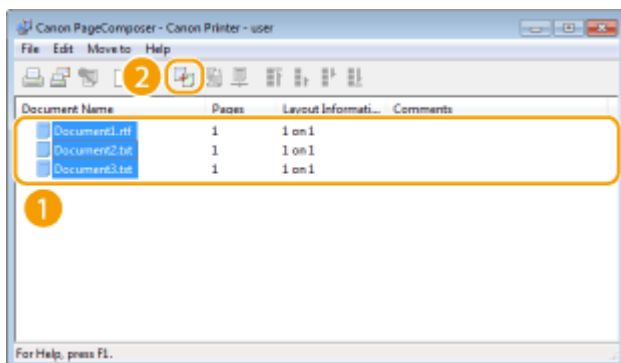

7 Change the settings as necessary, and click [Combine].

- The documents selected in step 6 are combined.

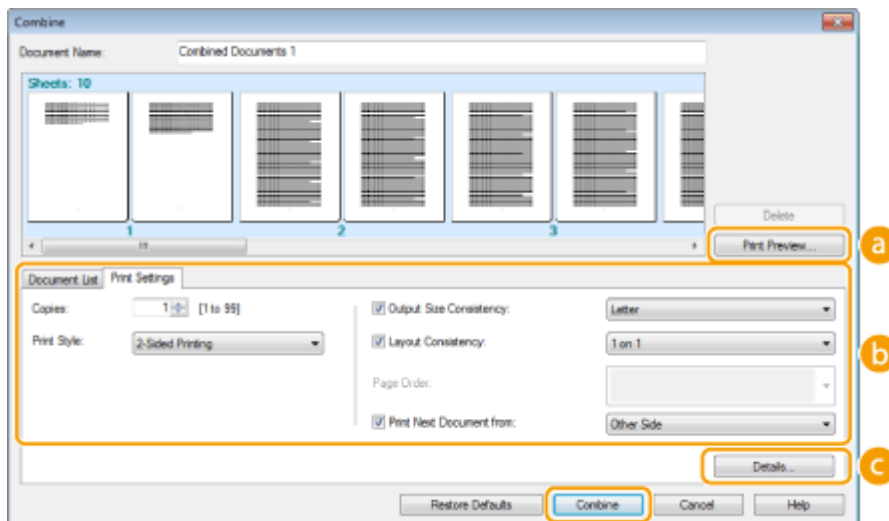

a [Print Preview]

Displays a preview of the document to be printed.

b [Document List]/[Print Settings]

- Click the [Document List] tab to display the documents added in steps 1 to 4. You can remove documents by selecting them in the list and clicking [Delete from List].

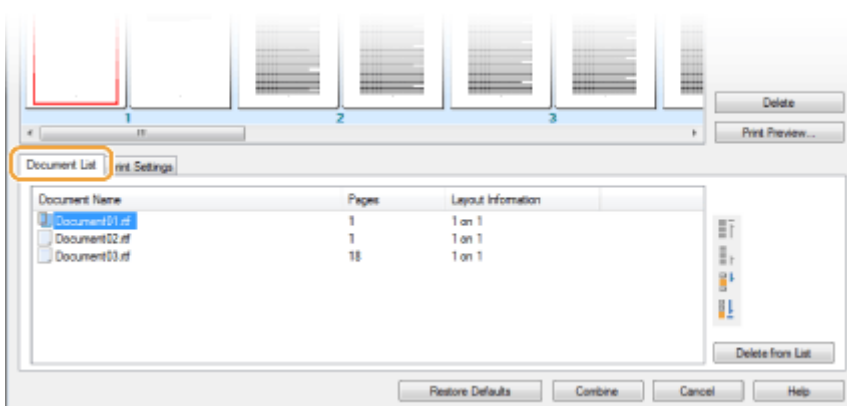

- Click the [Print Settings] tab to display the screen for specifying print settings such as the number of copies or 1-sided/2-sided printing. The settings specified here are applied to the whole print job.

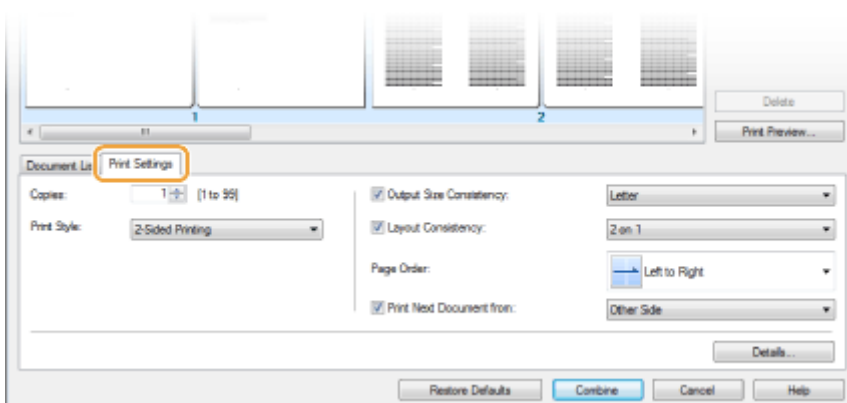

NOTE:

- For more information, click [Help] on the Canon PageComposer screen.

c [Details]

Displays the print setting screen of the printer driver. There are fewer settings available than when using the ordinary printing method.

- 8** On the [Document Name] list, select the combined-document print job you want to print, and click .

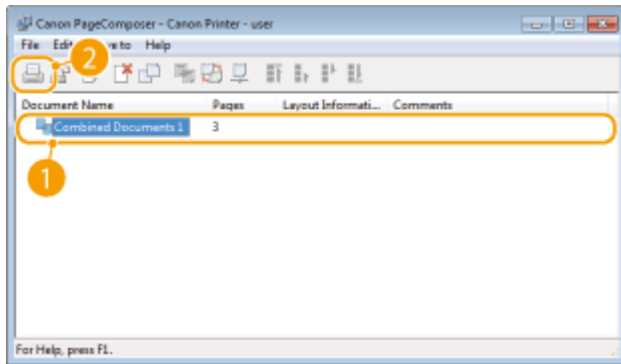

⇒ Printing starts.

- For instructions on how to cancel printing, see [▶Canceling Prints\(P. 195\)](#) .

LINKS

[▶Printing a Document\(P. 191\)](#)

Configuring Print Settings to Your Needs

14L7-047

You can register combinations of settings as "Profiles" to suit your different printing needs. Also, you can register the settings that you frequently use as the default setting. Once the default setting is set, the registered settings are automatically displayed on the printer driver screen, and you can skip the operations to specify the print settings and print immediately.



When I print highly confidential documents, I include a "TOP SECRET" watermark.



Specify "TOP SECRET" for a watermark and register it as a "Profile." Just select this "Profile" when you need it. ▶

Registering Combinations of Frequently Used Print Settings(P. 227)



To save printing costs, I always print 2 document pages on 1 printout page.



Specify [2 on 1] as the user default in the printer driver. The next and following print jobs will be performed so that each two pages are shrunk and printed on one page. ▶ **Changing Default Settings(P. 229)**

Registering Combinations of Frequently Used Print Settings

14L7-048

Specifying combinations of settings such as "1-sided landscape orientation on A4 size paper" every time you print may be time consuming. If you register these frequently used combinations of print settings as "profiles," you can specify printing settings simply by selecting one of these profiles from the list. This section describes how to register profiles and how to print using them.

▶ **Registering a Profile(P. 227)**

▶ **Selecting a Profile(P. 228)**

Registering a Profile

1 Change the settings that you want to register as a profile, and click [Add].

- Click the [Basic Settings], [Page Setup], [Finishing], or [Quality] tabs to specify the print settings on each screen as necessary. ▶ **Various Print Settings(P. 199)**

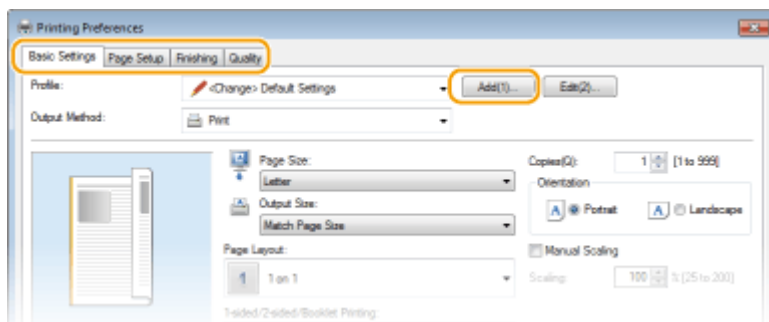

2 Enter a profile name in [Name], select an icon, and then click [OK].

- Enter comments on the profile in [Comment] as necessary.
- Click [View Settings] to see the settings to register.

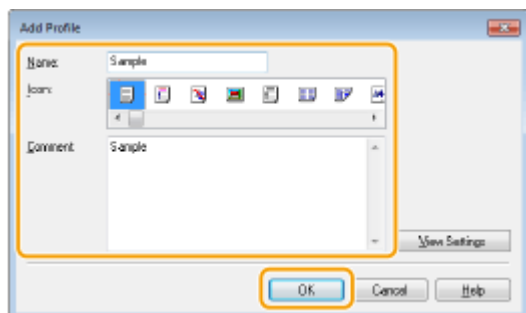

NOTE

Editing a profile

- By clicking [Edit] on the right side of [Add] on the screen shown in step 1, you can change the name, icon, or comment of the profiles you have previously registered. You cannot edit the pre-registered profiles.

Selecting a Profile

Select the profile that suits your needs, and click [OK].

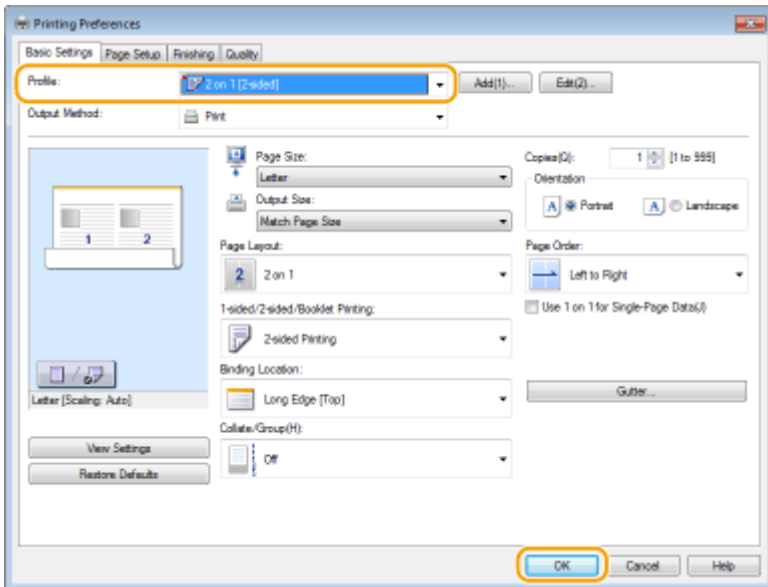

NOTE

Changing the settings of the selected profile

- You can change the settings of a selected profile. In addition, the changed settings can be registered as another profile.

LINKS

- ▶ [Printing a Document\(P. 191\)](#)
- ▶ [Changing Default Settings\(P. 229\)](#)

Changing Default Settings

14L7-049

The default settings are the settings that are first displayed whenever you open the print settings screen of the printer driver, but you can change them. For example, if you want to print all documents in such manner that each two pages are shrunk and printed on one page, specify [2 on 1] as the user default of page layout. From next time on, the printer driver will be opened with [2 on 1] specified as page layout setting and you will not have to change settings each time you print.

IMPORTANT

- To perform the following procedure, log on to your computer with an administrator account.

1 Open the printer folder. ▶Displaying the Printer Folder(P. 664)

2 Right-click the printer driver icon for this machine and click [Printing preferences].

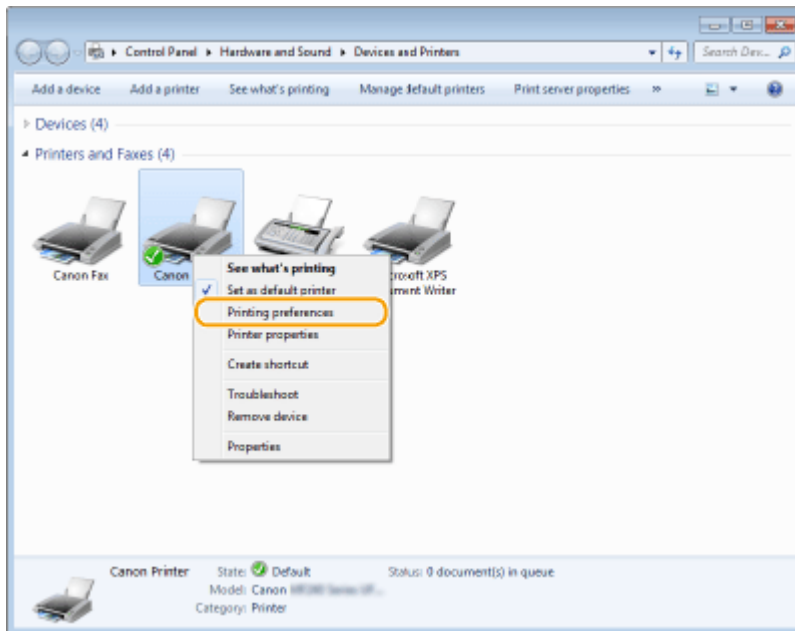

3 Change the settings on the print setting screen, and click [OK].

- Click the [Basic Settings], [Page Setup], [Finishing], or [Quality] tabs to specify the print settings on each screen as necessary. ▶Various Print Settings(P. 199)

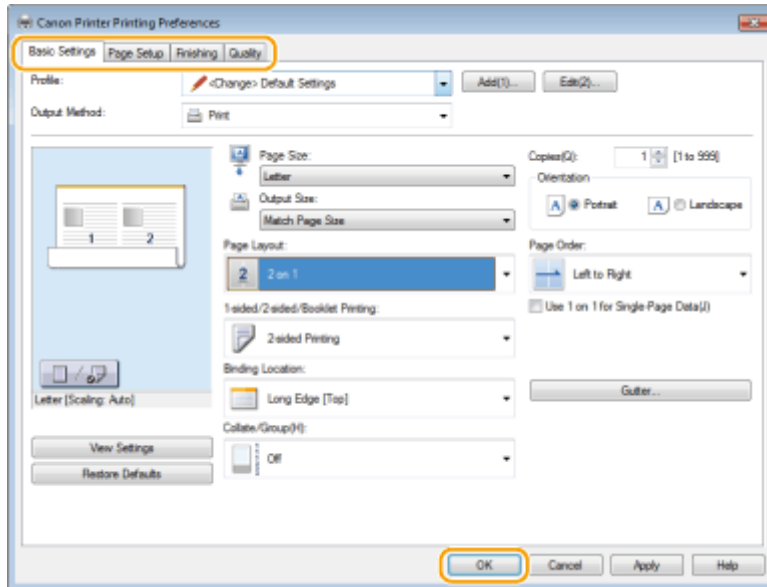

LINKS

- ▶ **Printing a Document(P. 191)**
- ▶ **Registering Combinations of Frequently Used Print Settings(P. 227)**

Using the Machine as a Scanner

Using the Machine as a Scanner	232
Preparing to Use the Machine as a Scanner (MF249dw / MF246dn / MF237w)	233
Scanning from the Machine	234
Scanning Using the <Scan -> PC> Button	237
Scanning from a Computer	241
Scanning Using an Application	242
Configuring Scan Settings in ScanGear MF	244
Convenient Scanning with a Machine-Based Operation (MF249dw / MF246dn)	245
Sending Documents as E-Mails Directly from the Machine	246
Saving Documents Directly in Shared Folder	253
Canceling Sending Documents (E-Mail/Shared Folder)	256
Specifying Detailed Settings	258
Specifying a Scanning Size	260
Setting Color Mode	261
Selecting a File Format	262
Adjusting Density	264
Specifying Orientation of Your Document	265
Selecting Document Type	266
Scanning 2-Sided Documents (MF249dw)	267
Adjusting Sharpness	268
Adjusting Balance between File Size and Image Quality	270
Setting Gamma Values	271
Sending Using Registered Destinations (E-Mail/Shared Folder)	272
Specifying from Address Book	273
Selecting Destinations Directly by Entering Coded Dial Numbers	276
Specifying Destinations with the One-Touch Buttons	279
Specifying Previously Used Destinations	281
Changing Default Settings	284
Checking Status and Log for Sent Documents (E-Mail/Shared Folder)	286

Using the Machine as a Scanner

14L7-04A

You can scan original documents by using the operation panel of the machine or an application on a computer. Whichever way you use, the scanned documents are converted into electronic file formats such as PDFs. Use the scan function to convert large-volume paper documents into files so that you can organize them easily.

NOTE

- To use this machine as a scanner, you must complete preparations in advance, including installation of software to a computer. For more information, see "MF Driver Installation Guide." To connect the machine to your computer via a network, you must register the machine to the installed software. **▶Preparing to Use the Machine as a Scanner (MF249dw / MF246dn / MF237w)(P. 233)**
- If you are a Mac OS user, see the User's Guide for ScanGear MF for installing the software and for using scan functions.
- Depending on the operating system and the version of the scanner driver or applications you are using, the screens in this manual may differ from your screens.

■ Scanning from the Machine

You can scan and save documents to your computer by using the operation panel of the machine. You can also send documents as e-mail attachments.

▶Scanning from the Machine(P. 234)

▶Convenient Scanning with a Machine-Based Operation (MF249dw / MF246dn)(P. 245)



■ Scanning from a Computer

You can scan documents placed on the machine from a computer. The scanned documents are saved to the computer. You can scan using MF Scan Utility (included with the machine), or with other applications such as an image-processing or word-processing application. **▶Scanning from a Computer(P. 241)**

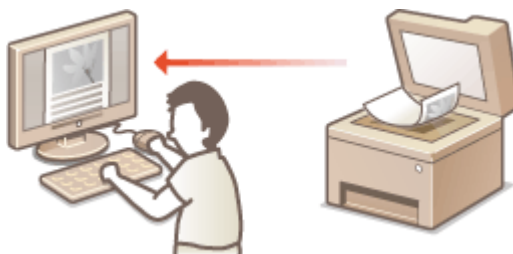

Scanning from Mobile Devices (MF249dw / MF246dn / MF237w)

- Linking mobile devices such as smartphones or tablets to this machine provides a quick and easy way to scan documents set on this machine. **▶Can Be Used Conveniently with a Mobile Device (MF249dw / MF246dn / MF237w)(P. 289)**

Preparing to Use the Machine as a Scanner

MF249dw / MF246dn / MF237w

14L7-04C

Make sure that the machine and your computer are connected and all software is installed. For how to check, see "MF Driver Installation Guide." To connect via a wireless or wired LAN, you must register this machine in MF Network Scanner Selector. Register by following the procedure below. This procedure is not required if the machine and your computer are connected via USB.

IMPORTANT

The scan function is not available if the machine and your computer are connected in an IPv6 environment. Use IPv4 or a USB connection.

- 1 Click  in the system tray.

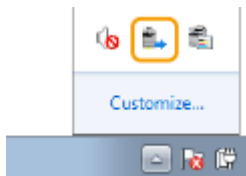

- 2 Select the check box for the machine, and click [OK].

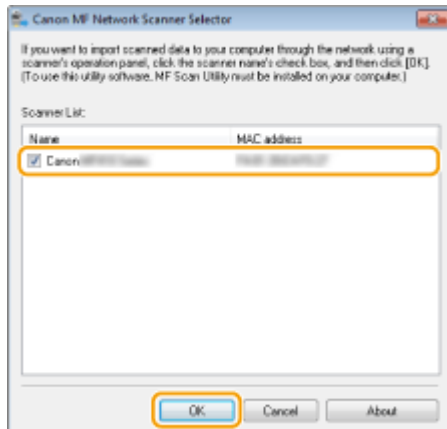

- Up to ten computers can be connected at a time on a network to one product (scanner).

Scanning from the Machine

14L7-04E



The sequence of "scanning a document and saving it to a computer" can be done entirely from the machine. Scan while specifying what computer documents will be saved to; whether to scan documents in color or black and white; whether to save documents as PDFs or JPEGs; and other settings.

1 Place the document(s). [▶Placing Documents\(P. 41\)](#)

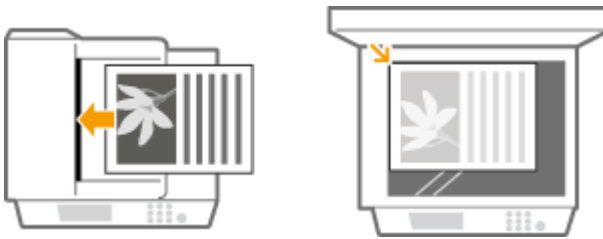

2 Press and tap <Scan>.

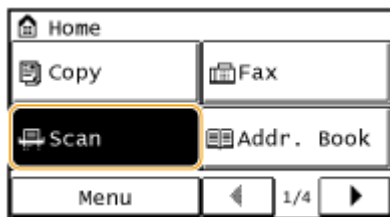

3 Tap <Computer>.

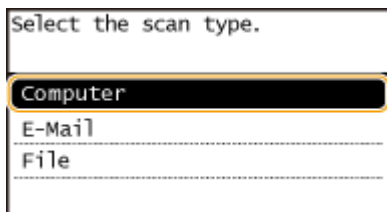

4 Select the destination computer.

- This screen is not displayed if only a computer is connected to the machine via USB.

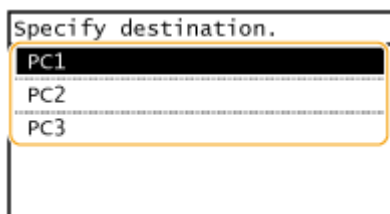

5 Select the scan type.

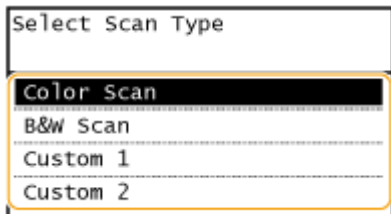

Scan type	Color	Resolution	File format
<Color Scan>	Color	300 dpi	JPEG (Exif)
<B&W Scan>	Black and white* ¹	300 dpi	PDF (searchable* ²)
<Custom 1>	Color	300 dpi	JPEG (Exif)
<Custom 2>	Color	300 dpi	JPEG (Exif)

*¹ Documents are scanned in black and white only, with no intermediate shades of gray.

*² A PDF format where characters on the document are scanned as text data and the text can be searched using a computer.

NOTE:

To change settings

- The settings in the table above are all factory default settings. You can change settings from MF Scan Utility. For more information, click [Instructions] on MF Scan Utility.
- If you are a Mac OS user, see the User's Guide for ScanGear MF.

6 Press .

- Scanning starts.
- To cancel, tap <Cancel> ► <Yes>.

IMPORTANT:

You cannot scan while the ScanGear MF is displayed. Close the screen before scanning.

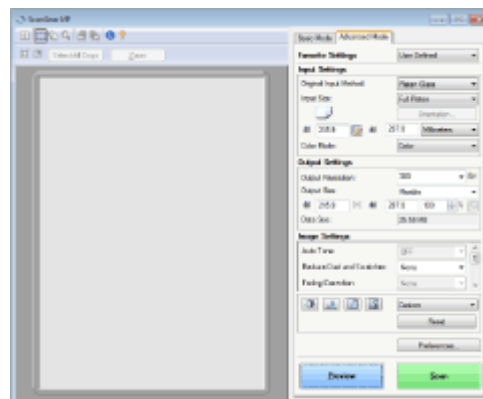

■When placing documents in the feeder in step 1

When scanning is complete, the save destination folder is displayed on the computer.

■When placing documents on the platen glass in step 1

When scanning is complete, follow the procedure below (when file format is PDF).

- 1 If there are additional pages of documents to be scanned, place the next document on the platen glass, and press .

- Repeat this step until you finish scanning all of the pages.
- When there is only one page to be scanned, proceed to the next step.

2 Tap <Finish Scan>.

- The save destination folder is displayed on the computer.

NOTE

About the save destination folder

- By default, the scanned data is saved to the [My Documents] folder. A subfolder named with the scanning date is created, and the data is saved to that folder.
- You can change the save destination from MF Scan Utility. For more information, click [Instructions] on MF Scan Utility.

TIPS

Scan from the machine more easily

- If you have regularly used preferences, such as scanning in color or black and white, or a pre-determined computer where scanned documents will be saved, specifying these settings each time you scan can be troublesome. Register these settings in a <Scan -> PC> button so that you can scan with one press of a button. There are two <Scan -> PC> buttons: <Scan -> PC1> and <Scan -> PC2>. You can register your settings in either of these buttons. ▶ **Scanning Using the <Scan -> PC> Button(P. 237)**

Other useful scanning functions (MF249dw / MF246dn)

- You can send scanned documents by e-mail. The documents can also be saved to shared folders. You can accomplish these functions directly from the machine.
 - ▶ **Sending Documents as E-Mails Directly from the Machine(P. 246)**
 - ▶ **Saving Documents Directly in Shared Folder(P. 253)**

Scanning Using the <Scan -> PC> Button

14L7-04F



Place a document on the machine, and tap <Scan -> PC1> or <Scan -> PC2>, and scanning starts immediately. The type of scan (color or black and white), the save destination for the document, and other settings can be registered to a button, and documents can be scanned using those settings. This section describes how to register settings in a button and scan with it.

- ▶ Registering Your Settings in the <Scan -> PC> Button(P. 237)
- ▶ Using the <Scan -> PC> Button(P. 239)

Registering Your Settings in the <Scan -> PC> Button

Register the computer that scanned images are saved in and the type of scan to <Scan -> PC1> or <Scan -> PC2> button.

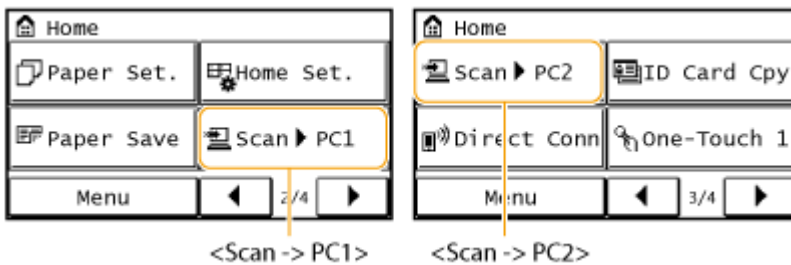

- 1 Press and tap <Menu>.

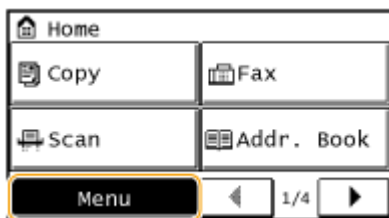

- 2 Tap <Scan Settings>.
- 3 Select <Shortcut Key Settings> ▶ <Register>.
- 4 Tap <Scan -> PC1> or <Scan -> PC2>.

- Select the button to which you want to register settings.

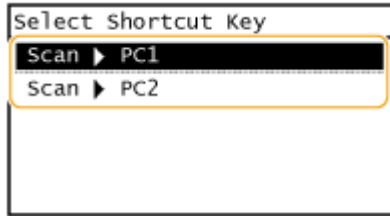

5 Select the type of connection that is used between the machine and computer.

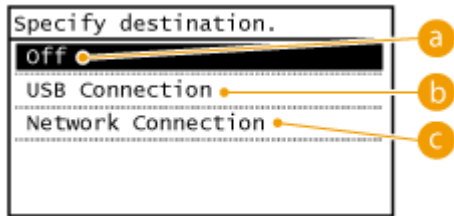

a <Off>

Select this setting to erase registered settings.

b <USB Connection>

Select this setting if the machine and computer are connected via USB.

c <Network Connection> (MF249dw / MF246dn / MF237w)

Select this setting if the machine and computer are connected via a network.

6 Select the destination computer.

- This screen is not displayed if you select <USB Connection> in step 5.

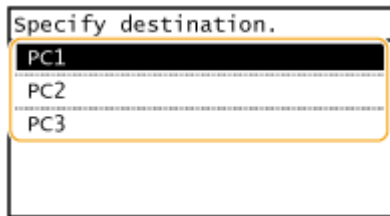

7 Select the scan type.

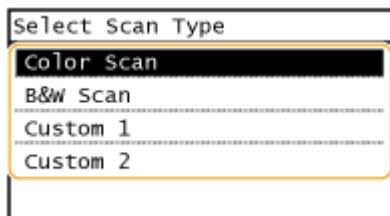

Scan type	Color	Resolution	File format
<Color Scan>	Color	300 dpi	JPEG (Exif)
<B&W Scan>	Black and white* ¹	300 dpi	PDF (searchable* ²)

*¹ Documents are scanned in black and white only, with no intermediate shades of gray.

*² A PDF format where characters on the document are scanned as text data and the text can be searched using a computer.

Scan type	Color	Resolution	File format
<Custom 1>	Color	300 dpi	JPEG (Exif)
<Custom 2>	Color	300 dpi	JPEG (Exif)

*1 Documents are scanned in black and white only, with no intermediate shades of gray.

*2 A PDF format where characters on the document are scanned as text data and the text can be searched using a computer.

NOTE:

To change settings

- The settings in the table above are all factory default settings. You can change settings from MF Scan Utility. For more information, click [Instructions] on MF Scan Utility.
- If you are a Mac OS user, see the User's Guide for ScanGear MF.

■ **Checking the Registered Settings**

 <Menu> ▶ <Scan Settings> ▶ <Shortcut Key Settings> ▶ <Confirm Destination> ▶ Select <Scan -> PC1> or <Scan -> PC2>

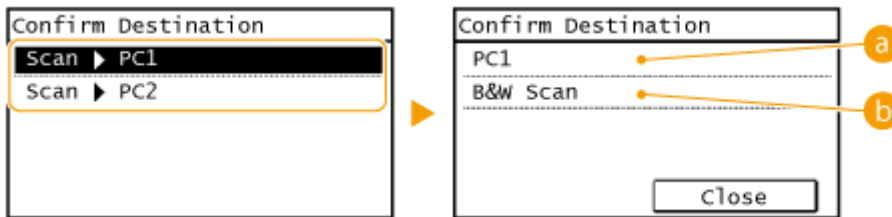

a Name of destination computer

Shows the name of the computer registered as the save destination.

b Scan type

Shows the type of scan that has been set.

Using the <Scan -> PC> Button

1 Place the document(s).  **Placing Documents(P. 41)**

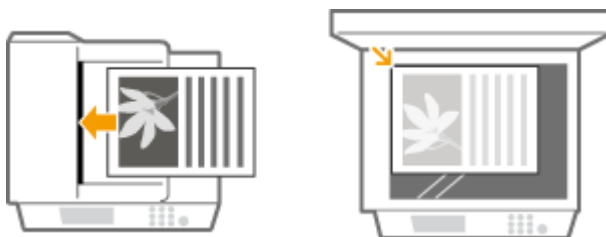

2 Press  and tap <Scan -> PC1> or <Scan -> PC2> button.

- To check the settings registered in the button, see **▶Checking the Registered Settings(P. 239)** .
- Scanning starts.
- To cancel, tap <Cancel> ▶ <Yes>.

IMPORTANT:

You cannot scan while the ScanGear MF is displayed. Close the screen before scanning.

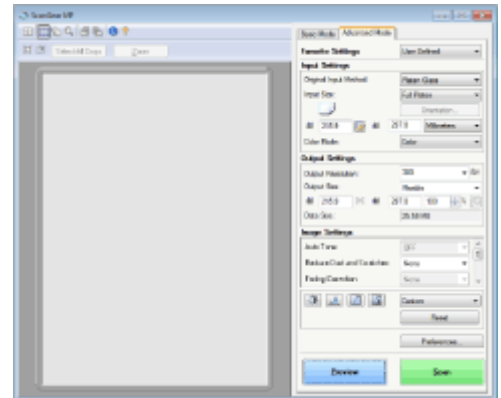

■When placing documents in the feeder in step 1

When scanning is complete, the save destination folder is displayed on the computer.

■When placing documents on the platen glass in step 1

When scanning is complete, follow the procedure below (when file format is PDF).

- 1 If there are additional pages of documents to be scanned, place the next document on the platen glass, and press .
 - Repeat this step until you finish scanning all of the pages.
 - When there is only one page to be scanned, proceed to the next step.
- 2 Tap <Finish Scan>.
 - The save destination folder is displayed on the computer.

NOTE

About the save destination folder

- By default, the scanned data is saved to the [My Documents] folder. A subfolder named with the scanning date is created, and the data is saved to that folder.
- You can change the save destination from MF Scan Utility. For more information, click [Instructions] on MF Scan Utility.

LINKS

▶Scanning from the Machine(P. 234)

Scanning from a Computer

14L7-04H

There are two ways to scan from a computer: using MF Scan Utility and using an application such as an image-processing or word-processing application.

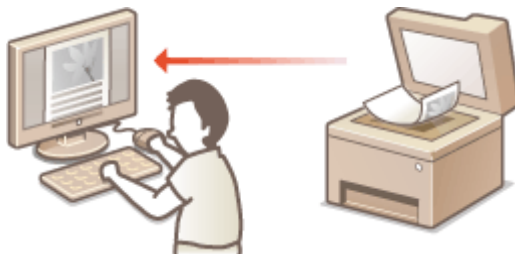

Scanning Using MF Scan Utility



MF Scan Utility is an application included with the machine that enables you to scan documents or images to a computer. You can forward the scanned data to a specified application, or attach it to an e-mail message. After installing it from the supplied DVD-ROM, click [MF Scan Utility] displayed in the Windows start menu to start MF Scan Utility. For details on using this utility, click [Instructions] on MF Scan Utility.

NOTE

- If you are a Mac OS user, see the User's Guide for ScanGear MF.

Scanning Using an Application



You can scan images by using an application such as a word-processing or image-processing application, and load the images directly into the application. You do not need to start another application to scan.

Scanning Using an Application

14L7-04J



You can scan documents from applications such as image-processing or word-processing software. The scanned image is directly loaded in the application, allowing you to edit or process the image immediately. The following procedure varies depending on the application.

IMPORTANT

- The application must be compatible with TWAIN or WIA*. For more information, see the instruction manual for your application.

* TWAIN is a standard for connecting image input devices, such as scanners, with computers. WIA is a function that is an integrated standard in Windows.

1 Place the document(s). **▶ Placing Documents(P. 41)**

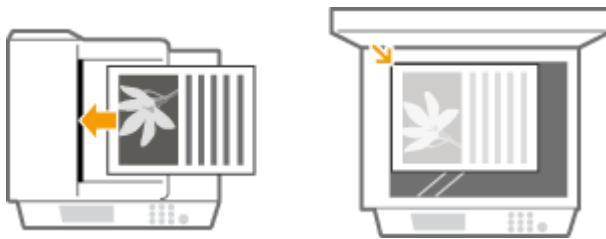

IMPORTANT:

- The second or subsequent documents may not be scanned, or an error message may be displayed depending on the application. In such a case, place and scan one document at a time.
- When <Auto Online for Remote Scan> is set to <Off>, you must tap <Scan> ▶ <Remote Scanner> in the <Home> screen to bring the machine online. **▶ Auto Online for Remote Scan(P. 531)**

2 From the application, select the start scan command.

- The procedure for selecting the start scan command varies depending on the application. For more information, see the instruction manual for your application.

3 Select the scanner driver for the machine.

- Select ScanGear MF or WIA.

4 Configure the scan settings as necessary.

- For more information about ScanGear MF scan settings, see **▶ Configuring Scan Settings in ScanGear MF(P. 244)** .

5 Click [Scan].

⇒ Scanning of the document starts.

- When scanning is complete, the scanned image is forwarded to an application.

LINKS

[!\[\]\(4729e517bc6a7cd81c8025b9646574fb_img.jpg\) Configuring Scan Settings in ScanGear MF\(P. 244\)](#)

Configuring Scan Settings in ScanGear MF

14L7-04K



ScanGear MF is a scanner driver included with the machine. You can use ScanGear MF to configure advanced scan settings when you scan. The way of starting ScanGear MF differs depending of the way of scanning from the computer.

Starting from MF Scan Utility

When scanning from MF Scan Utility, click [ScanGear] to start ScanGear MF. For instructions on how to use ScanGear MF, click [Instructions] on MF Scan Utility.

NOTE

- If you are a Mac OS user, see the User's Guide for ScanGear MF.

Starting from an Application

- To scan from applications such as image-processing or word-processing software, select ScanGear MF as scanner driver. **Scanning Using an Application(P. 242)**
- For instructions on how to use ScanGear MF, click on the ScanGear MF  icon and see the Help.



Convenient Scanning with a Machine-Based Operation

MF249dw / MF246dn

14L7-04L

The machine can convert original documents into electronic file formats such as PDF without using a computer. There are many advantages to digitizing documents. A variety of useful settings are available to suit your needs.

Sending Documents as E-Mails Directly from the Machine

You can save scanned documents as JPEG images, PDF files or in other digital file formats and send them directly from the machine as e-mail attachments. You can work more efficiently because this feature eliminates the need to use your computer to send scanned documents. **➤ Sending Documents as E-Mails Directly from the Machine(P. 246)**



Saving Documents Directly in Shared Folder

You can save scanned documents as JPEG images, PDF files or in other digital file formats and store them in shared folders on computers. This feature is helpful when digitalizing paper documents for sharing. **➤ Saving Documents Directly in Shared Folder(P. 253)**

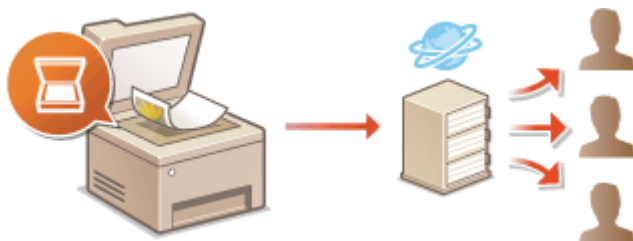

Sending Documents as E-Mails Directly from the Machine

14L7-04R

This section describes how to scan documents and send them as e-mails directly from the machine. Scanned documents are sent as e-mail attachments in JPEG, PDF, or other digital file formats. You can specify multiple destinations, including Cc/Bcc destinations, just like you can when sending normal e-mails.

NOTE

- To send e-mails directly from the machine, you must complete preparations in advance, including specification of mail server settings. ▶ **Configuring Scan Settings (Sending E-Mail)(P. 358)**
- When you specify multiple destinations, the second and following destinations must be ones registered in the Address Book. As for Cc and Bcc, you can only specify destinations registered in the Address Book. To use the Address Book, you must complete the necessary registration procedure in advance. ▶ **Registering in the Address Book(P. 60)**

1 Place the document(s). ▶ **Placing Documents(P. 41)**

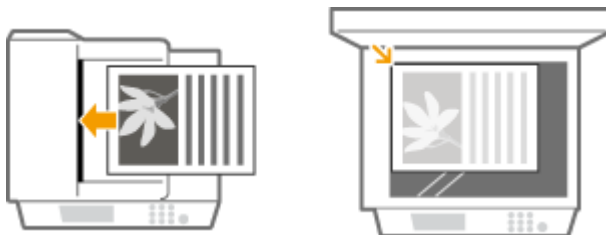

2 Press and tap <Scan>.

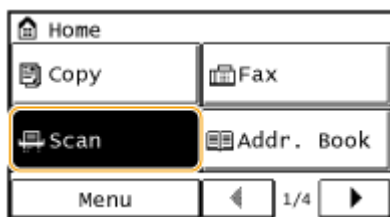

3 Tap <E-Mail>.

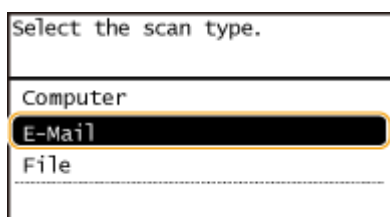

4 Enter the destination using the numeric keys, and tap <Apply>.

- On how to enter text, see ▶ **Entering Text(P. 38)** .

- To use the Address Book to quickly specify destinations: **▶ Sending Using Registered Destinations (E-Mail/ Shared Folder)(P. 272)**



5 Specify multiple destinations, including Cc/Bcc destinations, as necessary.

- Tap <Destination>, and select the method for specifying destinations.

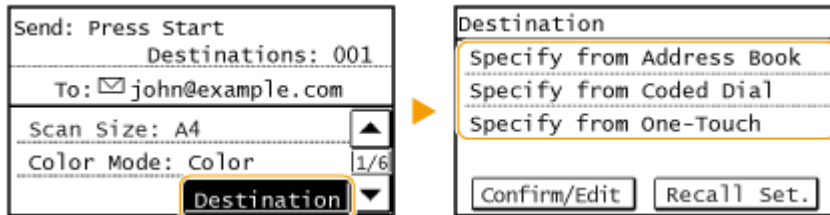

6 Specify the scanning settings as necessary.

- Tap the settings. **▶ Specifying Detailed Settings(P. 258)**

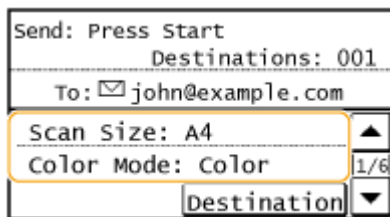

NOTE:

- The file name of a scanned document is automatically assigned based on the following format: "communication management number (four digits)_sent date and time_document number (three digits).file extension."
Example of file names: If a one-page document is converted into a PDF file and sent on October 17, 2015 at 07:00:05 P.M.
 "0045_151017190005_001.pdf"
- You cannot specify file names yourself.

7 Specify the subject, body, reply-to address, and priority for the e-mail as necessary.

- The subject and the priority are set to "Attached Image" and "Standard" respectively by default.
- The body is not set by default. Enter it as necessary. Without the body text, only scanned documents are sent.
- The reply-to address is not set by default. If you want to display the reply-to address differently from that of the machine, specify the address from among those registered in the Address Book. If no destination is registered in the Address Book, see **▶ Registering in the Address Book(P. 60)** .



■ To specify subject/body

- 1 Tap <Subject/Message>.

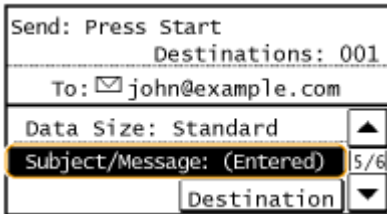

- 2 Tap <Subject>.

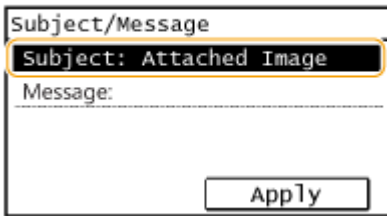

- 3 Enter the subject using the numeric keys, and tap <Apply>.

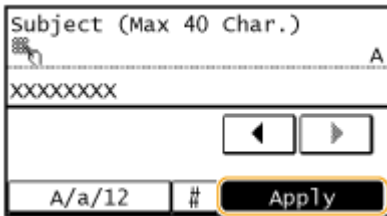

- 4 Tap <Message>.

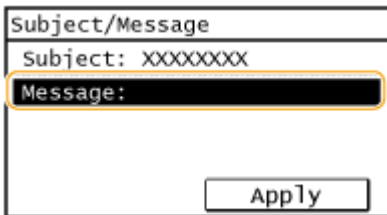

- 5 Enter the body using the numeric keys, and tap <Apply>.

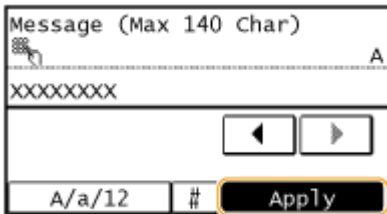

- 6 Tap <Apply>.



■ To specify reply-to address

- 1 Tap <Reply To>.

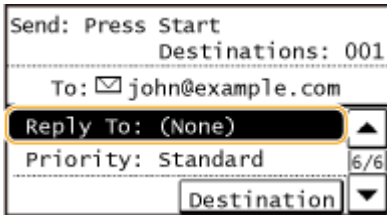

- 2 Tap <Specify from Address Book>.

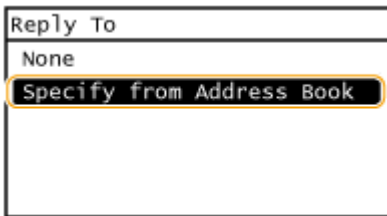

- 3 Select a reply-to address from the Address Book.

- For instructions on how to use the Address Book, see [Specifying from Address Book\(P. 273\)](#) .

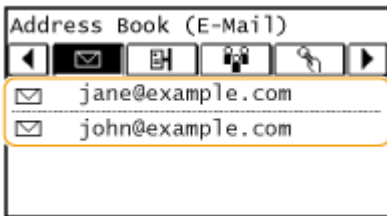

■ To specify priority

- 1 Tap <Priority>.

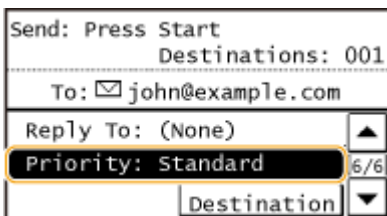

- 2 Select a priority level.

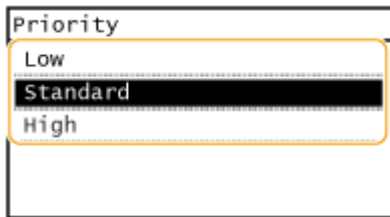

8 Press to start sending.

⇒ Scanning of the document starts.

- To cancel sending, tap <Cancel> ► <Yes>. [▶Canceling Sending Documents \(E-Mail/Shared Folder\) \(P. 256\)](#)

■When placing documents in the feeder in step 1

When scanning is complete, the e-mail is sent.

■When placing documents on the platen glass in step 1

When scanning is complete, follow the procedures below (except if you selected JPEG as a file format in step 6).

- 1 If there are additional pages of documents to be scanned, place the next document on the platen glass, and press .
 - Repeat this step until you finish scanning all of the pages.
 - When there is only one page to be scanned, proceed to the next step.
- 2 Tap <Start TX>.

⇒ The e-mail is sent.

If a Send Error Occurs

Error notifications are sometimes sent to the e-mail address set to the machine. If you leave it as-is, it may result in an insufficient remaining capacity of mailbox depending on your mail server. It is recommended that you clear the mailbox periodically.

■To clear the mailbox

IMPORTANT:

- When the mailbox is cleared, all e-mail in the server mailbox is deleted. When you specify the e-mail account that you use usually, you should first check whether any e-mail in the mailbox needs to be kept.

- 1 Start the Remote UI and log on in System Manager Mode. [▶Starting Remote UI\(P. 450\)](#)
- 2 Click [Settings/Registration].

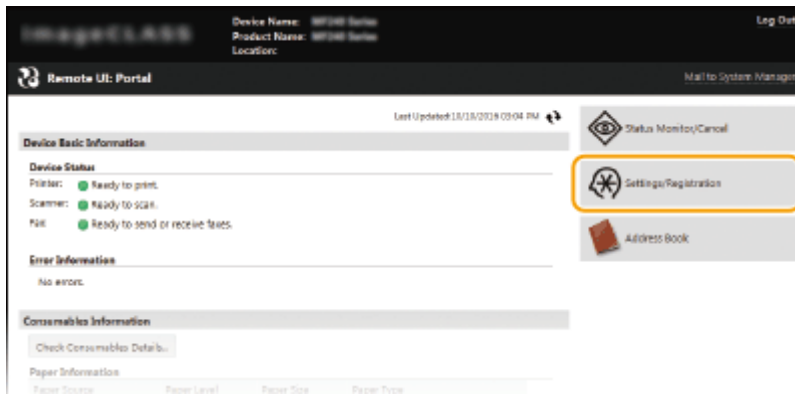

3 Click [Network Settings] ► [E-Mail Settings].

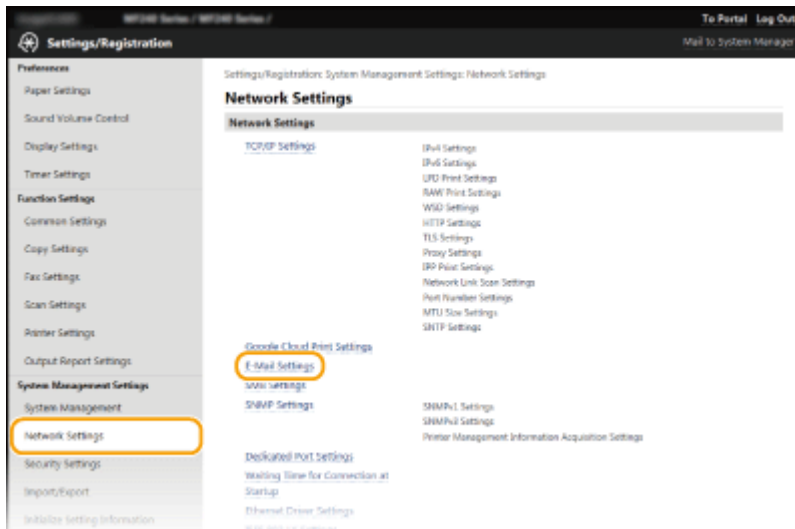

4 Click [Clear] in [Clear Mail Box].

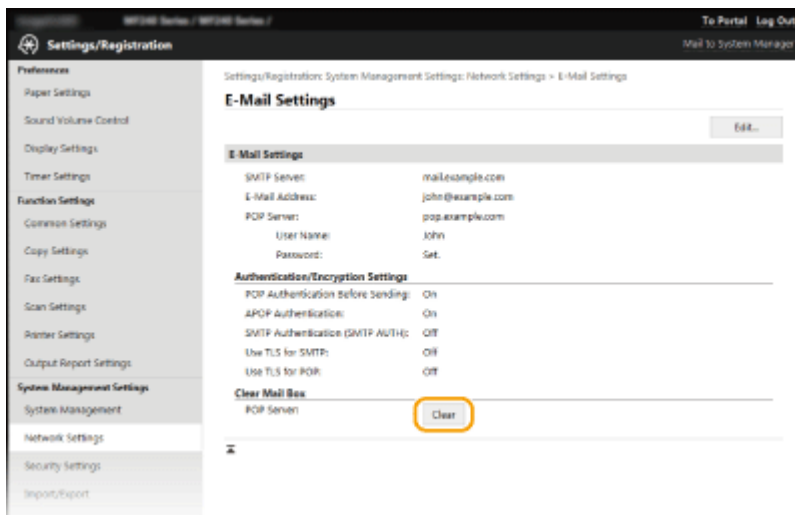

5 Read the message that is displayed, and click [OK].

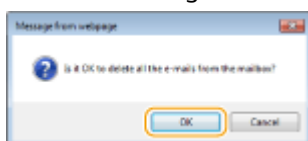

⇒ E-mail is deleted from the mailbox.

- If you always want to scan with the same settings: [▶ Changing Default Settings\(P. 284\)](#)
- If you want to specify the e-mail sender name: [▶ Register Unit Name \(E-Mail\)\(P. 510\)](#)

LINKS

- ▶ [Checking Status and Log for Sent Documents \(E-Mail/Shared Folder\)\(P. 286\)](#)

Saving Documents Directly in Shared Folder

14L7-04S

This section describes how to scan documents and save them to a shared folder directly from the machine. Scanned documents are saved as JPEG images, PDF files or in other digital file formats.

NOTE

- To save documents directly to a shared folder, you must complete preparations in advance, including specification of the save destination.
 - ▶ **Configuring the Machine for Scanning to Shared Folders(P. 367)**
- Available destinations for shared folders are limited to the destinations registered in the Address Book. To specify a destination using the Address Book, it is necessary to register the destinations for shared folders beforehand.
 - ▶ **Setting a Shared Folder as a Save Location(P. 368)**
 - ▶ **Registering Address Book from Remote UI(P. 467)**
- You can only specify one destination at a time.

1 Place the document(s). ▶ **Placing Documents(P. 41)**

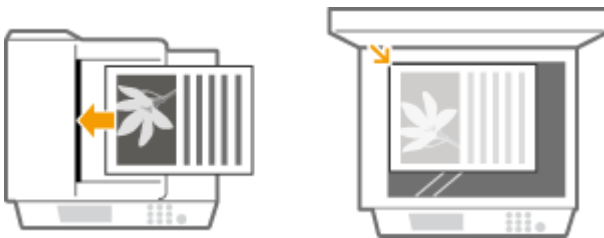

2 Press and tap <Scan>.

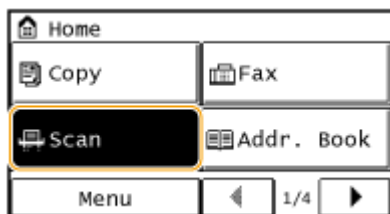

3 Tap <File>.

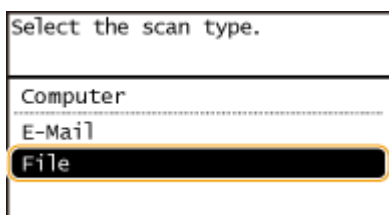

4 Select a destination from the Address Book.

- For instructions on how to use the Address Book, see ▶ **Specifying from Address Book(P. 273)** .

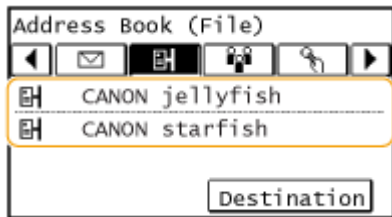

- Selecting destinations directly by entering coded dial numbers. You can also specify previously used destinations.
 - ▶ **Selecting Destinations Directly by Entering Coded Dial Numbers(P. 276)**
 - ▶ **Specifying Previously Used Destinations(P. 281)**

5 Specify the scanning settings as necessary.

- Tap the settings. ▶ **Specifying Detailed Settings(P. 258)**

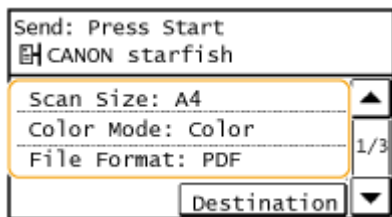

NOTE:

- The file name of a scanned document is automatically assigned based on the following format: "communication management number (four digits)_sent date and time_document number (three digits).file extension name."

Example of file names: If a one-page document is converted into a PDF file and sent on October 17, 2015 at 07:00:05 P.M.
"0045_151017190005_001.pdf"
- You cannot specify file names yourself.

6 Press to start scanning.

⇒ Scanning of the document starts.

- To cancel scanning, tap <Cancel> ▶ <Yes>. ▶ **Canceling Sending Documents (E-Mail/Shared Folder) (P. 256)**

■ When placing documents in the feeder in step 1

When scanning is complete, the documents are scanned to the shared folder.

■ When placing documents on the platen glass in step 1

When scanning is complete, follow the procedures below (except if you selected JPEG as a file format in step 5).

- 1 If there are additional pages of documents to be scanned, place the next document on the platen glass, and press .
 - Repeat this step until you finish scanning all of the pages.
 - When there is only one page to be scanned, proceed to the next step.

- 2 Tap <Start TX>.

⇒ The documents are scanned to the shared folder.

TIPS



- If you always want to scan with the same settings: [▶ Changing Default Settings\(P. 284\)](#)

LINKS

- ▶ [Checking Status and Log for Sent Documents \(E-Mail/Shared Folder\)\(P. 286\)](#)

Canceling Sending Documents (E-Mail/Shared Folder)

14L7-04U

If you want to cancel sending documents immediately after pressing , tap <Cancel> on the display or press . You can also cancel sending documents after checking the sending status.

■ Use <Cancel> to Cancel

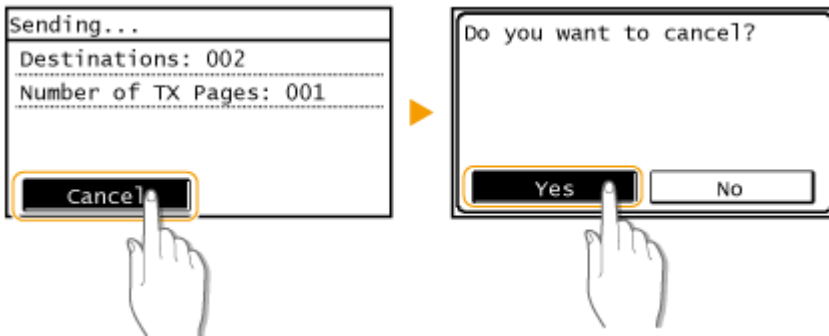

■ Press to Cancel



If the Screen Displays a List of Documents When Is Pressed

Documents have been scanned and are waiting to be processed. Select the document to cancel.

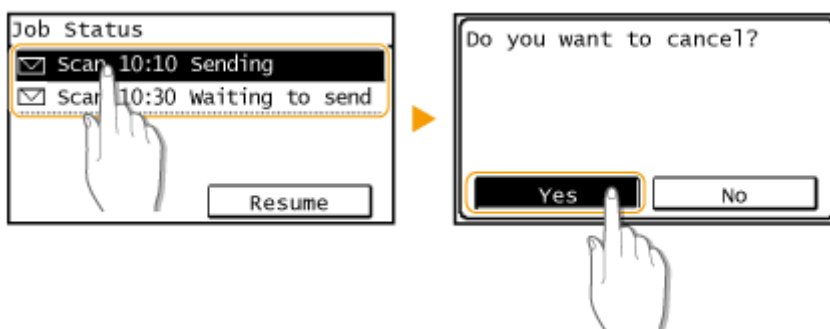

■ Check the Transmission Status before Canceling

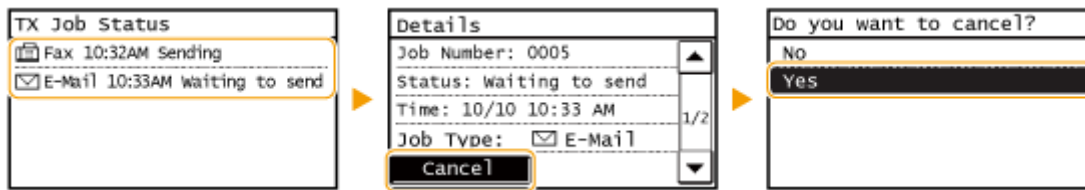
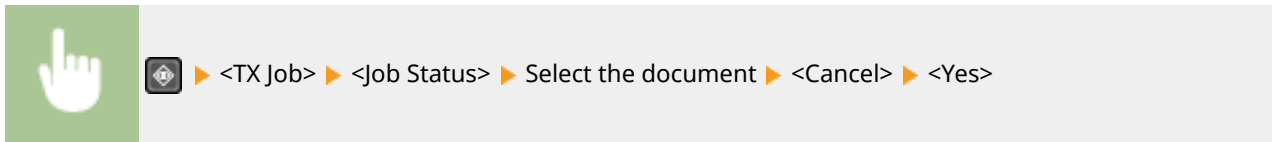

LINKS

- ▶ [Sending Documents as E-Mails Directly from the Machine\(P. 246\)](#)
- ▶ [Saving Documents Directly in Shared Folder\(P. 253\)](#)
- ▶ [Checking Status and Log for Sent Documents \(E-Mail/Shared Folder\)\(P. 286\)](#)

Specifying Detailed Settings

14L7-04W

This section describes the settings available when scanning documents. These settings include specifying the file format into which documents are converted and adjusting density to improve the appearance of scanned documents as well as the basic settings such as specifying the document orientation or scanning size.



▶ **Specifying a Scanning Size(P. 260)**



▶ **Setting Color Mode(P. 261)**



▶ **Selecting a File Format(P. 262)**

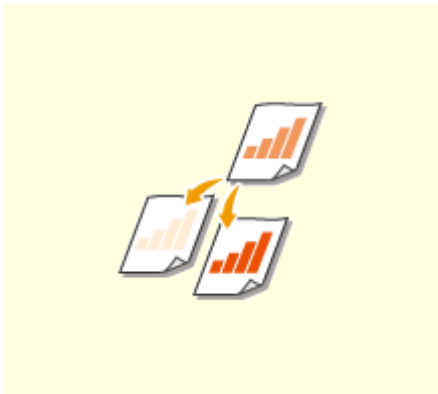

▶ **Adjusting Density(P. 264)**



▶ **Specifying Orientation of Your Document(P. 265)**

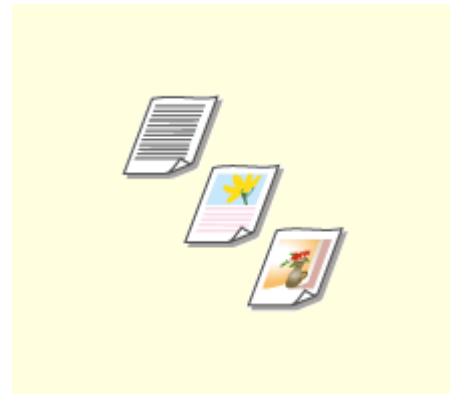

▶ **Selecting Document Type(P. 266)**

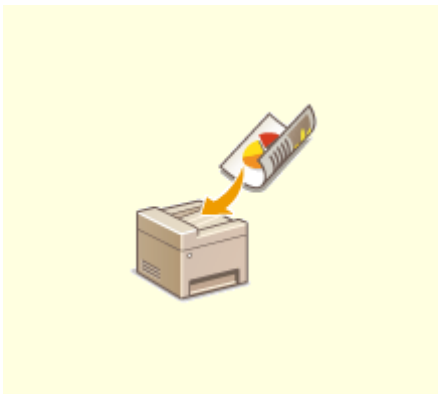

▶ **Scanning 2-Sided Documents (MF249dw)(P. 267)**

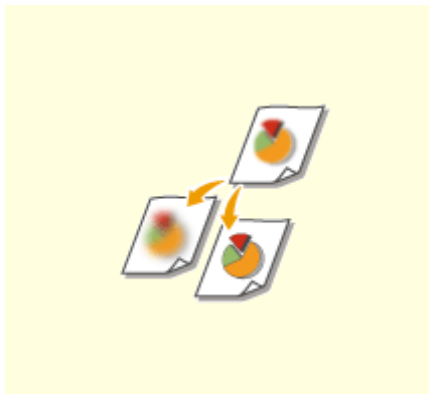

▶ **Adjusting Sharpness(P. 268)**



▶ **Adjusting Balance between File Size and Image Quality(P. 270)**



▶ **Setting Gamma Values(P. 271)**

Specifying a Scanning Size

14L7-04X



You can specify the scanning size of your documents.



<Scan> ▶ Specify a destination with <E-Mail>/<File> ▶ <Scan Size> ▶ Select the document size

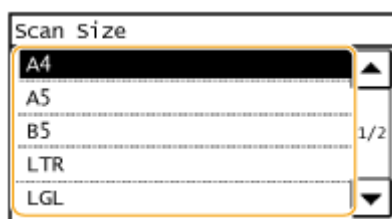

LINKS

- ▶ [Sending Documents as E-Mails Directly from the Machine\(P. 246\)](#)
- ▶ [Saving Documents Directly in Shared Folder\(P. 253\)](#)

Setting Color Mode

14L7-04Y



You can specify whether to scan documents in color or black and white.



<Scan> ▶ Specify a destination with <E-Mail>/<File> ▶ <Color Mode> ▶ Select the color mode

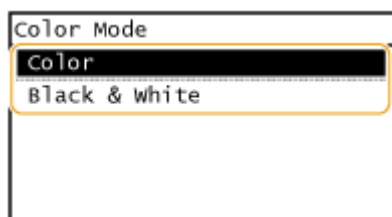

LINKS

- ▶ **Sending Documents as E-Mails Directly from the Machine(P. 246)**
- ▶ **Saving Documents Directly in Shared Folder(P. 253)**

Selecting a File Format

14L7-050



You can select the file format to which documents are scanned, from PDF/JPEG/TIFF. For PDF, you can select a highly compressed PDF file with a reduced file size.



<Scan> ► Specify a destination with <E-Mail>/<File> ► <File Format> ► Select a file format

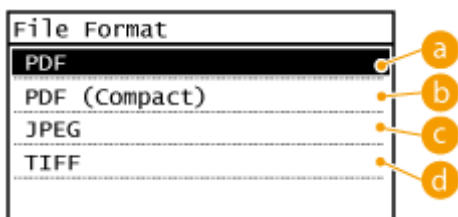

a <PDF>

Converts a scanned document into a PDF file with no file size reduction.

b <PDF (Compact)>

Converts a scanned document into a PDF file with a reduced file size than that of <PDF>.

c <JPEG>

The scanned document is converted into a JPEG file.

d <TIFF>

The scanned document is converted into a TIFF file.

NOTE

- If you select JPEG in <File Format> and try to scan a document from the platen glass, you can only scan one page. To scan a multiple-page document all at once, use the feeder. Each page of the document is saved as a separate file. If you select TIFF or PDF, you can scan multiple-page documents either from the platen glass or from the feeder and the whole of the scanned document is saved as one file.
- <PDF (Compact)> compresses photos and illustrations on documents more than <PDF>. The file will be smaller, but the image quality of some documents or the number of documents that can be scanned at once may be lower.
- For the resolutions of each file format, see ► **Specifications for Scanning to Shared Folders (MF249dw / MF246dn)(P. 654)** .

LINKS

- ▶ **Sending Documents as E-Mails Directly from the Machine(P. 246)**
- ▶ **Saving Documents Directly in Shared Folder(P. 253)**

Adjusting Density

14L7-051



You can adjust the density of the scan if the text or images in a document are too light or dark.



<Scan> ▶ Specify a destination with <E-Mail>/<File> ▶ <Density> ▶ Adjust the density ▶ <Apply>

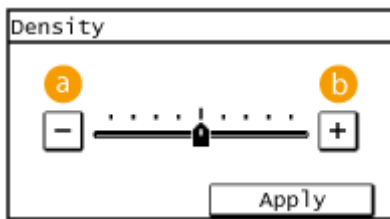

a <->

Decreases the density.

b <+>

Increases the density.

LINKS

- ▶ [Sending Documents as E-Mails Directly from the Machine\(P. 246\)](#)
- ▶ [Saving Documents Directly in Shared Folder\(P. 253\)](#)
- ▶ [Adjusting Sharpness\(P. 268\)](#)

Specifying Orientation of Your Document

14L7-052



You can specify portrait or landscape orientation.



<Scan> ► Specify a destination with <E-Mail>/<File> ► <Original Orientation> ► Select the document type

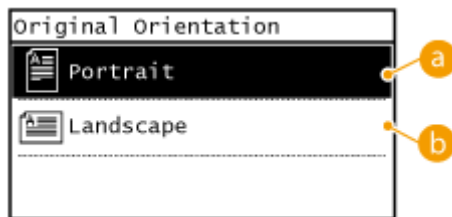

a <Portrait>

Select for documents with portrait orientation.

b <Landscape>

Select for documents with landscape orientation.

LINKS

- 🔗 [Sending Documents as E-Mails Directly from the Machine\(P. 246\)](#)
- 🔗 [Saving Documents Directly in Shared Folder\(P. 253\)](#)

Selecting Document Type

14L7-053



You can select the image quality for the scan depending on the document type, such as text-only documents, documents with charts and graphs, or magazine photos.



<Scan> ► Specify a destination with <E-Mail>/<File> ► <Original Type> ► Select the document type

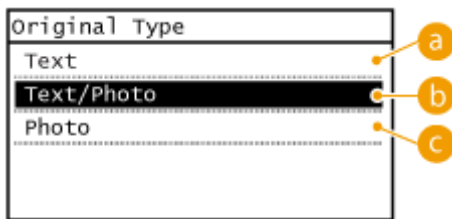

a <Text>

Suitable when scanning documents that only contain text.

b <Text/Photo>

Suitable when scanning documents that contain both text and photos.

c <Photo>

Suitable when scanning documents that contain printed photos, such as magazines or pamphlets.

LINKS

► [Sending Documents as E-Mails Directly from the Machine\(P. 246\)](#)

► [Saving Documents Directly in Shared Folder\(P. 253\)](#)

Scanning 2-Sided Documents MF249dw

14L7-054



The machine can automatically scan the front and back sides of documents in the feeder.

IMPORTANT

- The machine cannot scan both sides of documents automatically when the documents are placed on the platen glass.



<Scan> ▶ Specify a destination with <E-Mail>/<File> ▶ <2-Sided Original> ▶ Select <Book Type> or <Calendar Type>

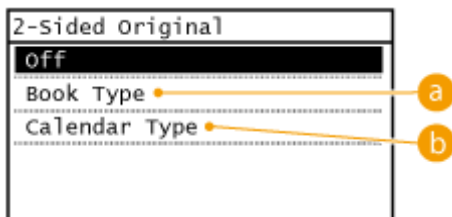

a <Book Type>

Select for documents whose images on the front and back sides face the same direction.

b <Calendar Type>

Select for documents whose images on the front and back sides face in opposite directions.

LINKS

- ▶ [Sending Documents as E-Mails Directly from the Machine\(P. 246\)](#)
- ▶ [Saving Documents Directly in Shared Folder\(P. 253\)](#)

Adjusting Sharpness

14L7-055



You can adjust the sharpness of the image. Increase the sharpness to sharpen blurred text and lines, or decrease the sharpness to improve the appearance of magazine photos.



<Scan> ▶ Specify a destination with <E-Mail>/<File> ▶ <Sharpness> ▶ Adjust the sharpness ▶ <Apply>

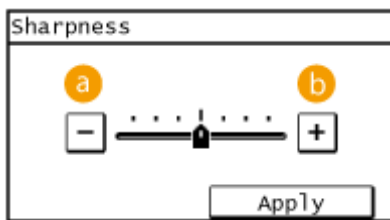

a <->

Decreases the sharpness, resulting in a softer image.

Example: If you want to improve the appearance of magazine photos

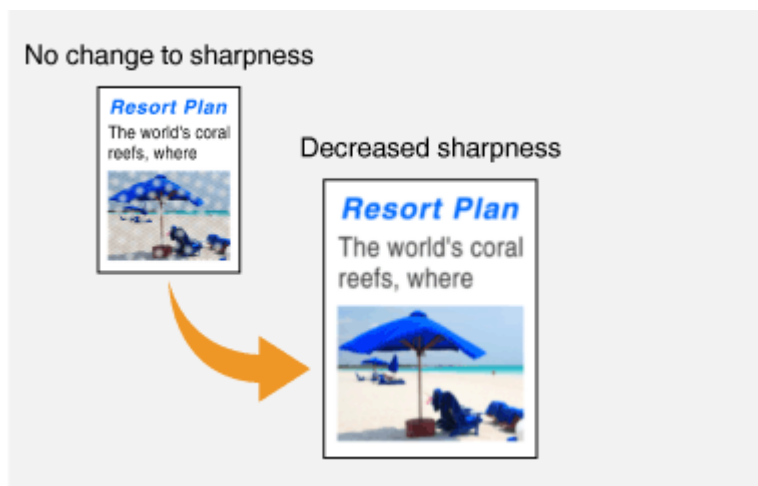

b <+>

Increases the image sharpness.

Example: If you want to sharpen text and lines written in pencil

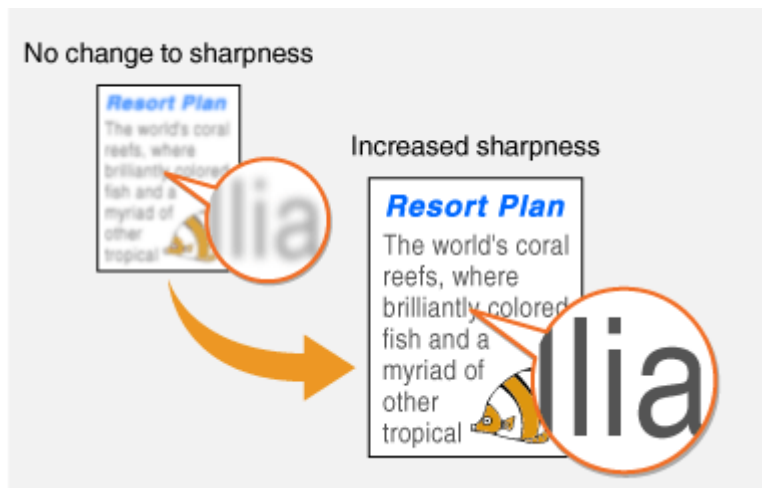

LINKS

- ▶ **Sending Documents as E-Mails Directly from the Machine(P. 246)**
- ▶ **Saving Documents Directly in Shared Folder(P. 253)**
- ▶ **Adjusting Density(P. 264)**

Adjusting Balance between File Size and Image Quality

14L7-056



You can specify the file compression ratio when converting scanned documents into the JPEG format. <Small: Memory Priority> makes the compression ratio higher than normal to create smaller files with lower image quality. On the other hand, <Large: Image Quality Priority> makes the compression ratio lower than normal larger files with higher image quality.



<Scan> ► Specify a destination with <E-Mail>/<File> ► <Data Size> ► Specify the setting

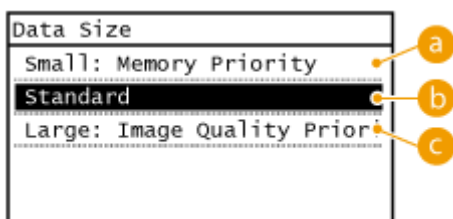

a <Small: Memory Priority>

The data size is highly compressed and reduced, but the image quality becomes low.

b <Standard>

The compression ratio and the image quality are adjusted to an intermediate setting between <Small: Memory Priority> and <Large: Image Quality Priority>.

c <Large: Image Quality Priority>

The image quality improves, but the data compression ratio decreased and data size becomes large.

LINKS

- 🔗 [Sending Documents as E-Mails Directly from the Machine\(P. 246\)](#)
- 🔗 [Saving Documents Directly in Shared Folder\(P. 253\)](#)
- 🔗 [Selecting a File Format\(P. 262\)](#)

Setting Gamma Values

14L7-057



The scanned documents are converted into the specified file formats. At that time, you can specify the gamma values to apply to the documents. You can specify the same gamma value as that of the monitor which is to be used for viewing the converted files so the files are displayed with brightness true to the original documents.

NOTE

- For the gamma value of a monitor display, see the instruction manual included with the display.



<Menu> ▶ <Scan Settings> ▶ <Output File Image Settings> ▶ <YCbCr TX Gamma Value> ▶ Select the gamma value

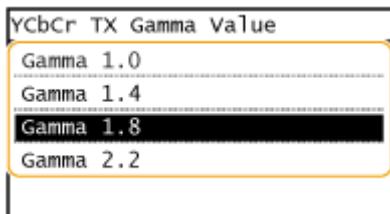

LINKS

- ▶ [Sending Documents as E-Mails Directly from the Machine\(P. 246\)](#)
- ▶ [Saving Documents Directly in Shared Folder\(P. 253\)](#)
- ▶ [Selecting a File Format\(P. 262\)](#)

Sending Using Registered Destinations (E-Mail/Shared Folder)

14L7-058

You can specify destinations by selecting from the Address Book as well as by using the numeric keys. To use the Address Book, you need to register destinations in the Address Book beforehand. You can also specify previously used destinations.



▶ **Specifying from Address Book(P. 273)**



▶ **Selecting Destinations Directly by Entering Coded Dial Numbers(P. 276)**



▶ **Specifying Destinations with the One-Touch Buttons(P. 279)**



▶ **Specifying Previously Used Destinations(P. 281)**

TIPS for Enhancing Security

- If you want to limit available destinations to ones from the Address Book or previously specified ones: ▶ **Limiting Available Destinations(P. 417)**
- If you want to disable specifying previously used destinations: ▶ **Disabling Use of Previously Used Destinations(P. 419)**

LINKS

- ▶ **Sending Documents as E-Mails Directly from the Machine(P. 246)**
- ▶ **Saving Documents Directly in Shared Folder(P. 253)**
- ▶ **Registering in the Address Book(P. 60)**

Specifying from Address Book

14L7-059



The Address Book enables you to specify a destination by selecting from a list of registered destinations or by searching by name for destinations with recipient names.

NOTE

- You need to register destinations in the Address Book before using this feature. ▶ **Registering in the Address Book (P. 60)**
- To register shared folders as destinations, you need to perform the registration procedure from the computer.
 - ▶ **Setting a Shared Folder as a Save Location (P. 368)**
 - ▶ **Registering Address Book from Remote UI (P. 467)**

1 Press and tap <Scan>.

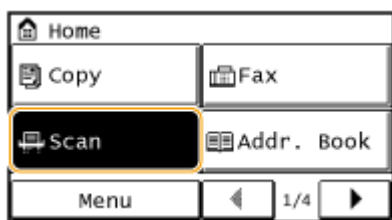

2 Tap <E-Mail> or <File>.

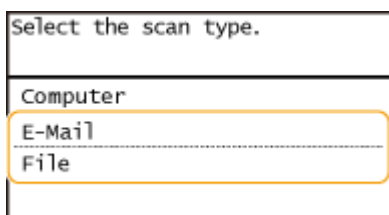

- If you select <File>, proceed to step 4.

3 Select <Destination> ▶ <Specify from Address Book>.



- If the <Type> screen appears, select <To>, <Cc>, or <Bcc> as a destination type.

4 Select a tab using ◀ / ▶.

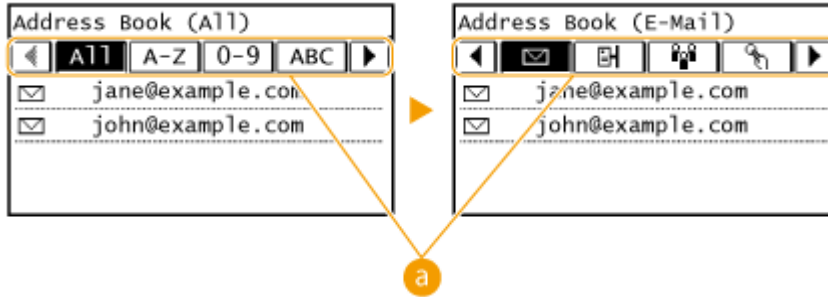

a <All>

Displays all the destinations registered in the Address Book.



Only destinations for one-touch dialing are displayed.

<A-Z>/<0-9>/<ABC> to <YZ>

Displays destinations with recipient names whose first characters correspond to the characters of the selected tab.



Displays destinations for faxes. Do not use in this procedure. To specify destinations using this tab, see **Specifying from Address Book(P. 121)** .



Displays destinations for e-mails.



Displays destinations for shared folders.



Displays a list of destinations registered in Group Dial. This feature is not available when scanning documents to shared folders.

5 Select a destination.

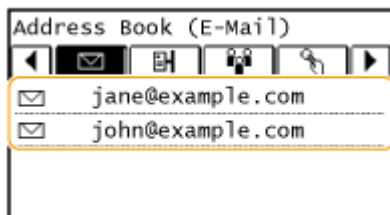

NOTE:

If you want to specify multiple destinations (e-mail)

- Repeat steps 3 to 5. Up to 50 destinations can be specified.

To delete destinations (e-mail)

If you specified multiple destinations, you can delete destinations as necessary.

- 1 Select <Destination> ▶ <Confirm/Edit>.

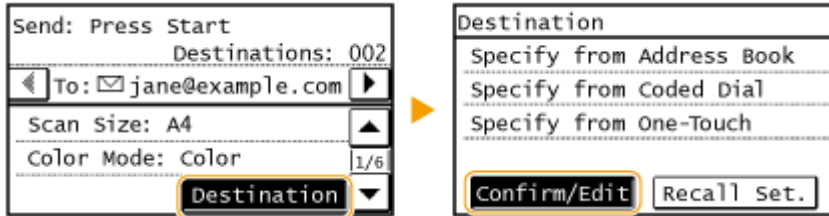

- 2 Select a destination you want to delete.



- 3 Tap <Remove>.

- If you select Group Dial in step 2, <Number of Destinations> is displayed. Tapping this item displays destinations registered in the group.

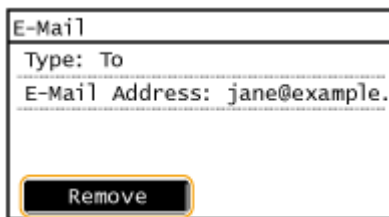

- 4 Tap <Yes>.

NOTE

If you want to easily and quickly delete destinations without displaying a list of destinations

- Before tapping <Destination> in step 1, you can tap ◀ / ▶ to toggle the destinations you specified. Display a destination you want to delete, and press **C**.

LINKS

- ◉ [Sending Documents as E-Mails Directly from the Machine\(P. 246\)](#)
- ◉ [Saving Documents Directly in Shared Folder\(P. 253\)](#)

Selecting Destinations Directly by Entering Coded Dial Numbers

14L7-05A



Three-digit numbers (coded dial numbers) are assigned to addresses in the Address Book. You can specify an address simply by entering its coded dial number.

NOTE

- To use coded dial numbers, the destination must be registered in the Address Book beforehand. [▶ Registering Destinations in the Address Book\(P. 61\)](#)
- To register shared folders as destinations, you need to perform the registration procedure from the computer.
 - ▶ [Setting a Shared Folder as a Save Location\(P. 368\)](#)
 - ▶ [Registering Address Book from Remote UI\(P. 467\)](#)

1 Press and tap <Scan>.

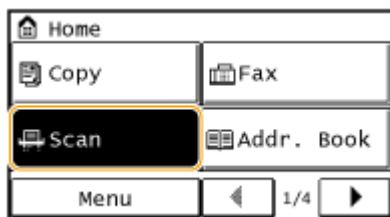

2 Tap <E-Mail> or <File>.

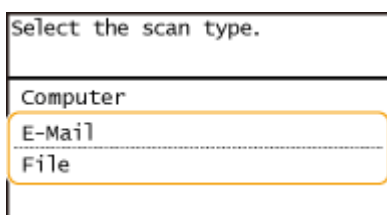

3 Select <Destination> ▶ <Specify from Coded Dial>.

■ If <E-Mail> is selected at step 2

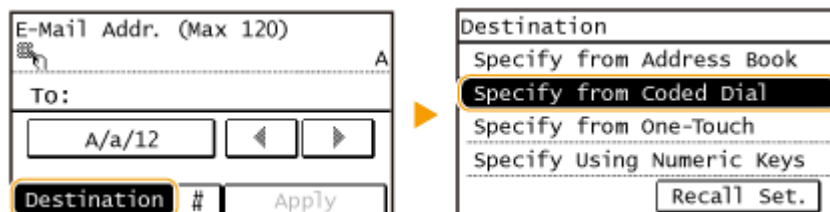

- If the <Type> screen appears, select <To>, <Cc>, or <Bcc> as a destination type.

■ If <File> is selected at step 2



4 Use the numeric keys to enter a three-digit number (001 to 100).

- If you enter the wrong characters, press **C**. (Press to delete each character one by one; press and hold to delete all the input characters at once.)

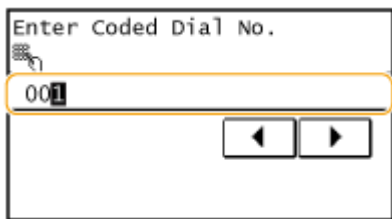

NOTE:

If a confirmation screen appears

- When <One-Touch/Coded Dial TX Confirmation> is set to <On>, a screen is displayed that shows the destination and the name for the number. (For Group Dial, the group name and the number of destinations are shown.) Check the contents and if everything is correct, tap <OK>. To specify a different destination, tap <Cancel> and then re-enter the three-digit coded dial number. **▶ Displaying Destinations in Address Book(P. 420)**

If you want to specify multiple destinations (e-mail)

- Repeat steps 2 and 3. Up to 50 destinations can be specified.

■ To delete destinations (e-mail)

If you specified multiple destinations, you can delete destinations as necessary.

- 1 Select <Destination> ▶ <Confirm/Edit>.

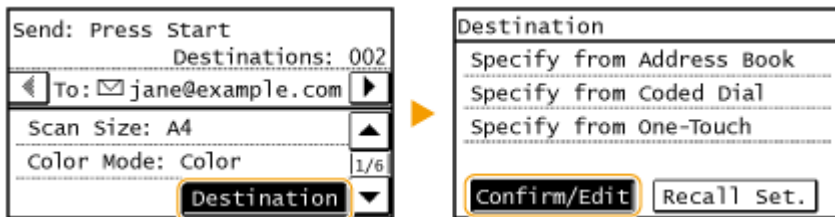

- 2 Select a destination you want to delete.



- 3 Tap <Remove>.

- If you select Group Dial in step 2, <Number of Destinations> is displayed. Tapping this item displays destinations registered in the group.



- 4 Tap <Yes>.

NOTE

If you want to easily and quickly delete destinations without displaying a list of destinations

- Before tapping <Destination> in step 1, you can tap ◀ / ▶ to toggle the destinations you specified. Display a destination you want to delete, and press .

LINKS

- ▶ [Sending Documents as E-Mails Directly from the Machine\(P. 246\)](#)
- ▶ [Saving Documents Directly in Shared Folder\(P. 253\)](#)

Specifying Destinations with the One-Touch Buttons

14L7-05C



Tap one-touch buttons in the <Home> Screen to specify destinations.

NOTE

You need to register destinations before using one-touch dialing.

▶ **Registering Destinations for One-Touch Dial(P. 65)**

- 1 Press and tap any one of <One-Touch 1> to <One-Touch 4>.

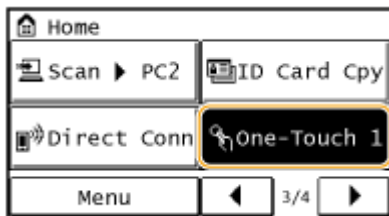

NOTE:

If a confirmation screen appears

If <One-Touch/Coded Dial TX Confirmation> is set to <On>, a confirmation screen appears with the destination and destination name registered to the one-touch button (if a destination registered for Group Dial, the group name and number of destinations appears). Confirm the destinations are correct, and tap <OK>. If destinations are incorrect, tap <Cancel> and tap the one-touch buttons again. ▶ **Checking Destinations before Sending Documents(P. 420)**



Selecting several destinations

Destinations can be added from the Address Book, coded dial numbers, One-Touch, and Recall Settings. Tap <Destination>.

- 2 Specify the scanning settings as necessary.

- Select the settings. ▶ **Specifying Detailed Settings(P. 258)**

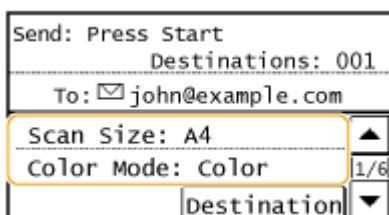

3 Press to start sending.

- Scanning starts.
- If you want to cancel sending, press  ▶ Tap <Yes>.

■ To delete destinations

If you specified multiple destinations, you can delete destinations as necessary.

- 1 Select <Destination> ▶ <Confirm/Edit>.

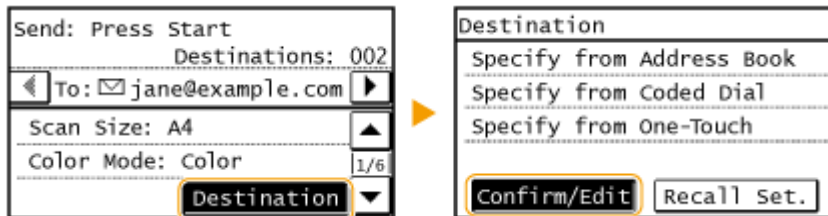

- 2 Select a destination you want to delete.

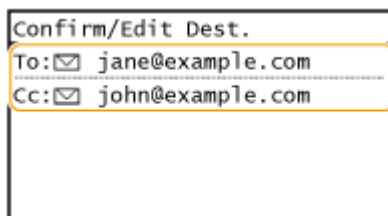

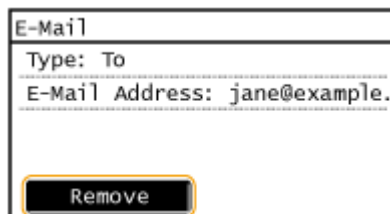

- 3 Tap <Remove> ▶ <Yes>.

- If you specified Group Dial in step 2, "destination(s)" is displayed. Tapping <Number of Destinations> displays destinations registered in the group.



NOTE

If you want to easily and quickly delete destinations without displaying a list of destinations

Before tapping <Destination> in step 1, you can tap  /  to toggle the destinations you specified. Display a destination you want to delete, and press .

LINKS

- ▶ [Sending Documents as E-Mails Directly from the Machine\(P. 246\)](#)
- ▶ [Saving Documents Directly in Shared Folder\(P. 253\)](#)

Specifying Previously Used Destinations

14L7-05E



You can select a destination from among the past three destinations. When you specify a previously used destination, the machine also sets the same scan settings such as density you used the last time you sent documents to that destination.

IMPORTANT

- When <Restrict Resending from Log> is set to <On>, you cannot use this feature. **Disabling Use of Previously Used Destinations(P. 419)**
- Turning OFF the machine or setting <Restrict New Destinations> to <On> deletes the past destinations, and disables this feature. **Limiting Available Destinations(P. 417)**

NOTE

- When you specify a destination using this feature, any destinations that you have already specified are deleted.

1 Press  and tap <Scan>.

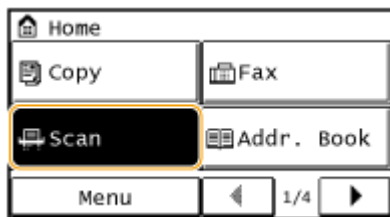

2 Tap <E-Mail> or <File>.

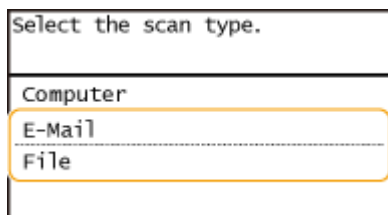

3 Select <Destination> ▶ <Recall Set.>.

■ If <E-Mail> is selected at step 2

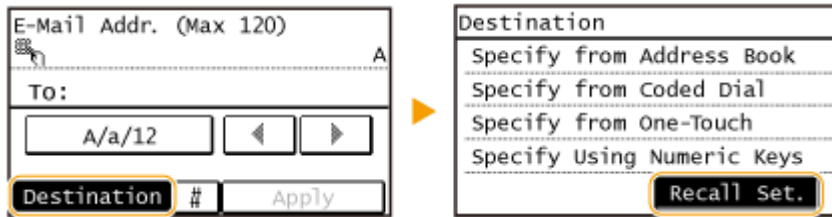

■ If <File> is selected at step 2

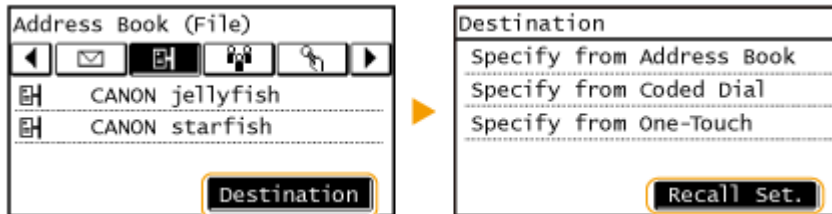

4 Select a destination.

- When you transmit to multiple destinations, only the address specified for the first transmission is displayed in the log, but all the destinations are specified.

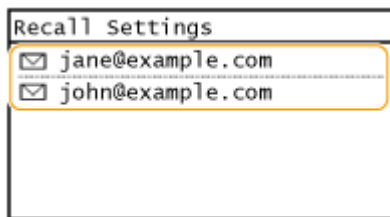

⇒ The selected destination and its scan settings are specified. You can also change the settings before sending.

■ To delete destinations (e-mail)

When you transmitted to multiple destinations, you can delete destinations as necessary.

- 1 Select <Destination> ▶ <Confirm/Edit>.

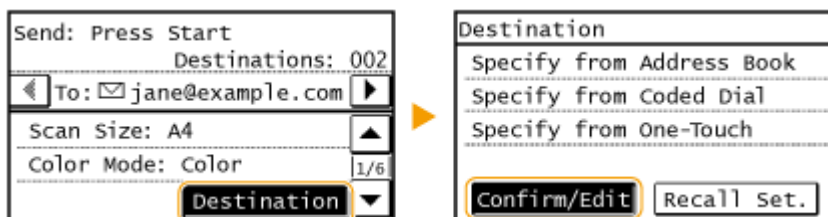

- 2 Select a destination you want to delete.

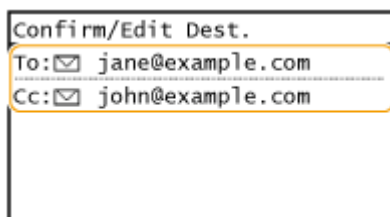

- 3 Tap <Remove>.

- If you select Group Dial in step 2, <Number of Destinations> is displayed. Tapping this item displays destinations registered in the group.



- 4 Tap <Yes>.

NOTE

If you want to easily and quickly delete destinations without displaying a list of destinations

- Before tapping <Destination> in step 1, you can tap ◀ / ▶ to toggle the destinations you specified. Display a destination you want to delete, and press .

LINKS



- ▶ [Sending Documents as E-Mails Directly from the Machine\(P. 246\)](#)
- ▶ [Saving Documents Directly in Shared Folder\(P. 253\)](#)

Changing Default Settings

14L7-05F

The default settings are the settings that are displayed whenever you turn ON the machine, or when you press . If you change these default settings to match the operations that you perform frequently, you can eliminate the need to configure the same settings every time you scan.

■ E-Mail

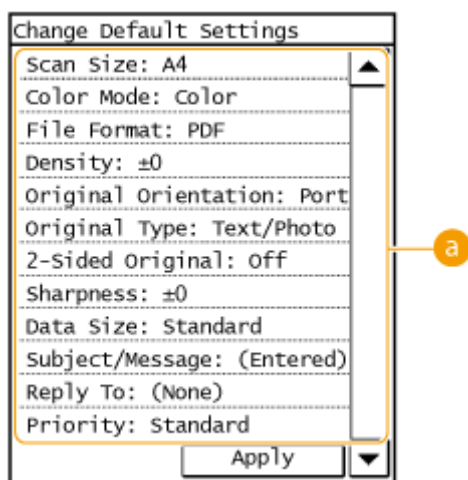

 <Menu> ▶ <Scan Settings> ▶ <E-Mail Settings> ▶ <Change Default Settings> ▶ Select the setting ▶ Change the default value of the selected item ▶ <Apply> ▶ 



a Settings

Select the item you want to set, and change the default value.

■ Shared Folder



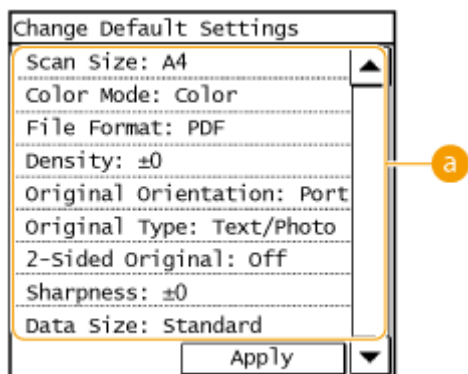

 <Menu> ▶ <Scan Settings> ▶ <File Settings> ▶ <Change Default Settings> ▶ Select the setting ▶ Change the default value of the selected item ▶ <Apply> ▶ 



Settings

Select the item you want to set, and change the default value.

LINKS

-  **Sending Documents as E-Mails Directly from the Machine(P. 246)**
-  **Saving Documents Directly in Shared Folder(P. 253)**
-  **Specifying Detailed Settings(P. 258)**
-  **Scan Settings(P. 507)**

Checking Status and Log for Sent Documents (E-Mail/ Shared Folder)

14L7-05H

You can check the status and log for scanned documents sent directly from the machine.

IMPORTANT

- When <Display Job Log> is set to <Off>, you cannot check the logs for sent documents. ▶ **Display Job Log (P. 532)**

1 Press .

2 Tap <TX Job>.

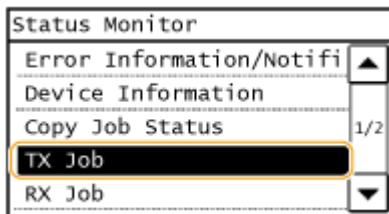

3 Check the statuses and logs for sent documents.

■ To check the statuses for sent documents

1 Tap <Job Status>.



2 Select the document whose status you want to check.

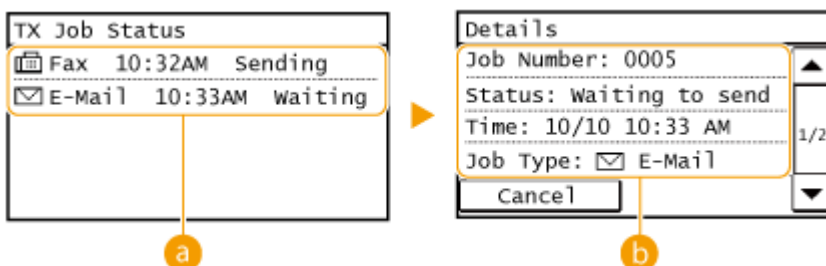

a <TX Job Status>

Displays a list of the documents that are being sent or are waiting to be processed.

b <Details>

Displays detailed information about the document selected from the list. If you specified multiple destinations, the number of specified destinations is displayed on the screen. To check the details of specified multiple destinations, tap <Destination>.

■ To check the logs for sent documents

1 Tap <Job Log>.

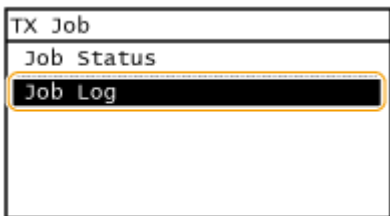

2 Select the document whose log you want to check.

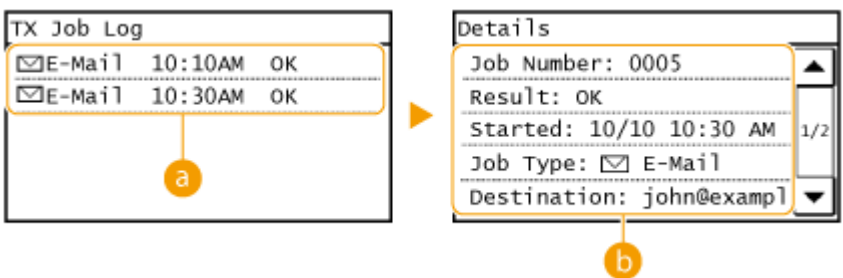

a <TX Job Log>

Displays a list of the documents that were sent. <OK> is displayed when a document was sent successfully, and <Error> is displayed when a document failed to be sent because it was canceled or there was some error.

b <Details>

Displays detailed information about the document selected from the list.

NOTE:

When a three-digit number is shown in the case of <Error>

- This number represents an error code. **▶ When an Error Code Appears(P. 558)**

LINKS

- ▶ **Sending Documents as E-Mails Directly from the Machine(P. 246)**
- ▶ **Saving Documents Directly in Shared Folder(P. 253)**
- ▶ **Canceling Sending Documents (E-Mail/Shared Folder)(P. 256)**
- ▶ **TX Result Report(P. 608)**
- ▶ **Communication Management Report(P. 611)**

Can Be Used Conveniently with a Mobile Device (MF249dw / MF246dn / MF237w)

Can Be Used Conveniently with a Mobile Device (MF249dw / MF246dn / MF237w)	289
Connecting to a Mobile Device	290
Make Direct Connection (Access Point Mode) (MF249dw / MF237w)	291
Making the Best Use of the Machine by Utilizing Applications	294
Using AirPrint	295
Printing with AirPrint	300
Scanning with AirPrint	303
Faxing with AirPrint	305
If AirPrint Cannot Be Used	307
Using Google Cloud Print	308
Managing the Machine Remotely	312

Can Be Used Conveniently with a Mobile Device

MF249dw / MF246dn / MF237w

14L7-05J

Combining the machine with a mobile device such as a smartphone or tablet enables you to use an appropriate application to perform printing, scan, or other operation with ease. You can also use a mobile device to operate the machine remotely, check the printing status, and change machine's settings.



- ▶ **Connecting to a Mobile Device**(P. 290)
- ▶ **Making the Best Use of the Machine by Utilizing Applications**(P. 294)
- ▶ **Managing the Machine Remotely**(P. 312)

Connecting to a Mobile Device

14L7-05K

When connecting the machine to a mobile device, you can select whether to connect via a wireless LAN router or Direct Connection. Select the connection method that best suits your environment and devices.

■ Connecting via a Wireless LAN Router

Like when connecting a computer and the machine, connect a mobile device and the machine via a wireless LAN router. For how to connect your mobile device and wireless LAN, see the instruction manual for the device or contact your manufacturer.

Connect the machine to the router with a wired LAN or wireless LAN. **▶Connecting to a Network(P. 315)**



■ Making Direct Connection **MF249dw / MF237w**

Connect the mobile device and the machine directly without using a wireless LAN router. Even where no wireless LAN environment is available, you can quickly connect the machine and a mobile device. You can also configure the machine to exit Direct Connection mode automatically once a certain period of time elapses after the machine enters Direct Connection mode and switch to a wireless LAN connection. **▶Make Direct Connection (Access Point Mode) (MF249dw / MF237w)(P. 291)**



Make Direct Connection (Access Point Mode)

MF249dw / MF237w

14L7-05L

Even in an environment without wireless LAN router, you can connect your mobile device and the machine without going through difficult settings when you use "Access Point Mode," which allows you to wirelessly and directly connect your mobile device to the machine.



Using the Machine in Direct Connection (in Access Point Mode)

Follow these steps to establish a connection using Access Point Mode.



Put the machine into Access Point Mode.

- Set <Use Direct Connection> to <On>.
- ▶ **Use Direct Connection(P. 475)**

■ If connected to the network by wireless LAN

A screen for selecting the Direct Connection method is displayed.

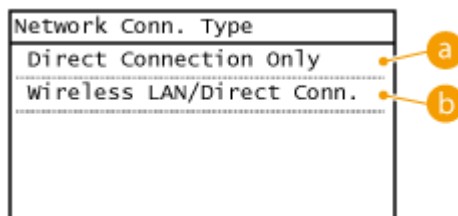

a <Direct Connection Only>

Connection by wireless LAN becomes unavailable. Set when only using Direct Connection.

b <Wireless LAN/Direct Conn. (Auto Switch)>

A wireless LAN connection is disconnected only when using Direct Connection. Set when wishing to switch between Direct Connection and connection by wireless LAN.



Put the machine into a connection waiting state.

- In the <Home> screen, tap <Direct Conn>. The machine enters the state in which you can connect your mobile device to the machine.

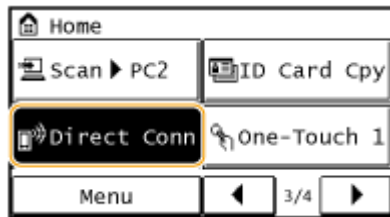

Connecting from a mobile device

- Based on the SSID and network key displayed in the display, make wireless LAN connection settings for connecting to the machine.

NOTE:

- The screen below appears in the display during the connection process.

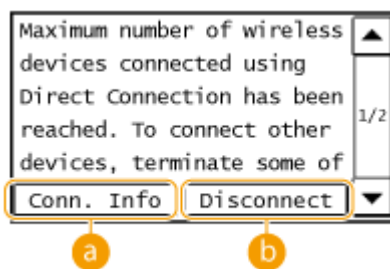

a <Conn. Info>

You can view the information on the Direct Connection being proceeding.

b <Disconnect>

Stops the Direct Connection procedure. When printing, scanning, or other desired operation is complete, tap this button to terminate the connection.

IMPORTANT

- When the machine is in Direct Connection mode, it is possible that you cannot connect to the Internet depending on your mobile device.
- If <Use Custom SSID> is <Off> when the machine is in Direct Connection mode, only a single device can be connected at a time.
- If wireless connection from the mobile device is not performed within 5 minutes while the SSID and network key are displayed, the connection waiting state terminates.
- If while in communication by Direct Connection, a duration when there is no data transmission between the machine and the mobile device lasts for some time, the communication may terminate.
- The machine's SSID and network key are changed each time the Direct Connection procedure is started.
- While in Direct Connection, sleep mode is not as effective at saving power.
- If you use the Direct Connection, do not set the IP address manually on the mobile device. Doing so may prevent proper communication after using the Direct Connection.

TIPS

Setting an arbitrary SSID and network key

- You can enter and set the SSID and network key used for Direct Connection yourself. Setting any SSID allows up to 5 devices to connect to the machine at the same time. ▶ **Access Point Mode Settings (P. 475)**

Exiting from Direct Connection mode automatically

- You can also configure the machine to exit Direct Connection mode automatically once a certain period of time elapses after the machine enters Direct Connection mode. If <Wireless LAN/Direct Conn. (Auto Switch)> is specified as the connection method in Direct Connection mode, the machine connects to a wireless LAN automatically after exiting Direct Connection mode.
 - ▶ **Selecting Wired LAN or Wireless LAN (MF249dw / MF237w)(P. 317)**
 - ▶ **Time Until Direct Connection Termination (P. 475)**

Making the Best Use of the Machine by Utilizing Applications

14L7-05R

You can use an appropriate application that enables you to perform printing, scanning, or other operation by operating the machine from your mobile device. The machine supports a dedicated application from Canon and various other applications. You can select the most appropriate application to your mobile device, the purpose, the situation, and so on.

■ Printing/Scanning via Canon PRINT Business

You can print from mobile devices that support iOS/Android, and place and scan originals with the machine, then send to a mobile device. When printing, it is not necessary to perform operations on the machine. For more information on supported operating systems, detailed setting methods, and operations, see the Canon website (<http://www.canon.com/>).

■ Printing with Canon Print Service

You can easily print from the menu of applications that support the Android print subsystem. For more information on supported operating systems and detailed settings and procedures, see the Canon website (<http://www.canon.com/>).

■ Using Google Cloud Print

You can print from an application or service that supports Google Cloud Print. You can print by remotely operating the machine at any time and from anywhere, for example even while you are on the go. **☞ Using Google Cloud Print(P. 308)**



■ Printing with Mopria®

This machine also supports Mopria®. Using Mopria® allows you to print with printers of different models from different manufacturers by using common operations and common settings. For example, assume that Mopria® compatible printers of different models from different manufacturers are installed in your office, at your place, or at places you are visiting. You can then print with any of those printers by using Mopria® without the need to install the respective dedicated applications on them. For details about the models supporting Mopria® and the system requirements, see <http://www.mopria.org>.



Using AirPrint

You can print, scan, or fax without using drivers by sending print data from Apple devices.



AirPrint settings

- ▶ **Configuring AirPrint Settings(P. 295)**
- ▶ **Displaying the Screen for AirPrint(P. 298)**

Functions of the AirPrint

- ▶ **Printing with AirPrint(P. 300)**
- ▶ **Scanning with AirPrint(P. 303)**
- ▶ **Faxing with AirPrint(P. 305)**

Troubleshooting

- ▶ **If AirPrint Cannot Be Used(P. 307)**

Configuring AirPrint Settings

You can register information, including the name of the machine and installation location, that is used for identifying the machine. You can also disable the AirPrint function of the machine. Use the Remote UI to change these settings.

- 1 Start the Remote UI and log on in System Manager Mode. ▶ Starting Remote UI(P. 450)**
- 2 Click [Settings/Registration].**

- If you are using a mobile device, such as iPad, iPhone, or iPod touch, read "click" as "tap" in this section.

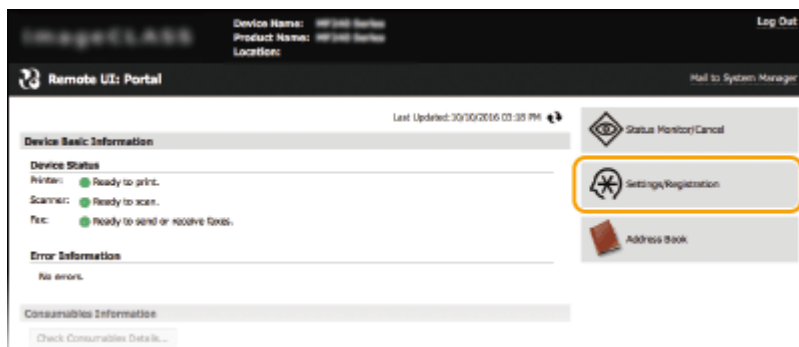

- 3 Click [Network Settings] ▶ [AirPrint Settings].**

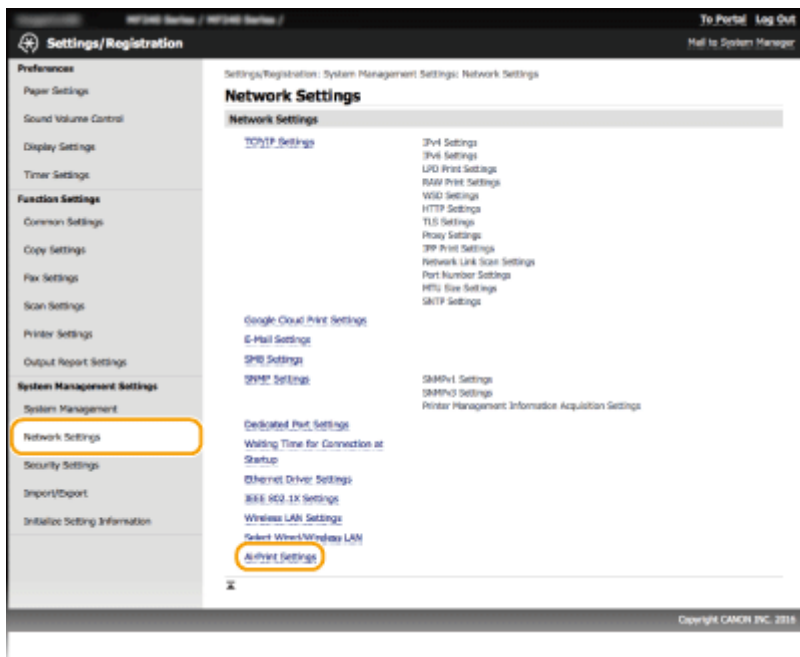

4 Click [Edit].

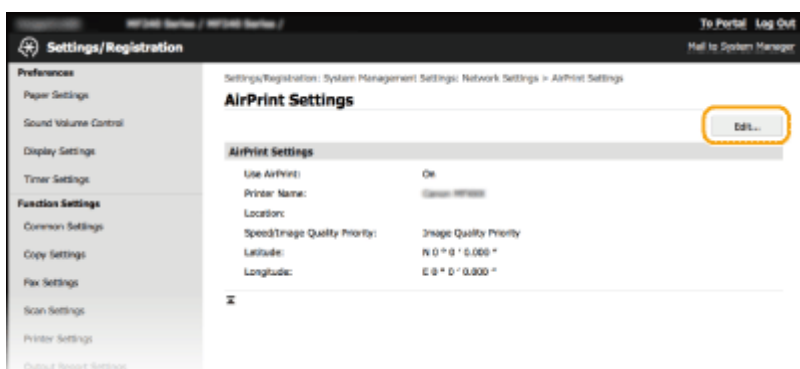

5 Specify the required settings, and click [OK].

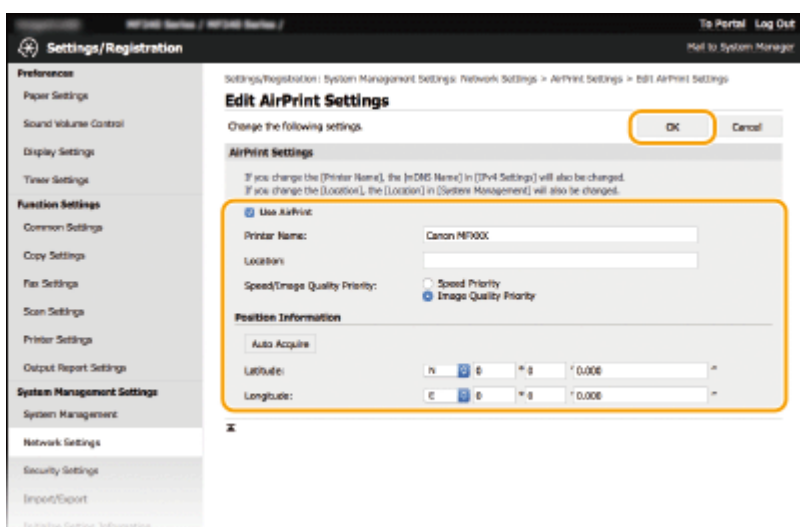

[Use AirPrint]

Select the check box to enable AirPrint. To disable AirPrint, clear the check box.

[Printer Name]/[Location]/[Speed/Image Quality Priority]/[Latitude]/[Longitude]

Enter the name and the installation location information to help you identify this machine when operating your Apple device. This information is useful if you have more than one AirPrint printer. Also select whether to give priority to print speed or to print quality.

NOTE:**If you select the [Use AirPrint] check box**

The following items are also set to <On> automatically.

- <mDNS Settings> for IPv4 and IPv6 (▶ **Configuring DNS(P. 377)**)
- <Use HTTP> (▶ **Disabling HTTP Communication (MF249dw / MF246dn / MF237w)(P. 423)**)
- [Use IPP Printing] under [IPP Print Settings] (▶ **Changing the Setting of Functions Available with AirPrint(P. 297)**)
- <Use Network Link Scan> (▶ **Changing the Setting of Functions Available with AirPrint(P. 297)**)

If you change [Printer Name]

- If you change [Printer Name] that you have once specified, you may be unable to print any more from the Mac that has been able to be used for printing so far. This phenomenon occurs because <mDNS Name> (▶ **Configuring DNS(P. 377)**) of IPv4 is also changed automatically. In this case, add the machine to the Mac again.

■ Changing the Setting of Functions Available with AirPrint

If you want to disable functions that you are not going to use with AirPrint or encrypt communications, configure the necessary setting using the operation panel or Remote UI.

Changing Print and Fax Settings

To perform printing or fax sending with AirPrint, IPP protocol is used.

Turning the function On/Off

You can specify whether to perform printing and fax sending with AirPrint. The factory default setting is [On].



Log on to the Remote UI in System Manager Mode (▶ **Starting Remote UI(P. 450)**) ▶ [Settings/Registration] ▶ [Network Settings] ▶ [TCP/IP Settings] ▶ [IPP Print Settings] ▶ [Edit] ▶ Clear or select the [Use IPP Printing] check box ▶ [OK]

Changing the TLS setting

You can specify whether to encrypt communications using TLS when performing printing or sending faxes with AirPrint. The factory default setting is [On].

NOTE:

- When the machine is connected to a Mac via USB, set [Use TLS] to [Off].



Log on to the Remote UI in System Manager Mode (▶ **Starting Remote UI(P. 450)**) ▶ [Settings/Registration] ▶ [Network Settings] ▶ [TCP/IP Settings] ▶ [IPP Print Settings] ▶ [Edit] ▶ Clear or select the [Use TLS] check box ▶ [OK]

Changing Scan Settings

To perform scanning with AirPrint, Network Link Scan is used.

Turning the function On/Off

You can turn on/off the scan function available with AirPrint. The factory default setting is <On>.

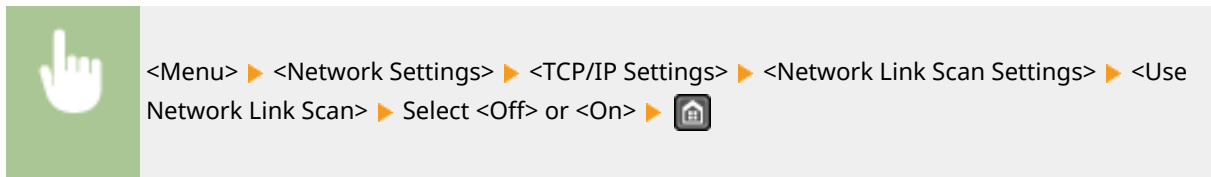

Changing the TLS setting

You can specify whether to encrypt communications using TLS when performing scanning with AirPrint. The factory default setting is [On].

NOTE:

- When the machine is connected to a Mac via USB, set [Use TLS] to [Off].

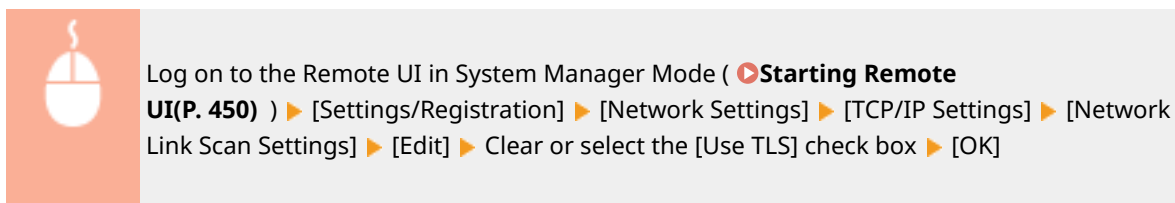

Displaying the Screen for AirPrint

You can display the screen for AirPrint, on which you can not only access the AirPrint Settings but also view information about consumables, such as paper and toner cartridge. Further, you can configure security function settings (▶ **Enabling TLS Encrypted Communication for the Remote UI(P. 426)**).

- 1** Click [System Preferences] in the Dock on the desktop ▶ [Printers & Scanners].
- 2** Select this machine and click [Options & Supplies].
- 3** Click [Show Printer Webpage].
- 4** Log on to the Remote UI.

- To change AirPrint settings, log on in System Manager Mode.

⇒ The screen for AirPrint is displayed.

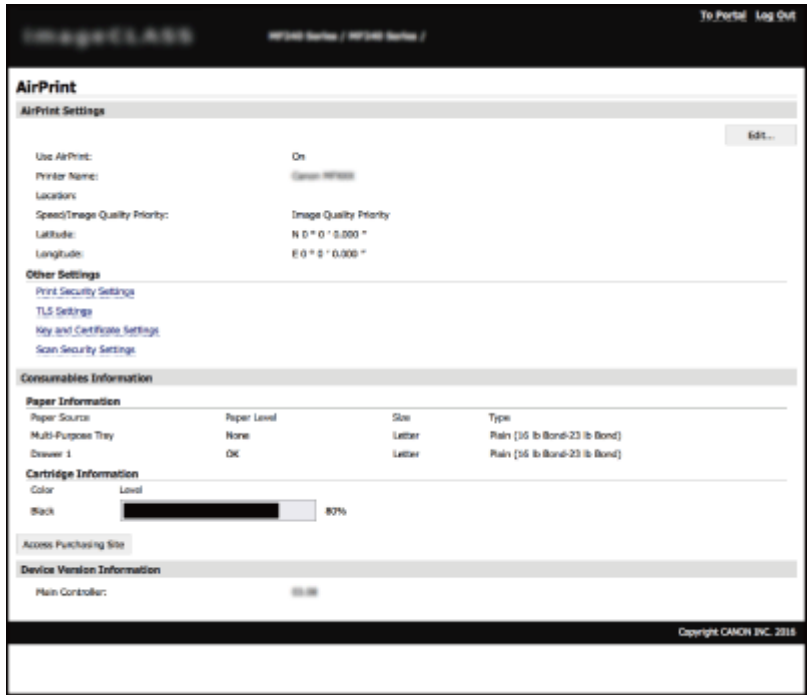

Trademarks

Apple, Bonjour, iPad, iPhone, iPod touch, Mac, Mac OS, OS X, and Safari are trademarks of Apple Inc., registered in the U.S. and other countries. AirPrint and the AirPrint logo are trademarks of Apple Inc.

Printing with AirPrint

You do not necessarily need to use a computer for printing e-mails, photos, Web pages, and other documents. AirPrint enables you to print directly from Apple devices such as iPad, iPhone, and iPod touch.



- ▶ **Printing from iPad, iPhone, or iPod touch(P. 300)**
- ▶ **Printing from Mac(P. 301)**

System Requirements

To print with AirPrint, you need one of the following Apple devices.

- iPad (all models)
- iPhone (3GS or later)
- iPod touch (3rd generation or later)
- Mac (Mac OS X 10.7 or later)*

* OS X 10.9 or later when you use USB connection.

Network Environment

You need one of the following environments.

- The Apple device and the machine are connected to the same LAN.
- The Apple device and the machine are in Direct Connection.
- The Mac and the machine are connected via USB.

IMPORTANT

- For printing, it is required to set [Use IPP Printing] to [On]. ▶ **Changing the Setting of Functions Available with AirPrint(P. 297)**

Printing from iPad, iPhone, or iPod touch

1 Make sure that the machine is turned ON and that it is connected to your Apple device.

- For how to make sure of this, see "Getting Started." ▶ **Manuals Included with the Machine(P. 656)**
- For how to make sure whether the Apple device and the machine are in Direct Connection, see ▶ **Make Direct Connection (Access Point Mode) (MF249dw / MF237w)(P. 291)** .

2 From the application on your Apple device, tap  to display the menu options.

3 From the drop-down list, tap [Print].

4 Select this machine from [Printer] in [Printer Options].

- The printers connected to the network are displayed. Select this machine in this step.

IMPORTANT:

- [Printer Options] is not displayed on applications that do not support AirPrint. You cannot print by using those applications.

5 Specify the print settings as necessary.

NOTE:

- The available settings and paper sizes differ depending on the application you are using.
- You can specify the halftones setting for image files using the operation panel.  **Mobile Print Halftones(P. 513)**

6 Tap [Print].

▢▢▢▢ Printing starts.

NOTE:

Checking the print status

- During printing, press the Home button of the Apple device twice  tap [Print].

Printing from Mac

1 Make sure that the machine is turned ON and that it is connected to your Mac.

- For how to make sure of this, see "Getting Started."  **Manuals Included with the Machine(P. 656)**

2 Add the machine to the Mac from [System Preferences]  [Printers & Scanners].

- This operation is not necessary if the registration has already been performed for another operation.

3 Open a document in an application and display the print dialog box.

- How to display the print dialog box differs for each application. For more information, see the instruction manual for the application you are using.

4 Select this machine in the print dialog box.

- The printers connected to the Mac are displayed. Select this machine in this step.

5 Specify the print settings as necessary.

NOTE:

- The available settings and paper sizes differ depending on the application you are using.
- You can specify the halftones setting for image files using the operation panel. **▶ Mobile Print Halftones(P. 513)**

6 Click [Print].

▶▶▶ Printing starts.

Scanning with AirPrint

14L7-05W

You can use AirPrint to transfer the data scanned by the machine directly to a Mac.



System Requirements

To scan with AirPrint, you need a Mac with OS X 10.9 or later installed.

Network Environment

You need one of the following environments.

- The Mac and the machine are connected to the same LAN.
- The Mac and the machine are connected via USB.

IMPORTANT

- For scanning, it is required to set <Use Network Link Scan> to <On>. **▶ Changing the Setting of Functions Available with AirPrint(P. 297)**
- Before scanning, it is required to put the machine into online state. When the auto online function (**▶ Auto Online for Remote Scan(P. 531)**) is set to <Off>, first put the machine into online state by tapping <Scan> ▶ <Remote Scanner>, then start the procedure for scanning.
- You cannot scan while settings for operations are being made, or while the machine is performing an operation whatsoever.

Scanning from the Mac

- 1 Make sure that the machine is turned ON and that it is connected to the Mac.**
 - For how to make sure of this, see "Getting Started." **▶ Manuals Included with the Machine(P. 656)**
- 2 Add the machine to your Mac from [System Preferences] ▶ [Printers & Scanners].**
 - This operation is not necessary if the registration has already been performed for another operation.
- 3 Select this machine from the list of printers in [Printers & Scanners].**
- 4 Click [Scan].**

5 Click [Open Scanner].

⇒ The [Scanner] screen is displayed.

6 Configure the scan settings as necessary.

7 Click [Scan].

⇒ Scanning starts, and scanned data is displayed.

Faxing with AirPrint

14L7-05X

AirPrint enables you to send faxes from a Mac in almost the same way as when you print from a Mac.



System Requirements

To send faxes with AirPrint, you need a Mac with OS X 10.9 or later installed.

Network Environment

You need one of the following environments.

- The Mac and the machine are connected to the same LAN.
- The Mac and the machine are connected via USB.

IMPORTANT

- For faxing, it is required to set [Use IPP Printing] to [On]. **▶ Changing the Setting of Functions Available with AirPrint(P. 297)**

Faxing from Mac

1 Make sure that the machine is turned ON and that it is connected to the Mac.

- For how to make sure of this, see "Getting Started." **▶ Manuals Included with the Machine(P. 656)**

2 Add the machine to your Mac from [System Preferences] ▶ [Printers & Scanners].

- This operation is not necessary if the registration has already been performed for another operation.

3 Open a document in an application and display the print dialog box.

- How to display the print dialog box differs for each application. For more information, see the instruction manual for the application you are using.

4 Select this machine in the print dialog box.

- ▶ The printers connected to the Mac are displayed. Select the fax driver of this machine in this step.

5 Specify the destination.

6 Click [Fax].

⇒ Fax sending starts.

If AirPrint Cannot Be Used

14L7-05Y

If AirPrint cannot be used, try taking the following solutions.

- Make sure that the machine is turned ON. If the machine is turned ON, first turn it OFF, then wait for at least 10 seconds and then turn it back ON to check if the problem is solved.
- Make sure that no error messages are displayed on the machine.
- Make sure that Apple devices and the machine are connected to the same LAN. If the machine is turned ON, it may take several minutes before the machine is ready for communication.
- Make sure that Bonjour on your Apple device is enabled.
- For printing, make sure that the paper is loaded in the machine and the machine has sufficient toner cartridge remaining. **▶Displaying the Screen for AirPrint(P. 298)**
- For scanning, make sure that the machine's setting for Network Link Scan is <On>. **▶Changing the Setting of Functions Available with AirPrint(P. 297)**

Using Google Cloud Print

14L7-060

Google Cloud Print is a service that enables a user who has a Google account to print from applications compatible with Google Cloud Print via a smartphone, tablet, or computer connected to the Internet. Unlike conventional printing from a computer, Google Cloud Print enables you to print without using a printer driver. For example, if you want to print an e-mail or files that are attached to an e-mail, you can print just by using an application compatible with Google Cloud Print. You will find your printouts when you go to the machine.



- ▶ **Checking the Machine Settings(P. 308)**
- ▶ **Changing Google Cloud Print Settings(P. 308)**
- ▶ **Registering the Machine with Google Cloud Print(P. 309)**

IMPORTANT

- When registering the machine or when using Google Cloud Print to print documents, you must be able to connect the machine to the Internet. You are also responsible for paying all Internet connection fees.
- You may not be able to use this function in some countries or regions.
- Google Cloud Print does not support printing from IPv6 addresses.

NOTE

- To use Google Cloud Print, a Google account is required. If you do not have one, access Google website to create your account.

Checking the Machine Settings

Before setting up Google Cloud Print, check the following:

- Make sure that the machine is assigned an IPv4 address and connected to a computer over a network.
 - ▶ **Connecting to a Wireless LAN (MF249dw / MF237w)(P. 319)**
 - ▶ **Connecting to a Wired LAN(P. 318)**
- Make sure that the date and time and the time zone settings are correct. ▶ **Date/Time Settings(P. 488)**

Changing Google Cloud Print Settings

Enable the Google Cloud Print function of the machine. You can also disable the Google Cloud Print function of the machine.

- 1 Tap <Menu> in the <Home> screen.**
- 2 Tap <System Management Settings>.**

- If a screen appears prompting you to enter a PIN, enter the correct PIN using the numeric keys, and tap <Apply>. ▶ **Setting the System Manager PIN(P. 397)**

3 Select <Google Cloud Print Settings> ▶ <Enable Google Cloud Print>.

4 Tap <On> or <Off>.

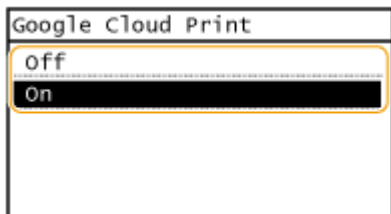

Registering the Machine with Google Cloud Print

Registering the machine with Google Cloud Print allows you to print from anywhere.

1 Start the Remote UI and log on in System Manager Mode. ▶ **Starting Remote UI(P. 450)**

2 Click [Settings/Registration].

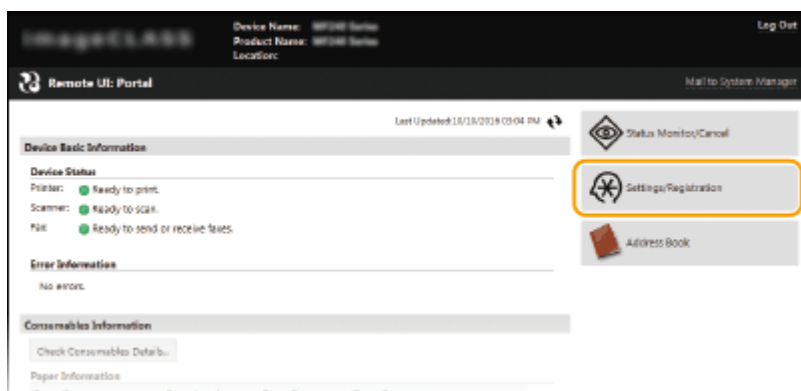

3 Click [Network Settings] ▶ [Google Cloud Print Settings].

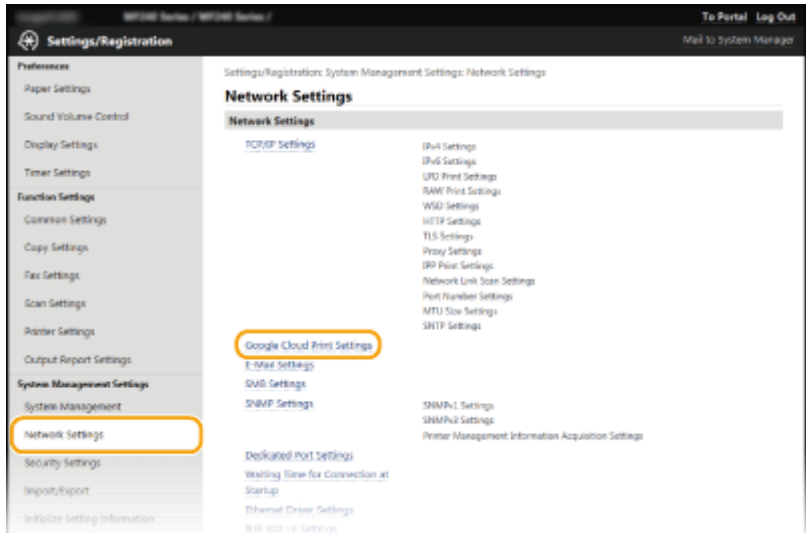

4 Click [Register] in [Registration Status].

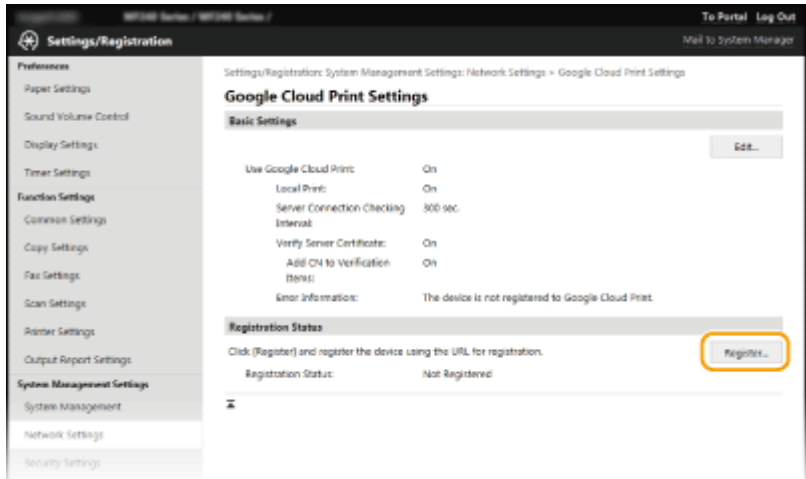

NOTE:

If [Register] is unavailable

- You need to enable Google Cloud Print. Click [Edit], select the [Use Google Cloud Print] check box, and then click [OK].

To reregister the machine

- To reregister the machine if the owner of the machine has changed or for other reasons, unregister the machine and register it again.

5 Click the link of the URL displayed for [URL for Registration].

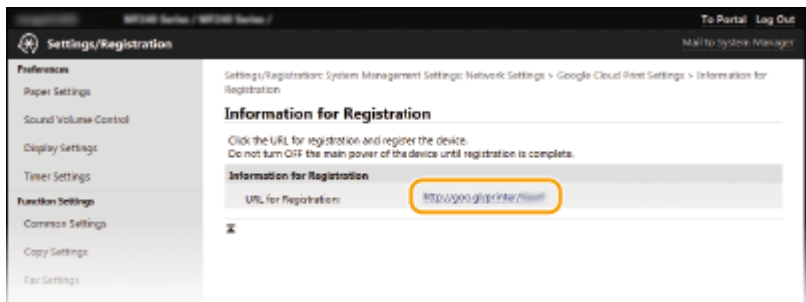

6 Follow the on-screen instructions to register the machine.

⇒ You can print from a Google Cloud Print compatible application such as Google Chrome™.

NOTE:

- Access the Google Cloud Print website for information about the latest applications that support Google Cloud Print.

NOTE

Registering from a mobile device or Google Chrome

- You can also register the machine from a mobile device or Google Chrome*. The machine's display shows the following confirmation screen before completion of the registration. Tap <Yes> to complete the registration.

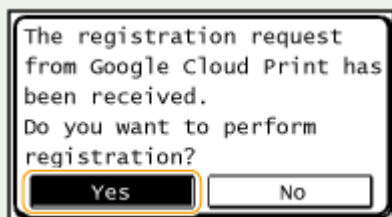

* For the registration procedure, see the instruction manual for your mobile device or the Google Cloud Print website.

Managing the Machine Remotely

14L7-061

You can use the Remote UI from a Web browser installed on your mobile device. This allows you to check the machine's status and specify machine's settings from your mobile device. Note that the Remote UI screen may not be displayed properly for some devices and environments.



Starting Remote UI with a Mobile Device

Enter the IP address of the machine into the Web browser and start the Remote UI. Check the IP address set to the machine in advance ([▶Viewing Network Settings\(P. 344\)](#)). If you have any questions, ask your Network Administrator.

1 Start the Web browser on your mobile device.

2 Enter "http://<the IP address of the machine>/" in the address field.

- If you want to use an IPv6 address, enclose the IPv6 address with brackets (example: http://[fe80::2e9e:fcff:fe4e:dbce]/).

NOTE:

- Some items of the Remote UI are not displayed in its "Smartphone Version." If you want to check all items, see the "PC Version."

LINKS

[▶Using Remote UI \(MF249dw / MF246dn / MF237w\)\(P. 449\)](#)

Network (MF249dw / MF246dn / MF237w)

Network (MF249dw / MF246dn / MF237w)	314
Connecting to a Network	315
Selecting Wired LAN or Wireless LAN (MF249dw / MF237w)	317
Connecting to a Wired LAN	318
Connecting to a Wireless LAN (MF249dw / MF237w)	319
Setting Up Connection Using WPS Push Button Mode	321
Setting Up Connection Using WPS PIN Code Mode	323
Setting Up Connection by Selecting a Wireless Router	326
Setting Up Connection by Specifying Detailed Settings	329
Checking the SSID and Network Key	333
Setting IP Addresses	336
Setting IPv4 Address	337
Setting IPv6 Addresses	340
Viewing Network Settings	344
Configuring the Machine for Printing or Faxing from a Computer	347
Configuring Printing Protocols and WSD Functions	348
Configuring Printer Ports	351
Setting Up Print Server	354
Configuring Scan Settings (E-Mail/Shared Folders) (MF249dw / MF246dn)	357
Configuring Scan Settings (Sending E-Mail)	358
Configuring Basic E-Mail Settings	359
Configuring E-Mail Communication Settings	363
Configuring the Machine for Scanning to Shared Folders	367
Setting a Shared Folder as a Save Location	368
Configuring the Machine for Your Network Environment	372
Configuring Ethernet Settings	373
Changing the Maximum Transmission Unit	375
Setting a Wait Time for Connecting to a Network	376
Configuring DNS	377
Configuring SMB (MF249dw / MF246dn)	382
Configuring SNMP	384
Monitoring and Controlling the Machine with SNMP	386

Network MF249dw / MF246dn / MF237w

14L7-062

The machine has been designed for flexibility of use across a variety of environments, and it includes advanced technologies in addition to basic network features. Do not worry if you are not a network expert, because the machine has also been designed for convenience and ease of use. Relax and proceed with the network setup one step at a time.

■ Connecting to a Computer/Viewing the Machine's Network Settings

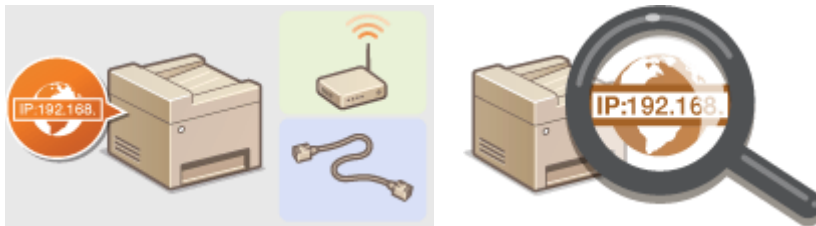

- ▶ **Connecting to a Network(P. 315)**
- ▶ **Viewing Network Settings(P. 344)**

■ Configuring or Preparing for Print/PC Fax/Scan Functions



- ▶ **Configuring the Machine for Printing or Faxing from a Computer(P. 347)**
- ▶ **Configuring Scan Settings (E-Mail/Shared Folders) (MF249dw / MF246dn)(P. 357)**

■ Customizing the Machine for More Convenient Network Experience

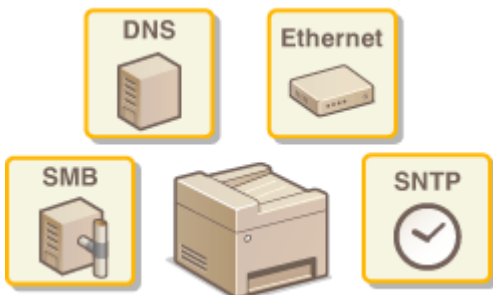

- ▶ **Configuring the Machine for Your Network Environment(P. 372)**

Direct Connection to a mobile device (MF249dw / MF237w)

- You can directly communicate with the machine from your mobile device without the need to configure difficult network settings. ▶ **Make Direct Connection (Access Point Mode) (MF249dw / MF237w)(P. 291)**

Connecting to a Network

14L7-063

When connecting the machine to a wired or wireless local area network (LAN), you need to set an IP address unique to the selected network. Select "wired" or "wireless" depending on your communication environment and networking devices. For steps to connect the machine and set an IP address, see "Getting Started" (**Manuals Included with the Machine(P. 656)**). For specific IP address settings, contact your Internet service provider or Network Administrator.

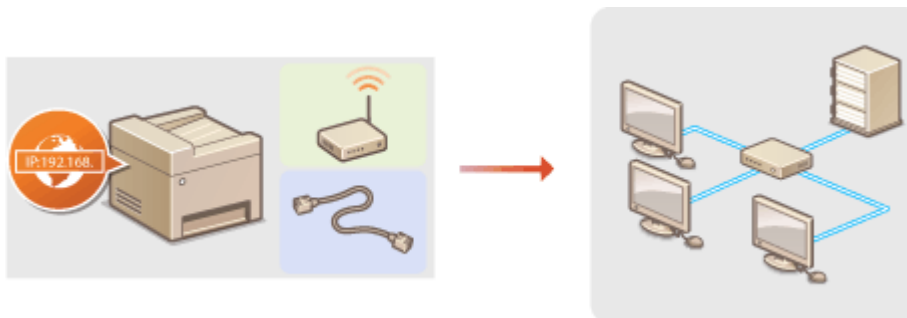

IMPORTANT

If the machine is connected to an unsecured network, your personal information might be leaked to a third party.

NOTE

- The machine cannot connect to both wired and wireless LANs at the same time.
- The machine does not come with a LAN cable or router. Have them ready as necessary.
- For more information about your networking devices, see the instruction manuals for the devices or contact your manufacturer.

■ Before You Start

Follow these steps to connect the machine to a network.



Check your computer settings.

- Make sure that the computer is correctly connected to the network. For more information, see the instruction manuals for the devices you are using, or contact the device manufacturers.
- Make sure that the network settings have been completed on the computer. If the network has not been set up properly, you will not be able to use the machine on the network, even if you perform the rest of the procedure below.

NOTE:

- Depending on the network, you may need to change settings for the communication method (half-duplex/full-duplex) or the Ethernet type (10BASE-T/100BASE-TX) (**Configuring Ethernet Settings(P. 373)**). For more information, contact your Internet service provider or Network Administrator.
- To check the MAC address of the machine.
 - ▶ **Viewing the MAC Address for Wired LAN(P. 345)**
 - ▶ **Viewing the MAC Address and Information for Wireless LAN(P. 345)**

- To connect to an IEEE 802.1X network, see **▶Configuring IEEE 802.1X Authentication(P. 429)** .



2



Select wired or wireless LAN.

- ▶**Selecting Wired LAN or Wireless LAN (MF249dw / MF237w)(P. 317)**



3



Connect to a wired or wireless LAN.

- Proceed to the section that corresponds to the setting you selected in step 2.
- ▶**Connecting to a Wired LAN(P. 318)**
- ▶**Connecting to a Wireless LAN (MF249dw / MF237w)(P. 319)**



4



Set the IP address as necessary.

- This step is required when you want to assign a specific IP address to the machine or change the dynamic IP addressing protocol from the default DHCP.
- ▶**Setting IP Addresses(P. 336)**

Selecting Wired LAN or Wireless LAN MF249dw / MF237w

14L7-064

After you decide on wired or wireless LAN to connect the machine to the computer, select wired LAN or wireless LAN using the operation panel. For how to connect to and specify settings for a wireless LAN/wired LAN, see "Getting Started" ([Manuals Included with the Machine\(P. 656\)](#)). Note that if you change the setting from <Wired LAN> to <Wireless LAN> or vice versa, you will need to uninstall MF Drivers installed on your computer and then reinstall them. For more information, see "MF Driver Installation Guide."

1 Tap <Menu> in the <Home> Screen.

2 Tap <Network Settings>.

- If a screen for entering a PIN is displayed, enter the PIN with the numeric keys and tap <Apply>. [Setting the System Manager PIN\(P. 397\)](#)

3 Tap <Select Wired/Wireless LAN>.

4 Tap <Wired LAN> or <Wireless LAN>.



LINKS

- [Connecting to a Network\(P. 315\)](#)
- [Connecting to a Wired LAN\(P. 318\)](#)
- [Connecting to a Wireless LAN \(MF249dw / MF237w\)\(P. 319\)](#)

Connecting to a Wired LAN

Connect the machine to a computer via a router. Use a LAN cable to connect the machine to the router.

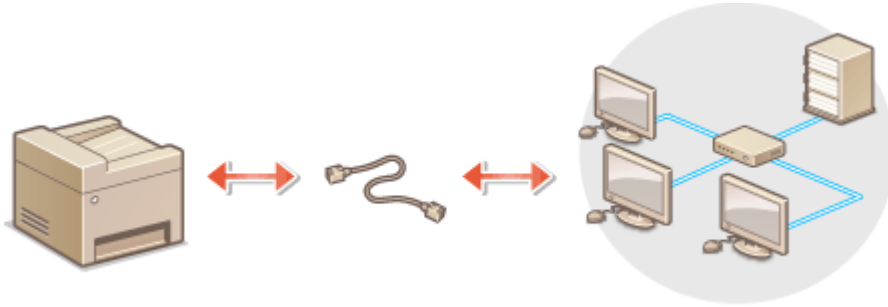

1 Connect a LAN cable.

- Connect the machine to a router by using a LAN cable.
- Push the connector in until it clicks into place.

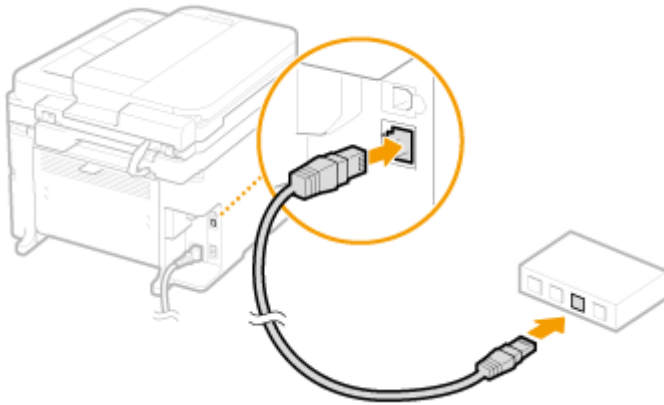

2 Wait approximately 2 minutes.

- While you wait, the IP address is set automatically.

NOTE:

You can set the IP address manually. [Setting IP Addresses\(P. 336\)](#)

LINKS

[Connecting to a Network\(P. 315\)](#)

Connecting to a Wireless LAN MF249dw / MF237w

14L7-066

Wireless routers (or access points) connect the machine to a computer via radio waves. If your wireless router is equipped with Wi-Fi Protected Setup (WPS), configuring your network is automatic and easy. If your networking devices do not support automatic configuration, or if you want to specify authentication and encryption settings in detail, you need to manually set up the connection. Make sure that your computer is correctly connected to the network.

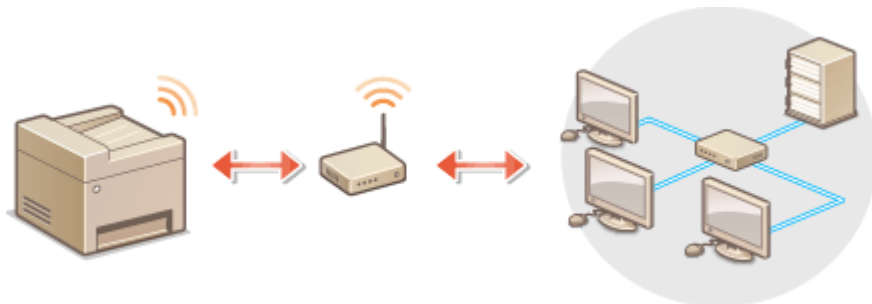

▶ **Setting Up Connection Using WPS(P. 319)**

▶ **Manually Setting Up Connection(P. 320)**

IMPORTANT

Risk of information leak

Use wireless LAN connection at your own discretion and at your own risk. If the machine is connected to an unsecured network, your personal information might be leaked to a third party because radio waves used in wireless communication can go anywhere nearby, even beyond walls.

Wireless LAN security

The wireless LAN security that is supported by the machine is listed below. For the wireless security compatibility of your wireless router, see the instruction manuals for your networking devices or contact your manufacturer.

- 128 (104)/64 (40) bit WEP
- WPA-PSK (TKIP/AES-CCMP)
- WPA2-PSK (TKIP/AES-CCMP)

NOTE

Required devices for wireless LAN connection

- The machine does not come with a wireless router. Have the router ready as necessary.
- The wireless router must conform to IEEE 802.11b/g/n and be able to communicate in 2.4 GHz frequency band. For more information, see the instruction manuals for your networking devices or contact your manufacturer.

Setting Up Connection Using WPS

When using WPS, two modes are available: push button mode and PIN code mode.

■ Push Button Mode

Find the WPS mark shown below on the package of your wireless router. Also make sure that there is a WPS button on your networking device. [▶Setting Up Connection Using WPS Push Button Mode\(P. 321\)](#)



■ PIN Code Mode

Some WPS routers do not support the push button mode. If WPS PIN code mode is mentioned on the package or in the instruction manuals of your networking device, set up the connection by entering the PIN code. [▶Setting Up Connection Using WPS PIN Code Mode\(P. 323\)](#)

NOTE

If the wireless router is set to use WEP authentication, you may not be able to set up connection using WPS.

Manually Setting Up Connection

When manually setting up a wireless connection, you can either select a wireless router or manually enter the required information. Regardless of the method, make sure that you have the required setup information, including the SSID and network key ([▶Checking the SSID and Network Key\(P. 333\)](#)).

■ Selecting a Wireless Router

Select this setup option if you need to manually set up the connection but want to complete the setup as easily as possible. [▶Setting Up Connection by Selecting a Wireless Router\(P. 326\)](#)

■ Manually Entering the Setup Information

If you want to specify security settings in detail, such as authentication and encryption settings, manually enter the SSID and network key to set up the connection. [▶Setting Up Connection by Specifying Detailed Settings\(P. 329\)](#)

LINKS

[▶Connecting to a Network\(P. 315\)](#)

[▶Selecting Wired LAN or Wireless LAN \(MF249dw / MF237w\)\(P. 317\)](#)

Setting Up Connection Using WPS Push Button Mode

14L7-067

If your wireless router supports WPS push button mode, you can easily set up a connection with a WPS button.

IMPORTANT

How to operate the wireless router may vary on each device. See the instruction manuals for your networking device for help.

1 Tap <Menu> in the <Home> Screen.

2 Tap <Network Settings>.

- If a screen for entering a PIN is displayed, enter the PIN with the numeric keys and tap <Apply>. **▶Setting the System Manager PIN(P. 397)**

3 Tap <Wireless LAN Settings>.

- If the <Do you want to enable the wireless LAN?> message is displayed, tap <Yes>.
- If the <Direct Connection will be disabled. Is it OK?> message is displayed, tap <Yes>.

4 Read the message that is displayed, and tap <OK>.

5 Tap <WPS Push Button Mode>.

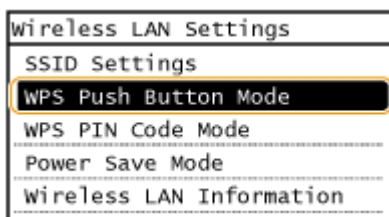

6 Tap <Yes>.

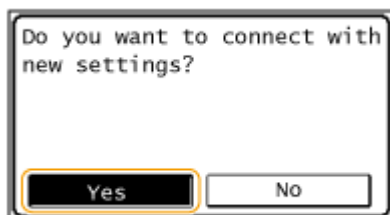

7 Press and hold the WPS button on the wireless router.

The button must be pressed within 2 minutes after tapping <Yes> in step 6.

- Depending on the networking device, you may need to press and hold the button for 2 seconds or longer. See the instruction manuals for your networking device for help.

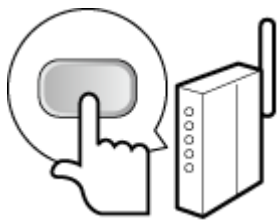

NOTE:

If an error message is displayed during setup

Tap <Close> and return to step 5.

8 Check that the Wi-Fi indicator is blinking on the operation panel.

- The Wi-Fi indicator blinks when a wireless router is detected.

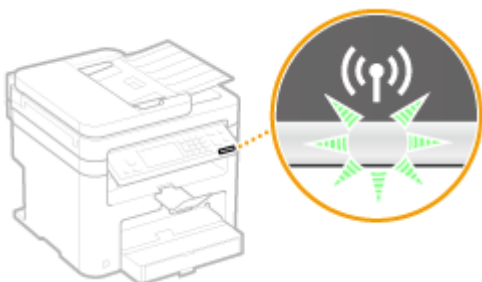

- When the setup is completed, the screen below is displayed, and approximately 2 seconds later, the Wi-Fi indicator lights up.



- Wait approximately 2 minutes until the IP address settings of the machine are completed.

IMPORTANT:
Signal strength

When more than one wireless router is available for connection, the machine connects to the device with the strongest signal. Signal strength is measured using RSSI (Received Signal Strength Indication).

NOTE

Reducing power consumption

You can set the machine to enter <Power Save Mode> based on signals emitted from the wireless router. ▶ **Power Save Mode (P. 474)**

If the IP address of the machine has changed

In a DHCP environment, the IP address of the machine may be changed automatically. If this happens, the connection is maintained as long as the machine and the computer belong to the same subnet.

LINKS

- ▶ **Connecting to a Wireless LAN (MF249dw / MF237w)(P. 319)**

Setting Up Connection Using WPS PIN Code Mode

14L7-068

If your wireless router supports WPS PIN code mode, generate a PIN code with the machine and register the code to the networking device.

IMPORTANT

How to operate the wireless router may vary on each device. See the instruction manuals for your networking device for help.

From a Computer

1 Access your wireless router from a computer and display the screen for entering a WPS PIN code.

- For more information, see the instruction manuals for your networking device.

From the Operation Panel

2 Tap <Menu> in the <Home> Screen.

3 Tap <Network Settings>.

- If a screen for entering a PIN is displayed, enter the PIN with the numeric keys and tap <Apply>.  **Setting the System Manager PIN(P. 397)**

4 Tap <Wireless LAN Settings>.

- If the <Do you want to enable the wireless LAN?> message is displayed, tap <Yes>.
- If the <Direct Connection will be disabled. Is it OK?> message is displayed, tap <Yes>.

5 Read the message that is displayed, and tap <OK>.

6 Tap <WPS PIN Code Mode>.

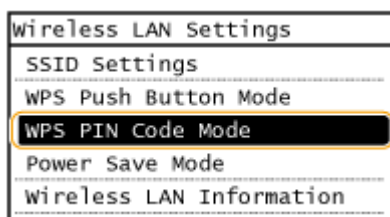

7 Tap <Yes>.

- A PIN code is generated.

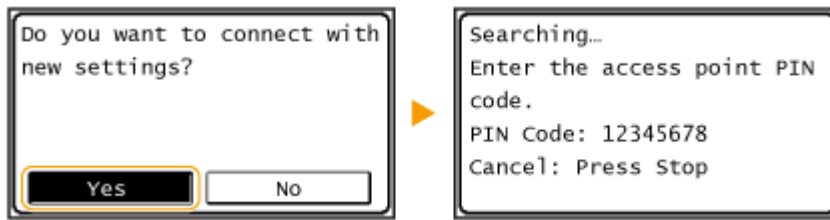

From a Computer

8 Register the generated PIN code to the wireless router.

- Register the PIN code on the setup screen displayed in step 1.
- The PIN code must be registered within 10 minutes after tapping <Yes> in step 7.

NOTE:

If an error message is displayed during setup

Tap <Close> and return to step 6.

From the Operation Panel

9 Check that the Wi-Fi indicator is blinking on the operation panel.

- The Wi-Fi indicator blinks when a wireless router is detected.

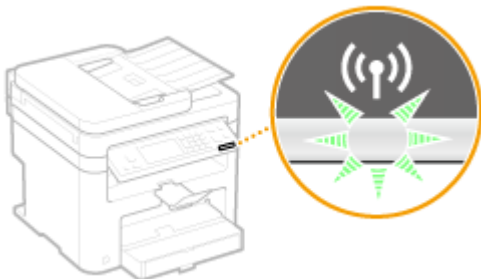

- When the setup is completed, the screen below is displayed, and approximately 2 seconds later, the Wi-Fi indicator lights up.



- Wait approximately 2 minutes until the IP address settings of the machine are completed.

IMPORTANT:

Signal strength

When more than one wireless router is available for connection, the machine connects to the device with the strongest signal. Signal strength is measured using RSSI (Received Signal Strength Indication).

NOTE

Reducing power consumption

You can set the machine to enter <Power Save Mode> based on signals emitted from the wireless router. 
Power Save Mode (P. 474)

If the IP address of the machine has changed

In a DHCP environment, the IP address of the machine may be changed automatically. If this happens, the connection is maintained as long as the machine and the computer belong to the same subnet.

LINKS

 **Connecting to a Wireless LAN (MF249dw / MF237w)(P. 319)**

Setting Up Connection by Selecting a Wireless Router

14L7-069

You can search the wireless routers (or access points) available for connection and select one from the display of the machine. For the network key, enter a WEP key or TKIP. Before selecting a wireless router, check and write down the required setup information, including the SSID and network key ([▶Checking the SSID and Network Key\(P. 333\)](#)).

NOTE

Security settings

If the wireless connection is set up by selecting a wireless router, the WEP authentication method is set to <Open System> or the WPA/WPA2 encryption method is set to <Auto> (AES-CCMP or TKIP). If you want to select <Shared Key> for WEP authentication or <AES-CCMP> for WPA/WPA2 encryption, you need to set up the connection using the manual entry method ([▶Setting Up Connection by Specifying Detailed Settings\(P. 329\)](#)).

1 Tap <Menu> in the <Home> Screen.

2 Tap <Network Settings>.

- If a screen for entering a PIN is displayed, enter the PIN with the numeric keys and tap <Apply>. [▶Setting the System Manager PIN\(P. 397\)](#)

3 Tap <Wireless LAN Settings>.

- If the <Do you want to enable the wireless LAN?> message is displayed, tap <Yes>.
- If the <Direct Connection will be disabled. Is it OK?> message is displayed, tap <Yes>.

4 Read the message that is displayed, and tap <OK>.

5 Tap <SSID Settings>.

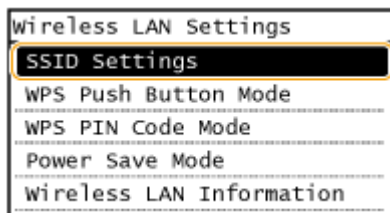

6 Tap <Select Access Point>.

- The machine starts searching for available wireless routers.

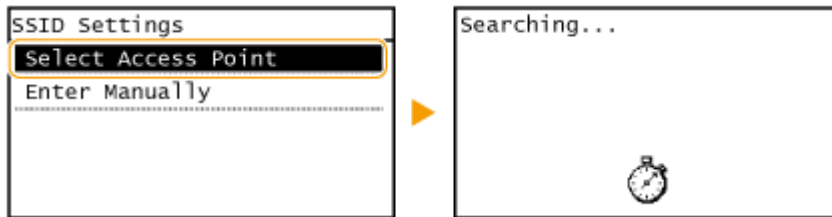

NOTE:
 If <Cannot find the access point.> is displayed
 See [When an Error Message Appears\(P. 548\)](#) .

7 Select a wireless LAN router.

- Select the router whose SSID matches the one that you have written down.

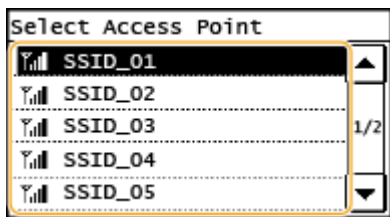

NOTE:
 If your wireless router is not found

Check whether the machine is properly installed and ready to connect to the network. [Installation/Settings Problems\(P. 565\)](#)

8 Enter the network key that you have written down.

- Enter the network key using the numeric keys, and tap <Apply>.
[Entering Text\(P. 38\)](#)

WEP

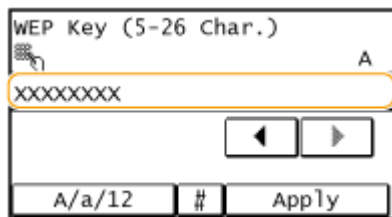

WPA-PSK or WPA2-PSK

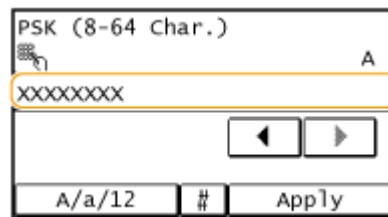

9 Tap <Yes>.

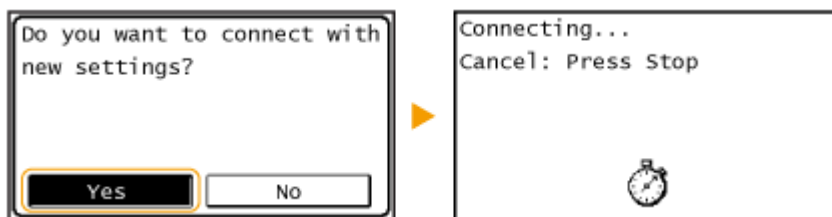

NOTE:
 If an error message is displayed during setup
 Tap <Close>, check whether the network key is correct, and return to step 5.

10 Check that the Wi-Fi indicator is blinking on the operation panel.

- The Wi-Fi indicator blinks when a wireless router is detected.

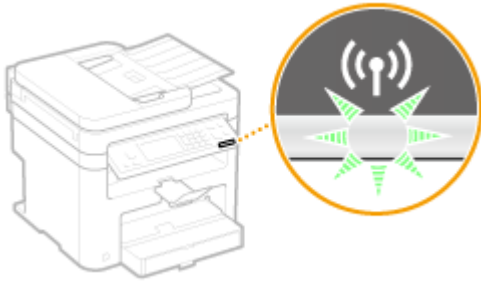

- When the setup is completed, the screen below is displayed, and approximately 2 seconds later, the Wi-Fi indicator lights up.



- Wait approximately 2 minutes until the IP address settings of the machine are completed.

IMPORTANT:
Signal strength

When more than one wireless router is available for connection, the machine connects to the device with the strongest signal. Signal strength is measured using RSSI (Received Signal Strength Indication).

NOTE

Reducing power consumption

You can set the machine to enter <Power Save Mode> based on signals emitted from the wireless router. ▶
Power Save Mode (P. 474)

If the IP address of the machine has changed

In a DHCP environment, the IP address of the machine may be changed automatically. If this happens, the connection is maintained as long as the machine and the computer belong to the same subnet.

LINKS

▶ **Connecting to a Wireless LAN (MF249dw / MF237w)(P. 319)**

Setting Up Connection by Specifying Detailed Settings

14L7-06A

If you want to specify the security settings in detail or cannot establish the wireless connection using the other procedures, manually enter all the required information for the wireless LAN connection. Before specifying detailed settings, check and write down the required information, including the SSID, network key, and wireless security protocols ([▶Checking the SSID and Network Key\(P. 333\)](#)).

1 Tap <Menu> in the <Home> Screen.

2 Tap <Network Settings>.

- If a screen for entering a PIN is displayed, enter the PIN with the numeric keys and tap <Apply>. [▶Setting the System Manager PIN\(P. 397\)](#)

3 Tap <Wireless LAN Settings>.

- If the <Do you want to enable the wireless LAN?> message is displayed, tap <Yes>.
- If the <Direct Connection will be disabled. Is it OK?> message is displayed, tap <Yes>.

4 Read the message that is displayed, and tap <OK>.

5 Select <SSID Settings> ▶ <Enter Manually>.

6 Enter the SSID that you have written down.

- Enter the SSID using the numeric keys, and tap <Apply>. [▶Entering Text\(P. 38\)](#)

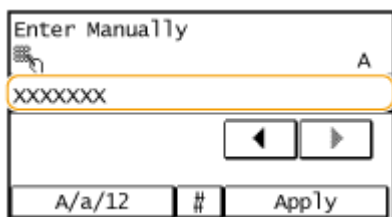

7 Specify the security settings based on the information that you have written down.

- If you do not need to specify the security settings, tap <None>.

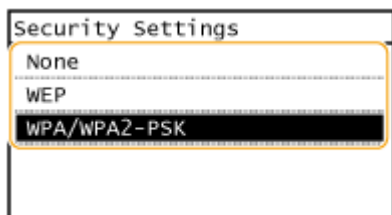

■ Using WEP

- 1 Tap <WEP>.
- 2 Select an authentication method.

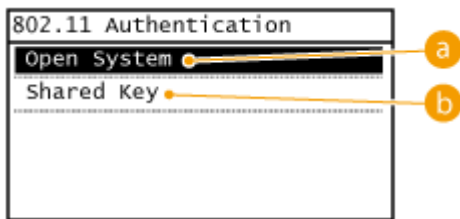

a <Open System>

Sets open system authentication, which is also called "open authentication."

b <Shared Key>

Uses the WEP key as a password.

NOTE:

When <Open System> is selected

When connecting to a wireless LAN, the machine experiences an authentication error if the shared key authentication is set on the wireless router. If this happens, the machine automatically changes the setting to <Shared Key> and retries the connection.

- 3 Tap <Edit WEP Key>.

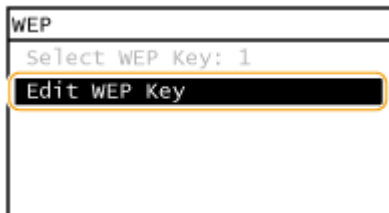

- 4 Select the WEP key(1 to 4) you want to edit.
 - Up to four WEP keys can be registered.

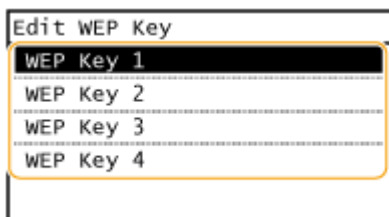

- 5 Enter the network key that you have written down.
 - Enter the network key using the numeric keys, and tap <Apply>. [▶ Entering Text\(P. 38\)](#)

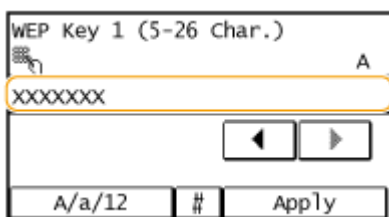

- 6 Tap <Select WEP Key>.

7 Tap the WEP key you have edited.

Using WPA-PSK or WPA2-PSK

1 Tap <WPA/WPA2-PSK>.

2 Select an encryption method.



a <Auto>

Sets the machine to automatically select AES-CCMP or TKIP to match the setting of the wireless router.

b <AES-CCMP>

Sets AES-CCMP as the encryption method.

3 Enter the network key that you have written down.

- Enter the network key using the numeric keys, and tap <Apply>. **▶ Entering Text(P. 38)**

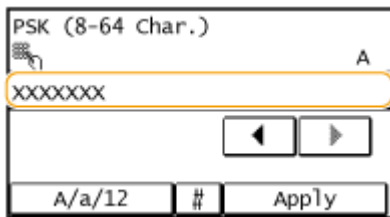

8 Tap <Yes>.

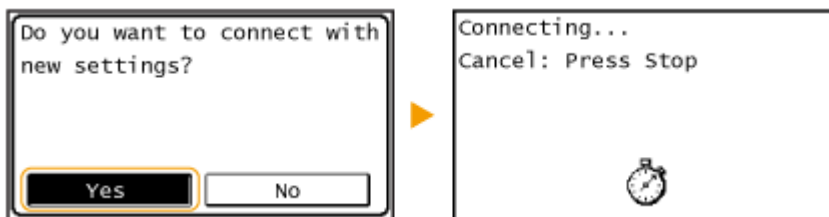

NOTE:

If an error message is displayed during setup

Tap <Close>, check whether the specified settings are correct, and return to step 5.

9 Check that the Wi-Fi indicator is blinking on the operation panel.

- The Wi-Fi indicator blinks when a wireless router is detected.

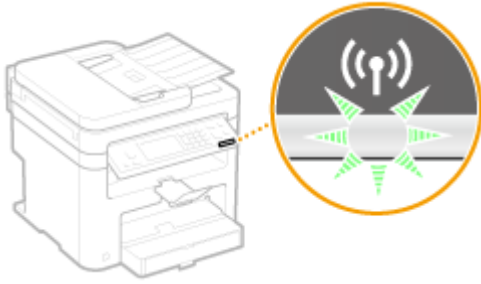

- When the setup is completed, the screen below is displayed, and approximately 2 seconds later, the Wi-Fi indicator lights up.



- Wait approximately 2 minutes until the IP address settings of the machine are completed.

IMPORTANT:
Signal strength

When more than one wireless router is available for connection, the machine connects to the device with the strongest signal. Signal strength is measured using RSSI (Received Signal Strength Indication).

NOTE

Reducing power consumption

You can set the machine to enter <Power Save Mode> based on signals emitted from the wireless router. 
Power Save Mode (P. 474)

If the IP address of the machine has changed

In a DHCP environment, the IP address of the machine may be changed automatically. If this happens, the connection is maintained as long as the machine and the computer belong to the same subnet.

LINKS

-  **Connecting to a Wireless LAN (MF249dw / MF237w)(P. 319)**

Checking the SSID and Network Key

14L7-06C

When manually setting up a wireless connection, you need to specify the SSID and network key of your wireless router. The SSID and network key may be indicated on these networking devices. Check your devices and write down the necessary information before setting up the connection. For more information, see the instruction manuals for your networking devices or contact your manufacturer.

SSID	A name given for identifying a specific wireless LAN. Some other terms used for SSID include "access point name" and "network name."
Network Key	A keyword or password used for encrypting data or authenticating a network. Some other terms used for network key include "encryption key," "WEP key," "WPA/WPA2 passphrase," and "preshared key (PSK)."
Wireless Security Protocols (Authentication/ Encryption)	When manually setting up a wireless connection by specifying detailed settings, you need to specify security settings. Check the following information: <ul style="list-style-type: none"> • Security types (WEP/WPA-PSK/WPA2-PSK) • Authentication method (Open System/Shared Key) • Encryption method (TKIP/AES-CCMP)

■ Checking the SSID and Network Key from a Computer

The SSID or the network key may have been changed. If you do not know the SSID or the network key, you can check them by using the Canon MF/LBP Wireless Setup Assistant included with the provided DVD-ROM. The Canon MF/LBP Wireless Setup Assistant can be used on a computer connected to a wireless LAN.

NOTE

If you are a Mac OS user

The provided DVD-ROM that comes with the machine does not contain the Canon MF/LBP Wireless Setup Assistant for Mac OS. It is available from the following Canon Web site: <http://www.canon.com/>

1 Insert the provided DVD-ROM into the drive on the computer.

- Select a language and click [OK] if you are prompted to do so.

2 Click [Start Software Programs].

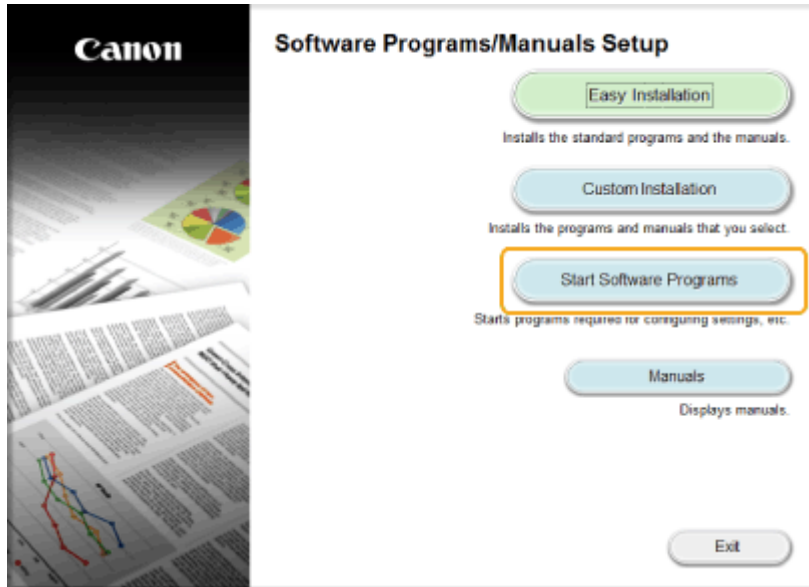

NOTE:

- If the above screen is not displayed ▶ **Displaying the [Software Programs/Manuals Setup] Screen(P. 665)**
- If [AutoPlay] is displayed, click [Run MInst.exe].

3 Click [Start] for [Canon MF/LBP Wireless Setup Assistant].

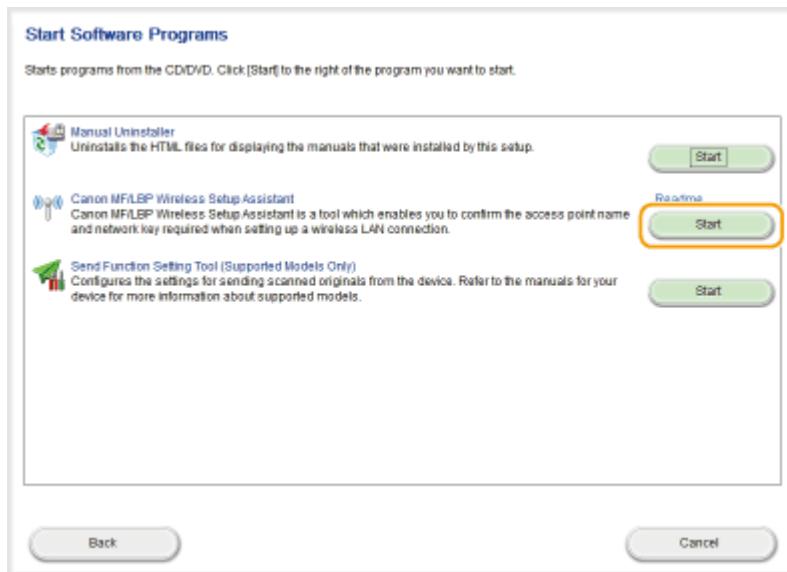

4 Read the License Agreement and click [Yes] to agree.

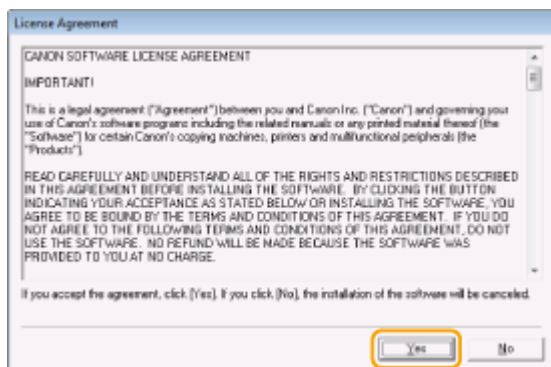

5 Check the information displayed for the wireless router.

- Write down the necessary information. If you do not know what information is necessary, write down all the information that is displayed.

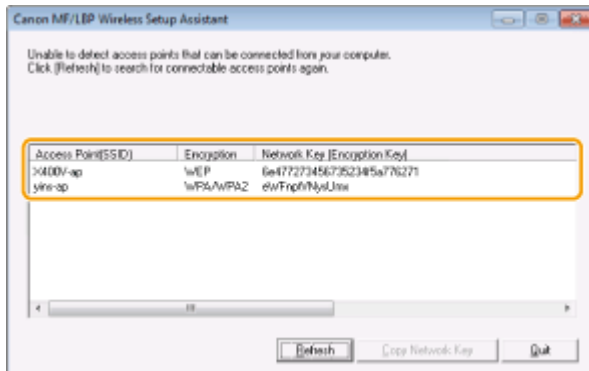

NOTE:

If wireless routers are not found

Click [Refresh]. If nothing happens, check that the settings are correctly configured on the computer and the wireless router.

LINKS

- ▶ [Connecting to a Wireless LAN \(MF249dw / MF237w\)\(P. 319\)](#)
- ▶ [Setting Up Connection by Selecting a Wireless Router\(P. 326\)](#)
- ▶ [Setting Up Connection by Specifying Detailed Settings\(P. 329\)](#)

Setting IP Addresses

14L7-06E

Connecting the machine to a network requires a unique network IP address. Two versions of IP addresses are available: IPv4 and IPv6. Configure these settings depending on the network environment. To use IPv6 addresses, you need to properly configure the IPv4 address settings.

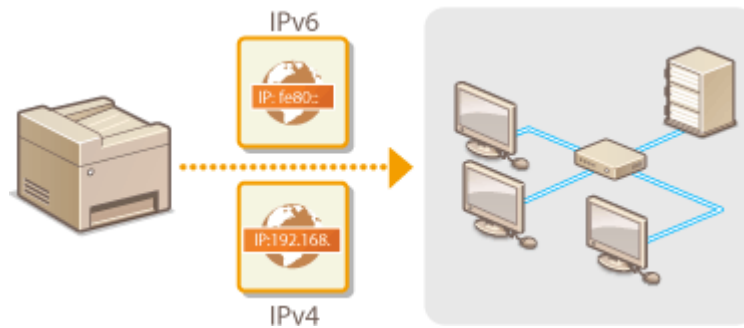

Setting IPv4 Address



The machine's IPv4 address can be either assigned automatically by a dynamic IP addressing protocol, such as DHCP, or entered manually. When connecting the machine to a wired LAN, make sure that the connectors of the LAN cable are firmly inserted into the ports (**Connecting to a Wired LAN(P. 318)**). You can test the network connection if necessary.

- ▶ **Setting IPv4 Address(P. 337)**
- ▶ **Testing the Network Connection(P. 339)**

Setting IPv4 Address

1 Tap <Menu> in the <Home> Screen.

2 Tap <Network Settings>.

- If a screen for entering a PIN is displayed, enter the PIN with the numeric keys and tap <Apply>. ▶ **Setting the System Manager PIN(P. 397)**

3 Select <TCP/IP Settings> ▶ <IPv4 Settings> ▶ <IP Address Settings>.

4 Configure IP address settings.

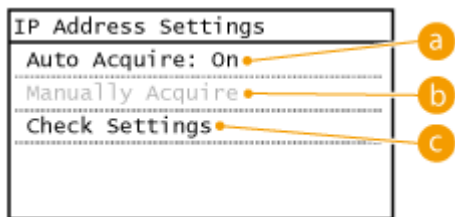

a <Auto Acquire>

Select to automatically assign an IP address via a protocol such as DHCP. When <Auto Acquire: On> is displayed, automatic addressing is enabled.

b <Manually Acquire>

Select to configure the IP address settings by manually entering an IP address. In order to select this option, <Auto Acquire> must be set to <Off>.

c <Check Settings>

Select when you want to view the current IP address settings.

■ Automatically assigning an IP address

1 Select <Auto Acquire> ▶ <Select Protocol>.

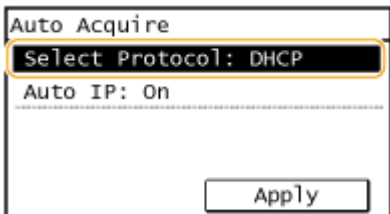

- 2 Tap <DHCP>, <BOOTP>, or <RARP>.

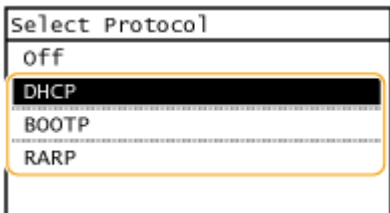

NOTE:

If you do not want to use DHCP/BOOTP/RARP to assign an IP address

Select <Off>. If you select <DHCP>, <BOOTP>, or <RARP> when these services are unavailable, the machine will waste time and communications resources searching the network for these services.

- 3 Check that <Auto IP> is set to <On>.
 - If <Off> is selected, change the setting to <On>.

- 4 Tap <Apply>.

NOTE:

IP addresses assigned via DHCP/BOOTP/RARP override the address obtained via Auto IP.

Manually entering an IP address

- 1 Check that <Auto Acquire> is set to <Off>.

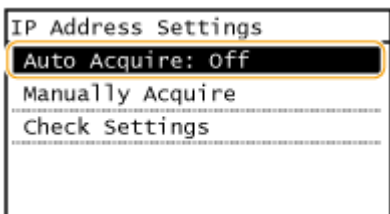

- If <On> is displayed, tap <Auto Acquire>, and set both <Select Protocol> and <Auto IP> to <Off>.

- 2 Tap <Manually Acquire>.

- 3 Specify the IP address, subnet mask, and gateway address (or default gateway).
 - Specify the settings in the following order: <IP Address> ► <Subnet Mask> ► <Gateway Address>.
 - Enter each setting using the numeric keys, and tap <Apply>.

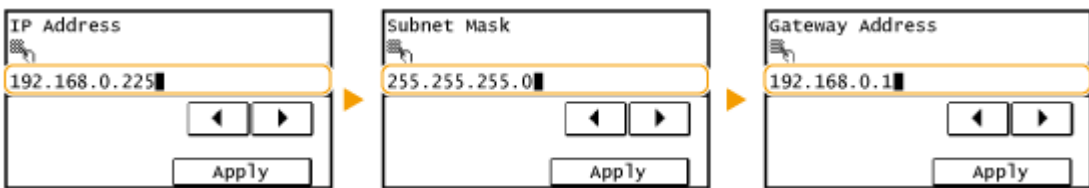

NOTE

Checking whether the settings are correct

Make sure that the Remote UI screen can be displayed with your computer ([▶Starting Remote UI\(P. 450\)](#)). If a computer is not available, you can check the connection by using the operation panel ([▶Testing the Network Connection\(P. 339\)](#)).

Testing the Network Connection

1 Tap <Menu> in the <Home> Screen.

2 Tap <Network Settings>.

- If a screen for entering a PIN is displayed, enter the PIN with the numeric keys and tap <Apply>. [▶Setting the System Manager PIN\(P. 397\)](#)

3 Select <TCP/IP Settings> ▶ <IPv4 Settings> ▶ <PING Command>.

4 Enter the IPv4 address of another device on the network, and tap <Apply>.

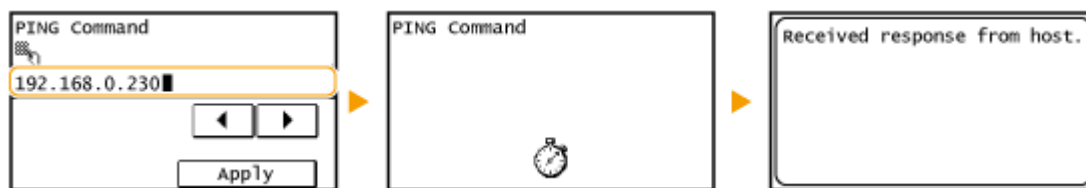

- If a proper connection has been established, the result is displayed as shown above.

LINKS

[▶Setting IPv6 Addresses\(P. 340\)](#)

[▶Viewing Network Settings\(P. 344\)](#)

Setting IPv6 Addresses

14L7-06H



The IPv6 addresses of the machine can be configured via the Remote UI. Before setting IPv6 addresses, check the IPv4 address settings ([▶Viewing IPv4 Settings\(P. 344\)](#)). You need to set the correct IPv4 settings to use IPv6 addresses. Note that the scan function that uses the scanner driver or MF Scan Utility is not available in an IPv6 environment. The machine can use up to nine of the following IPv6 addresses:

Type	Maximum number available	Description
Link-local address	1	An address that is only valid within a subnet or link and cannot be used to communicate with devices beyond a router. A link-local address is automatically set when the IPv6 function of the machine is enabled.
Manual address	1	An address that is entered manually. When using this address, specify the prefix length and default router address.
Stateless address	6	An address that is generated automatically using the MAC address of the machine and the network prefix that is advertised by the router. Stateless addresses are discarded when the machine is restarted (or turned ON).
Stateful address	1	An address obtained from a DHCP server using DHCPv6.

1 Start the Remote UI and log on in System Manager Mode. [▶Starting Remote UI\(P. 450\)](#)

2 Click [Settings/Registration].

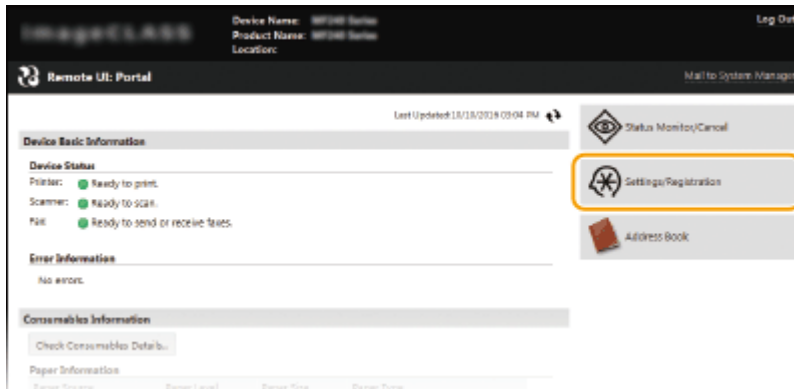

3 Click [Network Settings] ▶ [TCP/IP Settings].

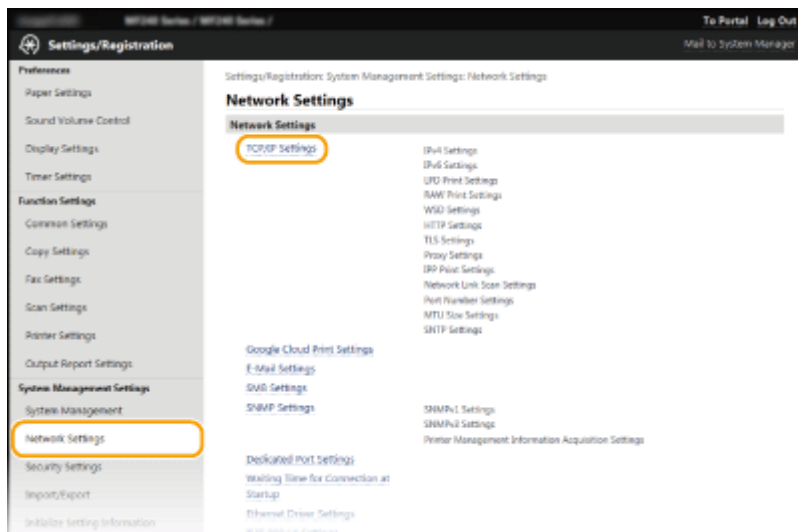

4 Click [Edit] in [IPv6 Settings].

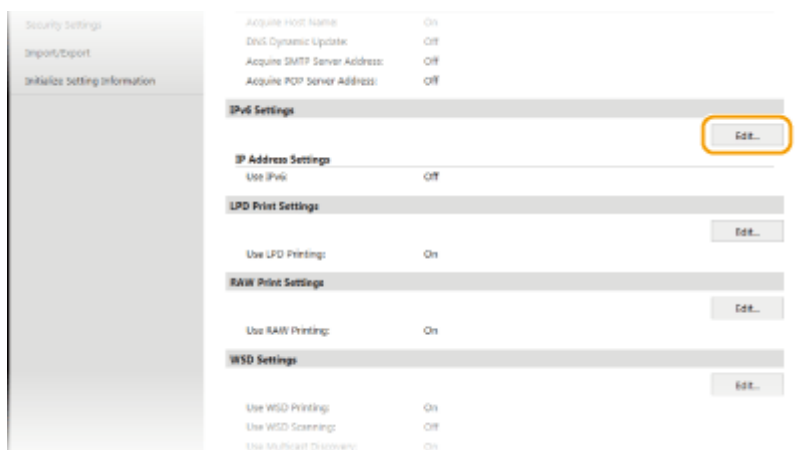

5 Select the [Use IPv6] check box and configure the required settings.

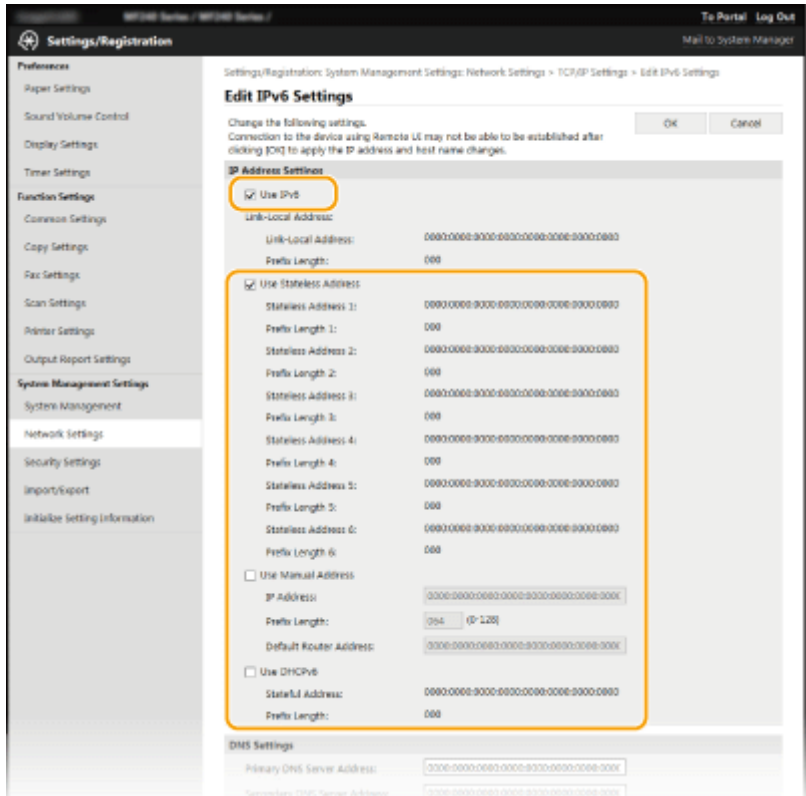

[Use IPv6]
 Select the check box to enable IPv6 on the machine. When not using IPv6, clear the check box.

[Use Stateless Address]
 Select the check box when using a stateless address. When not using a stateless address, clear the check box.

[Use Manual Address]
 When you want to manually enter an IPv6 address, select the check box and enter the IP address, prefix length, and default router address in the corresponding text boxes.

[IP Address]
 Enter an IPv6 address. Addresses that start with "ff" (or multicast address) cannot be entered.

[Prefix Length]
 Enter a number that indicates how many bits are available for the network address.

[Default Router Address]
 Specify the IPv6 address of the default router as necessary. Addresses that start with "ff" (or multicast address) cannot be entered.

[Use DHCPv6]
 Select the check box when using a stateful address. When not using DHCPv6, clear the check box.

6 Click [OK].

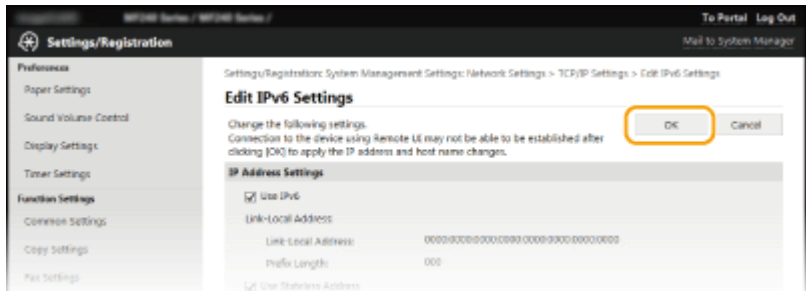

NOTE

Checking whether the settings are correct

Make sure that the Remote UI screen can be displayed with your computer by using the IPv6 address of the machine. ▶ **Starting Remote UI(P. 450)**

Using the operation panel

IPv6 settings can also be accessed from <Menu> in the <Home> Screen. ▶ **IPv6 Settings(P. 477)**

LINKS

▶ **Setting IPv4 Address(P. 337)**

▶ **Viewing Network Settings(P. 344)**

Viewing Network Settings

14L7-06J

- ▶ Viewing IPv4 Settings(P. 344)
- ▶ Viewing IPv6 Settings(P. 344)
- ▶ Viewing the MAC Address for Wired LAN(P. 345)
- ▶ Viewing the MAC Address and Information for Wireless LAN (MF249dw / MF237w)(P. 345)

NOTE

- The IP address is not correctly configured if it is displayed as "0.0.0.0".
- Connecting the machine to a switching hub or bridge may result in a connection failure even when the IP address is correctly configured. This problem can be solved by setting a certain interval before the machine starts communicating. ▶ **Setting a Wait Time for Connecting to a Network(P. 376)**
- You can print a list of the current network settings. ▶ **User Data List(P. 619)**

Viewing IPv4 Settings



▶ <Network Information> ▶ <IPv4> ▶ Select the setting to view

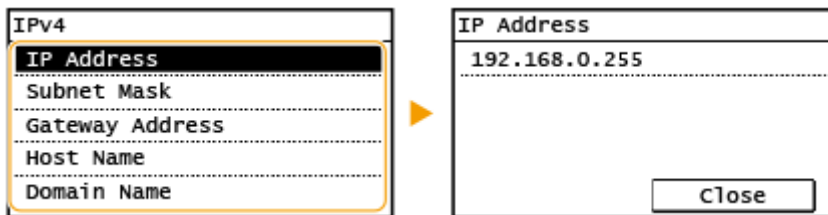

Viewing IPv6 Settings



▶ <Network Information> ▶ <IPv6> ▶ Select the setting to view



Viewing the MAC Address for Wired LAN

1 Tap <Menu> in the <Home> Screen.

2 Tap <Network Settings>.

- If a screen for entering a PIN is displayed, enter the PIN with the numeric keys and tap <Apply>. **▶Setting the System Manager PIN(P. 397)**

3 Tap <Ethernet Driver Settings>.

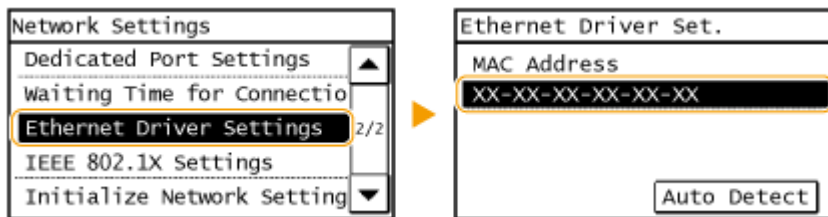

Viewing the MAC Address and Information for Wireless LAN (MF249dw / MF237w)

1 Tap <Menu> in the <Home> Screen.

2 Tap <Network Settings>.

- If a screen for entering a PIN is displayed, enter the PIN with the numeric keys and tap <Apply>. **▶Setting the System Manager PIN(P. 397)**

3 Tap <Wireless LAN Settings>.

- If the <Do you want to enable the wireless LAN?> message is displayed, tap <Yes>.
- If the <Direct Connection will be disabled. Is it OK?> message is displayed, tap <Yes>.

4 Read the message that is displayed, and tap <OK>.

5 Tap <Wireless LAN Information>.

6 Select the setting to view.

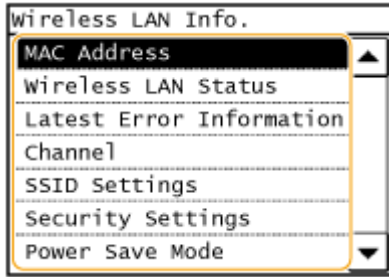

■ Viewing WEP and WPA/WPA2-PSK information

- 1 Tap <Security Settings>.
- 2 Confirm and tap the current security setting.
 - If the security settings are not configured, <None> is displayed.
- 3 Select the setting to view.

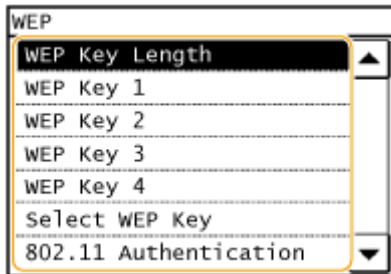

WEP

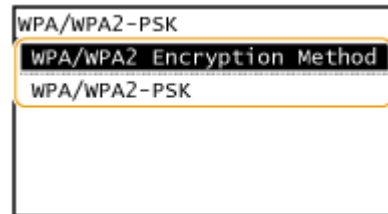

WPA/WPA2-PSK



NOTE

- <Wireless LAN Status> and <Latest Error Information> can be viewed from . Press  > <Network Information> > <Network Connection Method> and select the setting to view.

LINKS

- ▶ Connecting to a Wireless LAN (MF249dw / MF237w)(P. 319)
- ▶ Setting IPv4 Address(P. 337)
- ▶ Setting IPv6 Addresses(P. 340)
- ▶ Configuring DNS(P. 377)

Configuring the Machine for Printing or Faxing from a Computer

14L7-06K

When using the machine as a network printer or a PC-to-fax machine, you can configure the protocols and ports used for printing and create a print server for the machine. Before configuring the machine for printing or faxing from a computer, perform the basic setup procedures, including the printer driver installation. For more information, see "MF Driver Installation Guide."

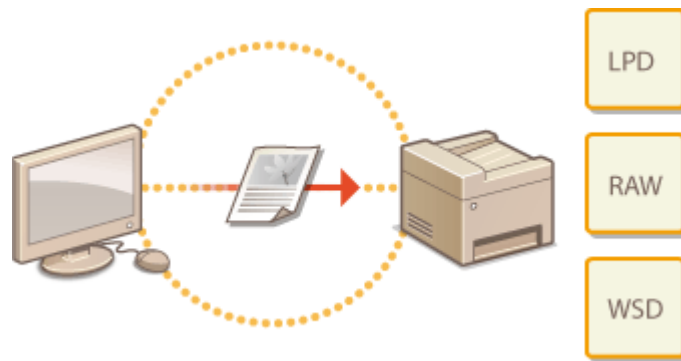

NOTE

- Printing protocols are rules for delivering document data created on a computer to the machine, and can be selected according to the printing purpose or the network environment.
- Ports are gateways for passing document data from a computer to the printer. Incorrect port settings are often the cause when documents cannot be printed from a network computer.

Configuring Printing Protocols and WSD Functions

14L7-06L

Configure the protocols that are used for printing documents from a networked computer. The protocols supported by the machine include LPD, RAW, and WSD (Web Services on Devices).

NOTE

To change protocols' port numbers, see [▶ Changing Port Numbers \(MF249dw / MF246dn / MF237w\)\(P. 409\)](#) .

1 Start the Remote UI and log on in System Manager Mode. ▶ Starting Remote UI(P. 450)

2 Click [Settings/Registration].

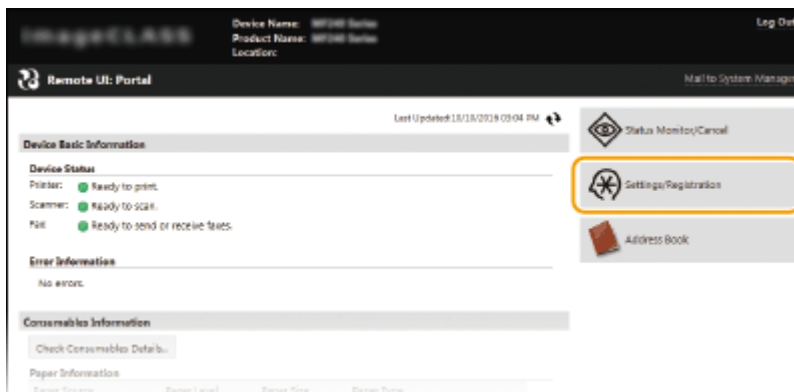

3 Click [Network Settings] ▶ [TCP/IP Settings].

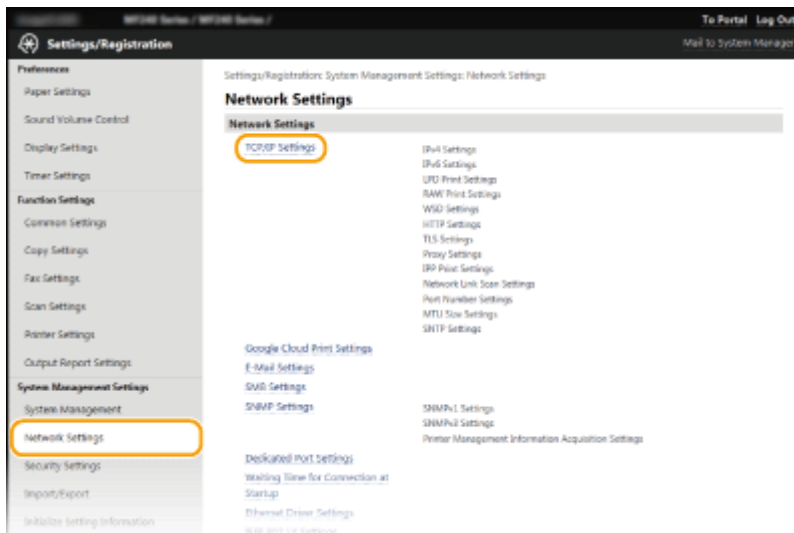

4 Configure printing protocols.

■Configuring LPD or RAW

- 1 Click [Edit] in [LPD Print Settings] or [RAW Print Settings].

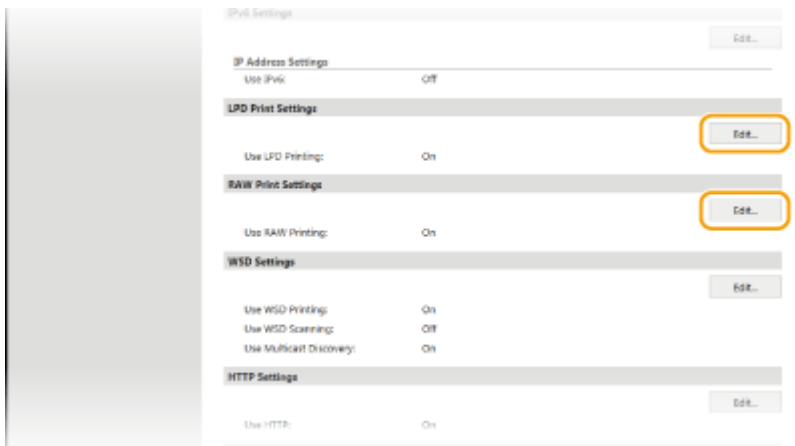

- 2 Configure the settings as necessary.

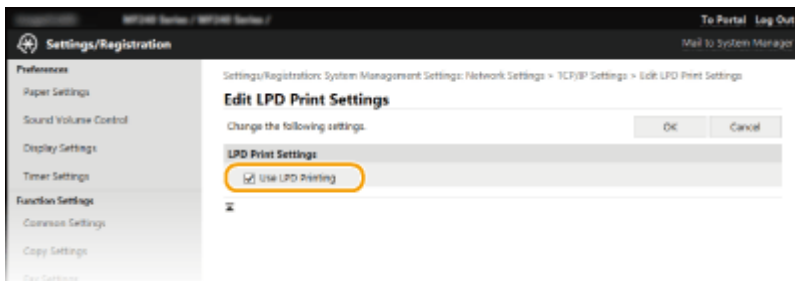

[Use LPD Printing]

Select the check box to print via LPD. When not using LPD printing, clear the check box.

[Use RAW Printing]

Select the check box to print via RAW. When not using RAW printing, clear the check box.

- 3 Click [OK].

■Configuring WSD

- 1 Click [Edit] in [WSD Settings].

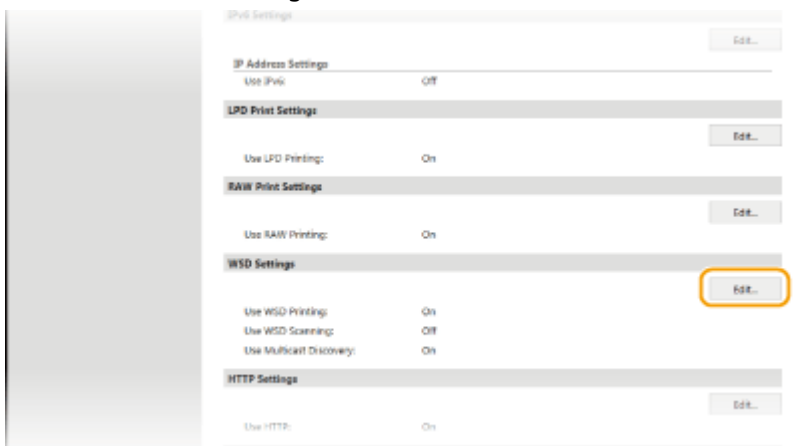

- 2 Configure the settings as necessary.

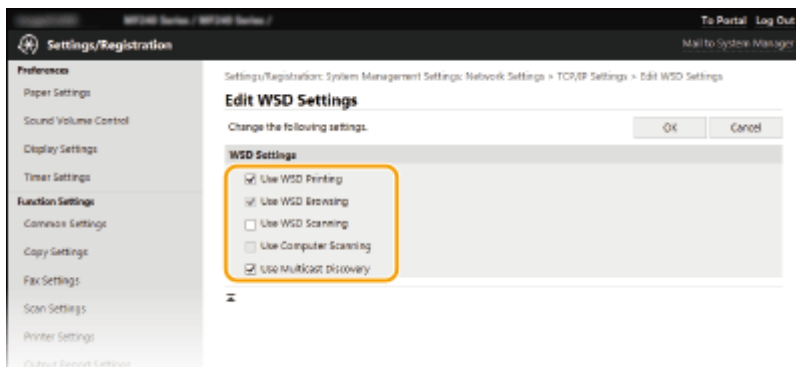
**[Use WSD Printing]**

Select the check box to print via WSD. When not using WSD printing, clear the check box.

[Use WSD Browsing]

Select the check box to obtain information about the machine from a computer via WSD. This check box is automatically selected when the [Use WSD Printing] check box is selected.

[Use WSD Scanning]

Available for Windows Vista/7/8/10, WSD scanning enables you to scan documents to a computer without installing the scanner driver. Select the check box to scan documents via WSD. When not using WSD scanning, clear the check box.

[Use Computer Scanning]

Select the check box to use WSD scanning by operating the machine with the operation panel. This check box can only be selected when the [Use WSD Scanning] check box is selected. To perform scanning, tap <Scan> and specify a WSD-connected computer as a scan destination. (**▶ Scanning from the Machine(P. 234)**).

[Use Multicast Discovery]

Select the check box to set the machine to reply to multicast discovery messages. If the check box is cleared, the machine stays in sleep mode even when multicast discovery messages are flowing on the network.

3 Click [OK].

NOTE**Using the operation panel**

- LPD, RAW, and WSD settings can also be accessed from <Menu> in the <Home> Screen.

- ▶ **LPD Print Settings(P. 479)**
- ▶ **RAW Print Settings(P. 479)**
- ▶ **WSD Settings(P. 479)**

Setting up WSD network devices on Windows Vista/7/8/10

- The WSD printer and scanner can be added from the printer folder. Open the printer folder (**▶ Displaying the Printer Folder(P. 664)**) ▶ click [Add a device] or [Add a printer] and follow the on-screen instructions. For more information about how to install MF Drivers for the WSD network printer, see "MF Driver Installation Guide."

LINKS

▶ **Configuring Printer Ports(P. 351)**

Configuring Printer Ports

14L7-06R

Printing errors can occur when the IP address of the machine has been changed, or when a printer has been added via the Windows printer folder. These errors are typically caused by incorrect printer port settings. For example, an incorrect port number or port type may have been specified. In such situations, your attempt to print fails because the document data cannot reach the machine. To fix this type of problem, configure the printer port settings on the computer.

IMPORTANT

To perform the following procedure, log on to your computer with an administrator account.

- 1 Open the printer folder. ▶ **Displaying the Printer Folder(P. 664)**
- 2 Right-click your printer icon and click **[Printer properties]** (or **[Properties]**).

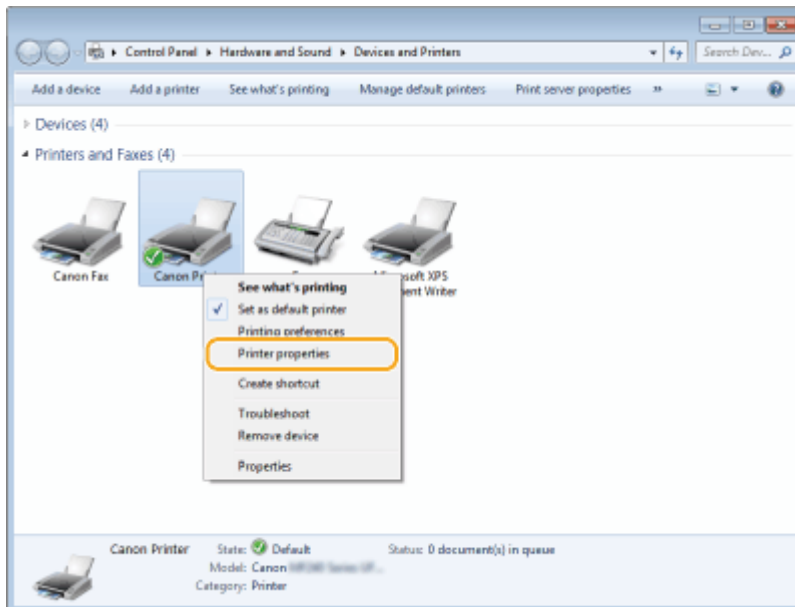

- 3 Click the **[Ports]** tab and configure the required settings.

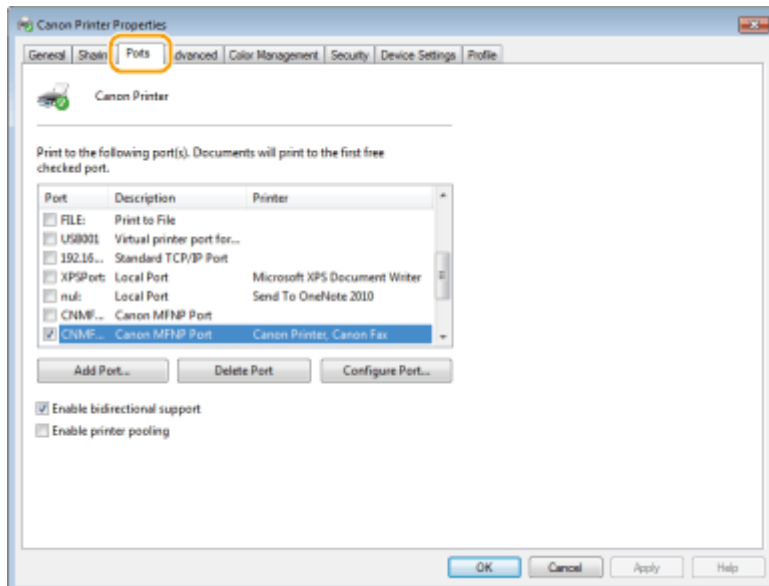

■ Adding a port

If the IP address of the machine has been changed, add a new port. Adding a port is also an effective solution when an incorrect port type was selected in the Windows printer folder during the printer driver installation.

- 1 Click [Add Port].
- 2 Select [Canon MFNP Port] in [Available port types] and click [New Port].

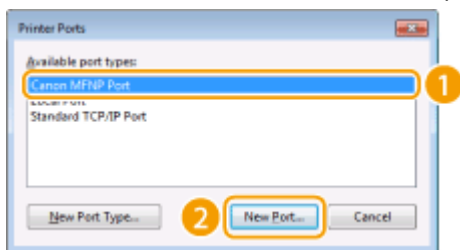

- 3 Click [Auto Detect], select the machine when it is detected, and click [Next].



NOTE:

If the machine is not detected

Click [Refresh]. If the problem persists, click [IP address] or [MAC address], enter the IP address or MAC address of the machine ([▶ Viewing Network Settings\(P. 344\)](#)), and then click [Next].

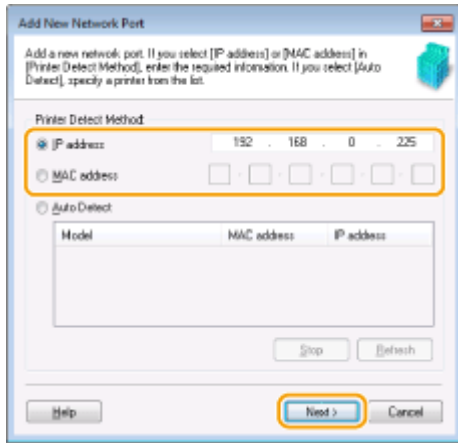

4 Click [Add] ► [Finish].

5 Click [Close].

■ Changing the port type or number

If the printing protocols ([◀ Configuring Printing Protocols and WSD Functions\(P. 348\)](#)) or port numbers ([▶ Changing Port Numbers \(MF249dw / MF246dn / MF237w\)\(P. 409\)](#)) have been changed on the machine, the corresponding settings on the computer must also be configured. This change is only available for LPR or RAW ports.

1 Click [Configure Port].

2 Click the [LPR] or [RAW] radio button in [Protocol Type], change the number in the [Port Number] text box as necessary, and then click [OK].

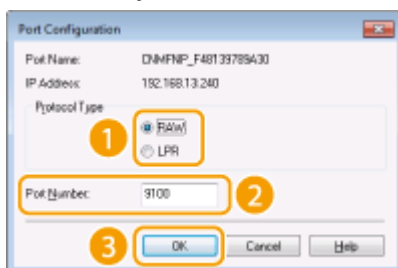

4 Click [Close].

LINKS

[▶ Setting Up Print Server\(P. 354\)](#)

Setting Up Print Server

14L7-06S

With a print server, you can reduce the load on the computer that you print from. The print server also enables each computer to install MF Drivers over the network, which saves you the trouble of installing the drivers on each computer by using the provided DVD-ROM. To set up a computer on the network as a print server, configure the settings for sharing the printer.

IMPORTANT

- To perform the following procedure, log on to your computer with an administrator account.
- You may be unable to install drivers over the network depending on the operating system and the bit architecture (32-bit or 64-bit) of the print server and client computers.
- When implementing a print server in a domain environment, consult your Network Administrator.

NOTE

To obtain device information when using a print server

- Canon Driver Information Assist Service must be added during the printer driver installation. For more information, see "MF Driver Installation Guide."

1 Open the printer folder. ▶ **Displaying the Printer Folder(P. 664)**

2 Right-click your printer icon and click [Printer properties] (or [Properties]).

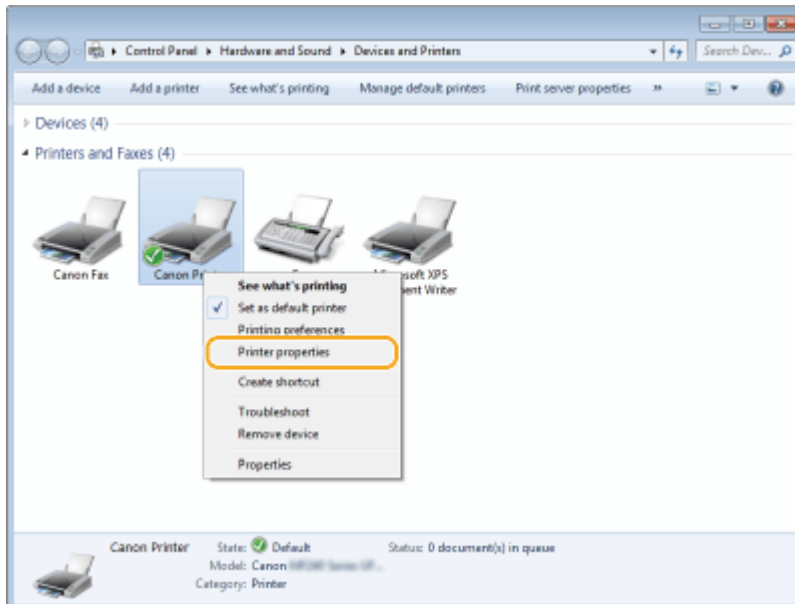

3 Click the [Sharing] tab, select [Share this printer], and enter the share name of the machine.

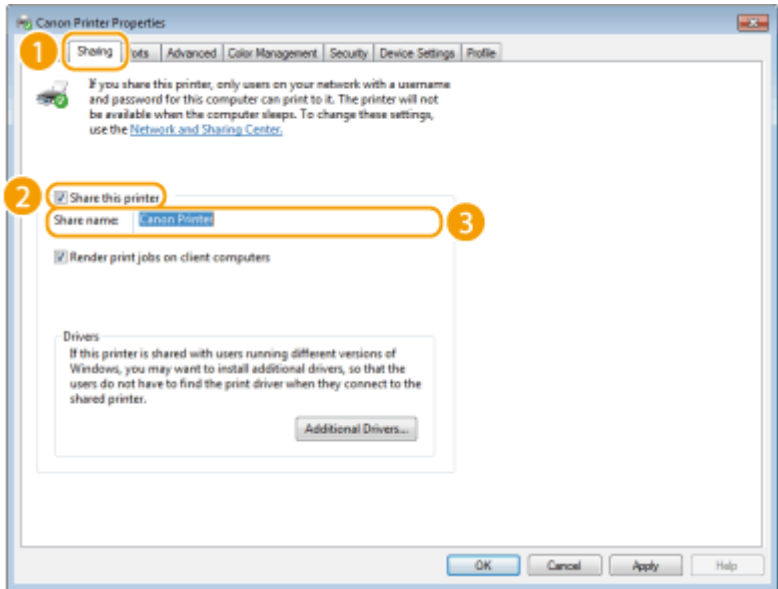

NOTE:
 When [Change Sharing Options] is displayed
 Click [Change Sharing Options]. If the [User Account Control] dialog box appears, click [Yes] (or [Continue]).

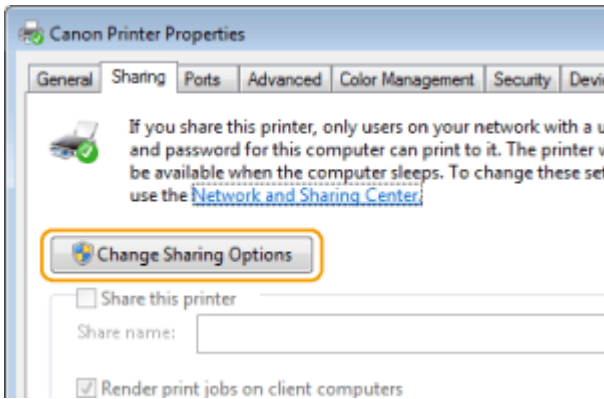

4 Install additional drivers as necessary.

- This operation is required if you want to install MF Drivers in other computers running a different bit architecture via the print server.

- 1 Click [Additional Drivers].
- 2 Select the check box for the bit architecture that other computers are running, and click [OK].

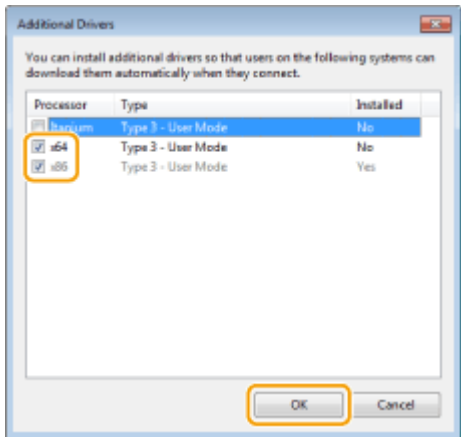

- Select additional drivers from the following, according to the operating system of the print server.

Print server	Select the check box for
32-bit operating systems	[x64]
64-bit operating systems	[x86] under [Processor]

NOTE:

If you do not know whether your Windows Vista/7/8/10/Server 2008/Server 2012 is a 32-bit or 64-bit operating system, see [▶Checking the Bit Architecture\(P. 667\)](#) .

- 3** Insert the provided DVD-ROM into the drive on the computer, click [Browse] to specify the folder that contains MF Drivers, and then click [OK].
 - * Specify the folder for your language in [xxxx].
 - If the print server runs a 32-bit operating system, select [intdrv] ▶ [UFRII] or [PCL] ▶ [XXXX]* ▶ [x64] ▶ [Driver] folders on the provided DVD-ROM.
 - If the print server runs a 64-bit operating system, select [intdrv] ▶ [UFRII] or [PCL] ▶ [XXXX]* ▶ [32bit] ▶ [Driver] folders on the provided DVD-ROM.
- 4** Follow the on-screen instructions to install the drivers.

5 Click [OK].**■ Installing MF Drivers on a Computer via the Print Server**

- 1** Locate the shared printer in the print server. [▶Displaying Shared Printers in the Print Server\(P. 665\)](#)
- 2** Double-click the shared printer.
- 3** Follow the on-screen instructions to install the drivers.

LINKS

[▶Printing from a Computer\(P. 190\)](#)

Configuring Scan Settings (E-Mail/Shared Folders)

MF249dw / MF246dn

14L7-06U

To send scanned originals directly by e-mail or save them to shared folders, you need to configure the network. The Send Function Setting Tool, an application that is included with the machine, will assist you with the required setup. Set the necessary configuration depending on your purpose and network environment.

Scanning to E-Mail



▶ [Configuring Scan Settings \(Sending E-Mail\)\(P. 358\)](#)

Scanning to Shared Folders

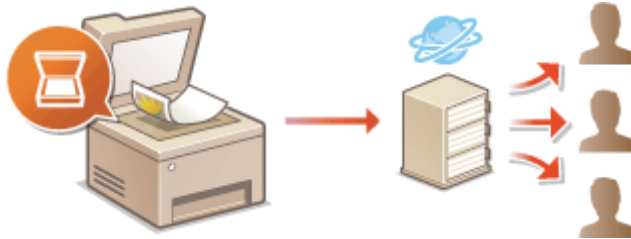

▶ [Configuring the Machine for Scanning to Shared Folders\(P. 367\)](#)

LINKS

- ▶ [Specifications for E-Mail Sending \(MF249dw / MF246dn\)\(P. 653\)](#)
- ▶ [Specifications for Scanning to Shared Folders \(MF249dw / MF246dn\)\(P. 654\)](#)

Configuring Scan Settings (Sending E-Mail)

14L7-06W

Before configuring the machine for scanning to e-mail, check the setup flow shown below.

1



Make sure that the machine and the computer are correctly connected.

- ▶ **Connecting to a Wireless LAN (MF249dw / MF237w)(P. 319)**
- ▶ **Connecting to a Wired LAN(P. 318)**



2



Make sure that you have the following information:

- The IP address of the machine. ▶ **Viewing Network Settings(P. 344)**
- An e-mail address to be registered as a destination.
- Information about the e-mail server, including the SMTP server name, port numbers, whether authentication is required, and the user name and password for authentication.

NOTE:

- For more information about the e-mail server settings, contact your Internet service provider or Network Administrator.



3



Make sure that the computer meets the following system requirements for the Send Setting Tool(sending e-mail):

- **Operating system**
Windows Vista/7/8/10/Server 2008/Server 2012
- **Web browser**
Microsoft Internet Explorer 7.0 or later
- **Display**
SVGA monitor (with at least 800 x 600 pixel screen resolution) that supports at least 256 colors

NOTE:

- Also make sure that <Use HTTP> and <Use Remote UI> are set to <On>.
 - ▶ **Disabling HTTP Communication (MF249dw / MF246dn / MF237w)(P. 423)**
 - ▶ **Disabling Remote UI (MF249dw / MF246dn / MF237w)(P. 424)**



4



Set the machine configuration.

- Configuring Basic E-Mail Settings ▶ **Configuring Basic E-Mail Settings(P. 359)**
- Configuring E-Mail Communication Settings ▶ **Configuring E-Mail Communication Settings(P. 363)**
- Configuring Detailed E-Mail Communication Settings (Authentication, Encryption, etc.) ▶ **Configuring E-Mail Communication Settings(P. 363)**

Configuring Basic E-Mail Settings

14L7-06X

This section describes how to configure the e-mail settings by using the Send Function Setting Tool. With the Send Function Setting Tool, you can also register e-mail addresses to the Address Book.

NOTE

- The Send Function Setting Tool helps you configure the basic settings for sending e-mails. Instead of the Send Function Setting Tool, you can use the Remote UI to configure more detailed settings such as the settings for POP authentication before sending or for encrypted communication. [▶Configuring E-Mail Communication Settings\(P. 363\)](#)

1 Start the Send Function Setting Tool.

■ Using a Web browser

Enter "http://<the IP address of the machine>/sendsupport_login.html" in the address field of a Web browser, and press the [ENTER] key.

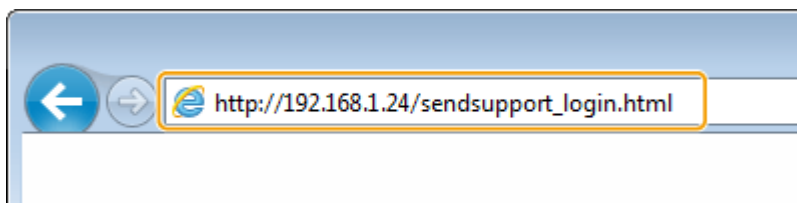

■ Using the provided DVD-ROM

- 1 Insert the provided DVD-ROM into the drive on the computer.
 - Select a language and click [OK] if you are prompted to do so.
- 2 Click [Start Software Programs].

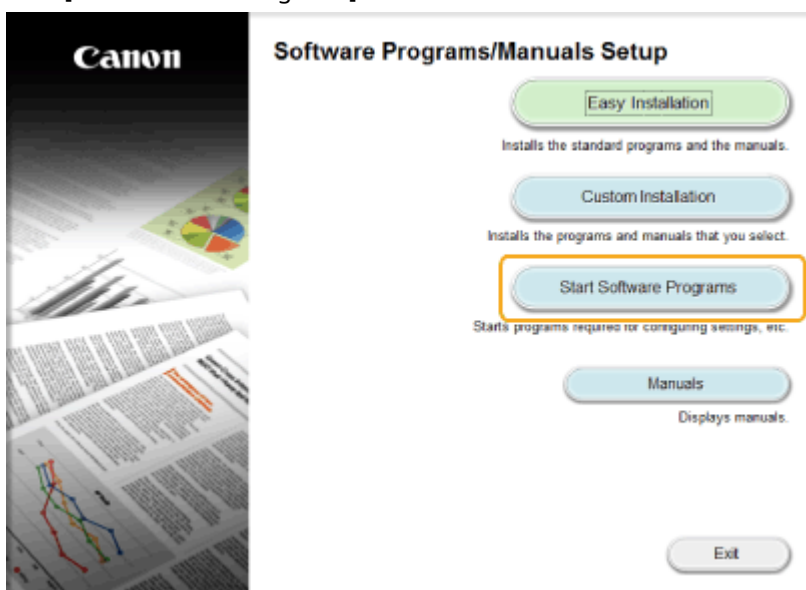

NOTE:

- If the above screen is not displayed, see [▶Displaying the \[Software Programs/Manuals Setup\] Screen\(P. 665\)](#) .

- If [AutoPlay] is displayed, click [Run MInst.exe].
- 3** Click [Start] for [Send Function Setting Tool].
- 4** Click [Next].
- If you want to view "Send Setting Guide," click [How to Set].

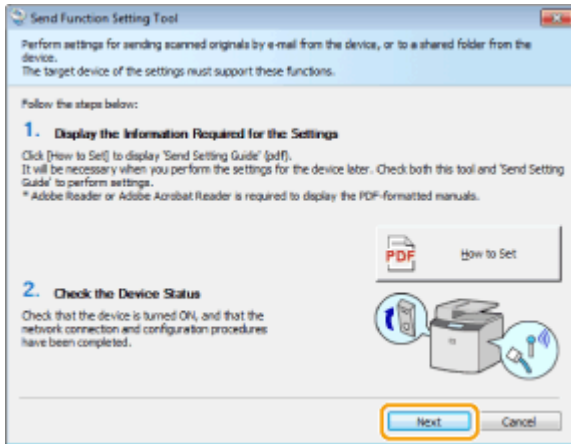

NOTE:

If the screen below appears

- Click [Yes].

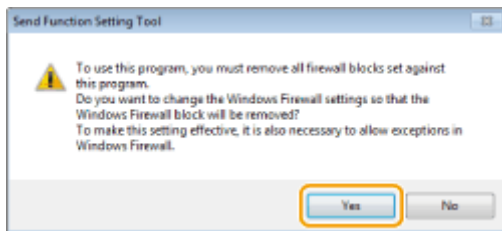

- 5** Select the machine from [Device List] and click [Next].

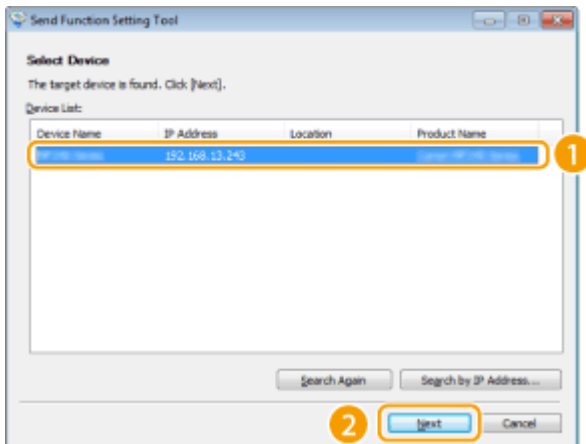

NOTE:

If the machine is not displayed in [Device List]

- Click [Search Again]. If the problem persists, click [Search by IP Address], enter the IP address of the machine, and then click [OK].

- 6** Confirm the settings and click [OK].

- 2** Click [Start].

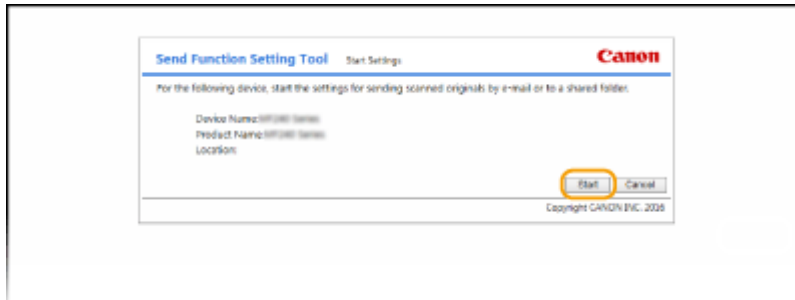

- If the logon screen is displayed, enter the appropriate PIN, and click [Logon].

3 Click [Send to E-mail Settings].

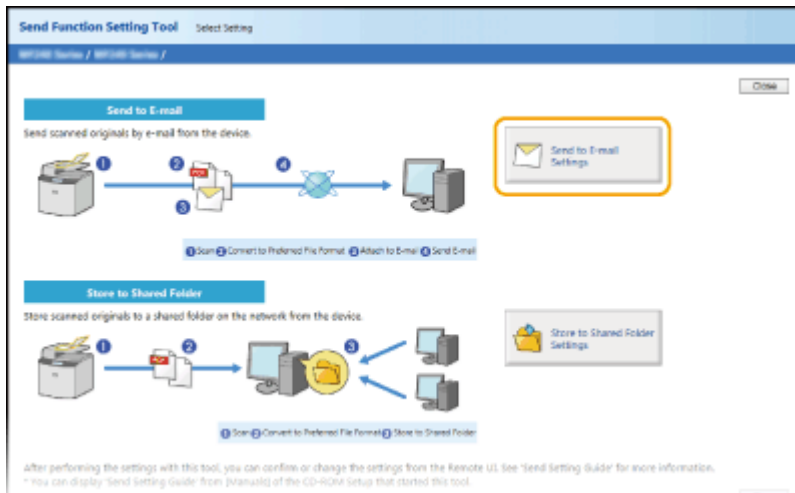

- If the screen prompting you to enter the Address Book PIN is displayed, enter the PIN for the Address Book, and click [OK]. **▶Setting a PIN for Address Book(P. 415)**

4 Specify the required settings.

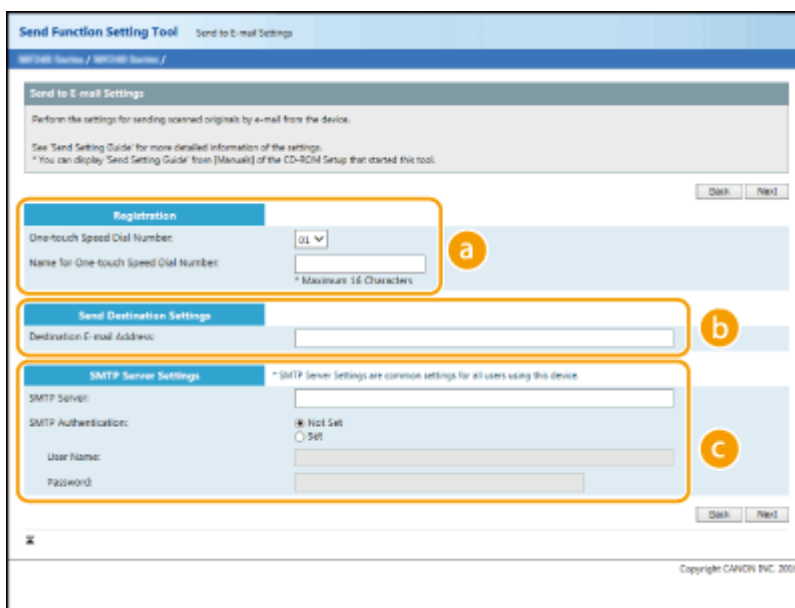

a [Registration]

[One-touch Speed Dial Number]

With the Send Function Setting Tool, you can register an e-mail address into <One-Touch> in the Address Book. Select a number from the drop-down list.

[Name for One-touch Speed Dial Number]

Enter the name for identifying the destination to be registered. Set a name that will be easy for you to find later in the Address Book.

b [Send Destination Settings]**[Destination E-mail Address]**

Enter the e-mail address that you want to send your scanned documents to.

c [SMTP Server Settings]**[SMTP Server]**

Enter the SMTP server name.

[SMTP Authentication]

Click the [Not Set] or [Set] radio button to match the authentication settings of the SMTP server. When [Set] is selected, enter the user name in the [User Name] text box and password in the [Password] text box.

NOTE:**Authentication methods for sending e-mails**

- To prevent e-mail transmissions by unauthorized users, the machine supports SMTP authentication (SMTP AUTH) and POP before SMTP. For more information about the required authentication method, contact your Internet service provider or Network Administrator.
- POP before SMTP authentication can only be configured by using the Remote UI. [▶Configuring E-Mail Communication Settings\(P. 363\)](#)

5 Click [Next].**6 Confirm the settings and click [Register].****7 Restart the machine.**

- Turn OFF the machine, wait for at least 10 seconds, and turn it back ON.

IMPORTANT

Additional settings may be required depending on the network you are using. For more information, contact your Internet service provider or Network Administrator.

- To enable TLS for e-mailing, see [▶Configuring E-Mail Communication Settings\(P. 363\)](#) .
- To change port numbers, see [▶Changing Port Numbers \(MF249dw / MF246dn / MF237w\)\(P. 409\)](#) .

LINKS

- ▶[Configuring Scan Settings \(Sending E-Mail\)\(P. 358\)](#)
- ▶[Sending Documents as E-Mails Directly from the Machine\(P. 246\)](#)
- ▶[Registering in the Address Book\(P. 60\)](#)

Configuring E-Mail Communication Settings

14L7-06Y

Use the Remote UI to configure the detailed send settings, such as the settings for POP authentication and encryption of communication before you send e-mail. Contact your provider or network administrator for the required settings.

1 Start the Remote UI and log on in System Manager Mode. ▶Starting Remote UI(P. 450)

2 Click [Settings/Registration].

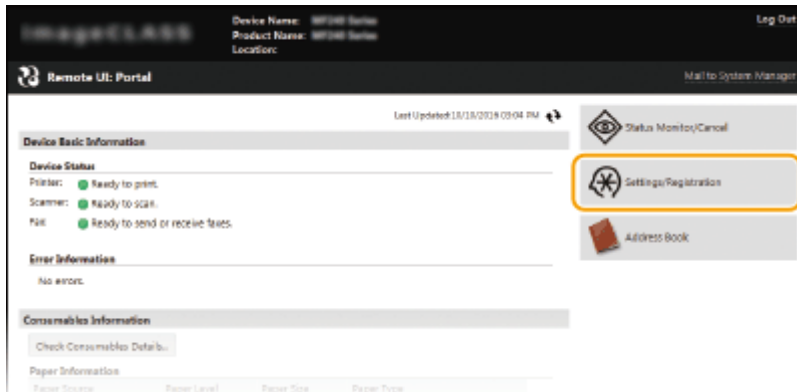

3 Click [Network Settings] ▶ [E-Mail Settings].

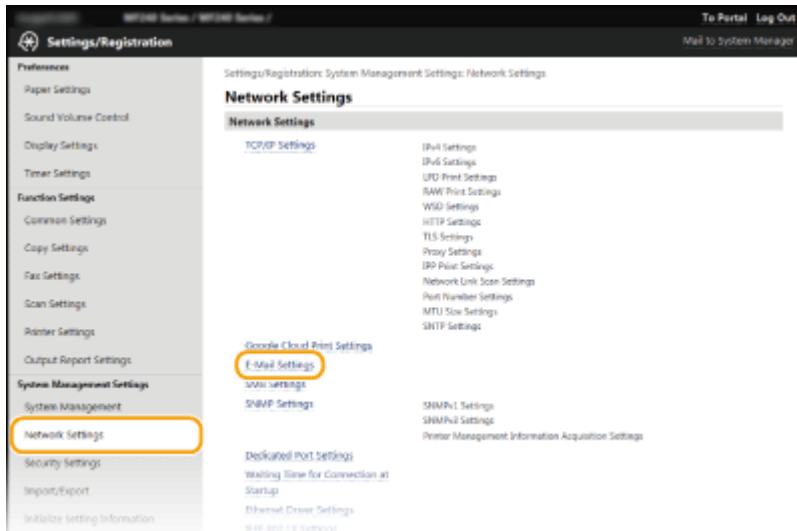

4 Click [Edit].

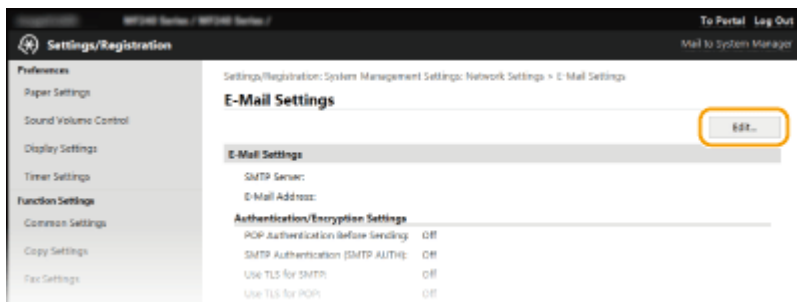

5 Specify the required settings.

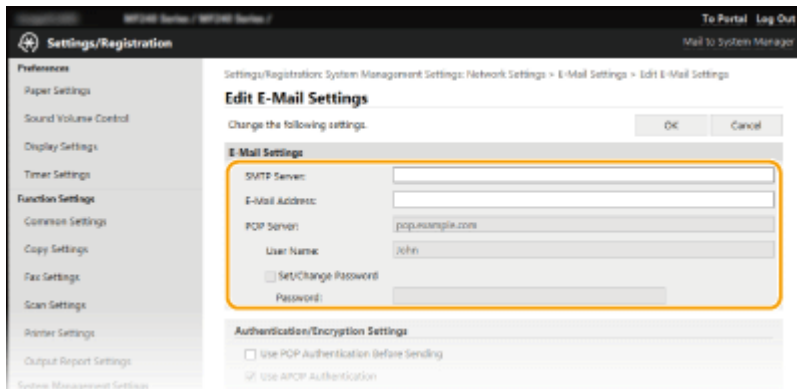

[SMTP Server]

Enter up to 48 alphanumeric characters as the SMTP server name (or IP address) for sending e-mail.

[E-Mail Address]

Enter up to 120 characters for the e-mail address that you want to use for the machine.

[POP Server]

Enter up to 48 alphanumeric characters as the SMTP server name or IP address for sending e-mail.

[User Name]

Enter up to 64 alphanumeric characters as the user name for the specified e-mail account when a POP3 server is used.

[Set/Change Password]

To set or change the password when a POP3 server is used, select this check box and enter up to 32 alphanumeric characters in [Password].

■ Configuring Pop Authentication before Sending

POP before SMTP authentication prevents unauthorized users from using e-mail by performing user authentication on the POP3 server.

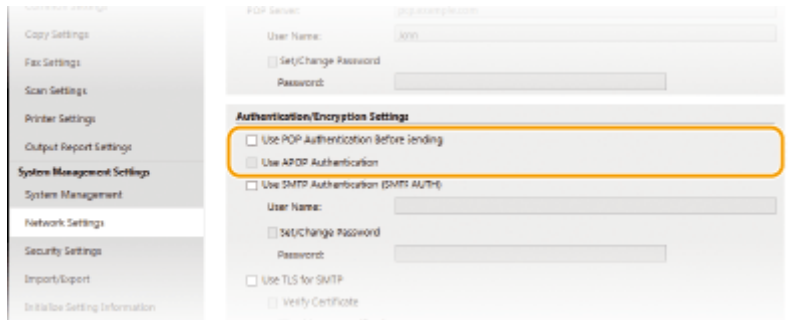

[Use POP Authentication Before Sending]

To use the POP3 server for authentication before you send e-mail, select the check box.

[Use APOP Authentication]

Select the check box to use APOP to encrypt the password during the authentication process.

■ Configuring SMTP authentication

If you configure SMTP authentication (SMTP AUTH), user identification by user name and password is performed at the time of sending e-mail.

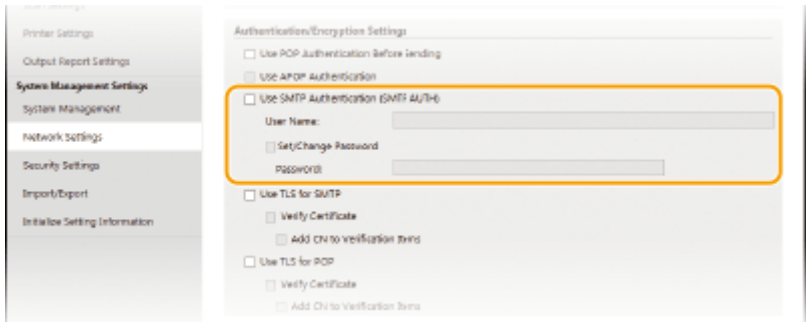

[Use SMTP Authentication (SMTP AUTH)]

To enable authentication on the SMTP server, select the check box and enter up to 64 characters in the [User Name] text box.

[Set/Change Password]

To specify or change the password, enter up to 32 characters in the [Password] text box.

■ Configuring encrypted communication

You can configure encryption of communication with an SMTP or POP3 server.

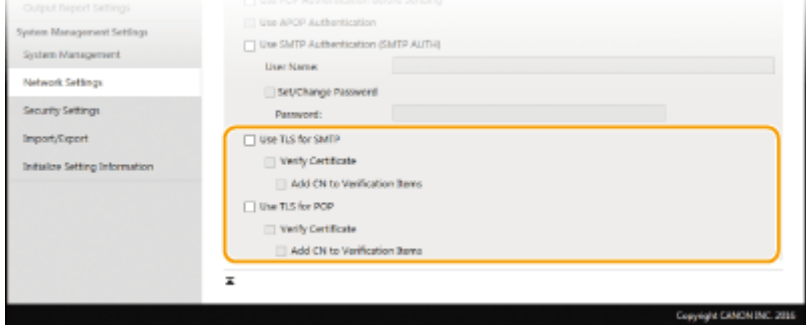

[Use TLS for SMTP]

Select the check box to use TLS for encrypting communication with the SMTP server. Select the check box for [Verify Certificate] or [Add CN to Verification Items] depending on your needs.

[Use TLS for POP]

Select the check box to encrypt communication with the POP3 server using TLS. Select the [Verify Certificate] and [Add CN to Verification Items] check boxes as required.

6 Click [OK].

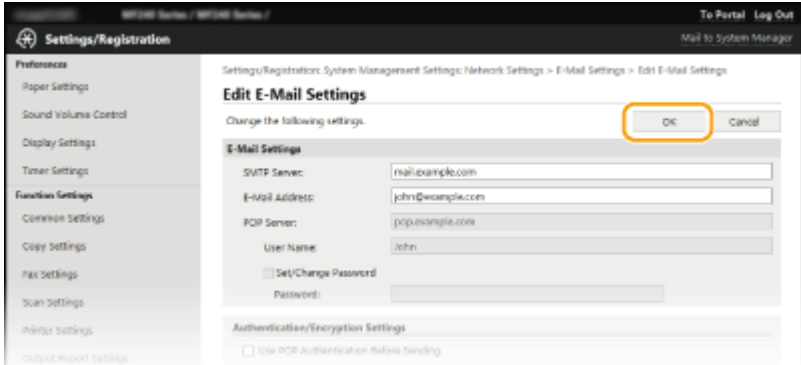

IMPORTANT

- Depending on the network you are using, you may need to change the SMTP or POP3 port setting (**Changing Port Numbers (MF249dw / MF246dn / MF237w)(P. 409)**). For more information, contact your Internet service provider or Network Administrator.

LINKS

- ▶ **Configuring Scan Settings (Sending E-Mail)(P. 358)**
- ▶ **Configuring Basic E-Mail Settings(P. 359)**
- ▶ **Sending Documents as E-Mails Directly from the Machine(P. 246)**

Configuring the Machine for Scanning to Shared Folders

14L7-070

Before configuring the machine for scanning to shared folders, check the setup flow shown below.

1



Make sure that the machine and the computer are correctly connected.

▶ **Connecting to a Wireless LAN (MF249dw / MF237w)(P. 319)**

▶ **Connecting to a Wired LAN(P. 318)**



2



Make sure that you have the following information:

- The IP address of the machine. ▶ **Viewing Network Settings(P. 344)**
- The name of the computer where the shared folder is located. ▶ **Checking the Computer Name(P. 668)**
- Path to and the name of the shared folder (If access restrictions are set to the folder, the user name and password information is also needed).

NOTE:

- For instructions on how to create a new shared folder, see "Send Setting Guide."



3



Make sure that the computer meets the following system requirements for the Send Function Setting Tool:

- **Operating system**
Windows Vista/7/8/10/Server 2008/Server 2012
- **Web browser**
Microsoft Internet Explorer 7.0 or later
- **Display**
SVGA monitor (with at least 800 x 600 pixel screen resolution) that supports at least 256 colors

NOTE:

- Also make sure that <Use HTTP> and <Use Remote UI> are set to <On>.
 - ▶ **Disabling HTTP Communication (MF249dw / MF246dn / MF237w)(P. 423)**
 - ▶ **Disabling Remote UI (MF249dw / MF246dn / MF237w)(P. 424)**



4



Set the machine configuration. ▶ **Setting a Shared Folder as a Save Location(P. 368)**

Setting a Shared Folder as a Save Location

14L7-071

The feature of scanning to shared folders is also called "Scan to SMB" because the feature uses Server Message Block (SMB), a Windows-specific technology. SMB is a protocol for sharing resources, such as files and printers, with more than one device in a network (**Configuring SMB (MF249dw / MF246dn)(P. 382)**). To configure the machine for saving your scanned documents into a shared folder in the network via SMB, specify the location of the shared folder from a computer in advance. This section describes how to specify the save location by using the Send Function Setting Tool.

NOTE

- You can also use the Remote UI to specify the location of the shared folder as save destination by registering the folder to the Address Book. **Registering Address Book from Remote UI(P. 467)**

1 Start the Send Function Setting Tool.

■Using a Web browser

Enter "http://<the IP address of the machine>/sendsupport_login.html" in the address field of a Web browser, and press the [ENTER] key.

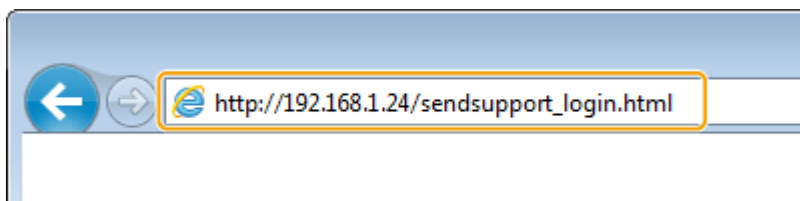

■Using the provided DVD-ROM

- 1 Insert the provided DVD-ROM into the drive on the computer.
 - Select a language and click [OK] if you are prompted to do so.
- 2 Click [Start Software Programs].

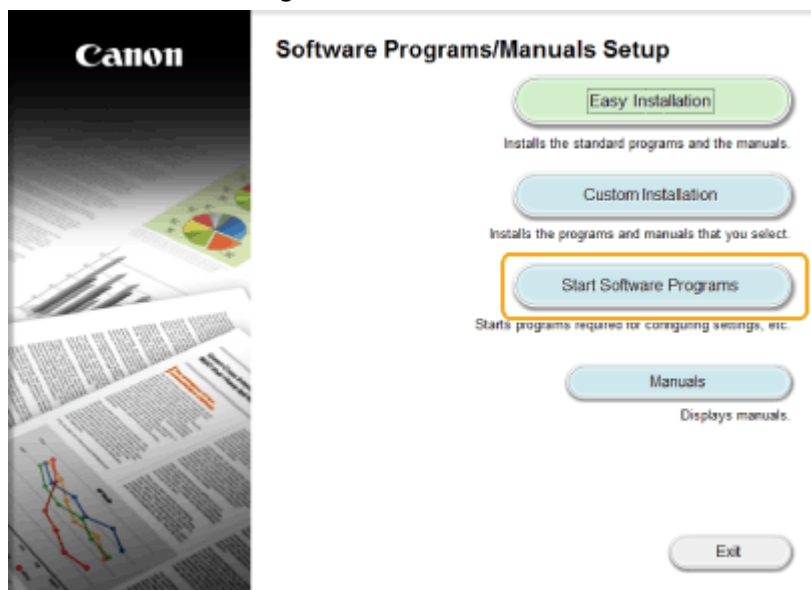

NOTE:

- If the above screen is not displayed, see **▶Displaying the [Software Programs/Manuals Setup] Screen(P. 665)** .
- If [AutoPlay] is displayed, click [Run MInst.exe].

3 Click [Start] for [Send Function Setting Tool].

4 Click [Next].

- If you want to view "Send Setting Guide," click [How to Set].

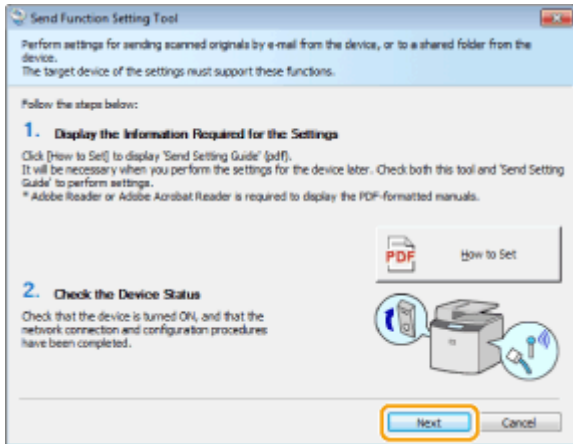

NOTE:

If the screen below appears

- Click [Yes].

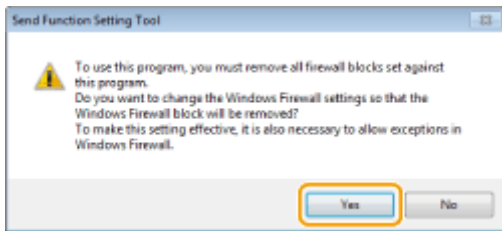

5 Select the machine from [Device List] and click [Next].

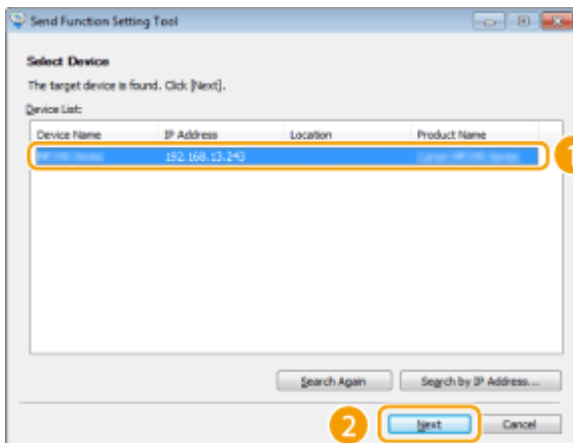

NOTE:

If the machine is not displayed in [Device List]

- Click [Search Again]. If the problem persists, click [Search by IP Address], enter the IP address of the machine, and then click [OK].

6 Confirm the settings and click [OK].

2 Click [Start].

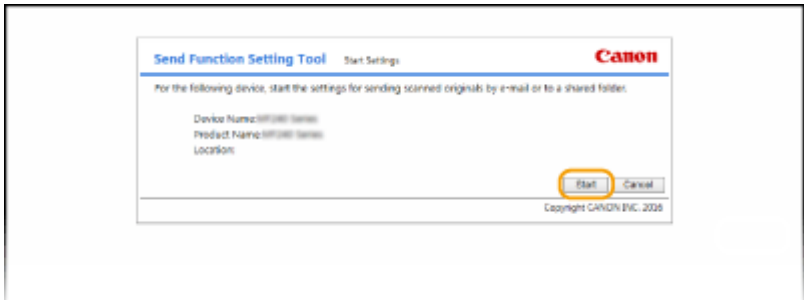

- If the logon screen is displayed, enter the appropriate PIN, and click [Logon].

3 Click [Store to Shared Folder Settings].

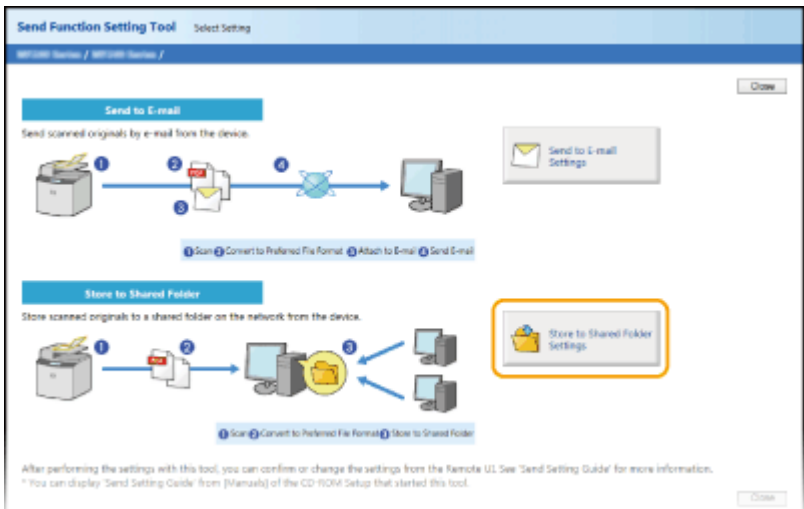

- If the screen prompting you to enter the Address Book PIN is displayed, enter the PIN for the Address Book, and click [OK]. **▶Setting a PIN for Address Book(P. 415)**

4 Specify the required settings.

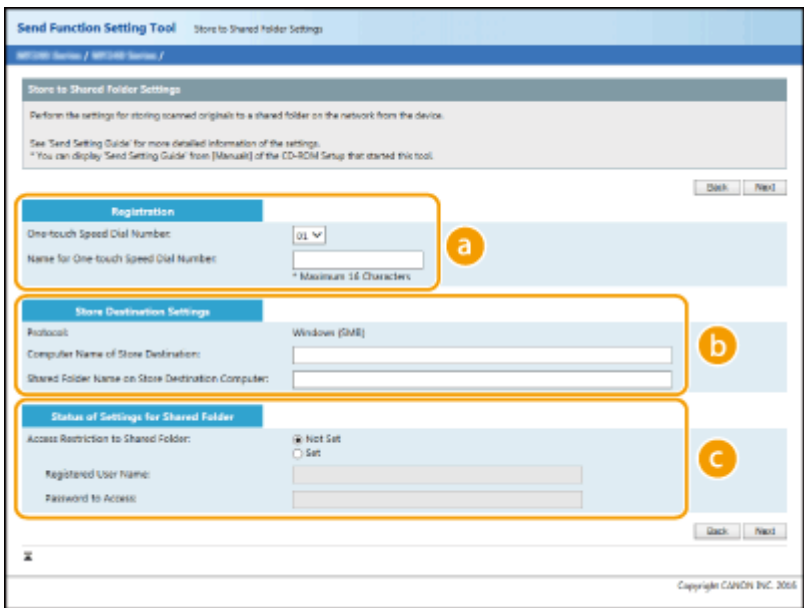

a [Registration]

[One-touch Speed Dial Number]

With the Send Function Setting Tool, you can register a shared folder for saving scanned documents into <One-Touch> in the Address Book. Select a number from the drop-down list.

[Name for One-touch Speed Dial Number]

Enter the name for identifying the destination to be registered. Set a name that will be easy for you to find later in the Address Book.

b [Store Destination Settings]

[Protocol]

The protocol that is used for sending scanned documents to a shared folder is displayed.

[Computer Name of Store Destination]

Enter the name or the IP address of the computer where the shared folder is located.

[Shared Folder Name on Store Destination Computer]

Enter the name of (or path to) the shared folder. For example, if the shared folder is a subfolder named "share" and is contained in the [Public] folder in drive C (path: C:\users\public\share), enter "users\public\share."

The screenshot shows a configuration window with two main sections. The top section, titled 'Store Destination Settings', contains three fields: 'Protocol' (Windows (SMB)), 'Computer Name of Store Destination' (Swan), and 'Shared Folder Name on Store Destination Computer' (users\public\share). The bottom section, titled 'Status of Settings for Shared Folder', contains a radio button selection for 'Access Restriction to Shared Folder', with 'Not Set' selected and 'Set' unselected.

c [Status of Settings for Shared Folder]

[Access Restriction to Shared Folder]

Click the [Not Set] or [Set] radio button to match the access restrictions set to the shared folder. When [Set] is selected, enter the user name in the [Registered User Name] text box and password in the [Password to Access] text box.

5 Click [Next].

6 Confirm the settings and click [Register].

7 Restart the machine.

- Turn OFF the machine, wait for at least 10 seconds, and turn it back ON.

LINKS

- ▶ **Configuring the Machine for Scanning to Shared Folders(P. 367)**
- ▶ **Saving Documents Directly in Shared Folder(P. 253)**

Configuring the Machine for Your Network Environment

14L7-072

The configuration of a network varies depending on the purpose of the network. Specify the settings necessary to suit your network environment.

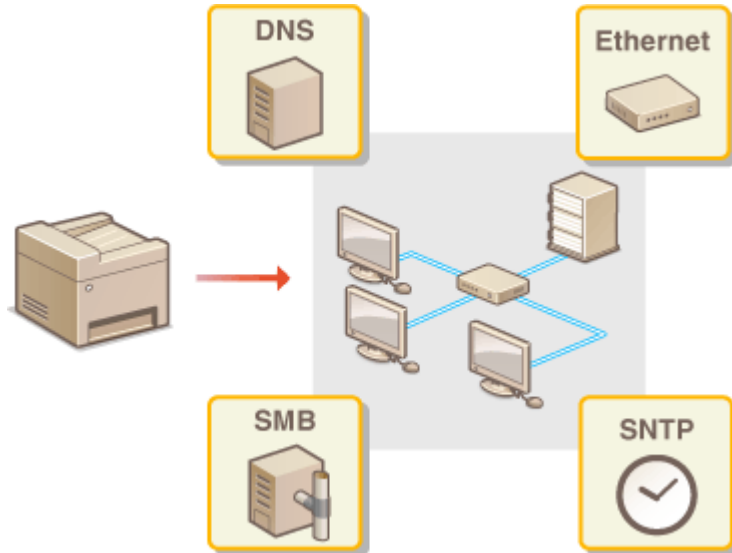

Configuring Ethernet Settings

14L7-073

Ethernet is a standard for communicating data in a local area network (LAN). You can set the communication mode (half-duplex/full-duplex) and the Ethernet type (10BASE-T/100BASE-TX). In general, the machine can be used without changing the defaults (**▶ Ethernet Driver Settings(P. 482)**), but you can change these settings to suit your network environment.

1 Tap **<Menu>** in the **<Home>** Screen.

2 Tap **<Network Settings>**.

- If a screen for entering a PIN is displayed, enter the PIN with the numeric keys and tap **<Apply>**. **▶ Setting the System Manager PIN(P. 397)**

3 Select **<Ethernet Driver Settings>** ▶ **<Auto Detect>**.

4 Select whether to configure Ethernet settings automatically or manually.

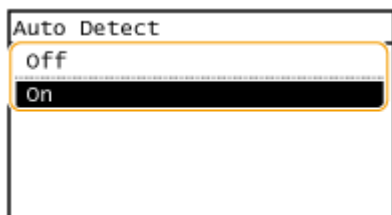

■ Configuring Ethernet settings automatically

Tap **<On>**. The machine detects and automatically sets the communication mode and the Ethernet type that can be used.

■ Configuring Ethernet settings manually

1 Tap **<Off>**.

2 Select the communication mode.

- Tap **<Communication Mode>** ▶ tap **<Half Duplex>** or **<Full Duplex>**.

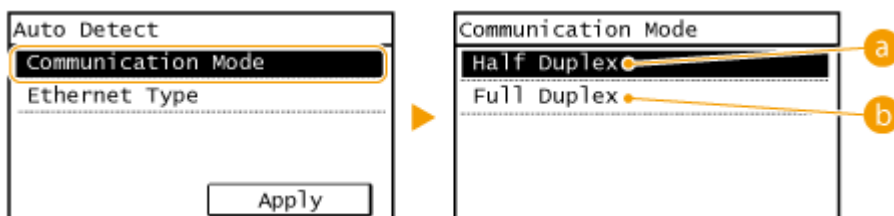

a **<Half Duplex>**

Alternately sends and receives communication data. Select when the machine is connected to a networking device using half duplex.

b **<Full Duplex>**

Simultaneously sends and receives communication data. Use this setting for most environments.

3 Select the Ethernet type.

- Tap <Ethernet Type> ► tap <10BASE-T> or <100BASE-TX>.

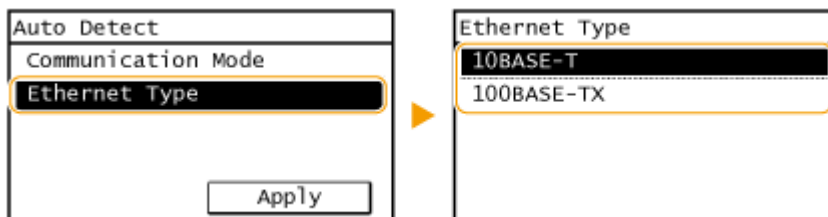
**4** Tap <Apply>.**LINKS**

- ▶ **Changing the Maximum Transmission Unit(P. 375)**
- ▶ **Setting a Wait Time for Connecting to a Network(P. 376)**

Changing the Maximum Transmission Unit

14L7-074

In most Ethernet networks, the maximum size of a packet that can be sent is 1500 bytes. A packet refers to a chunk of data into which the original data is divided before being sent. The maximum transmission unit (MTU) may vary on each network. Change the settings of the machine as necessary. For more information, contact your Network Administrator.

1 Tap <Menu> in the <Home> Screen.

2 Tap <Network Settings>.

- If a screen for entering a PIN is displayed, enter the PIN with the numeric keys and tap <Apply>. **▶Setting the System Manager PIN(P. 397)**

3 Select <TCP/IP Settings> ▶ <MTU Size>.

4 Select the MTU.

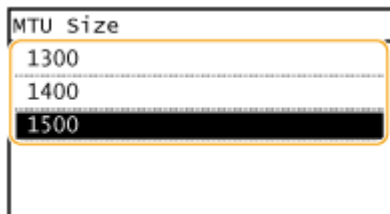

LINKS

- ▶**Configuring Ethernet Settings(P. 373)**
- ▶**Setting a Wait Time for Connecting to a Network(P. 376)**

Setting a Wait Time for Connecting to a Network

14L7-075

When a network is designed to enjoy redundant connectivity with multiple switching hubs or bridges, it must have a mechanism to prevent packets from looping. One effective solution is to define the role of each switch port. However, communication may still be disrupted for several tens of seconds immediately after you change the way that network devices are connected, or if you add a new device. If this type of problem occurs, set a wait time for connecting to the network.

1 Tap <Menu> in the <Home> Screen.

2 Tap <Network Settings>.

- If a screen for entering a PIN is displayed, enter the PIN with the numeric keys and tap <Apply>. [▶Setting the System Manager PIN\(P. 397\)](#)

3 Tap <Waiting Time for Connection at Startup>.

4 Enter the wait time in seconds, and tap <Apply>.

- Use ▲ / ▼ or the numeric keys to enter the time.

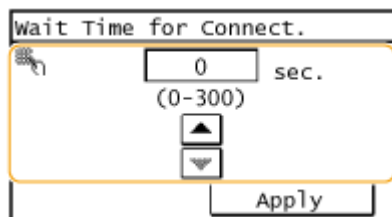

LINKS

- ▶[Configuring Ethernet Settings\(P. 373\)](#)
- ▶[Changing the Maximum Transmission Unit\(P. 375\)](#)

Configuring DNS

14L7-076

DNS (Domain Name System) provides a service for name resolution that associates a host (or domain) name with an IP address. Configure the DNS, mDNS, or DHCP option settings as necessary. Note that the procedures for configuring DNS are different for IPv4 and IPv6.

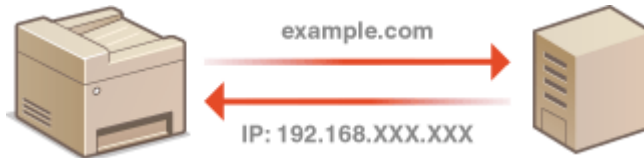

- 1 Start the Remote UI and log on in System Manager Mode. ▶ Starting Remote UI(P. 450)
- 2 Click [Settings/Registration].

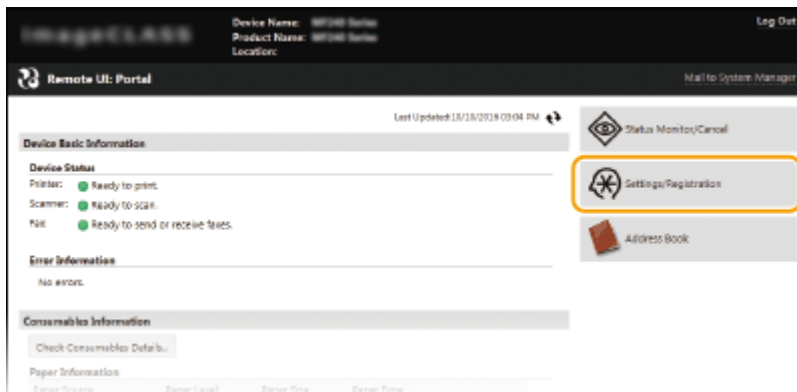

- 3 Click [Network Settings] ▶ [TCP/IP Settings].

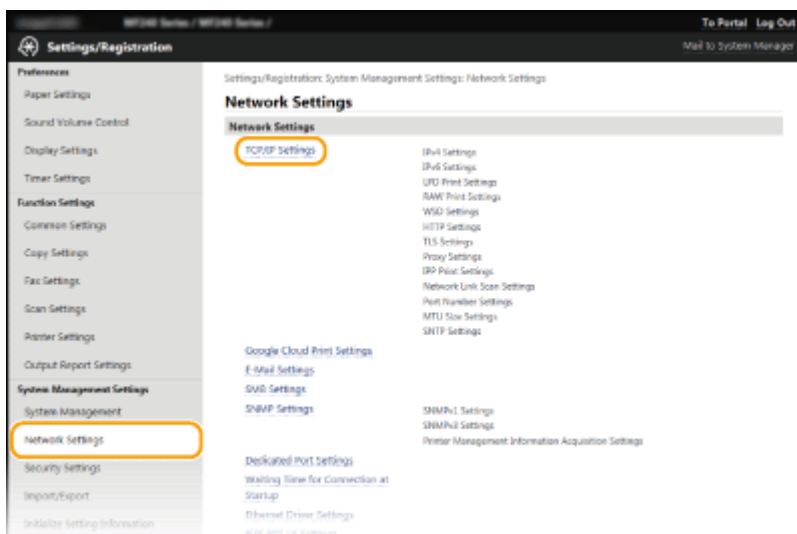

- 4 Configure DNS settings.

■ Configuring IPv4 DNS

- 1 Click [Edit] in [IPv4 Settings].

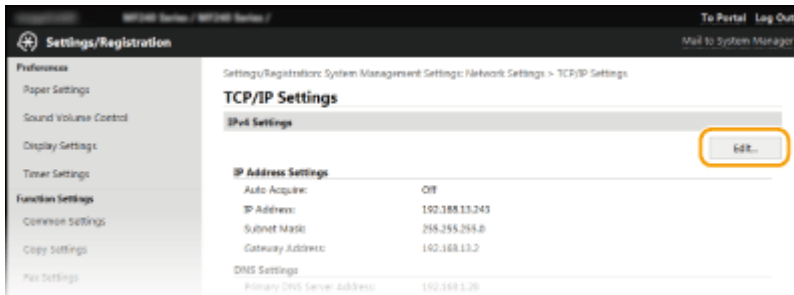

- 2 Configure IPv4 DNS settings.

- Settable options vary depending on the machine model.

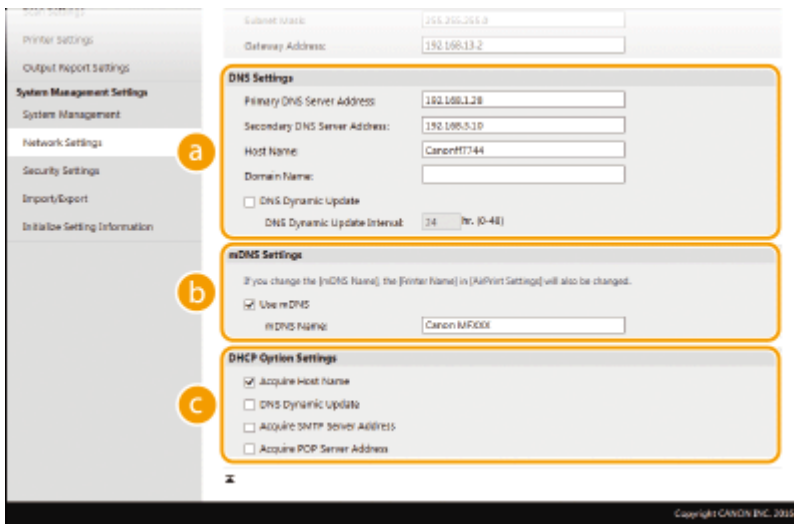

a [DNS Settings]

[Primary DNS Server Address]

Enter the IP address of a DNS server.

[Secondary DNS Server Address]

Enter the IP address of a secondary DNS server, if any.

[Host Name]

Enter up to 47 alphanumeric characters for the host name of the machine that is to be registered to the DNS server.

[Domain Name]

Enter up to 47 alphanumeric characters for the name of the domain the machine belongs to, such as "example.com."

[DNS Dynamic Update]

Select the check box to dynamically update the DNS records whenever the machine's IP address is changed. When specifying the interval between updates, enter the time in hours in the [DNS Dynamic Update Interval] text box.

b [mDNS Settings]

[Use mDNS]

Adopted by Bonjour, mDNS (multicast DNS) is a protocol for associating a host name with an IP address without using DNS. Select the check box to enable mDNS and enter the mDNS name in the [mDNS Name] text box.

c [DHCP Option Settings]

[Acquire Host Name]

Select the check box to enable Option 12 to obtain the host name from the DHCP server.

[DNS Dynamic Update]

Select the check box to enable Option 81 to dynamically update the DNS records through the DHCP server.

[Acquire SMTP Server Address] (MF249dw / MF246dn)

Select the check box to enable Option 69 to obtain an SMTP server address from the DHCP server.

[Acquire POP Server Address] (MF249dw / MF246dn)

Select the check box to enable Option 70 to obtain a POP3 server address from the DHCP server.

3 Click [OK].

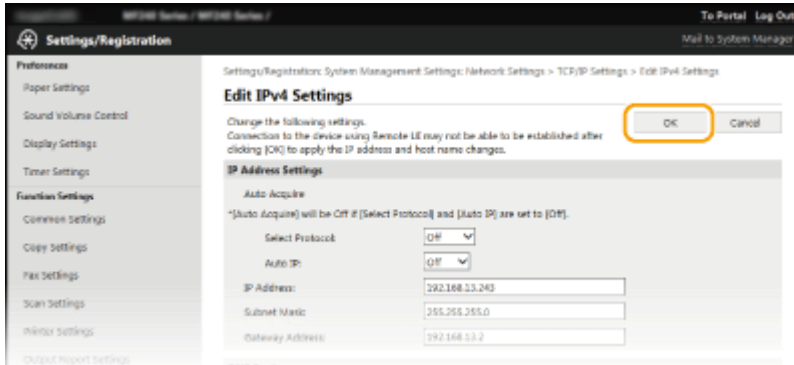

■ Configuring IPv6 DNS

1 Click [Edit] in [IPv6 Settings].

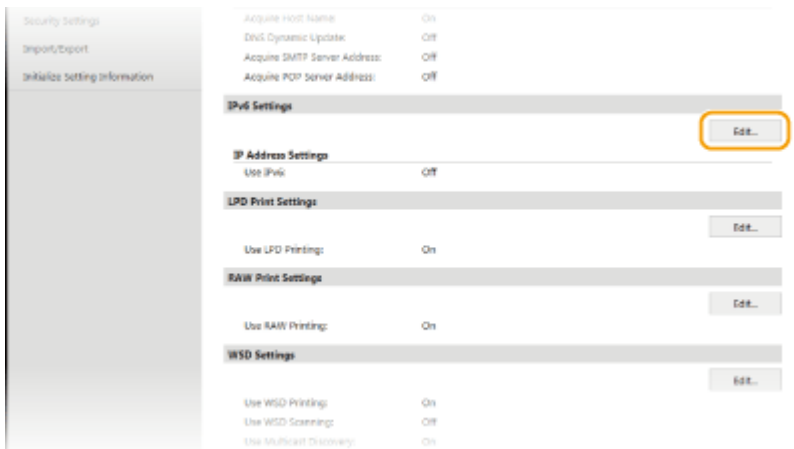

2 Configure IPv6 DNS settings.

- The [Use IPv6] check box must be selected to configure the settings. **▶ Setting IPv6 Addresses(P. 340)**

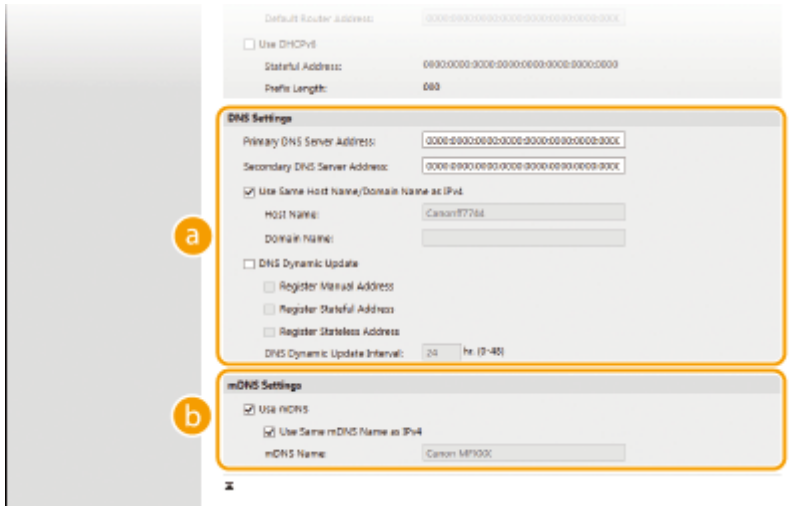

a [DNS Settings]

[Primary DNS Server Address]

Enter the IP address of a DNS server. Addresses that start with "ff" (or multicast address) cannot be entered.

[Secondary DNS Server Address]

Enter the IP address of a secondary DNS server, if any. Addresses that start with "ff" (or multicast address) cannot be entered.

[Use Same Host Name/Domain Name as IPv4]

Select the check box to use the same host and domain names as in IPv4.

[Host Name]

Enter up to 47 alphanumeric characters for the host name of the machine that is to be registered to the DNS server.

[Domain Name]

Enter up to 47 alphanumeric characters for the name of the domain the machine belongs to, such as "example.com."

[DNS Dynamic Update]

Select the check box to dynamically update the DNS records whenever the machine's IP address is changed. To specify the type(s) of addresses you want to register to the DNS server, select the check box for [Register Manual Address], [Register Stateful Address], or [Register Stateless Address]. To specify the interval between updates, enter the time in hours in the [DNS Dynamic Update Interval] text box.

b [mDNS Settings]

[Use mDNS]

Adopted by Bonjour, mDNS (multicast DNS) is a protocol for associating a host name with an IP address without using DNS. Select the check box to enable mDNS.

[Use Same mDNS Name as IPv4]

Select the check box to use the same mDNS name as in IPv4. To set a different name, clear the check box and enter the mDNS name in the [mDNS Name] text box.

3 Click [OK].

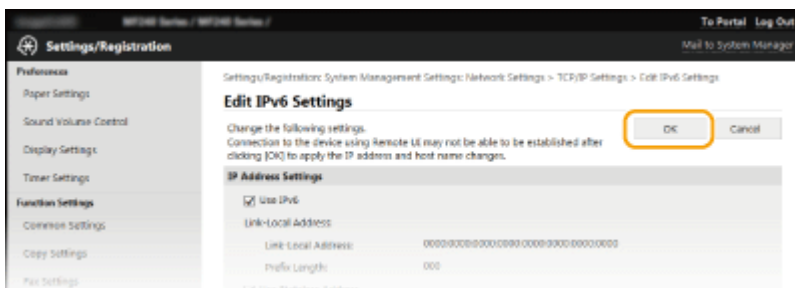

NOTE

Using the operation panel

DNS settings can also be accessed from <Menu> in the <Home> Screen. ▶ [IPv4 Settings\(P. 476\)](#) ▶ [IPv6 Settings\(P. 477\)](#)

LINKS

- ▶ [Setting IPv4 Address\(P. 337\)](#)
- ▶ [Setting IPv6 Addresses\(P. 340\)](#)
- ▶ [Viewing Network Settings\(P. 344\)](#)

Configuring SMB MF249dw / MF246dn

14L7-077



Server Message Block (SMB) is a protocol for sharing resources, such as files and printers, with more than one device in a network. The machine uses SMB to store scanned documents into a shared folder. Depending on your network, you may have to set the NetBIOS name and workgroup name.

NetBIOS Name

In a Windows network that uses NetBIOS, NetBIOS names are used for identifying network-connected computers as well as for file sharing and other network services. Most computers use the computer name as the NetBIOS name.

Workgroup Name

Workgroup name is a name for grouping multiple computers so that basic network functions, such as file sharing, become available in a Windows network. Specify the workgroup name to identify the group that the machine belongs to.

- 1 Start the Remote UI and log on in System Manager Mode. ▶ Starting Remote UI(P. 450)**
- 2 Click [Settings/Registration].**

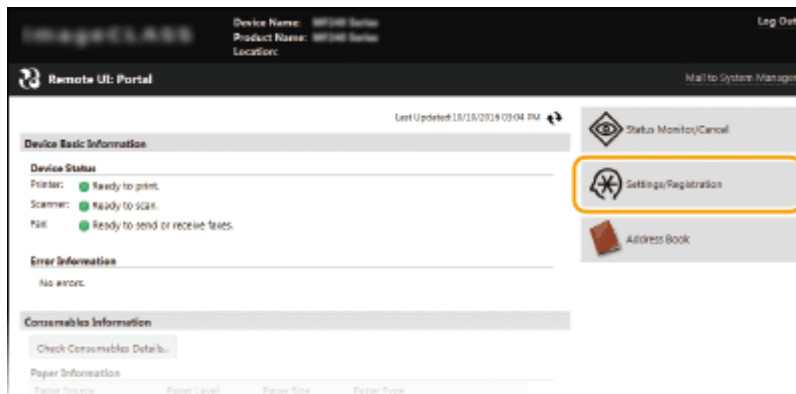

- 3 Click [Network Settings] ▶ [SMB Settings].**

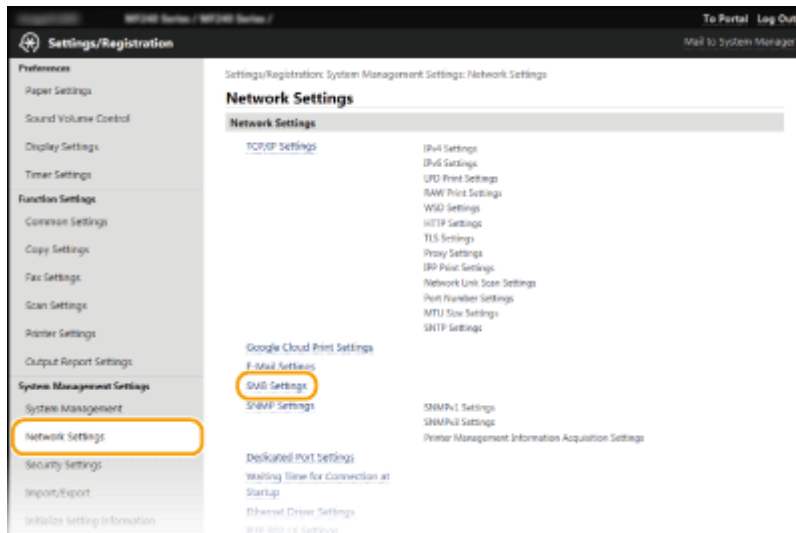

4 Click [Edit].

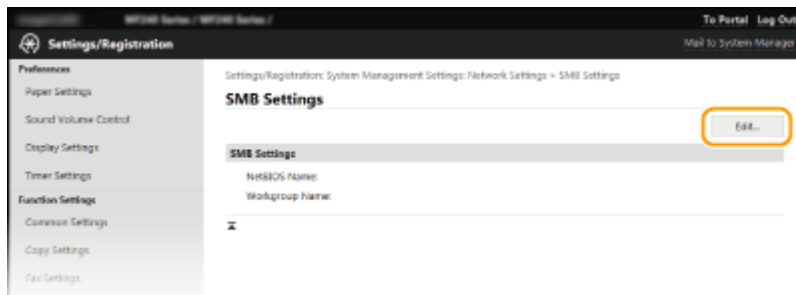

5 Specify the required settings and click [OK].

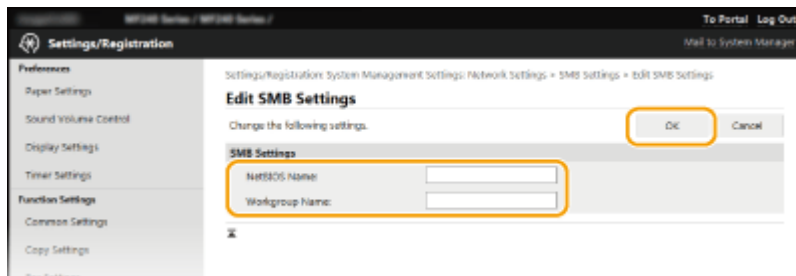

[NetBIOS Name]

Enter up to 15 alphanumeric characters for the NetBIOS name of the machine.

[Workgroup Name]

Enter up to 15 alphanumeric characters for the name of the workgroup that the machine belongs to.

Configuring SNTP

14L7-078



Simple Network Time Protocol (SNTP) enables you to adjust the system clock by using the time server on the network. The protocol is typically used for synchronizing the machine and a server. The time is adjusted based on Coordinated Universal Time (UTC), so specify the time zone setting before configuring SNTP (**▶Date/Time Settings(P. 488)**). SNTP settings can be specified via the Remote UI.

NOTE

- The SNTP of the machine supports both NTP (version 3) and SNTP (versions 3 and 4) servers.

1 Start the Remote UI and log on in System Manager Mode. ▶Starting Remote UI(P. 450)

2 Click [Settings/Registration].

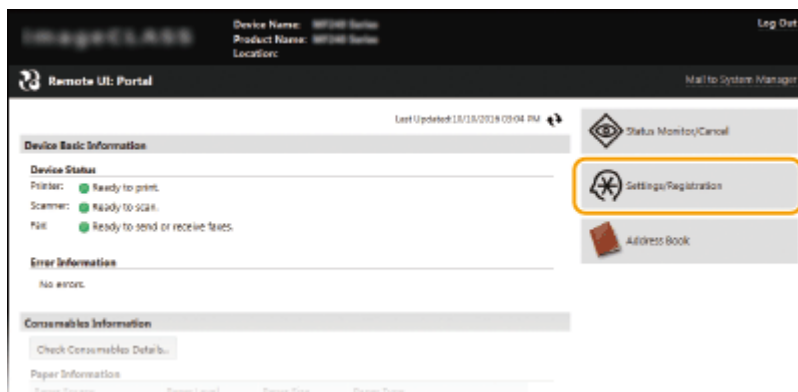

3 Click [Network Settings] ▶ [TCP/IP Settings].

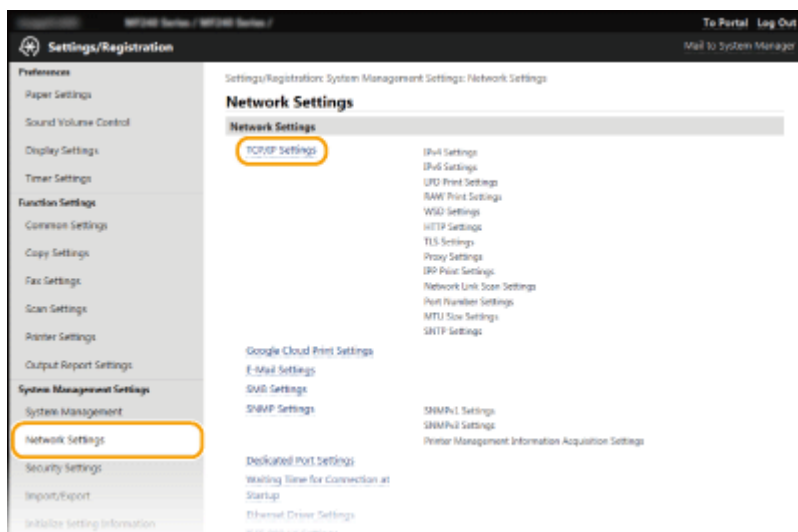

4 Click [Edit] in [SNTP Settings].

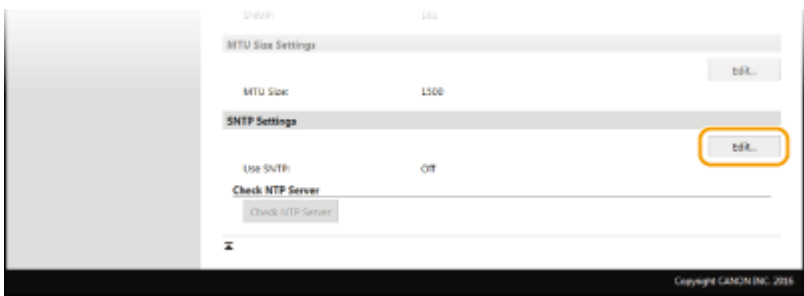

5 Select the [Use SNTP] check box and specify the required settings.

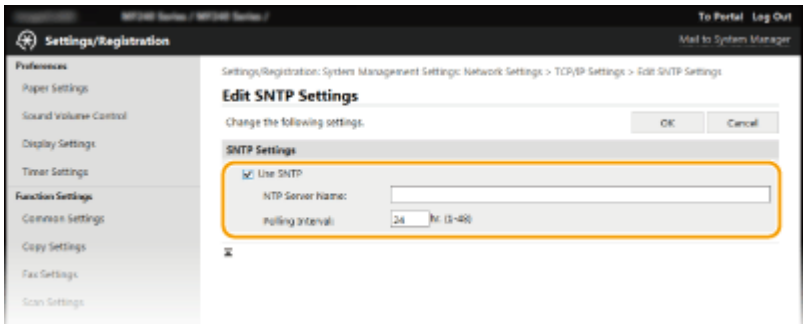

[Use SNTP]

Select the check box to use SNTP for synchronization. If you do not want to use SNTP, clear the check box.

[NTP Server Name]

Enter the IP address of the NTP or the SNTP server. If DNS is available on the network, you can enter a host name (or FQDN) of up to 255 alphanumeric characters instead (example: ntp.example.com).

[Polling Interval]

Specify the interval between one synchronization and the next. Specify an interval from 1 to 48 hours.

6 Click [OK].

NOTE

Testing communication with the NTP/SNTP server

- You can view communication status with the registered server by clicking [Settings/Registration] ► [Network Settings] ► [TCP/IP Settings] and then clicking [Check NTP Server] in [SNTP Settings] that appears. If a proper connection has been established, the result is displayed as shown below. Note that this operation does not adjust the system clock.

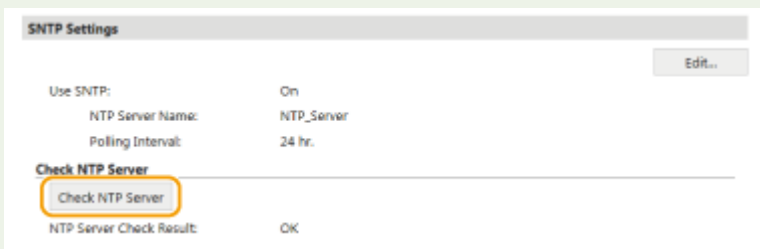

Monitoring and Controlling the Machine with SNMP

14L7-079

Simple Network Management Protocol (SNMP) is a protocol for monitoring and controlling communication devices in a network by using Management Information Base (MIB). The machine supports SNMPv1 and security-enhanced SNMPv3. You can check the status of the machine from a computer when you print documents or use the Remote UI. You can enable either SNMPv1 or SNMPv3, or both at the same time. Specify the settings for each version to suit your network environment and the purpose of use.

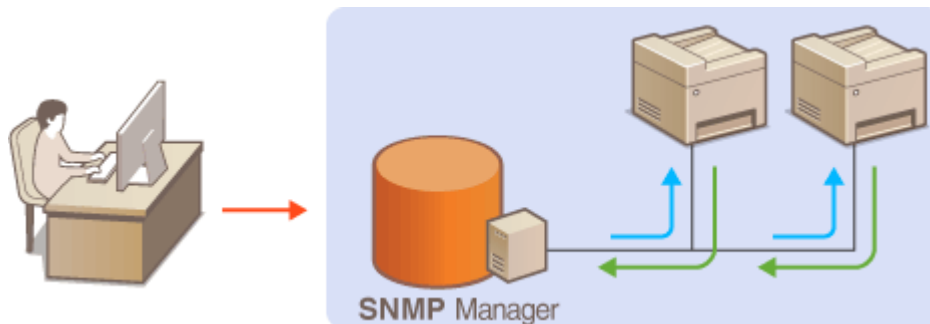

SNMPv1

SNMPv1 uses information called "community" to define the scope of SNMP communication. Because this information is exposed to the network in plain text, your network will be vulnerable to attacks. If you want to ensure network security, disable SNMPv1 and use SNMPv3.

SNMPv3

With SNMPv3, you can implement network device management that is protected by robust security features. Note that TLS must be enabled for the Remote UI before configuring SNMPv3 ([▶Enabling TLS Encrypted Communication for the Remote UI\(P. 426\)](#)).

NOTE

- The machine does not support the trap notification feature of SNMP.
- To change the port number of SNMP, see [▶Changing Port Numbers \(MF249dw / MF246dn / MF237w\) \(P. 409\)](#) .
- SNMP management software, when installed on a computer on the network, enables you to configure, monitor, and control the machine remotely from the computer. For more information, see the instruction manuals for your management software.

1 Start the Remote UI and log on in System Manager mode. [▶Starting Remote UI\(P. 450\)](#)

2 Click [Settings/Registration].

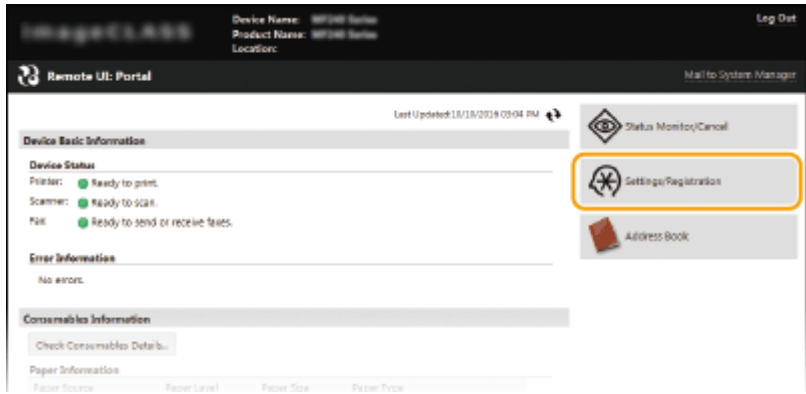

3 Click [Network Settings] ► [SNMP Settings].

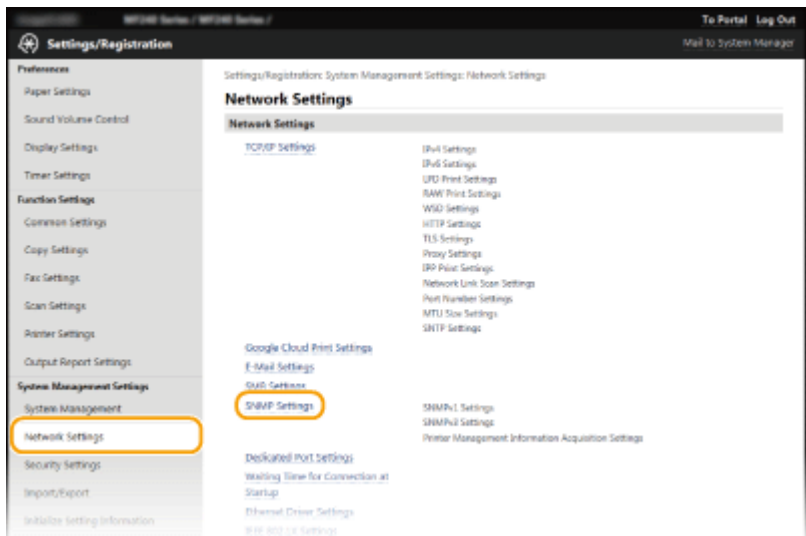

4 Click [Edit].

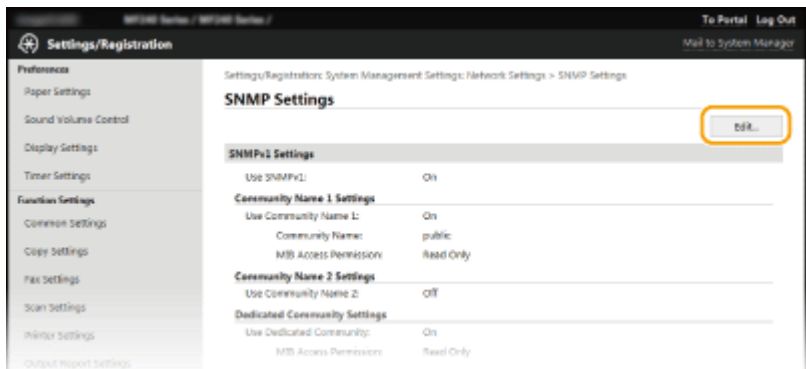

5 Specify SNMPv1 settings.

- If you do not need to change SNMPv1 settings, proceed to the next step.

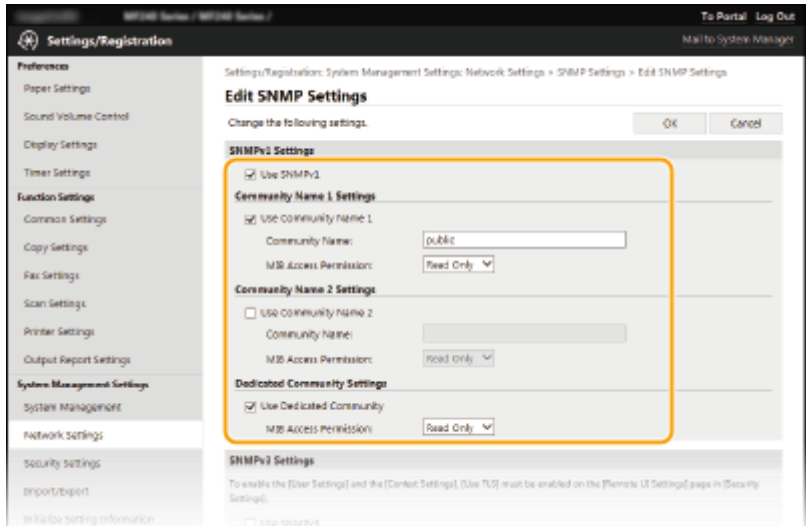

[Use SNMPv1]

Select the check box to enable SNMPv1. You can specify the rest of SNMPv1 settings only when this check box is selected.

[Use Community Name 1]/[Use Community Name 2]

Select the check box to specify a community name. If you do not need to specify a community name, clear the check box.

[Community Name]

Enter up to 32 alphanumeric characters for the name of the community.

[MIB Access Permission]

For each community, select [Read/Write] or [Read Only] for the access privileges to MIB objects.

[Read/Write]	Permits both viewing and changing the values of MIB objects.
[Read Only]	Permits only viewing the values of MIB objects.

[Use Dedicated Community]

Dedicated Community is a preset community, intended exclusively for Administrators using Canon software. Select the check box to use Dedicated Community. If you do not need to use Dedicated Community, clear the check box.

6 Specify SNMPv3 settings.

- If you do not need to change SNMPv3 settings, proceed to the next step.

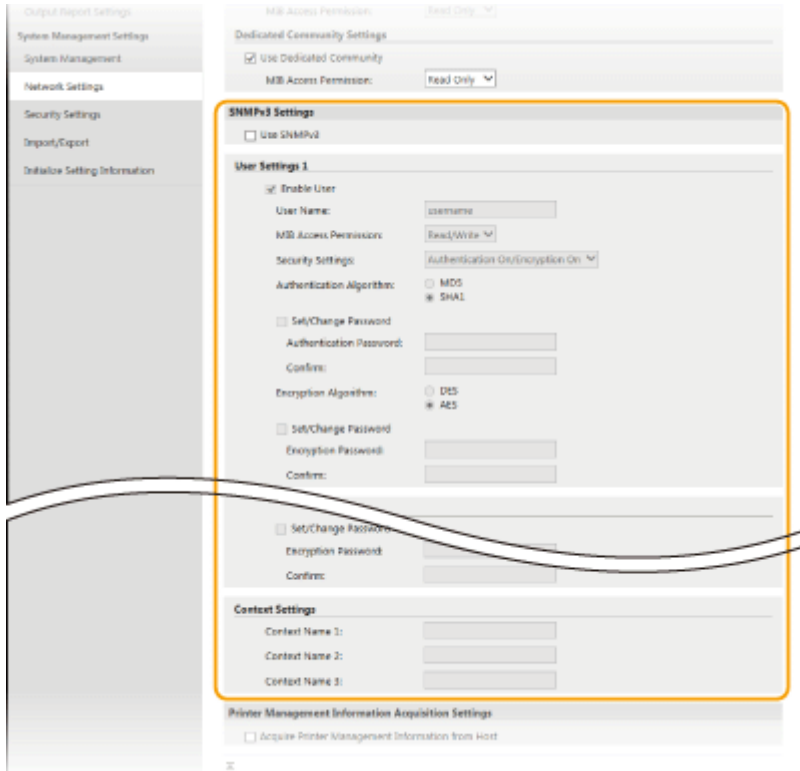

[Use SNMPv3]

Select the check box to enable SNMPv3. You can specify the rest of SNMPv3 settings only when this check box is selected.

[Enable User]

Select the check box to enable [User Settings 1]/[User Settings 2]/[User Settings 3]. To disable user settings, clear the corresponding check box.

[User Name]

Enter up to 32 alphanumeric characters for the user name.

[MIB Access Permission]

Select [Read/Write] or [Read Only] for the access privileges to MIB objects.

[Read/Write]	Permits both viewing and changing the values of MIB objects.
[Read Only]	Permits only viewing the values of MIB objects.

[Security Settings]

Select [Authentication On/Encryption On], [Authentication On/Encryption Off], or [Authentication Off/Encryption Off] for the desired combination of authentication and encryption settings.

[Authentication Algorithm]

If you selected [Authentication On/Encryption On] or [Authentication On/Encryption Off] for [Security Settings], select the algorithm that corresponds to your environment.

[Encryption Algorithm]

If you selected [Authentication On/Encryption On] for [Security Settings], select the algorithm that corresponds to your environment.

[Set/Change Password]

To set or change the password, select the check box and enter between 6 and 16 alphanumeric characters for the password in the [Authentication Password] or [Encryption Password] text box. For confirmation, enter the same password in the [Confirm] text box. Passwords can be set independently for authentication and encryption algorithms.

[Context Name 1]/[Context Name 2]/[Context Name 3]

Enter up to 32 alphanumeric characters for the context name. Up to three context names can be registered.

7 Specify Printer Management Information Acquisition Settings.

- With SNMP, the printer management information, such as printing protocols and printer ports, can be monitored and obtained regularly from a computer on the network.

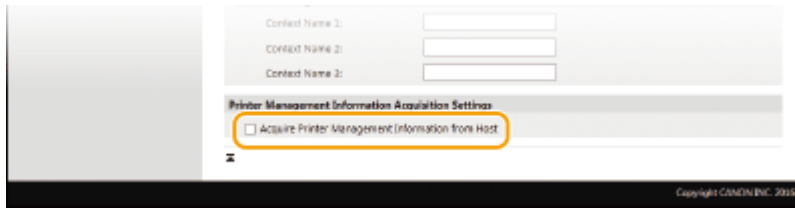

[Acquire Printer Management Information from Host]

Select the check box to enable monitoring of the printer management information of the machine via SNMP. To disable monitoring of the printer management information, clear the check box.

8 Click [OK].

NOTE

Disabling SNMPv1

- Some of the functions of the machine become unavailable, such as obtaining machine information via the printer driver.

Using the operation panel

- You can also specify SNMPv1 settings and enable/disable SNMPv3 settings from the <Menu> in the <Home> screen. [▶SNMP Settings\(P. 480\)](#)

Enabling Both SNMPv1 and SNMPv3

- If both versions of SNMP are enabled, it is recommended that MIB access permission in SNMPv1 be set to [Read Only]. MIB access permission can be set independently in SNMPv1 and SNMPv3 (and for each user in SNMPv3). Selecting [Read/Write] (full access permission) in SNMPv1 negates the robust security features that characterize SNMPv3 because most of the machine settings can then be controlled with SNMPv1.

LINKS

- [▶Enabling TLS Encrypted Communication for the Remote UI\(P. 426\)](#)

Security

Security	392
Protecting the Machine from Unauthorized Access	393
Preventing Unauthorized Access	394
Setting Access Privileges	396
Setting the System Manager PIN	397
Setting a Remote UI PIN (MF249dw / MF246dn / MF237w)	399
Restricting Communication by Using Firewalls (MF249dw / MF246dn / MF237w)	401
Specifying IP Addresses for Firewall Rules	402
Specifying MAC Addresses for Firewall Rules	406
Changing Port Numbers (MF249dw / MF246dn / MF237w)	409
Setting a Proxy (MF249dw / MF246dn / MF237w)	411
Restricting the Machine's Functions	413
Restricting Access to Address Book and Sending Functions	414
Setting a PIN for Address Book	415
Limiting Available Destinations	417
Prohibiting PC Faxing	418
Disabling Use of Previously Used Destinations	419
Checking Destinations before Sending Documents	420
Prohibiting Sequential Broadcasting	422
Disabling HTTP Communication (MF249dw / MF246dn / MF237w)	423
Disabling Remote UI (MF249dw / MF246dn / MF237w)	424
Implementing Robust Security Features (MF249dw / MF246dn / MF237w)	425
Enabling TLS Encrypted Communication for the Remote UI	426
Configuring IEEE 802.1X Authentication	429
Configuring Settings for Key Pairs and Digital Certificates	434
Generating Key Pairs	436
Using CA-issued Key Pairs and Digital Certificates	443
Verifying Key Pairs and Digital Certificates	446

Security

14L7-07A

Confidential information is handled by information devices everywhere, including computers and printers, and any of these devices may become a target for malicious third parties at anytime. Attackers may directly gain unauthorized access to your devices, or indirectly take advantage of negligence or improper use. Either way, you may incur unanticipated losses when your confidential information is leaked. To counter these risks, the machine is equipped with a variety of security functions. Set the necessary configuration depending on your network environment.

NOTE

- You can configure the best security system by building an environment that inhibits access to printers on your in-house network via the Internet and using such environment together with the machine's security features. ▶ **Preventing Unauthorized Access(P. 394)**

■ Establishing the Basics of Information Security



▶ Protecting the Machine from Unauthorized Access(P. 393)

■ Preparing for Risks from Negligence or Misuse

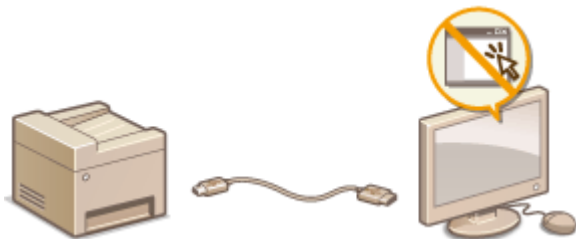

▶ Restricting the Machine's Functions(P. 413)

■ Implementing Robust Security Features **MF249dw / MF246dn / MF237w**



▶ Implementing Robust Security Features (MF249dw / MF246dn / MF237w)(P. 425)

Protecting the Machine from Unauthorized Access

14L7-07C

Prevent unauthorized third parties from accessing and using the machine. You can implement multiple security measures, such as using firewalls and changing port numbers.

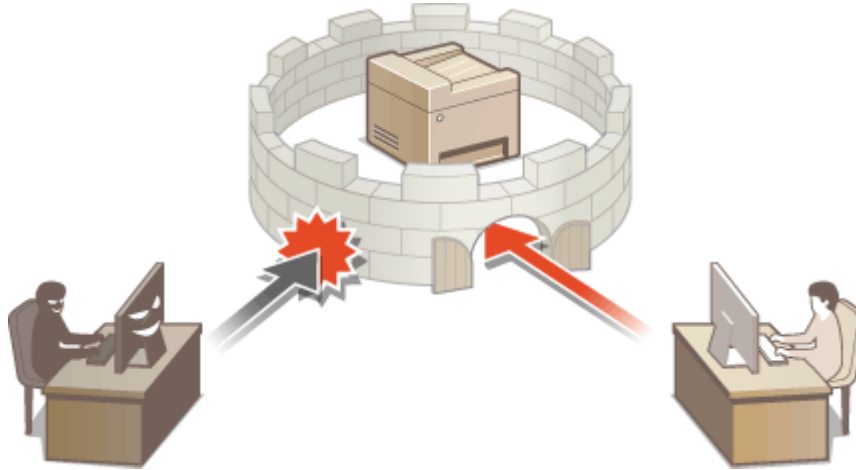

Preventing Unauthorized Access

14L7-07E

This section describes the security measures on how to prevent unauthorized access from the external network. This is a must-read for all users and administrators before using this machine, other printers, and multifunction machines connected to the network. In recent years, a printer/multifunction machine connected to the network can offer you a variety of useful functions, such as printing from a computer, operating from a computer using the remote function, and sending scanned documents via the Internet. On the other hand, it is essential to take security measures to reduce the security risk for information leakage, as a printer/multifunction machine has become more exposed to threats, such as unauthorized access and theft, when it is connected to the network. This section explains necessary settings you need to specify to prevent unauthorized access before using a printer/multifunction machine connected to the network.

Security Measures to Prevent Unauthorized Access from the External Network

- ▶ **Assigning a Private IP Address (MF249dw / MF246dn / MF237w)(P. 394)**
- ▶ **Using Firewall to Restrict Transmission (MF249dw / MF246dn / MF237w)(P. 395)**
- ▶ **Specifying the TLS Encrypted Communication (MF249dw / MF246dn / MF237w)(P. 395)**
- ▶ **Setting PIN to Manage Information Stored in the Multifunction Machine(P. 395)**

Assigning a Private IP Address (MF249dw / MF246dn / MF237w)

An IP address is a numerical label assigned to each device participating in a computer network. A "global IP address" is used for the communication connecting to the Internet, and a "private IP address" is used for the communication within a local area network, such as a LAN in the company. If a global IP address is assigned, your printer/multifunction machine is open to the public and can be accessed via the Internet. Thus, the risk of information leakage due to unauthorized access from external network increases. On the other hand, if a private IP address is assigned, your printer/multifunction machine is closed to a local area network and can be accessed by only users on your local area network, such as a LAN in the company.

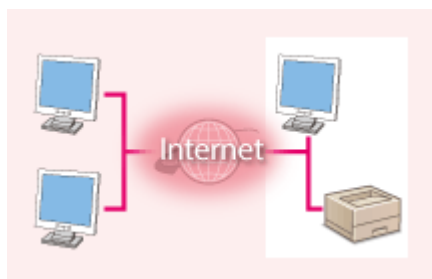

Global IP Address

Can be accessed from the external network

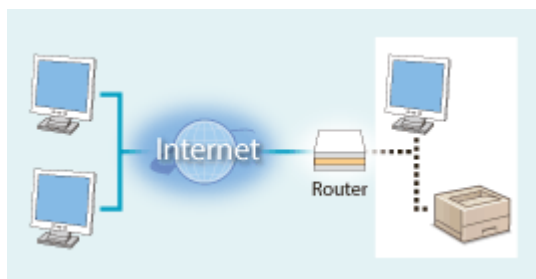

Private IP Address

Can be accessed from the users within a local area network

Basically, assign a private IP address to your printer/multifunction machine. Make sure to confirm the IP address, assigned to the printer/multifunction machine you are using, is a private IP address or not. A private IP address is found in one of the following ranges.

■ Ranges for Private IP addresses

- From 10.0.0.0 to 10.255.255.255
- From 172.16.0.0 to 172.31.255.255
- From 192.168.0.0 to 192.168.255.255

For information on how to confirm the IP address, see ▶ **Setting IPv4 Address(P. 337)** .

NOTE

- If a global IP address is assigned to a printer/multifunction machine, you can create a network environment to reduce the risk of unauthorized access by installing security software, such as a firewall that prevents

access from the external networks. If you want to assign a global IP address to and use a printer/multifunction machine, contact your network administrator.

Using Firewall to Restrict Transmission (MF249dw / MF246dn / MF237w)

A firewall is a system that prevents unauthorized access from the external networks and protects against attacks/intrusions to a local area network. You can use a firewall on your network environment to block access from the external network that appears to be dangerous, by restricting communication from specified IP address of the external network. The function installed to a Canon printer/multifunction machine enables you to set up the IP address filter. For information on how to set up an IP address filter, see [▶Specifying IP Addresses for Firewall Rules\(P. 402\)](#) .

Specifying the TLS Encrypted Communication (MF249dw / MF246dn / MF237w)

For information on the TLS Encrypted Communication, see [▶Implementing Robust Security Features \(MF249dw / MF246dn / MF237w\)\(P. 425\)](#) , and on the procedures to specify, see [▶Enabling TLS Encrypted Communication for the Remote UI\(P. 426\)](#) .

Setting PIN to Manage Information Stored in the Multifunction Machine

If a malicious third party attempts to gain unauthorized access to a printer/multifunction machine, setting PIN to information stored in the machine will reduce the risk of information leakage. Canon printer/multifunction machine enables you to protect various type of information by setting PIN.

■Setting PIN to Each Function

- Setting PIN for Using Remote UI
For more information, see [▶Setting a Remote UI PIN \(MF249dw / MF246dn / MF237w\)\(P. 399\)](#) .
- Setting PIN for the System Manager Settings
For more information, see [▶Setting the System Manager PIN\(P. 397\)](#) .
- Address Book PIN
For more information on setting a PIN, see [▶Setting a PIN for Address Book\(P. 415\)](#) .

Listed above are some examples of security measures for preventing unauthorized access. For more information on the other security measures, see [▶Security\(P. 392\)](#) and take necessary security measures for preventing unauthorized access to suit your environment.

Setting Access Privileges

14L7-07F

Protect the machine from unauthorized access by only allowing users with access privileges to use the machine. When privileges are set, the user must enter a PIN to change settings or access the Remote UI.



Access privileges are divided into two types: System Manager Mode and General User Mode. System Manager Mode has full access privileges, and a System Manager PIN can be set to restrict logon in this mode. And by setting a Remote UI Access PIN, you can restrict use of the Remote UI in General User Mode and in System Manager Mode without a System Manager PIN set.

System Manager PIN

System Manager PIN is intended exclusively for Administrators having full access privileges. If you specify this PIN, you need to log on to the machine using this PIN in order to access <Network Settings> or <System Management Settings>. Set the System Manager PIN when you need different access privilege levels for administrators and general users.

▶ Setting the System Manager PIN(P. 397)

Remote UI PIN (Remote UI Access PIN) MF249dw / MF246dn / MF237w

This is a PIN for using the Remote UI. Only users who know the PIN can access the Remote UI.

▶ Setting a Remote UI PIN (MF249dw / MF246dn / MF237w)(P. 399)

Setting the System Manager PIN

Set a System Manager PIN that is intended exclusively for Administrators. You can access <Network Settings>, <System Management Settings>, etc. only when the PIN has been entered correctly. It is recommended that only Administrators know the PIN.

- 1 Tap <Menu> in the <Home> Screen.
- 2 Tap <System Management Settings>.
- 3 Select <System Manager Information Settings> ► <System Manager PIN>.
- 4 Specify the System Manager PIN.

- Enter a number of up to seven digits using the numeric keys, and tap <Apply>.
- When <PIN (Confirm)> is displayed, enter the PIN once again to confirm.

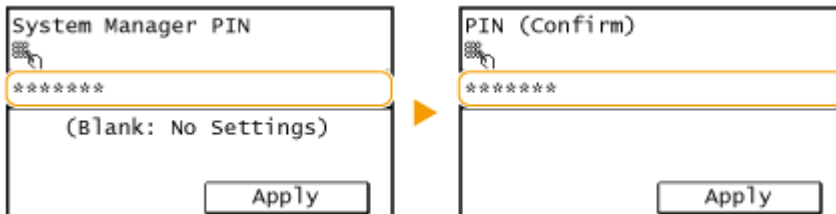

NOTE:

- You cannot set a PIN that consists only of zeros, such as "00" or "0000000".
- To disable the PIN, press **C** to erase the PIN (leave the text box blank), and tap <Apply>.

■ Setting the System Manager Name

- 1 Tap <System Manager Name>.

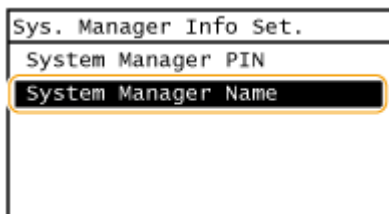

- 2 Enter up to 32 characters for the System Manager Name, and tap <Apply>. [▶ Entering Text\(P. 38\)](#)



NOTE**Configuring settings via the Remote UI (MF249dw / MF246dn / MF237w)**

- Start the Remote UI and log on in System Manager Mode. Click [Settings/Registration] ► [System Management] ► [Edit] and specify the necessary settings on the displayed screen.
- By using the Remote UI, you can register a variety of information, including contact information, Administrator comments, the installation location of the machine, as well as to the settings that you can register by using the operation panel. The registered information can be viewed on the [Device Information] page of the Remote UI. ► **Checking System Manager Information(P. 459)**

If PIN is forgotten

- Do not forget your PIN. If you forget your PIN, contact your authorized Canon dealer or the Canon help line.

If a System Manager PIN is Set

- If you try to access <Network Settings>, <System Management Settings>, etc., the following screen is displayed. Enter the set PIN.
- Entering a PIN is also required when logging on in System Manager Mode in the Remote UI. ► **Starting Remote UI(P. 450)**



Setting a Remote UI PIN MF249dw / MF246dn / MF237w

14L7-07J

You can set a PIN for access to the Remote UI. All users use a common PIN.

- 1 Start the Remote UI and log on in System Manager Mode. ▶ Starting Remote UI(P. 450)**
- 2 Click [Settings/Registration].**

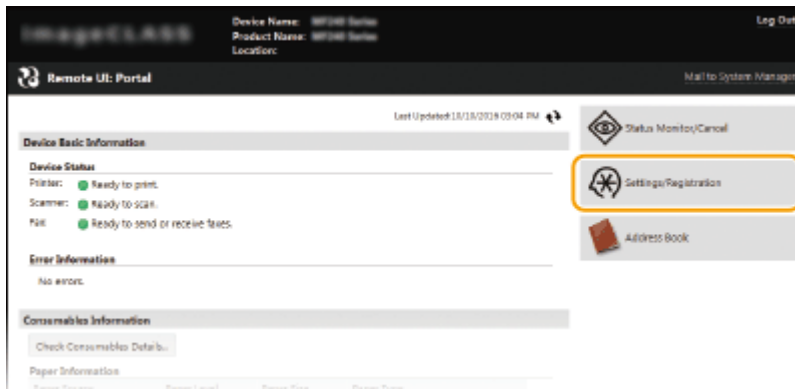

- 3 Click [Security Settings] ▶ [Remote UI Settings].**

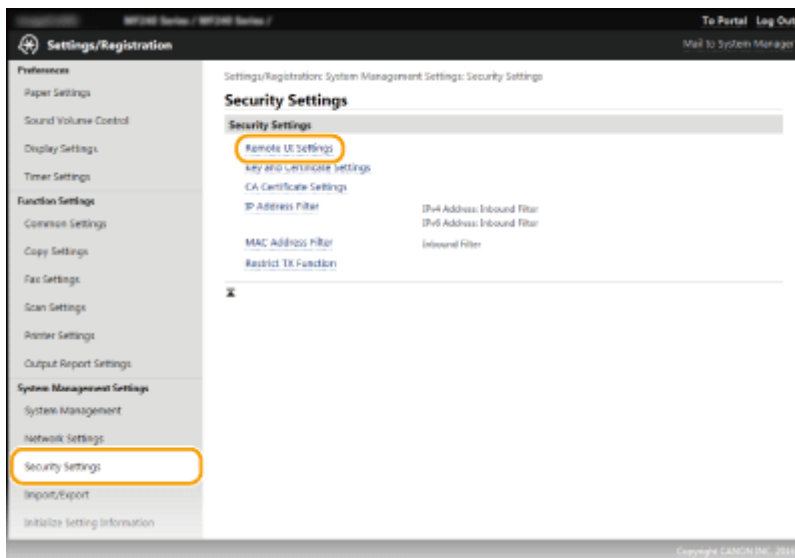

- 4 Click [Edit].**

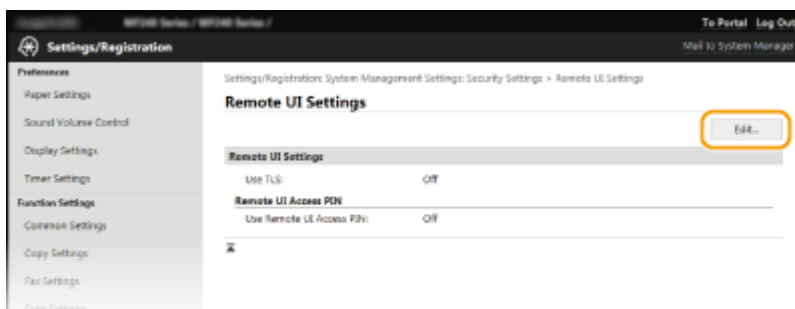

5 Select the [Use Remote UI Access PIN] check box and set the PIN.

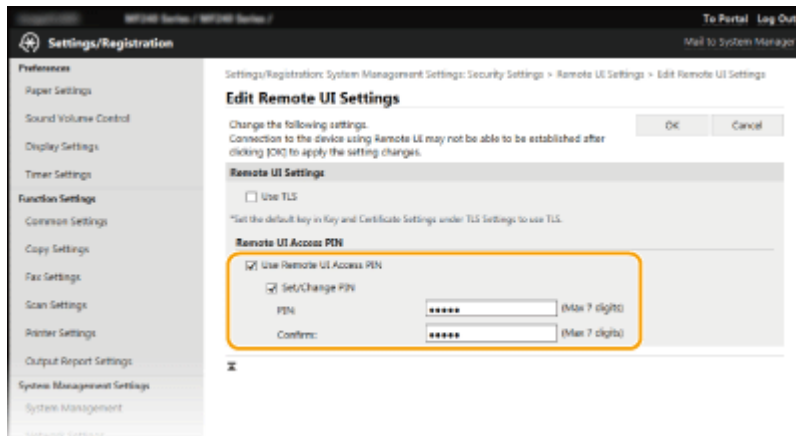

[Use Remote UI Access PIN]

If you select this check box, you must enter a PIN to access the Remote UI.

[Set/Change PIN]

To set a PIN, select the check box and enter a number of up to seven digits both in the [PIN] and [Confirm] text boxes.

6 Click [OK].

NOTE

If PIN is forgotten

- Set a new Remote UI Access PIN in the settings menu on the operation panel. [▶Remote UI Settings\(P. 531\)](#)

If Remote UI settings are initialized

- The Remote UI Access PIN is also initialized. After an initialization, reset the PIN. [▶Initializing Menu\(P. 622\)](#)

LINKS

[▶Setting Access Privileges\(P. 396\)](#)

[▶Setting the System Manager PIN\(P. 397\)](#)

Restricting Communication by Using Firewalls

MF249dw / MF246dn / MF237w

14L7-07K

Without proper security, unauthorized third parties can access computers and other communication devices that are connected to a network. To prevent this unauthorized access, specify the settings for packet filter, a feature that restricts communication to devices with specified IP addresses or MAC addresses.

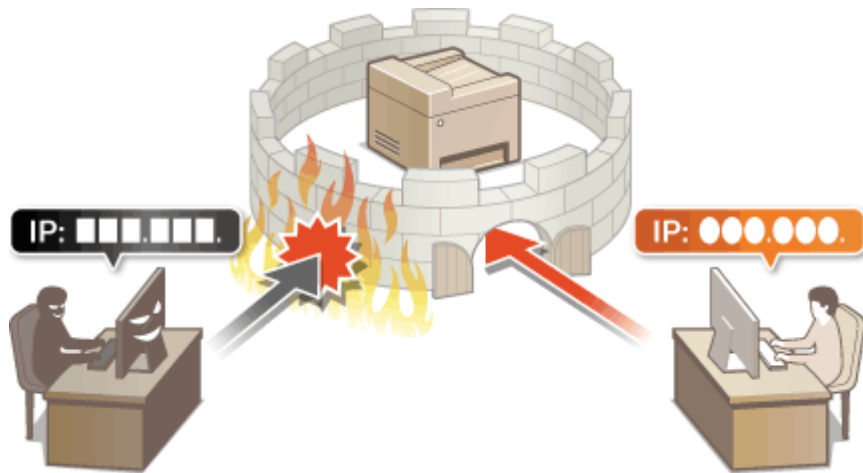

Specifying IP Addresses for Firewall Rules

14L7-07L

You can either limit communication to only devices with specified IP addresses, or block devices with specified IP addresses but permit other communications. You can specify a single IP address or a range of IP addresses.

NOTE

- Up to 4 IP addresses (or ranges of IP addresses) can be specified for both IPv4 and IPv6.
- The packet filters described in this section control communications over TCP, UDP, and ICMP.

1 Start the Remote UI and log on in System Manager Mode. ▶ Starting Remote UI(P. 450)

2 Click [Settings/Registration].

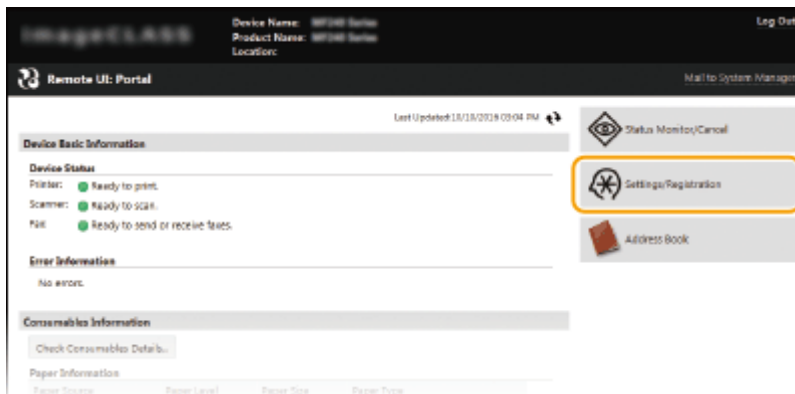

3 Click [Security Settings] ▶ [IP Address Filter].

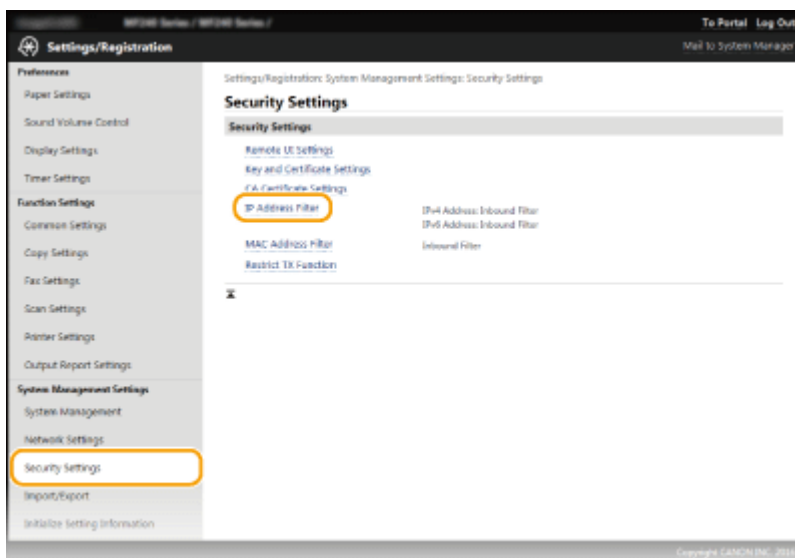

4 Click [Edit] for the filter type that you want to use.



[IPv4 Address: Inbound Filter]

Select to restrict receiving data from the machine to a computer by specifying IPv4 addresses.

[IPv6 Address: Inbound Filter]

Select to restrict receiving data from the machine to a computer by specifying IPv6 addresses.

5 Specify the settings for packet filtering.

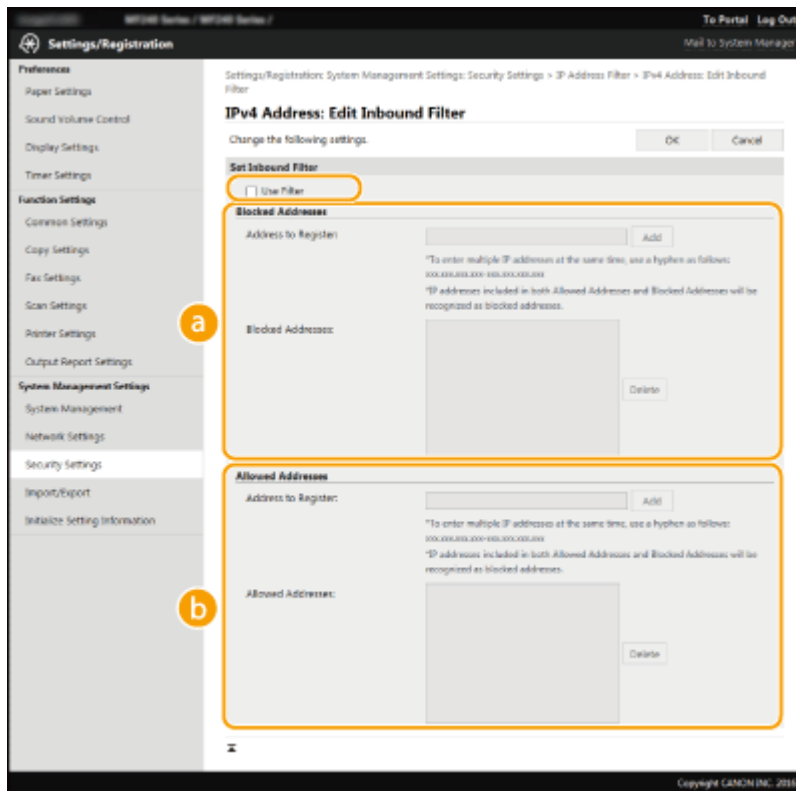

a [Blocked Addresses]

Register addresses to be blocked, as well as check or delete registered blocked addresses.

b [Allowed Addresses]

Register addresses to be allowed, as well as check or delete registered allowed addresses.

1 Select the [Use Filter] check box.

- Select the check box to restrict communication. Clear the check box to disable the restriction.

2 Specify the address.

- Enter the IP address (or the range of IP addresses) in the [Address to Register] text box and click [Add].

Registered address	Result
[Blocked Addresses]	Restricts communication (received) with devices having their IP addresses entered for [Address to Register]. Communication is allowed with devices with any other IP addresses.
[Allowed Addresses]	Allows communication (received) only with devices having their IP addresses entered for [Address to Register], and restricts communication with devices with any other IP addresses.
Registered as both	Allows communication (received) only with devices having their IP addresses registered in [Allowed Addresses], and restricts communication with devices with any other IP addresses. However, communication is restricted for IP addresses also registered in [Blocked Addresses].

IMPORTANT:
Check for entry errors

If IP addresses are incorrectly entered, you may be unable to access the machine from the Remote UI, in which case you need to set <IPv4 Address Filter> or <IPv6 Address Filter> to <Off>. **▶IPv4 Address Filter (P. 529)** **▶IPv6 Address Filter (P. 530)**

NOTE:
Entry form for IP addresses

	Description	Example
Entering a single address	IPv4: Delimit numbers with periods.	192.168.0.10
	IPv6: Delimit alphanumeric characters with colons.	fe80::10
Specifying a range of addresses	Insert a hyphen between the addresses.	IPv4: 192.168.0.10-192.168.0.20
		IPv6: fe80::10-fe80::20
Specifying a range of addresses with a prefix (IPv6 only)	Enter the address, followed by a slash and a number indicating the prefix length.	fe80::1234/64

Deleting an IP address from exceptions

Select an IP address and click [Delete].

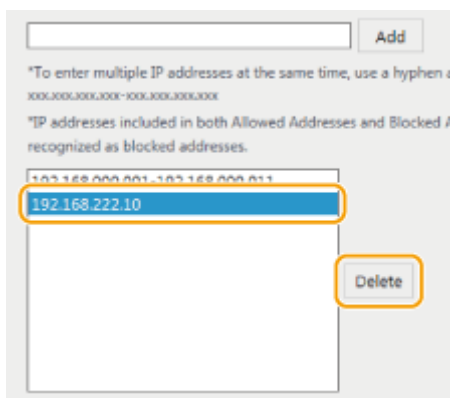

3 Click [OK].

NOTE

You can enable or disable the IP Address Filter settings from <Menu> in the <Home> Screen. [▶IPv4 Address Filter \(P. 529\)](#) [▶IPv6 Address Filter \(P. 530\)](#)

LINKS

[▶Specifying MAC Addresses for Firewall Rules\(P. 406\)](#)

Specifying MAC Addresses for Firewall Rules

14L7-07R

You can limit communication to only devices with specified MAC addresses, or block devices with specified MAC addresses but permit other communications. Up to 10 MAC addresses can be specified.

IMPORTANT

This function is unavailable when the machine is connected to a wireless LAN.

1 Start the Remote UI and log on in System Manager Mode. ▶ Starting Remote UI(P. 450)

2 Click [Settings/Registration].

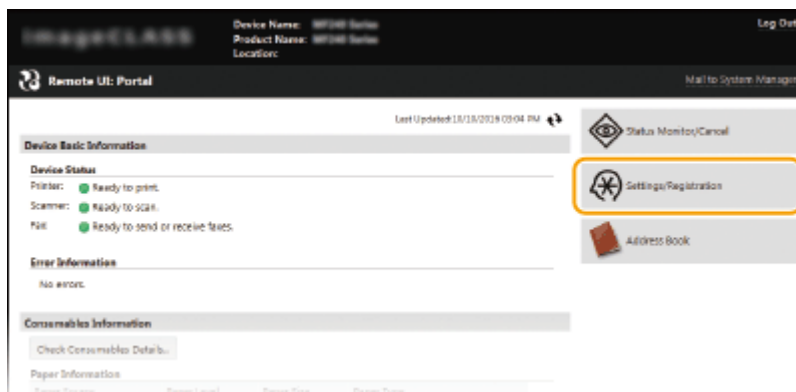

3 Click [Security Settings] ▶ [MAC Address Filter].

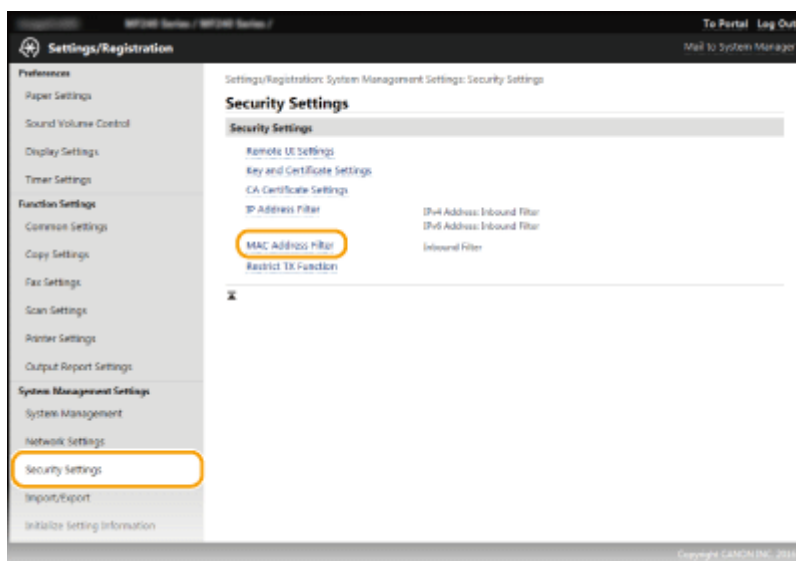

4 Click [Edit].

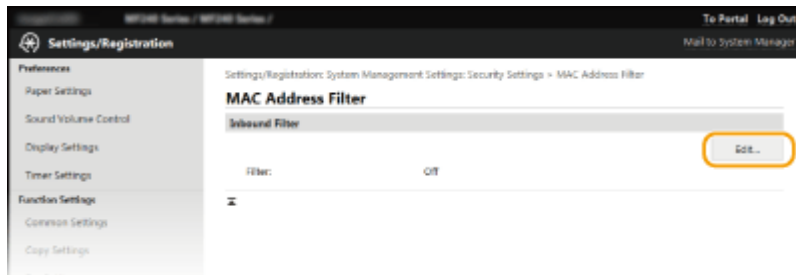

[Inbound Filter]

Select to restrict receiving data from the machine to a computer by specifying MAC addresses.

5 Specify the settings for packet filtering.

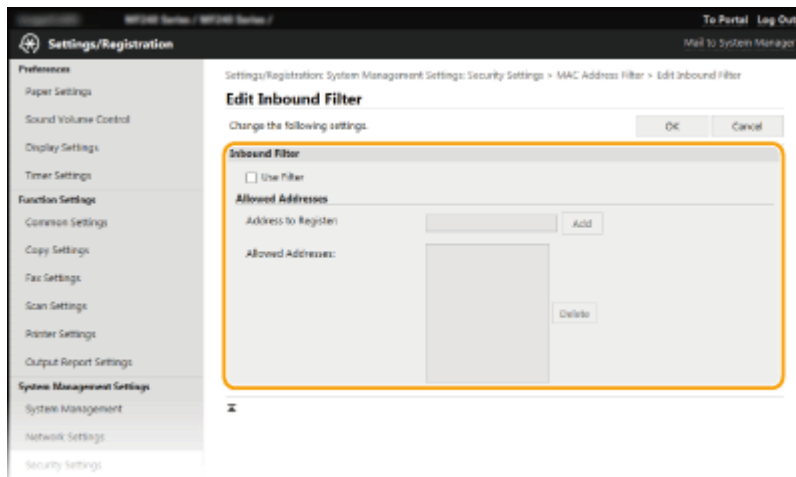

1 Select the [Use Filter] check box.

- Select the check box to restrict communication. Clear the check box to disable the restriction.

2 Specify the address.

- Enter the MAC address in the [Address to Register] text box and click [Add]. Allows communication (received) only with devices having registered MAC addresses, and restricts communication with devices with any other MAC addresses.
- You do not need to delimit the address with hyphens or colons.

IMPORTANT:

Check for entry errors

If MAC addresses are incorrectly entered, you may become unable to access the machine from the Remote UI, in which case you need to set <MAC Address Filter> to <Off>. [▶MAC Address Filter \(P. 530\)](#)

NOTE:

Deleting a MAC address from exceptions

Select a MAC address and click [Delete].

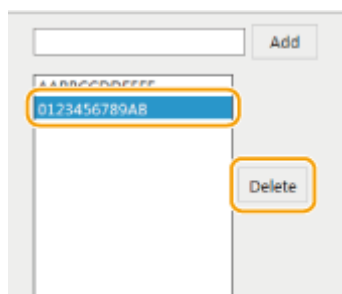

3 Click [OK].

NOTE

You can enable or disable the MAC Address Filter settings from <Menu> in the <Home> Screen. [▶MAC Address Filter \(P. 530\)](#)

LINKS

[▶Specifying IP Addresses for Firewall Rules\(P. 402\)](#)

Changing Port Numbers MF249dw / MF246dn / MF237w

14L7-07S

Ports serve as endpoints for communicating with other devices. Typically, conventional port numbers are used for major protocols, but devices that use these port numbers are vulnerable to attacks because these port numbers are well-known. To enhance security, your Network Administrator may change the port numbers. When a port number has been changed, the new number must be shared with the communicating devices, such as computers and servers. Specify the port number settings depending on the network environment.

NOTE

To change the port number for proxy server, see [▶Setting a Proxy \(MF249dw / MF246dn / MF237w\)\(P. 411\)](#) .

1 Tap <Menu> in the <Home> Screen.

2 Tap <Network Settings>.

- If a screen for entering a PIN is displayed, enter the PIN with the numeric keys and tap <Apply>. [▶Setting the System Manager PIN\(P. 397\)](#)

3 Select <TCP/IP Settings> ▶ <Port Number Settings>.

4 Tap the port to change.

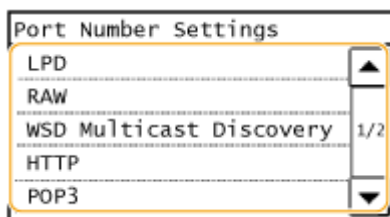

NOTE:

Learning more about the ports

- <LPD>/<RAW>/<WSD Multicast Discovery> [▶Configuring Printing Protocols and WSD Functions\(P. 348\)](#)
- <HTTP> [▶Disabling HTTP Communication \(MF249dw / MF246dn / MF237w\)\(P. 423\)](#)
- <POP3>/<SMTP> [▶Configuring E-Mail Communication Settings\(P. 363\)](#)
- <SNMP> [▶Monitoring and Controlling the Machine with SNMP\(P. 386\)](#)

5 Enter the port number using the numeric keys, and tap <Apply>.



LINKS

▶ **Configuring Printer Ports(P. 351)**

Setting a Proxy MF249dw / MF246dn / MF237w

14L7-07U

A proxy (or HTTP proxy server) refers to a computer or software that carries out HTTP communication for other devices, especially when communicating with resources outside the network, such as when browsing Web sites. The client devices connect to the outside network through the proxy server, and do not communicate directly to the resources outside. Setting a proxy not only facilitates management of traffic between in-house and outside networks but also blocks unauthorized access and consolidates anti-virus protection for enhanced security. When you use Google Cloud Print to print over the Internet, you can enhance security by setting a proxy. When setting a proxy, make sure that you have the necessary proxy information, including the IP address, port number, and a user name and password for authentication.

- 1 Start the Remote UI and log on in System Manager Mode. ▶ Starting Remote UI(P. 450)
- 2 Click [Settings/Registration].

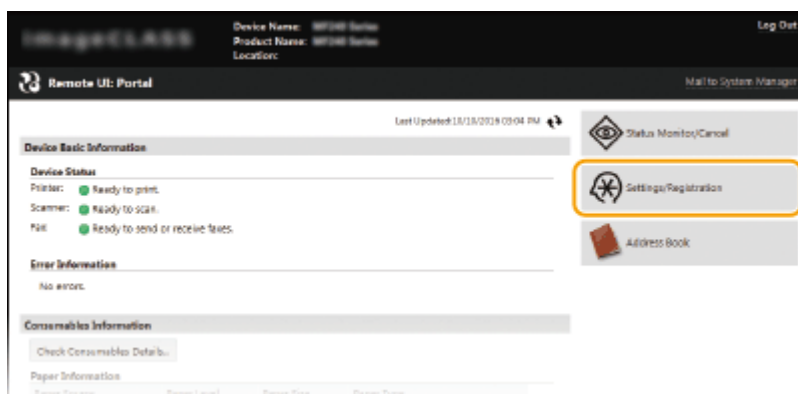

- 3 Click [Network Settings] ▶ [TCP/IP Settings].

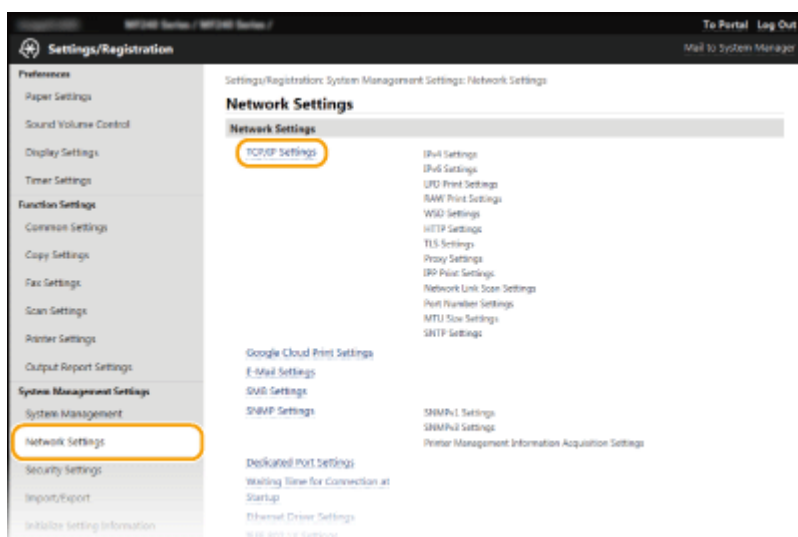

- 4 Click [Edit] in [Proxy Settings].



5 Select the [Use Proxy] check box and specify the required settings.

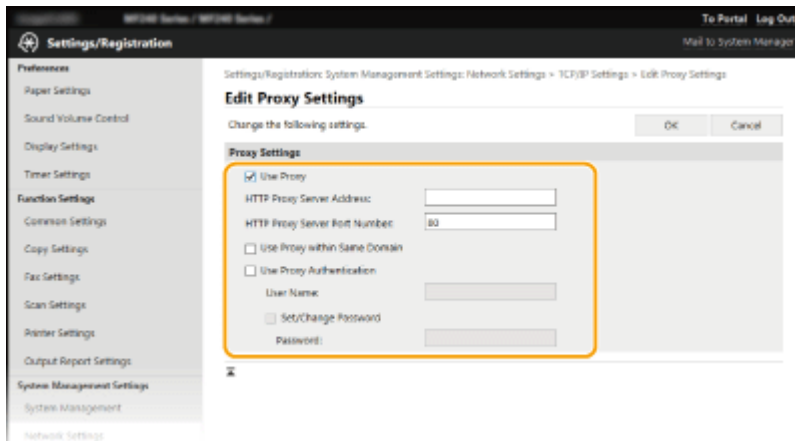

[Use Proxy]

Select the check box to use the specified proxy server when communicating with an HTTP server.

[HTTP Proxy Server Address]

Enter the address of the proxy server. Specify the IP address or host name depending on the environment.

[HTTP Proxy Server Port Number]

Change the port number as necessary. Enter a number between 1 and 65535.

[Use Proxy within Same Domain]

Select the check box to use a proxy server specified in the same domain.

[Use Proxy Authentication]

To enable authentication by the proxy server, select the check box and enter up to 24 alphanumeric characters for the user name in the [User Name] text box.

[Set/Change Password]

To set or change the password for the proxy authentication, when it is enabled, select the check box and enter up to 24 alphanumeric characters for the new password in the [Password] text box.

6 Click [OK].

Restricting the Machine's Functions

14L7-07W

Some of the functions of the machine may rarely be used or provide opportunities for misuse. For security purposes, the machine can be set to limit its capabilities by partially or completely disabling these functions.

Restricting Access to Address Book and Sending Functions



- ▶ Restricting Access to Address Book and Sending Functions(P. 414)

Disabling HTTP Communication and Remote Management

MF249dw / MF246dn / MF237w



- ▶ Disabling HTTP Communication (MF249dw / MF246dn / MF237w)(P. 423)
- ▶ Disabling Remote UI (MF249dw / MF246dn / MF237w)(P. 424)

Restricting Access to Address Book and Sending Functions

14L7-07X

Some cases of information leakage can be prevented by limiting the available fax and e-mail destinations to those registered in the Address Book or by setting a PIN for the Address Book so that unauthorized users cannot add or edit Address Book entries. You can also avoid sending documents to unintended recipients if the machine is set to ask you to enter the fax number twice for confirmation.



Setting a PIN for Address Book

14L7-07Y



The Address Book can be set to require users to enter a PIN in order to add new entries to the Address Book or edit existing entries. Setting a PIN to the Address Book can reduce the risk of documents being sent to unintended recipients because changes to the Address Book can only be made by users who know the PIN.

1 Tap <Menu> in the <Home> Screen.

2 Tap <System Management Settings>.

- If a screen for entering a PIN is displayed, enter the PIN with the numeric keys and tap <Apply>. [▶Setting the System Manager PIN\(P. 397\)](#)

3 Select <Restrict TX Function> ▶ <Address Book PIN>.

4 Set the PIN for editing the Address Book.

- Enter a number of up to seven digits using numeric keys, and tap <Apply>.
- When <PIN (Confirm)> is displayed, enter the PIN once again to confirm.

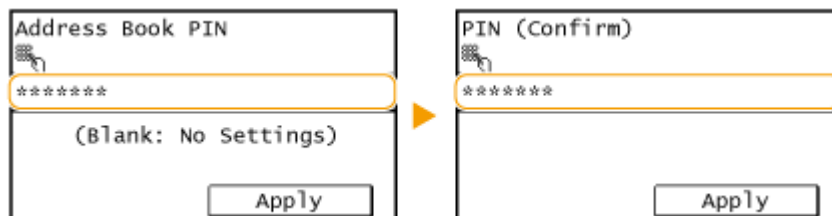

NOTE:

- You cannot set a PIN that consists only of zeros, such as "00" or "0000000".
- To disable the PIN, press **C** to erase the PIN (leave the text box blank), and tap <Apply>.

NOTE

In addition to setting the Address Book PIN, you can further enhance security by performing the following operations:

- Restricting the addition of new destinations [▶Limiting Available Destinations\(P. 417\)](#)
- Disabling the PC fax function [▶Prohibiting PC Faxing\(P. 418\)](#)

LINKS

- [▶Registering in the Address Book\(P. 60\)](#)
- [▶Registering Address Book from Remote UI\(P. 467\)](#)
- [▶Configuring Basic E-Mail Settings\(P. 359\)](#)

▶ **Setting a Shared Folder as a Save Location(P. 368)**

Limiting Available Destinations



By limiting fax numbers that can be specified when sending documents to those already registered in the Address Book, those registered as One-Touch Dial, or those previously used, you can reduce the possibility of specifying incorrect destinations and prevent users from leaking information. Destinations for sending scanned documents by e-mail are also limited.

When this function is enabled, the machine prohibits users from entering destinations using the numeric keys, adding new entries to the Address Book, and editing the existing Address Book entries.

1 Tap <Menu> in the <Home> Screen.

2 Tap <System Management Settings>.

- If a screen for entering a PIN is displayed, enter the PIN with the numeric keys and tap <Apply>. **▶Setting the System Manager PIN(P. 397)**

3 Select <Restrict TX Function> ▶ <Restrict New Destinations>.

4 Tap <On>.

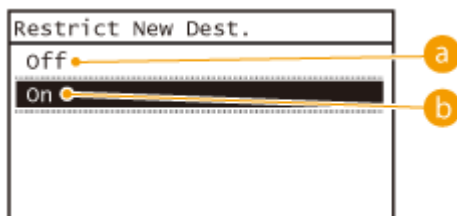

a <Off>

Cancels the restriction on new destinations. Fax numbers and e-mail addresses can be specified by using any method.

b <On>

Restricts input so that the only addresses that can be specified are those registered in the Address Book, those registered as One-Touch Dial, or those previously used.

IMPORTANT

This function does not limit the available destinations for PC faxing.

▶Prohibiting PC Faxing(P. 418)

LINKS

- ▶Setting a PIN for Address Book(P. 415)
- ▶Disabling Use of Previously Used Destinations(P. 419)
- ▶Prohibiting Sequential Broadcasting(P. 422)

Prohibiting PC Faxing

14L7-081

You can prohibit users from PC faxing (faxing from a computer).



1 Tap <Menu> in the <Home> Screen.

2 Tap <Fax Settings>.

3 Select <TX Function Settings> ▶ <Allow Fax Driver TX>.

- If a screen for entering a PIN is displayed, enter the PIN with the numeric keys and tap <Apply>. **▶Setting the System Manager PIN(P. 397)**

4 Tap <Off>.

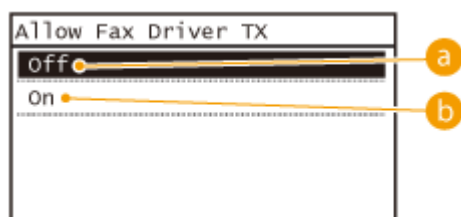

a <Off>

Disables PC faxing.

b <On>

Enables PC faxing.

LINKS

- ▶ **Sending Faxes from Your Computer (PC Fax)(P. 167)**
- ▶ **Setting a PIN for Address Book(P. 415)**
- ▶ **Limiting Available Destinations(P. 417)**

Disabling Use of Previously Used Destinations

14L7-082

Prohibits the specification of destinations from the transmission records. Using this restriction prevents destinations being selected from the transmission records for "Send Fax", "Scan and Send as E-Mail" and "Scan and Save to Shared Folder".

1 Tap <Menu> in the <Home> Screen.

2 Tap <System Management Settings>.

- If a screen for entering a PIN is displayed, enter the PIN with the numeric keys and tap <Apply>. **Setting the System Manager PIN(P. 397)**

3 Select <Restrict TX Function> ▶ <Restrict Resending from Log>.

4 Tap <On>.

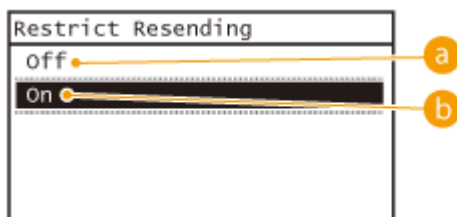

a <Off>

Enables use of previously used destinations.

b <On>

Disables use of previously used destinations.

LINKS

- ▶ **Limiting Available Destinations(P. 417)**
- ▶ **Prohibiting Sequential Broadcasting(P. 422)**
- ▶ **Specifying Previously Used Destinations(P. 130)**
- ▶ **Specifying Previously Used Destinations(P. 281)**

Checking Destinations before Sending Documents

14L7-083

By entering the fax number twice, you can reduce the risk of faxing to the wrong number due to input mistakes. Use features described in this section if you send confidential documents.

- ▶ **Displaying the Screen for Confirming the Fax Number(P. 420)**
- ▶ **Displaying Destinations in Address Book(P. 420)**

Displaying the Screen for Confirming the Fax Number

You can set the machine to ask users to enter the fax number twice when it is entered by using the numeric keys. This way, you can reduce the risk of faxing to the wrong number due to input mistakes.

1 Tap <Menu> in the <Home> Screen.

2 Tap <Fax Settings>.

3 Select <TX Function Settings> ▶ <Confirm Entered Fax Number>.

- If a screen for entering a PIN is displayed, enter the PIN with the numeric keys and tap <Apply>. ▶ **Setting the System Manager PIN(P. 397)**

4 Tap <On>.

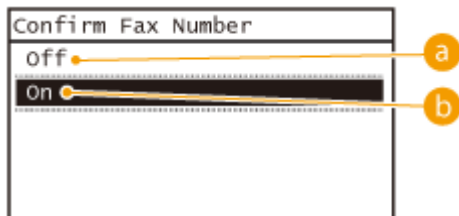

a <Off>

Does not display the screen for confirming the fax number.

b <On>

Displays the screen for confirming the fax number.

Displaying Destinations in Address Book

When using One-Touch buttons or coded dial numbers to specify destinations, you need to remember whose destination (or what group) is registered in what coded dial number. If you do not remember all these numbers perfectly, you may send your documents to unintended destinations. You can avoid sending data to unintended recipients by configuring the machine to display the details of the One-Touch button or coded dial number you selected/entered as a sending destination before you send documents to that destination.

1 Tap <Menu> in the <Home> Screen.

2 Tap <System Management Settings>.

- If a screen for entering a PIN is displayed, enter the PIN with the numeric keys and tap <Apply>. **▶Setting the System Manager PIN(P. 397)**

3 Select <Restrict TX Function> ▶ <One-Touch/Coded Dial TX Confirmation>.

4 Tap <On>.

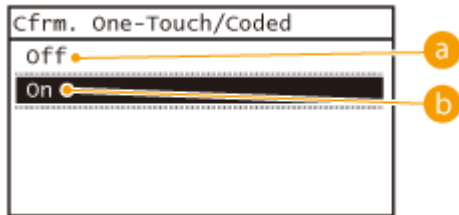

a <Off>

Does not display the details of the selected/entered One-Touch button or coded dial number.

b <On>

Displays the details of the selected/entered One-Touch button or coded dial number.

LINKS

- ▶**Registering Destinations(P. 178)**
- ▶**Specifying from Address Book(P. 121)**
- ▶**Specifying from Address Book(P. 273)**
- ▶**Registering Address Book from Remote UI(P. 467)**

Prohibiting Sequential Broadcasting

14L7-084

Sequential broadcasting is a feature that sends faxes to multiple recipients in succession. This feature can be disabled if preferred.

1 Tap <Menu> in the <Home> Screen.

2 Tap <Fax Settings>.

3 Select <TX Function Settings> ▶ <Restrict Sequential Broadcast>.

- If a screen for entering a PIN is displayed, enter the PIN with the numeric keys and tap <Apply>. **▶Setting the System Manager PIN(P. 397)**

4 Select <Confirm Sequential Broadcast> or <Reject Sequential Broadcast>.

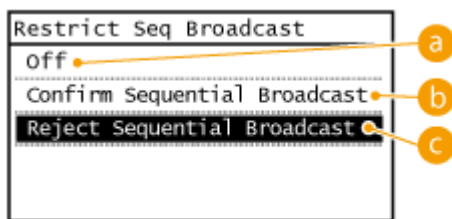

a <Off>

Enables sequential broadcasting.

b <Confirm Sequential Broadcast>

Displays the confirmation screen when sending a fax via sequential broadcasting.

c <Reject Sequential Broadcast>

Disables sequential broadcasting.

LINKS

- ▶Limiting Available Destinations(P. 417)
- ▶Disabling Use of Previously Used Destinations(P. 419)
- ▶Sending Faxes to Multiple Destinations Simultaneously (Sequential Broadcast)(P. 148)

Disabling HTTP Communication MF249dw / MF246dn / MF237w

14L7-085

HTTP is used for communications over the network, such as when you access the machine via the Remote UI. If you are using a USB connection or are otherwise not using HTTP, you can disable HTTP to block malicious third-party intrusions via the unused HTTP port.

IMPORTANT

Disabling HTTP disables some of the network capabilities, such as the Remote UI, WSD printing, and printing with Google Cloud Print.

1 Tap <Menu> in the <Home> Screen.

2 Tap <Network Settings>.

- If a screen for entering a PIN is displayed, enter the PIN with the numeric keys and tap <Apply>. **▶Setting the System Manager PIN(P. 397)**

3 Select <TCP/IP Settings> ▶ <Use HTTP>.

4 Tap <Off>.



a <Off>

Disables HTTP communication.

b <On>

Enables HTTP communication.

LINKS

- ▶ **Using Remote UI (MF249dw / MF246dn / MF237w)(P. 449)**
- ▶ **Changing Port Numbers (MF249dw / MF246dn / MF237w)(P. 409)**
- ▶ **Configuring Printing Protocols and WSD Functions(P. 348)**

Disabling Remote UI MF249dw / MF246dn / MF237w

14L7-086

The Remote UI is useful because the machine settings can be specified by using a Web browser on a computer. To use the Remote UI, the machine must be connected to a computer over the network. If you do not need to use the Remote UI, you might want to disable the Remote UI to reduce the risk of having your machine controlled remotely over the network by malicious third parties.

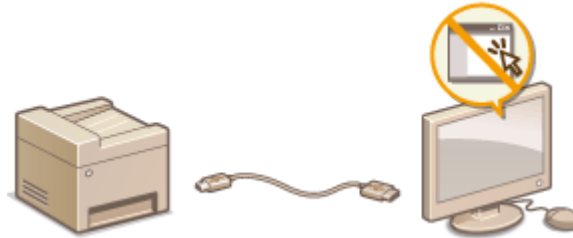

1 Tap <Menu> in the <Home> Screen.

2 Tap <System Management Settings>.

- If a screen for entering a PIN is displayed, enter the PIN with the numeric keys and tap <Apply>. **▶Setting the System Manager PIN(P. 397)**

3 Select <Remote UI Settings> ▶ <Use Remote UI>.

4 Tap <Off>.

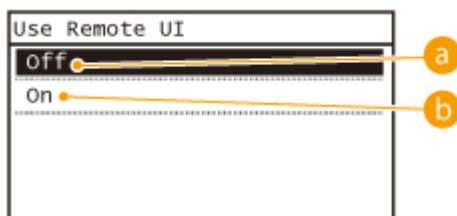

a <Off>

Disables the Remote UI.

b <On>

Enables the Remote UI.

LINKS

▶Using Remote UI (MF249dw / MF246dn / MF237w)(P. 449)

▶Disabling HTTP Communication (MF249dw / MF246dn / MF237w)(P. 423)

Implementing Robust Security Features

MF249dw / MF246dn / MF237w

14L7-087

Authorized users may incur unanticipated losses from attacks by malicious third parties, such as sniffing, spoofing, and tampering of data as it flows over a network. To protect your important and valuable information from these attacks, the machine supports the following features to enhance security and secrecy.

TLS Encrypted Communication

TLS is a protocol for encryption for data sent over a network and is often used for communication via a Web browser or an e-mail application. TLS enables secure network communication when you access the machine from a computer via the Remote UI. [▶ Enabling TLS Encrypted Communication for the Remote UI \(P. 426\)](#)



IEEE 802.1X Authentication

IEEE 802.1X is a standard and mechanism for blocking unauthorized access to the network by collectively managing user authentication information. If a device tries to connect to the 802.1X network, the device must go through user authentication in order to prove that the connection is made by an authorized user. Authentication information is sent to and checked by a RADIUS server, which permits or rejects communication to the network depending on the authentication result. If authentication fails, a LAN switch (or an access point) blocks access from the outside of the network. The machine can connect to an 802.1X network as a client device. [▶ Configuring IEEE 802.1X Authentication \(P. 429\)](#)

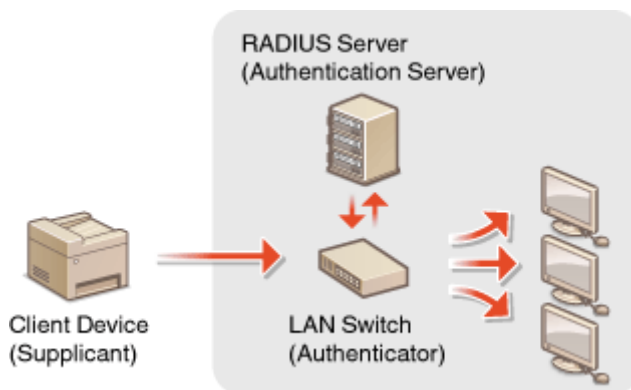

LINKS

[▶ Configuring Settings for Key Pairs and Digital Certificates \(P. 434\)](#)

Enabling TLS Encrypted Communication for the Remote UI

14L7-088

You can encrypt communication between the machine and a Web browser on the computer by using Transport Layer Security (TLS). TLS is a mechanism for encrypting data sent or received over the network. TLS must be enabled when the Remote UI is used for specifying settings for IEEE 802.1X authentication (TTLS/PEAP) or SNMPv3. To use TLS for the Remote UI, you need to set a key pair and enable the TLS function. Generate or install the key pair for TLS before enabling TLS ([▶Configuring Settings for Key Pairs and Digital Certificates\(P. 434\)](#)).



1 Start the Remote UI and log on in System Manager Mode. [▶Starting Remote UI\(P. 450\)](#)

2 Click [Settings/Registration].

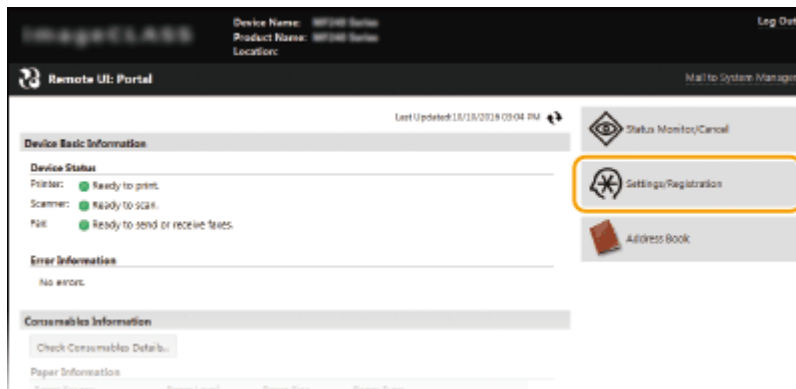

3 Click [Network Settings] ▶ [TCP/IP Settings].

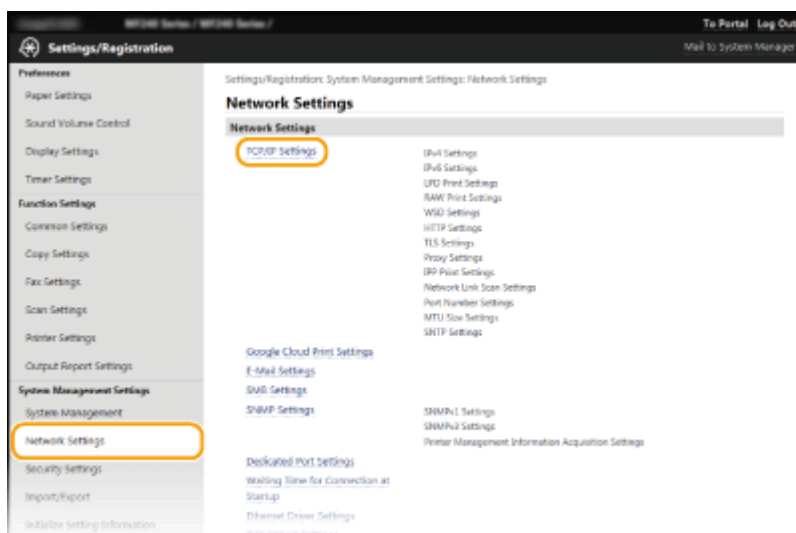

4 Click [Key and Certificate] in [TLS Settings].



5 Click [Register Default Key] on the right of the key pair you want to use.

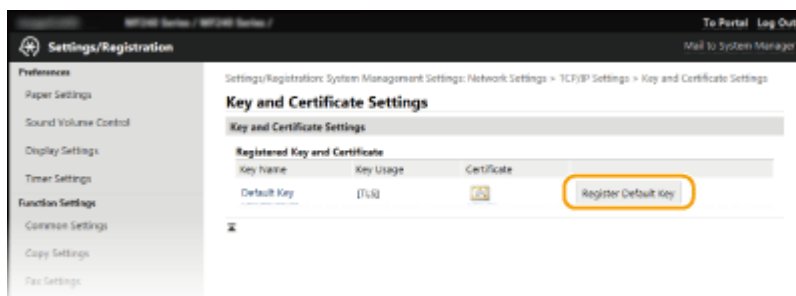

NOTE:

Viewing details of a certificate

- You can check the details of the certificate or verify the certificate by clicking the corresponding text link under [Key Name], or the certificate icon. [▶ Verifying Key Pairs and Digital Certificates\(P. 446\)](#)

6 Enable TLS for the Remote UI.

- 1 Click [Security Settings] ▶ [Remote UI Settings].

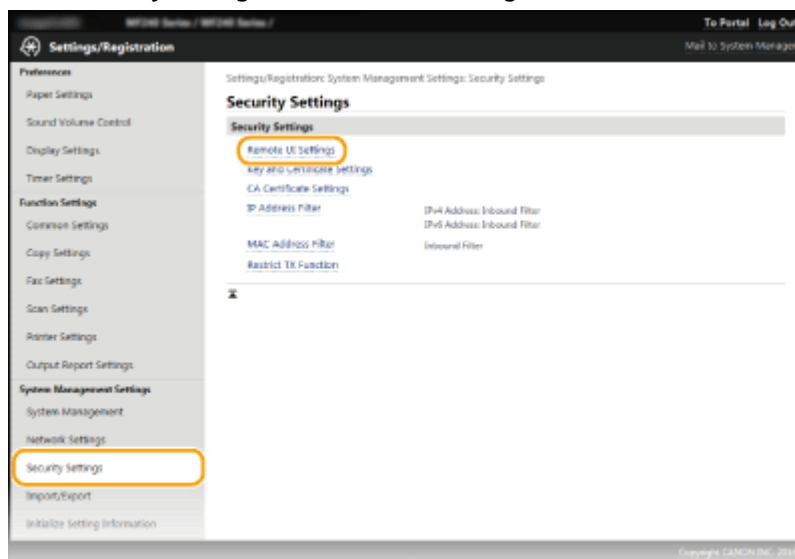

- 2 Click [Edit].

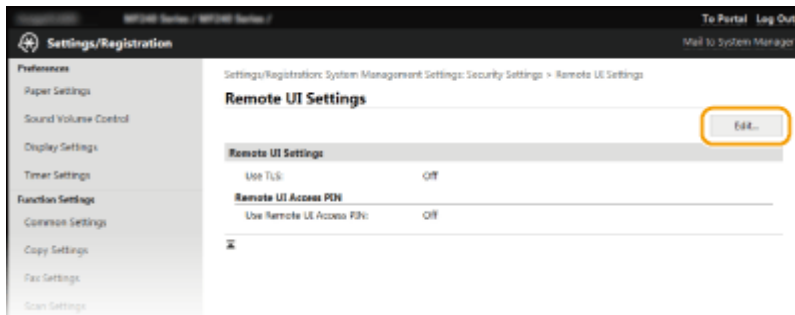

- 3 Select the [Use TLS] check box and click [OK].

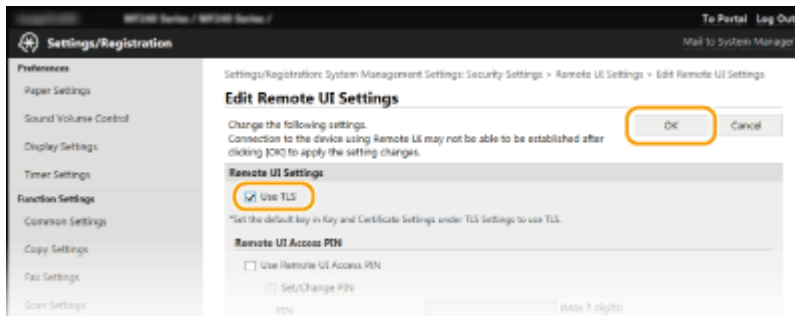

NOTE

Using the operation panel

- You can also enable or disable TLS encrypted communication from <Menu> in the <Home> screen. ▶ **Use TLS(P. 529)**

Starting the Remote UI with TLS

- If you try to start the Remote UI when TLS is enabled, a security alert may be displayed regarding the security certificate. In this case, check that the correct URL is entered in the address field, and then proceed to display the Remote UI screen. ▶ **Starting Remote UI(P. 450)**

Enabling TLS for e-mailing (MF249dw / MF246dn)

- If the SMTP server and the POP3 server support TLS, you can enable TLS for communication with these servers (▶ **Configuring E-Mail Communication Settings(P. 363)**). For more information about the SMTP server and the POP3 server, contact your Internet service provider or Network Administrator.

LINKS

- ▶ **Generating Key Pairs(P. 436)**
- ▶ **Using CA-issued Key Pairs and Digital Certificates(P. 443)**
- ▶ **Configuring IEEE 802.1X Authentication(P. 429)**
- ▶ **Monitoring and Controlling the Machine with SNMP(P. 386)**

Configuring IEEE 802.1X Authentication

14L7-089

The machine can connect to an 802.1X network as a client device. A typical 802.1X network consists of a RADIUS server (authentication server), LAN switch (authenticator), and client devices with authentication software (supplicants). If a device tries to connect to the 802.1X network, the device must go through user authentication in order to prove that the connection is made by an authorized user. Authentication information is sent to and checked by a RADIUS server, which permits or rejects communication to the network depending on the authentication result. If authentication fails, a LAN switch (or an access point) blocks access from the outside of the network.

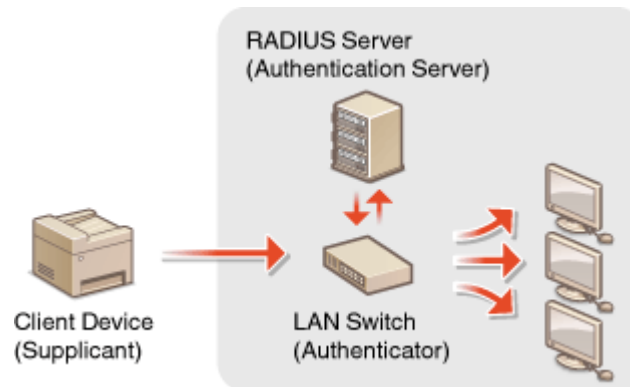

Select the authentication method from the options below. If necessary, install or register a key pair or CA certificate before configuring IEEE 802.1X authentication ([▶Using CA-issued Key Pairs and Digital Certificates\(P. 443\)](#)).

TLS

The machine and the authentication server authenticate each other by mutually verifying their certificates. A key pair issued by a certification authority (CA) is required for the client authentication (when authenticating the machine). For the server authentication, a CA certificate installed via the Remote UI can be used in addition to a CA certificate preinstalled in the machine.

TTLS

This authentication method uses a user name and password for the client authentication and a CA certificate for the server authentication. MSCHAPv2 or PAP can be selected as the internal protocol. TTLS can be used with PEAP at the same time. Enable TLS for the Remote UI before configuring this authentication method ([▶Enabling TLS Encrypted Communication for the Remote UI\(P. 426\)](#)).

PEAP

The required settings are almost the same as those of TTLS. MS-CHAPv2 is used as the internal protocol. Enable TLS for the Remote UI before configuring this authentication method ([▶Enabling TLS Encrypted Communication for the Remote UI\(P. 426\)](#)).

- 1 Start the Remote UI and log on in System Manager Mode. [▶Starting Remote UI\(P. 450\)](#)**
- 2 Click [Settings/Registration].**

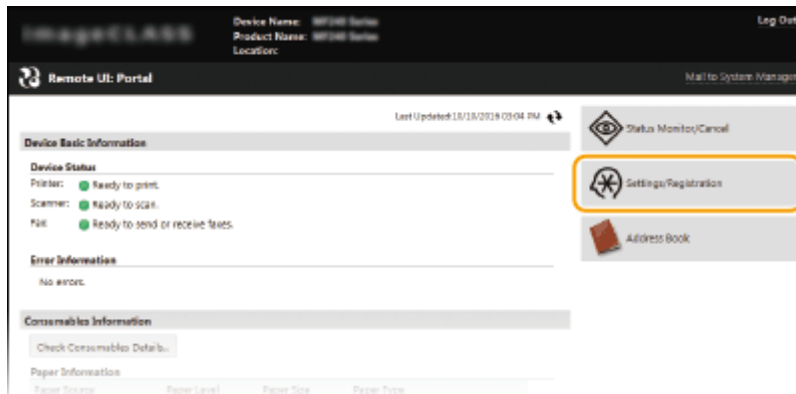

3 Click [Network Settings] ► [IEEE 802.1X Settings].

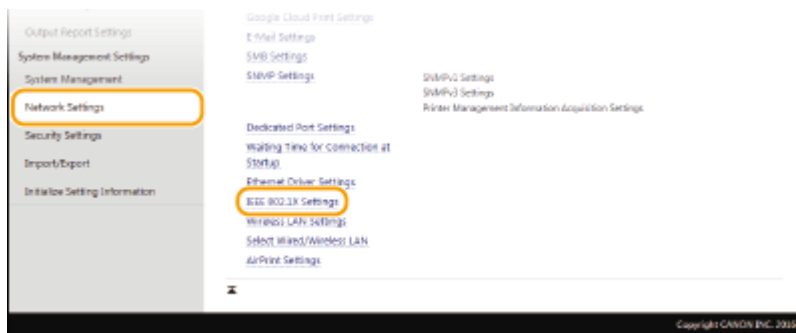

4 Click [Edit].

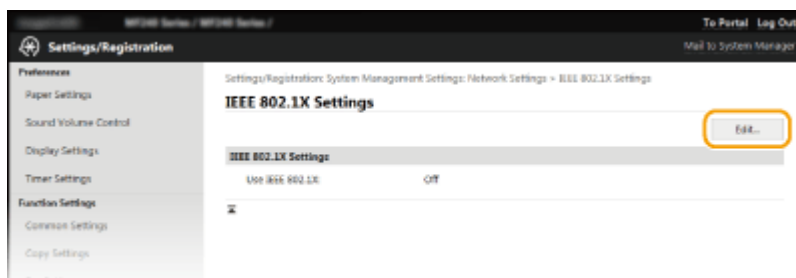

5 Select the [Use IEEE 802.1X] check box, enter the login name in the [Login Name] text box, and specify the required settings.

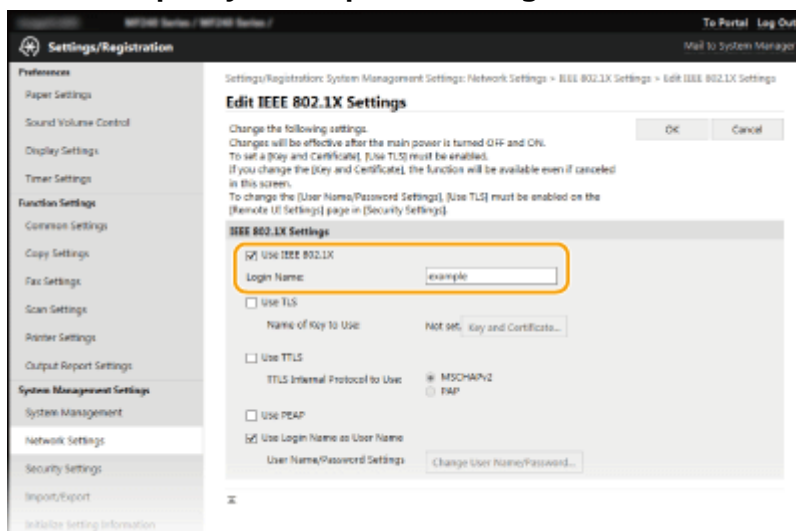

[Use IEEE 802.1X]

Select the check box to enable IEEE 802.1X authentication.

[Login Name]

Enter up to 24 alphanumeric characters for a name (EAP identity) that is used for identifying the user.

■ Setting TLS

- 1 Select the [Use TLS] check box and click [Key and Certificate].
- 2 Click [Register Default Key] on the right of the key pair you want to use for the client authentication.

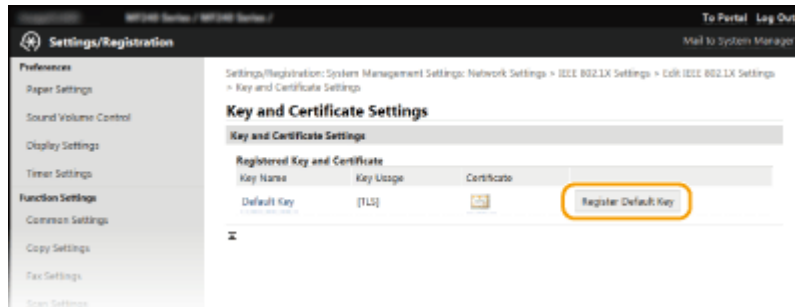

NOTE:

Viewing details of a key pair or certificate

- You can check the details of the certificate or verify the certificate by clicking the corresponding text link under [Key Name], or the certificate icon. [▶ Verifying Key Pairs and Digital Certificates\(P. 446\)](#)

■ Setting TTLS/PEAP

- 1 Select the [Use TTLS] or [Use PEAP] check box.

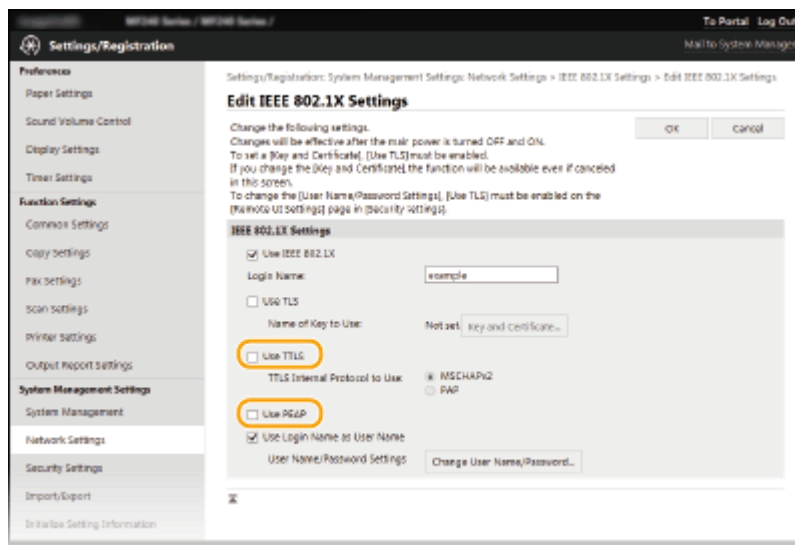

NOTE:

Internal protocol for TTLS

- You can select MSCHAPv2 or PAP. If you want to use PAP, click the [PAP] radio button.

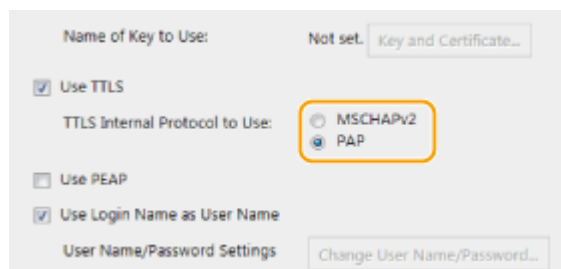

2 Click [Change User Name/Password].

- To specify a user name other than the login name, clear the [Use Login Name as User Name] check box. Select the check box if you want to use the login name as the user name.

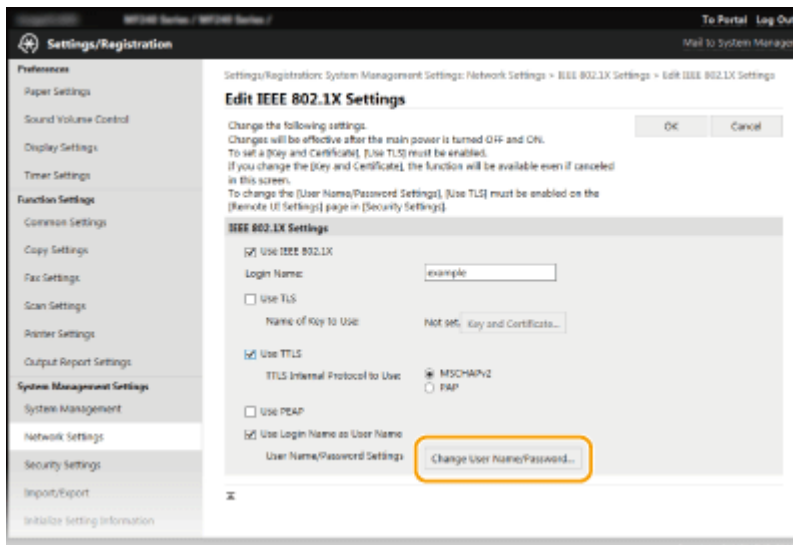

3 Set the user name/password and click [OK].

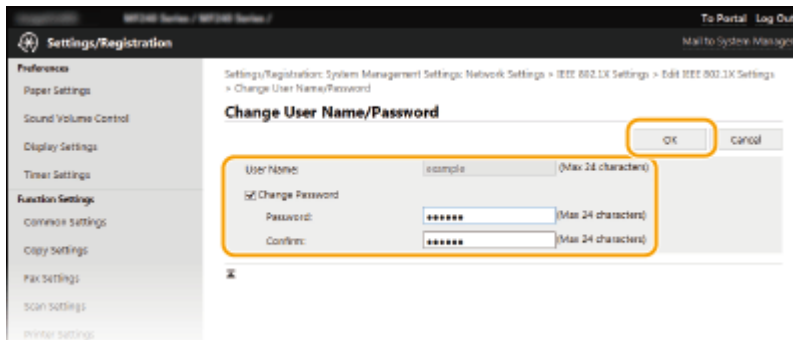

[User Name]

Enter up to 24 alphanumeric characters for the user name.

[Change Password]

To set or change the password, select the check box and enter up to 24 alphanumeric characters for the new password both in the [Password] and [Confirm] text boxes.

6 Click [OK].

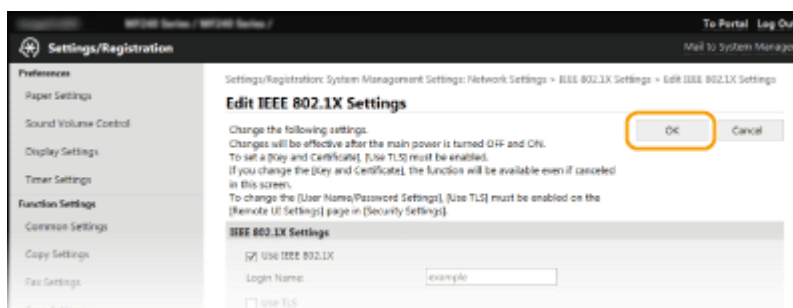

7 Restart the machine.

- Turn OFF the machine, wait for at least 10 seconds, and turn it back ON.

NOTE

Using the operation panel

- You can also enable or disable IEEE 802.1X authentication from <Menu> in the <Home> screen. [▶IEEE 802.1X Settings\(P. 482\)](#)

LINKS

- ▶ [Configuring Settings for Key Pairs and Digital Certificates\(P. 434\)](#)

Configuring Settings for Key Pairs and Digital Certificates

14L7-08A

In order to encrypt communication with a remote device, an encryption key must be sent and received over an unsecured network beforehand. This problem is solved by public-key cryptography. Public-key cryptography ensures secure communication by protecting important and valuable information from attacks, such as sniffing, spoofing, and tampering of data as it flows over a network.

Key Pair



A key pair consists of a public key and a secret key, both of which are required for encrypting or decrypting data. Because data that has been encrypted with one of the key pair cannot be returned to its original data form without the other, public-key cryptography ensures secure communication of data over the network. A key pair is used for TLS encrypted communication or TLS of the IEEE 802.1X authentication. Up to five key pairs (including the preinstalled pairs) can be generated to the machine ([Using CA-issued Key Pairs and Digital Certificates\(P. 443\)](#)). A key pair can be generated with the machine ([Generating Key Pairs\(P. 436\)](#)).

CA Certificate



Digital certificates including CA certificates are similar to other forms of identification, such as driver's licenses. A digital certificate contains a digital signature, which enables the machine to detect any spoofing or tampering of data. It is extremely difficult for third parties to abuse digital certificates. A digital certificate that contains a public key of a certification authority (CA) is referred to as a CA certificate. CA certificates are used for verifying the device the machine is communicating with for features such as printing with Google Cloud Print or IEEE 802.1X authentication. Up to 67 CA certificates can be registered, including the 62 certificates that are preinstalled in the machine ([Using CA-issued Key Pairs and Digital Certificates\(P. 443\)](#)).

■ Key and Certificate Requirements

The certificate contained in a key pair generated with the machine conforms to X.509v3. If you install a key pair or a CA certificate from a computer, make sure that they meet the following requirements:

Format	<ul style="list-style-type: none"> Key pair: PKCS#12^{*1} CA certificate: X.509v1 or X.509v3, DER (encoded binary), PEM
File extension	<ul style="list-style-type: none"> Key pair: ".p12" or ".pfx" CA certificate: ".cer"
Public key algorithm (and key length)	RSA (512 bits, 1024 bits, 2048 bits, or 4096 bits)
Certificate signature algorithm	SHA1-RSA, SHA256-RSA, SHA384-RSA ^{*2} , SHA512-RSA ^{*2} , MD5-RSA, or MD2-RSA
Certificate thumbprint algorithm	SHA1

^{*1} Requirements for the certificate contained in a key pair are pursuant to CA certificates.

^{*2} SHA384-RSA and SHA512-RSA are available only when the RSA key length is 1024 bits or more.

NOTE

- The machine does not support use of a certificate revocation list (CRL).

Generating Key Pairs

14L7-08C

A key pair can be generated with the machine when it is required for encrypted communication via Transport Layer Security (TLS). You can use TLS when accessing the machine via the Remote UI. Up to five key pairs (including the preinstalled pairs) can be generated to the machine. Self-signed certificates are used with key pairs generated in "Network Communication". With a "Key and Certificate Signing Request (CSR)", you can apply for a CA-issued digital certificate for the key pair generated by the machine.

- ▶ **Generate Network Communication Key(P. 436)**
- ▶ **Generate Key and Certificate Signing Request (CSR)(P. 438)**

Generate Network Communication Key

- 1 Start the Remote UI and log on in System Manager Mode. ▶ Starting Remote UI(P. 450)**
- 2 Click [Settings/Registration].**

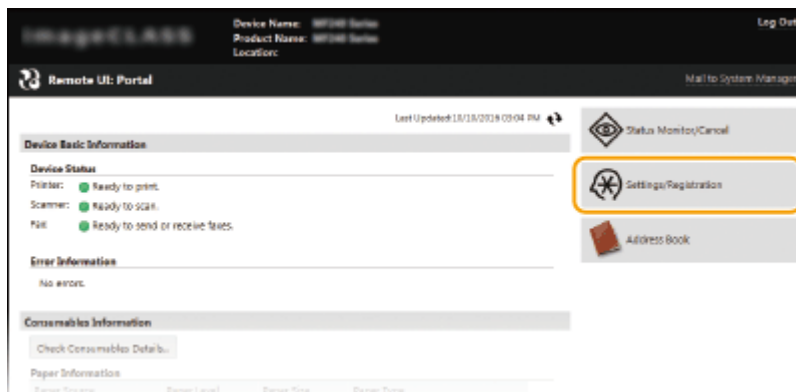

- 3 Click [Security Settings] ▶ [Key and Certificate Settings].**

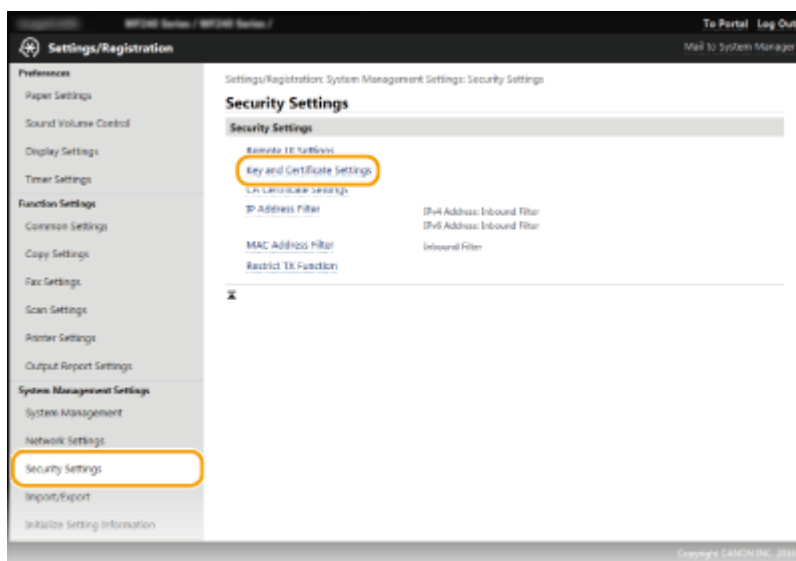

4 Click [Generate Key].

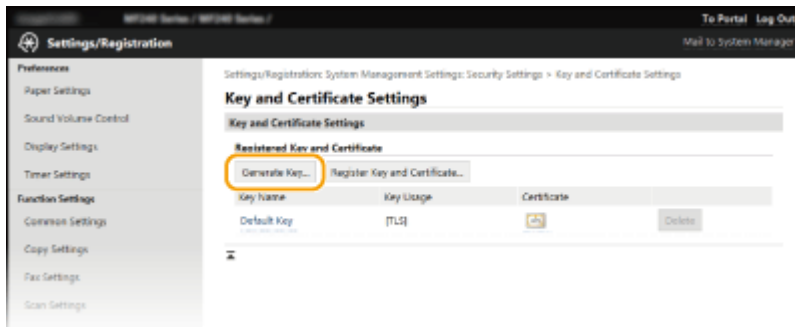

NOTE:

Deleting a registered key pair

- Click [Delete] on the right of the key pair you want to delete ► click [OK].
- A key pair cannot be deleted if it is currently used for some purpose, such as when "[TLS]" or "[IEEE 802.1X]" is displayed under [Key Usage]. In this case, disable the function or replace the key pair before deleting it.

5 Select [Network Communication] and click [OK].

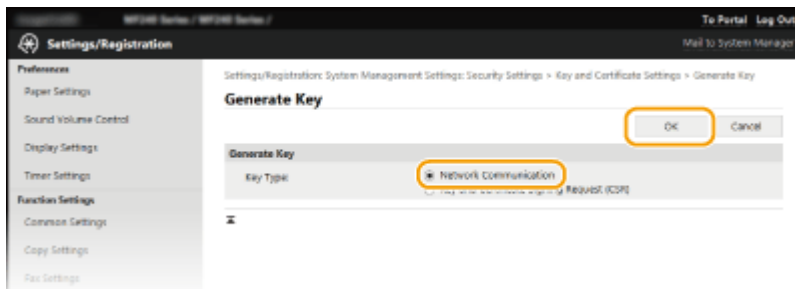

6 Specify settings for the key and certificate.

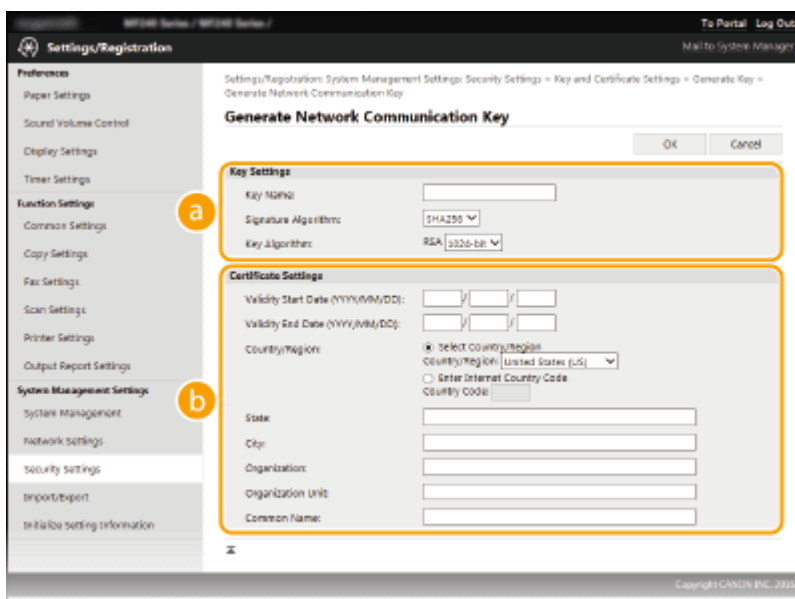

a [Key Settings]

[Key Name]

Enter up to 24 alphanumeric characters for naming the key pair. Set a name that will be easy for you to find later in a list.

[Signature Algorithm]

Select the signature algorithm from the drop-down list.

[Key Algorithm]

RSA is used for generating a key pair. Select the key length from the drop-down list. The larger the number for the key length, the slower the communication. However, the security is tighter.

NOTE:

- [512-bit] cannot be selected for the key length, if [SHA384] or [SHA512] is selected for [Signature Algorithm].

b [Certificate Settings]

[Validity Start Date (YYYY/MM/DD)]

Enter the validity start date of the certificate in the range between 01/01/2000 and 31/12/2099, in the order of: year, month, day.

[Validity End Date (YYYY/MM/DD)]

Enter the validity end date of the certificate in the range between 01/01/2000 and 31/12/2099, in the order of: year, month, day. A date earlier than [Validity Start Date (YYYY/MM/DD)] cannot be set.

[Country/Region]

Click the [Select Country/Region] radio button and select the country/region from the drop-down list. You can also click the [Enter Internet Country Code] radio button and enter a country code, such as "US" for the United States.

[State]/[City]

Enter up to 24 alphanumeric characters for the location as necessary.

[Organization]/[Organization Unit]

Enter up to 24 alphanumeric characters for the organization name as necessary.

[Common Name]

Enter up to 48 alphanumeric characters for the common name of the certificate as necessary. "Common Name" is often abbreviated as "CN."

7 Click [OK].

- Keys for network communication may take approximately 10 to 15 minutes to generate.
- After a key pair is generated, it is automatically registered to the machine.

Generate Key and Certificate Signing Request (CSR)

1 Start the Remote UI and log on in System Manager Mode.

▶ Starting Remote UI(P. 450)

2 Click [Settings/Registration].

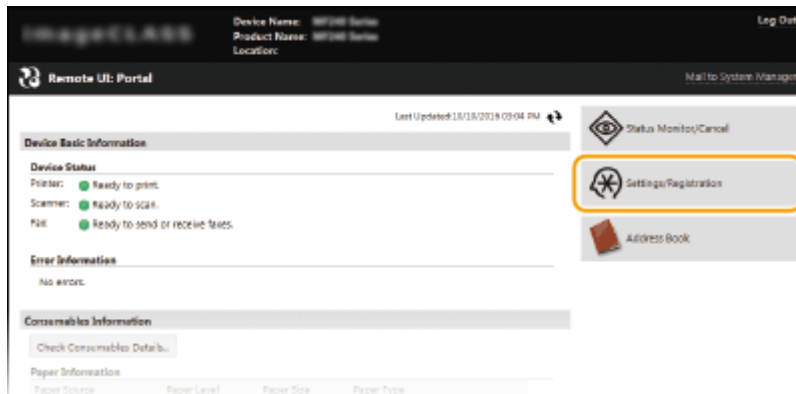

3 Click [Security Settings] ► [Key and Certificate Settings].

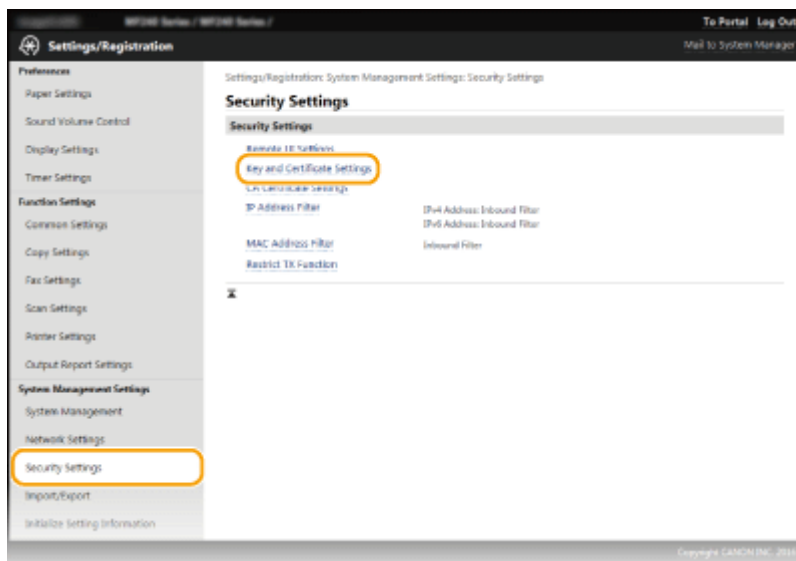

4 Click [Generate Key].

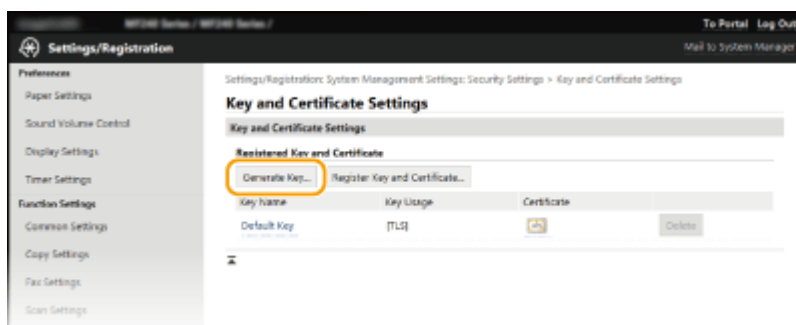

NOTE:

Deleting a registered key pair

- Click [Delete] on the right of the key pair you want to delete ► click [OK].
- A key pair cannot be deleted if it is currently used for some purpose, such as when "[TLS]" or "[IEEE 802.1X]" is displayed under [Key Usage]. In this case, disable the function or replace the key pair before deleting it.

5 Select [Key and Certificate Signing Request (CSR)] and click [OK].

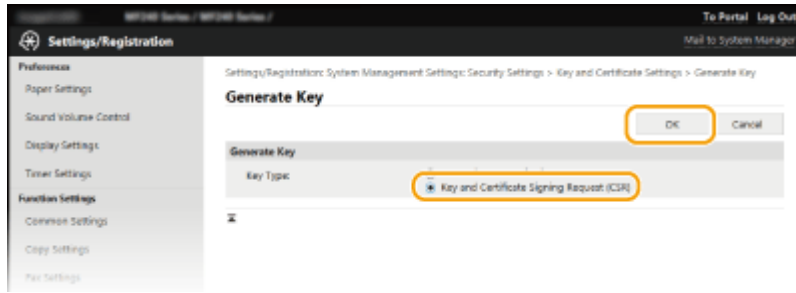

6 Specify settings for the key and certificate.

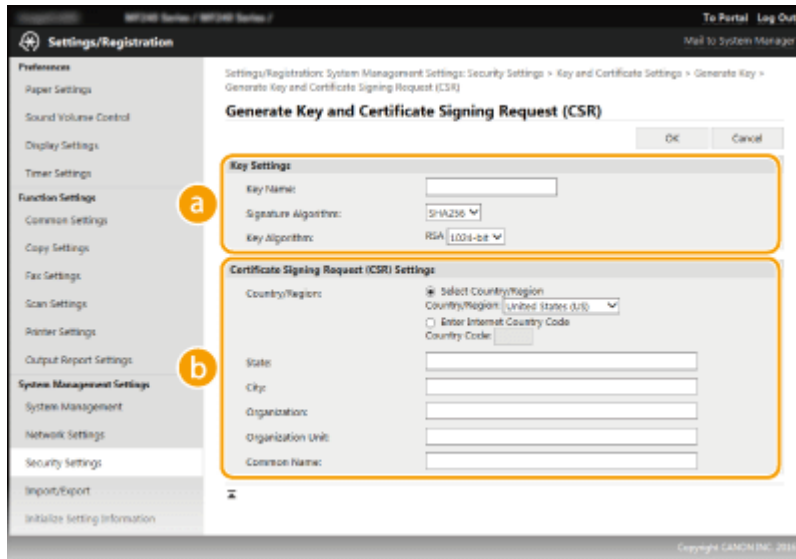

a [Key Settings]

[Key Name]

Enter up to 24 alphanumeric characters for naming the key pair. Set a name that will be easy for you to find later in a list.

[Signature Algorithm]

Select the signature algorithm from the drop-down list.

[Key Algorithm]

RSA is used for generating a key pair. Select the key length from the drop-down list. The larger the number for the key length, the slower the communication. However, the security is tighter.

NOTE:

- [512-bit] cannot be selected for the key length, if [SHA384] or [SHA512] is selected for [Signature Algorithm].

b [Certificate Signing Request (CSR) Settings]

[Country/Region]

Click the [Select Country/Region] radio button and select the country/region from the drop-down list. You can also click the [Enter Internet Country Code] radio button and enter a country code, such as "US" for the United States.

[State]/[City]

Enter up to 24 alphanumeric characters for the location as necessary.

[Organization]/[Organization Unit]

Enter up to 24 alphanumeric characters for the organization name as necessary.

[Common Name]

Enter up to 48 alphanumeric characters for the common name of the certificate as necessary. "Common Name" is often abbreviated as "CN."

7 Click [OK].

- Key and Certificate Signing Request (CSR) may take approximately 10 to 15 minutes to generate.

8 Click [Store in File].

- A dialog box for storing the file appears. Choose where to store the file and click [Save].

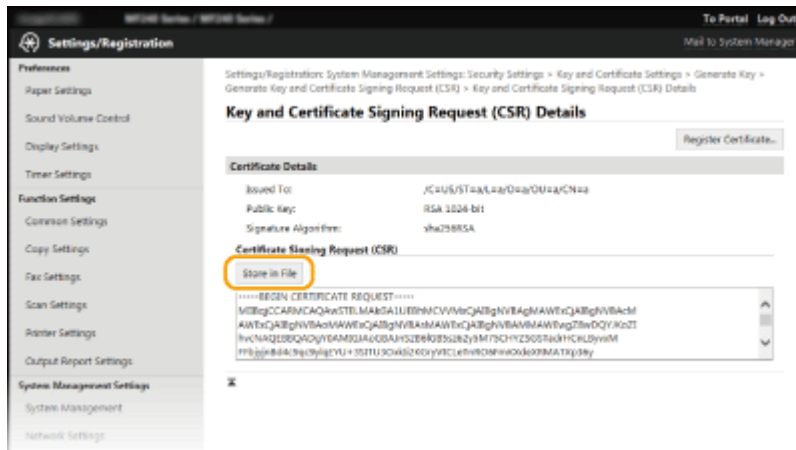

⇒ The Key and Certificate Signing Request (CSR) file is stored on the computer.

9 Attach the stored file and submit the application to the certification authority.

■ Registering the CA-issued Digital Certificate

You cannot use the key pair generated by the Certificate Signing Request (CSR) until the certificate is registered. Once the certification authority has issued the digital certificate, register it using the procedure below.

1 Start the Remote UI and log on in Administrator mode.

▶ Starting Remote UI(P. 450)

2 Click [Settings/Registration].

3 Click [Security Settings] ▶ [Key and Certificate Settings].

4 Click [Key Name] or [Certificate] for the certificate to be registered.

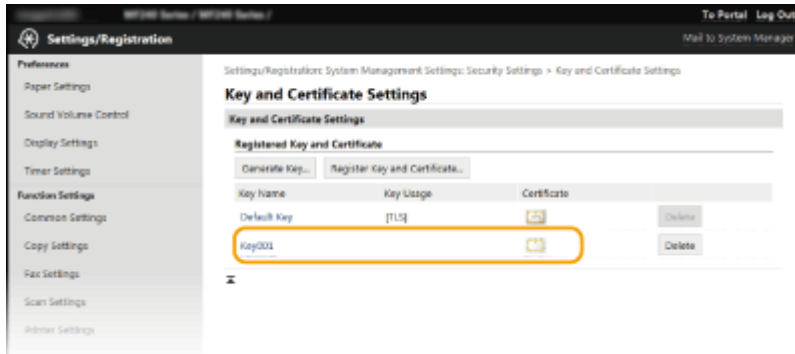

5 Click [Register Certificate].

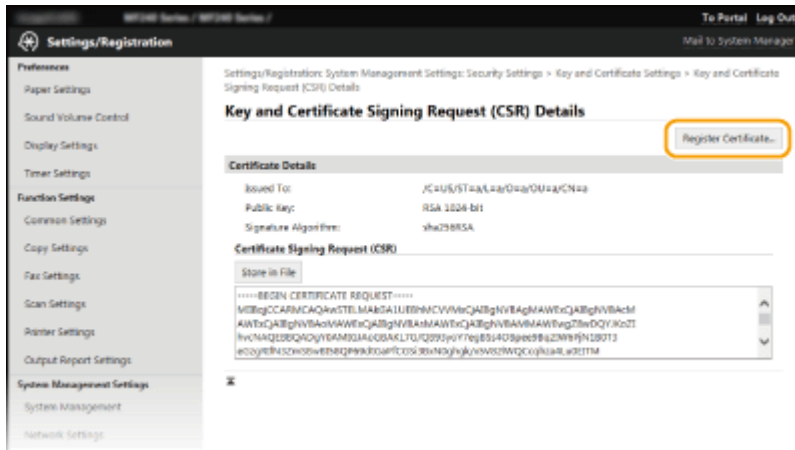

6 Click [Browse], specify the file for the certificate signing request, and click [Register].

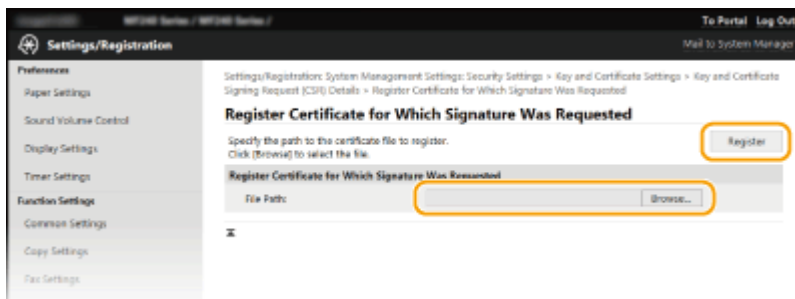

LINKS

- ▶ Using CA-issued Key Pairs and Digital Certificates(P. 443)
- ▶ Verifying Key Pairs and Digital Certificates(P. 446)
- ▶ Enabling TLS Encrypted Communication for the Remote UI(P. 426)

Using CA-issued Key Pairs and Digital Certificates

14L7-08E

Key pairs and digital certificates can be obtained from a certification authority (CA) for use with the machine. You can store and then register these files by using the Remote UI. Make sure that the key pair and the certificate satisfy the requirements of the machine ([▶Key and Certificate Requirements\(P. 434\)](#)). Up to five key pairs (including the preinstalled key pairs) and up to 67 CA certificates (including the 62 preinstalled certificates) can be registered.



1 Start the Remote UI and log on in System Manager Mode. [▶Starting Remote UI\(P. 450\)](#)

2 Click [Settings/Registration].

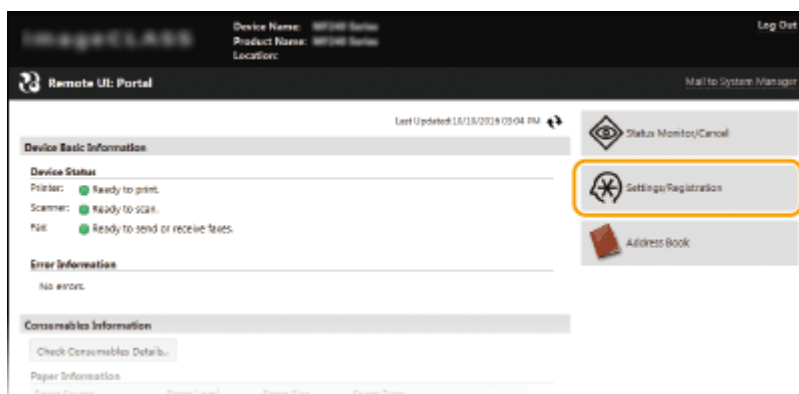

3 Click [Security Settings] ▶ [Key and Certificate Settings] or [CA Certificate Settings].

- Click [Key and Certificate Settings] to install a key pair, or [CA Certificate Settings] to install a CA certificate.

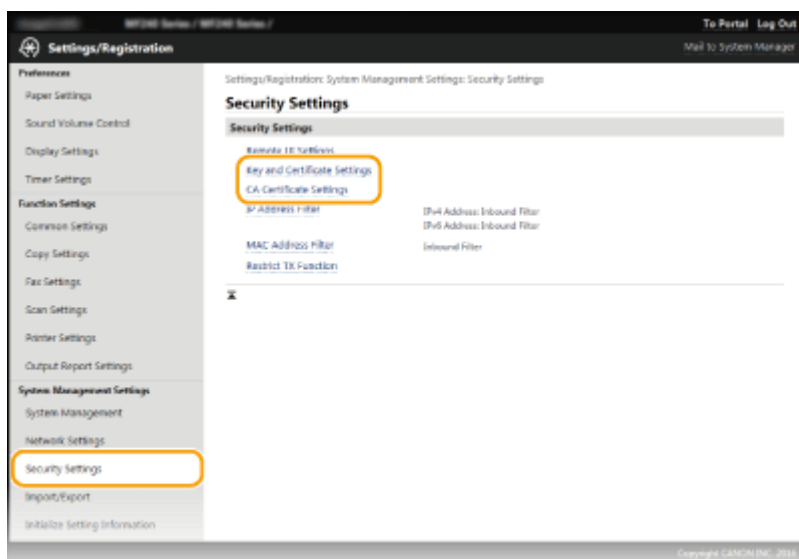

4 Click [Register Key and Certificate] or [Register CA Certificate].

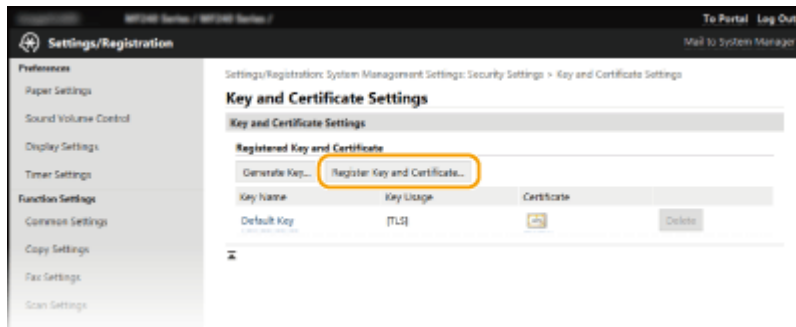

NOTE:

Deleting a registered key pair or CA certificate

- Click [Delete] on the right of the key pair or CA certificate you want to delete ► click [OK]. You cannot delete the preinstalled CA certificates.
- A key pair cannot be deleted if it is currently used for some purpose, such as when "[TLS]" or "[IEEE 802.1X]" is displayed under [Key Usage]. In this case, disable the function or replace the key pair before deleting it. The preinstalled CA certificate cannot be deleted.

Disabling or enabling the preinstalled CA certificates

- Click [Disable] on the right of the preinstalled CA certificate you want to disable. To enable the certificate again, click [Enable] on the right of the certificate.

5 Click [Install].

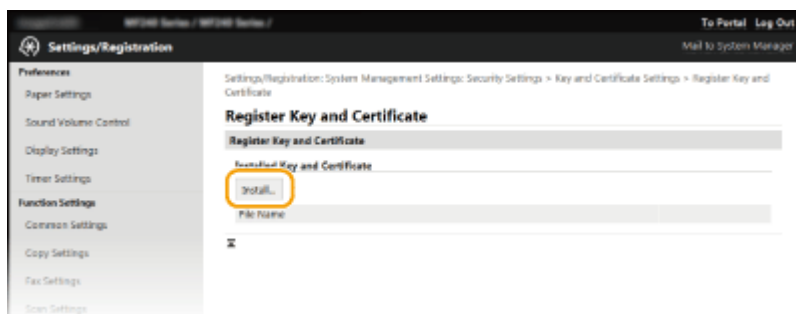

NOTE:

Deleting a key pair or CA certificate file

- Click [Delete] on the right of the file you want to delete ► click [OK].

6 Click [Browse], specify the file to install, and click [Start Installation].

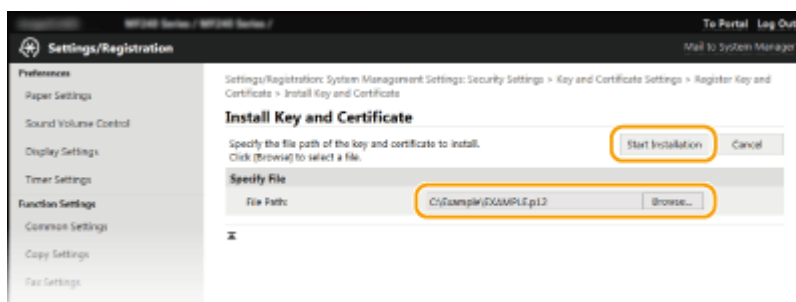

► The key pair or CA certificate is installed in the machine.

7 Register the key pair or CA certificate.

■ Registering a key pair

- 1 Click [Register] on the right of the key pair you want to register.
- 2 Enter the name of the key pair and password, and then click [OK].

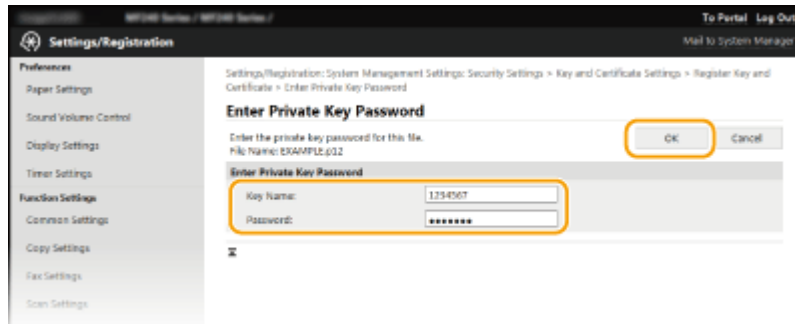

[Key Name]

Enter up to 24 alphanumeric characters for the name of the key pair to be registered.

[Password]

Enter up to 24 alphanumeric characters for the password of the private key set for the file to be registered.

■ Registering a CA certificate

Click [Register] on the right of the CA certificate you want to register.

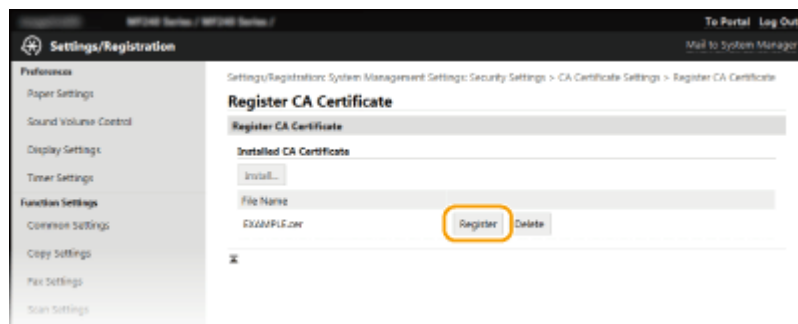

LINKS

- ▶ [Generating Key Pairs\(P. 436\)](#)
- ▶ [Verifying Key Pairs and Digital Certificates\(P. 446\)](#)
- ▶ [Enabling TLS Encrypted Communication for the Remote UI\(P. 426\)](#)
- ▶ [Configuring IEEE 802.1X Authentication\(P. 429\)](#)

Verifying Key Pairs and Digital Certificates

14L7-08F

Once key pairs and CA certificates are registered, you can view their detailed information or verify them for validity and signature.

- 1 Start the Remote UI and log on in System Manager Mode. ▶ Starting Remote UI(P. 450)
- 2 Click [Settings/Registration].

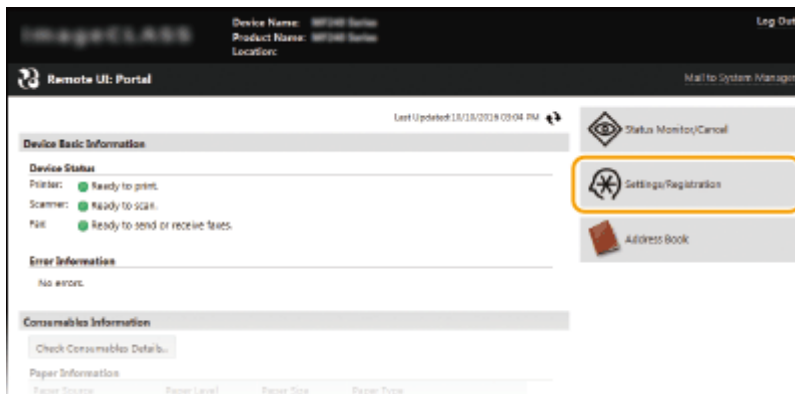

- 3 Click [Security Settings] ▶ [Key and Certificate Settings] or [CA Certificate Settings].
 - Click [Key and Certificate Settings] to verify a key pair, or [CA Certificate Settings] to verify a CA certificate.

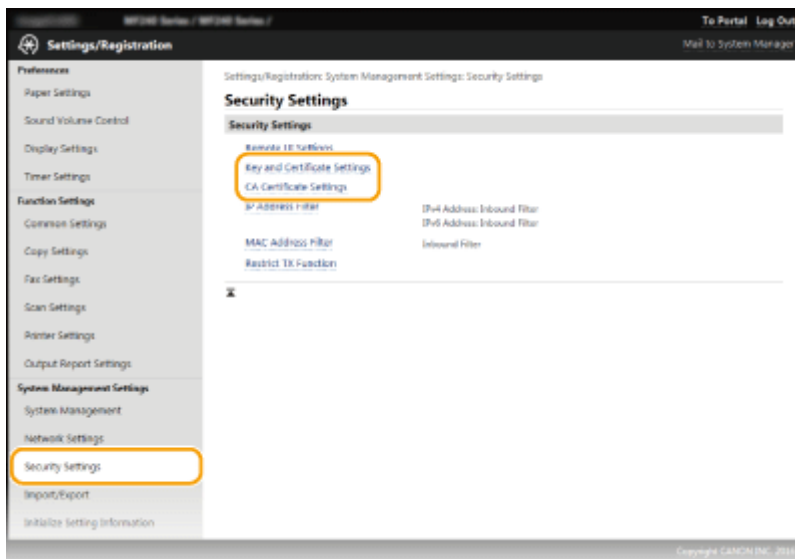

- 4 Click the icon for the key pair or certificate that you want to verify.

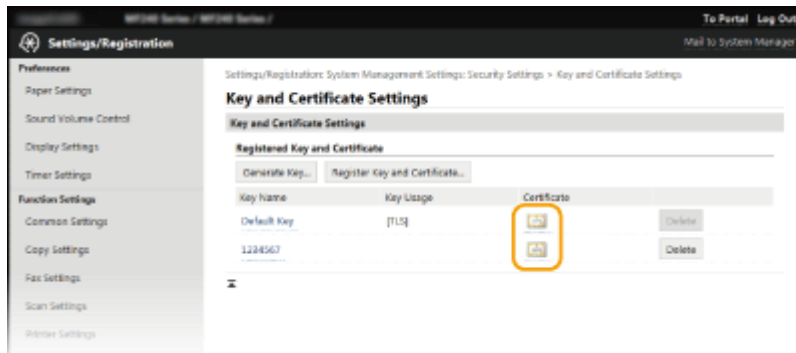

⇒ Certificate details can be viewed on this screen.

5 Check the details of the certificate, and click [Verify Certificate].

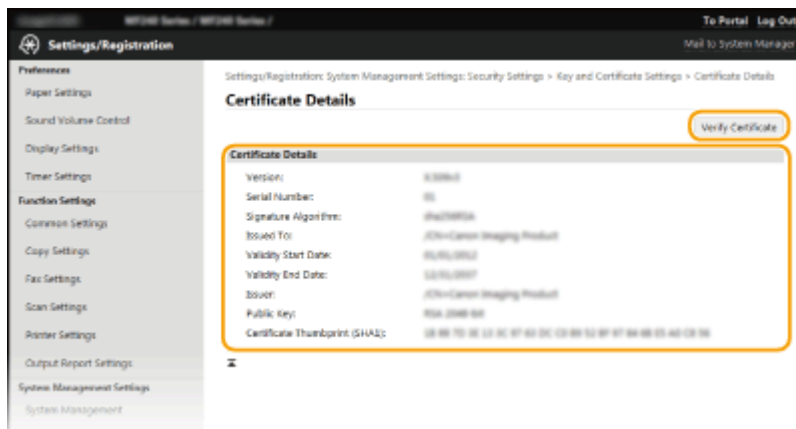

⇒ The result from verifying the certificate is displayed as shown below.

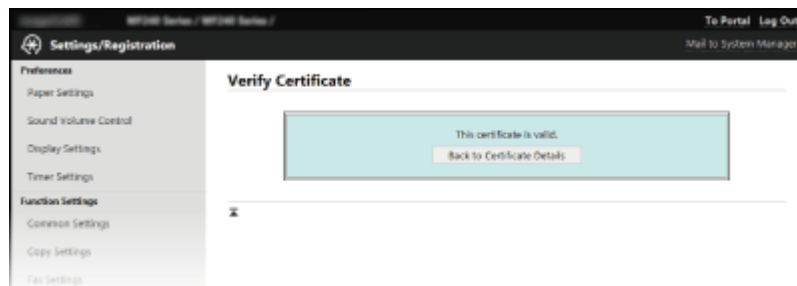

LINKS

- ▶ [Generating Key Pairs\(P. 436\)](#)
- ▶ [Using CA-issued Key Pairs and Digital Certificates\(P. 443\)](#)

Using Remote UI (MF249dw / MF246dn / MF237w)

Using Remote UI (MF249dw / MF246dn / MF237w)	449
Starting Remote UI	450
Remote UI Screens	452
Managing Documents and Checking the Machine Status	456
Setting Up Menu Options from Remote UI	461
Saving/Loading Address Book from Remote UI	463
Registering Address Book from Remote UI	467

Using Remote UI MF249dw / MF246dn / MF237w

14L7-08H

Using a Web browser to operate the machine remotely, you can check the documents waiting to be printed or the status of the machine. You can also make some settings such as registering the Address Book. You can do this without leaving your desk, making system management easier.

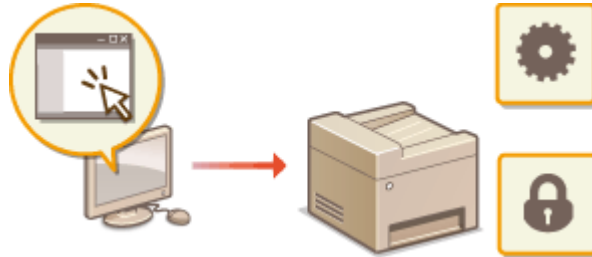

Functions of the Remote UI

- ▶ **Managing Documents and Checking the Machine Status(P. 456)**
- ▶ **Setting Up Menu Options from Remote UI(P. 461)**
- ▶ **Saving/Loading Address Book from Remote UI(P. 463)**
- ▶ **Registering Address Book from Remote UI(P. 467)**

Basics of the Remote UI

- ▶ **Starting Remote UI(P. 450)**
- ▶ **Remote UI Screens(P. 452)**

System Requirements

The following environment is required to use the Remote UI. In addition, set the Web browser to enable Cookies.

Windows

- Windows Vista/7/8/10
- Microsoft Internet Explorer 7.0 or later

Mac OS

- Mac OS 10.6 or later (except for Classic environment)
- Safari 3.2.1 or later

Starting Remote UI

14L7-08J

To operate remotely, you need to input the IP address of the machine into a Web browser and start the Remote UI. Check the IP address set to the machine in advance ([▶Viewing Network Settings\(P. 344\)](#)). If you have any questions, ask your Network Administrator.

1 Start the Web browser.

2 Enter "http://(the IP address of the machine)/" in the address field, and press the [ENTER] key.

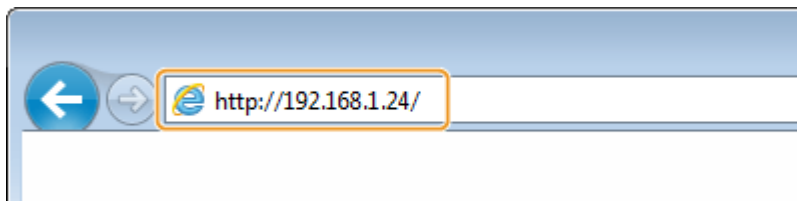

- If you want to use an IPv6 address, enclose the IPv6 address with brackets (example: http://[fe80::2e9e:fcff:fe4e:dbce]/).

NOTE:

If a security alert is displayed

- A security alert may be displayed if communication with an Apple device is encrypted ([▶Enabling TLS Encrypted Communication for the Remote UI\(P. 426\)](#)). When certificate settings or TLS settings have no errors, continue browsing the Web site.
- A security alert may be displayed when the Remote UI communication is encrypted ([▶Enabling TLS Encrypted Communication for the Remote UI\(P. 426\)](#)). When certificate settings or TLS settings have no errors, continue browsing the website.

3 Log on to the Remote UI.

■When a System Manager PIN is not set

Select [System Manager Mode] or [General User Mode].

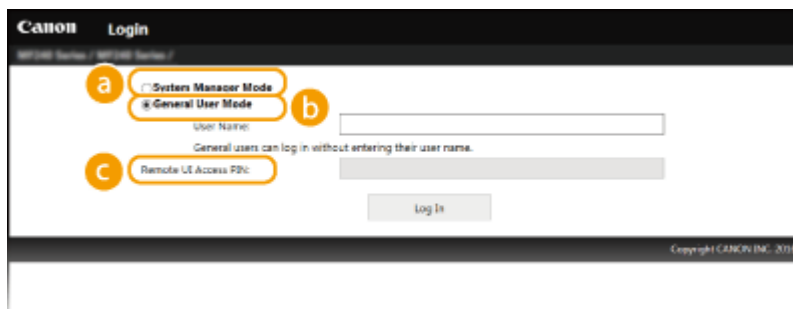

a [System Manager Mode]

You can perform all the Remote UI operations and settings. Enter the appropriate PIN in [System Manager PIN] ([▶Setting the System Manager PIN\(P. 397\)](#)). If [System Manager PIN] is not set, you do not need to input anything.

b [General User Mode]

You can check the status of documents or the machine, and you can also change some of the settings. If you wish to delete your print documents, enter the user name of the documents in [User Name]. The user

name is automatically set to print documents based on information such as your computer name or computer logon name.

C [Remote UI Access PIN]

If [Remote UI Access PIN] is set, enter the PIN. **▶Setting a Remote UI PIN (MF249dw / MF246dn / MF237w)(P. 399)**

■When a System Manager PIN is set

Enter the registered [System Manager PIN]. **▶Setting the System Manager PIN(P. 397)**

4 Click [Log In].

- Portal Page (main page) will be displayed. **▶Remote UI Screens(P. 452)**

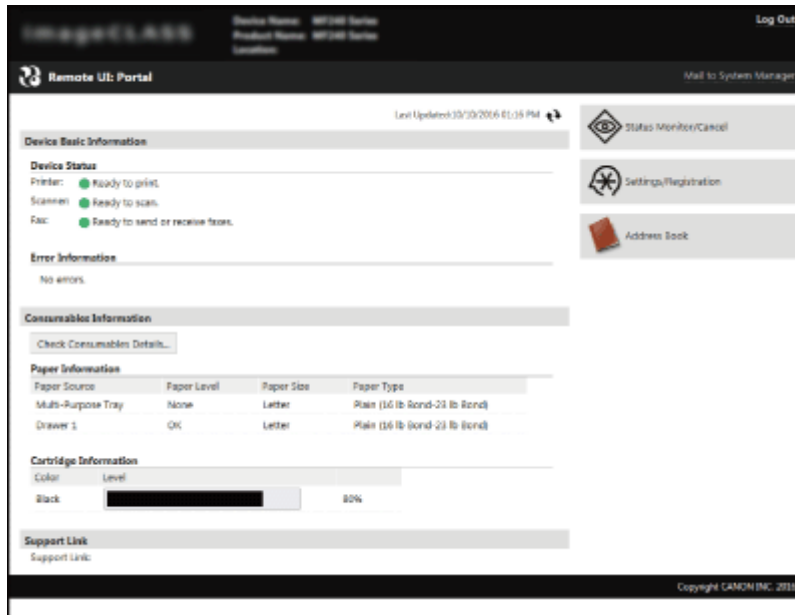

Remote UI Screens

This section describes the typical screens of the Remote UI.

- ▶ **Portal Page (Main Page)(P. 452)**
- ▶ **[Status Monitor/Cancel] Page(P. 453)**
- ▶ **[Settings/Registration] Page(P. 454)**
- ▶ **[Address Book] Page(P. 455)**

Portal Page (Main Page)

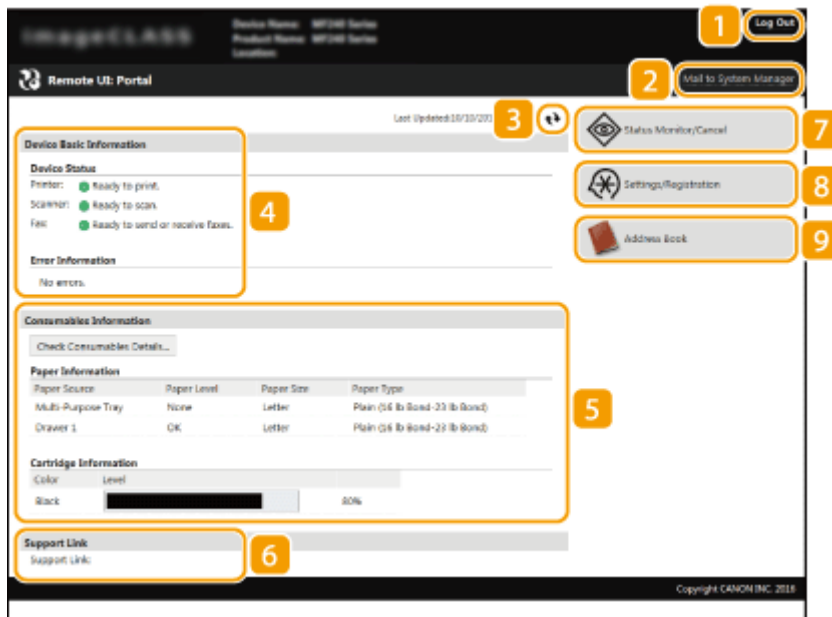

1 [Log Out]

Logs off from the Remote UI. The Login page will be displayed.

2 [Mail to System Manager]

Displays a window for creating an e-mail to the system manager specified in [System Manager Information] under [System Management].

3 Refresh Icon

Refreshes the currently displayed page.

4 Device Basic Information

Displays the current status of the machine and error information. If an error has occurred, the link to the Error Information page will be displayed.

5 Consumables Information

Displays paper information and the amount remaining in the toner cartridges.

Click [Check Consumables Details] to display the screen for checking consumables. ▶ **Checking Consumables(P. 458)**

6 Support Link

Displays the support link specified in [Device Information] under [System Management].

7 [Status Monitor/Cancel]

Displays the status of the current print documents and history of print, copy, send, and received documents. You can also check the status of the machine.

8 [Settings/Registration]

Displays [Settings/Registration] page. When you have logged on in System Manager Mode, you can change the settings items and save/load the registered data. ▶ **Setting Up Menu Options from Remote UI(P. 461)**

9 [Address Book]

Displays the destinations registered in the Address Book. You can also register or edit the Address Book when you have logged on in System Manager Mode. ▶ **Registering Address Book from Remote UI(P. 467)**

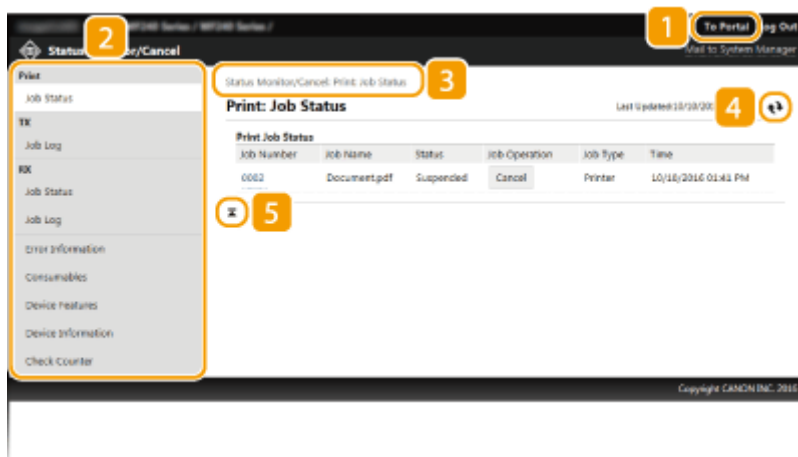
[Status Monitor/Cancel] Page**1 [To Portal]**

Returns to Portal Page (main page).

2 Menu

Click an item, and the content is displayed in the right page. ▶ **Managing Documents and Checking the Machine Status(P. 456)**

3 Breadcrumb Trail

Indicates the series of pages you opened to display the currently displayed page. You can check what page is currently displayed.

4 Refresh Icon

Refreshes the currently displayed page.

5 Top Icon

Moves the scroll box up to the top of the page when the page is scrolled down.

[Settings/Registration] Page

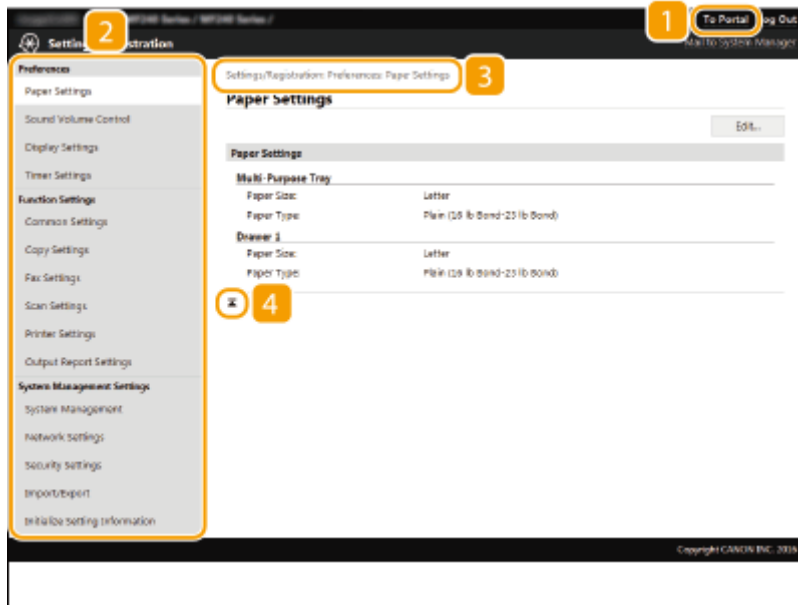

1 [To Portal]

Returns to Portal Page (main page).

2 Menu

Click an item, the content is displayed in the right page. ▶ **Setting Up Menu Options from Remote UI(P. 461)**

3 Breadcrumb Trail

Indicates the series of pages you opened to display the currently displayed page. You can check what page is currently displayed.

4 Top Icon

Moves the scroll box up to the top of the page when the page is scrolled down.

NOTE

System Management Settings

- You can only set [System Management Settings] when you have logged on in System Manager Mode.
- When you have logged on in General User Mode, only [System Management] will be displayed.

[Address Book] Page

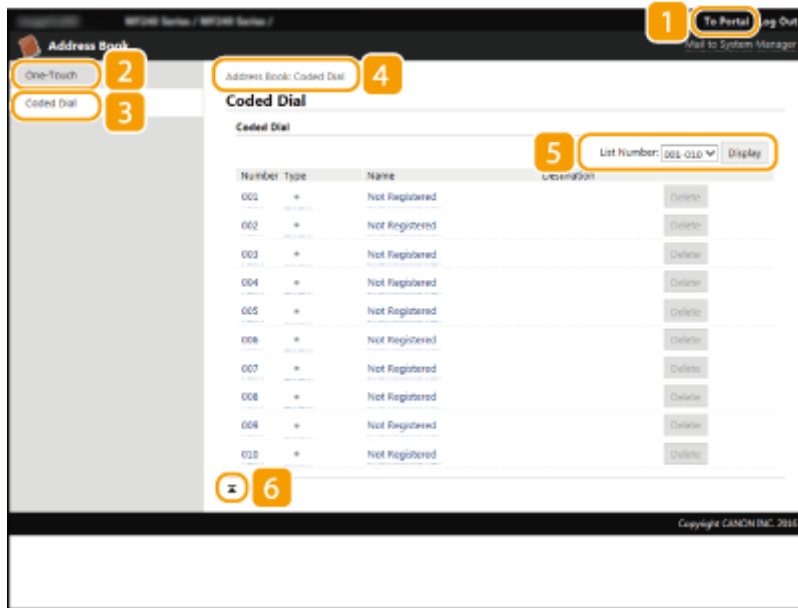
**1 [To Portal]**

Displays Portal Page (main page).

2 [One-Touch]

Displays the list of the One-Touch. ▶ **Registering in the Address Book(P. 60)**

3 [Coded Dial]

Displays the list of the coded dial numbers. ▶ **Registering in the Address Book(P. 60)**

4 Breadcrumb Trail

Indicates the series of pages you opened to display the currently displayed page. You can check what page is currently displayed.

5 List Number

Specifies the range of coded dial numbers displayed on the page.

6 Top Icon

Moves the scroll box up to the top of the page when the page is scrolled down.

NOTE**Registering/Editing the Address Book**

You can register or edit the Address Book when you have logged on in System Manager Mode.

Managing Documents and Checking the Machine Status

14L7-08L

- ▶ **Checking Current Status of Print Documents(P. 456)**
- ▶ **Checking the Status of Received Faxes(P. 457)**
- ▶ **Checking History of Documents(P. 457)**
- ▶ **Checking Error Information(P. 458)**
- ▶ **Checking Consumables(P. 458)**
- ▶ **Checking Maximum Print Speed(P. 459)**
- ▶ **Checking System Manager Information(P. 459)**
- ▶ **Checking Print Total Counter(P. 460)**

NOTE

The document file name displays only 255 characters. The printed application name may be added to the file name.

Checking Current Status of Print Documents

The list of the documents currently printing or waiting to be printed is displayed.



Log on to the Remote UI (▶ **Starting Remote UI(P. 450)**) ▶ [Status Monitor/Cancel] ▶ [Job Status] under [Print]

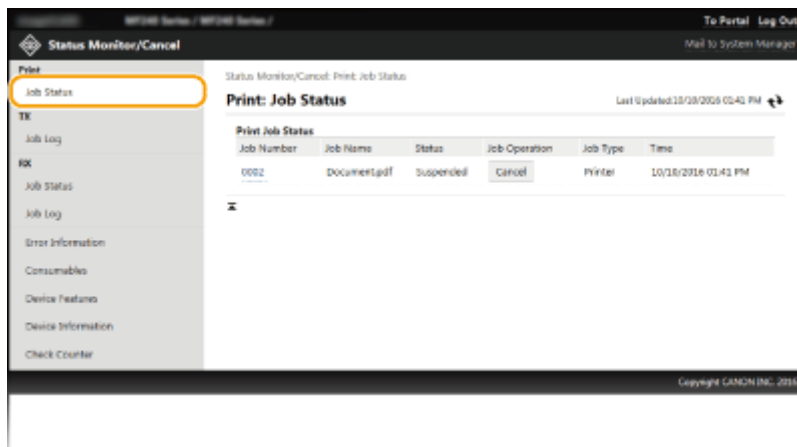

You can delete a document job by clicking [Cancel].

NOTE

- If you logged on in System Manager Mode, all the print documents currently printing and waiting to be printed will be listed.
- If you entered your user name when you logged on in General User Mode, your user name will only be displayed on the documents that you printed.

- Click [Job Number] on the paused documents to display detailed information. You can check the user name and the page count of the printed document.

Checking the Status of Received Faxes

You can check the status (printing/queued for printing) of up to 90 received faxes. You can also check a preview of received faxes stored in memory.



Log on to the Remote UI ([▶ Starting Remote UI\(P. 450\)](#)) ▶ [Status Monitor/Cancel] ▶ [Job Status] under [RX]

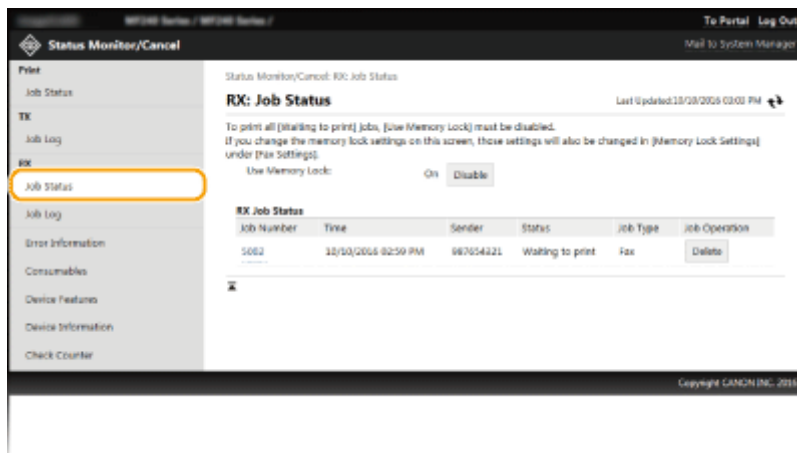

You can delete a document job by clicking [Delete].

NOTE

- Click [Job Number] while a fax job is waiting to be printed to view fax details. You can check the sender, number of prints, any received images, and other information. [▶ Previewing Documents from the Remote UI\(P. 152\)](#)

Checking History of Documents

The history of sending faxes/e-mails (TX) or receiving faxes (RX) is displayed.



Log on to the Remote UI ([▶ Starting Remote UI\(P. 450\)](#)) ▶ [Status Monitor/Cancel] ▶ [Job Log]

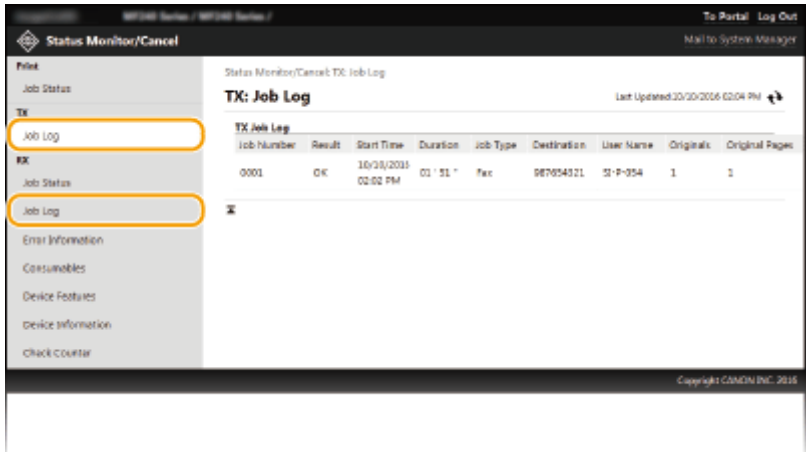

Checking Error Information

When an error occurs, this page will be displayed by clicking the message displayed under [Error Information] on Portal Page (main page). **Portal Page (Main Page)(P. 452)**

Log on to the Remote UI (**Starting Remote UI(P. 450)**) ▶ [Status Monitor/Cancel] ▶ [Error Information]

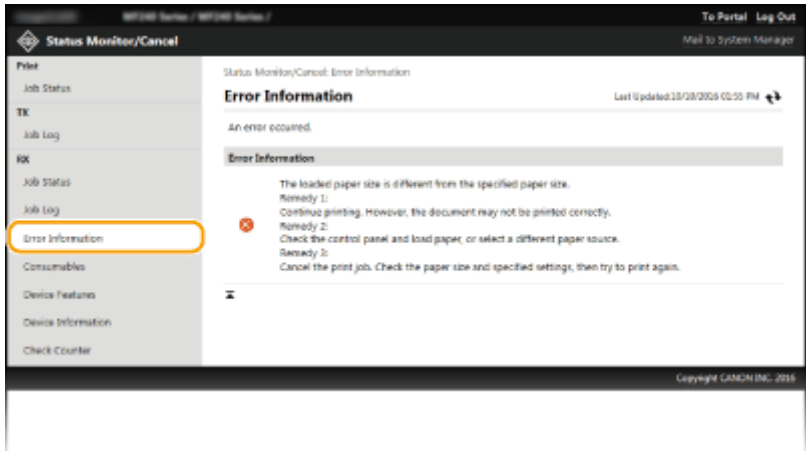

Checking Consumables

Paper size and paper type for the paper source, toner cartridge model number, etc. are displayed. You can also click [Check Consumables Details] in **Portal Page (Main Page)(P. 452)** to display this page.

Log on to the Remote UI (**Starting Remote UI(P. 450)**) ▶ [Status Monitor/Cancel] ▶ [Consumables]

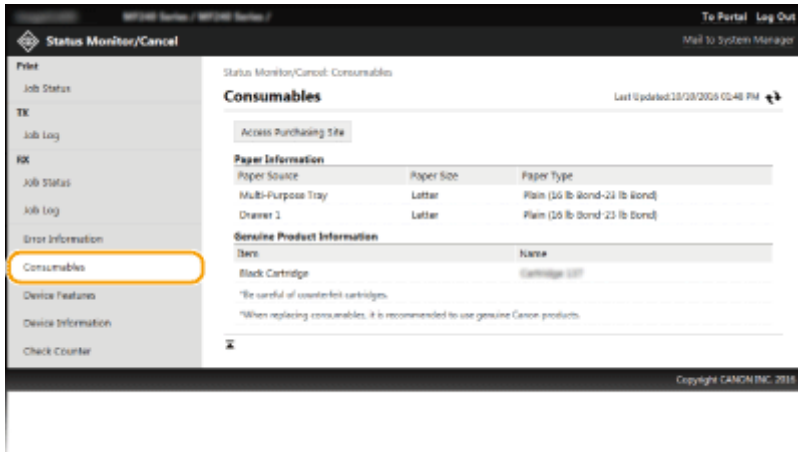

Checking Maximum Print Speed

The maximum print speed is displayed.

Log on to the Remote UI ([▶ Starting Remote UI\(P. 450\)](#)) ▶ [Status Monitor/Cancel] ▶ [Device Features]

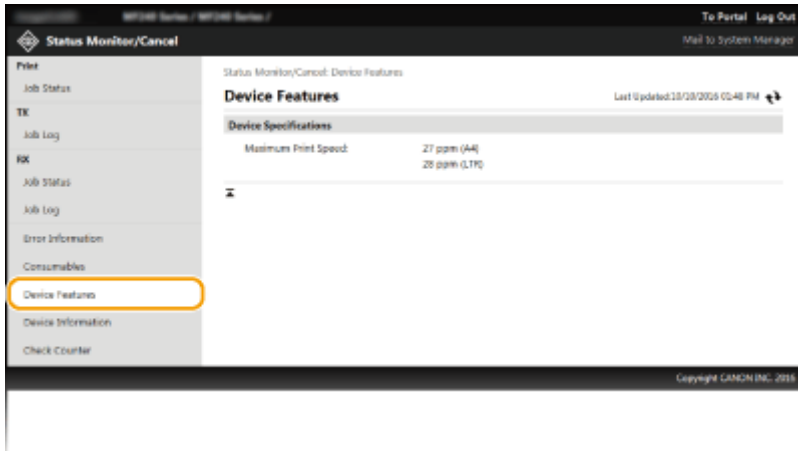

Checking System Manager Information

Information about the machine and the system manager is displayed. This information is set in [System Management] on the [Settings/Registration] page. [▶ System Management Settings\(P. 528\)](#)

Log on to the Remote UI ([▶ Starting Remote UI\(P. 450\)](#)) ▶ [Status Monitor/Cancel] ▶ [Device Information]

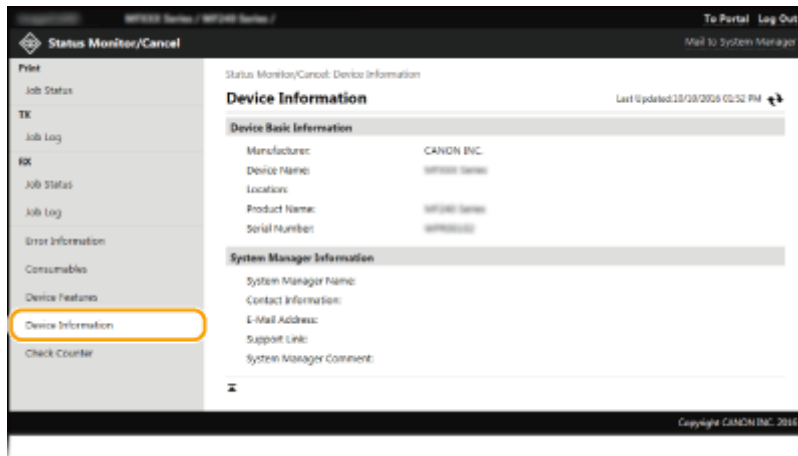

Checking Print Total Counter

The total number of pages that have been printed by the copy, print, and fax functions is displayed.



Log on to the Remote UI ([Starting Remote UI\(P. 450\)](#)) ▶ [Status Monitor/Cancel] ▶ [Check Counter]

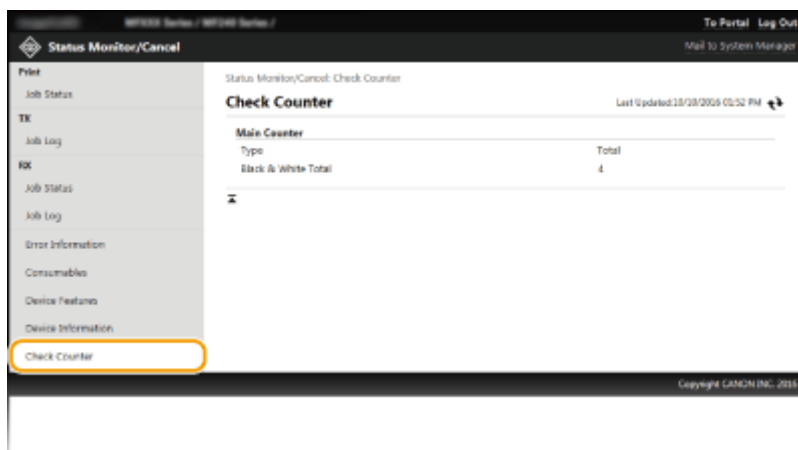

LINKS

[Remote UI Screens\(P. 452\)](#)

Setting Up Menu Options from Remote UI

14L7-08R

You can change the various machine settings by using the Remote UI. Most of the settings can be set also on the machine, but some settings can only be set using the Remote UI.

NOTE

Some settings require you to first log on in System Manager Mode before you can change them.

1 Start the Remote UI. ▶Starting Remote UI(P. 450)

2 Click [Settings/Registration].

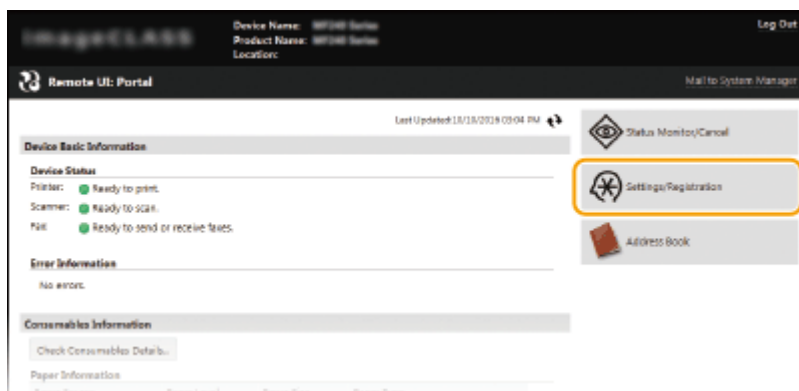

3 Click the menu item you want to set, then click [Edit].

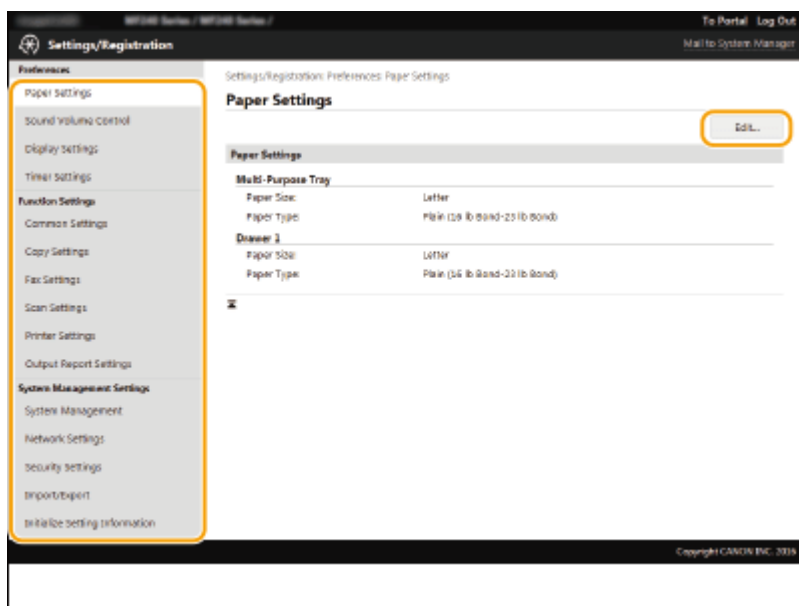

- For more information about the settings menu, see each item below

Menu items	Referents
Preferences	

Menu items	Referents
Paper Settings	▶ Specifying Paper Size and Type(P. 56)
Sound Volume Control/Display Settings	▶ Preferences(P. 483)
Timer Settings	▶ Timer Settings(P. 488)
Function Settings	
Common Settings	▶ Common Settings (MF249dw / MF246dn)(P. 492)
Copy Settings	▶ Copy Settings(P. 494)
Fax Settings	▶ Fax Settings (P. 496)
Scan Settings	▶ Scan Settings(P. 507)
Printer Settings	▶ Printer Settings(P. 512)
Output Report Settings	▶ Printing Reports and Lists(P. 607)
System Management Settings	
System Management	▶ System Management Settings(P. 528)
Network Settings	▶ Network (MF249dw / MF246dn / MF237w)(P. 314)
Security Settings	▶ Security(P. 392)
Import/Export	▶ Saving/Loading Address Book from Remote UI(P. 463)
Initialize Setting Information	▶ Initializing Menu(P. 622)

LINKS

▶ **Remote UI Screens(P. 452)**

Saving/Loading Address Book from Remote UI

14L7-08S

Address Book data in the machine can be saved in your computer (export). Data that is saved on your computer can also be registered in the machine (import). You can easily copy the destinations in the Address Book to multiple machines.* To use these features, it is required that you have logged on in System Manager Mode.

* Depending on the model, you cannot import the Address Book that exported from the machine.

▶ **Exporting Address Book Data(P. 463)**

▶ **Loading Address Book Data(P. 464)**

IMPORTANT

Do not turn OFF the machine until the import or export process is complete

It may take a few minutes to complete the process. If the machine is turned OFF during the process, it may result in damage to data or the machine.

Do not operate the machine during the export/import process

Before exporting/importing, check that no operation such as printing documents is currently processing.

Exporting Address Book Data

- 1 Start the Remote UI and log on in System Manager Mode. ▶ **Starting Remote UI(P. 450)**
- 2 Click [Settings/Registration].

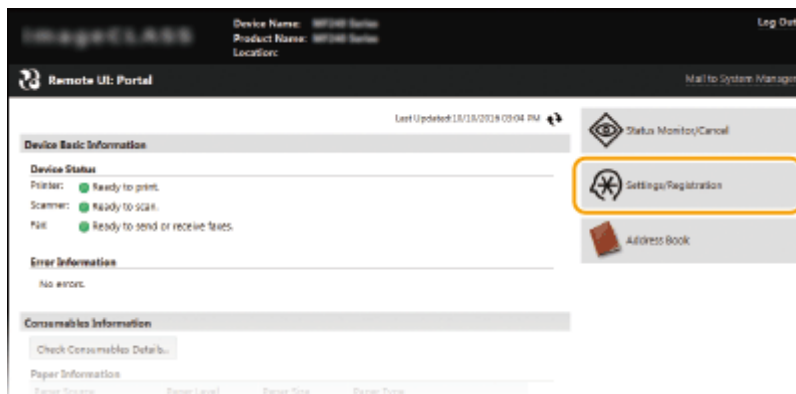

- 3 Click [Import/Export] ▶ [Export].

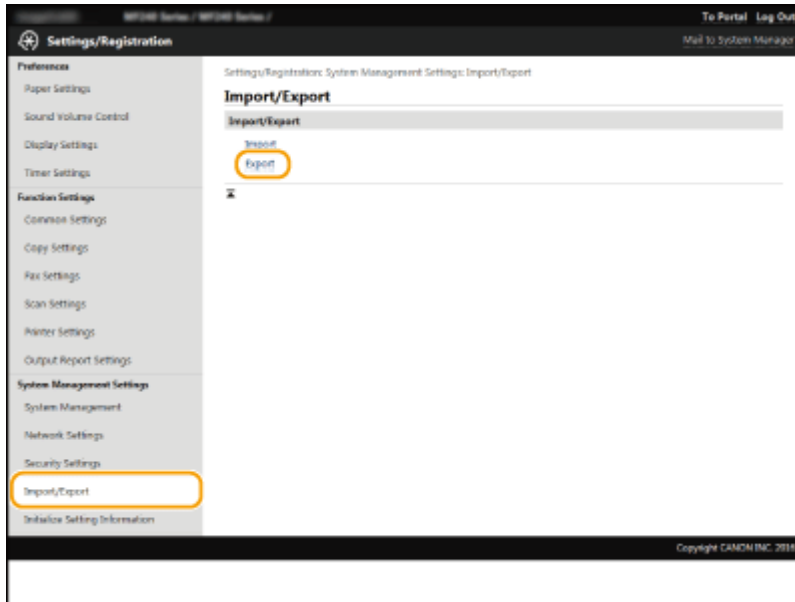

- If the screen prompting you to enter the Address Book PIN is displayed, enter the [PIN] and click [OK].  **Setting a PIN for Address Book(P. 415)**

4 Click [Start Exporting].

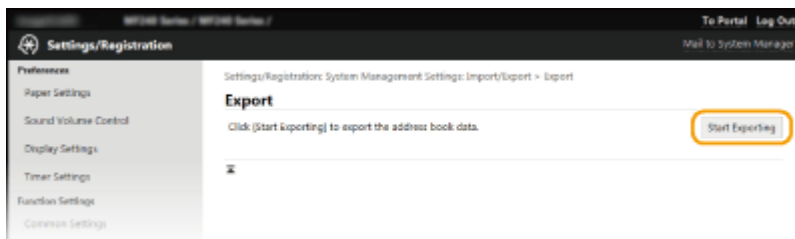

5 Follow the on-screen instructions to specify the location where the exported Address Book is saved.

- The Address Book will be saved.

IMPORTANT

Do not operate until the process is complete.

The screen remains the same during the export process. Do not operate the Remote UI until the message [The (file name) download has completed.] is displayed at the bottom of the screen.

Loading Address Book Data

IMPORTANT

The Address Book data currently registered is overwritten when you load the Address Book data.

1 Start the Remote UI and log on in System Manager Mode. Starting Remote UI(P. 450)

2 Click [Settings/Registration].

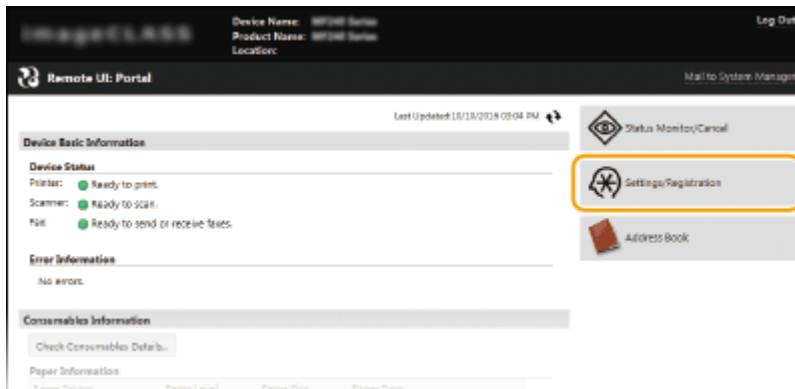

3 Click [Import/Export] ► [Import].

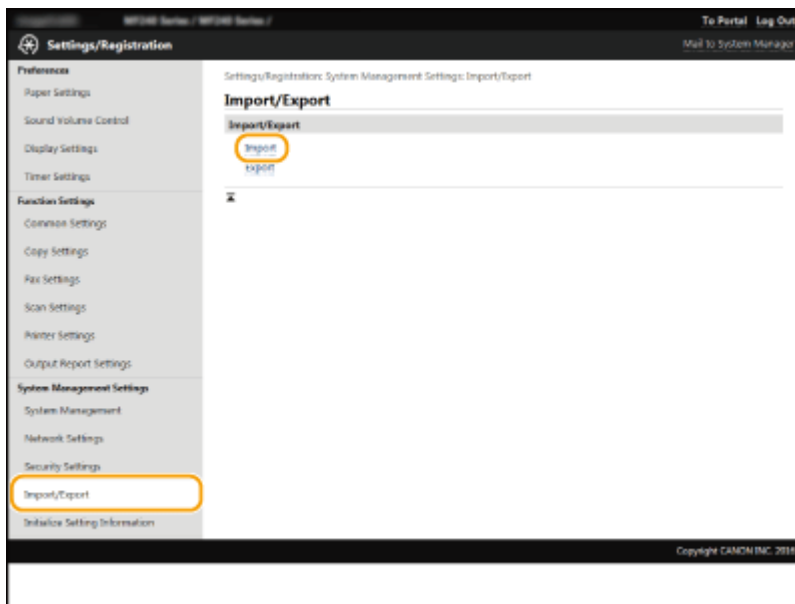

- If the screen prompting you to enter the Address Book PIN is displayed, enter the [PIN] and click [OK]. ▶
Setting a PIN for Address Book(P. 415)

4 Specify the Address Book file to be imported, and click [Start Importing].

- To specify the file to be imported, click [Browse] and select the file.

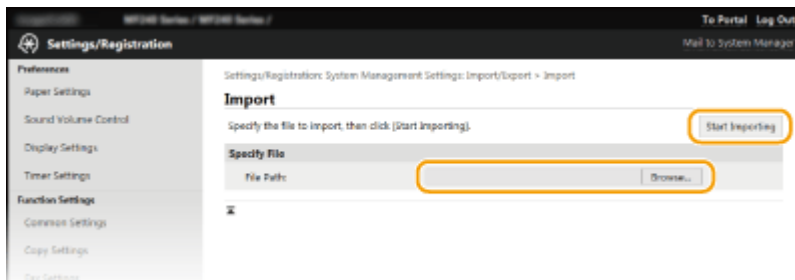

5 Click [OK].

- The specified Address Book data will be imported into the machine.

LINKS

- ▶ **Remote UI Screens(P. 452)**
- ▶ **Registering Address Book from Remote UI(P. 467)**
- ▶ **Registering in the Address Book(P. 60)**
- ▶ **Address Book List(P. 617)**

Registering Address Book from Remote UI

14L7-08U

You can register or edit the Address Book of the machine by using the computer. Specify the shared folder destination here.

NOTE

You can change the settings only when you have logged on in System Manager Mode.

1 Start the Remote UI. ▶ Starting Remote UI(P. 450)

2 Click [Address Book].

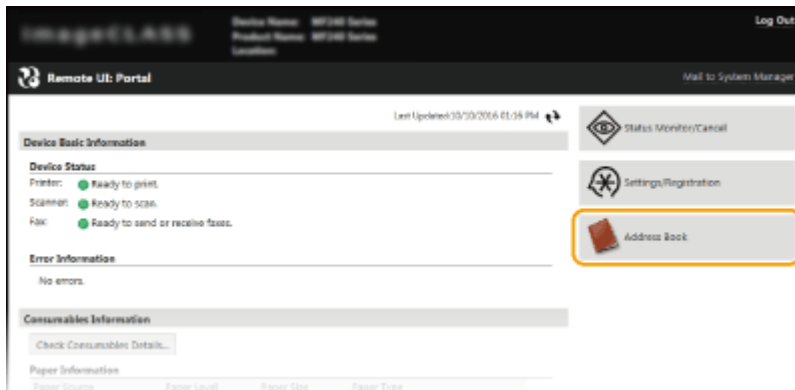

NOTE:

If the enter PIN page is displayed

The Address Book is protected by a PIN. Enter the [PIN] and click [OK].

3 Click [Coded Dial].

- You can also register destinations in One-Touch. In this case, click [One-Touch] instead of [Coded Dial]. ▶ Registering in the Address Book(P. 60)

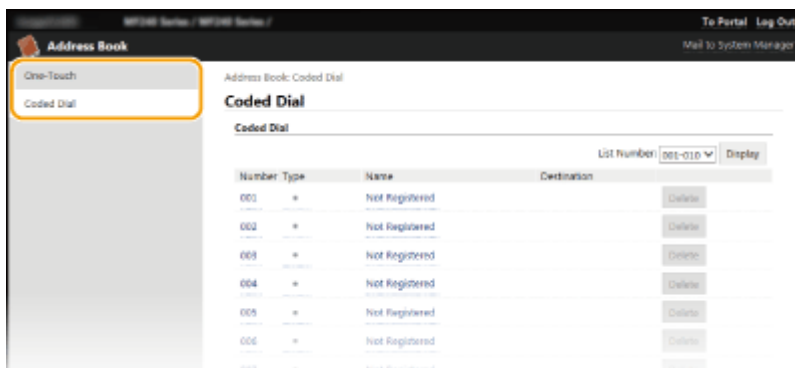

4 Click the text link under [Number], [Type], or [Name] for an item named "Not Registered."

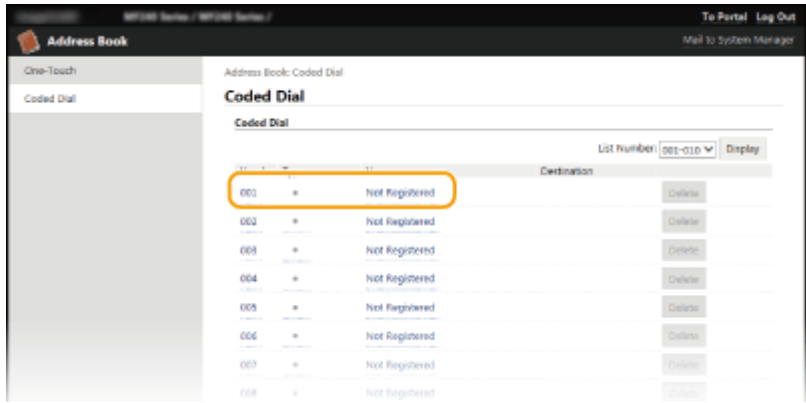

NOTE:

- You can edit a registered item by clicking the corresponding text link under [Number], [Type] or [Name].
- You can delete a registered item by clicking the corresponding [Delete] button.

5 Select [Destination Type to Register] and click [OK].

- To register the shared folder destination, select [File].

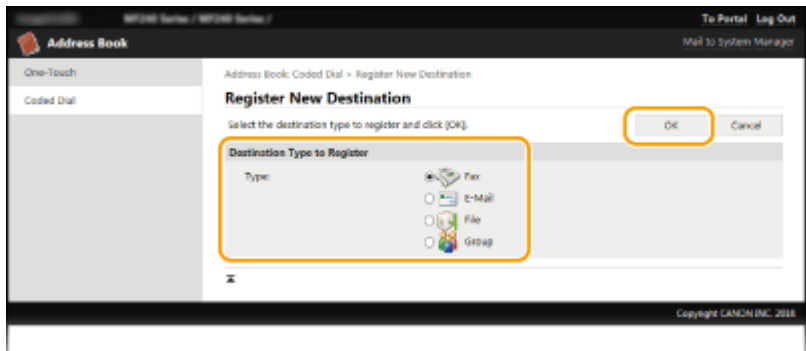

6 Specify the destination.

■ To register the fax destination

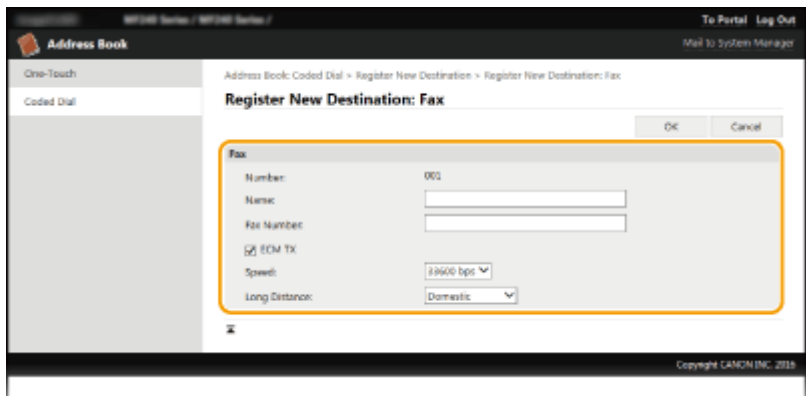

[Name]

Enter the name of the destination.

[Fax Number]

Enter the fax number of the destination.

[ECM TX]

Select the check box to make the following possible: if an error occurs in an image that is being sent, the error is checked and corrected to prevent an improper image from being sent.

[Speed]

If it takes time for transmissions to start, such as when there is a poor telephone connection, you can adjust the transmission start speed downward incrementally starting from [33600 bps].

[Long Distance]

Specify [International (1)] to [International (3)] according to the transmission conditions when registering overseas fax numbers.

NOTE:

- You can also specify [ECM TX] and [Speed] from <Fax Settings> (**Fax Settings (P. 496)**) on the operation panel. However, settings made from <Address Book> are enabled for the detailed settings of destinations registered in the Address Book.

■ To register the e-mail destination

The screenshot shows the 'Register New Destination: E-Mail' screen. The form has the following fields:

- Number: 001
- Name: [Text Input Field]
- E-Mail Address: [Text Input Field]

 The Name and E-Mail Address fields are highlighted with a yellow box. There are 'OK' and 'Cancel' buttons at the top right of the form area. The screen also shows a sidebar with 'One-Touch' and 'Coded Dial' options, and a top navigation bar with 'To Portal' and 'Log Out' links.

[Name]

Enter the name of the destination.

[E-Mail Address]

Enter the e-mail address of the destination.

■ To register the shared folder destination

The screenshot shows the 'Register New Destination: File' screen. The form has the following fields:

- Number: 001
- Name: [Text Input Field]
- Protocol: Windows (SMB)
- Host Name: [Text Input Field]
- Folder Path: [Text Input Field]
- User Name: [Text Input Field]
- Set Password
- Password: [Text Input Field]

 All fields from Name to Password are highlighted with a yellow box. There are 'OK' and 'Cancel' buttons at the top right of the form area. The screen also shows a sidebar with 'One-Touch' and 'Coded Dial' options, and a top navigation bar with 'To Portal' and 'Log Out' links.

[Name]

Enter the name for the destination.

[Host Name]

Enter the computer name or IP address using up to 120 characters. You can include a path to the shared folder with the computer name or IP address (e.g. "\\swan\share" or "\\192.168.2.100\share").

NOTE:

Using a DNS server

- You can also enter the host name (or FQDN) instead of the computer name or IP address (e.g. for a shared folder: "\\swan.organization.company.com\share").

[Folder Path]

Enter the location of the folder to which the data will be sent (up to 120 characters).

Use "\" as a separator. Specify the level that follows the path specified in [Host Name].

[User Name]

Enter the user name set for the shared folder (up to 32 characters).

[Set Password]

To set a password for the shared folder, select this check box and enter a [Password] of up to 32 characters.

IMPORTANT

Ensure that the same display language is selected on both the computer and the Remote UI.

- [Host Name] and [Folder Path] may not be displayed correctly or may not be referenceable.

7 Click [OK].

LINKS

- ▶ Remote UI Screens(P. 452)
- ▶ Saving/Loading Address Book from Remote UI(P. 463)
- ▶ Address Book List(P. 617)

Setting Menu List

Setting Menu List	472
Network Settings (MF249dw / MF246dn / MF237w)	473
Preferences	483
Timer Settings	488
Common Settings (MF249dw / MF246dn)	492
Copy Settings	494
Fax Settings	496
Scan Settings	507
Printer Settings	512
Adjustment/Maintenance	522
System Management Settings	528

Setting Menu List

14L7-08W

There are various settings in this machine. You can adjust each of the settings in detail. Access these settings by tapping <Menu> in the Home Screen.

TIPS

You can print the setting menu in list form to check the current settings:  **User Data List(P. 619)**

Network Settings MF249dw / MF246dn / MF237w

14L7-08X

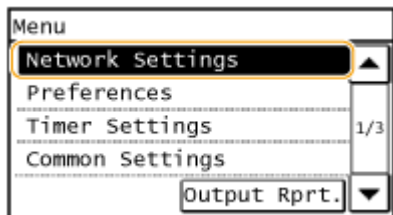

All the settings about the network are listed with short descriptions. Default settings are marked with a dagger (†).

NOTE

If a screen for entering a PIN is displayed

Enter the PIN with the numeric keys and tap <Apply>. [▶Setting the System Manager PIN\(P. 397\)](#)

Asterisks (*)

- Settings marked with "*1" are only available for the MF249dw / MF237w.
- Settings marked with "*2" are only available for the MF249dw / MF246dn.

- ▶[Select Wired/Wireless LAN\(P. 473\)](#)
- ▶[Wireless LAN Settings\(P. 473\)](#)
- ▶[Direct Connection Settings\(P. 475\)](#)
- ▶[TCP/IP Settings\(P. 476\)](#)
- ▶[SNMP Settings\(P. 480\)](#)
- ▶[Dedicated Port Settings\(P. 481\)](#)
- ▶[Waiting Time for Connection at Startup\(P. 482\)](#)
- ▶[Ethernet Driver Settings\(P. 482\)](#)
- ▶[IEEE 802.1X Settings\(P. 482\)](#)
- ▶[Initialize Network Settings\(P. 482\)](#)

Select Wired/Wireless LAN *1

When switching the machine from Wireless LAN to Wired LAN, you need to specify the setting. Conversely, when switching the machine from Wired LAN to Wireless LAN, you do not need to specify this setting (You can switch using the following <Wireless LAN Settings>). [▶Selecting Wired LAN or Wireless LAN \(MF249dw / MF237w\)\(P. 317\)](#)

Wired LAN †
Wireless LAN

Wireless LAN Settings *1

Specify settings for connecting the machine to a wireless LAN. You can also view the current settings or specify the setting for saving power consumption. See "Getting Started" [▶Manuals Included with the Machine\(P. 656\)](#) .

SSID Settings

Select to configure a wireless connection by specifying information including an SSID or a network key by inputting manually from the operation panel.

Select Access Point

Wireless LAN routers that can access the machine are automatically located, so you can select from the list. You must manually enter a network key, such as a WEP key or a PSK. **▶Setting Up Connection by Selecting a Wireless Router(P. 326)**

Enter Manually

Select to configure a wireless connection by manually entering an SSID. By using this method, you can specify authentication and encryption settings in detail. **▶Setting Up Connection by Specifying Detailed Settings(P. 329)**

Security Settings

- None
- WEP
 - Open System †
 - Select WEP Key: 1/2/3/4
 - Edit WEP Key
- Shared Key
 - Select WEP Key: 1/2/3/4
 - Edit WEP Key
- WPA/WPA2-PSK
 - Auto †
 - AES-CCMP

WPS Push Button Mode

Select to automatically configure a wireless connection by using the button on a WPS wireless router. **▶Setting Up Connection Using WPS Push Button Mode(P. 321)**

WPS PIN Code Mode

Select to configure a wireless connection by entering a PIN code for a WPS wireless router. **▶Setting Up Connection Using WPS PIN Code Mode(P. 323)**

Power Save Mode

Select whether or not the machine enters Power Save Mode based on signals emitted from the wireless router.

- Off †
- On

<Menu> ▶ <Network Settings> ▶ <Wireless LAN Settings> ▶ Read the displayed message

▶ <Power Save Mode> ▶ Select <Off> or <On> ▶

Wireless LAN Information

Select to view the current wireless LAN settings. **▶Viewing Network Settings(P. 344)**

- MAC Address
- Wireless LAN Status
- Latest Error Information
- Channel
- SSID Settings
- Security Settings
- Power Save Mode

Direct Connection Settings ^{*1}

Configure settings for Direct Connection. After configuring settings, you can connect to the machine directly and wirelessly from a mobile device even without an access point or wireless LAN router.

Use Direct Connection

Select whether to use Direct Connection. You can select <Direct Connection Only> or <Wireless LAN/Direct Conn. (Auto Switch)> when <Use Direct Connection> is set to <On> while the Wireless LAN connection is enabled.  **Make Direct Connection (Access Point Mode) (MF249dw / MF237w)(P. 291)**

Off 

On

Direct Connection Only

Wireless LAN/Direct Conn. (Auto Switch)



<Menu> ▶ <Network Settings> ▶ <Direct Connection Settings> ▶ <Use Direct Connection> ▶ <On>
▶ Select <Direct Connection Only> or <Wireless LAN/Direct Conn. (Auto Switch)> when <Wireless LAN> is selected in <Select Wired/Wireless LAN> ▶ <Yes> 

Time Until Direct Connection Termination

Set the time that the machine exits Direct Connection mode automatically. Can be set when <Use Direct Connection> is <On>. Once the time set in <Time Until Direct Connection Termination> is reached, communication between the machine and a mobile device is discontinued. Before starting a large print job, you should set a long delay time or set the delay time to <0> (Off).

0 (Off)

1 to 10  to 60 (min.)



<Menu> ▶ <Network Settings> ▶ <Direct Connection Settings> ▶ <Time Until Direct Connection Termination> ▶ Set time to disconnect ▶ <Apply> 

Access Point Mode Settings

To make detailed settings, such as authentication and encryption, enter an SSID and network key to configure settings. Can be set when <Use Direct Connection> is <On>.

Use Custom SSID

Off 

On

SSID (1-20 Characters)

Use Custom Network Key

Off 

On

Network Key (10 Char.)



<Menu> ▶ <Network Settings> ▶ <Direct Connection Settings> ▶ <Access Point Mode Settings> ▶
 Select <Use Custom SSID> or <Use Custom Network Key> ▶ <On> ▶ Set SSID Settings or Network
 Key Settings ▶ <Apply> ▶

TCP/IP Settings

Specify settings for using the machine in a TCP/IP network, such as IP address settings.

IPv4 Settings

Specify settings for using the machine in an IPv4 network.

IP Address Settings

Configure the IP address, which is used for identifying devices, such as computers and printers, on a TCP/IP network. ▶ **Setting IPv4 Address(P. 337)**

Auto Acquire †

Select Protocol

Off

DHCP †

BOOTP

RARP

Auto IP

Off

On †

Manually Acquire

IP Address: 0.0.0.0

Subnet Mask: 0.0.0.0

Gateway Address: 0.0.0.0

Check Settings

Auto Acquire

IP Address

Subnet Mask

Gateway Address

PING Command

Select to check that the machine is connected to a computer over a network. ▶ **Testing the Network Connection(P. 339)**

DNS Settings

Specify settings for Domain Name System (DNS), which provides a host name for IP address resolutions. ▶ **Configuring DNS(P. 377)**

DNS Server Settings

Primary DNS Server: 0.0.0.0

Secondary DNS Server: 0.0.0.0

DNS Host Name/Domain Name Settings

Host Name

Domain Name

DNS Dynamic Update Settings
 Off⁺
 On
 DNS Dyn. Updt. Intrvl.
 0 to 24⁺ to 48 (hr.)

mDNS Settings

Specify settings for using DNS functions without DNS servers. [▶Configuring DNS\(P. 377\)](#)

Off

On⁺
 mDNS Name

DHCP Option Settings

Select whether to acquire the host name and whether to use the dynamic update function via the DHCP options when DHCP is enabled. [▶Configuring DNS\(P. 377\)](#)

Acquire Host Name
 Off
 On⁺

DNS Dynamic Update
 Off⁺
 On

Acquire SMTP Server Address *2
 Off⁺
 On

Acquire POP Server Address *2
 Off⁺
 On

IPv6 Settings

Specify settings for using the machine in an IPv6 network.

Use IPv6

Enable or disable IPv6 in the machine. You can also view the current settings. [▶Setting IPv6 Addresses\(P. 340\)](#)

Off⁺

On

Check Settings
 Link-Local Address
 Prefix Length

Stateless Address Settings

Enable or disable stateless addresses. [▶Setting IPv6 Addresses\(P. 340\)](#)

Off

On †

Check Settings
Stateless Address
Prefix Length

Use DHCPv6

Enable or disable the stateful address that is acquired via DHCPv6. ▶ **Setting IPv6 Addresses(P. 340)**

Off †

On

Check Settings
Stateful Address
Prefix Length

DNS Settings

Specify settings for Domain Name System (DNS), which provides a host name for IP address resolutions. ▶ **Configuring DNS(P. 377)**

DNS Host Name/Domain Name Settings
Use IPv4 Host/Domain
Off
Host Name
Domain Name
On †

DNS Dynamic Update Settings
Off †
On
Register Manual Address
Off †
On
Register Stateful Address
Off †
On
Register Stateless Address
Off †
On
DNS Dynamic Update Interval
0 to 24 † to 48 (hr.)

mDNS Settings

Specify settings for using DNS functions without DNS servers. ▶ **Configuring DNS(P. 377)**

Off

On †
Use IPv4 Name for mDNS

Off mDNS Name On [†]

LPD Print Settings

Enable or disable LPD, a printing protocol that can be used on any hardware platform or operating system. ▶ **Configuring Printing Protocols and WSD Functions(P. 348)**

Off On [†]

RAW Print Settings

Enable or disable RAW, a Windows specific printing protocol. ▶ **Configuring Printing Protocols and WSD Functions(P. 348)**

Off On [†]

WSD Settings

Enable or disable automatic browsing and acquiring information for the printer or scanner by using the WSD protocol that is available on Windows Vista/7/8/10/Server 2008/Server 2012. ▶ **Configuring Printing Protocols and WSD Functions(P. 348)**

WSD Print Settings Use WSD Print Off On [†] Use WSD Browsing Off On [†]
WSD Scan Settings Use WSD Scan Off [†] On Use Computer Scan Off [†] On
Use Multicast Discovery Off On [†]

Use HTTP

Enable or disable HTTP, which is required for communications with a computer, such as when using the Remote UI, WSD printing, or printing with Google Cloud Print. ▶ **Disabling HTTP Communication (MF249dw / MF246dn / MF237w)(P. 423)**

Off On [†]

Port Number Settings

Change port numbers for protocols according to the network environment. **▶ Changing Port Numbers (MF249dw / MF246dn / MF237w)(P. 409)**

<p>LPD 1 to 515 † to 65535</p> <p>RAW 1 to 9100 † to 65535</p> <p>WSD Multicast Discovery 1 to 3702 † to 65535</p> <p>HTTP 1 to 80 † to 65535</p> <p>POP3 *2 1 to 110 † to 65535</p> <p>SMTP *2 1 to 25 † to 65535</p> <p>SNMP 1 to 161 † to 65535</p>
--

MTU Size

Select the maximum size of packets the machine sends or receives. **▶ Changing the Maximum Transmission Unit(P. 375)**

<p>1300</p> <p>1400</p> <p>1500 †</p>
--

SNMP Settings

Specify the settings for monitoring and controlling the machine from a computer running SNMP-compatible software. **▶ Monitoring and Controlling the Machine with SNMP(P. 386)**

SNMPv1 Settings

Enable or disable SNMPv1. When enabling SNMPv1, specify a community name and access privileges to Management Information Base (MIB) objects.

<p>Off</p> <p>On †</p> <p>Community Name 1 Settings</p> <p>Off</p> <p>On †</p> <p>Community Name</p> <p>MIB Access Permission</p> <p>Community Name 2 Settings</p>
--

Off †
 On
 Community Name
 MIB Access Permission
 Dedicated Community Settings
 Off
 On †





<Menu> ▶ <Network Settings> ▶ <SNMP Settings> ▶ <SNMP Settings> ▶ <SNMPv1 Settings>
 ▶ Select <Off> or <On> ▶ Specify settings if <On> is selected ▶ 

SNMPv3 Settings

Enable or disable SNMPv3. Use the Remote UI to specify detailed settings that are applied when SNMPv3 is enabled.

Off †
 On





<Menu> ▶ <Network Settings> ▶ <SNMP Settings> ▶ <SNMPv3 Settings> ▶ Select <Off> or <On>
 ▶ 

Acquire Printer Mngt. Info. from Host

Enable or disable the monitoring of printer management information from a networked computer running SNMP-compatible software.

Off †
 On



<Menu> ▶ <Network Settings> ▶ <SNMP Settings> ▶ <Acquire Printer Mngt. Info. from Host>
 ▶ Select <Off> or <On> ▶ 

Dedicated Port Settings

Enable or disable the dedicated port. The dedicated port is used when printing, faxing, or scanning uses MF Scan Utility and when browsing or specifying the machine settings over the network.

Off
 On †



<Menu> ▶ <Network Settings> ▶ <Dedicated Port Settings> ▶ Select <Off> or <On> ▶

Waiting Time for Connection at Startup

Specify a wait time for connecting to a network. Select the setting depending on the network environment. [▶Setting a Wait Time for Connecting to a Network\(P. 376\)](#)

0 [†] to 300 (sec.)

Ethernet Driver Settings

Select the communication mode of Ethernet (half-duplex/full-duplex) and the Ethernet type (10BASE-T/100BASE-TX). You can also view the MAC address of the machine.

Auto Detect

Select whether to automatically detect or manually select the communication mode and the Ethernet type. [▶Configuring Ethernet Settings\(P. 373\)](#)

Off
 Communication Mode
 Half Duplex [†]
 Full Duplex
 Ethernet Type
 10BASE-T [†]
 100BASE-TX

On [†]

MAC Address

Check the MAC address of the machine, which is a number unique to each communication device. [▶Viewing the MAC Address for Wired LAN\(P. 345\)](#)

IEEE 802.1X Settings

Enable or disable IEEE 802.1X authentication. [▶Configuring IEEE 802.1X Authentication\(P. 429\)](#)

Off [†]
 On

Initialize Network Settings

Select to return the Network Settings to the factory defaults. [▶Initialize Menu\(P. 535\)](#)

Preferences

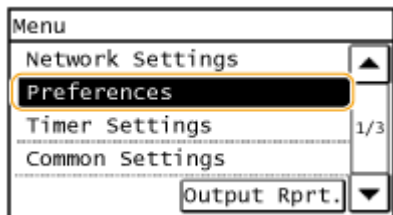

All the settings about the sound volume and display are listed with short descriptions. Default settings are marked with a dagger (†).

NOTE

If a screen for entering a PIN is displayed

Enter the PIN with the numeric keys and tap <Apply>. [▶Setting the System Manager PIN\(P. 397\)](#)

Asterisks (*)

- Settings marked with "*1" have different defaults depending on the country or region of purchase.
- Settings marked with "*2" are only available for the MF249dw / MF246dn / MF237w.

[▶Volume Settings\(P. 483\)](#)

[▶Display Settings\(P. 485\)](#)

Volume Settings

Adjust volume at which the machine beeps when a key is pressed on the operation panel or when a paper jam occurs.

[▶Adjusting the Volume\(P. 72\)](#)

Fax Tone

Select whether to make a dial tone while a fax is being sent. You can also adjust the volume.

0 to 1 † to 5

Ring Tone

Select whether the machine beeps when a fax is received. You can also adjust the volume.

0 to 1 † to 5

TX Done Tone

Select whether the machine beeps when a fax is sent. You can also adjust the volume.

0 to 1 † to 5

Only When Error Occurs

Off †

On

RX Done Tone

Select whether the machine beeps when a fax is received. You can also adjust the volume.

0 to 1 [†] to 5

Only When Error Occurs

Off [†]

On

Scanning Done Tone

Select whether the machine beeps when scanning fax documents is complete. You can also adjust the volume.

0 to 1 [†] to 5

Only When Error Occurs

Off [†]

On

Entry Tone

Select whether the machine beeps when a key is pressed on the operation panel.

Off

On [†]

Invalid Entry Tone

Select whether the machine beeps when an invalid settings value is entered, such as when a user is trying to enter a number unavailable for a setting.

Off [†]

On

Warning Tone

Select whether the machine beeps when problem such as a paper jam or an operation mistake occurs.

Off

On [†]

Job Done Tone

Select whether the machine beeps when copying or scanning is complete.

Off

On [†]

Energy Saver Alert

Select whether the machine beeps when the machine enters or wakes from sleep mode.

Off [†]

On

Original in Feeder Detection Tone

Select whether the machine beeps when an original is loaded in the feeder.

Off

On [†]

Display Settings

Default Screen after Startup/Restoration

By default, the Home screen is displayed immediately after the machine is turned ON or when the Auto Reset function is performed. Specify the setting to change the default screen and display the main screen of a different function.

Home †
Copy
Fax
Scan



<Menu> ▶ <Preferences> ▶ <Display Settings> ▶ <Default Screen after Startup/Restoration>
▶ Select a function to display the desired screen ▶

Home Screen Button Display Settings

Change the order in which Home Screen buttons are displayed. [▶ Customizing the <Home> Screen\(P. 33\)](#)

Contrast

Adjust the brightness of the display to suit the installation location of the machine.

Five Levels



<Menu> ▶ <Preferences> ▶ <Display Settings> ▶ <Contrast> ▶ Use <->/<+> to adjust the brightness ▶ <Apply> ▶

Invert Screen Colors

Select <On> to invert the display colors. Select <On> if the display is hard to view even after the brightness was adjusted in <Contrast>.

Off †
On





<Menu> ▶ <Preferences> ▶ <Display Settings> ▶ <Invert Screen Colors> ▶ Select <On> or <Off> ▶

Millimeter/Inch Entry Switch

Select the unit of measurement.

Millimeter †
Inch





<Menu> ▶ <Preferences> ▶ <Display Settings> ▶ <Millimeter/Inch Entry Switch> ▶ Select <Millimeter> or <Inch> ▶ 

Notify to Check Paper Settings

Specify whether to display a message prompting you to check paper settings when loading paper into the paper drawer or manual feed slot.

Off
On †





<Menu> ▶ <Preferences> ▶ <Display Settings> ▶ <Notify to Check Paper Settings> ▶ Select <Off> or <On> ▶ 

Notify to Clean Original Scanning Area

When set to <On>, a message is displayed for dirt or soiling on the original scanning area.

Off
On †





<Menu> ▶ <Preferences> ▶ <Display Settings> ▶ <Notify to Clean Original Scanning Area> ▶ Select <On> or <Off> ▶ 

Message Display Time

Specify the interval in seconds at which two different messages are alternately displayed.

1 to 2 † to 5 (sec.)





<Menu> ▶ <Preferences> ▶ <Display Settings> ▶ <Message Display Time> ▶ Enter a number for the interval ▶ <Apply> ▶ 

Scrolling Speed

Adjust the speed for scrolling the screen by selecting from three levels.



Slow
Standard †
Fast

 <Menu> ▶ <Preferences> ▶ <Display Settings> ▶ <Scrolling Speed> ▶ Select the speed ▶ 

Cursor Movement Type

Configure how the cursor moves after a character is entered on the screen. Select <Auto> to automatically move the cursor to the right of the entered character. Select <Manual> to manually move the cursor to the right of the entered character.



Auto †
Manual

 <Menu> ▶ <Preferences> ▶ <Display Settings> ▶ <Cursor Movement Type> ▶ Select <Auto> or <Manual> ▶ 

Language*1

Select the display language used for the display, reports, and lists.



Chinese (Simplified), Chinese (Traditional), English †, French, German, Italian, Japanese, Korean, Malay, Portuguese, Spanish, Thai, Vietnamese

 <Menu> ▶ <Preferences> ▶ <Display Settings> ▶ <Language> ▶ Select a language ▶ <Yes> ▶ 

Remote UI Language*1 *2

Select the display language used for the Remote UI screens.

Chinese (Simplified), Chinese (Traditional), English †, French, German, Italian, Japanese, Korean, Portuguese, Spanish

 <Menu> ▶ <Preferences> ▶ <Display Settings> ▶ <Remote UI Language> ▶ Select a language ▶ 

Timer Settings

14L7-090

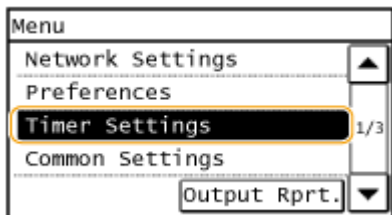

All the settings about the timer are listed with short descriptions. Default settings are marked with a dagger (†).

NOTE

Asterisks (*)

Settings marked with (*) are unavailable depending on the country or region of purchase.

- ▶ Quiet Mode Time(P. 488)
- ▶ Date/Time Settings(P. 488)
- ▶ Auto Sleep Time(P. 490)
- ▶ Auto Reset Time(P. 490)
- ▶ Function After Auto Reset(P. 491)
- ▶ Auto Offline Time(P. 491)

Quiet Mode Time

You can reduce the operation sound of the machine when you want it to run more quietly (quiet mode). Set a time for the machine to enter quiet mode automatically. You can also set the machine to always run in quiet mode. ▶ **Entering Quiet Mode(P. 74)**

<p>Start Time Off † On Start time setting to enter quiet mode</p> <p>End Time Off † On Stop time setting to exit quiet mode</p>

Date/Time Settings

Specify date and time settings, including the date format and the 12- or 24-hour clock display setting. The date and time that are printed on each fax document, report, and list are determined by these settings.

Date Format *

Select the date format (order of year, month, and day).

YYYY MM/DD MM/DD/YYYY DD/MM YYYY †
--





<Menu> ▶ <Timer Settings> ▶ <Date/Time Settings> ▶ <Date Format> ▶ Select the date format
▶ 

Time Format

Select the 12- or 24-hour clock display setting.



12 Hour (AM/PM) †
24 Hour



<Menu> ▶ <Timer Settings> ▶ <Date/Time Settings> ▶ <Time Format> ▶ Select the display setting
▶ 

Current Date/Time Settings

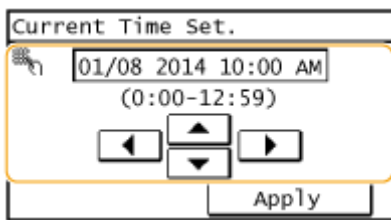
Set the current date and time. Use ◀ / ▶ to move the cursor, and ▲ / ▼ to specify the date and time or switch between <AM>/<PM>.

<Menu> ▶ <Timer Settings> ▶ <Date/Time Settings> ▶ <Current Date/Time Settings> ▶ Set the date and time ▶ <Apply> ▶ 

NOTE

The current date and time cannot be changed for 1 hour after daylight saving time is in effect.

Time Zone

Select the time zone. If the time zone setting is changed, the values set in <Current Date/Time Settings> are also changed accordingly.

(UTC-12:00) International Date Line West
to
(UTC) Coordinated Universal Time †
to
(UTC+14:00) Kiribati

NOTE

UTC

Coordinated Universal Time (UTC) is the primary time standard by which the world regulates clocks and time. The correct UTC time zone setting is required for Internet communications.



<Menu> ▶ <Timer Settings> ▶ <Date/Time Settings> ▶ <Time Zone> ▶ Select a time zone ▶

Daylight Saving Time Settings *

Enable or disable daylight saving time. If daylight saving time is enabled, specify the dates from which and to which daylight saving time is in effect.

Off ⁺

On

Start: Month, Day
End: Month, Day



<Menu> ▶ <Timer Settings> ▶ <Date/Time Settings> ▶ <Daylight Saving Time Settings> ▶ <On> ▶ Select a month and day ▶ <Apply> ▶

Auto Sleep Time

If the machine has not been operated or has had no data to process for a specified period of time, the machine enters sleep mode to save energy consumption (Auto Sleep). Specify the period of time after which auto sleep is performed. Auto Sleep is not performed when the setting menu is displayed. We recommend using the factory default settings to save the most power. **Entering Sleep Mode(P. 76)**

1 ⁺ to 30 (min.)

Auto Reset Time

If a key is not pressed for a specified period of time, the screen and the settings are initialized to display the default screen (Auto Reset). Specify the interval at which the Auto Reset is performed. Select <0> to disable the Auto Reset function. The Auto Reset is not performed in the following cases:

- The setting menu is displayed.
- The machine is processing data, such as when printing documents or sending or receiving faxes.
- An error message is displayed and the error indicator is blinking (However, Auto Reset is performed when the error does not prevent the user from continuing to use a function.)

0 (Auto Reset is disabled.)
1 to 2 ⁺ to 9 (min.)





<Menu> ▶ <Timer Settings> ▶ <Auto Reset Time> ▶ Set the Auto Reset time ▶ <Apply> ▶ 

NOTE

The screen displayed after the Auto Reset is performed can be selected in <Function After Auto Reset>.

Function After Auto Reset

Select whether to return the display to the default screen after the Auto Reset is performed. If <Default Function> is selected, the main screen of the function selected in <Default Screen after Startup/Restoration> is displayed ( **Default Screen after Startup/Restoration(P. 485)**). If <Selected Function> is selected, the display returns to the main screen of the function that was selected.

Default Function 
Selected Function





<Menu> ▶ <Timer Settings> ▶ <Function After Auto Reset> ▶ Select <Default Function> or <Selected Function> ▶ 

Auto Offline Time

If a key has not been pressed for a specified period of time after the screen below is displayed (the machine is set online for scanning), the machine automatically becomes offline. Specify the time period at which the machine becomes offline. You can also set the machine to remain online.

```
Remote Scanner
waiting... (Online)
Start scanning using
the device at the
store location.
```

0 (The machine remains online.)
1 to 5  to 60 (min.)



<Menu> ▶ <Timer Settings> ▶ <Auto Offline Time> ▶ Set the time period ▶ <Apply> ▶ 

Common Settings MF249dw / MF246dn

14L7-091

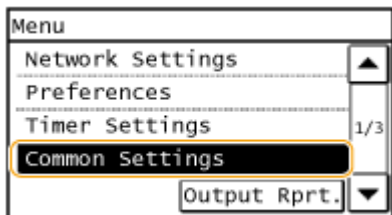

All the settings about the operation of the paper drawer and the paper feed method are listed with short descriptions. Default settings are marked with a dagger (†).

Switch Paper Feed Method

Specify this setting when you print a document on paper with logos. To print on paper with logos, you need to change how the paper loaded in the paper source is facing depending on whether you are performing 1- or 2-sided printing. However, if you change the setting to <Print Side Priority>, you can just load the paper face down for both 1- and 2-sided printing. For more information, see [Loading Preprinted Paper\(P. 54\)](#) .

<p>Multi-Purpose Tray Speed Priority † Print Side Priority</p> <p>Drawer 1 Speed Priority † Print Side Priority</p>

<Menu> ▶ <Common Settings> ▶ <Switch Paper Feed Method> ▶ Select the paper source ▶ Select <Speed Priority> or <Print Side Priority> ▶

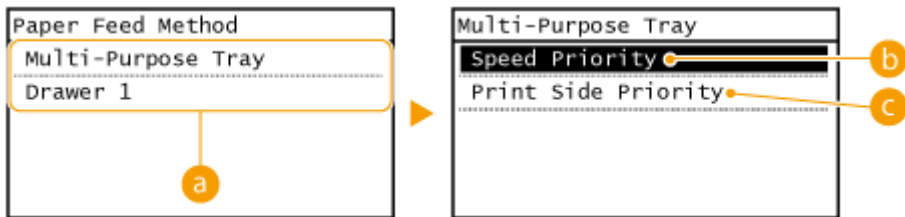

a Paper Sources

Select the paper source that you want to change the setting for.

b <Speed Priority>

When using paper that has been preprinted with a logo, you need to change how it is facing when you perform 1-sided and 2-sided printing.

NOTE:

We recommend selecting <Speed Priority> if you do not need to consider which side to print on.

C <Print Side Priority>

To print on a specific side of paper, you do not need to flip over paper in the paper source whether 1- or 2-sided printing is selected.

NOTE:

- If <Print Side Priority> is set for a paper source that is loaded with paper you cannot use for 2-sided printing (**▶Paper(P. 647)**), <Speed Priority> is applied to the paper source instead. In this case, you need to load the paper in the same way as when <Speed Priority> is selected (**▶Loading Preprinted Paper(P. 54)**).
- 1-sided printing speed may be slower when <Print Side Priority> is selected.

Copy Settings

14L7-092

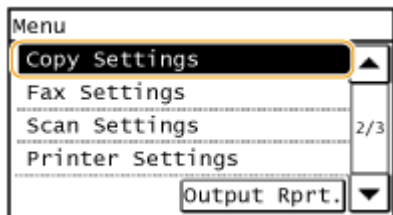

All the settings about the copy are listed with short descriptions. Default settings are marked with a dagger (†).

NOTE

Asterisks (*)

- Settings marked with "*1" are only available for the MF249dw / MF246dn.
- Settings marked with "*2" are only available for the MF249dw.

- ▶ **Change Default Settings (P. 494)**
- ▶ **Correct Density(P. 495)**
- ▶ **Initialize Default Settings(P. 495)**

Change Default Settings

You can change the factory default settings about copy. The selected settings are used as the default settings of the copy function. ▶ **Changing Default Settings(P. 100)**

Number of Copies

1 † to 999

Density

-4 to 0 † to +4

Auto Density

Original Type

Text

Text/Photo (High Speed) †

Text/Photo

Photo

2-Sided *1

Off †

1->2-Sided

2->2-Sided*2

2->1-Sided*2

Original/Finishing Type

Copy Ratio

Custom Ratio



100% (1:1) †

400% (Max)
200%
141% A5->A4/LTR
122% A5->B5
115% B5->A4/LTR
86% A4/LTR->B5
81% B5->A5
70% A4/LTR->A5
50%
25% (Min)
N on 1
Off †
2 on 1
4 on 1
ID Card Copy
Select Layout
Collate
Off †
On
Sharpness
Seven Levels

Correct Density

Specify the initial copy density. You can also change the copy density temporarily.  **Adjusting Density(P. 88)**

-4 to 0 † to +4

 <Menu> ▶ <Copy Settings> ▶ <Correct Density> ▶ Adjust the density ▶ <Apply> ▶ 

Initialize Default Settings

Select this option to restore the default copy settings.

 <Menu> ▶ <Copy Settings> ▶ <Initialize Default Settings> ▶ <Yes> ▶ 

Fax Settings

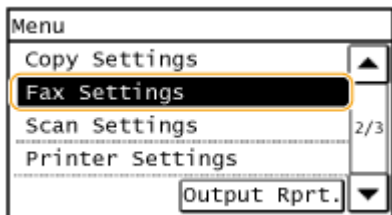

All the settings about the fax are listed with short descriptions. Default settings are marked with a dagger (†).

NOTE

If a screen for entering a PIN is displayed

Enter the PIN with the numeric keys and tap <Apply>. [▶Setting the System Manager PIN\(P. 397\)](#)

Asterisks (*)

- Settings marked with "*1" may be unavailable or have different defaults depending on the country or region of purchase.
- Settings marked with "*2" are only available for the MF249dw.
- Settings marked with "*3" are only available for the MF249dw / MF246dn.

- ▶Basic Settings(P. 496)
- ▶TX Function Settings(P. 498)
- ▶RX Function Settings(P. 502)
- ▶RX Print Settings(P. 504)
- ▶Forwarding Settings(P. 506)
- ▶Fax Setup Guide(P. 506)

Basic Settings

Specify the basic settings for using the machine as a fax device.

Register Unit Telephone Number

Register the fax number for the machine. [▶Registering the Fax Number and Unit Name\(P. 108\)](#)

Select Line Type *1

Select the telephone line type used for fax transmission. [▶Connecting the Telephone Line\(P. 112\)](#)

Pulse Tone †

Public Line Connection

When the fax receive mode is <Fax/Tel (Auto Switch)>, an external telephone may not ring or a call may not be dialable. In this instance, specify <Adapter 1> or <Adapter 2>.

Direct † Adapter 1 Adapter 2





<Menu> ▶ <Fax Settings> ▶ <Basic Settings> ▶ <Public Line Connection> ▶ Select connection type ▶ 

Off-Hook Alarm

Select whether the machine makes an alert sound when the handset of a telephone or the optional handset connected to the machine is not properly set on the cradle. You can also adjust the volume of the alert sound.

0 + to 5



<Menu> ▶ <Fax Settings> ▶ <Basic Settings> ▶ <Off-Hook Alarm> ▶ Select the volume of the alert sound ▶ <Apply> ▶ 

Communication Management Settings

Specify the communication start speed settings and the R-key settings.

TX Start Speed

Adjust the communication start speed in descending order from "33600 bps." This adjustment should be made when it takes a long time to start sending a fax due to a poor telephone line connection.

33600 bps +
 14400 bps
 9600 bps
 7200 bps
 4800 bps
 2400 bps



<Menu> ▶ <Fax Settings> ▶ <Basic Settings> ▶ <Communication Management Settings> ▶ <TX Start Speed> ▶ Select a communication start speed ▶ 

RX Start Speed

Adjust the communication start speed in descending order from "33600 bps." This adjustment should be made when it takes a long time to start receiving a fax due to a poor telephone line connection.

33600 bps +
 14400 bps
 9600 bps
 7200 bps
 4800 bps
 2400 bps



<Menu> ▶ <Fax Settings> ▶ <Basic Settings> ▶ <Communication Management Settings> ▶ <RX Start Speed> ▶ Select a communication start speed ▶

R-Key Setting

If your machine is connected through a PBX (Private Branch Exchange), it is necessary to set the access method. You can set the PBX type to <Prefix> or <Hooking>. If you register the outside line access number to the R-key, you can easily access the outside line.

PSTN †

PBX
Prefix
Hooking †



<Menu> ▶ <Fax Settings> ▶ <Basic Settings> ▶ <Communication Management Settings> ▶ <R-Key Setting> ▶ <PBX> ▶ Select <Prefix> or <Hooking> ▶ Enter the outside line access number if you select <Prefix> ▶ <Apply> ▶

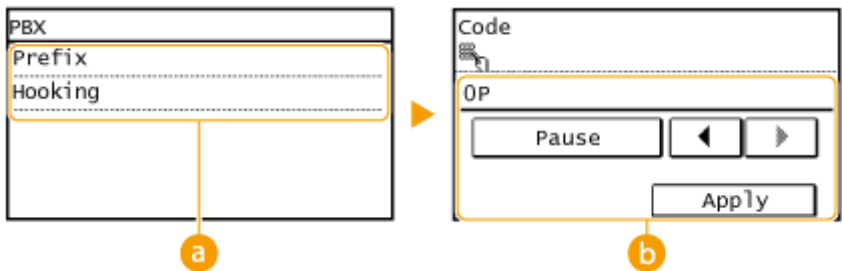

a <PBX>

Select the type of PBX you are using. If you select <Prefix>, register the prefix code on the next screen.

b <Code>

Enter the prefix code using the numeric keys, tap <Pause>, and then tap <Apply>. If you do not insert a pause, the prefix code is not registered.

TX Function Settings

Specify settings for sending faxes.

Change Default Settings

Specify settings used for sending faxes. The selected settings are used as the default settings when scanning documents. **Changing Default Settings(P. 139)**

Resolution
200 x 100 dpi (Normal) †
200 x 200 dpi (Fine)
200 x 200 dpi (Photo)

200 x 400 dpi (Superfine)

Density
Nine Levels

2-Sided Original *2
Off †

Book Type
Calendar Type

Sharpness
Seven Levels

Register Unit Name

Register the name of a company or person. ▶ **Registering the Fax Number and Unit Name(P. 108)**

The registered name is sent as sender information to the destination. ▶ **TX Terminal ID(P. 501)**

ECM TX

Enable or disable error correction mode (ECM). ECM checks for fax data errors and corrects them. To reduce errors on received faxes, see ▶ **ECM RX(P. 502)** .

Off
On †

NOTE

- ECM must be enabled on both the machine and the other fax device because error checks are performed on both the sending and receiving devices.
- Even when ECM is enabled, errors may occur due to telephone line conditions.
- It may take a longer time than usual to process data when ECM is enabled because the error checks and corrections are performed while the data is transmitted.



<Menu> ▶ <Fax Settings> ▶ <TX Function Settings> ▶ <ECM TX> ▶ <On> ▶

Set Pause Time

For example, when you make calls by dialing "0 - (pause) - (telephone number)", 0 is dialed first and then a few seconds later, the telephone number. When sending faxes overseas, you need to specify destinations by dialing "(international access code) - (country code) - (area code) - (fax number)" but consecutive numbers that are input without pauses may not be recognized correctly. In this case, try adding a pause after the international access code or the fax number. If the code or the number is still not recognized correctly, change the duration of the pause. For instructions on how to enter a pause, see step 3 on ▶ **Sending Faxes(P. 114)** .

1 to 2 † to 15 (sec.)



<Menu> ▶ <Fax Settings> ▶ <TX Function Settings> ▶ <Set Pause Time> ▶ Specify the duration of pause ▶ <Apply> ▶

Auto Redial *1

Specify settings for Auto Redial, a function that automatically redials the fax number after several minutes if the first attempt fails because the line is busy. You can specify how many times the machine redials and the interval between redials.

Off

On †

Number of Times to Redial
1 to 2 † to 10 (times)

Redial Interval
2 † to 99 (min.)

Redial When Error Occurs
Off
On †



<Menu> ▶ <Fax Settings> ▶ <TX Function Settings> ▶ <Auto Redial> ▶ <On> ▶ Specify the settings ▶ <Apply> ▶

a <Number of Times to Redial>

Specifies how many times the machine redials. Use ▲ / ▼ or the numeric keys to enter a number, and tap <Apply>.

b <Redial Interval>

Specifies the interval between redials. Use ▲ / ▼ or the numeric keys to enter a number for the interval, and tap <Apply>.

c <Redial When Error Occurs>

Specifies whether to redial when a transmission error occurs. Select <Off> or <On>.

TX Terminal ID

Specify settings for adding the sender information, including the fax number and the name of the machine, to the fax header. The recipient can check who sent the fax by looking at the added information.

Off †

On †

Print Position

 Inside Image Area

 Outside Image Area †

Mark No. as: TEL/FAX

 FAX †

 TEL



<Menu> ▶ <Fax Settings> ▶ <TX Function Settings> ▶ <TX Terminal ID> ▶ <On> ▶ Specify the settings ▶ <Apply> ▶ 

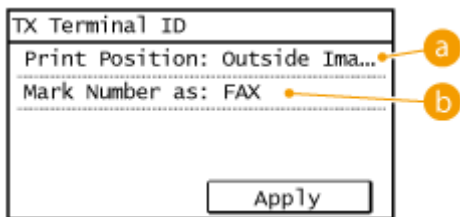

a <Print Position>

Specifies the position to print the terminal ID information in the sent fax. Select <Inside Image Area> to print the information inside the image area, or <Outside Image Area> to print the information outside the image area.

b <Mark Number as>

Adds the "FAX" or "TEL" mark in front of the fax number registered for the machine ( **Registering the Fax Number and Unit Name(P. 108)**). Select <TEL> to indicate that the notified number is a telephone number.

Check Dial Tone Before Sending *1

Select whether to check the dial tone before a fax number is dialed.

Off †

On



<Menu> ▶ <Fax Settings> ▶ <TX Function Settings> ▶ <Check Dial Tone Before Sending> ▶ Select <On> or <Off> ▶ 

Allow Fax Driver TX

Enable or disable PC faxing (sending faxes from a computer). ▶ **Prohibiting PC Faxing(P. 418)**

Off
On †

Confirm Entered Fax Number

Select whether to require users to enter the fax number twice when it is entered by using the numeric keys. ▶ **Displaying the Screen for Confirming the Fax Number(P. 420)**

Off †
On

Restrict Sequential Broadcast

Select whether to prohibit sequential broadcasting, a feature that sends faxes to multiple destinations in succession. ▶ **Prohibiting Sequential Broadcasting(P. 422)**

Off †
Confirm Sequential Broadcast
Reject Sequential Broadcast

Initialize Default Settings

Select this option to restore the default fax transmission settings.



<Menu> ▶ <Fax Settings> ▶ <TX Function Settings> ▶ <Initialize Default Settings> ▶ <Yes> ▶

RX Function Settings

Specify settings for receiving faxes.

ECM RX

Enable or disable error correction mode (ECM). ECM checks for fax data errors and corrects them. To reduce errors on sent faxes, see ▶ **ECM TX(P. 499)** .

Off
On †

NOTE

- ECM must be enabled on both the machine and the other fax device because error check is performed on both the sending and receiving devices.
- Even when ECM is enabled, errors may occur due to telephone line conditions.
- It may take a longer time than usual to process data when ECM is enabled because the error check and corrections are performed while the data is transmitted.

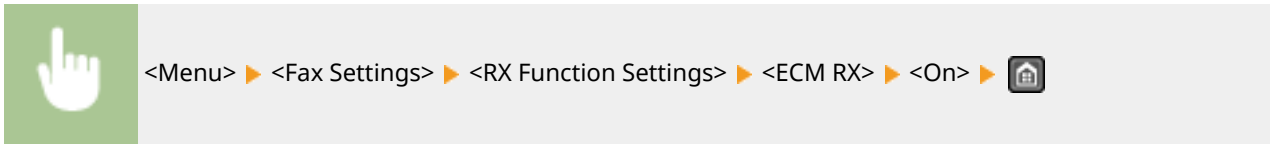

Incoming Ring *1

Specify settings for sounding a ring to notify you of incoming faxes. This feature is only available when <Auto> or <Fax/Tel (Auto Switch)> is selected for the receive mode. Specify how many times the incoming call rings when the machine receives a fax call. You can also disable the settings to prevent the incoming call from ringing.

Off

On †
1 to 2 † to 99 (times)

NOTE

If you use this feature in the <Auto> mode, you need to connect your telephone to the machine beforehand.

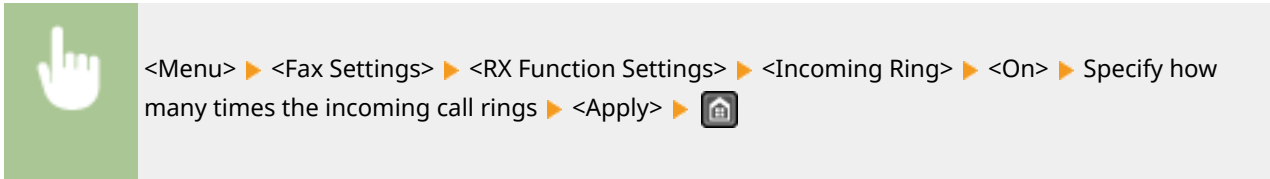

Remote RX

Specify settings for receiving a fax by operating a telephone that is connected to the machine (Remote Reception). When a fax is sent to the machine, you can receive it just by picking up the handset of the telephone and entering a specific ID number by using the telephone. This feature can save you the trouble of going all the way to the machine. For instructions on how to use Remote Reception, see **Using a Telephone to Receive Faxes (Remote Reception)(P. 145)** .

Off

On †
00 to 25 † to 99

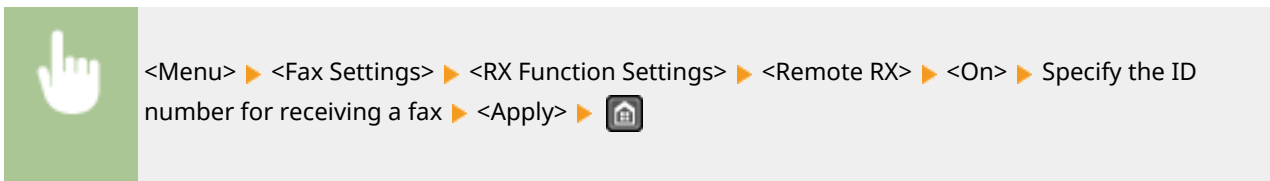

Switch to Auto RX

Specify settings for automatically receiving a fax after the machine has rung for a specified time period. This feature is only available when <Manual> is selected for the receive mode. By using this feature, faxes can be received even when no one is available to pick up the handset.

Off †

On

1 to 15 [†] to 99 (sec.)



<Menu> ▶ <Fax Settings> ▶ <RX Function Settings> ▶ <Switch to Auto RX> ▶ <On> ▶ Specify how long the incoming call rings ▶ <Apply> ▶

Memory Lock Settings

Select whether to store received faxes without immediately printing them. Stored fax documents can be printed at any time by changing the setting to <Off>. **Storing Received Faxes into Memory (Memory Reception) (P. 150)**

Off [†]

On

Report Print

Off

On [†]

Memory Lock Time

Off [†]

On

Memory Lock Start Time

Memory Lock End Time



<Menu> ▶ <Fax Settings> ▶ <RX Function Settings> ▶ <Memory Lock Settings> ▶ <On> ▶ Specify settings ▶ <Apply> ▶

RX Print Settings

Specify settings for printing received faxes.

Print on Both Sides ^{*3}

Specify settings for printing received faxes on both sides of paper.

Off [†]

On



<Menu> ▶ <Fax Settings> ▶ <RX Print Settings> ▶ <Print on Both Sides> ▶ <On> ▶

Reduce RX Size

Specify settings for reducing the image size of a received document. You can select an automatic reduction ratio that reduces the received document to size of the loaded paper. You can also select a ratio from a list.

Off

On †

Ratio

Auto †

97%

95%

90%

75%

Direction

Vertical/Horizontal

Vertical Only †

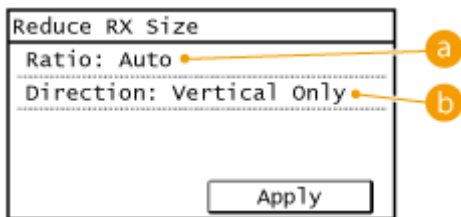
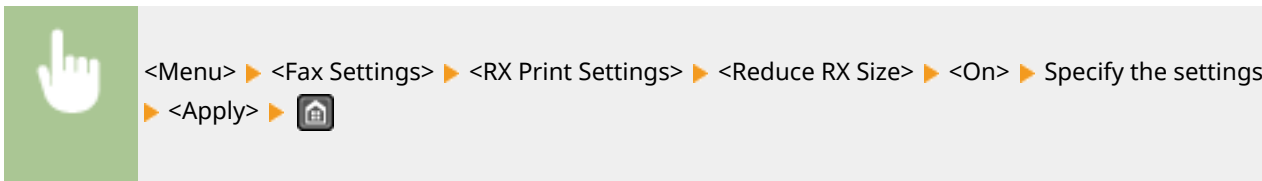

a <Ratio>

<Auto> reduces the image by a ratio that is based on the size of the loaded paper. <97%>, <95%>, <90%>, or <75%> reduce the image by the corresponding ratio.

b <Direction>

Select <Vertical/Horizontal> to reduce the image both vertically and horizontally. Select <Vertical Only> to reduce only vertically.

RX Page Footer

Select whether to print information, including date and time of reception and page numbers, on the bottom of received faxes.

Off †

On

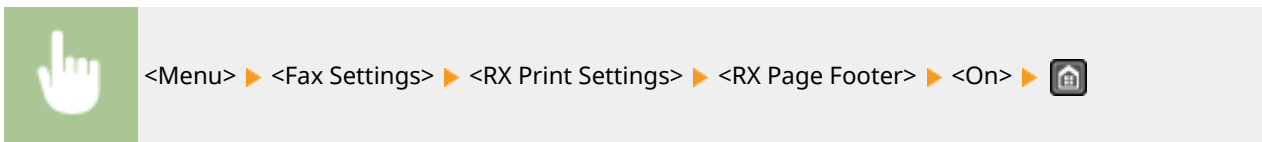

Continue Print. When Near Cart. Life End

If receiving faxes when the amount remaining in a toner cartridge is nearly empty, the machine holds them in memory instead of printing. However, if this function is enabled, the machine continues printing.

Off †
On

IMPORTANT

When this function is enabled, faxes may fade or blur. Because received documents are not stored in memory, you need to ask the sender to resend the document.



<Menu> ▶ <Fax Settings> ▶ <RX Print Settings> ▶ <Continue Print. When Near Cart. Life End>
▶ <On> ▶

Forwarding Settings ^{*3}

Specify settings for forwarding faxes.

Enable Forwarding Settings

Select whether to forward all the received fax documents to a specified destination. You can specify an e-mail address or a shared folder in a computer as the forwarding destination. **Forwarding All the Received Documents Automatically (MF249dw / MF246dn)(P. 157)**

Off †
On

Print Images

Select whether to print forwarded fax documents. You can set the machine to print forwarded documents only when an error occurs. **Printing Documents to be Forwarded(P. 157)**

Off
On †
Only When Error Occurs

Store Images in Memory

Select whether to store fax documents in memory when they are not successfully forwarded. You can resend or print the documents later as necessary. **Printing/Resending/Deleting Documents that Failed to be Forwarded(P. 158)**

Off †
Only When Error Occurs

Fax Setup Guide

Select to display on-screen instructions for specifying settings, including the fax number and the telephone line type. **Configuring Initial Settings for Fax Functions(P. 106)**

Scan Settings

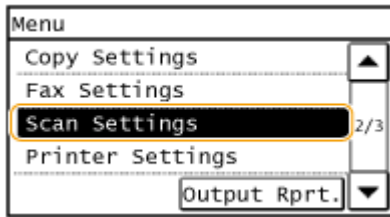

All the settings about the scan are listed with short descriptions. Default settings are marked with a dagger (†).

NOTE

Asterisks (*)

- Settings marked with "*1" are only available for the MF249dw / MF246dn.
- Settings marked with "*2" are only available for the MF249dw.
- Settings marked with "*3" are only available for the MF249dw / MF246dn / MF237w.

▶ **E-Mail Settings(P. 507)**

▶ **File Settings(P. 509)**

▶ **Register Unit Name (E-Mail)(P. 510)**

▶ **Output File Image Settings(P. 510)**

▶ **Shortcut Key Settings(P. 510)**

E-Mail Settings *1

Specify settings used for scanning documents to send as e-mails.

Change Default Settings

Specify settings used for scanning documents to send as e-mails. The selected settings are used as the default settings when scanning documents. ▶ **Changing Default Settings(P. 284)**

Scan Size

A4 †

A5

B5

LTR

LGL

STMT

Color Mode

Color †

Black & White

File Format

PDF †

PDF (Compact)

JPEG

TIFF

Density

Nine Levels

Original Orientation

Portrait †

Landscape

Original Type

Text

Text/Photo †

Photo

2-Sided Original*2

Off †

Book Type

Calendar Type

Sharpness

Seven Levels

Data Size

Small: Memory Priority

Standard †

Large: Image Quality Priority

Subject/Message

Subject

Message

Reply To

None †

Specify from Address Book

Priority

Low

Standard †

High

Initialize Default Settings

Select this option to restore the default e-mail transmission settings.

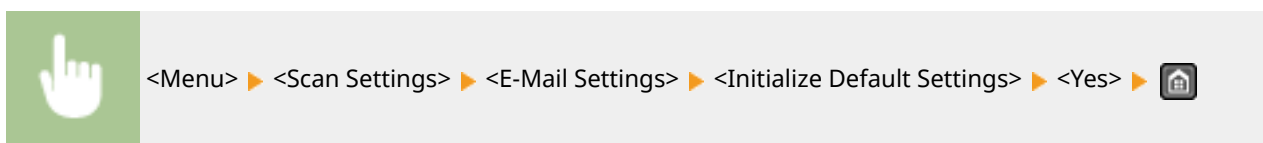

File Settings *1

You can change and register the settings used when documents are saved to a shared folder.

Change Default Settings

You can change the default settings used when documents are saved to a shared folder. The selected settings are used as the default settings when scanning. [▶ Changing Default Settings\(P. 284\)](#)

Scan Size

A4 †

A5

B5

LTR

LGL

STMT

Color Mode

Color †

Black & White

File Format

PDF †

PDF (Compact)

JPEG

TIFF

Density

Nine Levels

Original Orientation

Portrait †

Landscape

Original Type

Text

Text/Photo †

Photo

2-Sided Original*2

Off †

Book Type

Calendar Type

Sharpness

Seven Levels

Data Size

Small: Memory Priority

Standard †

Large: Image Quality Priority

Initialize Default Settings

You can change and register the settings used when documents are saved to a shared folder.

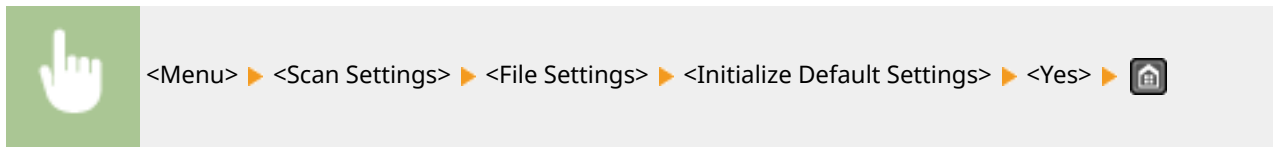

Register Unit Name (E-Mail) *1

Register the sender name for e-mails. The registered name is displayed in e-mails, along with the e-mail address. If the sender name is not registered, only the e-mail address is displayed.

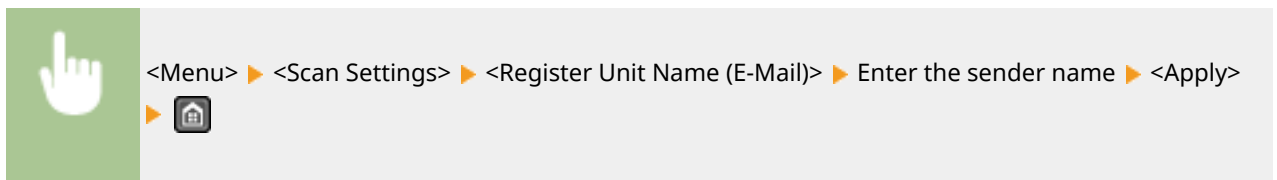

Output File Image Settings *1

Specify settings for the gamma value and file compression ratio for converting scanned documents into files.

YCbCr TX Gamma Value

Select the gamma value used when converting scanned color documents into the specified file format. You can specify the same gamma value as that of the monitor which is to be used for viewing the converted files. The files are displayed with brightness that is true to the original documents. ▶ **Setting Gamma Values(P. 271)**

Gamma 1.0
Gamma 1.4
Gamma 1.8 †
Gamma 2.2

Shortcut Key Settings

Register scan settings for the <Scan -> PC1> and <Scan -> PC2> buttons. The settings include the computer that scanned images are saved in, the type of scan (color or black and white), and the file format (PDF or JPEG). Registering these settings enables you to scan documents into a specified computer just by pressing a button. You can view the registered settings by selecting <Confirm Destination>. ▶ **Scanning Using the <Scan -> PC> Button(P. 237)**

Register
Scan -> PC1
Off †
USB Connection
Color Scan
B&W Scan
Custom 1

Custom 2

Network Connection*3

Color Scan

B&W Scan

Custom 1

Custom 2

Scan -> PC2

Off †

USB Connection

Color Scan

B&W Scan

Custom 1

Custom 2

Network Connection*3

Color Scan

B&W Scan

Custom 1

Custom 2

Confirm Destination

Scan -> PC1

Scan -> PC2

Printer Settings

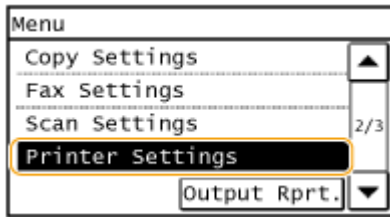

All the settings about the printer are listed with short descriptions. Default settings are marked with a dagger (†).

NOTE

Asterisks (*)

- Settings marked with "*1" are only available for the MF249dw / MF246dn / MF237w.
- Settings marked with "*2" are only available for the MF249dw / MF246dn.

Priority of settings

- If a print setting is specified both from the printer driver and the operation panel of the machine, the specification from the printer driver overrides that from the operation panel. The specification from the operation panel becomes effective in some specific cases, such as when performing PCL printing and printing from UNIX or other operating system that does not support printer drivers.





- ▶ Action When Paper Size Mismatch(P. 512)
- ▶ Mobile Print Halftones(P. 513)
- ▶ Copies(P. 513)
- ▶ 2-Sided Printing(P. 513)
- ▶ Default Paper(P. 514)
- ▶ Print Quality(P. 514)
- ▶ Layout(P. 515)
- ▶ Timeout(P. 516)
- ▶ PCL(P. 516)

Action When Paper Size Mismatch

Set whether printing goes ahead if a paper size other than the size loaded in the paper source is selected. You can also set the machine not to go ahead with printing and instead display an alert message. ▶ **When an Error Message Appears(P. 548)**

Force Output
Display Error †





<Menu> ▶ <Printer Settings> ▶ <Action When Paper Size Mismatch> ▶ Select <Force Output> or <Display Error> ▶ 

Mobile Print Halftones *1

Select the image processing when printing from a mobile device. Select <Gradation> for photos and illustrations, and <Error Diffusion> for mostly text documents for more attractive printouts.

Gradation †
Error Diffusion





<Menu> ▶ <Printer Settings> ▶ <Mobile Print Halftones> ▶ Select <Gradation> or <Error Diffusion> ▶ 

Copies *2

Set the number of copies to print.

1 † to 999





<Menu> ▶ <Printer Settings> ▶ <Copies> ▶ Set the number of copies to print ▶ <Apply> ▶ 

2-Sided Printing *2

Select whether to make 2-sided printouts.

Off †
On



<Menu> ▶ <Printer Settings> ▶ <2-Sided Printing> ▶ Select <Off> or <On> ▶ 

Default Paper *2

Use this item to specify the paper size. **Paper(P. 647)**



Print Quality

You can change settings related to print quality.

Density *2

Adjust the toner density.

17 Levels

Fine Adjust

High

17 Levels

Medium

17 Levels

Low

17 Levels

NOTE

- The settings specified for <Density> are disabled when <Toner Save> is enabled.

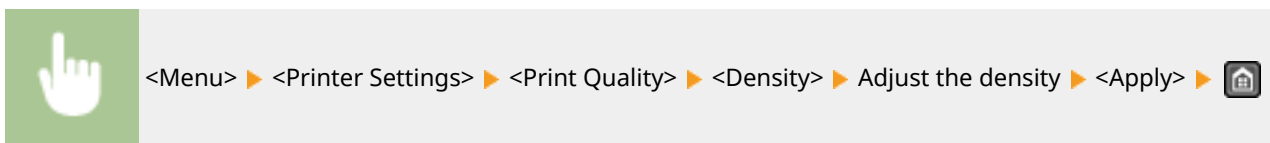

Toner Save

You can save toner consumption. Select <On> when you want to check the layout or other appearance characteristics before proceeding to final printing of a large job.

Off†

On

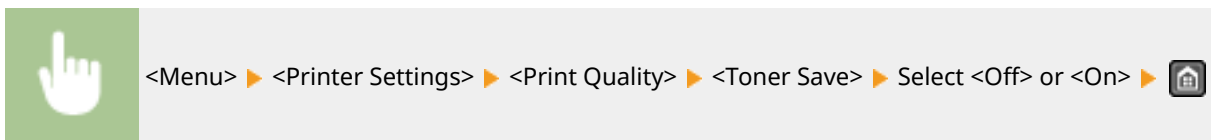

Special Print Mode *2

Select <Special Settings 1> if a printed bar code is unreadable, or <Special Settings 2> if print results are partially faded.

Off †
 Special Settings 1
 Special Settings 2





<Menu> ▶ <Printer Settings> ▶ <Print Quality> ▶ <Special Print Mode> ▶ Select <Special Settings 1> or <Special Settings 2> ▶ 

Resolution *2

Specify the resolution to be used for print data processing.

1200 dpi
 600 dpi †





<Menu> ▶ <Printer Settings> ▶ <Print Quality> ▶ <Resolution> ▶ Select <1200 dpi> or <600 dpi> ▶ 

Density Fine Adjustment *2

Finely adjust the density. You can specify this setting only when <1200 dpi> is selected in <Resolution>.

-1 to 0 † to 1



<Menu> ▶ <Printer Settings> ▶ <Print Quality> ▶ <Density Fine Adjustment> ▶ Specify the density ▶ 

Layout *2

Specify the page layout settings such as binding position.

Binding Location

If you are binding the printouts with a binding tool such as a stapler, use this item to specify whether to bind on the long or short edge.

Long Edge †
 Short Edge

 <Menu> ▶ <Printer Settings> ▶ <Layout> ▶ <Binding Location> ▶ Select <Long Edge> or <Short Edge> ▶ 

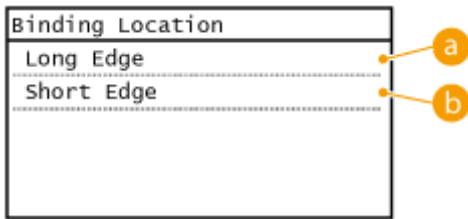

a <Long Edge>

Specify this to bind on the long edge of paper.



b <Short Edge>



Specify this to bind on the short edge of paper.



Timeout *2

Set the time period after which the current print job is automatically canceled in the case of a print data reception interruption.

5 to 15 ⁺ to 300 (sec.)

 <Menu> ▶ <Printer Settings> ▶ <Timeout> ▶ Set the time period ▶ <Apply> ▶ 



PCL *2

Specify the PCL printing settings such as page layout and print quality.

Paper Save

Select whether to save paper by not outputting blank pages in documents. By selecting <On>, the machine will not output blank pages. To output all your document data when printing, including any blank pages that you have inserted in your document, select <Off>.

Off ⁺
On

 <Menu> ▶ <Printer Settings> ▶ <PCL> ▶ <Paper Save> ▶ Select <Off> or <On> ▶ 

Orientation

Select <Portrait> (vertical orientation) or <Landscape> (horizontal orientation) for the page orientation.



Portrait †
Landscape

 <Menu> ▶ <Printer Settings> ▶ <PCL> ▶ <Orientation> ▶ Select <Portrait> or <Landscape> ▶ 

Font Number

Specify the font to use by selecting a corresponding font ID number. You can print the PCL font list with font samples from the operation panel.  **PCL Font List (MF249dw / MF246dn)(P. 616)**

0 † to 54

 <Menu> ▶ <Printer Settings> ▶ <PCL> ▶ ▶ Select the font number
▶ <Apply> ▶ 

Point Size

Set the font size in points, adjustable in 0.25 increments. You can specify this setting only when a proportionally-spaced scalable font is selected in .

4.00 to 12.00 † to 999.75 (point)

 <Menu> ▶ <Printer Settings> ▶ <PCL> ▶ <Point Size> ▶ Specify the point size ▶ <Apply> ▶ 

Pitch

Set the font pitch, or cpi (characters per inch), adjustable in 0.01 increments. You can specify this setting only when a fixed-pitch scalable font or a bitmap font is selected in .

0.44 to 10.00 † to 99.99 (cpi)



<Menu> ▶ <Printer Settings> ▶ <PCL> ▶ <Pitch> ▶ Specify the pitch value ▶ <Apply> ▶ 

Form Lines

Set the number of lines printed on one page from 5 to 128. This setting is automatically changed according to the settings specified in <Default Paper Size> and <Orientation>.

5 to 64 ⁺ to 128 (lines)



<Menu> ▶ <Printer Settings> ▶ <PCL> ▶ <Form Lines> ▶ Specify the number of lines
▶ <Apply> ▶ 

Character Code

Select the character code that is most suited for the computer you send print data from. The specified setting is ignored when the character code is controlled by the font specified in .

DESKTOP	PC8 ⁺
ISO4	PC850
ISO6	PC852
ISO11	PC8DN
ISO15	PC8TK
ISO17	PC1004
ISO21	PIFONT
ISO60	PSMATH
ISO69	PSTEXT
ISOL1	ROMAN8
ISOL2	VNINTL
ISOL5	VNMATH
ISOL6	VNUS
LEGAL	WIN30
MATH8	WINBALT
MCTEXT	WINL1
MSPUBL	WINL2
PC775	WINL5



<Menu> ▶ <Printer Settings> ▶ <PCL> ▶ <Character Code> ▶ Select the character code ▶ 

Custom Paper

Select whether to set a custom paper size. Select <On> to set the dimensions of the paper in <X dimension> and <Y dimension>.

Off †
On



<Menu> ▶ <Printer Settings> ▶ <PCL> ▶ <Custom Paper> ▶ Select <Off> or <On> ▶

Unit of Measure

Select the unit of measurement to use to set a custom paper size.

Millimeters †
Inches



<Menu> ▶ <Printer Settings> ▶ <PCL> ▶ <Unit of Measure> ▶ Select <Millimeters> or <Inches> ▶

X dimension

Specify the horizontal dimension (short edge) of the custom paper.

77 to 216 † (mm)



<Menu> ▶ <Printer Settings> ▶ <PCL> ▶ <X dimension> ▶ Specify the dimension ▶ <Apply> ▶

Y dimension

Specify the vertical dimension (long edge) of the custom paper.

127 to 356 † (mm)



<Menu> ▶ <Printer Settings> ▶ <PCL> ▶ <Y dimension> ▶ Specify the dimension ▶ <Apply> ▶

Append CR to LF

Select whether to append a carriage return (CR) when the machine receives a line feed code (LF). If <Yes> is selected, the print position moves to the beginning of the next line when the machine receives an LF code. If <No> is selected, the print position moves to the next line, just under the received LF code.

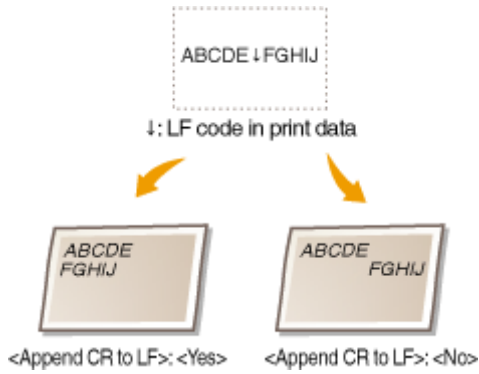

Yes
No †



Enlarge A4 Print Width

Select whether to expand the width of the printable area of A4 size paper in portrait orientation to that of LTR size.

Off †
On



Halftones

You can select the printing method to reproduce halftones (the intermediate range between the lighter and darker areas of an image) for optimal image quality. For each document, you can make settings by type of image.

Text

- Color Tone
- Gradation
- Resolution †

Graphics

- Color Tone †
- Gradation
- Resolution

Image

- Color Tone †
- Gradation
- Resolution

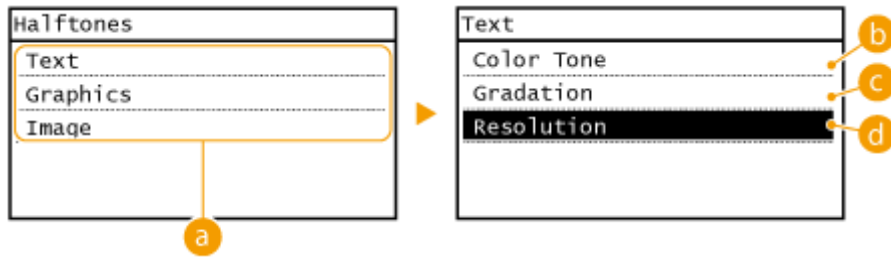
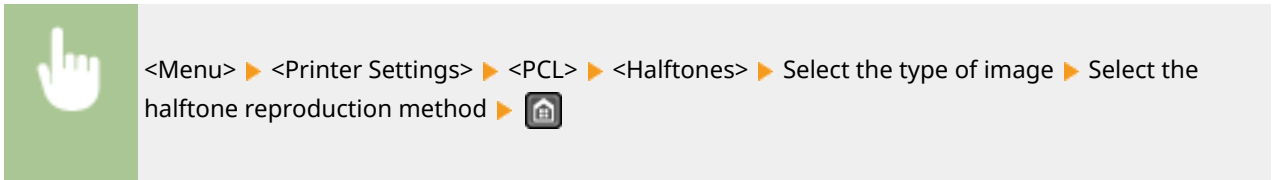

a Type of image

Select the object for which to change the setting. <Text> represents letters and characters, <Graphics> represents lines and figures, and <Image> represents photos and images.

b <Color Tone>

Produces a sharp print with strong contrast of lightness and darkness. It is suitable for printing image data such as photo image data.

c <Gradation>

Produces a print with smooth gradation or smooth edges. It is suitable for printing figures or graphs containing gradation areas.

d <Resolution>

Produces a fine print with clear edges of text. It is suitable for printing characters and fine lines.

Adjustment/Maintenance

14L7-096

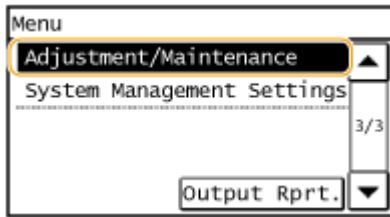

All the settings about adjustment and maintenance are listed with short descriptions. Default settings are marked with a dagger (†).

NOTE

Asterisks (*)

- Settings marked with an asterisk (*) are only available for the MF249dw / MF246dn / MF237w.

- ▶ **Displ. Timing for Cartridge Prep. Notif.(P. 522)**
- ▶ **Toner Save(P. 522)**
- ▶ **Special Processing(P. 523)**
- ▶ **Clean Fixing Assembly(P. 527)**

Displ. Timing for Cartridge Prep. Notif.

Set the display timing for the message notifying you that the amount remaining in the toner cartridges is low.

Auto † Custom 10 to 20 † to 99 (%)
--



<Menu> ▶ <Adjustment/Maintenance> ▶ <Displ. Timing for Cartridge Prep. Notif.> ▶ <Custom> ▶
 Enter the toner cartridge level ▶ <Apply> ▶ 

Toner Save

Select whether to reduce toner consumption when copying or faxing.

Copy Off † On
Fax Off † On



NOTE:

When set to <On>

Fine lines and portions with lighter print density may become blurred.

Special Processing

If the print results on special types of paper are not satisfactory, the following settings may improve the quality of the printouts.

Special Printing Mode U

If toner appears splattered around text and patterns in a printout, select <On>.



NOTE:

When set to <On>

Print quality can be affected by the type of paper (especially lightweight paper) and the printing environment (especially high humidity).

Special Printing Mode V

Adjust this setting if the print paper curls or wrinkles.

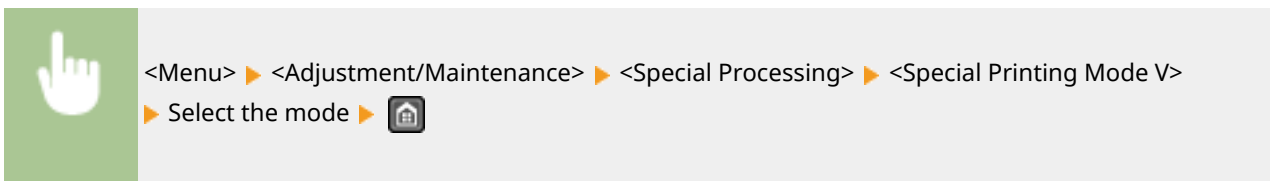

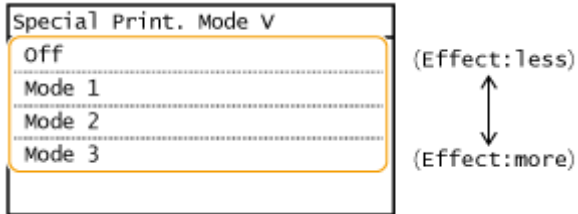

NOTE:

To enable the setting

This setting is enabled in the following conditions.

- The paper size is set to <B5>, <A5>, <STMT>, or <EXEC>
- <Paper Type> is set to <Plain (60-89 g/m²)>, <Plain L (60-89 g/m²)>, <Recycled (60-89 g/m²)>, <Color (60-89 g/m²)>, or <Envelope>

After the setting is enabled

Print speed is slower.

Special Printing Mode X*

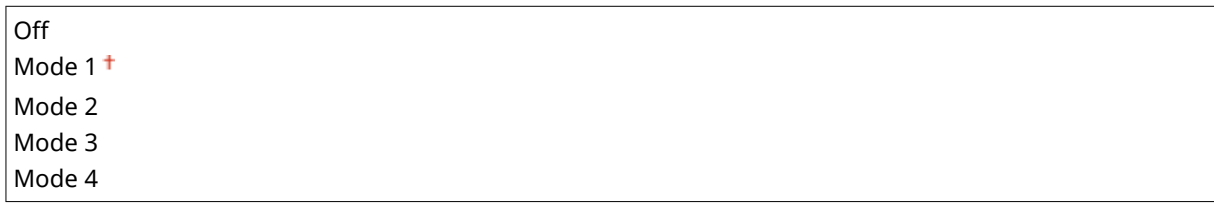

Adjust this setting if streaks adhere to the print paper.

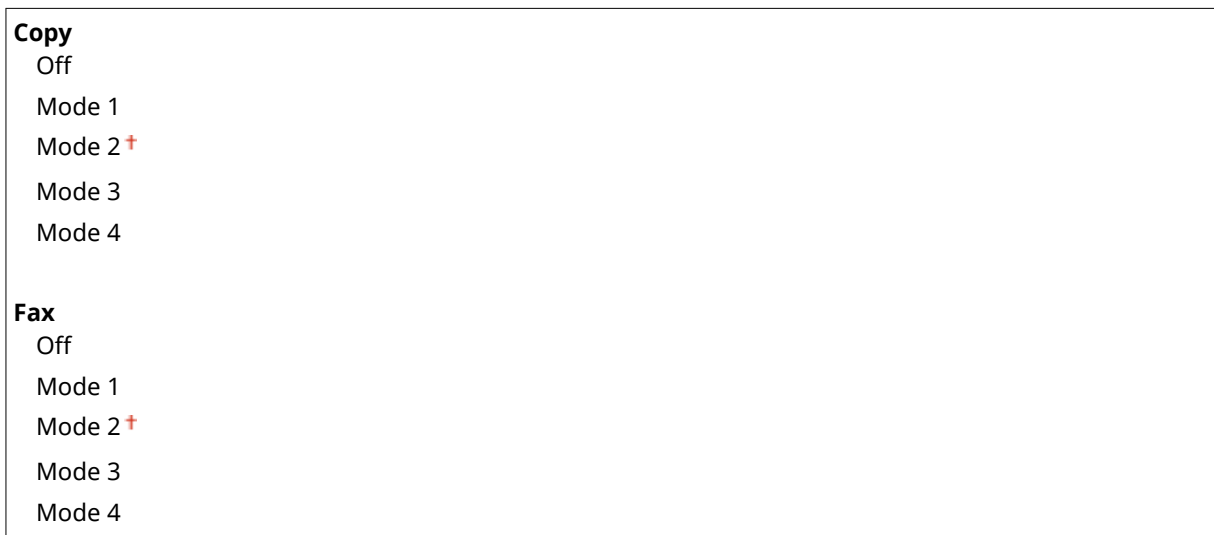

Special Printing Mode Z

Adjust this setting if streaks adhere to the print paper output when copying or faxing.



 <Menu> ▶ <Adjustment/Maintenance> ▶ <Special Processing> ▶ <Special Printing Mode Z> ▶
 Select <Copy> or <Fax> ▶ Select the mode ▶ 

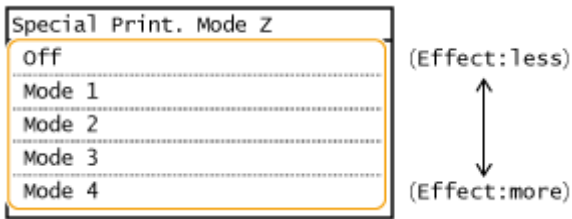

NOTE:

After the setting is changed

By specifying <Off> or <Mode 1>, streaks may adhere to the print paper. By specifying <Mode 3> or <Mode 4>, outlines may be blurred or images may appear somewhat grainy. The print density becomes lighter as the setting progresses from <Off> to <Mode 4>.



After printing from a smartphone or tablet

If streaks adhere to the paper, change the setting with <Special Printing Mode Z> ▶ <Copy>.

Special Printing Mode B

Adjust this setting if streaks adhere to the print paper after replacing the toner cartridge or after not printing for a long period of time.



 <Menu> ▶ <Adjustment/Maintenance> ▶ <Special Processing> ▶ <Special Printing Mode B>
 ▶ Select the mode ▶ 

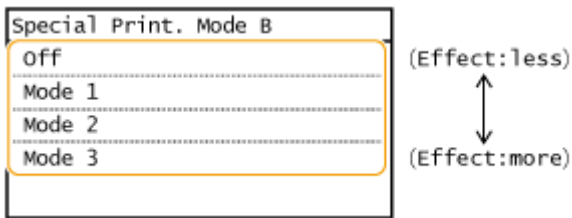

NOTE:

After the setting is enabled



Print speed is slower.

Special Printing Mode C

Adjust this setting if streaks adhere to the print paper when printing out received faxes.



On

 <Menu> ▶ <Adjustment/Maintenance> ▶ <Special Processing> ▶ <Special Printing Mode C>
▶ <On> ▶ 

NOTE:

After the setting is enabled



- While more effect is gained than with <Special Printing Mode Z>, print speed is slower.

Special Printing Mode D

Adjust this setting if streaks adhere to the print paper. Also, setting this item to <On> will reduce the operating noise during printing.

Copy
Off †
On

Print
Off †
On

 <Menu> ▶ <Adjustment/Maintenance> ▶ <Special Processing> ▶ <Special Printing Mode D>
▶ Select <Copy> or <Print> ▶ <On> ▶ 

NOTE:

After the setting is enabled

- While more effect is gained than with <Special Printing Mode Z>, print speed is slower.

After printing from a smartphone or tablet

If streaks adhere to the paper, change the setting with <Special Printing Mode D> ▶ <Copy>.

Special Printing Mode I

Only select <On> if paper jams frequently when performing 2-sided printing on lightweight paper or on curled paper.

Off †
On

 <Menu> ▶ <Adjustment/Maintenance> ▶ <Special Processing> ▶ <Special Printing Mode I>
▶ <On> ▶ 

NOTE:

When set to <On>

White patches may appear in images printed on paper other than lightweight paper.

Special Printing Mode J

If printing is uneven when printing fine lines or faint images, select <On>.

Off [†]
On

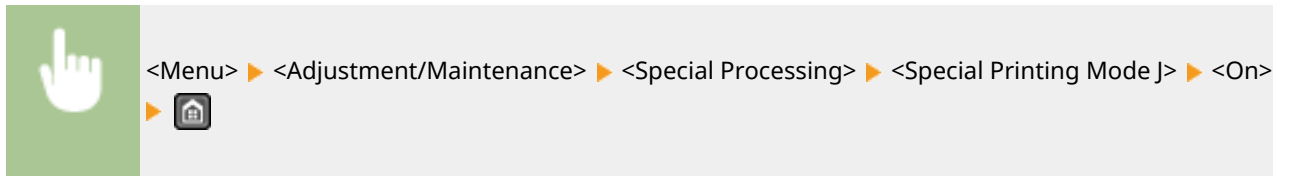

NOTE:

When set to <On>.

The following may occur.

- Definition may be affected
- Toner appears in non-print areas when using a new toner cartridge
- Toner cartridge may be used up more quickly

Special Printing Mode K

If toner does not adhere adequately and printouts are faded, select <On>.

Off [†]
On

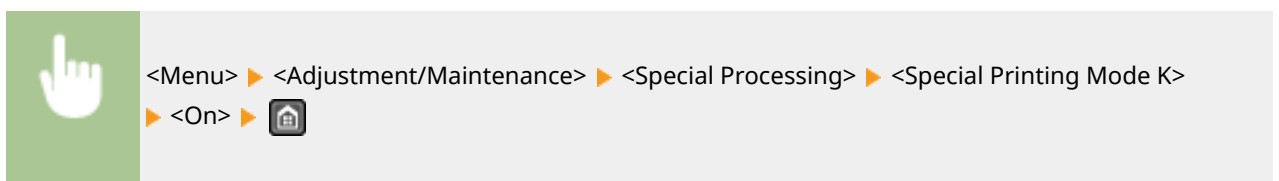

NOTE:

When set to <On>

Print speed is slower.

Clean Fixing Assembly

Clean the fixing unit after a toner cartridge is replaced or if black streaks appear on printouts. **▶ Fixing Assembly(P. 594)**

System Management Settings

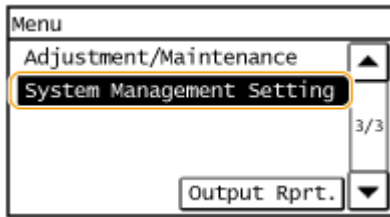

All the settings about System Management Settings are listed with short descriptions. Default settings are marked with a dagger (†).

NOTE

If a screen for entering a PIN is displayed

Enter the PIN with the numeric keys and tap <Apply>. [▶Setting the System Manager PIN\(P. 397\)](#)

Asterisks (*)

- Settings marked with "*1" are only available for the MF249dw / MF246dn / MF237w.
- Settings marked with "*2" have different defaults depending on the country or region of purchase.
- "*3": Displayed as <Display Consumables Info. (Toner Status)> for the MF235.
- Settings marked with "*4" are only available for the MF249dw / MF246dn.

- ▶[Network Settings\(P. 528\)](#)
- ▶[System Manager Information Settings\(P. 529\)](#)
- ▶[Device Information Settings\(P. 529\)](#)
- ▶[Security Settings\(P. 529\)](#)
- ▶[Select Country/Region\(P. 530\)](#)
- ▶[Remote UI Settings\(P. 531\)](#)
- ▶[Auto Online for Remote Scan\(P. 531\)](#)
- ▶[Restrict TX Function\(P. 532\)](#)
- ▶[Display Job Log\(P. 532\)](#)
- ▶[Use as USB Device\(P. 532\)](#)
- ▶[Enable Product Extended Survey Program\(P. 533\)](#)
- ▶[Displ. Consmbls. Info \(RUI/Toner Status\)\(P. 533\)](#)
- ▶[Google Cloud Print Settings\(P. 533\)](#)
- ▶[Import/Export Address Book\(P. 534\)](#)
- ▶[PDL Selection \(Plug and Play\)\(P. 534\)](#)
- ▶[Update Firmware\(P. 535\)](#)
- ▶[Initialize Address Book\(P. 535\)](#)
- ▶[Initialize Eco Report Counter\(P. 535\)](#)
- ▶[Initialize Menu\(P. 535\)](#)
- ▶[Initialize All Data/Settings\(P. 536\)](#)

Network Settings ^{*1}

See [▶Network Settings \(MF249dw / MF246dn / MF237w\)\(P. 473\)](#) .

System Manager Information Settings

Specify the PIN exclusively for Administrators who have access privileges to <Network Settings> and <System Management Settings>. You can set the PIN from <System Manager PIN>. You can also register the name of an Administrator. **▶Setting the System Manager PIN(P. 397)**

System Manager PIN

Enter a number of up to seven digits for the System Manager PIN.

System Manager Name

Enter up to 32 alphanumeric characters for the name of an Administrator.

Device Information Settings

Enter up to 32 alphanumeric characters for the name and the installation location to identify the machine.

Device Name
Location



<Menu> ▶ <System Management Settings> ▶ <Device Information Settings> ▶ Select <Device Name> or <Location> ▶ Enter <Device Name> or <Location> (**▶Entering Text(P. 38)**) ▶ <Apply>



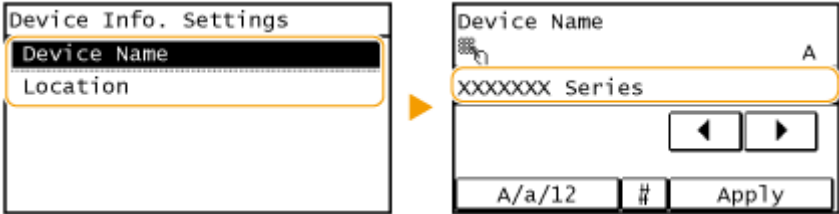

Security Settings *1

Enable or disable settings for IP address or MAC address packet filtering.

Use TLS



Select whether to use TLS encrypted communication. **▶Enabling TLS Encrypted Communication for the Remote UI(P. 426)**

Off [†]
On

IPv4 Address Filter

Enable or disable settings for filtering packets received from devices with specified IPv4 addresses. **▶Specifying IP Addresses for Firewall Rules(P. 402)**



Off [†]
On

 <Menu> ▶ <System Management Settings> ▶ <Security Settings> ▶ <IPv4 Address Filter> ▶ <Inbound Filter> ▶ Select <Off> or <On> ▶ 

IPv6 Address Filter

Enable or disable settings for filtering packets received from devices with specified IPv6 addresses. ▶
Specifying IP Addresses for Firewall Rules(P. 402)



Off [†]
 On

 <Menu> ▶ <System Management Settings> ▶ <Security Settings> ▶ <IPv6 Address Filter> ▶ <Inbound Filter> ▶ Select <Off> or <On> ▶ 

MAC Address Filter

Enable or disable settings for filtering packets received from devices with specified MAC addresses. ▶
Specifying MAC Addresses for Firewall Rules(P. 406)

Off [†]
 On

 <Menu> ▶ <System Management Settings> ▶ <Security Settings> ▶ <MAC Address Filter> ▶ <Inbound Filter> ▶ Select <Off> or <On> ▶ 

Select Country/Region *2

Specify the country or region where the machine is used. The default setting may vary depending on the setting selected at initial power-on.

Hong Kong (HK)
 Singapore (SG)
 Australia (AU)
 New Zealand (NZ)
 Malaysia (MY)
 Vietnam (VN)
 Argentina (AR)
 Thailand (TH)
 India (IN)
 Philippines (PH)
 Other
 Other (Asia)
 Other (Latin America)

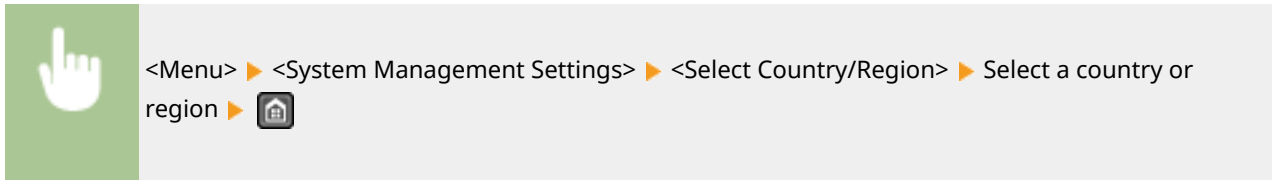

Remote UI Settings ^{*1}

Configure settings for using the Remote UI. Using the Remote UI allows you to configure machine settings from a Web browser.

Use Remote UI

Select whether to use the Remote UI. Using the Remote UI allows you to configure machine settings from a Web browser. **Disabling Remote UI (MF249dw / MF246dn / MF237w)(P. 424)**

Off
On

Remote UI Access Security Settings

Set whether a PIN is required for accessing the Remote UI. Set a PIN of up to 7 digits. All users use a common PIN. **Setting a Remote UI PIN (MF249dw / MF246dn / MF237w)(P. 399)**

Off
On
Remote UI Access PIN

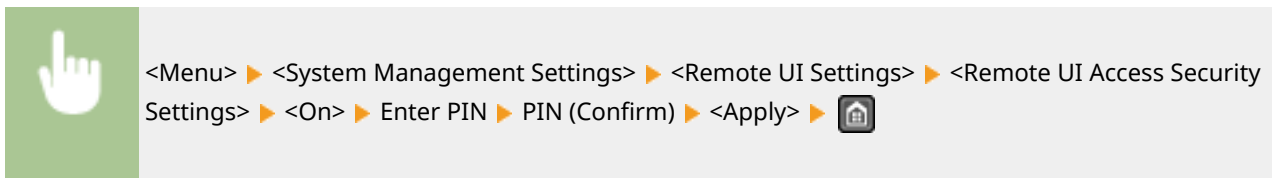

Auto Online for Remote Scan

Select whether to use this feature to go online for remote scanning, even without using the operation panel.

Off
On

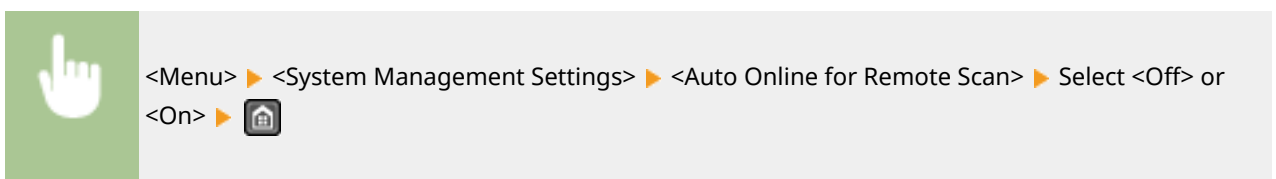

Restrict TX Function

Specify settings for restricting access to sending functions for selected destinations.

Address Book PIN

Specify a PIN and require entering it to add new entries to or edit existing entries in the Address Book. ▶
Setting a PIN for Address Book(P. 415)

Restrict New Destinations

Select whether to limit the fax numbers and e-mail addresses that can be specified as destinations to those already registered in the Address Book. ▶**Limiting Available Destinations(P. 417)**

Off †
On

Restrict Resending from Log

Select whether to prevent a destination from being selected from the sent job logs. ▶**Disabling Use of Previously Used Destinations(P. 419)**

Off †
On

One-Touch/Coded Dial TX Confirmation

Select whether to display the details of an entered coded dial number when it is selected as a destination. ▶
Displaying Destinations in Address Book(P. 420)

Off †
On

Display Job Log

Select whether to display the faxing logs on the display of the machine and in the Communication Management Report.

Off
On †



<Menu> ▶ <System Management Settings> ▶ <Display Job Log> ▶ Select <Off> or <On> ▶

Use as USB Device

Enable or disable the USB port that is used for connecting the machine to a computer.

Off
On †



<Menu> ▶ <System Management Settings> ▶ <Use as USB Device> ▶ Select <Off> or <On>
▶ Restart the machine

Enable Product Extended Survey Program

Enable or disable the Product Extended Survey Program (a program for the machine usage survey).

Off
On †



<Menu> ▶ <System Management Settings> ▶ <Enable Product Extended Survey Program> ▶ Select <Off> or <On> ▶

Displ. Consmbls. Info (RUI/Toner Status) *3

Set whether to display a button in the Remote UI or Toner Status for accessing the Web site for purchasing toner cartridges. Also set whether to use Toner Status.

Displ. Consumables Purchase Button (RUI) *1
Off
On †

Toner Status Settings
Off
On †

Displ. Purchase Button
Off
On †



<Menu> ▶ <System Management Settings> ▶ <Displ. Consmbls. Info (RUI/Toner Status)> ▶ Select <Displ. Consumables Purchase Button (RUI)> or <Toner Status Settings> ▶ Select <Off> or <On> ▶

NOTE:

If you selected <On> for <Toner Status Settings>, continue by selecting <On> or <Off> for <Displ. Purchase Button>.

Google Cloud Print Settings *1

Enable or disable Google Cloud Print. **▶Using Google Cloud Print(P. 308)**

Enable Google Cloud Print

Off

On [†]

Google Cloud Print Registration Status

Import/Export Address Book

You can import an Address Book from a computer or export an Address Book from the machine. **▶Importing/Exporting Address Book Data with the Supplied Software(P. 165)**

PDL Selection (Plug and Play)

Select a page description language so that the machine is detected as a printer that is compatible with that language when it is connected to a computer by using Plug and Play. For more information, see "MF Driver Installation Guide."

Network ^{*1}

Select a page description language so that the machine is detected as a printer that is compatible with that language when it is detected over the network.

FAX

UFRII LT [†]

UFRII LT (V4)

PCL6^{*4}

USB

Select a page description language so that the machine is detected as a printer that is compatible with that language when it is connected to a computer via USB.

UFRII LT [†]

UFRII LT (V4)

PCL6^{*4}

NOTE:

Any setting change is enabled the next time the main power is turned ON.

<Menu> ▶ <System Management Settings> ▶ <PDL Selection (Plug and Play)> ▶ Select <Network> or <USB> ▶ Select a page description language ▶ Restart the machine

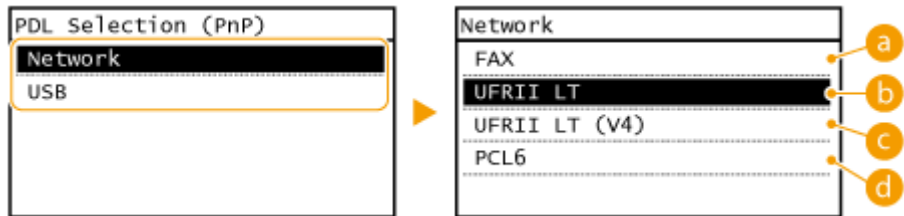

a <FAX>

Detects and connects the machine as a fax device.

b <UFRII LT>

Detects and connects the machine as a UFRII LT printer.

c <UFRII LT (V4)>

Detects and connects the machine as a UFRII LT printer that is compatible with XML Paper Specification (XPS).

d <PCL6> *4

Detects and connects the machine as a PCL6 printer.

Update Firmware

Select how to install the firmware update according to the environment of the machine.

- <Via PC>

Select to manually install the firmware update available on the Canon Web site yourself. For instructions on how to install the update, see the instruction manual available on the Web site. When the machine uses a wireless LAN, update with <Via Internet> below or use a USB cable to connect.

- <Via Internet>*1

Select to automatically install the firmware update without using a computer. Follow the on-screen instructions to perform the update. The machine must be connected to the Internet.

- <Version Information>

Select to check details for the current firmware.

Via PC

Via Internet*1

Version Information

Initialize Address Book

Select to restore the Address Book settings to the factory defaults. **▶Initializing Address Book (P. 624)**

Initialize Eco Report Counter

Select to restore the Eco Report Counter settings to the factory defaults. **▶Initialize Eco Report Counter(P. 625)**

Initialize Menu

Select to restore the settings to the factory defaults. You can restore all the settings at once. **▶Initializing Menu(P. 622)**

Preferences
 Timer Settings
 Common Settings*4
 Copy Settings
 Fax Settings
 Scan Settings
 Printer Settings
 Adjustment/Maintenance
 System Management Settings
 Initialize All

System Management Settings

Select to restore the System Management Settings to the factory defaults. You can restore all the System Management Settings at once.  **Initializing Menu(P. 622)**

Network Settings*1	Use as USB Device
System Manager Information Settings	Enable Product Extended Survey Program
Device Information Settings	Displ. Consmbls. Info (RUI/Toner Status)*3
Security/Remote UI Settings*1	Google Cloud Print Settings*1
Auto Online for Remote Scan	PDL Selection (Plug and Play)
Restrict TX Function	Initialize All
Display Job Log	

Initialize All Data/Settings

Delete all data on the machine and return it to its factory default settings.



<Menu> ▶ <System Management Settings> ▶ <Initialize All Data/Settings> ▶ <Yes> ▶ <Yes>
 ▶ Restart the machine

Troubleshooting

Troubleshooting	538
Clearing Jams	540
When an Error Message Appears	548
When an Error Code Appears	558
Common Problems	564
Installation/Settings Problems	565
Copy/Printing Problems	569
Faxing/Telephone Problems	572
When You Cannot Print Properly	574
Printing Results Are Not Satisfactory	576
Paper Creases or Curls	581
Paper Is Fed Incorrectly	583
When a Problem Cannot Be Solved	585

Troubleshooting

When a problem occurs, check this chapter to find out solutions before contacting Canon.

■ Paper Jams

If a document or paper jams, see [▶Clearing Jams\(P. 540\)](#) to remove the jammed paper.



■ A Message or Error Code Appears

If the screen displays a message or error code (three digits), see the following sections.



[▶When an Error Message Appears\(P. 548\)](#)

[▶When an Error Code Appears\(P. 558\)](#)

■ Common Problems

If you suspect that the machine is malfunctioning, see the following sections before contacting Canon.



[▶Common Problems\(P. 564\)](#)

[▶Installation/Settings Problems\(P. 565\)](#)

[▶Copy/Printing Problems\(P. 569\)](#)

[▶Faxing/Telephone Problems\(P. 572\)](#)

■ Printing Results are Not Satisfactory

If printing results are not satisfactory, see [▶When You Cannot Print Properly\(P. 574\)](#) .



■ When a Problem Cannot Be Solved

If a problem persists, see [▶When a Problem Cannot Be Solved\(P. 585\)](#) to find out where to contact.



Clearing Jams

14L7-099

If a paper jams, <Paper jammed.> is displayed on the screen. Tap <Next> to display simple solutions. If it is difficult to understand the procedures on the display, see the following sections to clear jams.

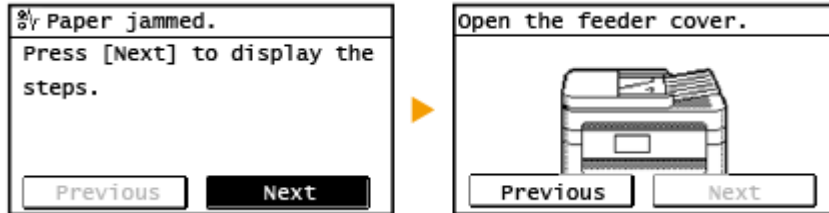

MF249dw

- <Open the feeder cover.>
 - ▶ **Document Jams in the Feeder (MF249dw)(P. 541)**
- <Close the upper area.> ▶ <Lift the control panel.>
 - ▶ **Paper Jams inside the Machine(P. 543)**

MF246dn / MF237w / MF235

- <Open the feeder cover.>
 - ▶ **Document Jams in the Feeder (MF246dn / MF237w / MF235)(P. 542)**
- <Close the upper area.> ▶ <Lift the control panel.>
 - ▶ **Paper Jams inside the Machine(P. 543)**

IMPORTANT

When removing the jammed paper, do not turn OFF the machine

Turning OFF the machine deletes the data that is being printed. Be especially careful when receiving fax documents.

If paper tears

Remove all the paper fragments to prevent them from becoming jammed.

If paper jams repeatedly

- Make sure that the paper and the packing material are completely removed.

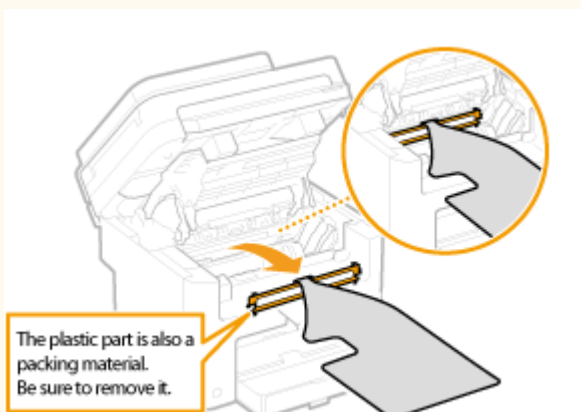

- Tap the paper stack on a flat surface to even the edges of the paper before loading it into the machine.
- Check that the paper is appropriate for the machine.
 - ▶ **Paper(P. 647)**
- Check that no jammed paper fragments remain in the machine.

Do not forcibly remove the jammed document or paper from the machine

Forcibly removing the paper may damage parts. If you are not able to remove the paper, contact your local authorized Canon dealer or the Canon help line.

▶When a Problem Cannot Be Solved(P. 585)

Document Jams in the Feeder (MF249dw)

If there are documents placed in the feeder, remove them first. Then, follow the procedure below.

1 Remove the jammed document from the feeder cover.

- 1 Open the feeder cover.

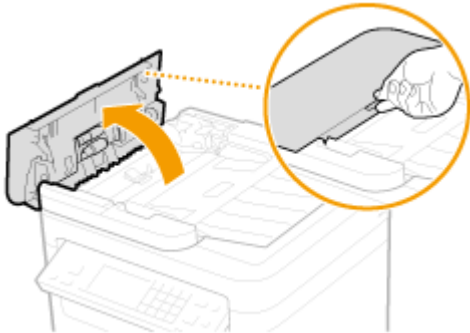

- 2 Move the lever to unlock.

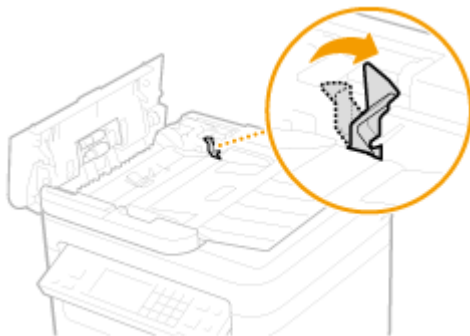

- 3 Gently pull out the document.

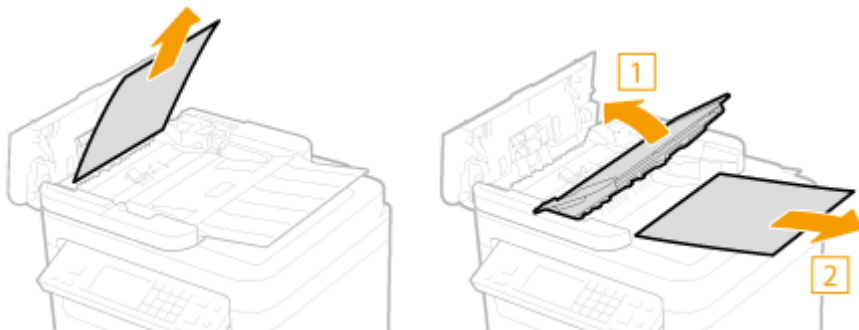

2 Remove the jammed document from the inner cover inside the feeder.

- 1 Hold the green knob, and open the inner cover.

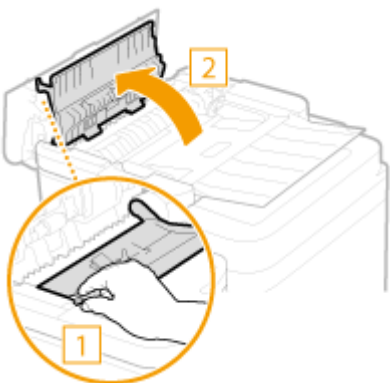

2 Gently pull out the document.



3 Close the inner cover.

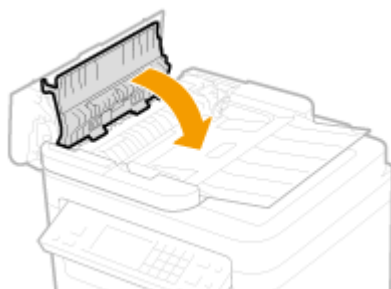

3 Return the lever back in place, and close the feeder cover.

Document Jams in the Feeder (MF246dn / MF237w / MF235)

If there are documents placed in the feeder, remove them first. Then, follow the procedure below.

1 Open the feeder cover.

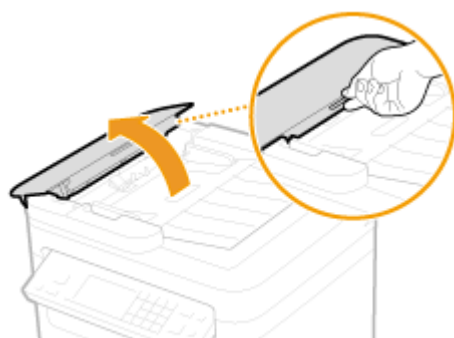

2 Gently pull out the document.



3 Close the feeder cover.

Paper Jams inside the Machine

1 Remove the toner cartridge.

1 Lift the operation panel.

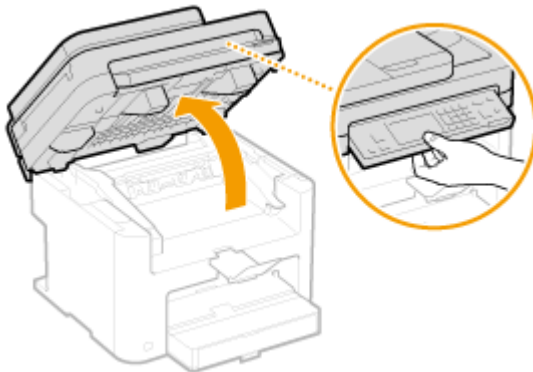

IMPORTANT:

The operation panel cannot be opened if the feeder is not completely closed. Forcing the operation panel up may cause damage.

2 Open the toner cover by the grip at the front right of the toner cover.

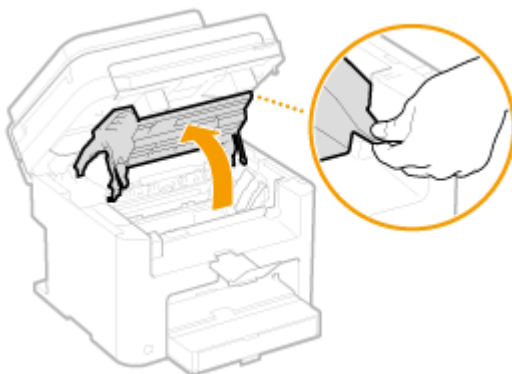

3 Remove the toner cartridge.

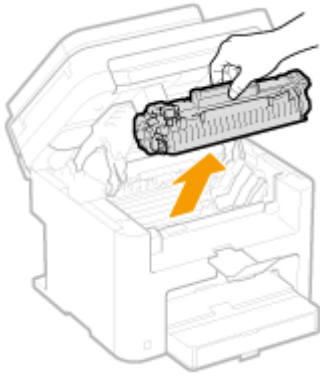

2 Gently pull out the document.



3 Check whether paper is jammed inside the paper exit guide.

1 Pull out toward you while pressing the button (a) to open the paper exit guide.

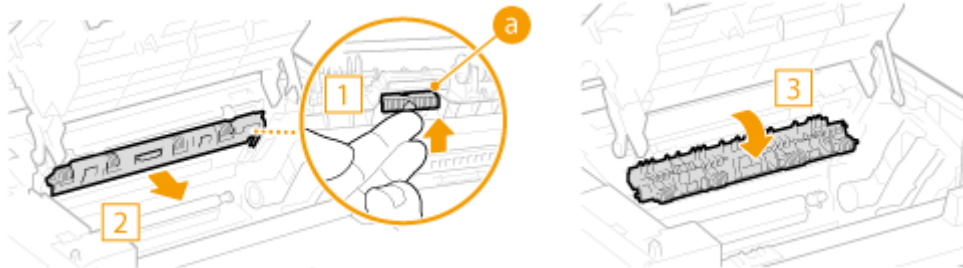

2 Gently pull out the document.



3 Close the paper exit guide.

4 Check whether paper is jammed inside the machine.

- 1 Gently pull out any paper between the fixing assembly (a) and roller (b) until you can see the edge of the paper.

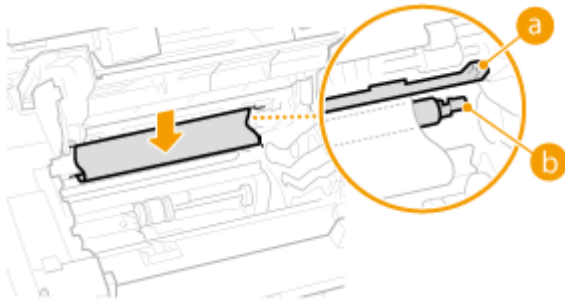

- 2 Once the edge of the paper is visible, pull it out slowly.

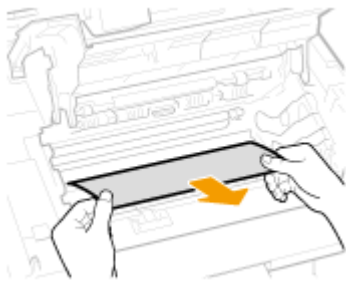

5 Check whether paper is jammed in the manual feed slot or paper drawer.

- 1 Slowly pull out any paper in the manual feed slot.

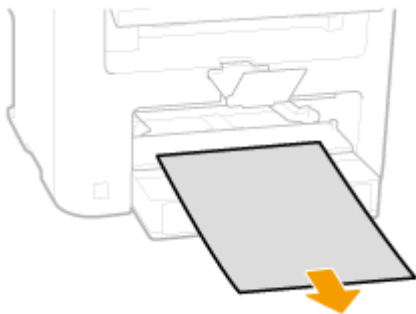

- 2 Open the paper cover and remove any loaded paper.

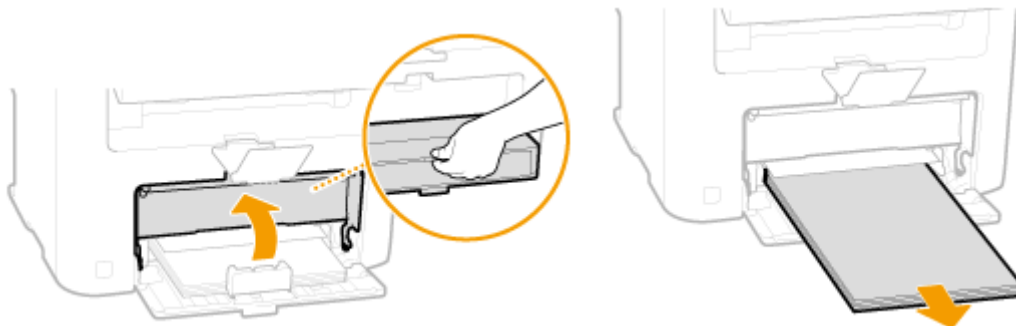

- 3 Gently pull out the document.

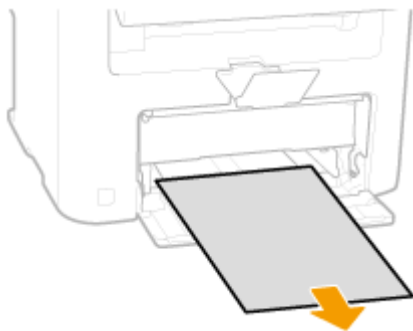

- 4 Load paper and close the paper cover.
 - For MF237w / MF235, proceed to step 7.

6 Check whether paper is jammed inside the rear cover.

- 1 Open the rear cover.

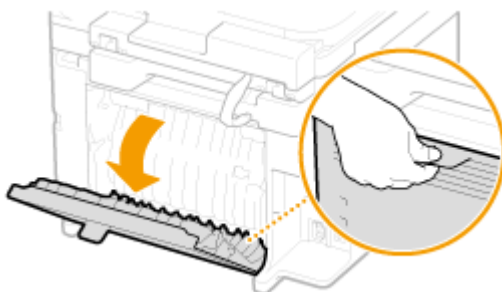

- 2 Gently pull out the document.

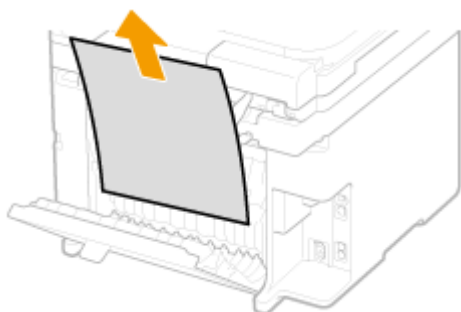

- 3 Close the rear cover.

7 Install the toner cartridge.

- Align the right and left projections (a) with the toner cartridge guides, and push securely all the way in.

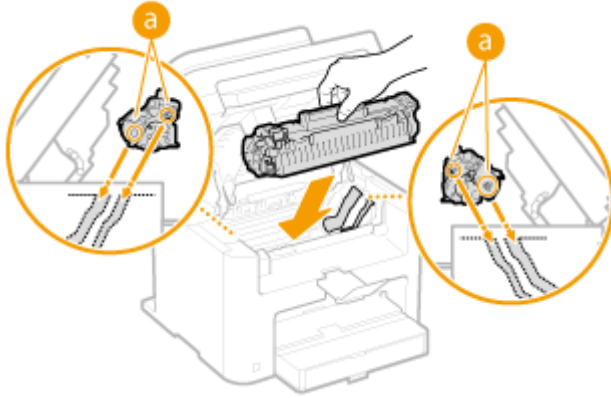

8 Close the toner cover, and lower the operation panel.

NOTE

If you cannot close the toner cover

Make sure that the toner cartridge is inserted properly. Forcing it closed may cause damage.

When an Error Message Appears

14L7-09A

If you cannot send a fax or the memory is full, or you encounter operation problems, a message appears on the display. Find out more information about messages in the following list.

A counterfeit or non-Canon cartridge may be in use. The amount remaining in the cartridge cannot be displayed correctly.

You might not be using a Canon genuine toner cartridge.

- We recommend Canon genuine toner cartridges as replacement toner cartridges.
- ▶ **Consumables(P. 655)**

Cannot change the destination type of any destination that is registered to a group.

A selected destination could not be edited because it was registered to Group Dial.

- To change the type of destination that is registered to Group Dial, first delete the registered destination from Group Dial. Next, change the destination type, and then register the destination to Group Dial again.

Cannot export. An error has been detected during file creation.

Exporting the address book failed.

- Check the USB cable connecting the machine to a computer.
- Check if you have access permission to the destination folder of the address book on the computer.
- ▶ **Importing/Exporting Address Book Data with the Supplied Software(P. 165)**

NOTE:

You cannot access or edit the address book if you do not have access permission to the destination folder of the address book. If you do not have permission, log on as a user with access privileges, or change the destination for saving the address book.

Cannot find the access point.

When automatic setting with WPS was attempted, a wireless router could not be detected within a specific period of time.

- Connect again paying attention to the time limit.
- ▶ **Setting Up Connection Using WPS Push Button Mode(P. 321)**
- ▶ **Setting Up Connection Using WPS PIN Code Mode(P. 323)**

An SSID of a wireless router was entered, but the entry was incorrect.

- Check the SSID and enter the correct one again.
- ▶ **Checking the SSID and Network Key(P. 333)**

▶ **Setting Up Connection by Specifying Detailed Settings(P. 329)**

A wireless router could not be detected due to setting problems of the network to be connected.

- Check whether the machine is properly installed and ready to connect to the network.

▶ **Installation/Settings Problems(P. 565)**

- If the problem persists, check the security settings of the wireless router.

Cannot import. A file error has been detected.

Importing the address book failed.

- Check the USB cable connecting the machine to a computer.
- Check if the contents of address book to be imported is correct.

▶ **Importing/Exporting Address Book Data with the Supplied Software(P. 165)**

Cannot print RX data.

A received document cannot be printed due to the following:

- Replacement period of the toner cartridge is near.
- A cover is opened.
- A toner cartridge is not set.
- Paper is not set.
- A document or paper jams.
- An abnormality occurs.
- Check whether the problems above are occurring. If messages including causes and solutions appear on the display, check the contents.

Cannot receive the fax. Make sure the fax was sent correctly by the sender.

The recipient's machine did not respond within 35 seconds.

- Ask the sender to send the fax again. If you hear a beep, tap <Start Receiving> to receive the fax.

▶ **Receiving Faxes(P. 142)**

Cannot send because more than one destination is specified.

Sending a fax to multiple destinations is disabled.

- To specify multiple destinations, you need to set <Restrict Sequential Broadcast> to <Off> or <Confirm Sequential Broadcast>. For more information, contact your Administrator.

▶ **Prohibiting Sequential Broadcasting(P. 422)**

Cannot specify a group.

Group Dial was specified as a destination after pressing <Hook>.

- Once you tap <Hook>, you cannot specify destinations in Group Dial. Tap <End> on the <Specify destination.> screen, and specify destinations to send fax documents without tapping <Hook>.

Cannot use Google Cloud Print. Server authentication failed.

Cloud Print could not perform server authentication, or could not acquire information for registration.

- Check whether the date and time settings are correctly specified.
- ▶ **Date/Time Settings(P. 488)**

Cannot use Google Cloud Print. Server communication error.

Cloud Print is unavailable due to an error.

Check whether the machine is correctly connected to a wireless LAN or wired LAN.

- ▶ **Connecting to a Wireless LAN (MF249dw / MF237w)(P. 319)**
- ▶ **Connecting to a Wired LAN(P. 318)**
- A port that is used for Cloud Print may be blocked by a firewall or other protection. Check whether the 5222 port is available with your computer.
- If a proxy server is used on the network, check whether the proxy settings on the machine and the server are correct. For details, contact your Network Administrator.
- ▶ **Setting a Proxy (MF249dw / MF246dn / MF237w)(P. 411)**

Cart. Communication Error A counterfeit or non-Canon cartridge may be in use.

Toner cartridge is not installed correctly, or there is possible trouble on the toner cartridge.

- Reinstall the toner cartridge. If this message does not disappear after reinstalling several times, the toner cartridge might be possibly broken. Contact the shop where you purchased the machine, or the Canon Customer Care Center.

▶ **How to Replace Toner Cartridges(P. 602)**

You might not be using a Canon genuine toner cartridge.

- We recommend Canon genuine toner cartridges as replacement toner cartridges.
- ▶ **Consumables(P. 655)**

Cartridge has reached end of lifetime. Rplcmt. recommended.

The toner cartridge has reached the end of its lifetime.

- Replacement of the toner cartridge is recommended.
- ▶ **How to Replace Toner Cartridges(P. 602)**

Check the authentication settings.

The authentication method set on the machine does not match the authentication method set on the RADIUS server.

- Check that the same authentication method is set on this machine and the RADIUS server, and set the correct authentication method.
- ▶ **Configuring IEEE 802.1X Authentication(P. 429)**

Could not connect. Check the PSK settings.

The network key (PSK) of a wireless router to be connected is not set to the machine correctly.

- Check the network key (PSK) of the wireless router, and set it to the machine again.
- ▶ **Checking the SSID and Network Key(P. 333)**
- ▶ **Setting Up Connection by Selecting a Wireless Router(P. 326)**
- ▶ **Setting Up Connection by Specifying Detailed Settings(P. 329)**
- If the problem persists even after checking the network key, check whether the machine is properly installed and ready to connect to the network.
- ▶ **Installation/Settings Problems(P. 565)**

Could not connect using Access Point Mode.

Connection in Access Point Mode failed due to an error.

- Wait a few moments and try again. If you still cannot connect, try switching the machine off briefly.
- ▶ **Make Direct Connection (Access Point Mode) (MF249dw / MF237w)(P. 291)**

Could not connect using the wireless LAN. Turn the main power OFF and ON, then configure the settings again.

A connection failed due to an error while setting wireless LAN connection.

- Restart the machine and set again.
- If the problem persists even after restarting the machine, check whether the machine is properly installed and ready to connect to the network.
- ▶ **Installation/Settings Problems(P. 565)**
- If the problem persists even after checking the wireless LAN connection, check the security settings of the wireless router.

Could not connect using WPS. Wait a moment, then configure the settings again.

When automatic setting with WPS was attempted, the connection failed due to an error.

- Wait for a while, and set again. If the problem persists, check whether the wireless router supports WPS.

If WPS is supported:

Check whether the machine is properly installed and ready to connect to the network.

▶ **Installation/Settings Problems(P. 565)**

If WPS is not supported:

Set using another connecting method.

▶ **Connecting to a Wireless LAN (MF249dw / MF237w)(P. 319)**

Could not detect any connections from wireless devices.

It was not possible to detect any mobile device within the predetermined length of time.

- Connect again paying attention to the time limit.
- ▶ **Using the Machine in Direct Connection (in Access Point Mode)(P. 291)**

Could not perform cleaning.

Paper jammed during cleaning.

- Remove the jammed paper, set paper correctly, and perform cleaning again.
- ▶ **Paper Jams inside the Machine(P. 543)**
- ▶ **Fixing Assembly(P. 594)**

Could not perform Shared Key authentication. Check the WEP settings.

The network key (the WEP key) of a wireless router to be connected is not set to the machine correctly.

- Check the network key (the WEP key) of the wireless router, and set it to the machine again.
- ▶ **Checking the SSID and Network Key(P. 333)**
- ▶ **Setting Up Connection by Specifying Detailed Settings(P. 329)**
- Connect again by selecting a wireless router or by manually changing the WEP authentication method to <Open System>.
- ▶ **Setting Up Connection by Selecting a Wireless Router(P. 326)**
- ▶ **Setting Up Connection by Specifying Detailed Settings(P. 329)**

The authentication method of the machine is set to <Shared Key>, but that of the wireless router is set to "Open System."

- Change the WEP authentication method to "Shared Key" at the wireless router, and connect again. For more information about how to change, see the instruction manuals for your networking devices or contact your manufacturer.

Direct Connection terminated.

Connection between the machine and the mobile device was terminated.

- Reestablish Direct Connection.
- ▶ **Using the Machine in Direct Connection (in Access Point Mode)(P. 291)**

Insert the toner cartridge.

The toner cartridge is not set or properly set.

- Properly set the toner cartridge.
- ▶ **How to Replace Toner Cartridges(P. 602)**

Maximum number of wireless devices connected using Direct Connection has been reached. To connect other devices, terminate some of the current connections.

The number of directly connected mobile devices is at a maximum.

- To connect other devices by Direct Connection, disconnect current device(s) and try connecting again.
- ▶ **Using the Machine in Direct Connection (in Access Point Mode)(P. 291)**

No Paper: XXXX*

* <Drawer 1> or <MP Tray> is displayed for XXXX.

Paper is not loaded in the paper drawer or the manual feed slot.

- Load the paper.
- ▶ **Loading Paper(P. 45)**

Paper on which reports or lists can be printed is not loaded.

- Reports or lists can be printed on A4 or Letter size paper. Load A4 or Letter size paper and set its size.
- ▶ **Loading Paper(P. 45)**
- ▶ **Specifying Paper Size and Type(P. 56)**

Paper on which received documents can be printed is not loaded.

- Received documents can be printed on A4 or Letter size paper. Load A4 or Letter size paper and set its size. Also, set the paper type to <Plain (60-89 g/m²)>, <Plain L (60-89 g/m²)>, <Recycled (60-89 g/m²)>, or <Color (60-89 g/m²)> depending on the loaded paper.
- ▶ **Loading Paper(P. 45)**
- ▶ **Specifying Paper Size and Type(P. 56)**

NOTE:

If you print received documents on paper other than A4 or Letter size, some portions of the image may be missing or the image may be divided and printed onto several sheets.

No reply from the destination.

A network cable may be disconnected, or there may be a problem in a switch.

- Check the status of the network cables and switches.

No response from the host.

The machine is not connected to a network correctly.

- Check the machine and network settings, and connect again.
- ▶ **Connecting to a Network(P. 315)**

Paper jammed.

Paper jams.

- Remove the jammed paper or document, and print again (Printing may resume automatically).
- ▶ **Clearing Jams(P. 540)**

Prepare a cartridge.

The toner cartridge needs to be replaced soon.

- Shake the toner cartridge to evenly distribute the toner inside the toner cartridge. It is recommended to replace the toner cartridge when printing a large volume of documents.
- ▶ **Before Replacing the Toner Cartridge(P. 600)**
- ▶ **Replacing Toner Cartridges(P. 597)**

Set the correct authentication information.

The client authentication information (key pair and certificate, user name and password, or CA certificate) is not set correctly.

- Check the specified authentication method and authentication information (key pair and certificate, user name and password, and CA certificate).
- ▶ **Configuring IEEE 802.1X Authentication(P. 429)**
- ▶ **Verifying Key Pairs and Digital Certificates(P. 446)**

Size/Settings Mismatch

The paper size setting on the operation panel does not match the loaded paper size.

- Match the paper size setting specified in <Paper Settings> and the size of the paper that is actually loaded.

To use the loaded paper

Change the setting of <Paper Settings> to match the loaded paper size.

▶ **Specifying Paper Size and Type(P. 56)**

NOTE:

If printing from a computer, check whether the paper size setting in the printer driver matches the loaded paper size.

To load paper without changing the settings

Load the paper with the size that is set to <Paper Settings>.

▶ **Loading Paper(P. 45)**

Specifying and registering new destinations is restricted.

Only destinations that are registered in the Address Book can be specified to send a fax or e-mail.

- To enter a new destination with the operation panel, or add or edit it in the Address Book, you need to set <Restrict New Destinations> to <Off>. For more information, contact your Administrator.

▶ **Limiting Available Destinations(P. 417)**

The amount in the cartridge cannot be displayed correctly.

Toner cartridge is not installed correctly, or there is possible trouble on the toner cartridge.

- Reinstall the toner cartridge. If this message does not disappear after reinstalling several times, the toner cartridge might be possibly broken. Contact the shop where you purchased the machine, or the Canon Customer Care Center.

▶ **How to Replace Toner Cartridges(P. 602)**

You might not be using a Canon genuine toner cartridge.

- We recommend Canon genuine toner cartridges as replacement toner cartridges.

▶ **Consumables(P. 655)**

The connection with the PC has been lost. Check the connection.

The connection to the computer was lost during a scan.

- Check the connection between the machine and the computer.

▶ **Preparing to Use the Machine as a Scanner (MF249dw / MF246dn / MF237w)(P. 233)**

The memory is full.

A fax could not be sent or received, or a document could not be scanned due to insufficient memory space.

- If a sending or printing job is queued, wait until the job is completed.
- If a received document is stored to memory, print or delete it.

▶ **Storing Received Faxes into Memory (Memory Reception)(P. 150)**

- If sending a document with many pages, divide it into multiple sections.

- If sending a fax, reduce the resolution to scan the document.
- ▶ **Adjusting Resolution(P. 134)**
- If scanning, change the file format to reduce its file size.
- ▶ **Selecting a File Format(P. 262)**

The memory is full. Scanning will be canceled. Do you want to print?

A document could not be scanned due to insufficient memory space.

- Select whether to print up to the scanned pages or to cancel the scanning. If you cancel, divide the document into multiple sections and scan them, or change the scanning settings.

The number of entered characters is incorrect or invalid characters are used.

The network key (the WPA/WPA2-PSK or WEP key) of a wireless router is not entered correctly.

- Check the network key (the WPA/WPA2-PSK or WEP key) of the wireless router, and set it to the machine again. For more information about how to check the network key, see the instruction manuals for your networking devices or contact your manufacturer.
- ▶ **Checking the SSID and Network Key(P. 333)**
- ▶ **Setting Up Connection by Selecting a Wireless Router(P. 326)**
- ▶ **Setting Up Connection by Specifying Detailed Settings(P. 329)**

The WEP key is not set correctly. Check the WEP settings.

The network key (the WEP key) of a wireless router to be connected is not set to the machine correctly.

- Check the network key (the WEP key) of the wireless router, and set it to the machine again.
- ▶ **Checking the SSID and Network Key(P. 333)**
- ▶ **Setting Up Connection by Selecting a Wireless Router(P. 326)**
- ▶ **Setting Up Connection by Specifying Detailed Settings(P. 329)**

The authentication method of the machine is set to <Shared Key>, but that of the wireless router is set to "Open System."

- Connect again by selecting a wireless router or by manually changing the WEP authentication method to <Open System>.
- ▶ **Setting Up Connection by Selecting a Wireless Router(P. 326)**
- ▶ **Setting Up Connection by Specifying Detailed Settings(P. 329)**
- Change the WEP authentication method to "Shared Key" at the wireless router, and connect again. For more information about how to change, see the instruction manuals for your networking devices or contact your manufacturer.

Use Remote UI to set the information necessary for authentication.

The IEEE 802.1X settings are incorrect.

- Check whether [Login Name] is set correctly.

- Check whether the [Use TLS], [Use TTLS], or [Use PEAP] check box is selected.
- If using TLS, check whether a key pair is registered.
- If using TTLS or PEAP, check whether a user name and password are set correctly.
- **▶ Configuring IEEE 802.1X Authentication(P. 429)**

When an Error Code Appears

14L7-09C

If printing is not successful or you cannot send or receive a fax or scanned document, or another error occurs, that error appears on a report or a message on the <Status Monitor> screen as a three-digit number (error code). Check the following to find out causes and solutions for each error code. For how to print an error report and information in the report, see **▶Printing Reports and Lists(P. 607)** .

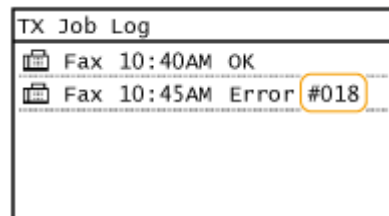
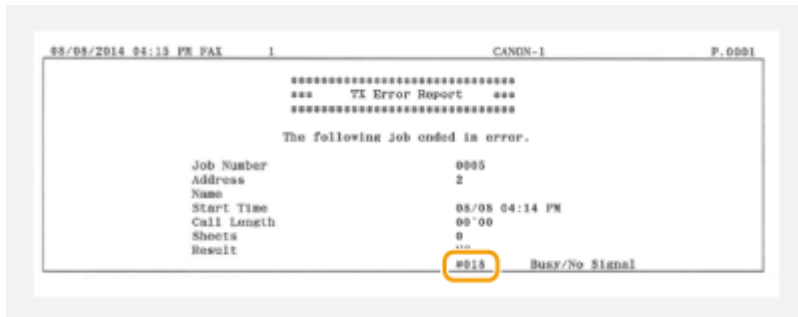

#001

A document jams in the feeder.

- Remove the jammed document.
- ▶ **Clearing Jams(P. 540)**

#003

A fax could not be sent or received due to its large data size.

- When sending a fax: Reduce the resolution, and scan the document.
- ▶ **Adjusting Resolution(P. 134)**
- When receiving a fax: Ask the sender to divide the document into multiple sections or reduce the resolution before sending.

#005

A fax could not be sent because the recipient's machine did not respond within 35 seconds.

- When the recipient's machine is turned OFF or the line is busy, a fax may not be sent. Ask the recipient to check the machine status. When sending the fax overseas, insert pauses in the fax number.
- ▶ **Sending Faxes(P. 114)**

#012

A fax could not be sent because the recipient's machine ran out of paper.

- Ask the recipient to reload the paper.

#018

A fax could not be sent since the recipient's machine did not respond because the line was busy or for other reasons.

- When the recipient's machine is turned OFF or the line is busy, a fax may not be sent. Ask the recipient to check the machine status. When sending the fax overseas, insert pauses in the fax number.
- ▶ **Sending Faxes(P. 114)**

#022

Sending of a fax from a computer is disabled.

- To send a fax from a computer, you need to set <Allow Fax Driver TX> to <On>. For more information, contact your Administrator.
- ▶ **Prohibiting PC Faxing(P. 418)**

A fax could not be forwarded because the specified destination was deleted from the Address Book.

- Register the forwarding destination again. If the documents that failed to be forwarded remain in memory, you can forward it again.
- ▶ **Registering in the Address Book(P. 60)**
- ▶ **Printing/Resending/Deleting Documents that Failed to be Forwarded(P. 158)**

#037

Memory is full.

- If a sending or printing job is queued, wait until the job is completed.
- If a received document is stored to memory, print or delete it.
- ▶ **Storing Received Faxes into Memory (Memory Reception)(P. 150)**
- If sending a document with many pages, divide it into multiple sections.
- If sending a fax, reduce the resolution to scan the document.
- ▶ **Adjusting Resolution(P. 134)**

#099

Printing, sending, or receiving was canceled.

- When you cancel an operation, this error code is displayed, but this is not abnormal. Print, send, or receive documents again as necessary.

#752

E-mail sending was impossible because an incorrect SMTP server name was set.

- Check the SMTP server name, and correct the setting.

- ▶ **Configuring Basic E-Mail Settings(P. 359)**
- ▶ **Configuring E-Mail Communication Settings(P. 363)**

E-mail sending was impossible because an incorrect domain name was set.

- Check the domain name, and correct the setting.
- ▶ **Configuring DNS(P. 377)**

E-mail sending was impossible because the machine was not connected to a network correctly.

- Check whether the machine is properly installed and correctly connected to the network.
- ▶ **Installation/Settings Problems(P. 565)**

#753

Scanned data could not be sent as e-mail or stored in the shared folder because the LAN cable is disconnected.

- Check whether the LAN cable is connected correctly.
- ▶ **Connecting to a Wired LAN(P. 318)**

#755

Scanned data could not be sent as e-mail or stored in the shared folder because TCP/IP was not working correctly.

- Check <TCP/IP Settings>, and set correctly.
- ▶ **Network Settings (MF249dw / MF246dn / MF237w)(P. 473)**

An IP address is not set.

- Set the IP address correctly.
- ▶ **Setting IP Addresses(P. 336)**

The machine cannot communicate with devices on a network immediately after the machine starts up because the waiting time for the start of the communication is set.

- The machine cannot start communicating immediately after it is turned ON. Wait until the set time for <Waiting Time for Connection at Startup> passes after turning ON the machine, and send again.
- ▶ **Setting a Wait Time for Connecting to a Network(P. 376)**

#801

When communicating with an SMTP server to send an e-mail, a timeout error occurred from the server.

- Check whether SMTP is running on the network correctly.
- Check whether the machine is properly installed and correctly connected to the network.
- ▶ **Installation/Settings Problems(P. 565)**

When communicating with the SMTP server, an error returned from the server.

- Check whether the SMTP server is set correctly.

A destination is not set correctly.

- Check whether the destination is set correctly.

When storing a scanned document into the shared folder, an error occurred from the folder.

- Check whether the shared folder and the computer that has the shared folder are running correctly.

The incorrect folder name or password was specified when storing to the shared folder.

- Check the destination settings.

#802

The SMTP/POP3 server name is not set correctly.

- Set the SMTP/POP3 server name correctly.
- ▶ **Configuring Basic E-Mail Settings(P. 359)**
- ▶ **Configuring E-Mail Communication Settings(P. 363)**

#804

No access privileges to access the shared folder are granted.

- Grant the sending user (user name registered to the destination) a privilege for writing to the save location folder. For details, contact your network administrator.

The incorrect folder name was specified when storing to the shared folder.

- Check the destination settings.

#806

When storing data to a shared folder, an incorrect user name or password was specified.

- The same user name and password as those registered in a shared folder must be registered in the Address Book.
- ▶ **Setting a Shared Folder as a Save Location(P. 368)**
- ▶ **Registering Address Book from Remote UI(P. 467)**

When sending an e-mail, an incorrect destination was specified.

- Enter the correct e-mail address, and send the message again. If the destination that was registered in the Address Book was used, check whether the e-mail address is correct.
- ▶ **Registering in the Address Book(P. 60)**

#810

When communicating with the POP3 server to send e-mail, an error returned from the server.

- Check whether the POP3 server is set correctly.
- Check whether your mail server and network are running correctly. For more information, contact your Network Administrator.

#813

The logon name or password that is used on the POP3 server is not set correctly.

- Correctly enter the logon name or password that is used on the POP3 server.

#839

A user name and password that are used for SMTP authentication are not set correctly.

- Set the user name and password correctly.
- ▶ **Configuring Basic E-Mail Settings(P. 359)**
- ▶ **Configuring E-Mail Communication Settings(P. 363)**

#841

When sending an e-mail, an encryption algorithm that is common to the mail server is not present.

- Clear the [Use TLS for SMTP] check box for the SMTP server.
- ▶ **Configuring E-Mail Communication Settings(P. 363)**
- Add the common encryption algorithm to the mail server settings.

When verifying a TLS server certificate to communicate to the SMTP server, a verification error occurred.

- Check that the CA certificate that signed the TLS server certificate on the SMTP server side is registered to the machine by using the Remote UI.
- ▶ **Verifying Key Pairs and Digital Certificates(P. 446)**
- Check that the TLS server certificate on the SMTP server side is valid.
- Check that the TLS server certificate is not a self-signed certificate.

#844

TLS encrypted communication to a POP3 server failed when sending an e-mail with POP before SMTP.

- Check the TLS encrypted communication settings in the POP3 server.
- Clear the [Use TLS for POP] check box for the POP3 server. If the problem persists, clear the [Use POP Authentication Before Sending] check box, and set the communication setting to a setting other than POP before SMTP.
- ▶ **Configuring E-Mail Communication Settings(P. 363)**

When verifying a TLS server certificate to communicate to the POP3 server, a verification error occurred.

- Check that the CA certificate that signed the TLS server certificate on the POP3 server side is registered to the machine by using the Remote UI.
- ▶ **Verifying Key Pairs and Digital Certificates(P. 446)**
- Check that the TLS server certificate on the POP3 server side is valid.
- Check that the TLS server certificate is not a self-signed certificate.

#846

An e-mail could not be sent due to a POP authentication failure.

- Check the setting, and try again.
- **▶ Configuring E-Mail Communication Settings(P. 363)**

#852

The machine turns OFF for some reason.

- Check whether the power plug is inserted into an outlet firmly.

#995

A document waiting to be sent was canceled.

- Send the document again as necessary.

Common Problems

14L7-09E

If you encounter problems when using the machine, check the items in this section before contacting us. If the problems persist, contact your local authorized Canon dealer or the Canon help line.

Check the Following

→ Is the machine turned ON? Is the power cord connected?

- If the machine is turned ON but does not respond, turn it OFF, check whether the power cord is connected correctly, and turn it back ON. For information on connecting the power cord, see Getting Started.
 - ▶ **Manuals Included with the Machine(P. 656)**

→ Are the phone cord, LAN cable and USB cable connected correctly?

- Check whether these cables are connected correctly. Use care not to mistake the phone cord's port for the other cables' ports.
 - ▶ **Connecting the Telephone Line(P. 112)**
 - ▶ **Parts and Their Functions(P. 17)**

→ Is sleep mode activated?

- If you leave the machine unattended for a specific period of time, it enters sleep mode for power conservation, not allowing you to operate it.
To cancel sleep mode, press .

→ Is any message displayed on the screen?

- If a problem occurs, a message is displayed.
 - ▶ **When an Error Message Appears(P. 548)**

If a Problem Persists Even after Checking

Click the link that corresponds to the problem.

- ▶ **Installation/Settings Problems(P. 565)**
- ▶ **Copy/Printing Problems(P. 569)**
- ▶ **Faxing/Telephone Problems(P. 572)**

Installation/Settings Problems

14L7-09F

See [▶Common Problems\(P. 564\)](#) also.

- ▶[Problems with the Wireless/Wired LAN Connection \(MF249dw / MF246dn / MF237w\)\(P. 565\)](#)
- ▶[Problem with the USB Connection\(P. 568\)](#)
- ▶[Problem with the Print Server \(MF249dw / MF246dn / MF237w\)\(P. 568\)](#)

Problems with the Wireless/Wired LAN Connection (MF249dw / MF246dn / MF237w)

The wireless LAN and wired LAN cannot be connected at the same time.

- The wireless LAN and wired LAN cannot be connected at the same time. The following can be used at the same time: a USB cable and a wireless LAN, or a USB cable and a wired LAN.

Remote UI is not displayed.

- Are <Use HTTP> and <Use Remote UI> set to <On>?
 - ▶[Disabling HTTP Communication \(MF249dw / MF246dn / MF237w\)\(P. 423\)](#)
 - ▶[Disabling Remote UI \(MF249dw / MF246dn / MF237w\)\(P. 424\)](#)
- If the machine is connected to a wireless LAN, check that the Wi-Fi indicator is lit and the IP address is set correctly, and then start the Remote UI again.
 - ▶[Operation Panel\(P. 25\)](#)
 - ▶[Viewing Network Settings\(P. 344\)](#)
- If the machine is connected to a wired LAN, check that the cable is connected firmly and the IP address is set correctly, and then start the Remote UI again.
 - ▶[Connecting to a Wired LAN\(P. 318\)](#)
 - ▶[Viewing Network Settings\(P. 344\)](#)
- Are you using a proxy server? If so, add the machine's IP address to the [Exceptions] list (addresses that do not use the proxy server) in the Web browser's proxy settings dialog.
- Is communication not limited by the firewall on your computer? If IP addresses are or an MAC address is incorrectly entered, the Remote UI cannot be displayed. In that case, you need to use the operation panel to set <IPv4 Address Filter>, <IPv6 Address Filter>, or <MAC Address Filter> to <Off>.
 - ▶[Restricting Communication by Using Firewalls \(MF249dw / MF246dn / MF237w\)\(P. 401\)](#)
 - ▶[IPv4 Address Filter \(P. 529\)](#)
 - ▶[IPv6 Address Filter \(P. 530\)](#)
 - ▶[MAC Address Filter \(P. 530\)](#)

A connection to a network cannot be established.

- The IP address may not be set correctly. Set the IP address again.
 - ▶[Setting IP Addresses\(P. 336\)](#)
- When you connect the machine to a computer via wireless LAN, check whether the machine is properly installed and ready to connect to the network.
 - ▶[When the Machine Cannot Connect to the Wireless LAN \(MF249dw / MF237w\)\(P. 566\)](#)

You are unsure of the set IP address. ▶ Viewing Network Settings(P. 344)

The connection method cannot be switched between a wired LAN and a wireless LAN.

- Did you select a wired LAN or a wireless LAN on the operation panel on the machine as well? This selection is required to have the machine switch to your selection.
▶ **Selecting Wired LAN or Wireless LAN (MF249dw / MF237w)(P. 317)**

You are unsure of the SSID or the network key of the wireless router to be connected. The SSID is not displayed on the screen.

- Check whether the SSID can be found on the wireless router or package box.
- Check the SSID or the network key of the wireless router by using Canon MF/LBP Wireless Setup Assistant.
▶ **Checking the SSID and Network Key(P. 333)**

The SSID of the wireless router to be connected is not displayed in the access point list.

- Check whether the SSID is correct.
▶ **Checking the SSID and Network Key(P. 333)**
- If the SSID of the wireless router is hidden (using a stealth mode*), set the SSID to be visible on the wireless router.

* A mode that disables the SSID auto-detection of other devices.

- Check whether the machine is properly installed and ready to connect to the network.
▶ **When the Machine Cannot Connect to the Wireless LAN (MF249dw / MF237w)(P. 566)**

The machine dials up to an unintended connection destination (if a dialup router is connected to a network).

- If a dialup router does not need to pass broadcast packets, set the dialup router so that the broadcast packets will not pass. If the dialup router needs to pass broadcast packets, check whether the settings are correct.
- If a DNS server is located in an external network, set the IP address to be connected, not the host name, even if connecting to the devices that are on the network that is connected to the machine.
- If a DNS server is located on a network that is connected to the machine and the information about the devices that are connected to an external network is registered to the DNS server, check whether the settings are correct.

When the Machine Cannot Connect to the Wireless LAN MF249dw / MF237w



1 Check the status of your computer.

- Have the settings of the computer and the wireless router been completed?
- Are the cables of the wireless router (including the power cord and LAN cable) correctly plugged in?
- Is the wireless router turned on?

If the problem persists even after checking the above:

- Turn off the devices, and then turn them on again.
- Wait for a while, and try again to connect to the network.



Check whether the machine is turned ON.

- If the machine is turned ON, turn it OFF, and then turn it back ON.



Check the installation site of the machine and the wireless router.

- Is the machine too far from the wireless router?
- Are there any obstacles such as walls between the machine and the wireless router?
- Are there any appliances such as microwave ovens or digital cordless phones that emit radio waves near the machine?

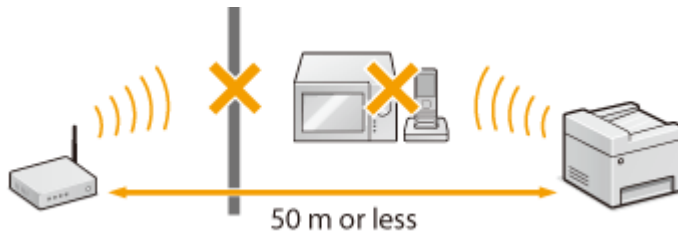

Perform one of the following settings again.

- ▶ **Setting Up Connection Using WPS Push Button Mode(P. 321)**
- ▶ **Setting Up Connection Using WPS PIN Code Mode(P. 323)**
- ▶ **Setting Up Connection by Selecting a Wireless Router(P. 326)**
- ▶ **Setting Up Connection by Specifying Detailed Settings(P. 329)**

NOTE

When you need to manually set up the connection

If the wireless router is set as described below, manually enter all the required information for the wireless LAN connection (▶ **Setting Up Connection by Specifying Detailed Settings(P. 329)**).

- ANY connection refusal* is activated.
- The WEP key that was automatically generated (hexadecimal) is selected.
- The stealth mode is activated.

* A function in which the wireless router refuses the connection if the SSID on the device to be connected is set to "ANY" or is blank.

When you need to change the settings of the wireless router

If the wireless router is set as described below, change the settings of the router.

- The MAC address packet filtering is set.

- When only IEEE 802.11n is used for the wireless communication, WEP is selected or the WPA/WPA2 encryption method is set to TKIP.

Problem with the USB Connection

Cannot communicate.

- Change the USB cable. If you are using a long USB cable, replace it with a short one.
- If you are using a USB hub, connect the machine directly to your computer using a USB cable.

Problem with the Print Server (MF249dw / MF246dn / MF237w)

You cannot find the print server to connect to.

- Are the print server and computer connected correctly?
- Is the print server running?
- Do you have user rights to connect to the print server? If you are not sure, contact the server administrator.
- Is [Network discovery] enabled? (Windows Vista/7/8/10/Server 2008/Server 2012)
 ▶ **Enabling [Network discovery](P. 664)**

You cannot connect to a shared printer.

- On the network, does the machine appear among the printers of the print server? If it is not displayed, contact the network or server administrator.
 ▶ **Displaying Shared Printers in the Print Server(P. 665)**

Copy/Printing Problems

14L7-09H

See [▶Common Problems\(P. 564\)](#) also.

Printing/copy results are not satisfactory. Paper creases or curls. [▶When You Cannot Print Properly\(P. 574\)](#)

You cannot print.

- Can you print a Windows test page? If you can print a Windows test page, there is no problem with the machine or the printer driver. Check the print settings of your application.

[▶Printing a Test Page in Windows\(P. 666\)](#)

If you cannot print a test page, check the following according to your environment.

■ Wireless LAN connection (MF249dw / MF237w)

- Check the connection status (signal strength) of the wireless LAN.

[▶Viewing Network Settings\(P. 344\)](#)

NOTE:

If the connection is poor, try the following.

- Change the channel of your wireless LAN router. If you have more than one router, set the channels to be at least five channels apart.
- If you can change the radio output power of your wireless LAN router, raise the output power.
- If your computer is connected to a wireless LAN, are the computer and this machine using the same wireless LAN router SSID? If they are different, reset the wireless LAN connection settings of this machine.

[▶Viewing Network Settings\(P. 344\)](#)

[▶Checking the SSID to Which Your Computer Is Connected\(P. 671\)](#)

[▶Connecting to a Wireless LAN \(MF249dw / MF237w\)\(P. 319\)](#)

NOTE:

When you reset wireless LAN connection settings

- As the wireless LAN router, select the one with the SSID to which the computer is connected.
- Have you selected the correct port? If there is no port to use, create a port.
 - [▶Checking the Printer Port\(P. 669\)](#)
 - [▶Configuring Printer Ports\(P. 351\)](#)
- Is communication not limited by the firewall on your computer? If IP addresses are incorrectly entered, you will be not able to access the machine. In that case, you need to use the operation panel to set <IPv4 Address Filter> or <IPv6 Address Filter> to <Off>.
 - [▶Restricting Communication by Using Firewalls \(MF249dw / MF246dn / MF237w\)\(P. 401\)](#)
 - [▶IPv4 Address Filter \(P. 529\)](#)
 - [▶IPv6 Address Filter \(P. 530\)](#)
- Disable security software and other resident software.
- Reinstall the printer driver in accordance with the MF Driver Installation Guide.
- Can you print from other computers on the network? If you also cannot print from other computers, contact your local authorized Canon dealer or the Canon help line.

■ Wired LAN connection (MF249dw / MF246dn / MF237w)

- Have you selected the correct port? If there is no port to use, create a port.
 - ▶ **Checking the Printer Port(P. 669)**
 - ▶ **Configuring Printer Ports(P. 351)**
- Is communication not limited by the firewall on your computer? If IP addresses are or an MAC address is incorrectly entered, you will be not able to access the machine. In that case, you need to use the operation panel to set <IPv4 Address Filter>, <IPv6 Address Filter>, or <MAC Address Filter> to <Off>.
 - ▶ **Restricting Communication by Using Firewalls (MF249dw / MF246dn / MF237w)(P. 401)**
 - ▶ **IPv4 Address Filter (P. 529)**
 - ▶ **IPv6 Address Filter (P. 530)**
 - ▶ **MAC Address Filter (P. 530)**
- Disable security software and other resident software.
- Reinstall the printer driver in accordance with the MF Driver Installation Guide.
- Can you print from other computers on the network? If you also cannot print from other computers, contact your local authorized Canon dealer or the Canon help line.

■ **USB connection**

- Have you selected the correct port? If there is no port to use or you are not sure, reinstall the printer driver in accordance with the MF Driver Installation Guide. When you reinstall the printer driver, the correct port is created automatically.
 - ▶ **Checking the Printer Port(P. 669)**
- Is bidirectional communication enabled? Enable bidirectional communication, and restart the computer.
 - ▶ **Checking Bidirectional Communication(P. 670)**
- Disable security software and other resident software.
- Connect to another USB port on the computer.
- Can you print from a USB connection to another computer? If you also cannot print from other computers, contact your local authorized Canon dealer or the Canon help line.

■ **Via print server (MF249dw / MF246dn / MF237w)**

- Can you print from the print server? If you can print from the print server, check the connection between the print server and your computer.
 - ▶ **Problem with the Print Server (MF249dw / MF246dn / MF237w)(P. 568)**
- Disable security software and other resident software.
- Reinstall the printer driver in accordance with the MF Driver Installation Guide.
- Can you print from other computers via the print server? If you also cannot print from other computers, contact your local authorized Canon dealer or the Canon help line.

Printing seems to be slow. *

- Print or delete data in memory.
 - ▶ **Printing Documents in Memory(P. 151)**
 - ▶ **Checking/Deleting Documents in Memory(P. 151)**

* When the free space in memory is running low, the processing speed of the machine becomes slow, just as a computer does. There is nothing abnormal.

You cannot print with Google Cloud Print. ▶ Using Google Cloud Print(P. 308)

It takes a long time before printing starts.

- Did you print to narrow width paper? After you print to narrow width paper, the machine may cool itself to maintain the print quality. As a result, it may take some time before the next job is printed. Wait until the machine is ready to print. Printing will resume when the temperature inside the machine has fallen.

A blank sheet is output (nothing is printed).

- Did you pull the sealing tape out when loading the toner cartridge? If you did not pull it out, remove the toner cartridge, pull the sealing tape out, and reload the toner cartridge.
▶ **How to Replace Toner Cartridges(P. 602)**

Faxing/Telephone Problems

14L7-09J

See **Common Problems(P. 564)** also.

Sending Problems(P. 572)

Receiving Problems(P. 573)

Sending Problems

A fax cannot be sent.

- Is an external phone line busy? Wait until the line becomes free.
- Has an error occurred? Print and check a Communication Management Report.
Communication Management Report(P. 611)
- Is a telephone line set correctly?
Connecting the Telephone Line(P. 112)
- When sending the fax overseas, insert pauses in the fax number.
Sending Faxes(P. 114)

A fax cannot be sent with a destination in the history specified.

- Did you turn OFF the machine? If so, the stored history was deleted.
- Did you set <Restrict New Destinations> to <On>? If so, the history before you set was deleted.
- Did you set <Restrict Resending from Log> to <On>? If so, the destinations in the history cannot be specified.

A fax cannot be sent on an optical fiber line.

- The machine is compliant with use on analog lines. When using an optical fiber line or IP phone line, the machine may not work correctly depending on the connection environment or connected devices. In such a case, contact the provider of the optical fiber line or IP phone.



The results of a sent fax are not satisfactory.

- Clean the platen glass or feeder. If cleaning does not improve the results, the recipient's fax machine may be a cause.
Platen Glass(P. 590)
Feeder(P. 593)



Receiving Problems

The results of received fax are not satisfactory. Paper creases or curls. When You Cannot Print Properly(P. 574)

Telephone and fax cannot be switched automatically.

- Check that the receive mode is set to <Fax/Tel (Auto Switch)>, <Answering Machine>, or <Net Switch>.
 -  **Selecting the Receive Mode(P. 110)**
- Free space in memory may be running low. Print or delete data in memory.
 -  **Checking/Deleting Documents in Memory(P. 151)**
 -  **Printing Documents in Memory(P. 151)**

A fax cannot be received automatically.

- Check that the receive mode is set to <Fax/Tel (Auto Switch)>, <Auto>, <Answering Machine>, or <Net Switch>.
 -  **Selecting the Receive Mode(P. 110)**
- Free space in memory may be running low. Print or delete data in memory.
 -  **Checking/Deleting Documents in Memory(P. 151)**
 -  **Printing Documents in Memory(P. 151)**

A fax cannot be received on an optical fiber line.

- The machine is compliant with use on analog lines. When using an optical fiber line or IP phone line, the machine may not work correctly depending on the connection environment or connected devices. In such a case, contact the provider of the optical fiber line or IP phone.

When You Cannot Print Properly

14L7-09K

If printing results are not satisfactory, or paper creases or curls, try the following solutions. If the problems persist, contact your local authorized Canon dealer or the Canon help line.



▶ Smudge Marks Appear on the Edge of Printouts(P. 576)



▶ Streaks Appear on Printouts(P. 576)



▶ White Streaks Appear(P. 577)



▶ Toner Smudges and Splatters Appear(P. 577)

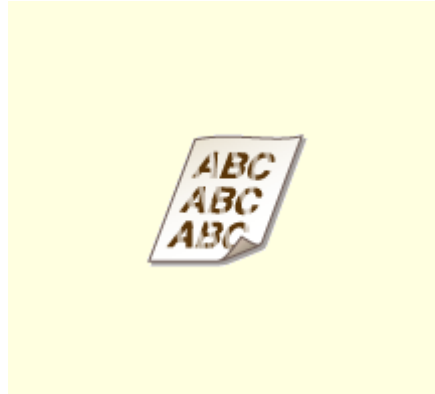

▶ Printouts Are Faded(P. 578)



▶ Printed Pages Have White Specks(P. 578)



▶ A Portion of the Page Is Not Printed(P. 579)



▶ Print Density Is Uneven(P. 579)

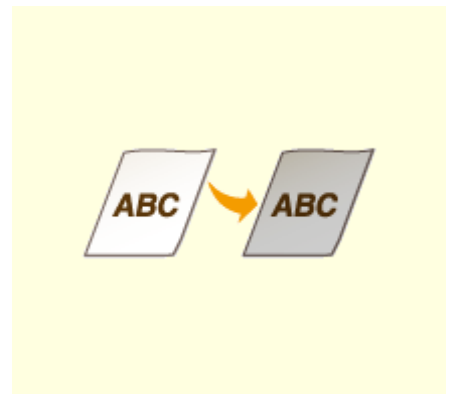

▶ Printouts Are Grayish(P. 580)



▶ Cannot Scan a Printed Barcode(P. 580)



▶ Paper Creases(P. 581)



▶ Paper Curls(P. 581)



▶ Printouts Are Skewed(P. 583)



▶ Paper Is Not Fed/Two or More Sheets Are Fed Together(P. 583)



▶ Paper Jams Frequently with 2-Sided Printing (MF249dw / MF246dn)(P. 584)

Printing Results Are Not Satisfactory

14L7-09L

Dirt inside the machine may affect printing results. Perform care and cleaning to the machine first.

▶ **Cleaning the Machine(P. 588)**

Smudge Marks Appear on the Edge of Printouts

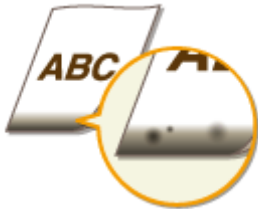

→ Do you print data without margins?

- This symptom occurs if a margin is set to none in the printer driver. A margin of 5 mm or less around the edge of paper or 10 mm or less around the edge of envelopes is not printable with the machine. Make sure to have margins around the document to print.

[Finishing] tab ▶ [Advanced Settings] ▶ [Expand Print Region and Print] ▶ [Off]

Streaks Appear on Printouts



→ Are you using appropriate paper?

- Check usable paper, and replace with appropriate paper.
- ▶ **Paper(P. 647)**
- ▶ **Loading Paper(P. 45)**
- If using the appropriate paper still does not solve the problem, change one of the <Special Printing Mode Z>, <Special Printing Mode C>, and <Special Printing Mode D> settings.
- ▶ **Special Processing (P. 523)**
- To print from a computer, change the setting for [Special Print Adjustment] in the printer driver.

NOTE:

[Mode 1] has the least effect while [Mode 4] has the most effect. Try each in order starting with [Mode 1]. Increasing the effect makes the print density lighter. Outlines may also be blurred or images may appear somewhat grainy.

→ **Did you just replace the toner cartridge? Have you not used the printer for a long period of time?**

- Change the setting for <Special Printing Mode B>.
- ▶ **Special Processing (P. 523)**

White Streaks Appear



→ **Is the platen glass dirty?**

- Clean the platen glass and the underside of the feeder.
- ▶ **Platen Glass(P. 590)**

→ **Is the amount remaining in the toner cartridge nearly empty?**

- Check the amount remaining in the toner cartridge, and replace the toner cartridges as necessary.
- ▶ **Replacing Toner Cartridges(P. 597)**

Toner Smudges and Splatters Appear



→ **Are you using appropriate paper?**

- Check usable paper, and replace with appropriate paper.
- ▶ **Paper(P. 647)**
- ▶ **Loading Paper(P. 45)**
- Change the setting for <Special Printing Mode U>.
- ▶ **Special Processing (P. 523)**

→ **Is the amount remaining in the toner cartridge nearly empty?**

- Check the amount remaining in the toner cartridge, and replace the toner cartridges as necessary.

▶ **Replacing Toner Cartridges(P. 597)**

Printouts Are Faded



→ Is the amount remaining in the toner cartridge nearly empty?

- Check the amount remaining in the toner cartridge, and replace the toner cartridges as necessary.

▶ **Replacing Toner Cartridges(P. 597)**

→ Are you using appropriate paper?

- Check usable paper, and replace with appropriate paper. Also, specify the paper size and type settings properly.

▶ **Paper(P. 647)**

▶ **Loading Paper(P. 45)**

▶ **Specifying Paper Size and Type(P. 56)**

→ Are you using the machine in a special environment (in particular, a low-temperature environment)?

- Toner may not adhere adequately, causing printouts to appear faded. Change the setting for <Special Printing Mode K>.

▶ **Special Processing (P. 523)**

Printed Pages Have White Specks



→ Are you using appropriate paper?

- Check usable paper, and replace with appropriate paper.

▶ **Paper(P. 647)**

▶ **Loading Paper(P. 45)**

→ Is the drum in the toner cartridge deteriorated?

- Replace the toner cartridge with a new one.
- ▶ **Replacing Toner Cartridges(P. 597)**

→ Are you printing a document with strong contrasts?

- Change the setting for [Special Print Mode] using the Printer Driver.

NOTE:

When set to [Special Settings 2], print density is lighter compared with [Off] or [Special Settings 1]. Text and lines may also appear faded.

A Portion of the Page Is Not Printed

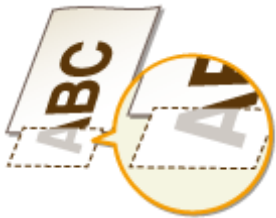

→ Do you print data without margins?

- This symptom occurs if a margin is set to none in the printer driver. A margin of 5 mm or less around the edge of paper or 10 mm or less around the edge of envelopes is not printable with the machine. Make sure to have margins around the document to print.

[Finishing] tab ▶ [Advanced Settings] ▶ [Expand Print Region and Print] ▶ [Off]

Print Density Is Uneven



→ Is the amount remaining in the toner cartridge nearly empty?

- Check the amount remaining in the toner cartridge, and replace the toner cartridges as necessary.
- ▶ **Replacing Toner Cartridges(P. 597)**

→ Is printing sometimes uneven when printing fine lines?

- Change the setting for <Special Printing Mode J>.

▶ **Special Processing (P. 523)**

Printouts Are Grayish



→ Is <Correct Density> in <Copy Settings> set too dark?

- Adjust the setting so that density is lighter.
- ▶ **Correct Density(P. 495)**

→ Is the printer installed where it is subject to direct sunlight or strong light?

- Install the printer in an appropriate location.
- ▶ **Installation(P. 3)**
- ▶ **Relocating the Machine(P. 605)**

→ Was the toner cartridge been left in direct sunlight for a long period of time?

- Store the toner cartridge in an appropriate location for two to three hours, then try printing again. This may solve the problem. If the problem persists, replace the toner cartridge.
- ▶ **Replacing Toner Cartridges(P. 597)**

Cannot Scan a Printed Barcode



→ Are you trying to scan a barcode printed with factory default settings?

- In the printer driver, specify [Special Settings 1] for the setting of [Special Print Mode].

NOTE:

- When set to [Special Settings 1], print density is lighter compared with [Off]. Text and lines may also appear faded.
- White specks may appear in images when this feature is used with paper other than lightweight paper.

Paper Creases or Curls

14L7-09R

Paper Creases



→ Is paper loaded correctly?

- If paper is not loaded below the load limit guide or is loaded obliquely, it may crease.
- ▶ **Loading Paper(P. 45)**

→ Are you using paper that has absorbed moisture?

- Replace with appropriate paper.
- ▶ **Loading Paper(P. 45)**

→ Are you using appropriate paper?

- Check usable paper, and replace with appropriate paper.
- ▶ **Paper(P. 647)**
- If the problem persists after using appropriate paper, change the setting for <Special Printing Mode V>.
- ▶ **Special Processing (P. 523)**

Paper Curls



→ Are you using appropriate paper?

- Check usable paper, and replace with appropriate paper. Also, specify the paper size and type settings properly.
- ▶ **Paper(P. 647)**
- ▶ **Loading Paper(P. 45)**

▶ **Specifying Paper Size and Type(P. 56)**

- If using plain paper (60 to 89 g/m²), making the following change in the printer driver may solve the problem.

[Page Setup] tab ▶ [Paper Type] ▶ [Plain L [60-89 g/m²]]

- If the use of the appropriate paper does not solve the problem, change the setting for <Special Printing Mode V>.

▶ **Special Processing(P. 523)**

Paper Is Fed Incorrectly

14L7-09S

Printouts Are Skewed



→ Do the paper guides align with the edges of the paper?

- If the paper guides are too loose or too tight, the printouts are skewed.
- ▶ **Loading Paper(P. 45)**

→ Is the paper source the manual feed slot?

- Load the paper into the paper drawer.
- ▶ **Loading Paper in the Paper Drawer(P. 47)**

→ Are you printing on curled envelopes?

- Uncurl the envelopes, and print again.
- ▶ **Loading Envelopes(P. 52)**

Paper Is Not Fed/Two or More Sheets Are Fed Together



→ Is paper loaded correctly?

- Fan the paper stack thoroughly so that paper is not stuck together.
- Check whether paper is loaded correctly.
- ▶ **Loading Paper(P. 45)**
- Check whether the number of sheets of paper loaded is appropriate and whether the appropriate paper is used.
- ▶ **Paper(P. 647)**

▶ **Loading Paper (P. 45)**

- Check whether mixed sizes and types of paper are loaded together.

Paper Jams Frequently with 2-Sided Printing (MF249dw / MF246dn)



→ **Does paper jam frequently especially with lightweight paper or curled paper during 2-sided printing?**

- Set <Special Printing Mode I> to <On>.
- ▶ **Special Processing (P. 523)**

When a Problem Cannot Be Solved

14L7-09U

If you cannot solve a problem by referring to the information in this chapter, contact your local authorized Canon dealer or the Canon help line.

IMPORTANT

Do not disassemble or repair the machine yourself

If you disassemble or repair the machine yourself, it may not be covered by warranty.

■ When Contacting Canon

When contacting us, have the following information ready:

- Product name (MF249dw / MF246dn / MF237w / MF235)
- Dealer where you purchased the machine
- Details about your problem (such as what you did and what happened as a result)
- Serial number (eight alphanumeric characters long, found on the label on the back side of the machine)

MF249dw / MF246dn

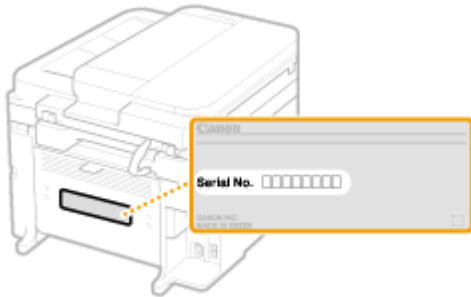

MF237w / MF235

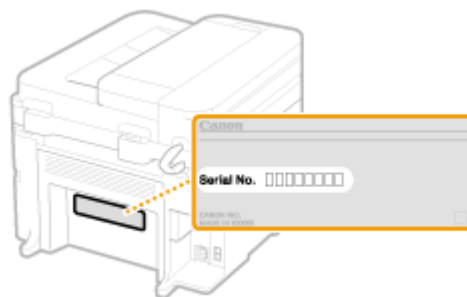

Maintenance

Maintenance	587
Cleaning the Machine	588
Exterior	589
Platen Glass	590
Feeder	593
Fixing Assembly	594
Machine Interior	595
Replacing Toner Cartridges	597
Before Replacing the Toner Cartridge	600
How to Replace Toner Cartridges	602
Relocating the Machine	605
Printing Reports and Lists	607
TX Result Report	608
Communication Management Report	611
RX Result Report	613
Consumables Status Report	614
Eco Report	615
PCL Font List (MF249dw / MF246dn)	616
Address Book List	617
User Data List	619
Viewing the Counter Value	620
Initializing Settings	621
Initializing Menu	622
Initializing Address Book	624
Initialize Eco Report Counter	625
Initializing All Data/Settings	626

Maintenance

This chapter describes upkeep of the machine, including how to clean the machine and initialize settings.

■ Basic Cleaning ▶ **Cleaning the Machine(P. 588)**



- The machine becomes dirty ▶ **Exterior(P. 589)**
- Smudge marks appear on originals or printouts ▶ **Platen Glass(P. 590)** ▶ **Feeder(P. 593)**
- Streaks appear on printouts ▶ **Fixing Assembly(P. 594)**
- The interior of the machine becomes dirty ▶ **Machine Interior(P. 595)**

■ Replacing Toner Cartridges

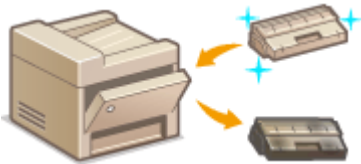

- If you want to check the remaining toner cartridge level ▶ **Replacing Toner Cartridges(P. 597)**
- How to replace toner cartridges ▶ **How to Replace Toner Cartridges(P. 602)**

■ Relocating the Machine



- Relocating the machine for maintenance or an office move ▶ **Relocating the Machine(P. 605)**

■ Printing Reports and Lists



- Print out reports describing transmission results, or a list of Address Book information ▶ **Printing Reports and Lists(P. 607)**

■ Checking the Total Pages Printed by the Machine

If you want to check the total page number of printouts ▶ **Viewing the Counter Value(P. 620)**

■ Initializing Settings

If you want to restore the settings ▶ **Initializing Settings(P. 621)**

Cleaning the Machine

Regularly clean the machine to prevent deterioration in printing quality and to ensure that you use it safely and easily. Carefully read the safety instructions before you start cleaning. ▶ **Maintenance and Inspections(P. 9)**

Where to Clean

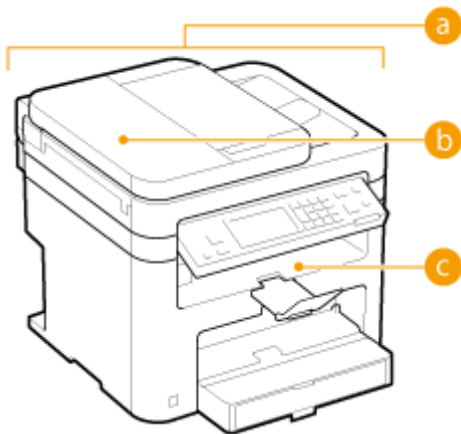

a Exterior of the machine and ventilation slots
▶ **Exterior(P. 589)**

b Rollers inside the feeder
▶ **Feeder(P. 593)**

c Interior of the machine and fixing assembly
▶ **Fixing Assembly(P. 594)**
▶ **Machine Interior(P. 595)**

d Platen glass and the underside of the feeder
▶ **Platen Glass(P. 590)**

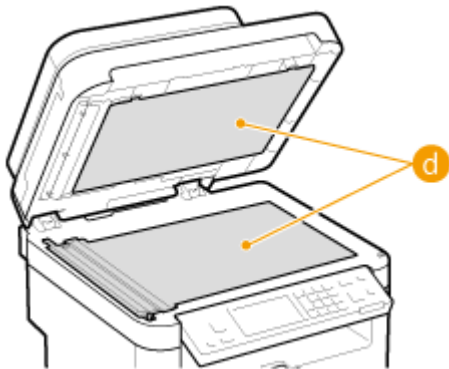

Exterior

14L7-09Y

Regularly wipe the exterior of the machine, especially around the ventilation slots, to keep the machine in good condition.

NOTE

Ventilation slots are provided only on MF249dw / MF246dn.

1 Turn OFF the machine, and unplug the power cord from the AC power outlet.

- When you turn OFF the machine, data that is waiting to be printed is deleted. Fax documents that were received by using the Memory Reception function, faxes that are waiting to be sent, and reports that are automatically printed after sending and receiving faxes are not deleted.

2 Clean the exterior of the machine and the ventilation slots.

- Use a soft, well-wrung-out cloth dampened with water or a mild detergent diluted with water.
- To locate the ventilation slots, see **Front Side(P. 18)** .



3 Wait for the exterior of machine to dry completely.

4 Reconnect the power cord and turn ON the machine.

Platen Glass

Regularly wipe off the dust from the platen glass and the underside of the feeder to prevent smudges to be printed on documents or printouts.

NOTE

Scanning area cleaning

To display a message when soiling is detected on the scanning area, set <Notify to Clean> to <On>.

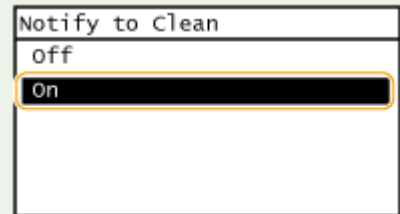

1 Turn OFF the machine, and unplug the power cord from the AC power outlet.

- When you turn OFF the machine, data that is waiting to be printed is deleted. Fax documents that were received by using the Memory Reception function, faxes that are waiting to be sent, and reports that are automatically printed after sending and receiving faxes are not deleted.

2 Open the feeder.

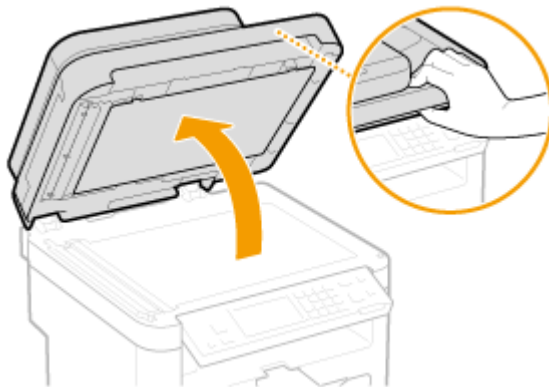

3 Clean the platen glass and the underside of the feeder.

- Clean the areas with a cloth dampened with water. Then, wipe the area with a soft, dry cloth.
- In addition to the platen glass and underside of the feeder, make sure to clean and wipe the white strip of plate (a) and the surface of the transparent plastic part (b), too.

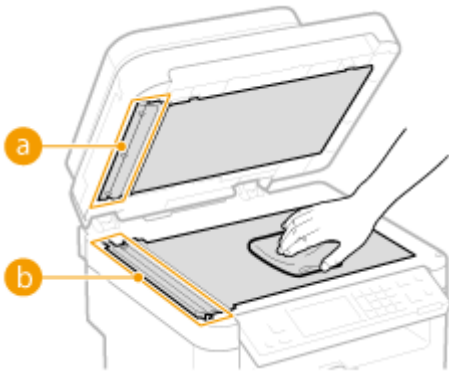

IMPORTANT:

- When wiping the transparent plastic part (b), take care not to bend the plastic.

■If the problem persists

Remove the transparent plastic part (b) and wipe it.

- 1 Hold the tabs (c) at both ends of the transparent plastic part, and remove the plastic part by gently lifting the rearward end first.

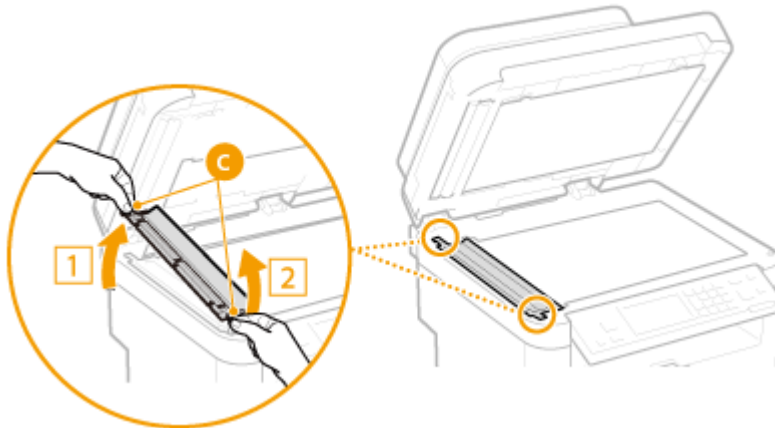

IMPORTANT:

- The plastic part (b) is rather damageable. When removing it, be careful not to bend it.

- 2 Wipe the scanning area (d).

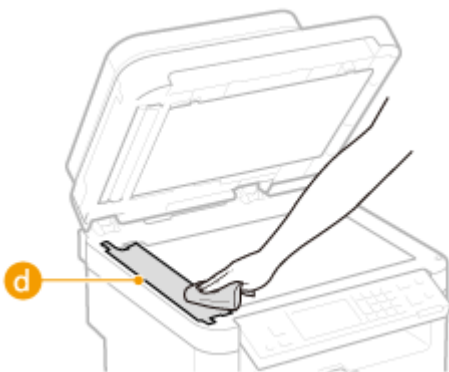

- 3 Wipe the back side of the transparent plastic part.

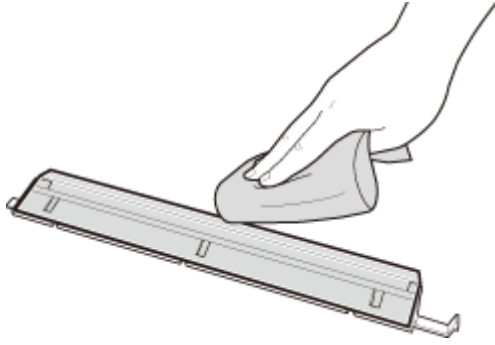

- 4** Wait for the plastic part to dry completely.
- 5** Place the transparent plastic part back into position.
 - Make sure of the proper orientation, then hold the tabs and place the plastic part back into position by gently lowering the frontward end first.

- 4** Wait for the cleaned area to dry completely.

- 5** Gently close the feeder.

- 6** Reconnect the power cord and turn **ON** the machine.

Feeder

Dust and graphite powder may adhere to the roller inside the feeder and cause smudges to appear on printouts. To clean the feeder, perform the following procedure.

1 Turn OFF the machine, and unplug the power cord from the AC power outlet.

- When you turn OFF the machine, data that is waiting to be printed is deleted. Fax documents that were received by using the Memory Reception function, faxes that are waiting to be sent, and reports that are automatically printed after sending and receiving faxes are not deleted.

2 Open the feeder cover.

MF249dw

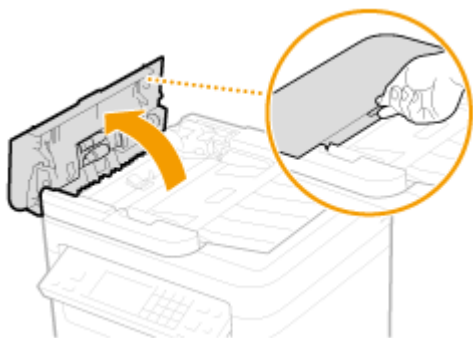

MF246dn / MF237w / MF235

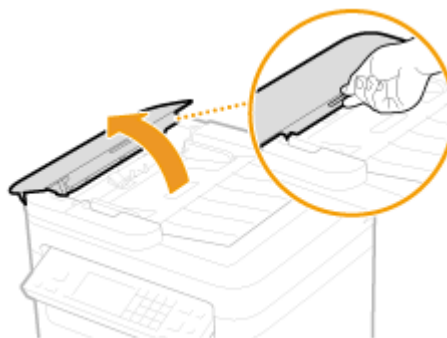

3 Wipe roller (a) inside feeder.

- Clean the areas with a well-wrung-out cloth dampened with water. Then, wipe the area with a soft, dry cloth.

MF249dw

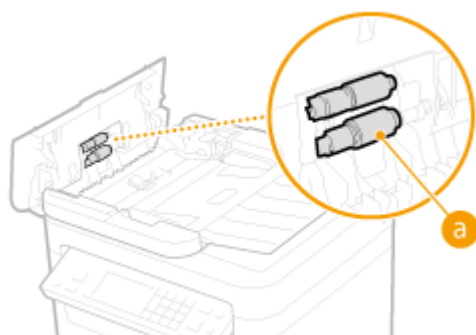

MF246dn / MF237w / MF235

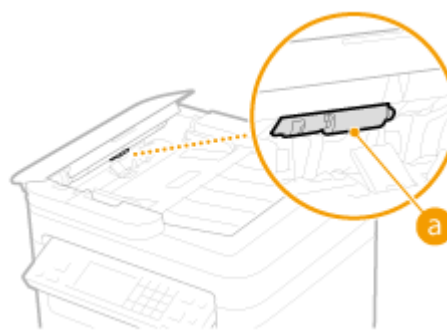

4 Gently close the feeder cover.

5 Reconnect the power cord and turn ON the machine.

Fixing Assembly

Dirt may adhere to the fixing units inside the machine and cause black streaks to appear on printouts. To clean the fixing unit, perform the following procedure. Note that you cannot clean the fixing unit when the machine has documents waiting to be printed. To clean the fixing unit, you need paper larger than plain A4 or Letter size paper. Set the paper in the manual feed slot before performing the following procedure.

NOTE

- Cleaning consumes the toner cartridge. Make sure that there is sufficient toner cartridge remaining beforehand.
- It takes approximately 90 seconds to clean the fixing assembly.

▶ **Checking Toner cartridge Level(P. 598)**

▶ **Loading Paper in the Manual Feed Slot(P. 50)**

1 Press  and tap <Menu>.

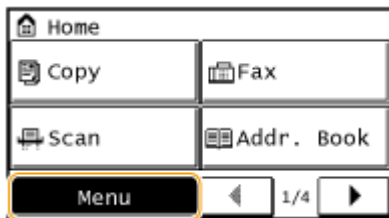

2 Tap <Adjustment/Maintenance>.

3 Tap <Clean Fixing Assembly>.

4 Load paper (A4/LTR or larger) in the manual feed slot, and tap <Start>.

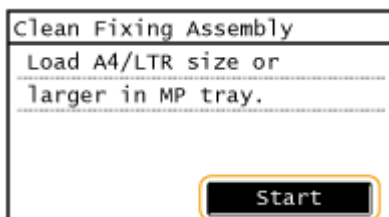

- After cleaning is completed and the message <Finished.> appears, press  to return to the <Home> Screen.

Machine Interior

14L7-0A3

Clean the interior of the machine regularly so that toner/paper dust does not collect.

1 Turn OFF the machine, and unplug the power cord from the AC power outlet.

- When you turn OFF the machine, data that is waiting to be printed is deleted. Fax documents that were received by using the Memory Reception function, faxes that are waiting to be sent, and reports that are automatically printed after sending and receiving faxes are not deleted.

2 Lift the operation panel.

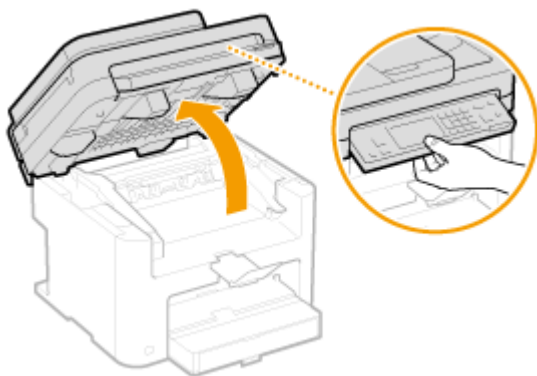

NOTE:

If you cannot lift the operation panel

Make sure the feeder is completely closed. If a thick original such as a book is placed on the platen glass, remove the original. Forcing the operation panel up may cause damage.

3 Open the toner cover by the grip at the front right of the toner cover.

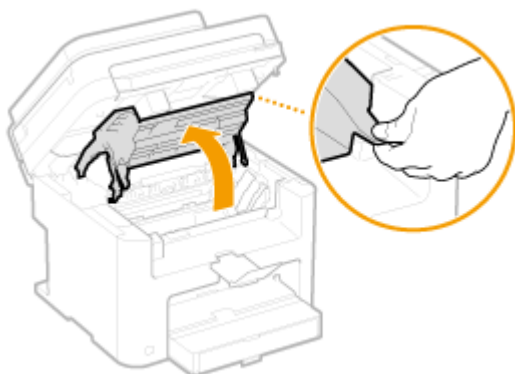

4 Pull the toner cartridge out of the machine.

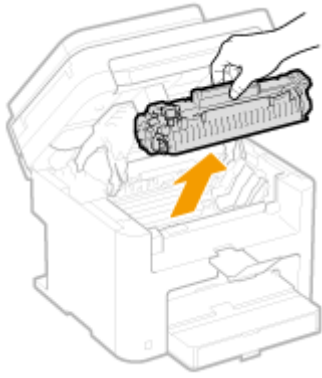

5 Using a lint-free clean, soft, dry cloth, wipe away toner/paper dust from the inside.

6 Install the toner cartridge.

- Align the right and left projections (a) with the toner cartridge guides, and push securely all the way in.

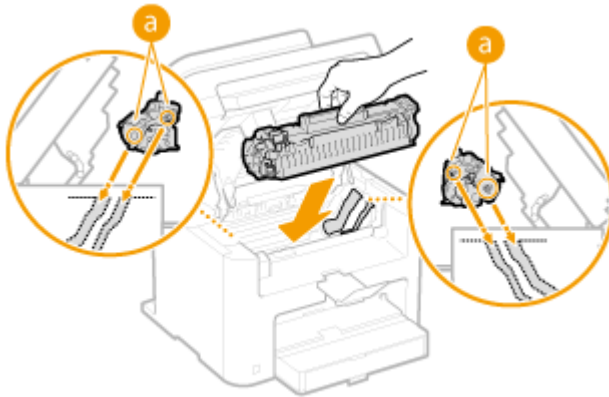

7 Close the toner cover, and lower the operation panel.

NOTE:

If you cannot close the toner cover

Make sure that the toner cartridge is inserted properly. Forcing it closed may cause damage.

8 Reconnect the power cord and turn ON the machine.

Replacing Toner Cartridges

The machine will display a message when a toner cartridge is nearly empty. Note that the print quality becomes poor if you continue printing without taking any action. You can check the remaining toner cartridge level on the display.

- ▶ **When a Message Appear(P. 597)**
- ▶ **If Printouts Are Poor in Quality(P. 598)**
- ▶ **Checking Toner cartridge Level(P. 598)**

■ When a Message Appear

The message that is displayed depends on the amount of remaining toner cartridge. Depending on which message is displayed, you will need to make sure that you have a replacement toner cartridge ready or replace the toner cartridge. ▶ **Before Replacing the Toner Cartridge(P. 600)** ▶ **How to Replace Toner Cartridges(P. 602)** ▶ **Consumables(P. 655)**

<Prepare a cartridge.>

This message notifies you that a toner cartridge needs to be replaced soon. Shake the toner cartridge to evenly distribute the toner inside the cartridge. Replace the toner cartridge if you see this message before you start to print a large job.

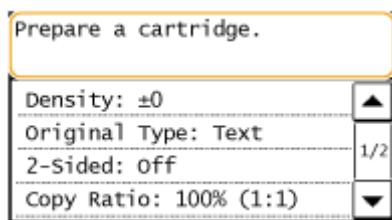

NOTE:

Specify when this message is displayed

- You can set any value as the percentage of the amount remaining in the toner cartridge that triggers this message. ▶ **Displ. Timing for Cartridge Prep. Notif.(P. 522)**

<Cartridge has reached end of lifetime. Rplcmt. recommended.>

This message notifies you that a toner cartridge has reached the end of its lifetime. It is recommended that you replace the cartridge with a new one. You can continue printing, but the print quality cannot be guaranteed.

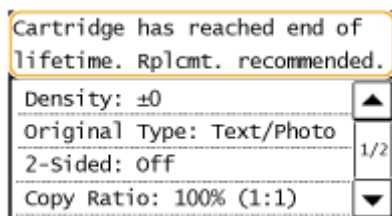

IMPORTANT

- If this message is displayed, the incoming fax will be stored in the memory without being printed. Also, reports are not printed, even if they are set to be printed automatically.

NOTE:

When a message is displayed

- If the message is displayed when the machine is receiving a fax or automatic report output is set, received faxes and reports will be stored in the machine so that they do not appear faded after they are printed.
- To continue printing even if the toner cartridge is running low, set <Continue Print. When Near Cart. Life End> to <On>. **▶Continue Print. When Near Cart. Life End (P. 506)**

■ If Printouts Are Poor in Quality

If your printouts begin to show any of the following features, one of your toner cartridges is nearly empty. Replace the nearly empty toner cartridge even if no message is displayed.

▶Before Replacing the Toner Cartridge(P. 600)

▶How to Replace Toner Cartridges(P. 602)

White streaks appear



Partially faded



Uneven density



Toner smudges and splatters appear



Blank space of originals becomes grayish in printouts



■ Checking Toner cartridge Level

You can check the amount remaining in the toner cartridge according to the following, whenever you want to. It is recommended that you check the level before you start to print a large job.

 **▶ <Device Information> ▶ <Cartridge Level> ▶ Check the amount remaining in the toner cartridge**

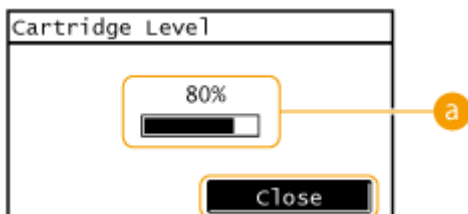

a Cartridge Level

Displays the amount remaining in the toner cartridges. Other internal parts may reach the end of their lifetime before the toner runs out.

NOTE

- The displayed amount remaining in the toner cartridge can be used only as a guide and may differ from the actual amount.

LINKS

[▶ Consumables\(P. 655\)](#)

Before Replacing the Toner Cartridge

14L7-0A5

Perform the following before replacing the toner cartridge. The message may no longer appear, or print quality may be improved. Review cautions for handling the toner cartridge before starting. **➤Maintenance and Inspections(P. 9)**
➤Consumables(P. 10)

1 Lift the operation panel.

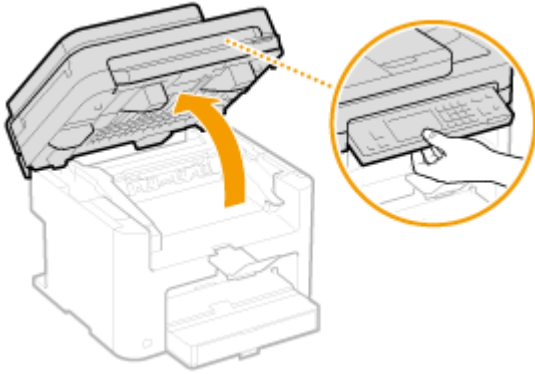

NOTE:

If you cannot lift the operation panel

Make sure the feeder is completely closed. If a thick original such as a book is placed on the platen glass, remove the original. Forcing the operation panel up may cause damage.

2 Open the toner cover by the grip at the front right of the toner cover.

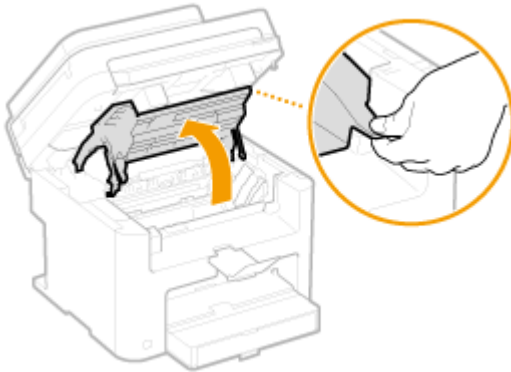

3 Pull the toner cartridge out of the machine.

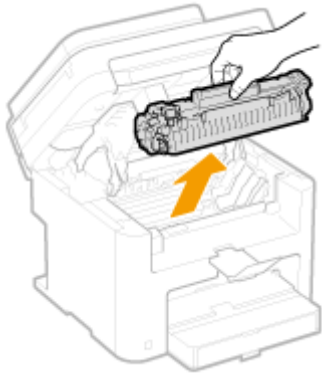

4 Shake the toner cartridge 5 or 6 times as shown below to evenly distribute the toner inside the cartridge.

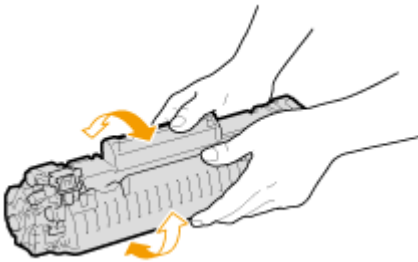

5 Install the toner cartridge.

- Align the right and left projections (a) with the toner cartridge guides, and push securely all the way in.

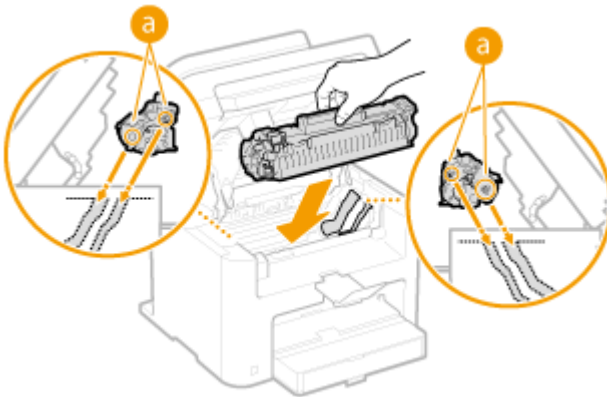

6 Close the toner cover, and lower the operation panel.

NOTE:

If you cannot close the toner cover

Make sure that the toner cartridge is inserted properly.
Forcing it closed may cause damage.

LINKS

▶ [Replacing Toner Cartridges\(P. 597\)](#)

How to Replace Toner Cartridges

Read the precautions in **Maintenance and Inspections(P. 9)** and **Consumables(P. 10)** before replacing the toner cartridges.

1 Lift the operation panel.

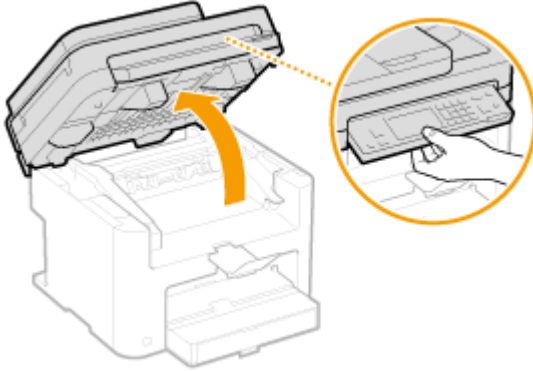

NOTE:

If you cannot lift the operation panel

Make sure the feeder is completely closed. If a thick original such as a book is placed on the platen glass, remove the original. Forcing the operation panel up may cause damage.

2 Open the toner cover by the grip at the front right of the toner cover.

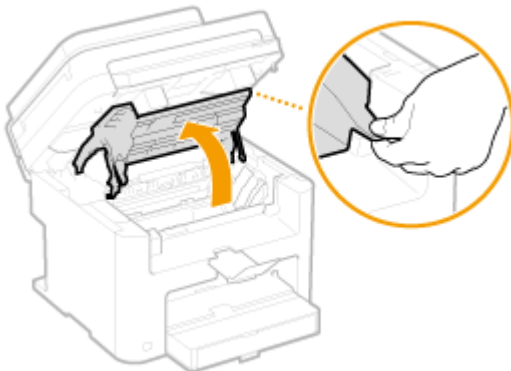

3 Pull the toner cartridge out of the machine.

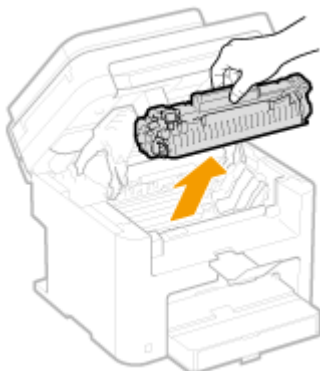

4 Remove the replacement toner cartridge from the protective bag.

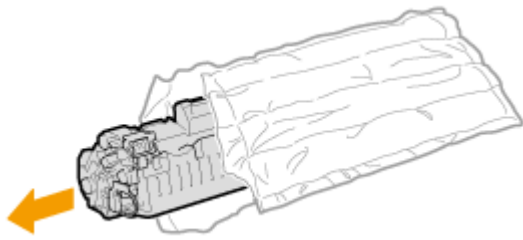

5 Shake the toner cartridge 5 or 6 times as shown below to evenly distribute the toner inside the cartridge, and then place it on a flat surface.

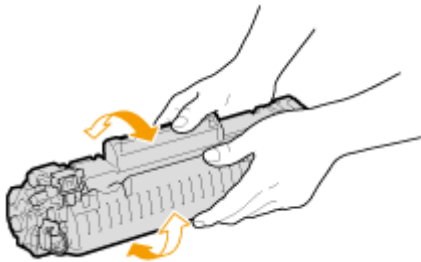

6 Pull the sealing tape straight out.

- The full length of the sealing tape is approximately 50 cm.

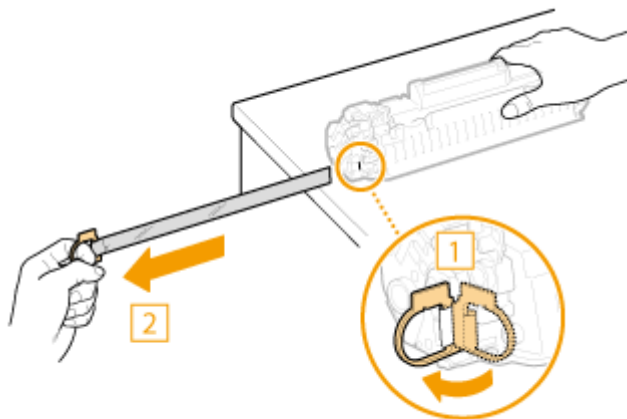

IMPORTANT:
When pulling out the sealing tape

If the sealing tape remains inside the toner cartridge, the quality of printouts, including faxes, may deteriorate. Also note that it will not be possible to reprint a fax because the fax function automatically deletes data once it is printed.

- Do not pull out the sealing tape at an angle or sideways. If the tape breaks, you may not be able to pull it out completely.

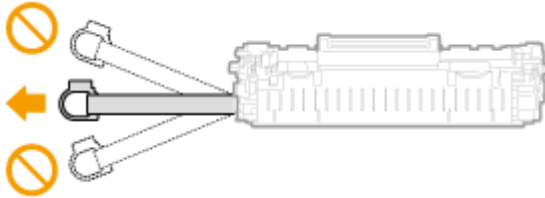

- If the sealing tape becomes stuck when pulling it out, keep pulling until it is completely removed.

7 Install the toner cartridge.

- Align the right and left projections (a) with the toner cartridge guides, and push securely all the way in.

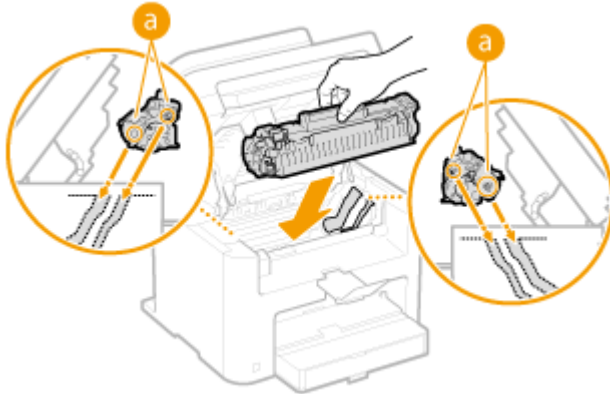

8 Close the toner cover, and lower the operation panel.

NOTE:

If you cannot close the toner cover

Make sure that the toner cartridge is inserted properly. Forcing it closed may cause damage.

LINKS

- **Before Replacing the Toner Cartridge(P. 600)**

Relocating the Machine

14L7-0A7

The machine is heavy. Make sure to follow the procedures below when moving the machine to avoid injury, and also make sure to read the safety precautions before you begin. **▶Important Safety Instructions(P. 2)**

1 Turn OFF the machine and computer.

- When you turn OFF the machine, data that is waiting to be printed is deleted. Fax documents that were received by using the Memory Reception function, faxes that are waiting to be sent, and reports that are automatically printed after sending and receiving faxes are not deleted.

2 Disconnect the cables and cord from the machine in numerical order as in the illustration below.

- Whether the cables with "*" are connected depends on your environment.

- 1 Power plug
- 2 Power cord
- 3 USB cable*
- 4 LAN cable*
- 5 Optional handset or external telephone cable*
- 6 Telephone cable*

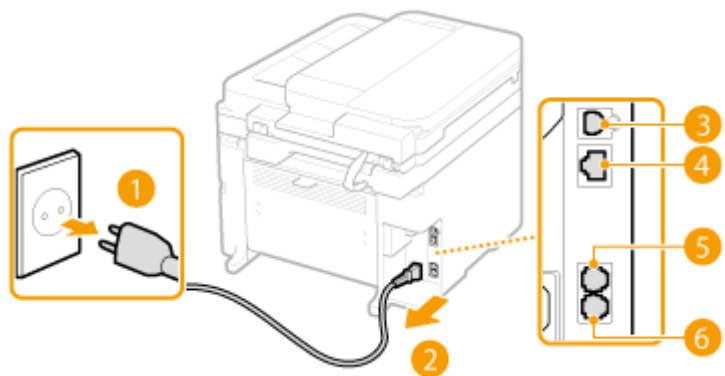

3 When transporting the machine across a long distance, remove the toner cartridges. **▶How to Replace Toner Cartridges(P. 602)**

4 Open the paper cover and remove any paper.

- If the paper guides are extended, return them so that they fit in the paper drawer.

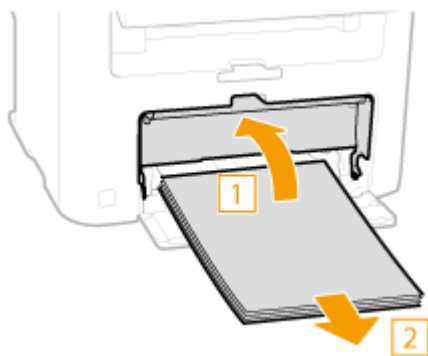

5 Close all the open covers, and move the machine to the new location.

- Check how heavy the machine is and carry it without straining. **▶Machine Specifications(P. 642)**

- Lift by the carrying grips on the front of the machine.

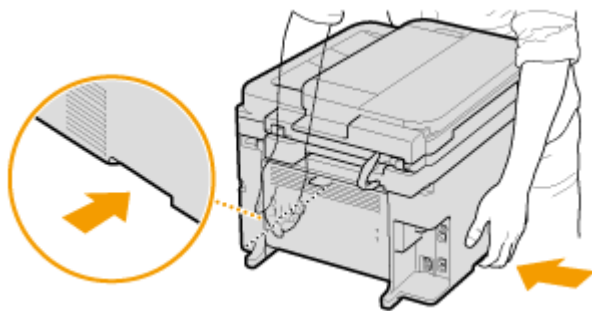

6 Carefully place the machine at the new installation site.

- For installation steps after moving, see "Getting Started". ▶ **Manuals Included with the Machine(P. 656)**

Printing Reports and Lists

14L7-0A8

You can check fax results and the machine settings by printing reports and lists.

TX Result Report

You can check the logs of sent documents. ▶ **TX Result Report(P. 608)**

Communication Management Report

You can check the logs of sent and received documents. ▶ **Communication Management Report(P. 611)**

RX Result Report

You can check the logs of received fax documents. ▶ **RX Result Report(P. 613)**

Consumables Status Report

You can check the consumables status installed in the machine. ▶ **Consumables Status Report(P. 614)**

Eco Report

You can check information such as the number of printouts per month and amount of consumed power, and also check ways to increase savings. ▶ **Eco Report(P. 615)**

PCL Font List (MF249dw / MF246dn)

You can check the list of available fonts for the machine. ▶ **PCL Font List (MF249dw / MF246dn)(P. 616)**

Address Book List

You can check the list of destinations registered in the Address Book. ▶ **Address Book List(P. 617)**

User Data List

You can check the list of the settings (▶ **Setting Menu List(P. 472)**) as well as the content that has been registered in the machine. ▶ **User Data List(P. 619)**

TX Result Report

14L7-0A9

You can check the fax or e-mail logs of sent documents as well as documents saved to a shared folder by printing a TX Result Report. The report can be printed either every time a transmission is completed or only when a sending error occurs.

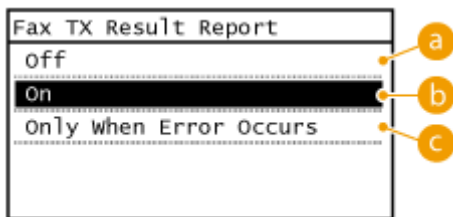
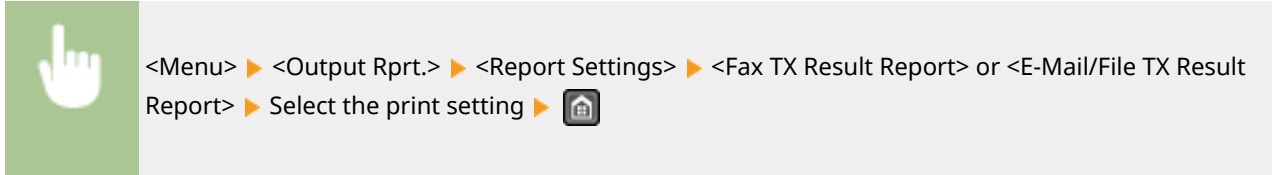

a <Off>

Select if you do not want to print TX Result Reports.

b <On>

Select to print a TX Result Report every time you send a document.

c <Only When Error Occurs>

Select to print a TX Result Report only when a sending error occurs.

Example: Fax sending

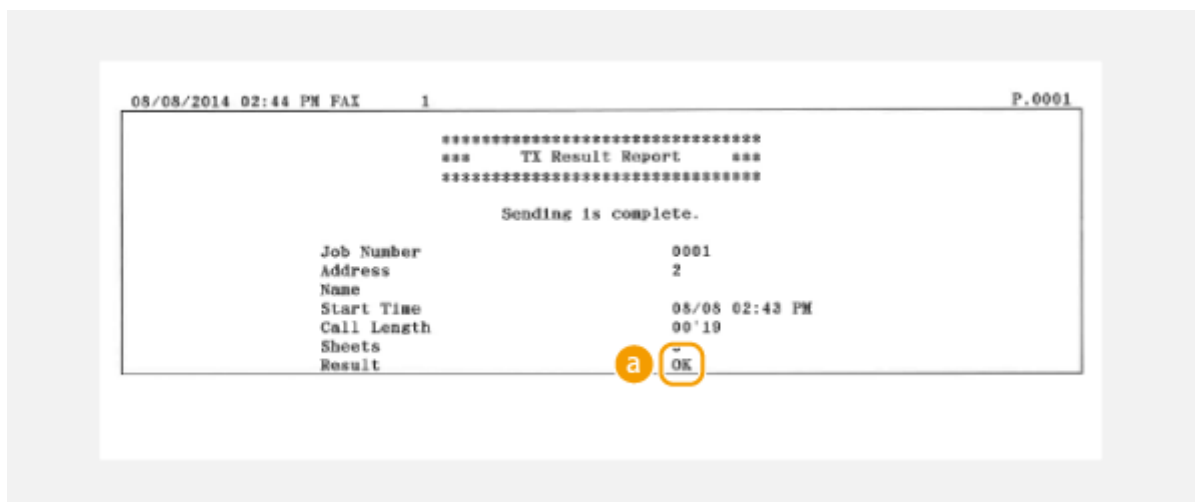

Example: Scanning to e-mail/shared folder

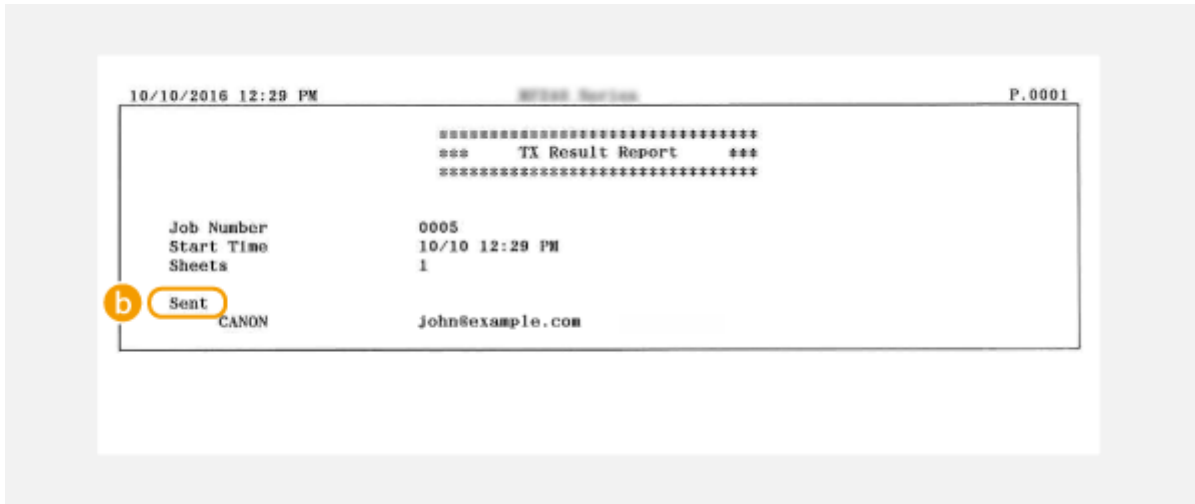

a Result

"OK" indicates that the transmission was completed successfully while "NG" and three digits (an error code) indicates that the transmission failed (**▶When an Error Code Appears(P. 558)**).

b Sent/Error

For e-mail, TX Result Reports indicate the transmission result between the machine and the mail server, not between the machine and the destination address. Even if the transmission fails, a three-digit error code will not be printed. To check the error code, print a Communication Management Report (**▶Communication Management Report(P. 611)**).

NOTE

To print a part of a fax document on the report

When you select <On> or <Only When Error Occurs>, a part of a fax document can be included in the report. Tap <Include TX Image> to <On>.

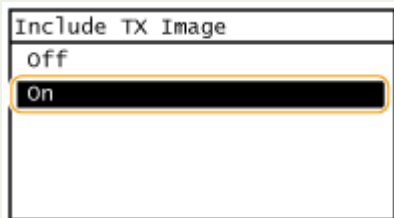

08/08/2014 02:44 PM FAX

1

P.0001

*** TX Result Report ***

Sending is complete.

Job Number	0001
Address	123XXXXXXXX
Name	
Start Time	08/08 02:43 PM
Call Length	00'19
Sheets	3
Result	OK

XXXXXX

Communication Management Report

14L7-0AA

You can check the fax and e-mail logs of sent and received documents by printing a Communication Management Report. The report can be printed automatically after every 40 transmissions, or you can print it manually.



<Menu> ▶ <Output Rprt.> ▶ <Report Settings> ▶ <Communication Management Report> ▶ Select the print setting ▶ 

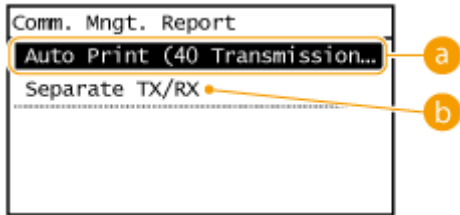

a <Auto Print (40 Transmissions)>

Tap <On> to print the report automatically after every 40 transmissions, or <Off> if you do not want to print the report automatically.

b <Separate TX/RX>

Tap <On> to print sent and received reports separately, or <Off> to print both reports on one sheet.

Print the Report Manually



<Menu> ▶ <Output Rprt.> ▶ <Print List> ▶ <Communication Management Report> ▶ Check that the size of paper displayed on the screen is loaded in the machine ▶ <OK> ▶ <Yes> ▶ 

Example:

Start Time	Name	No.	Comm. Mode	Page	Print
08/08 02:43 PM	123XXXXXXXX	0001	Auto TX ECM	3	OK 00'18
08/08 02:46 PM	456XXXXXXXX	0002	Auto TX ECM		OK 00'18

a Result

"OK" indicates that the transmission was completed successfully while "NG" and three digits (an error code) indicates that the transmission failed ( **When an Error Code Appears(P. 558)**). For e-mail, Communication Management Reports indicate the transmission result between the machine and the mail server, not between the machine and the destination address.

RX Result Report

14L7-0AC

You can check the logs of received fax documents by printing an RX Result Report. The report can be printed either every time a transmission is completed or only when a receiving error occurs.

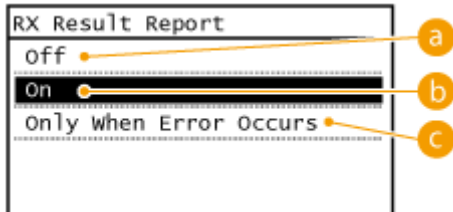
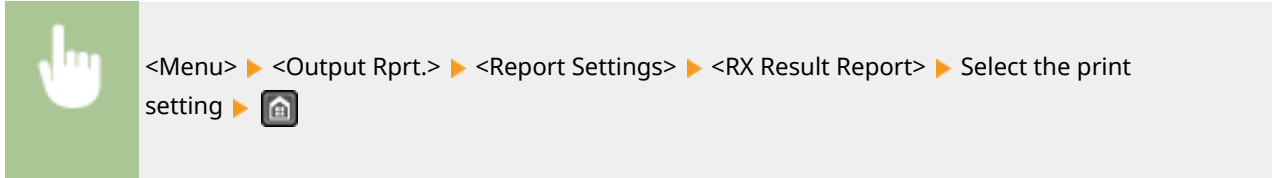

a <Off>

Select if you do not want to print RX Result Reports.

b <On>

Select to print an RX Result Report every time you receive a document.

c <Only When Error Occurs>

Select to print an RX Result Report only when a receiving error occurs.

Example:

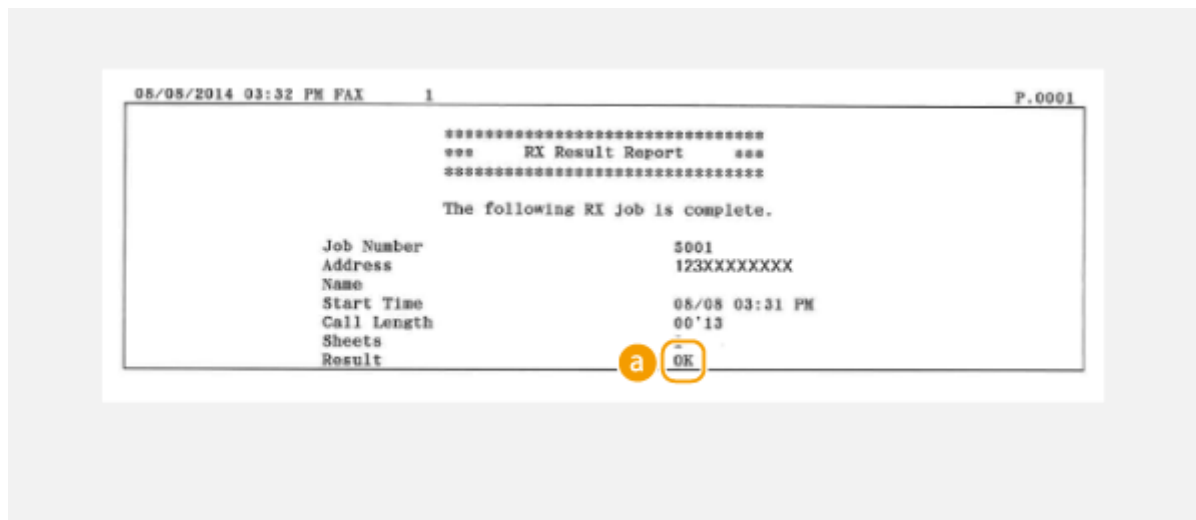

a Result

"OK" indicates that the transmission was completed successfully while "NG" and three digits (an error code) indicates that the transmission failed ([▶When an Error Code Appears\(P. 558\)](#)).

Consumables Status Report

You can check the consumables status installed in the machine.



<Menu> ▶ <Output Rprt.> ▶ <Print List> ▶ <Consumables Status Report> ▶ Check that the size of paper displayed on the screen is loaded in the machine ▶ <OK> ▶ <Yes> ▶ 

Example:

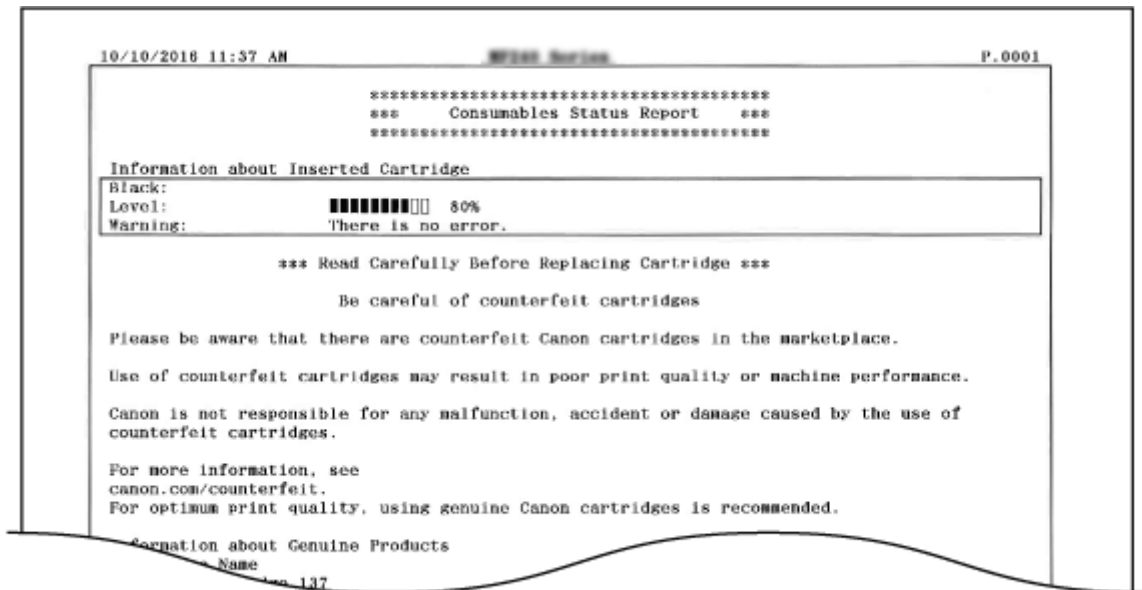

LINKS

🔗 [Replacing Toner Cartridges\(P. 597\)](#)

Eco Report

14L7-0AF

You can check information such as the number of printouts per month and amount of consumed power, and also check ways to increase savings.



<Menu> ▶ <Output Rprt.> ▶ <Print List> ▶ <Eco Report> ▶ Check that the size of paper displayed is loaded in the machine ▶ <OK> ▶ <Yes> ▶ 

Example:

10/10/2016 11:34 AM P.0001

*** Eco Report ***

You can change the settings of this device to save paper and energy.
For more information, refer to the manual.

*Save Paper
Current Usage (Average Number of Sheets Output per Month)

	Total Output Sheets	2-Sided Sheets	N on 1 Sheets
Copy	0	0 (0%)	0 (0%)
Print	0	0 (0%)	0 (0%)
Fax	0	0 (0%)	-

To Save Paper:
<Print on Both Sides/Print Multiple Pages of Data onto 1 Page>
You can combine multiple pages of data onto 1 sheet to save paper.
You can also change the default settings so that you do not have to configure the same settings every time.
You can change the default settings for Copy from the control panel.
Follow the steps below.
Menu > Copy Settings > Change Default Settings
You can change the default settings for Print.
Open Printer Folder from a connected computer.
<Use Memory Lock>
Enable Memory Lock Settings to check the content of the memory lock before printing to print them.
Change Memory Lock Settings

LINKS

- ▶ Consumables Status Report(P. 614)
- ▶ Replacing Toner Cartridges(P. 597)

PCL Font List MF249dw / MF246dn

14L7-0AH

You can check the list of available fonts for the machine.



<Menu> ▶ <Output Rprt.> ▶ <Print List> ▶ <PCL Font List> ▶ Check that the size of paper displayed on the screen is loaded in the machine ▶ <OK> ▶ <Yes> ▶ 

Example:

FONTS LIST							PAGE 001
PCL Internal Fonts							
Font Name	Symbol	Spacing	Style	StrokeW	Pitch/Point Typeface	Sample	
[000] Courier		0	0	0	scalable 4099	ABCDEFGHIJKLMNOPQRSTUVWXYZ	
[001] CG Times		1	0	0	scalable 4101	ABCDEFGHIJKLMNOPQRSTUVWXYZ	
[002] CG Times Bold		1	0	3	scalable 4101	ABCDEFGHIJKLMNOPQRSTUVWXYZ	
[003] CG Times Italic		1	1	0	scalable 4101	ABCDEFGHIJKLMNOPQRSTUVWXYZ	
[004] CG Times Bold Italic		1	1	3	scalable 4101	ABCDEFGHIJKLMNOPQRSTUVWXYZ	
[005] CG Omega		1	0	0	scalable 4113	QRSTUVWXYZ	
	Bold	0	0	3	scalable	WXYZ	

Address Book List

14L7-0AJ

You can check the list of destinations registered in the Address Book as <Coded Dial>, <One-Touch>, and <Group Dial> by printing an Address Book List.



<Menu> ▶ <Output Rprt.> ▶ <Print List> ▶ <Address Book List> ▶ Select the setting you want to print out ▶ Check that the size of paper displayed on the screen is loaded in the machine ▶ <OK> ▶ <Yes> ▶ 

Example: <Coded Dial>

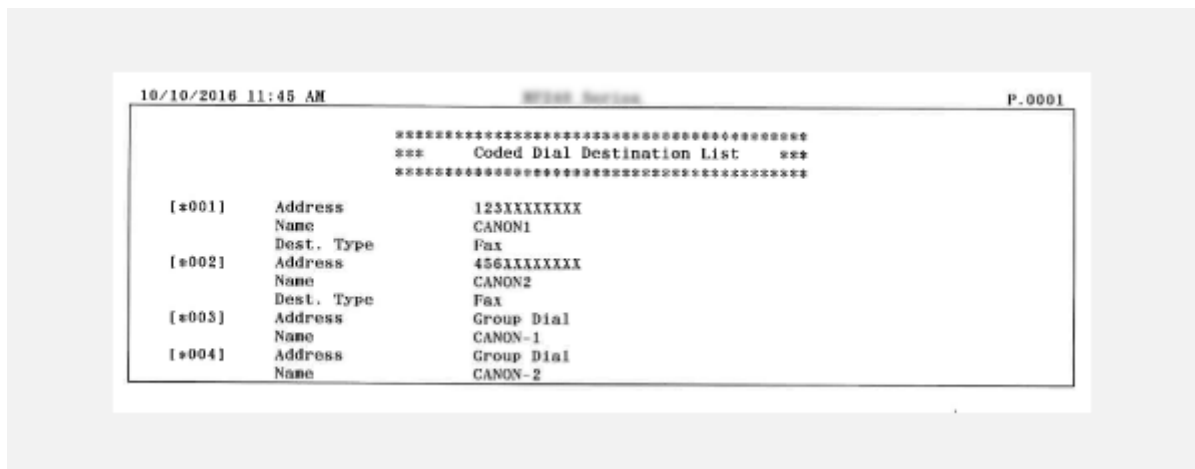

Example: <One-Touch>

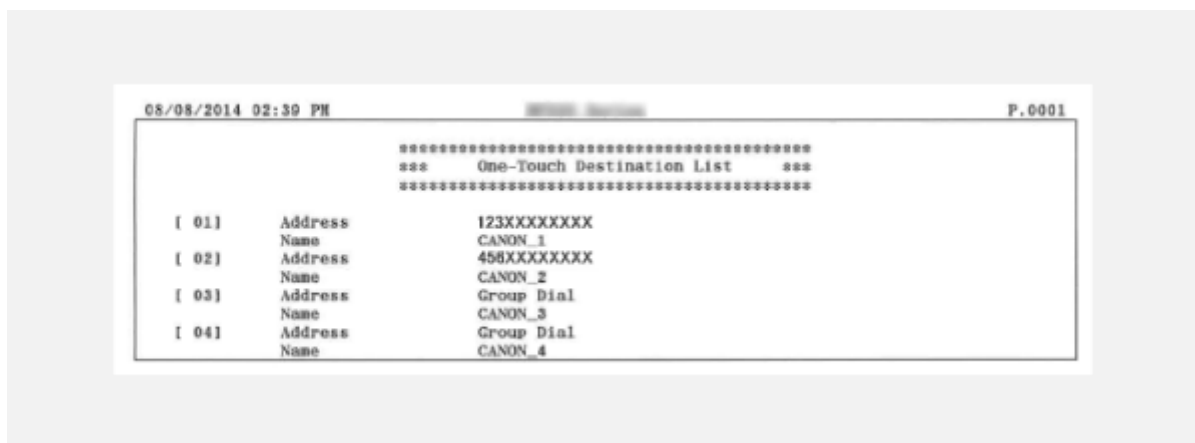

Example: <Group Dial>



LINKS

- ▶ **Registering in the Address Book(P. 60)**
- ▶ **Registering Address Book from Remote UI(P. 467)**

User Data List

14L7-0AK

You can check the list of the settings ([▶Setting Menu List\(P. 472\)](#)) as well as the content that has been registered in the machine by printing a User Data List. This list includes the paper size and type registered in the machine, the print settings of <TX Result Report>, <Communication Management Report>, and <RX Result Report>.



<Menu> ▶ <Output Rprt.> ▶ <Print List> ▶ <User Data List> ▶ Check that the size of paper displayed on the screen is loaded in the machine ▶ <OK> ▶ <Yes> ▶ 

Example:

```

10/10/2018 11:33 AM                               P.0001
*****
*** User Data List ***
*****
Rom Controller Version
  Boot Rom                               00.00
  Main Controller                         00.00
  Language                                00.00
  DCON                                    00.00
  Device Configuration                    4IN1_W_PCL
  Memory Capacity                         512 MB
  Serial Number                           *****
1. Network Settings
  Select Wired/Wireless LAN               Wired LAN
  Direct Connection Settings
  Use Direct Connection                   off
TCP/IP Settings
  IPv4 Settings
  IP Address Settings
  Auto Acquire                            off
  Select Protocol                         off
  Auto IP                                  off
  IP Address
  Subnet Mask

```

LINKS

- ▶ [TX Result Report\(P. 608\)](#)
- ▶ [Communication Management Report\(P. 611\)](#)
- ▶ [RX Result Report\(P. 613\)](#)
- ▶ [Loading Paper\(P. 45\)](#)

Viewing the Counter Value

14L7-0AL

You can check total for the number of pages used for printouts. This total includes faxes, reports, and lists, in addition to copies and printouts of data from computers.

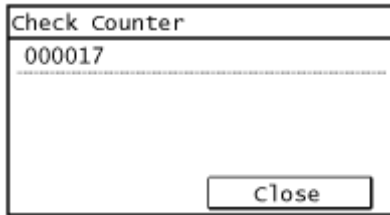
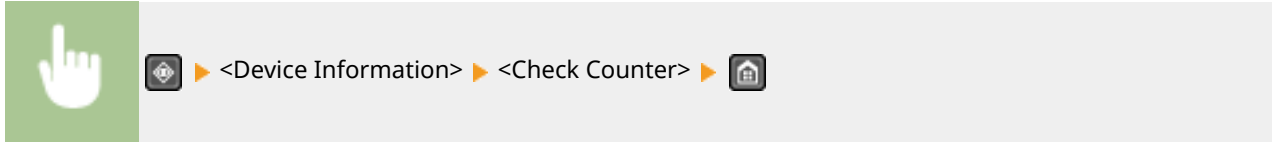

Initializing Settings

14L7-0AR

You can restore the following settings:

- ▶ **Initializing Menu(P. 622)**
- ▶ **Initializing Address Book (P. 624)**
- ▶ **Initialize Eco Report Counter(P. 625)**
- ▶ **Initializing All Data/Settings(P. 626)**

Initializing Menu

14L7-0AS

You can restore the settings of the machine (**▶Setting Menu List(P. 472)**). Depending on the settings selected, you may need to restart the machine after initialization.

NOTE

- If a screen for entering a PIN is displayed, enter the PIN with the numeric keys and tap <Apply>. **▶Setting the System Manager PIN(P. 397)**



<Menu> ▶ <System Management Settings> ▶ <Initialize Menu> ▶ Select the item you want to initialize ▶ <Yes> ▶

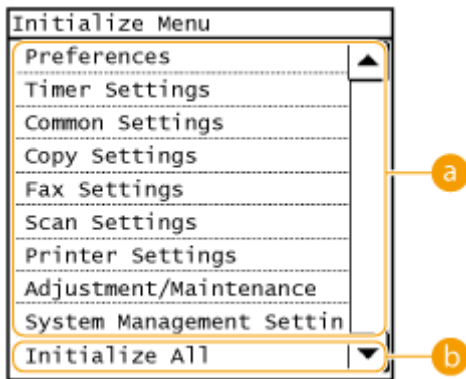

a Items for initializing

Select the setting you want to initialize.

■ When <System Management Settings> is selected

Select the specific system management settings that you want to initialize and tap <Yes>.

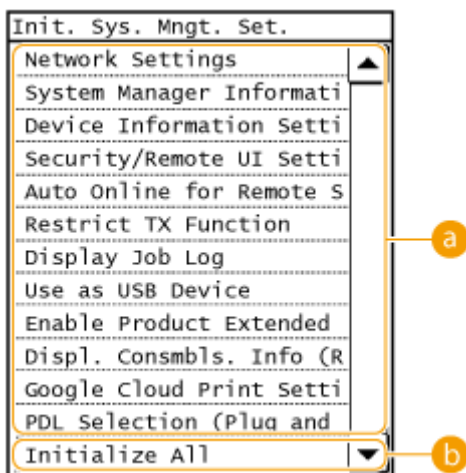

a Settings to be initialized

Select the settings to be initialized.

b <Initialize All>

Initializes all the system management settings.

IMPORTANT

If Remote UI settings are initialized

- The Remote UI Access PIN is also initialized. After an initialization, reset the Remote UI Access PIN. ▶ **Setting a Remote UI PIN (MF249dw / MF246dn / MF237w)(P. 399)**

NOTE

- You can use the procedure below to restore the default <Network Settings>.

<Menu> ▶ <Network Settings> ▶ <Initialize Network Settings> ▶ <Yes> ▶ Restart the machine

b <Initialize All>

Initializes all the settings.

Initializing Address Book

14L7-0AU

You can restore the settings of the Address Book. Note that all the information registered in the Address Book will be deleted after initializing.

NOTE

If a screen for entering a PIN is displayed, enter the PIN with the numeric keys and tap <Apply>. [▶Setting the System Manager PIN\(P. 397\)](#)



<Menu> ▶ <System Management Settings> ▶ <Initialize Address Book> ▶ <Yes> ▶ 

LINKS

- ▶ [Registering in the Address Book\(P. 60\)](#)
- ▶ [Registering Address Book from Remote UI\(P. 467\)](#)

Initialize Eco Report Counter

14L7-0AW

You can initialize the number of printouts appearing in the Eco Report and return it to its factory default setting. The number of printouts returns to 0 after being initialized.

NOTE

If a screen appears prompting you to enter a PIN, enter the correct PIN using the numeric keys, and tap <Apply>. [▶Setting the System Manager PIN\(P. 397\)](#)



<Menu> ▶ <System Management Settings> ▶ <Initialize Eco Report Counter> ▶ <Yes> ▶ 

LINKS

[▶Eco Report\(P. 615\)](#)

Initializing All Data/Settings

14L7-0AX

To make changes to registered data and settings all at once such as when changing the installation location of the machine, you can delete registered data (Address Book, etc.) and initialize all settings ([▶Setting Menu List\(P. 472\)](#)) together at the same time. You are required to restart the machine after initializing all data/settings.

NOTE

If a screen for entering a PIN is displayed, enter the PIN with the numeric keys and tap <Apply>. [▶Setting the System Manager PIN\(P. 397\)](#)



<Menu> ▶ <System Management Settings> ▶ <Initialize All Data/Settings> ▶ <Yes> ▶ <Yes> and restart the machine.

Appendix

Appendix	628
Third Party Software (MF249dw / MF246dn / MF237w)	629
Feature Highlights	630
Going Green and Saving Money	631
Improving Efficiency	633
Going Digital	635
So Much More	638
Specifications	641
Machine Specifications	642
Wireless LAN Specifications (MF249dw / MF237w)	644
Document Type	645
Scan Area	646
Paper	647
Copy Specifications	649
Fax Specifications	650
Scanner Specifications	651
Printer Specifications	652
Specifications for E-Mail Sending (MF249dw / MF246dn)	653
Specifications for Scanning to Shared Folders (MF249dw / MF246dn)	654
Consumables	655
Manuals Included with the Machine	656
Using User's Guide	657
Screen Layout of User's Guide	658
Viewing User's Guide	662
Others	663
Basic Windows Operations	664
Notice	673

Appendix

14L7-0AY

This chapter contains technical specifications of this machine, instructions on how to use the User's Guide, disclaimers, copyright information, and other important information for customers.

Third Party Software MF249dw / MF246dn / MF237w

14L7-0E4

For information related to third-party software, click the following icon.



Feature Highlights

14L7-0C0

Give the features that are described in this section a try. The features are grouped under four headings: "Going Green and Saving Money," "Improving Efficiency," "Going Digital," and "So Much More."

Going Green and Saving Money

14L7-0C1

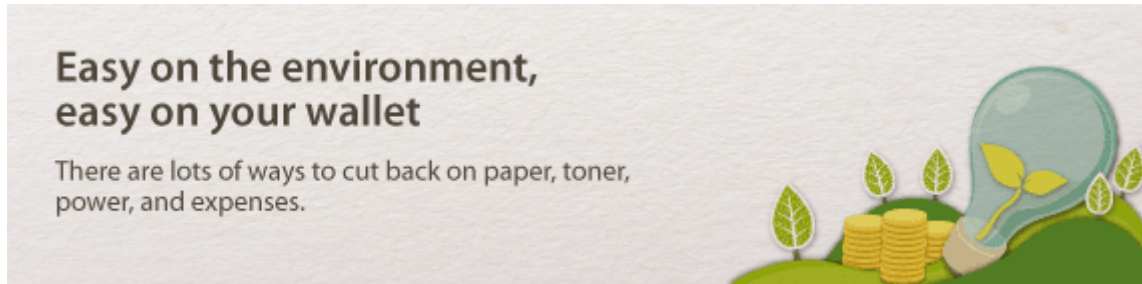

01



2-Sided Printing (MF249dw / MF246dn)

You can use 2-sided printing for copies, print jobs sent from your computer, and even incoming faxes. Because you'll only be using half the paper you would otherwise, you can cut your paper costs in half. The <Paper Save> button enables you to save even more paper by allowing you to simultaneously select the settings for 2-sided copying and for copying multiple pages onto one sheet.



- To make 2-sided copies: [▶2-Sided Copying \(MF249dw / MF246dn\)\(P. 91\)](#)
- To save paper when you copy: [▶Using the <Paper Save> Button\(P. 96\)](#)
- To print 2-sided documents from your computer: [▶Switching 1-Sided and 2-Sided Printing \(MF249dw / MF246dn\)\(P. 203\)](#)
- To print 2-Sided incoming faxes: [▶Print on Both Sides\(P. 504\)](#)

02



Print Multiple Pages on a Single Sheet

To really start saving paper, shrink multiple pages onto a single sheet - 2 or 4 pages for copies, and up to 16 pages for print jobs sent from your computer. This is even more effective when used together with 2-sided printing.



- To copy multiple pages of a document onto one sheet: [▶Copying Multiple Documents onto One Sheet \(2 on 1/4 on 1\)\(P. 94\)](#)
- To save paper when you copy: [▶Using the <Paper Save> Button\(P. 96\)](#)

- To print multiple pages of a document onto one sheet: **▶Printing Multiple Pages onto One Sheet(P. 207)**

03



Sleep Mode

For saving energy and money, a sleep mode that powers down a machine when nobody is using it has become an essential feature. This machine will enter sleep mode automatically, and can also be put to sleep whenever you want. Press  once to put the machine to sleep. Press it again to instantly wake the machine back into action.



For more information about this function, see **▶Entering Sleep Mode(P. 76)** .

04



Save Toner

Got multi-page documents or drafts that don't need presentation-quality printing? There's a setting that uses less toner. Give it a try and save toner and money.



For more information about this function, see **▶Saving Toner(P. 220)** .

05



Paperless Faxing

Assume you need paper to fax? Those old paper printouts you always make are a thing of the past. Send documents by fax just as they are, created on your computer. It's paperless, so it's fast. And, received documents are first stored in memory, allowing you to print out only those needed and eliminating worry about paper getting used on direct mailings, etc.



- To send documents from the computer as faxes: **▶Sending Faxes from Your Computer (PC Fax)(P. 167)**
- To store received documents into memory: **▶Storing Received Faxes into Memory (Memory Reception) (P. 150)**

Improving Efficiency

14L7-0C2

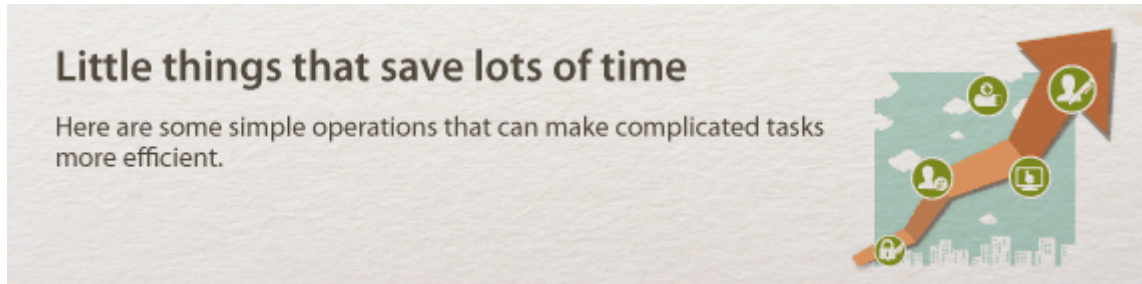

01



Address Book

Entering fax and e-mail addresses in the Address Book saves you the inconvenience of entering them number-by-number, letter-by-letter every time you have something to send. By registering destinations that you frequently send to <One-Touch>, you can quickly display them anytime. You can save your Address Book data on your computer and feel secure knowing that your important contact information is backed up.

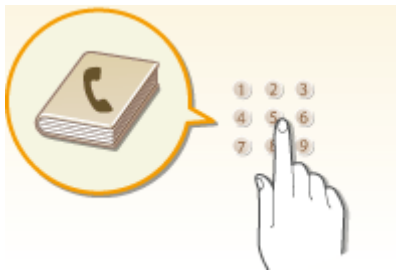

- To use the machine to enter addresses in the Address Book: **▶Registering in the Address Book(P. 60)**
- To use your computer to enter addresses in the Address Book: **▶Registering Address Book from Remote UI(P. 467)**
- To select an Address Book address as a fax destination: **▶Specifying from Address Book(P. 121)**
- To select an Address Book address as an e-mail destination: **▶Specifying from Address Book(P. 273)**
- To save Address Book addresses on your computer or to export Address Book addresses from your computer to the machine, using the Remote UI: **▶Saving/Loading Address Book from Remote UI(P. 463)**
- To save Address Book addresses on your computer or export Address Book addresses from your computer to the machine using the supplied software: **▶Importing/Exporting Address Book Data with the Supplied Software(P. 165)**

02



Shortcut Keys for Copying and Scanning

Take advantage of the shortcut keys on the operation panel so you don't have to reconfigure the same settings over and over again. The <Paper Save> button enables you to save paper by allowing you to copy two or four pages onto one sheet. If you are using a machine capable of 2-sided printing, you can also copy on both sides of the sheet. For scanning, use the <Scan -> PC1> / <Scan -> PC2> buttons to preset your favorite save destinations, scan types, and file formats. Just place your document and touch one of these shortcut keys to scan.



- To save paper when you copy: ▶ **Using the <Paper Save> Button(P. 96)**
- To easily scan documents: ▶ **Scanning Using the <Scan -> PC> Button(P. 237)**

03



Remote Management with Remote UI (MF249dw / MF246dn / MF237w)

Remote UI lets you manage a lot from your computer, all without having to go over to the machine. Configure settings and keep an eye on the machine's status with an intuitive, easy-to-understand Web browser interface that you'll master immediately. Save your time and energy for things other than taking care of the machine.

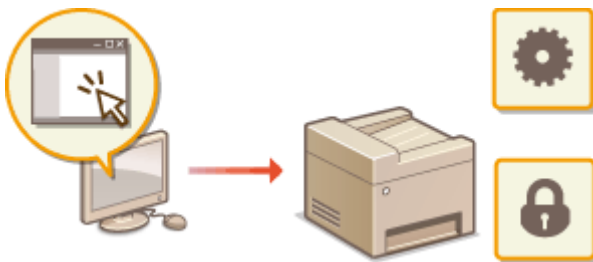

For more information about this function, see ▶ **Using Remote UI (MF249dw / MF246dn / MF237w)(P. 449)** .

04



Make Print Settings Quickly with Intuitive Operation

You can easily specify the page layout as well as binding position, switching between 1-sided and 2-sided printing, etc. intuitively on the preview image in the printer driver. The simple click-operation allows you to conveniently make settings while viewing how settings are applied.

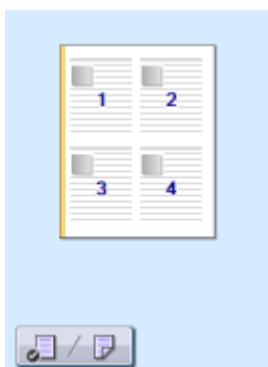

For more information, see ▶ **Printing a Document(P. 191)** .

Going Digital

14L7-0C3

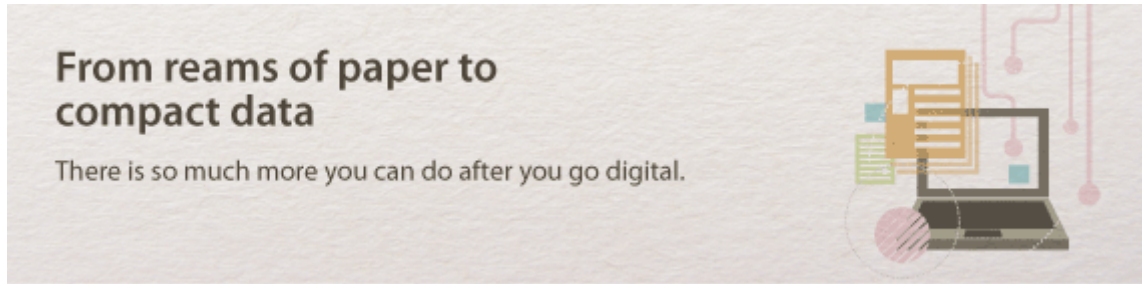

01



Scan and E-Mail (MF249dw / MF246dn)

E-mail scanned documents without even turning on your computer. Just convert your scanned document into an e-mail attachment right from the machine. If you're one of those people who'd rather send a fax than mess around with a computer, this feature is for you.



For more information about this function, see [▶ Sending Documents as E-Mails Directly from the Machine \(P. 246\)](#).

02



Scan and Share (MF249dw / MF246dn)

Say you've got a paper copy of a report for a company-wide meeting. Scan it, convert it, and now everyone can see it. It's saved directly in a shared folder on your network, so there's no need to print out copies and pass them out. Once you start talking about hundreds of pages of documents that everyone needs, there's just no other way to go.

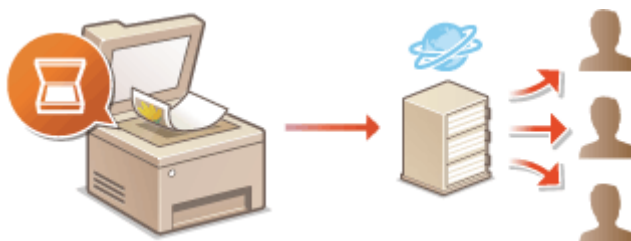

For more information about this function, see [▶ Saving Documents Directly in Shared Folder \(P. 253\)](#).

03



Scan Only What You Need

What if you're scanning a whole page of a newspaper but all you're really interested in is a headline and a photo? Use ScanGear MF. You can select what you want from a preview, and then have the scanner disregard the rest. Otherwise you'll have to use an editing program to crop out everything you don't need.

IMPORTANT

- Using your product to scan, print or otherwise reproduce certain documents, and the use of such images as scanned, printed or otherwise reproduced by your product, may be prohibited by law and may result in criminal and/or civil liability. If you are uncertain about the legality of using your product to scan, print or otherwise reproduce any particular document, and/or of the use of the images scanned, printed or otherwise reproduced, you should consult in advance with your legal advisor for guidance.

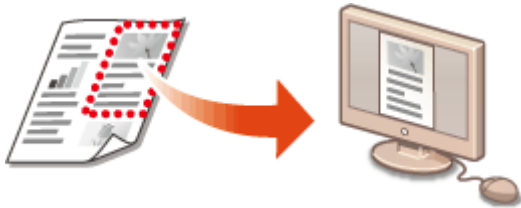

For more information about this function, see [▶Configuring Scan Settings in ScanGear MF\(P. 244\)](#) .

04



Searchable PDFs

Searching of text in a PDF can be done with a "searchable PDF*". By scanning an original with both text and images, text portions are converted by OCR into text data. In addition to being able to search for text information, you can also copy required portions into an Excel spreadsheet or Word document in Microsoft Office. Eliminate the need to type in customer data, addresses, etc. from scratch.

* You cannot create a searchable PDF in the Mac OS environment.



For more information about scanning from a computer, see [▶Scanning from a Computer\(P. 241\)](#) .

05



Add Images to a Work in Progress

Some applications work with the machine to let you easily import scanned images directly into documents you're working on. This way you can skip the steps of opening a separate application just for receiving the scanned images and then exporting them to the application you're really using.



For more information about this function, see [▶ Scanning Using an Application\(P. 242\)](#) .

So Much More

14L7-0C4

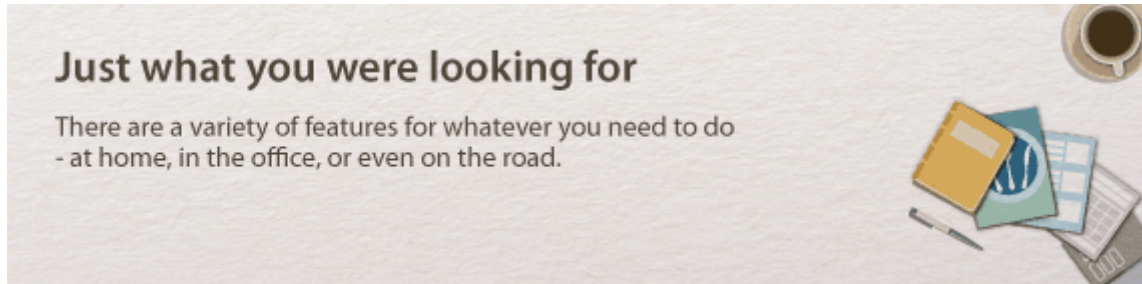

01



Using a smartphone/tablet (MF249dw / MF246dn / MF237w)

At times such as when you want to quickly print out a proposal you completed on a tablet while travelling to a business destination, or scan materials handed out at a meeting using a smartphone, Canon PRINT Business or Canon Print Service comes in handy. Even in environments without a wireless LAN router, you can connect to the machine with a mobile device wirelessly and directly.

PCless, quick, and easy! An even broader range of possibilities for work/play with functionality made for this age of speed.



For more information, see [▶Can Be Used Conveniently with a Mobile Device \(MF249dw / MF246dn / MF237w\)\(P. 289\)](#) .

02



Easy Printing with Google Cloud Print (MF249dw / MF246dn / MF237w)

Hook up to Google Cloud Print with your laptop or cell phone, send your data, and out come your printed documents. With this machine, Google Cloud Print, and your mobile device, print whenever you want from wherever you want.



For more information about this function, see [▶Using Google Cloud Print\(P. 308\)](#) .

03



Go Wireless (MF249dw / MF237w)

No cables, easy installation, simple maintenance. If you've got a WPS wireless LAN router, bypass the settings process altogether and be ready to go before you know it. Enjoy the kind of clutter-free and easy to use document system that you can only get from wireless. Compatible with IEEE 802.11b/g/n for stress-free wireless, and also supports WEP and WPA/WPA2-PSK (TKIP/AES-CCMP) for tighter security.



For more information about this function, see [▶Connecting to a Wireless LAN \(MF249dw / MF237w\)\(P. 319\)](#) .

04



Get Faxes Wherever You Go (MF249dw / MF246dn)

Never worry about missing a fax when you're out of the office. Set a forwarding destination and any fax that comes in on the machine will go right to you. Better yet, make the forwarding destination the e-mail address for your tablet or mobile.



For more information about this function, see [▶Forwarding Received Faxes\(P. 154\)](#) .

05



Make Posters

Blow up a regular one-sheet printout and make an exceptionally large poster. A large poster will be printed out on nine sheets. Put them together in a 3x3 grid, and voila!

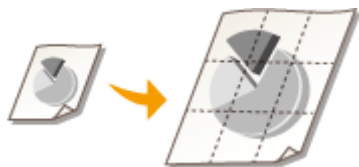

For more information about this function, see [▶Printing Posters\(P. 209\)](#) .

06



Make Booklets (MF249dw / MF246dn)

Sometimes your documents deserve better presentation than a staple in the upper-left corner. Making booklets is easy. The print driver will take care of the page positioning for you. All you have to do is fold the pages and staple them along the middle.



For more information about this function, see [▶ Printing Booklet \(MF249dw / MF246dn\)\(P. 211\)](#) .

Specifications

14L7-0C5

The machine specifications are subject to change without prior notice due to improvements of the machine.

- ▶ **Machine Specifications(P. 642)**
- ▶ **Wireless LAN Specifications (MF249dw / MF237w)(P. 644)**
- ▶ **Document Type(P. 645)**
- ▶ **Scan Area(P. 646)**
- ▶ **Paper(P. 647)**
- ▶ **Copy Specifications(P. 649)**
- ▶ **Fax Specifications (P. 650)**
- ▶ **Scanner Specifications(P. 651)**
- ▶ **Printer Specifications(P. 652)**
- ▶ **Specifications for E-Mail Sending (MF249dw / MF246dn)(P. 653)**
- ▶ **Specifications for Scanning to Shared Folders (MF249dw / MF246dn)(P. 654)**

Machine Specifications

14L7-OC6

Type	Personal Desktop
Power Supply ^{*1}	220 to 240 V, 50/60 Hz (Power requirements differ depending on the country in which you purchased the product.)
Power Consumption	<p>Maximum</p> <p>- MF249dw / MF246dn 1,150 W or less</p> <p>- MF237w / MF235 1,120 W or less</p> <p>Average consumption during standby mode</p> <p>- MF249dw / MF246dn Approx. 5.7 W</p> <p>- MF237w / MF235 Approx. 5.1 W</p> <p>Average consumption during sleep mode</p> <p>- MF249dw Approx. 1.3 W (by USB Connections) Approx. 1.4 W (by Wired Connections) Approx. 2.1 W (by Wireless Connections)</p> <p>- MF246dn Approx. 1.3 W (by USB Connections) Approx. 1.4 W (by Wired Connections)</p> <p>- MF237w Approx. 1.2 W (by USB Connections) Approx. 1.3 W (by Wired Connections) Approx. 2.0 W (by Wireless Connections)</p> <p>- MF235 Approx. 1.2 W</p> <p>When the power switch is turned OFF 0.5 W or less</p>
Warm-up Time ^{*2} (From power ON until machine enters standby)	13.5 seconds or less
Weight ^{*3}	<p>- MF249dw Approx. 13.7 kg</p> <p>- MF246dn Approx. 12.8 kg</p> <p>- MF237w Approx. 12.1 kg</p> <p>- MF235 Approx. 12.0 kg</p>

*1 The current value displayed on the rating label indicates average current consumption.





*2 Warm-up time may vary depending on the use conditions and environment of the machine.

*3 The value indicates the mass of the main unit including toner cartridges.

*4 MF249dw / MF246dn / MF237w only

*5 MF249dw / MF237w only

*6 Indicates that the sound pressure level of each bystander position is below the ISO 7779 absolute criteria for the background noise level.

Dimensions (W x D x H)	- MF249dw Standard 390 x 378 x 360 mm With optional handset 472 x 378 x 360 mm - MF246dn / MF237w / MF235 Standard 390 x 371 x 360 mm With optional handset 472 x 371 x 360 mm
Environmental Conditions	Temperature: 10 to 30°C Humidity: 20% to 80% RH (no condensation)
Host Interface	100BASE-TX*4 10BASE-T*4 Hi-Speed USB IEEE 802.11b/g/n (Infrastructure mode)*5
Noise (measured in accordance with ISO 7779, declared noise emission in accordance with ISO 9296)	LwAd (Declared A-weighted sound power level (1 B = 10 dB)) - MF249dw / MF246dn During standby mode: Inaudible*6 During printing: 6.6 B or less (1-sided) During printing: 6.6 B or less (2-sided) - MF237w / MF235 During standby mode: Inaudible*6 During printing: 6.5 B or less (1-sided) LpAm (Declared A-weighted emission sound pressure level (Bystander position)) - MF249dw During standby mode: Inaudible*6 During printing: Approx. 51 dB (1-sided) During printing: Approx. 52 dB (2-sided) - MF246dn During standby mode: Inaudible*6 During printing: Approx. 52 dB (1-sided) During printing: Approx. 52 dB (2-sided) - MF237w / MF235 During standby mode: Inaudible*6 During printing: Approx. 51 dB (1-sided)
Acceptable Documents	 Supported Document Types(P. 645)
Acceptable Paper Stock	 Paper(P. 647)
Printable Range	 Printable Area(P. 648)
Scan Range	 Scan Area(P. 646)

*1 The current value displayed on the rating label indicates average current consumption.

*2 Warm-up time may vary depending on the use conditions and environment of the machine.

*3 The value indicates the mass of the main unit including toner cartridges.

*4 MF249dw / MF246dn / MF237w only

*5 MF249dw / MF237w only

*6 Indicates that the sound pressure level of each bystander position is below the ISO 7779 absolute criteria for the background noise level.

Wireless LAN Specifications MF249dw / MF237w

14L7-0C7

Standard	IEEE 802.11g, IEEE 802.11b, IEEE 802.11n
Frequency Range	2,412 to 2,472 MHz
Communication Mode	Infrastructure Mode / Access Point Mode
Security	Infrastructure Mode WEP, WPA-PSK (TKIP/AES-CCMP), WPA2-PSK (TKIP/AES-CCMP) Access Point Mode WPA2-PSK (AES-CCMP)
Connection Method	WPS (Wi-Fi Protected Setup), Manual setup

Document Type

14L7-0C8

■ Supported Document Types

	Platen Glass	Feeder
Size (W x L)	Up to 216 x 297 mm	MF249dw Maximum size: 216 x 356 mm Minimum size: 140 x 127 mm MF246dn / MF237w / MF235 Maximum size: 216 x 356 mm Minimum size: 148 x 105 mm
Weight	—	1-sided documents 50 to 105 g/m ² 2-sided documents * 60 to 105 g/m ²
Paper Capacity	1 sheet	MF249dw Up to 50 sheets (A4, 80 g/m ²) MF246dn / MF237w / MF235 Up to 35 sheets (A4, 80 g/m ²)

*MF249dw only.

Scan Area

14L7-0C9

The shaded areas in the table below indicate the scan area of the document. Make sure that text and images in your documents fit within the shaded area. The scan area varies depending on the function used and where documents are placed (in the feeder or on the platen glass).

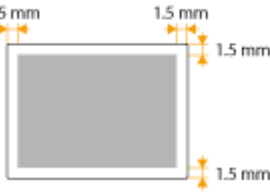
	Platen Glass	Feeder
Copy	 <p>NOTE: The scan area for copying may differ from the printable area. ▶Printable Area(P. 648)</p>	 <p>NOTE: The scan area for copying may differ from the printable area. ▶Printable Area(P. 648)</p>
Fax		
Scan	Saving in a Computer 	Saving in a Computer 
	Sending by E-mail/Sending to a File Server (MF249dw / MF246dn) 	Sending by E-mail/Sending to a File Server (MF249dw / MF246dn) 

Paper

14L7-OCA

■ Supported Paper Sizes

Paper sizes that can be loaded in the paper drawer, and the manual feed slot are listed below.

A4 (210 x 297 mm)^{*1 *2}

B5 (182 x 257 mm)

A5 (148 x 210 mm)

Legal (216 x 356 mm)^{*1}

Letter (216 x 279 mm)^{*1 *2}

Statement (140 x 216 mm)

Executive (184 x 267 mm)

Oficio (216 x 318 mm)^{*1}

Oficio (Brazil) (216 x 355 mm)^{*1}

Oficio (Mexico) (216 x 341 mm)^{*1}

Letter (Government) (203 x 267 mm)

Legal (Government) (203 x 330 mm)

Foolscap (216 x 330 mm)^{*1}

Foolscap (Australia) (206 x 338 mm)

Legal (India) (215 x 345 mm)^{*1}

F4A (216 x 343 mm)^{*1}

Envelope No. 10 (COM10) (104.7 x 241.3 mm)

Envelope Monarch (98.4 x 190.5 mm)^{*3}

Envelope C5 (162 x 229 mm)

Envelope DL (110 x 220 mm)

3x5inch (76 x 127 mm)^{*3}

Custom^{*4}

^{*1} Only in MF249dw / MF246dn, automatic 2-sided printing is available without replacing paper.

^{*2} The machine can print received fax documents.

^{*3} You can load Envelope Monarch and 3x5inch only in the manual feed slot.

^{*4} Custom paper size of 76.2 to 216.0 mm in width and 210 to 356.0 mm in length can be loaded in the paper drawer. Custom paper size of 76.2 to 216.0 mm in width and 127 to 356.0 mm in length can be loaded in the manual feed slot.

NOTE

The default paper size of the machine is set to A4. Change the paper size setting when using a different size of paper.

▶ **Specifying Paper Size and Type(P. 56)**

■ Paper Type and Paper Source Capacity

Chlorine-free paper can be used with this machine.

Paper Type		Paper Capacity for Paper Drawer	Paper Capacity for Manual Feed Slot
Plain paper* ¹	60 to 80 g/m ²	250 sheets	1 sheet
	81 to 89 g/m ²	170 sheets	1 sheet
Heavy paper* ²	90 to 105 g/m ²	170 sheets	1 sheet
	106 to 163 g/m ²	100 sheets	1 sheet
Recycled paper* ¹	60 to 80 g/m ²	250 sheets	1 sheet
	81 to 89 g/m ²	170 sheets	1 sheet
Color paper* ¹	60 to 80 g/m ²	250 sheets	1 sheet
	81 to 89 g/m ²	170 sheets	1 sheet
Bond paper* ³	60 to 163 g/m ²	100 sheets	1 sheet
Label		100 sheets	1 sheet
Envelope		20 sheets	1 sheet

*¹ Only in MF249dw / MF246dn, automatic 2-sided printing is available without replacing paper.

*² Only in MF249dw / MF246dn, automatic 2-sided printing is available for heavy paper 1 (90 to 120 g/m²).

*³ Only in MF249dw / MF246dn, automatic 2-sided printing is available for bond paper 1 (60 to 90 g/m²) and bond paper 2 (91 to 120 g/m²).

■ Paper Type and Setting for the Machine

▶ **Loading Paper(P. 45)**

■ Printable Area

The shaded areas in the image below indicate the printable area of the document.

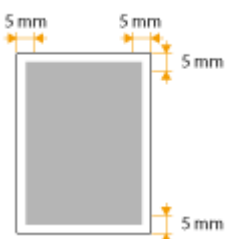

Copy Specifications

14L7-0CC

Scan Resolution	Text/Photo (High Speed) 300 x 600 dpi Text/Photo, Photo, Text 600 x 600 dpi
Output Resolution	600 x 600 dpi
Copy Ratio	100% 1:1, 400% Max, 200%, 141% A5->A4, 122% A5->B5, 115% B5->A4, 86% A4->B5, 81% B5->A5, 70% A4->A5, 50%, 25% Min
Copy Speed* (A4 Plain 1:1)	MF249dw / MF246dn 27 cpm MF237w / MF235 23 cpm
Continuous Copying Capacity	Maximum 999 copies
First Copy Time (A4)	Platen glass: 9 seconds or less Feeder: 14 seconds or less

* The copy speed on A4 size plain paper on one-side printing is measured during continuous copying. Copy speeds vary depending on the output resolution, the paper type and size, and the paper feeding direction. Copy speeds on smaller paper sizes may be slower. Plus, the machine may experience downtime or decrease the copy speed in the middle of a continuous copy run to adjust the temperature inside the machine or maintain the optimal print quality.

Fax Specifications

14L7-OCE

Line Used	Public Switched Telephone Network (PSTN)* ¹
Communication Mode	Super G3, G3
Compression Method	MH, MR, MMR
Modem Speed	Super G3: 33.6 Kbps, G3: 14.4 Kbps Automatic fallback
Transmission Speed	Approx. 3 seconds per page* ² (ECM-MMR, transmitting from the memory at 33.6 Kbps)
Sending from Memory/Receiving in Memory	Maximum approx. 256 pages* ² (Total pages of transmission/reception) (Maximum number of fax jobs that can be sent from the memory: 10 jobs/Maximum number of fax jobs that can be received into the memory: 90 jobs)
Fax Resolution	Normal: 200 x 100 dpi Fine: 200 x 200 dpi Photo: 200 x 200 dpi Superfine: 200 x 400 dpi
Dialing	One-touch keys (4 destinations) Coded dialing (100 destinations) Group dialing (103 groups) Address Book dialing Regular dialing (with numeric keys) Automatic redialing Manual redialing Sequential broadcast (114 destinations)
Reports	TX Result Report Communication Management Report (By default, auto output every 40 destinations) RX Result Report
Telephone Type	Handset (optional)/External telephone/External telephone with the built-in answer function/Data modem

*¹ Depending on your locale or your telephone connection, you may be unable to perform data communication. In this case, contact your local authorized Canon dealer or the Canon help line.

*² Based on ITU-T (ITU Telecommunication Standardization Sector) Standard Chart No. 1, MMR standard mode.

Scanner Specifications

14L7-OCF

Type	Color scanner
Maximum Scan Size	Platen glass: up to 216 x 297 mm Feeder: up to 216 x 356 mm
Scan Resolution	Optical resolution Platen glass: up to 600 x 600 dpi Feeder: up to 300 x 300 dpi Software interpolation resolution 9,600 x 9,600 dpi
Scan Speed* (A4, 300 x 300 dpi)	Color: Approx. 4 seconds/sheet Black and White: Approx. 3 seconds/sheet
Driver	TWAIN WIA 2.0 ICA

* Speed of scanning via the platen glass. The communication time is not included.

Printer Specifications

14L7-0CH

Output Tray Capacity * ¹ (a fresh stack of A4 size paper)	Approx. 100 sheets (68 g/m ²)
Print Speed * ² (A4 Plain 1:1)	MF249dw / MF246dn 27 ppm MF237w / MF235 23 ppm
First Print Time * ³ (A4)	6 seconds or less
Print Resolution	600 dpi x 600 dpi (1,200 dpi equivalent x 1,200 dpi equivalent)
Gradation	256 gradations
Toner Cartridges	 Consumables(P. 655)

*¹ May vary depending on the installation environment and paper type used.

*² The print speed on A4 size plain paper on one-side printing is measured during continuous printing. Print speeds vary depending on the output resolution, the paper type and size, and the paper feeding direction. Print speeds on smaller paper sizes may be slower. Plus, the machine may experience downtime or decrease the print speed in the middle of a continuous print run to adjust the temperature inside the machine or maintain the optimal print quality.

*³ May vary depending on the output environment.

Specifications for E-Mail Sending MF249dw / MF246dn

14L7-0CJ

Communication Protocol	SMTP, POP3*1
Data Format	PDF, PDF (Compact), JPEG, TIFF
Resolution	JPEG: 300 dpi TIFF (Black and White): 300 dpi (MMR Compression) TIFF (Color): 300 dpi (JPEG Compression) PDF (Black and White): 300 dpi (MMR Compression) PDF (Color): 200 dpi (JPEG Compression) PDF (Compact): Text 300 dpi, Background 150 dpi
System Environment	Windows Vista/7/8/10/Server 2008/Server 2012 Solaris Version 2.6 or later (with Samba 2.2 or later) Mac OS X Red Hat Linux 7.2 or later (with Samba 2.2 or later)
Interface	100BASE-TX, 10BASE-T, IEEE 802.11 b/g/n (Infrastructure mode)*2
Color Mode	Color, Black and White
Inputted Image	Text, Text/Photo, Photo
Paper Size	A4/A5/B5/LTR/LGL/STMT

*1 POP3 can also be used, though limited to when authenticating before sending.

*2 MF249dw only.

Specifications for Scanning to Shared Folders

MF249dw / MF246dn

14L7-0CK

Communication Protocol	SMB (TCP/IP)
Data Format	PDF, PDF (Compact), JPEG, TIFF
Resolution	JPEG: 300 dpi TIFF (Black and White): 300 dpi (MMR Compression) TIFF (Color): 300 dpi (JPEG Compression) PDF (Black and White): 300 dpi (MMR Compression) PDF (Color): 200 dpi (JPEG Compression) PDF (Compact): Text 300 dpi, Background 150 dpi
System Environment	Windows Vista/7/8/10/Server 2008/Server 2012 Solaris Version 2.6 or later (with Samba 2.2 or later) Mac OS X Red Hat Linux 7.2 or later (with Samba 2.2 or later)
Interface	100BASE-TX, 10BASE-T, IEEE 802.11 b/g/n (Infrastructure mode)*
Color Mode	Color, Black and White
Inputted Image	Text, Text/Photo, Photo
Paper Size	A4/A5/B5/LTR/LGL/STMT

* MF249dw only.

Consumables

14L7-0CL

The following is a guide to the estimated replacement time for the consumables used in this machine. Purchase consumables at your local authorized Canon dealer. Observe safety and health precautions when storing and handling consumables ([▶Consumables\(P. 10\)](#)).

For optimum print quality, using Canon genuine Toner, Cartridge and Parts is recommended.



NOTE

- Depending on the installation environment, printing paper size, or document type, you may need to replace consumables before the end of the estimated lifetime.
- Replacement toner cartridges are different from the supplied toner cartridges, so the yield may also differ.

■ Toner Cartridges

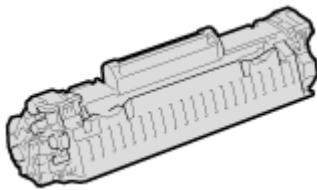

Supplied Toner Cartridges

The average yield* of the toner cartridge that comes with the machine is 1,700 sheets.

* The average yield is based on "ISO/IEC 19752" (the global standard related to "Method for the determination of toner cartridge yield for monochromatic electrophotographic printers and multi-function devices that contain printer components" issued by ISO [International Organization for Standardization]) when printing A4 size paper with the default print density setting.

Replacement Toner Cartridges

For optimum print quality, using Canon genuine toner cartridges is recommended.

Canon Genuine Toner Cartridge	Average yield of toner cartridge *
Canon Cartridge 337	2,400 sheets

NOTE

When replacing toner cartridges [▶How to Replace Toner Cartridges\(P. 602\)](#)



LINKS

[▶Replacing Toner Cartridges\(P. 597\)](#)

Manuals Included with the Machine

14L7-0CR

The manuals listed below are included with the machine. Refer to them as necessary.

Getting Started		Read this manual first. It describes basic setup procedures, from removing the packing materials to setting up the machine.
User's Guide (This Manual)		This manual describes all the functions of the machine in a manual that is viewed using a Web browser. You can browse information by category or enter a keyword to search for pages on a specific topic. Using User's Guide(P. 657)
Send Setting Guide (MF249dw / MF246dn)		This manual describes how to configure settings and prepare for sending scanned images by e-mail and saving scanned images to shared folders.

Using User's Guide

14L7-0CS

The User's Guide is a manual that can be viewed on your computer, smartphone, or other similar device.

How to Find the Topic You Are Looking for

You can find the page you are looking for using the following 2 methods.

Search the contents

You can find the page you are looking for by selecting the topic from [Contents] on the left side of the screen.

▶ **Top Page(P. 658)**

▶ **Topic Page(P. 660)**

Search by keyword

Perform a search by entering a keyword, such as "fax" or "wireless LAN", and the pages containing the keyword are displayed. You can find the page you are looking for from those results. You can also enter phrases such as "connecting to a network." The keyword search also supports the AND Boolean to search for multiple keywords.

▶ **Search(P. 660)**

NOTE

System Requirements

- If you do not have access to Adobe Reader to view the manuals in PDF format, try other programs such as PDF Preview developed by Vivid Document Imaging Technologies.

Screen Layout of User's Guide

14L7-0CX

The User's Guide is divided into different screens, and the content of each screen varies.

Top Page

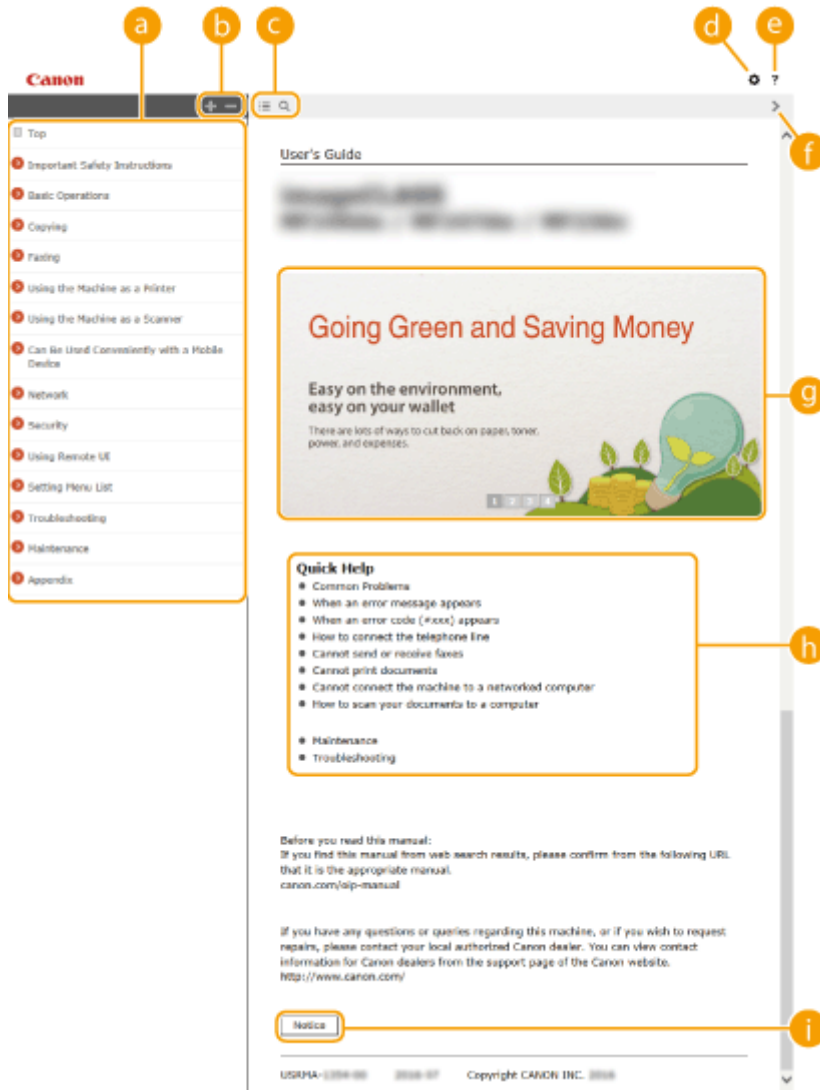

Appears when the User's Guide starts.



a Contents

The titles of chapters are displayed.

b

Click  to display all items, including those nested underneath other items. Click  to return to the original list.

c

Click to switch between the table of contents and the search display.



Click to specify settings such as text size, layout, and display method for the User's Guide.



Click to display information on how to view the User's Guide, how to perform a search, and other information.



Click to display the previous or following topic.

g Feature Highlights

Provides a variety of practical examples of ways to use the machine. Click **1** / **2** / **3** / **4** to toggle the display by category, or click the sliding display for more information about each category. The sliding display can be stopped by moving the pointer onto it. ▶ **Feature Highlights(P. 659)**

h [Quick Help]

Click to view how to solve problems.

i [Notice]

Click to view important information you should know when using the machine.

Feature Highlights

Provides a variety of practical examples of ways to use the machine.

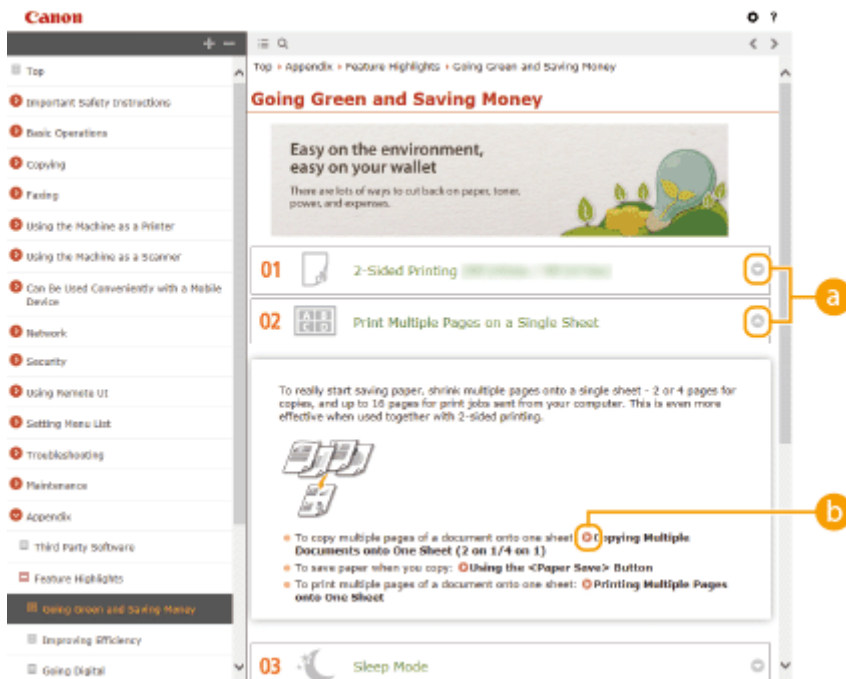

Click  to display the detailed information. Click  to close the window.



Click to display the corresponding topic page.

Topic Page

Contains information about how to configure and use the machine.

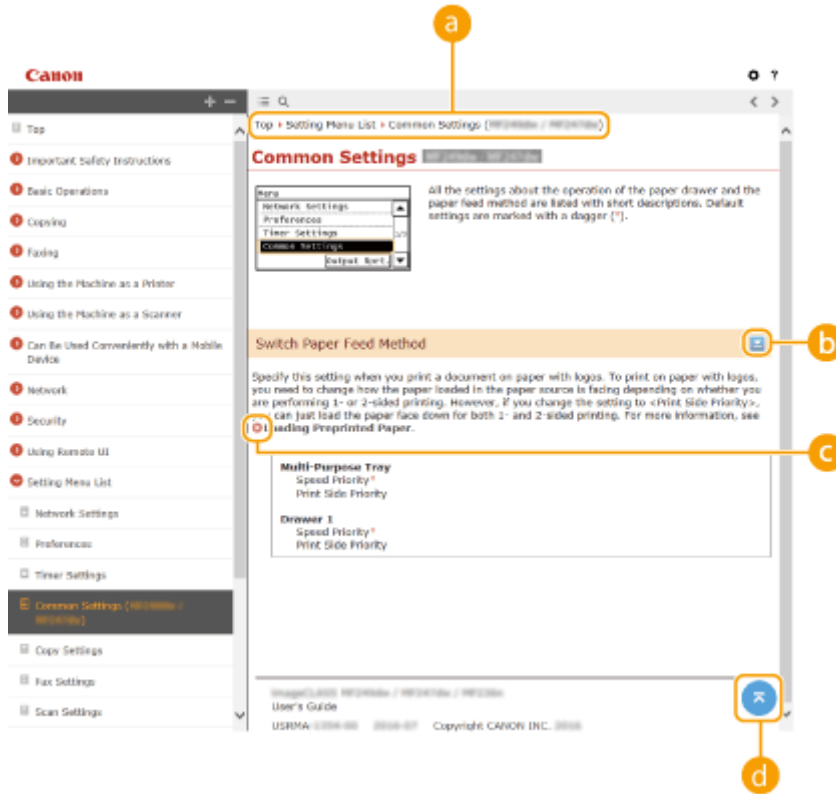

a Navigation

See what chapter topic you are currently viewing.



Click  to display the hidden detailed descriptions. Click  to close the detailed descriptions.



Click to go to the corresponding page. To return to the previous page, click "Back" on your Web browser.



Click to return to the page top.

Search

Click  to display the search screen. Contains a text box to perform a search by keyword and find the page you are looking for.

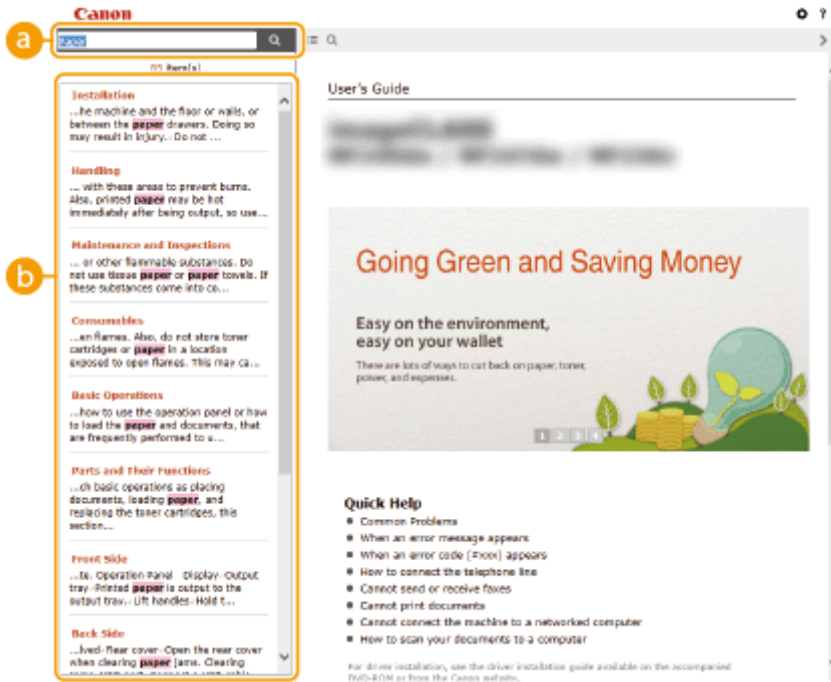

a [Enter keyword(s) here]

Enter a keyword or keywords and click  to display the search results. Search for pages containing all keywords by spacing keywords apart. Search for only pages with exact matches by enclosing keyword phrases in double quotation marks.

b Search result

Displays the search results of the pages that contain the specified keywords. From the results, locate the page you are looking for and click the topic title of the page.

NOTE:

- Specified keywords cover appear in bold in search results.

Viewing User's Guide

14L7-0CY

Marks

Cautions regarding safety, restrictions and cautions regarding the handling of the machine, useful tips, and other information are indicated using the marks below.



Indicates a warning concerning operations that may lead to death or injury to persons if not performed correctly. To use the machine safely, always pay attention to these warnings.

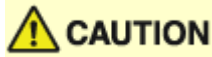

Indicates a caution concerning operations that may lead to injury to persons if not performed correctly. To use the machine safely, always pay attention to these cautions.



Indicates an operation that must not be performed. Read these items carefully, and make sure not to perform the described operations.

IMPORTANT

Indicates operational requirements and restrictions. Be sure to read these items carefully to operate the machine correctly, and avoid damage to the machine or property.

NOTE



Indicates a clarification of an operation, or contains additional explanations for a procedure.

TIPS

Indicates useful functions or tips for using the machine.

Keys and Buttons Used in this Manual

Keys on the operation panel and buttons on the computer display appear in the following notation:

Type	Example
Keys on the operation panel	 
Settings displayed on the operation panel	<Timer Settings> <Specify destination.>
Buttons and other text interfaces displayed on the computer display	[Preferences]

Screens Used in This Manual

Unless otherwise noted, displays used in the User's Guide are those for the MF249dw. Depending on the operating system you are using, the appearance of the displays used in this manual may slightly differ from the actual displays. Also, the appearance of drivers and software may differ depending on their version.

Illustrations Used in This Manual

Unless otherwise noted, illustrations used in the User's Guide are those for the MF249dw. When differences are significant, multiple illustrations are used with the model names, such as "MFXXXX / MFXXXX."

Others

14L7-0E1

This section describes basic Windows operations and includes disclaimers, copyright information, and other information.

Basic Windows Operations

14L7-0E2

- ▶ **Displaying the Printer Folder**(P. 664)
- ▶ **Enabling [Network discovery]**(P. 664)
- ▶ **Displaying Shared Printers in the Print Server**(P. 665)
- ▶ **Displaying the [Software Programs/Manuals Setup] Screen**(P. 665)
- ▶ **Printing a Test Page in Windows**(P. 666)
- ▶ **Checking the Bit Architecture**(P. 667)
- ▶ **Checking the Computer Name**(P. 668)
- ▶ **Checking the Printer Port**(P. 669)
- ▶ **Checking Bidirectional Communication**(P. 670)
- ▶ **Checking the SSID to Which Your Computer Is Connected**(P. 671)

■ Displaying the Printer Folder

Windows Vista

[Start] ▶ select [Control Panel] ▶ [Printer].

Windows 7/Server 2008 R2

[Start] ▶ select [Devices and Printers].

Windows 8/Server 2012

Right-click the lower-left corner of the screen ▶ select [Control Panel] ▶ [View devices and printers].

Windows 8.1/Server 2012 R2

Right-click [Start] ▶ select [Control Panel] ▶ [View devices and printers].

Windows 10

Right-click [] ▶ select [Control Panel] ▶ [Hardware and Sound] ▶ [Devices and printers].

Windows Server 2003

[Start] ▶ select [Printers and Faxes].

Windows Server 2008

[Start] ▶ select [Control Panel] ▶ double-click [Printers].

■ Enabling [Network discovery]

If you are using Windows Vista/7/8/10/Server 2008/Server 2012, enable [Network discovery] to view the computers on your network.

Windows Vista

[Start] ▶ select [Control Panel] ▶ [View network status and tasks] ▶ select [Turn on network discovery] under [Network discovery].

Windows 7/Server 2008 R2

[Start] ▶ select [Control Panel] ▶ [View network status and tasks] ▶ [Change advanced sharing settings] ▶ select [Turn on network discovery] under [Network discovery].

Windows 8/Server 2012

Right-click the lower-left corner of the screen ▶ select [Control Panel] ▶ [View network status and tasks] ▶ [Change advanced sharing settings] ▶ select [Turn on network discovery] under [Network discovery].

Windows 8.1/Server 2012 R2

Right-click [Start] ▶ select [Control Panel] ▶ [View network status and tasks] ▶ [Change advanced sharing settings] ▶ select [Turn on network discovery] under [Network discovery].

Windows 10

Right-click [] ▶ select [Control Panel] ▶ [View network status and tasks] ▶ [Change advanced sharing settings] ▶ select [Turn on network discovery] under [Network discovery].

Windows Server 2008

[Start] ▶ select [Control Panel] ▶ double-click [Network and Sharing Center] ▶ select [Turn on network discovery] under [Network discovery].

■ Displaying Shared Printers in the Print Server

1 Open Windows Explorer.

Windows Vista/7/Server 2003/Server 2008

[Start] ▶ select [All Programs] or [Programs] ▶ [Accessories] ▶ [Windows Explorer].

Windows 8/Server 2012

Right-click the lower-left corner of the screen ▶ select [File Explorer].

Windows 8.1/Server 2012 R2

Right-click [Start] ▶ select [File Explorer].

Windows 10

Click [] ▶ select [File Explorer].

2 Select [Network] or [My Network Places] in printer server.

- To view computers on the network, you may need to turn on network discovery or search the network for computers.

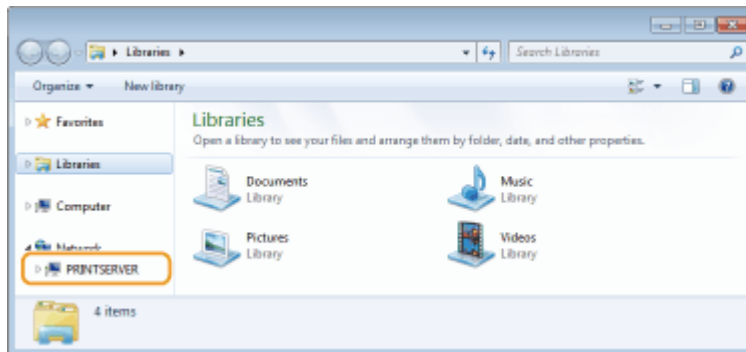

⇒ Shared printers are displayed.

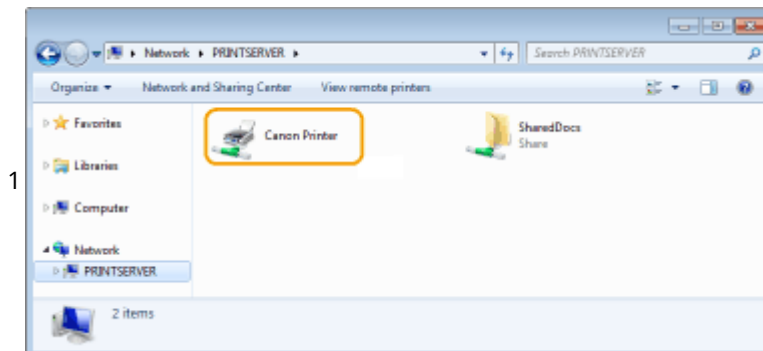

■ Displaying the [Software Programs/Manuals Setup] Screen

If your computer does not display the [Software Programs/Manuals Setup] screen after inserting the provided DVD-ROM, follow the procedure below. The DVD-ROM drive name is indicated as "D:" in this manual. The DVD-ROM drive name may differ depending on the computer you are using.

Windows Vista/7/Server 2008

[Start] ► enter "D:\MInst.exe" in [Search programs and files] or [Start Search] ► press the [ENTER] key.

Windows 8/Server 2012

Right-click the lower-left corner of the screen ► [Run] ► enter "D:\MInst.exe" ► click [OK]

Windows 8.1/Server 2012 R2

Right-click [Start] ► [Run] ► enter "D:\MInst.exe" ► click [OK]

Windows 10

Click [Search the web and Windows] ► enter "D:\MInst.exe" ► click "D:\MInst.exe" displayed in the search results

Windows Server 2003

[Start] ► [Run] ► enter "D:\MInst.exe" ► click [OK]

■ Printing a Test Page in Windows

You can check whether the printer driver is operational by printing a test page in Windows.

- 1 Load A4 size paper in the multi-purpose tray. ◀ Loading Paper in the Manual Feed Slot(P. 50)
- 2 Open the printer folder. ◀ Displaying the Printer Folder(P. 664)
- 3 Right-click the printer driver icon for this machine and click [Printer properties] or [Properties].

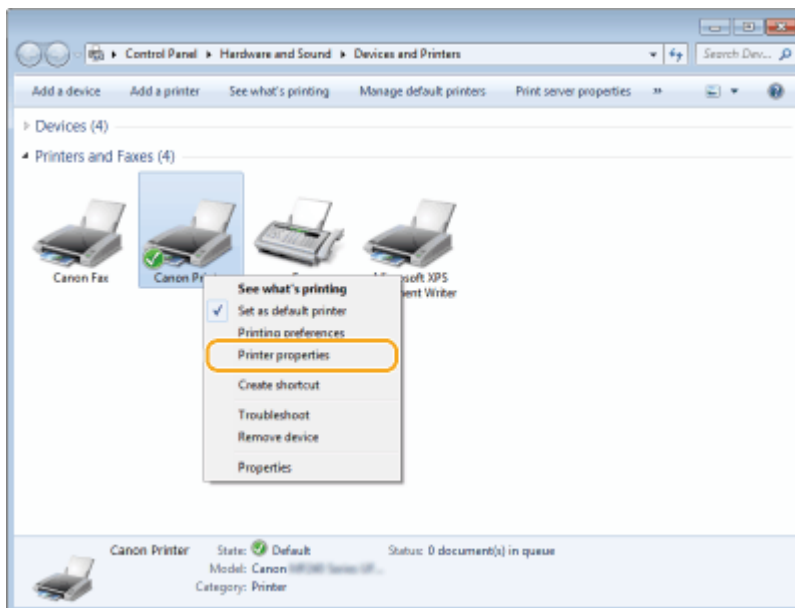

- 4 Click [Print Test Page] in [General] tab.

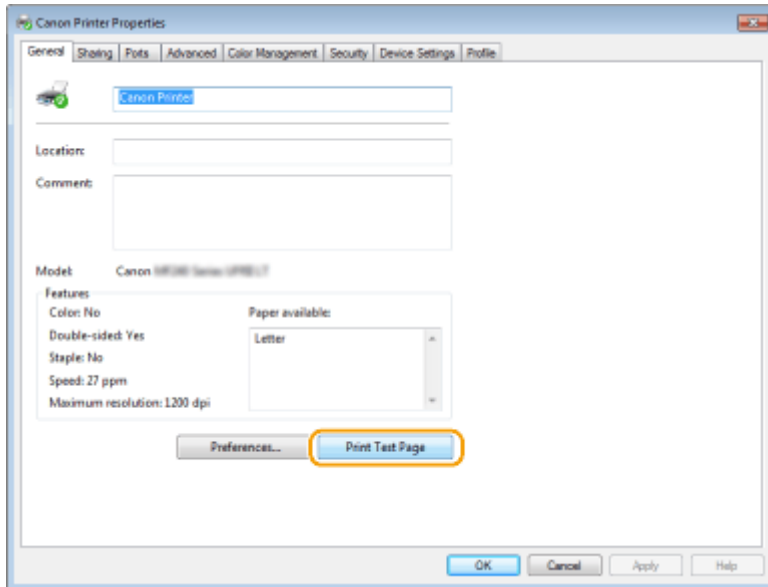

⇒ The test page is printed.

■ Checking the Bit Architecture

If you are not sure whether your computer is running 32-bit or 64-bit Windows follow the procedure below.

1 Display [Control Panel].

Windows Vista/7/Server 2008

[Start] ► select [Control Panel].

Windows 8/Server 2012

Right-click the lower-left corner of the screen ► select [Control Panel].

Windows 8.1/Server 2012 R2

Right-click [Start] ► select [Control Panel].

Windows 10

Proceed to step 2.

2 Display [System].

Windows Vista/7/8/Server 2008 R2/Server 2012

Click [System and Maintenance] or [System and Security] ► [System].

Windows 10

Click [] ► select [Settings] ► [System] ► [About].

Windows Server 2008

Double-click [System].

3 Check the bit architecture.

For 32-bit versions

[32-bit Operating System] is displayed.

For 64-bit versions

[64-bit Operating System] is displayed.

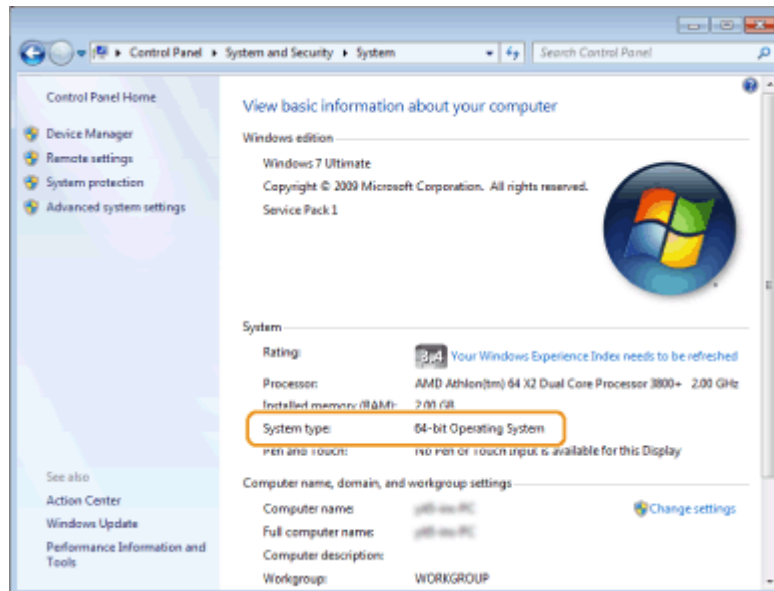

■ Checking the Computer Name

Windows Vista/7/8/10/Server 2008/Server 2012

- 1 Display [Control Panel].

Windows Vista/7/Server 2008
[Start] ► select [Control Panel].

Windows 8/Server 2012
Right-click the lower-left corner of the screen ► select [Control Panel].

Windows 8.1/Server 2012 R2
Right-click [Start] ► select [Control Panel].

Windows 10
Proceed to step 2.

- 2 Display [System].

Windows Vista/7/8/Server 2008 R2/Server 2012
Click [System and Maintenance] or [System and Security] ► [System].

Windows 10
Click [Windows Key] ► select [Settings] ► [System] ► [About].

Windows Server 2008
Double-click [System].

- 3 Check the computer name.

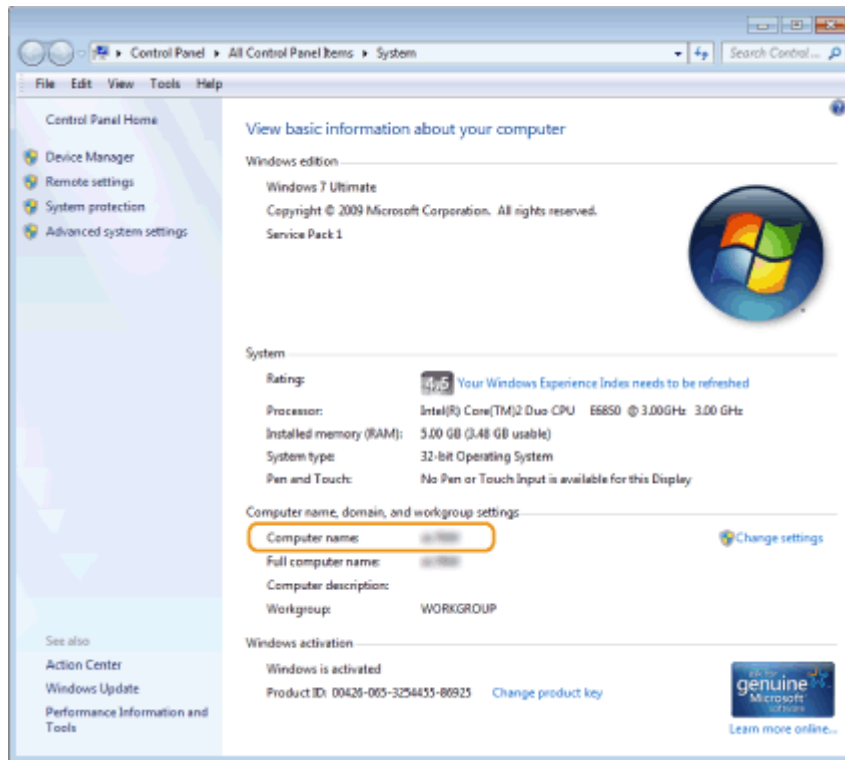

Windows Server 2003

- 1 [Start] ► select [Control Panel] ► [System].
- 2 Click [Change] in [Computer Name] tab.
- 3 Check the computer name.

■ Checking the Printer Port

- 1 Open the printer folder. ► Displaying the Printer Folder(P. 664)
- 2 Right-click the printer driver icon for this machine and click [Printer properties] or [Properties].

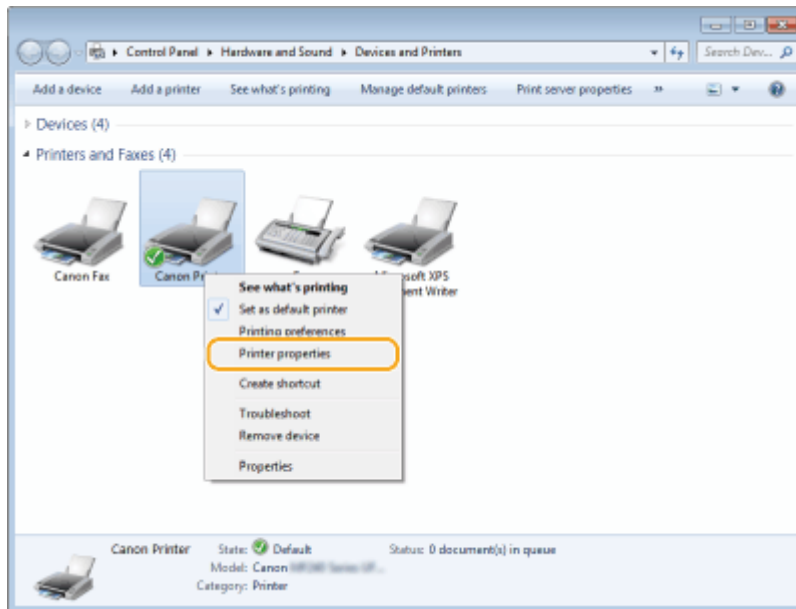

3 In the [Ports] tab, check that the port is selected correctly.

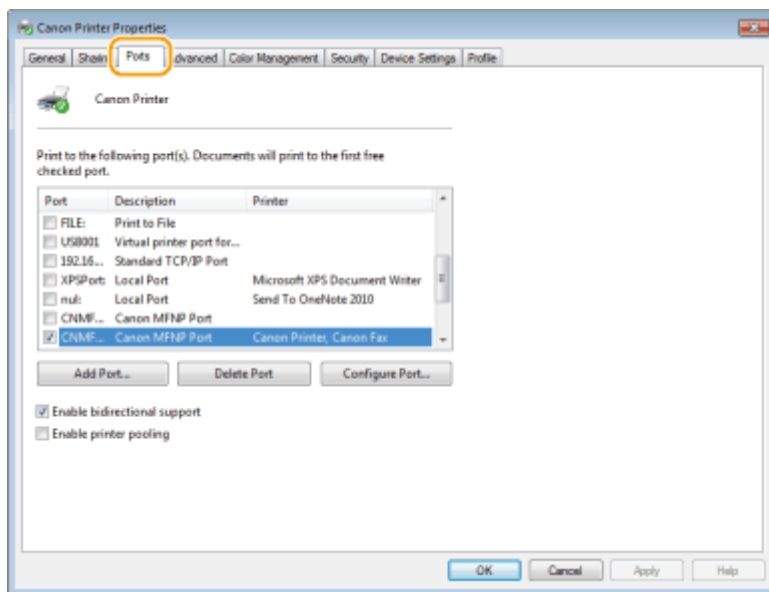

NOTE

If you are using a network connection and have changed the machine's IP address

- If [Description] for the selected port is [Canon MFNP Port], and the machine and the computer are on the same subnet, then the connection will be maintained. You do not need to add a new port. If it is [Standard TCP/IP Port], you need to add a new port. ▶ **Configuring Printer Ports(P. 351)**

■ Checking Bidirectional Communication

1 Open the printer folder. ▶ **Displaying the Printer Folder(P. 664)**

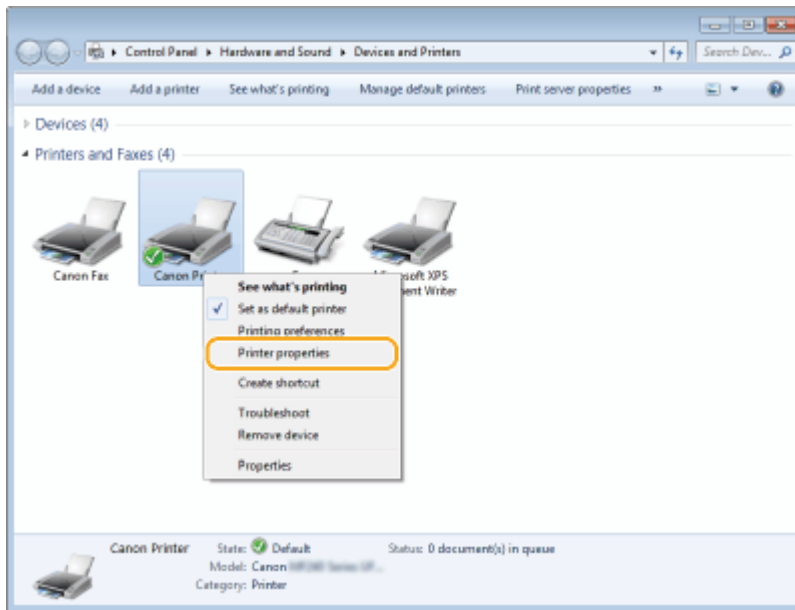

- 2** Right-click the printer driver icon for this machine and click [Printer properties] or [Properties].

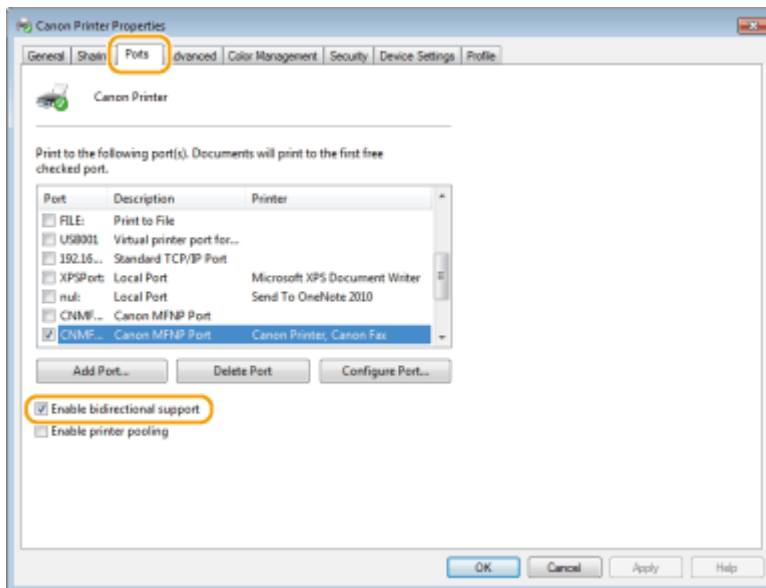

- 3** In the [Ports] tab, make sure that the [Enable bidirectional support] check box is selected.



■ Checking the SSID to Which Your Computer Is Connected

If your computer is connected to a wireless LAN network, click , , or  in the system tray to display the SSID of the connected wireless LAN router.

Appendix



Notice

14L7-0E3

■ IPv6 Ready Logo



The protocol stack included in this machine has obtained the IPv6 Ready Logo Phase-1 established by the IPv6 Forum.

■ E-Waste Rule

India only

This product is not to be disposed of with your household waste, according to the E-Waste (Management) Rules, 2016. This product should be handed over to a designated collection point, e.g., to an authorized collection site for recycling waste electrical and electronic equipment (EEE). Improper handling of this type of waste could have a possible negative impact on the environment and human health due to potentially hazardous substances that are generally associated with EEE. At the same time, your cooperation in the correct disposal of this product will contribute to the effective usage of natural resources. For more information regarding return and recycling of WEEE products, please visit <http://www.canon.co.in/environment> or write to us at customer.delight@canon.co.in.

Also, this product complies with the "E-Waste (Management) Rules, 2016" and prohibits use of lead, mercury, hexavalent chromium, polybrominated biphenyls or polybrominated diphenyl ethers in concentrations exceeding 0.1 % by weight and 0.01 % by weight for Cadmium, except for the exemptions set in Schedule II of the Rule.



■ Disclaimers

- The information in this document is subject to change without notice.
- CANON INC. MAKES NO WARRANTY OF ANY KIND WITH REGARD TO THIS MATERIAL, EITHER EXPRESS OR IMPLIED, EXCEPT AS PROVIDED HEREIN, INCLUDING WITHOUT LIMITATION, THEREOF, WARRANTIES AS TO MARKETABILITY, MERCHANTABILITY, FITNESS FOR A PARTICULAR PURPOSE OF USE, OR NON-INFRINGEMENT. CANON INC. SHALL NOT BE LIABLE FOR ANY DIRECT, INCIDENTAL, OR CONSEQUENTIAL DAMAGES OF ANY NATURE, OR LOSSES OR EXPENSES RESULTING FROM THE USE OF THIS MATERIAL.

■ Trademarks

Adobe, Acrobat, and Reader are registered trademarks of Adobe Systems Incorporated in the United States and/or other countries.

Apple, Bonjour, iPad, iPhone, iPod touch, Safari, Mac, Mac OS and OS X are trademarks of Apple Inc.

Microsoft, Windows, Windows Vista, Windows Server, Internet Explorer, Word and Excel are either registered trademarks or trademarks of Microsoft Corporation in the United States and/or other countries.

iOS is a trademark or registered trademark of Cisco in the U.S. and other countries and is used under license.

Google Cloud Print, Google Chrome and Android are either registered trademarks or trademarks of Google Inc.

Mopria®, the Mopria® Logo and the Mopria® Alliance logo are registered trademarks and service marks of Mopria Alliance, Inc. in the United States and other countries. Unauthorized use is strictly prohibited. This product contains the Universal Font Scaling Technology or UFST® under license from Monotype Imaging, Inc. UFST® is a trademark of Monotype Imaging, Inc. registered in the United States Patent and Trademark Office and may be registered in certain jurisdictions. UFST: Copyright © 1989 - 1996, 1997, 2003, 2004, 2008, all rights reserved, by Monotype Imaging Inc.



Adobe, PostScript, and the PostScript logo are either registered trademarks or trademarks of Adobe Systems Incorporated in the United States and/or other countries.

Copyright © 2007 -08 Adobe Systems Incorporated. All rights reserved.

Protected by U.S. Patents 5,737,599; 5,781,785; 5,819,301; 5,929,866; 5,943,063; 6,073,148; 6,515,763; 6,639,593; 6,754,382; 7,046,403; 7,213,269; 7,242,415; Patents pending in the U.S. and other countries.

All instances of the name PostScript in the text are references to the PostScript language as defined by Adobe Systems Incorporated unless otherwise stated. The name PostScript also is used as a product trademark for Adobe Systems' implementation of the PostScript language interpreter.

Except as otherwise stated, any reference to a "PostScript printing device," "PostScript display device," or similar item refers to a printing device, display device or item (respectively) that contains PostScript technology created or licensed by Adobe Systems Incorporated and not to devices or items that purport to be merely compatible with the PostScript language.

Adobe, the Adobe logo, PostScript, the PostScript logo, and PostScript 3 are either registered trademarks or trademarks of Adobe Systems Incorporated in the United States and/or other countries.

Linux is a registered trademark of Linus Torvalds. Microsoft and Windows are either registered trademarks or trademarks of Microsoft Corporation in the United States and/or other countries.

All other trademarks are the property of their respective owners.



The Adobe PDF logo is a trademark or registered trademark of Adobe Systems Incorporated in the United States and other countries.

Copyright © 2008 Adobe Systems Incorporated. All rights reserved.

Protected by U.S. Patents 6,185,684; 6,205,549; 7,213,269; 7,272,628; 7,278,168; Patents pending in the U.S. and other countries.

All instances of the name PostScript in the text are references to the PostScript language as defined by Adobe Systems Incorporated unless otherwise stated. The name PostScript also is used as a product trademark for Adobe Systems' implementation of the PostScript language interpreter.

Except as otherwise stated, any reference to a "PostScript printing device," "PostScript display device," or similar item refers to a printing device, display device or item (respectively) that contains PostScript technology created or licensed by Adobe Systems Incorporated and not to devices or items that purport to be merely compatible with the PostScript language.

Adobe, the Adobe logo, Adobe LiveCycle® Policy Server, PostScript, the PostScript Logo, and PostScript 3 are either registered trademarks or trademarks of Adobe Systems Incorporated in the United States and/or other countries.

All other trademarks are the property of their respective owners.

Portions of this software are copyright © 2007 The FreeType Project (www.freetype.org). All rights reserved.

All other product and brand names are registered trademarks, trademarks or service marks of their respective owners.

■ Copyright

Reproduction of the contents of this document in whole or in part without prior permission is prohibited.

This Font Software is licensed under the SIL Open Font License, Version 1.1.

This license is copied below, and is also available with a FAQ at: <http://scripts.sil.org/OFL>

SIL OPEN FONT LICENSE Version 1.1 - 26 February 2007

PREAMBLE

The goals of the Open Font License (OFL) are to stimulate worldwide development of collaborative font projects, to support the font creation efforts of academic and linguistic communities, and to provide a free and open framework in which fonts may be shared and improved in partnership with others.

The OFL allows the licensed fonts to be used, studied, modified and redistributed freely as long as they are not sold by themselves. The fonts, including any derivative works, can be bundled, embedded, redistributed and/or sold with any software provided that any reserved names are not used by derivative works. The fonts and derivatives, however, cannot be released under any other type of license. The requirement for fonts to remain under this license does not apply to any document created using the fonts or their derivatives.

DEFINITIONS

"Font Software" refers to the set of files released by the Copyright Holder(s) under this license and clearly marked as such. This may include source files, build scripts and documentation.

"Reserved Font Name" refers to any names specified as such after the copyright statement(s).

"Original Version" refers to the collection of Font Software components as distributed by the Copyright Holder(s).

"Modified Version" refers to any derivative made by adding to, deleting, or substituting -- in part or in whole -- any of the components of the Original Version, by changing formats or by porting the Font Software to a new environment.

"Author" refers to any designer, engineer, programmer, technical writer or other person who contributed to the Font Software.

PERMISSION & CONDITIONS

Permission is hereby granted, free of charge, to any person obtaining a copy of the Font Software, to use, study, copy, merge, embed, modify, redistribute, and sell modified and unmodified copies of the Font Software, subject to the following conditions:

- 1) Neither the Font Software nor any of its individual components, in Original or Modified Versions, may be sold by itself.
- 2) Original or Modified Versions of the Font Software may be bundled, redistributed and/or sold with any software, provided that each copy contains the above copyright notice and this license. These can be included either as stand-alone text files, human-readable headers or in the appropriate machine-readable metadata fields within text or binary files as long as those fields can be easily viewed by the user.
- 3) No Modified Version of the Font Software may use the Reserved Font Name(s) unless explicit written permission is granted by the corresponding Copyright Holder. This restriction only applies to the primary font name as presented to the users.
- 4) The name(s) of the Copyright Holder(s) or the Author(s) of the Font Software shall not be used to promote, endorse or advertise any Modified Version, except to acknowledge the contribution(s) of the Copyright Holder(s) and the Author(s) or with their explicit written permission.
- 5) The Font Software, modified or unmodified, in part or in whole, must be distributed entirely under this license, and must not be distributed under any other license. The requirement for fonts to remain under this license does not apply to any document created using the Font Software.

TERMINATION

This license becomes null and void if any of the above conditions are not met.

DISCLAIMER

THE FONT SOFTWARE IS PROVIDED "AS IS", WITHOUT WARRANTY OF ANY KIND, EXPRESS OR IMPLIED, INCLUDING BUT NOT LIMITED TO ANY WARRANTIES OF MERCHANTABILITY, FITNESS FOR A PARTICULAR PURPOSE AND NONINFRINGEMENT OF COPYRIGHT, PATENT, TRADEMARK, OR OTHER RIGHT. IN NO EVENT SHALL THE COPYRIGHT HOLDER BE LIABLE FOR ANY CLAIM, DAMAGES OR OTHER LIABILITY, INCLUDING ANY GENERAL, SPECIAL, INDIRECT, INCIDENTAL, OR CONSEQUENTIAL DAMAGES, WHETHER IN AN ACTION OF CONTRACT, TORT OR OTHERWISE, ARISING FROM, OUT OF THE USE OR INABILITY TO USE THE FONT SOFTWARE OR FROM OTHER DEALINGS IN THE FONT SOFTWARE.

The Software Subjected to the Other License Conditions

Please refer to Table of Software and respective License terms below, for more detail and corresponding license conditions.

Table of Software

Names of Software	Terms and Conditions of the License: See Page
Adobe PDF Scan Library	2
bldimake	5
FreeType	6
snmp	11
Incl	14
JPEG	15
math	16
mDNSResponder	17
mDNSResponder (part of mDNSShared)	21
OpenSSL	22
xpm	26

Portions use software under the following terms:

This product contains either BSAFE and/or TIPEM software by RSA Security Inc.

This product includes software developed by the Apache Software Foundation (<http://www.apache.org/>).
Copyright (c) 1998-2000 The Apache Software Foundation. All rights reserved.

Redistribution and use in source and binary forms, with or without modification, are permitted provided that the following conditions are met:

1. Redistributions of source code must retain the above copyright notice, this list of conditions and the following disclaimer.
2. Redistributions in binary form must reproduce the above copyright notice, this list of conditions and the following disclaimer in the documentation and/or other materials provided with the distribution.
3. The end-user documentation included with the redistribution, if any, must include the following acknowledgment:

"This product includes software developed by the Apache Software Foundation (<http://www.apache.org/>)."

Alternately, this acknowledgment may appear in the software itself, if and wherever such third-party acknowledgments normally appear.

4. The names "Xerces" and "Apache Software Foundation" must not be used to endorse or promote products derived from this software without prior written permission. For written permission, please contact apache@apache.org.
5. Products derived from this software may not be called "Apache", nor may "Apache" appear in their name, without prior written permission of the Apache Software Foundation.

THIS SOFTWARE IS PROVIDED ``AS IS" AND ANY EXPRESSED OR IMPLIED WARRANTIES, INCLUDING, BUT NOT LIMITED TO, THE IMPLIED WARRANTIES OF MERCHANTABILITY AND FITNESS FOR A PARTICULAR PURPOSE ARE DISCLAIMED. IN NO EVENT SHALL THE APACHE SOFTWARE FOUNDATION OR ITS CONTRIBUTORS BE LIABLE FOR ANY DIRECT, INDIRECT, INCIDENTAL, SPECIAL, EXEMPLARY, OR CONSEQUENTIAL DAMAGES (INCLUDING, BUT NOT LIMITED TO, PROCUREMENT OF SUBSTITUTE GOODS OR SERVICES; LOSS OF USE, DATA, OR PROFITS; OR BUSINESS INTERRUPTION) HOWEVER CAUSED AND ON ANY THEORY OF LIABILITY, WHETHER IN CONTRACT, STRICT LIABILITY, OR TORT (INCLUDING NEGLIGENCE OR OTHERWISE) ARISING IN ANY WAY OUT OF THE USE OF THIS SOFTWARE, EVEN IF ADVISED OF THE POSSIBILITY OF SUCH DAMAGE.

This software consists of voluntary contributions made by many individuals on behalf of the Apache Software Foundation and was originally based on software copyright (c) 1999, International Business Machines, Inc., <http://www.ibm.com>. For more information on the Apache Software Foundation, please see <http://www.apache.org/>.

March 27, 2003

Portions of this product are based on Modifications created from the Original Code known as the "Sablotron XSLT Processor". The Sablotron XSLT Processor is subject to the Mozilla Public License Version 1.1 (the "License"). You may obtain a copy of the License at <http://www.mozilla.org/MPL/>

Software distributed under the License is distributed on an "AS IS" basis, WITHOUT WARRANTY OF ANY KIND, either express or implied. See the License for the specific language governing rights and limitations under the License.

The Original Code is the Sablotron XSLT Processor.

The Initial Developer of the Original Code is Ginger Alliance Ltd. Portions created by Ginger Alliance are Copyright (C) 2000 Ginger Alliance Ltd. All Rights Reserved.

Pursuant to sections 3.2 and 3.6 of the License, the Modifications created by Adobe Systems Incorporated are available as Source Code. The Modifications may be downloaded via the Internet from:

<http://partners.adobe.com/asn/tech/xml/sablotron/index.jsp>

The Original Code may be downloaded via the Internet from:

<https://sourceforge.net/projects/sablotron/>

Portions Copyright (c) 1997-1999 Silicon Graphics Computer Systems, Inc.

Permission to use, copy, modify, distribute and sell this software and its documentation for any purpose is hereby granted without fee, provided that the above copyright notice appear in all copies and that both that copyright notice and this permission notice appear in supporting documentation. Silicon Graphics makes no representations about the suitability of this software for any purpose. It is provided "as is" without express or implied warranty.

The Loki Library

Portions Copyright (c) 2001 by Andrei Alexandrescu . This code accompanies the book: Alexandrescu, Andrei. "Modern C++ Design: Generic Programming and Design Patterns Applied".

Portions Copyright (c) 2001. Addison-Wesley. Permission to use, copy, modify, distribute and sell this software for any purpose is hereby granted without fee, provided that the above copyright notice appear in all copies and that both that copyright notice and this permission notice appear in supporting documentation. The author or Addison-Wesley Longman make no representations about the suitability of this software for any purpose. It is provided "as is" without express or implied warranty.

Updated Information/Additional Third Party Code Information available at <http://www.adobe.com/go/thirdparty> .

bldimake

Copyright (c) 1985, 1986, 1987, 1988 The Open Group

All right Reserved.

Permission to use, copy, modify, distribute, and sell this software and its documentation for any purpose is hereby granted without fee, provided that the above copyright notice appear in all copies and that both that copyright notice and this permission notice appear in supporting documentation. The above copyright notice and this permission notice shall be included in all copies or substantial portions of the Software.

THE SOFTWARE IS PROVIDED "AS IS", WITHOUT WARRANTY OF ANY KIND, EXPRESS OR IMPLIED, INCLUDING BUT NOT LIMITED TO THE WARRANTIES OF MERCHANTABILITY, FITNESS FOR A PARTICULAR PURPOSE AND NONINFRINGEMENT. IN NO EVENT SHALL THE OPEN GROUP BE LIABLE FOR ANY CLAIM, DAMAGES OR OTHER LIABILITY, WHETHER IN AN ACTION OF CONTRACT, TORT OR OTHERWISE, ARISING FROM, OUT OF OR IN CONNECTION WITH THE SOFTWARE OR THE USE OR OTHER DEALINGS IN THE SOFTWARE.

Except as contained in this notice, the name of The Open Group shall not be used in advertising or otherwise to promote the sale, use or other dealings in this Software without prior written authorization from The Open Group.

FreeType

The FreeType Project LICENSE

2006-Jan-27

Copyright 1996-2002, 2006 by
David Turner, Robert Wilhelm, and Werner Lemberg

Introduction

=====

The FreeType Project is distributed in several archive packages; some of them may contain, in addition to the FreeType font engine, various tools and contributions which rely on, or relate to, the FreeType Project.

This license applies to all files found in such packages, and which do not fall under their own explicit license. The license affects thus the FreeType font engine, the test programs, documentation and makefiles, at the very least.

This license was inspired by the BSD, Artistic, and IJG (Independent JPEG Group) licenses, which all encourage inclusion and use of free software in commercial and freeware products alike. As a consequence, its main points are that:

- o We don't promise that this software works. However, we will be interested in any kind of bug reports. ('as is' distribution)
- o You can use this software for whatever you want, in parts or full form, without having to pay us. ('royalty-free' usage)
- o You may not pretend that you wrote this software. If you use it, or only parts of it, in a program, you must acknowledge

somewhere in your documentation that you have used the FreeType code. ('credits')

We specifically permit and encourage the inclusion of this software, with or without modifications, in commercial products. We disclaim all warranties covering The FreeType Project and assume no liability related to The FreeType Project.

Finally, many people asked us for a preferred form for a credit/disclaimer to use in compliance with this license. We thus encourage you to use the following text:

Portions of this software are copyright © <year> The FreeType Project (www.freetype.org). All rights reserved.

Please replace <year> with the value from the FreeType version you actually use.

Legal Terms

=====

0. Definitions

Throughout this license, the terms `package', `FreeType Project', and `FreeType archive' refer to the set of files originally distributed by the authors (David Turner, Robert Wilhelm, and Werner Lemberg) as the `FreeType Project', be they named as alpha, beta or final release.

`You' refers to the licensee, or person using the project, where `using' is a generic term including compiling the project's source code as well as linking it to form a `program' or `executable'. This program is referred to as `a program using the FreeType

engine'.

This license applies to all files distributed in the original FreeType Project, including all source code, binaries and documentation, unless otherwise stated in the file in its original, unmodified form as distributed in the original archive. If you are unsure whether or not a particular file is covered by this license, you must contact us to verify this.

The FreeType Project is copyright (C) 1996-2000 by David Turner, Robert Wilhelm, and Werner Lemberg. All rights reserved except as specified below.

1. No Warranty

THE FREETYPE PROJECT IS PROVIDED 'AS IS' WITHOUT WARRANTY OF ANY KIND, EITHER EXPRESS OR IMPLIED, INCLUDING, BUT NOT LIMITED TO, WARRANTIES OF MERCHANTABILITY AND FITNESS FOR A PARTICULAR PURPOSE. IN NO EVENT WILL ANY OF THE AUTHORS OR COPYRIGHT HOLDERS BE LIABLE FOR ANY DAMAGES CAUSED BY THE USE OR THE INABILITY TO USE, OF THE FREETYPE PROJECT.

2. Redistribution

This license grants a worldwide, royalty-free, perpetual and irrevocable right and license to use, execute, perform, compile, display, copy, create derivative works of, distribute and sublicense the FreeType Project (in both source and object code forms) and derivative works thereof for any purpose; and to authorize others to exercise some or all of the rights granted herein, subject to the following conditions:

- o Redistribution of source code must retain this license file ('FTL.TXT') unaltered; any additions, deletions or changes to the original files must be clearly indicated in accompanying documentation. The copyright notices of the unaltered,

original files must be preserved in all copies of source files.

- o Redistribution in binary form must provide a disclaimer that states that the software is based in part of the work of the FreeType Team, in the distribution documentation. We also encourage you to put an URL to the FreeType web page in your documentation, though this isn't mandatory.

These conditions apply to any software derived from or based on the FreeType Project, not just the unmodified files. If you use our work, you must acknowledge us. However, no fee need be paid to us.

3. Advertising

Neither the FreeType authors and contributors nor you shall use the name of the other for commercial, advertising, or promotional purposes without specific prior written permission.

We suggest, but do not require, that you use one or more of the following phrases to refer to this software in your documentation or advertising materials: 'FreeType Project', 'FreeType Engine', 'FreeType library', or 'FreeType Distribution'.

As you have not signed this license, you are not required to accept it. However, as the FreeType Project is copyrighted material, only this license, or another one contracted with the authors, grants you the right to use, distribute, and modify it. Therefore, by using, distributing, or modifying the FreeType Project, you indicate that you understand and accept all the terms of this license.

4. Contacts

There are two mailing lists related to FreeType:

o freetype@nongnu.org

Discusses general use and applications of FreeType, as well as future and wanted additions to the library and distribution.

If you are looking for support, start in this list if you haven't found anything to help you in the documentation.

o freetype-devel@nongnu.org

Discusses bugs, as well as engine internals, design issues, specific licenses, porting, etc.

Our home page can be found at

<http://www.freetype.org>

--- end of FTL.TXT ---

snmp

Copyright 1988, 1989 by Carnegie Mellon University

All Rights Reserved

Permission to use, copy, modify, and distribute this software and its documentation for any purpose and without fee is hereby granted, provided that the above copyright notice appear in all copies and that both that copyright notice and this permission notice appear in supporting documentation, and that the name of CMU not be used in advertising or publicity pertaining to distribution of the software without specific, written prior permission.

CMU DISCLAIMS ALL WARRANTIES WITH REGARD TO THIS SOFTWARE, INCLUDING ALL IMPLIED WARRANTIES OF MERCHANTABILITY AND FITNESS, IN NO EVENT SHALL CMU BE LIABLE FOR ANY SPECIAL, INDIRECT OR CONSEQUENTIAL DAMAGES OR ANY DAMAGES WHATSOEVER RESULTING FROM LOSS OF USE, DATA OR PROFITS, WHETHER IN AN ACTION OF CONTRACT, NEGLIGENCE OR OTHER TORTIOUS ACTION, ARISING OUT OF OR IN CONNECTION WITH THE USE OR PERFORMANCE OF THIS SOFTWARE.

/* Copyright (C) 1995-1998 Eric Young (eay@cryptsoft.com)

* All rights reserved.

*

* This package is an SSL implementation written

* by Eric Young (eay@cryptsoft.com).

* The implementation was written so as to conform with Netscapes SSL.

*

* This library is free for commercial and non-commercial use as long as

* the following conditions are adhered to. The following conditions

* apply to all code found in this distribution, be it the RC4, RSA,

* lhash, DES, etc., code; not just the SSL code. The SSL documentation

* included with this distribution is covered by the same copyright terms

* except that the holder is Tim Hudson (tjh@cryptsoft.com).

*

* Copyright remains Eric Young's, and as such any Copyright notices in

- * the code are not to be removed.
- * If this package is used in a product, Eric Young should be given attribution
- * as the author of the parts of the library used.
- * This can be in the form of a textual message at program startup or
- * in documentation (online or textual) provided with the package.
- *
- * Redistribution and use in source and binary forms, with or without
- * modification, are permitted provided that the following conditions
- * are met:
- * 1. Redistributions of source code must retain the copyright
- * notice, this list of conditions and the following disclaimer.
- * 2. Redistributions in binary form must reproduce the above copyright
- * notice, this list of conditions and the following disclaimer in the
- * documentation and/or other materials provided with the distribution.
- * 3. All advertising materials mentioning features or use of this software
- * must display the following acknowledgement:
- * "This product includes cryptographic software written by
- * Eric Young (eay@cryptsoft.com)"
- * The word 'cryptographic' can be left out if the rouines from the library
- * being used are not cryptographic related :-).
- * 4. If you include any Windows specific code (or a derivative thereof) from
- * the apps directory (application code) you must include an acknowledgement:
- * "This product includes software written by Tim Hudson (tjh@cryptsoft.com)"
- *
- * THIS SOFTWARE IS PROVIDED BY ERIC YOUNG ``AS IS" AND
- * ANY EXPRESS OR IMPLIED WARRANTIES, INCLUDING, BUT NOT LIMITED TO, THE
- * IMPLIED WARRANTIES OF MERCHANTABILITY AND FITNESS FOR A PARTICULAR PURPOSE
- * ARE DISCLAIMED. IN NO EVENT SHALL THE AUTHOR OR CONTRIBUTORS BE LIABLE
- * FOR ANY DIRECT, INDIRECT, INCIDENTAL, SPECIAL, EXEMPLARY, OR CONSEQUENTIAL
- * DAMAGES (INCLUDING, BUT NOT LIMITED TO, PROCUREMENT OF SUBSTITUTE GOODS
- * OR SERVICES; LOSS OF USE, DATA, OR PROFITS; OR BUSINESS INTERRUPTION)
- * HOWEVER CAUSED AND ON ANY THEORY OF LIABILITY, WHETHER IN CONTRACT, STRICT
- * LIABILITY, OR TORT (INCLUDING NEGLIGENCE OR OTHERWISE) ARISING IN ANY WAY
- * OUT OF THE USE OF THIS SOFTWARE, EVEN IF ADVISED OF THE POSSIBILITY OF
- * SUCH DAMAGE.
- *
- * The licence and distribution terms for any publically available version or
- * derivative of this code cannot be changed. i.e. this code cannot simply be

* copied and put under another distribution licence

* [including the GNU Public Licence.]

*/

Copyright 1988, 1989 by Carnegie Mellon University

Copyright 1989 TGV, Incorporated

All Rights Reserved

Permission to use, copy, modify, and distribute this software and its documentation for any purpose and without fee is hereby granted, provided that the above copyright notice appear in all copies and that both that copyright notice and this permission notice appear in supporting documentation, and that the name of CMU and TGV not be used in advertising or publicity pertaining to distribution of the software without specific, written prior permission.

CMU AND TGV DISCLAIMS ALL WARRANTIES WITH REGARD TO THIS SOFTWARE, INCLUDING ALL IMPLIED WARRANTIES OF MERCHANTABILITY AND FITNESS, IN NO EVENT SHALL CMU OR TGV BE LIABLE FOR ANY SPECIAL, INDIRECT OR CONSEQUENTIAL DAMAGES OR ANY DAMAGES WHATSOEVER RESULTING FROM LOSS OF USE, DATA OR PROFITS, WHETHER IN AN ACTION OF CONTRACT, NEGLIGENCE OR OTHER TORTIOUS ACTION, ARISING OUT OF OR IN CONNECTION WITH THE USE OR PERFORMANCE OF THIS SOFTWARE.

Incl

Copyright (c) 1994-96 SunSoft, Inc.

Permission is hereby granted, free of charge, to any person obtaining a copy of this software and associated documentation files (the "Software"), to deal in the Software without restriction, including without limitation the rights to use, copy, modify, merge, publish, distribute, sublicense, and/or sell copies of the Software, and to permit persons to whom the Software is furnished to do so, subject to the following conditions:

The above copyright notice and this permission notice shall be included in all copies or substantial portions of the Software.

THE SOFTWARE IS PROVIDED "AS IS", WITHOUT WARRANTY OF ANY KIND, EXPRESS OR IMPLIED, INCLUDING BUT NOT LIMITED TO THE WARRANTIES OF MERCHANTABILITY, FITNESS FOR A PARTICULAR PURPOSE AND NONINFRINGEMENT. IN NO EVENT SHALL SUNSOFT INC. OR ITS PARENT COMPANY BE LIABLE FOR ANY CLAIM, DAMAGES OR OTHER LIABILITY, WHETHER IN AN ACTION OF CONTRACT, TORT OR OTHERWISE, ARISING FROM, OUT OF OR IN CONNECTION WITH THE SOFTWARE OR THE USE OR OTHER DEALINGS IN THE SOFTWARE.

Except as contained in this notice, the name of SunSoft, Inc. shall not be used in advertising or otherwise to promote the sale, use or other dealings in this Software without prior written authorization from SunSoft, Inc.

JPEG

"this software is based in part on the work of the Independent JPEG Group."

math

Copyright (c) 1993 by Sun Microsystems, Inc. All rights reserved.

Developed at SunPro, a Sun Microsystems, Inc. business.

Permission to use, copy, modify, and distribute this software is freely granted, provided that this notice is preserved.

copysignf.c:* Copyright (c) 1993 by Sun Microsystems, Inc. All rights reserved.

math_private.h:* Copyright (c) 1993 by Sun Microsystems, Inc. All rights reserved.

powf.c:* Copyright (c) 1993 by Sun Microsystems, Inc. All rights reserved.

scalbnf.c:* Copyright (c) 1993 by Sun Microsystems, Inc. All rights reserved.

Apache License

Version 2.0, January 2004

<http://www.apache.org/licenses/>

TERMS AND CONDITIONS FOR USE, REPRODUCTION, AND DISTRIBUTION

1. Definitions.

"License" shall mean the terms and conditions for use, reproduction, and distribution as defined by Sections 1 through 9 of this document.

"Licensor" shall mean the copyright owner or entity authorized by the copyright owner that is granting the License.

"Legal Entity" shall mean the union of the acting entity and all other entities that control, are controlled by, or are under common control with that entity. For the purposes of this definition, "control" means (i) the power, direct or indirect, to cause the direction or management of such entity, whether by contract or otherwise, or (ii) ownership of fifty percent (50%) or more of the outstanding shares, or (iii) beneficial ownership of such entity.

"You" (or "Your") shall mean an individual or Legal Entity exercising permissions granted by this License.

"Source" form shall mean the preferred form for making modifications, including but not limited to software source code, documentation source, and configuration files.

"Object" form shall mean any form resulting from mechanical transformation or translation of a Source form, including but not limited to compiled object code, generated documentation, and conversions to other media types.

"Work" shall mean the work of authorship, whether in Source or Object form, made available under the License, as indicated by a copyright notice that is included in or attached to the work (an example is provided in the Appendix below).

"Derivative Works" shall mean any work, whether in Source or Object form, that is based on (or derived from) the Work and for which the editorial revisions, annotations, elaborations, or other modifications represent, as a whole, an original work of authorship. For the purposes of this License, Derivative Works shall not include works that remain separable from, or merely link (or bind by name) to the interfaces of, the Work and Derivative Works thereof.

"Contribution" shall mean any work of authorship, including the original version of the Work and any modifications or additions to that Work or Derivative Works thereof, that is intentionally submitted to Licensor for inclusion in the Work by the copyright owner or by an individual or Legal Entity authorized to submit on behalf of the copyright owner. For the purposes of this definition, "submitted" means any form of electronic, verbal, or written communication sent to the Licensor or its representatives, including but not limited to communication on electronic mailing lists, source code control systems, and issue tracking systems that are managed by, or on behalf of, the Licensor for the purpose of discussing and improving the Work, but excluding communication that is conspicuously marked or otherwise designated in writing by the copyright owner as "Not a Contribution."

"Contributor" shall mean Licensor and any individual or Legal Entity on behalf of whom a Contribution has been received by Licensor and subsequently incorporated within the Work.

2. Grant of Copyright License. Subject to the terms and conditions of this License, each Contributor hereby grants to You a perpetual, worldwide, non-exclusive, no-charge, royalty-free, irrevocable copyright license to reproduce, prepare Derivative Works of, publicly display, publicly perform, sublicense, and distribute the Work and such Derivative Works in Source or Object form.

3. Grant of Patent License. Subject to the terms and conditions of this License, each Contributor hereby grants to You a perpetual, worldwide, non-exclusive, no-charge, royalty-free, irrevocable (except as stated in this section) patent license to make, have made, use, offer to sell, sell, import, and otherwise transfer the Work, where such license applies only to those patent claims licensable by such Contributor that are necessarily infringed by their Contribution(s) alone or by combination of their Contribution(s) with the Work to which such Contribution(s) was submitted. If You institute patent litigation against any entity (including a cross-claim or counterclaim in a lawsuit) alleging that the Work or a Contribution incorporated within the Work constitutes direct or contributory patent infringement, then any patent licenses granted to You under this License for that Work shall terminate as of the date such litigation is filed.

4. Redistribution. You may reproduce and distribute copies of the Work or Derivative Works thereof in any medium, with or without modifications, and in Source or Object form, provided that You meet the following conditions:

- a. You must give any other recipients of the Work or Derivative Works a copy of this License; and
- b. You must cause any modified files to carry prominent notices stating that You changed the files; and
- c. You must retain, in the Source form of any Derivative Works that You distribute, all copyright, patent, trademark, and attribution notices from the Source form of the Work, excluding those notices that do not pertain to any part of the Derivative Works; and

- d. If the Work includes a "NOTICE" text file as part of its distribution, then any Derivative Works that You distribute must include a readable copy of the attribution notices contained within such NOTICE file, excluding those notices that do not pertain to any part of the Derivative Works, in at least one of the following places: within a NOTICE text file distributed as part of the Derivative Works; within the Source form or documentation, if provided along with the Derivative Works; or, within a display generated by the Derivative Works, if and wherever such third-party notices normally appear. The contents of the NOTICE file are for informational purposes only and do not modify the License. You may add Your own attribution notices within Derivative Works that You distribute, alongside or as an addendum to the NOTICE text from the Work, provided that such additional attribution notices cannot be construed as modifying the License.

You may add Your own copyright statement to Your modifications and may provide additional or different license terms and conditions for use, reproduction, or distribution of Your modifications, or for any such Derivative Works as a whole, provided Your use, reproduction, and distribution of the Work otherwise complies with the conditions stated in this License.

5. Submission of Contributions. Unless You explicitly state otherwise, any Contribution intentionally submitted for inclusion in the Work by You to the Licensor shall be under the terms and conditions of this License, without any additional terms or conditions. Notwithstanding the above, nothing herein shall supersede or modify the terms of any separate license agreement you may have executed with Licensor regarding such Contributions.

6. Trademarks. This License does not grant permission to use the trade names, trademarks, service marks, or product names of the Licensor, except as required for reasonable and customary use in describing the origin of the Work and reproducing the content of the NOTICE file.

7. Disclaimer of Warranty. Unless required by applicable law or agreed to in writing, Licensor provides the Work (and each Contributor provides its Contributions) on an "AS IS" BASIS, WITHOUT WARRANTIES OR CONDITIONS OF ANY KIND, either express or implied, including, without limitation, any warranties or conditions of TITLE, NON-INFRINGEMENT, MERCHANTABILITY, or FITNESS FOR A PARTICULAR PURPOSE. You are solely responsible for determining the appropriateness of using or redistributing the Work and assume any risks associated with Your exercise of permissions under this License.

8. Limitation of Liability. In no event and under no legal theory, whether in tort (including negligence), contract, or otherwise, unless required by applicable law (such as deliberate and grossly negligent acts) or agreed to in writing, shall any Contributor be liable to You for damages, including any direct, indirect, special, incidental, or consequential damages of any character arising as a result of this License or out of the use or inability to use the Work (including but not limited to damages for loss of goodwill, work stoppage, computer failure or malfunction, or any and all other commercial damages or losses), even if such Contributor has been advised of the possibility of such damages.

9. Accepting Warranty or Additional Liability. While redistributing the Work or Derivative Works thereof, You may choose to offer, and charge a fee for, acceptance of support, warranty, indemnity, or other liability obligations and/or rights consistent with this License. However, in accepting such obligations, You may act only on Your own behalf and on Your sole responsibility, not on behalf of any other Contributor, and only if You agree to indemnify, defend, and hold each Contributor harmless for any liability incurred by, or claims asserted against, such Contributor by reason of your accepting any such warranty or additional liability.

END OF TERMS AND CONDITIONS

APPENDIX: How to apply the Apache License to your work

To apply the Apache License to your work, attach the following boilerplate notice, with the fields enclosed by brackets "[]" replaced with your own identifying information. (Don't include the brackets!) The text should be enclosed in the appropriate comment syntax for the file format. We also recommend that a file or class name and description of purpose be included on the same "printed page" as the copyright notice for easier identification within third-party archives.

Copyright [yyyy] [name of copyright owner] Licensed under the Apache License, Version 2.0 (the "License"); you may not use this file except in compliance with the License. You may obtain a copy of the License at <http://www.apache.org/licenses/LICENSE-2.0> Unless required by applicable law or agreed to in writing, software distributed under the License is distributed on an "AS IS" BASIS, WITHOUT WARRANTIES OR CONDITIONS OF ANY KIND, either express or implied. See the License for the specific language governing permissions and limitations under the License.

mDNSResponder (part of mDNSShared)

* Copyright (c) 2003-2004, Apple Computer, Inc. All rights reserved.

*

* Redistribution and use in source and binary forms, with or without

* modification, are permitted provided that the following conditions are met:

*

* 1. Redistributions of source code must retain the above copyright notice,

* this list of conditions and the following disclaimer.

* 2. Redistributions in binary form must reproduce the above copyright notice,

* this list of conditions and the following disclaimer in the documentation

* and/or other materials provided with the distribution.

* 3. Neither the name of Apple Computer, Inc. ("Apple") nor the names of its

* contributors may be used to endorse or promote products derived from this

* software without specific prior written permission.

*

* THIS SOFTWARE IS PROVIDED BY APPLE AND ITS CONTRIBUTORS "AS IS" AND ANY

* EXPRESS OR IMPLIED WARRANTIES, INCLUDING, BUT NOT LIMITED TO, THE IMPLIED

* WARRANTIES OF MERCHANTABILITY AND FITNESS FOR A PARTICULAR PURPOSE ARE

* DISCLAIMED. IN NO EVENT SHALL APPLE OR ITS CONTRIBUTORS BE LIABLE FOR ANY

* DIRECT, INDIRECT, INCIDENTAL, SPECIAL, EXEMPLARY, OR CONSEQUENTIAL DAMAGES

* (INCLUDING, BUT NOT LIMITED TO, PROCUREMENT OF SUBSTITUTE GOODS OR SERVICES;

* LOSS OF USE, DATA, OR PROFITS; OR BUSINESS INTERRUPTION) HOWEVER CAUSED AND

* ON ANY THEORY OF LIABILITY, WHETHER IN CONTRACT, STRICT LIABILITY, OR TORT

* (INCLUDING NEGLIGENCE OR OTHERWISE) ARISING IN ANY WAY OUT OF THE USE OF THIS

* SOFTWARE, EVEN IF ADVISED OF THE POSSIBILITY OF SUCH DAMAGE.

*/

OpenSSL

OpenSSL License

/* =====

* Copyright (c) 1998-2011 The OpenSSL Project. All rights reserved.

*

* Redistribution and use in source and binary forms, with or without

* modification, are permitted provided that the following conditions

* are met:

*

* 1. Redistributions of source code must retain the above copyright

* notice, this list of conditions and the following disclaimer.

*

* 2. Redistributions in binary form must reproduce the above copyright

* notice, this list of conditions and the following disclaimer in

* the documentation and/or other materials provided with the

* distribution.

*

* 3. All advertising materials mentioning features or use of this

* software must display the following acknowledgment:

* "This product includes software developed by the OpenSSL Project

* for use in the OpenSSL Toolkit. (<http://www.openssl.org/>)"

*

* 4. The names "OpenSSL Toolkit" and "OpenSSL Project" must not be used to

* endorse or promote products derived from this software without

* prior written permission. For written permission, please contact

* openssl-core@openssl.org.

*

* 5. Products derived from this software may not be called "OpenSSL"

* nor may "OpenSSL" appear in their names without prior written

* permission of the OpenSSL Project.

*

* 6. Redistributions of any form whatsoever must retain the following

* acknowledgment:

* "This product includes software developed by the OpenSSL Project

* for use in the OpenSSL Toolkit (<http://www.openssl.org/>)"

*
* THIS SOFTWARE IS PROVIDED BY THE OpenSSL PROJECT ``AS IS" AND ANY
* EXPRESSED OR IMPLIED WARRANTIES, INCLUDING, BUT NOT LIMITED TO, THE
* IMPLIED WARRANTIES OF MERCHANTABILITY AND FITNESS FOR A PARTICULAR
* PURPOSE ARE DISCLAIMED. IN NO EVENT SHALL THE OpenSSL PROJECT OR
* ITS CONTRIBUTORS BE LIABLE FOR ANY DIRECT, INDIRECT, INCIDENTAL,
* SPECIAL, EXEMPLARY, OR CONSEQUENTIAL DAMAGES (INCLUDING, BUT
* NOT LIMITED TO, PROCUREMENT OF SUBSTITUTE GOODS OR SERVICES;
* LOSS OF USE, DATA, OR PROFITS; OR BUSINESS INTERRUPTION)
* HOWEVER CAUSED AND ON ANY THEORY OF LIABILITY, WHETHER IN CONTRACT,
* STRICT LIABILITY, OR TORT (INCLUDING NEGLIGENCE OR OTHERWISE)
* ARISING IN ANY WAY OUT OF THE USE OF THIS SOFTWARE, EVEN IF ADVISED
* OF THE POSSIBILITY OF SUCH DAMAGE.

* =====

*
* This product includes cryptographic software written by Eric Young
* (eay@cryptsoft.com). This product includes software written by Tim
* Hudson (tjh@cryptsoft.com).

*
*/

Original SSLeay License

/* Copyright (C) 1995-1998 Eric Young (eay@cryptsoft.com)
* All rights reserved.
*
* This package is an SSL implementation written
* by Eric Young (eay@cryptsoft.com).
* The implementation was written so as to conform with Netscapes SSL.
*
* This library is free for commercial and non-commercial use as long as
* the following conditions are aheared to. The following conditions
* apply to all code found in this distribution, be it the RC4, RSA,
* lhash, DES, etc., code; not just the SSL code. The SSL documentation
* included with this distribution is covered by the same copyright terms
* except that the holder is Tim Hudson (tjh@cryptsoft.com).
*

* Copyright remains Eric Young's, and as such any Copyright notices in
 * the code are not to be removed.

* If this package is used in a product, Eric Young should be given attribution
 * as the author of the parts of the library used.

* This can be in the form of a textual message at program startup or
 * in documentation (online or textual) provided with the package.
 *

* Redistribution and use in source and binary forms, with or without
 * modification, are permitted provided that the following conditions
 * are met:

* 1. Redistributions of source code must retain the copyright
 * notice, this list of conditions and the following disclaimer.

* 2. Redistributions in binary form must reproduce the above copyright
 * notice, this list of conditions and the following disclaimer in the
 * documentation and/or other materials provided with the distribution.

* 3. All advertising materials mentioning features or use of this software
 * must display the following acknowledgement:
 * "This product includes cryptographic software written by
 * Eric Young (eay@cryptsoft.com)"
 * The word 'cryptographic' can be left out if the routines from the library
 * being used are not cryptographic related :-).

* 4. If you include any Windows specific code (or a derivative thereof) from
 * the apps directory (application code) you must include an acknowledgement:
 * "This product includes software written by Tim Hudson (tjh@cryptsoft.com)"
 *

* THIS SOFTWARE IS PROVIDED BY ERIC YOUNG ``AS IS" AND
 * ANY EXPRESS OR IMPLIED WARRANTIES, INCLUDING, BUT NOT LIMITED TO, THE
 * IMPLIED WARRANTIES OF MERCHANTABILITY AND FITNESS FOR A PARTICULAR PURPOSE
 * ARE DISCLAIMED. IN NO EVENT SHALL THE AUTHOR OR CONTRIBUTORS BE LIABLE
 * FOR ANY DIRECT, INDIRECT, INCIDENTAL, SPECIAL, EXEMPLARY, OR CONSEQUENTIAL
 * DAMAGES (INCLUDING, BUT NOT LIMITED TO, PROCUREMENT OF SUBSTITUTE GOODS
 * OR SERVICES; LOSS OF USE, DATA, OR PROFITS; OR BUSINESS INTERRUPTION)
 * HOWEVER CAUSED AND ON ANY THEORY OF LIABILITY, WHETHER IN CONTRACT, STRICT
 * LIABILITY, OR TORT (INCLUDING NEGLIGENCE OR OTHERWISE) ARISING IN ANY WAY
 * OUT OF THE USE OF THIS SOFTWARE, EVEN IF ADVISED OF THE POSSIBILITY OF
 * SUCH DAMAGE.
 *

* The licence and distribution terms for any publically available version or

* derivative of this code cannot be changed. i.e. this code cannot simply be
* copied and put under another distribution licence
* [including the GNU Public Licence.]
*/

xpm

Copyright (c) 1989-95 GROUPE BULL

Permission is hereby granted, free of charge, to any person obtaining a copy of this software and associated documentation files (the "Software"), to deal in the Software without restriction, including without limitation the rights to use, copy, modify, merge, publish, distribute, sublicense, and/or sell copies of the Software, and to permit persons to whom the Software is furnished to do so, subject to the following conditions:

The above copyright notice and this permission notice shall be included in all copies or substantial portions of the Software.

THE SOFTWARE IS PROVIDED "AS IS", WITHOUT WARRANTY OF ANY KIND, EXPRESS OR IMPLIED, INCLUDING BUT NOT LIMITED TO THE WARRANTIES OF MERCHANTABILITY, FITNESS FOR A PARTICULAR PURPOSE AND NONINFRINGEMENT. IN NO EVENT SHALL GROUPE BULL BE LIABLE FOR ANY CLAIM, DAMAGES OR OTHER LIABILITY, WHETHER IN AN ACTION OF CONTRACT, TORT OR OTHERWISE, ARISING FROM, OUT OF OR IN CONNECTION WITH THE SOFTWARE OR THE USE OR OTHER DEALINGS IN THE SOFTWARE.

Except as contained in this notice, the name of GROUPE BULL shall not be used in advertising or otherwise to promote the sale, use or other dealings in this Software without prior written authorization from GROUPE BULL.