

Canon

RF

24-50mm F4.5-6.3 IS STM

Instructions

ENG

Thank you for purchasing a Canon product.

Canon RF24-50mm F4.5-6.3 IS STM is a standard zoom lens for use with EOS R series cameras.

- “IS” stands for Image Stabilizer.
- “STM” stands for Stepping Motor.

Conventions used in these instructions



Warning to prevent lens or camera malfunction or damage.



Supplementary notes on using the lens and taking pictures.

Camera Firmware and Camera Applications

Please use the latest versions of firmware and applications with the camera in use. For details on whether the firmware and applications in use are the latest version or not, and for details on updating them, please check the Canon website.



If the camera's* firmware is not a compatible version, the following limitations will apply.

- Magnified view functionality is not available.
- In some cases, the camera malfunction may occur.

* Applies to the following camera models:
EOS R and EOS RP

Safety Precautions

Precautions to ensure that the camera is used safely. Read these precautions thoroughly. Make sure all details are observed in order to prevent risks and injury to the user and other people.



Warning

Details pertaining to risks that may result in death or serious injury.

- **Do not look directly at the sun or other strong light sources through a lens.** This may result in loss of sight.
- **Do not leave a lens in the sun without the lens cap attached.** The lens may concentrate entering sunlight and cause a malfunction or fire.



Caution

Details pertaining to risks that may result in injury or damage to other objects.

- **Do not leave the product in places exposed to extremely high or low temperatures.** The product may cause burns or injury when touched.
- **Do not insert your hand or fingers into the product.** This may result in injury.

General Precautions

Handling Precautions

- Do not leave the product in excessive heat such as in a car in direct sunlight. High temperatures can cause the product to malfunction.
- If the lens is taken from a cold environment into a warm one, condensation may develop on the lens surface and internal parts. To prevent condensation in this case, first put the lens into an airtight plastic bag before taking it from a cold to warm environment. Then take out the lens after it has warmed gradually. Do the same when taking the lens from a warm environment into a cold one.
- The lens interior may appear to waver, but this does not indicate a defect or failure, and will not cause any problems in use.
- In order to optimize aperture control, there are occasions in which the aperture blades will move during zooming and focusing, even when the aperture value is set for aperture-priority AE or manual exposure, etc.
- Please also read any lens related handling precautions listed in your camera's instruction manual.

Shooting Precautions

- Focus again after recovering from the auto power off status.
- To maintain the focus position in the shooting-ready status, set [Auto power off] to [Disable] on the camera.

This device complies with Part 15 of the FCC Rules.

Operation is subject to the following two conditions: (1) This device may not cause harmful interference, and (2) this device must accept any interference received, including interference that may cause undesired operation.

Do not make any changes or modifications to the equipment unless otherwise specified in the instructions. If such changes or modifications should be made, you could be required to stop operation of the equipment.

This equipment has been tested and found to comply with the limits for a class B digital device, pursuant to part 15 of the FCC Rules. These limits are designed to provide reasonable protection against harmful interference in a residential installation. This equipment generates, uses and can radiate radio frequency energy and, if not installed and used in accordance with the instructions, may cause harmful interference to radio communications.

However, there is no guarantee that interference will not occur in a particular installation. If this equipment does cause harmful interference to radio or television reception, which can be determined by turning the equipment off and on, the user is encouraged to try to correct the interference by one or more of the following measures:

- Reorient or relocate the receiving antenna.
- Increase the separation between the equipment and receiver.
- Connect the equipment into an outlet on a circuit different from that to which the receiver is connected.
- Consult the dealer or an experienced radio/TV technician for help.

Nomenclature

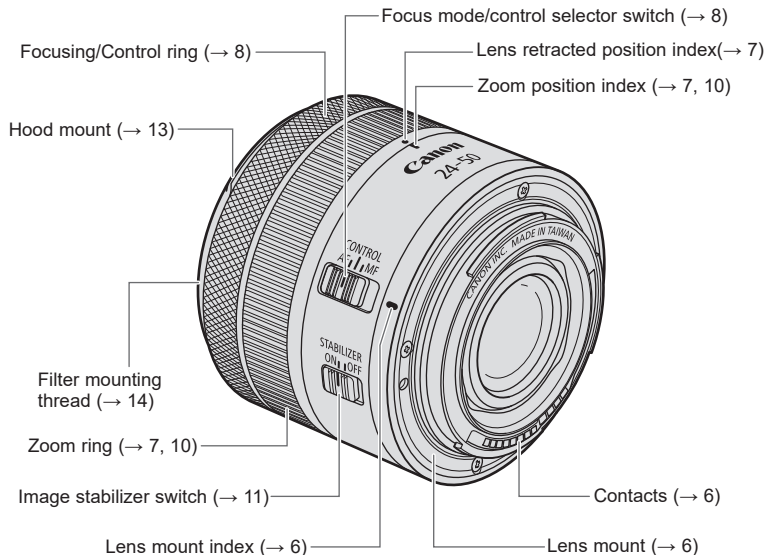

- For detailed information, reference page numbers are provided in parentheses (→ **).

1. Attaching and Detaching the Lens

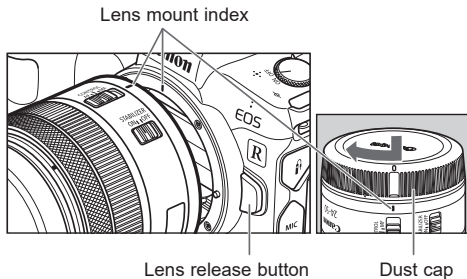

- Set the camera's power switch to OFF when attaching or detaching the lens.
- Attach the lens cap before detaching the lens from the camera.
- After detaching the lens, place the lens with the rear end up and attach the dust cap to prevent the lens surface and contacts from getting scratched. Make sure the lens and dust cap mount indexes are aligned when attaching the dust cap.
- Contacts that are scratched, soiled, or have fingerprints on them may result in faulty connections or corrosion, which may lead to malfunctions. If the contacts get soiled, clean them with a soft cloth.

Attaching the Lens

Align the lens mount indexes of the lens and camera, and turn the lens clockwise until you hear a click.

Detaching the Lens

Turn the lens counterclockwise while pressing the camera's lens release button. Detach the lens once it has stopped turning.

Please refer to the camera's instructions for details.

2. Shooting Preparations and Retracting Lens

The lens is fitted with a retraction mechanism.

This enables the length of the lens to be shortened in comparison to when shooting.

Shooting is not possible when the lens is stored.

Observe the following procedure to set the lens in the position for shooting.

Preparations from Retraction to Shooting

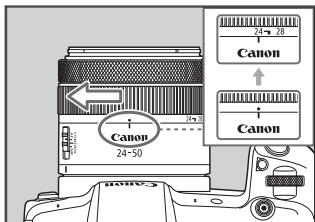

Rotate the zoom ring in the direction of the white arrow until you hear a click to set the lens in the preparatory shooting position.

- ⚠ If the lens retraction position indicator is aligned with the zoom indicator, add slight pressure to rotate the zoom ring in the direction of the arrow.

Retracting Lens

- 1 Rotate the zoom ring from the shooting position in the opposite direction to the white arrow.
- 2 Continue rotating after it exceeds the wide-angle position (24 mm).
- 3 Rotate it to the end to align the lens retraction position indicator with the zoom indicator and store it.

- ⚠ Take care to avoid catching your fingers, etc., between the lens extender and Focusing/Control ring.

3. Focusing/Control ring

The focusing/control ring can be used as either a focusing ring or a control ring.

Focusing/Control ring

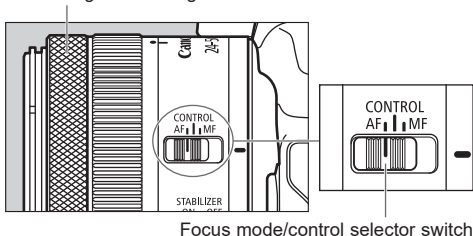

Use as a Focusing Ring

Set the focus mode/control selector switch to AF or MF.

To shoot in autofocus (AF) mode, set the focus mode/control selector switch to AF. Table*1

To use only manual focusing (MF), set the focus mode/control selector switch to MF, and focus by turning the focusing ring (focusing/control ring). Table*2

Table: List of Focus Mode and Focusing/Control Ring Functions Using the Focus Mode/Control Selector Switch

	Focus mode/ Control selector switch		
	*1 AF	*3 CONTROL	*2 MF
Focus mode	AF	*4 AF/ *5 MF	MF
Focusing/ control ring functions	Focusing ring	Control ring	Focusing ring

Use as a Control Ring

Set the focus mode/control selector switch to CONTROL. Table*3

Set the control ring function using the camera's menu. The control ring can be assigned the functions that are commonly used with cameras, such as shutter speed and aperture settings. Please refer to the camera's instructions for details on how to use the control ring.

Focusing/Control ring



- Delayed focus may occur if the focusing ring (focusing/control ring) is quickly turned.
- Setting the focus mode/control selector switch to CONTROL will fix the focus mode as AF. Table*4
However, depending on the camera used, it is possible to switch the focus mode to MF on the camera. Table*5
Please refer to the camera's instructions for details.



- The lens' focusing ring (focusing/control ring) is electronic.
- With a camera capable of electronic full-time manual focus, manual focusing is possible in both One-Shot AF and Servo AF modes. However, the camera settings need to be changed.
- When AF operation is set to One-Shot AF, manual focus is possible after autofocus has been completed by continuing to press the shutter button halfway (electronic manual focus function). However, the camera settings need to be changed.
- When movie recording, the AF speed will be slower than the still photo shooting mode. It is possible to adjust the AF speed on the camera by setting Movie Servo AF to [Enable].

Please refer to the camera's instructions for details.

4. Zooming

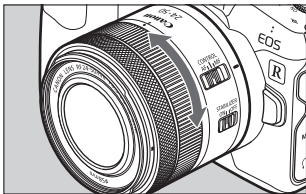

To zoom, turn the lens' zoom ring.

- Be sure to finish zooming before focusing. Zooming after focusing can affect the focus.
- Blurring may temporarily occur if the zoom ring is quickly turned.
- Please be careful not to let your fingers get caught in between the lens' front and the focusing/control ring when zooming.

5. Image Stabilizer

This function provides image stabilization appropriate for shooting conditions (such as shooting still subjects and panning shots).

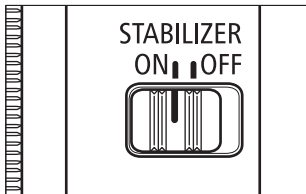

Set the image stabilizer switch to ON when you want to use the Image Stabilizer.

- Set the image stabilizer switch to OFF when you are not going to use the Image Stabilizer.

- The Image Stabilizer cannot compensate for a blurred shot caused by a subject that moved.
- The Image Stabilizer may not be fully effective if you shoot from a violently shaking vehicle or other transportation.
- When using a tripod, it is recommended that you set the Image Stabilizer to OFF.
- Even with a monopod, the Image Stabilizer will be as effective as during hand-held shooting. However, depending on the shooting conditions, there are cases in which the Image Stabilizer effect may be less effective.

- The Image Stabilizer will work in combination with cameras with in-body Image Stabilizer.

Image Stabilizer

The Image Stabilizer for this lens is suited to hand-held shots in the following conditions.



- In semi-darkened areas such as indoors or outdoors at night.
- In locations where the flash cannot be used, such as art museums and theater stages.
- In situations where your footing is uncertain.
- In situations where fast shutter speed settings cannot be used.



- Panning shots of vehicles, trains, etc.
It compensates for vertical camera shake during panning shots in a horizontal direction, and compensates for horizontal camera shake during panning shots in a vertical direction.

6. Hood (Sold separately)

The custom lens hood reduces unwanted light that causes flare and ghosting and protects the front of the lens from rain, snow, and dust.

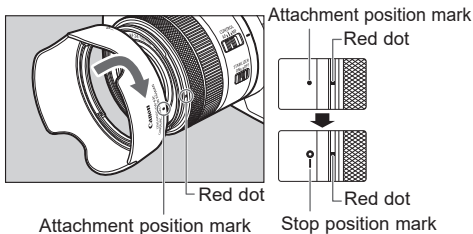

Attaching the Hood

Align the red attachment position mark on the hood with the red dot on the front of the lens, and then turn the hood in the direction of the arrow until the red dot on the lens is aligned with the stop position on the hood and the hood is firmly attached.

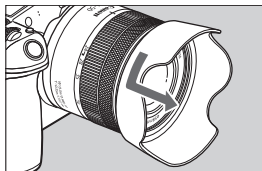

Detaching the Hood

Rotate the hood in the direction of the arrow until the hood attachment position mark is aligned with the red indicator on the front of the lens to remove it.

The hood can be reverse-mounted on the lens for storage.

- If the hood is not attached properly, vignetting (darkening of the perimeter of the picture) may occur.
- Grasp and turn the base of the hood when attaching and detaching it. There are cases in which it may become deformed if the hood is turned with it grasped near to the rim.

7. Filters (Sold separately)

You can attach filters ($\Phi 58$) to the filter mounting thread on the front of the lens.

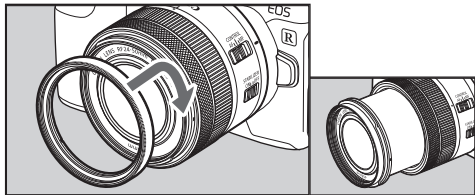

- Only one filter may be attached.

Specifications

Focal Length/Aperture	24-50mm f/4.5-6.3
Lens Construction	8 groups, 8 elements
Maximum Aperture	f/4.5-6.3 (1/3 stops), f/4.5-6.7 (1/2 stops)
Minimum Aperture	f/22-32
Angle of View	Horizontal: 74° - 40°, Vertical: 53° - 27°, Diagonal: 84° - 46°
Min. Focusing Distance	0.30 m/0.98 ft. (at 24 mm), 0.35 m/1.15 ft. (at 50 mm)
Max. Magnification	0.19x (at 50 mm)
Field of View	Approx. 309 x 206 mm/12.17 x 8.11 in. (at 24 mm, 0.30 m/0.98 ft.) Approx. 184 x 123 mm/7.24 x 4.84 in. (at 50 mm, 0.35 m/1.15 ft.)
Filter Diameter	58 mm
Max. Diameter and Length	Approx. 69.6 x 58 mm/2.74 x 2.28 in. (when lens is retracted)
Weight	Approx. 210 g/7.41 oz.
Hood	EW-63C (Sold separately)
Lens Cap	E-58 II
Case	LP1014 (Sold separately)

Specifications

- The lens length is measured from the lens mount surface to the front end of the lens.
Add 24.2 mm/0.95 in. when including the lens cap and dust cap.
- The maximum diameter, length and weight listed are for the lens itself only.
- You cannot use extenders.
- Multiple exposure shooting is not possible when using this lens on certain cameras*.
* EOS R, RP, Ra, R5, R6
- There are cases in which using the zoom function during continuous shooting may result in conspicuous image distortion.
- All data listed is measured according to Canon standards.
- Product specifications and appearance are subject to change without notice.

Canon