

Canon EF LENS

EF24-105mm f/3.5-5.6 IS STM



IMAGE STABILIZER

ENG

Instructions

Thank you for purchasing a Canon product.

The Canon EF24-105mm f/3.5-5.6 IS STM is a high-performance standard zoom lens that makes movie shooting comfortable. The lens is equipped with an Image Stabilizer and has been developed for use with EOS cameras.

- "IS" stands for Image Stabilizer.
- "STM" stands for stepping motor.

Camera Firmware

Please use the latest version of firmware with the camera in use. For details on whether the firmware is the latest version or not, and for details on updating the firmware, please check the Canon website.

Conventions used in these instructions



Warning to prevent lens or camera malfunction or damage.



Supplementary notes on using the lens and taking pictures.

Safety Precautions

Precautions to ensure that the camera is used safely. Read these precautions thoroughly. Make sure all details are observed in order to prevent risks and injury to the user and other people.



Warning

Details pertaining to risks that may result in death or serious injury.

- **Do not look directly at the sun or other strong light sources through a lens.** This may result in loss of sight.
- **Do not leave a lens in the sun without the lens cap attached.** The lens may concentrate entering sunlight and cause a malfunction or fire.



Caution

Details pertaining to risks that may result in injury or damage to other objects.

- **Do not leave the product in places exposed to extremely high or low temperatures.** The product may cause burns or injury when touched.

General Precautions

Handling Precautions

- Do not leave the product in excessive heat such as in a car in direct sunlight. High temperatures can cause the product to malfunction.
- If the lens is taken from a cold environment into a warm one, condensation may develop on the lens surface and internal parts. To prevent condensation in this case, first put the lens into an airtight plastic bag before taking it from a cold to warm environment. Then take out the lens after it has warmed gradually. Do the same when taking the lens from a warm environment into a cold one.
- Please also read any lens related handling precautions listed in your camera's instruction manual.

Shooting Precautions

The EF24-105mm f/3.5-5.6 IS STM utilizes a stepping motor that drives the focus lens. The motor also controls the focus lens during zooming.

1. When the camera is OFF

The motor does not operate while the camera is OFF or when the camera is OFF due to the use of the auto power off function. Therefore, users must be aware of the following points.

- Manual focus adjustments are not possible.
- During zooming, delayed focus will occur.

2. When the lens is in sleep mode

If not operated for a certain period of time, this lens will enter sleep mode in order to save power. Sleep mode differs from when the camera is OFF due to the use of the auto power off function.

In this state, the motor will not operate even if the camera is ON. Therefore, users must be aware of the following points.

- Manual focus adjustments are not possible.
- During zooming, delayed focus will occur.
- To exit sleep mode, press the shutter button halfway.

General Precautions

3. During initial reset

When the camera is ON or when the camera is turned ON by pressing the shutter button halfway down when the camera is OFF due to the use of the auto power off function*¹, the lens performs an initial reset of the focus lens.*²

- Although the image in the viewfinder will appear out of focus during the initial reset, this does not mean that the lens has malfunctioned.
- Although the shutter can be released during the initial reset, users must wait approximately 1 second*³ after the initial reset has completed before shooting.

*1: Not applicable to the following EOS camera models:

EOS REBEL T5i/700D, EOS REBEL SL1/100D, EOS REBEL T4i/650D

*2: With some cameras, the lens may perform an initial reset in order to improve lens performance even at times other than described in this section.

*3: The initial reset time varies depending on camera being used.

When using the lens with film-based SLR cameras

- The drive speed of the focus lens will be slower than when the lens is used with a digital camera.
- Images will appear out of focus when using the camera's internal flash while it is charging or when zooming during exposure for still images.
- Even when the camera is ON, images may appear out of focus when zooming. If this occurs, press the shutter button halfway while zooming.
- After focusing in ONE SHOT AF mode and zooming by holding the shutter button halfway, the camera may indicate that the AF mode has been changed to manual focus (MF) mode.
- During continuous shooting, zooming may slow down shooting speed.
- There are some cases when users must wait approximately 1 second after zooming before the auto focus will function.
- When using the lens with certain film single-lens reflex cameras, operating the power switch between ON and OFF with the lens attached to the cameras may cause the autofocus (AF) and manual focus (MF) to stop working. In this case, please reattach the lens with the power switched <ON>.

This device complies with Part 15 of the FCC Rules.

Operation is subject to the following two conditions: (1) This device may not cause harmful interference, and (2) this device must accept any interference received, including interference that may cause undesired operation.

Do not make any changes or modifications to the equipment unless otherwise specified in the instructions. If such changes or modifications should be made, you could be required to stop operation of the equipment.

This equipment has been tested and found to comply with the limits for a class B digital device, pursuant to part 15 of the FCC Rules. These limits are designed to provide reasonable protection against harmful interference in a residential installation. This equipment generates, uses and can radiate radio frequency energy and, if not installed and used in accordance with the instructions, may cause harmful interference to radio communications.

However, there is no guarantee that interference will not occur in a particular installation. If this equipment does cause harmful interference to radio or television reception, which can be determined by turning the equipment off and on, the user is encouraged to try to correct the interference by one or more of the following measures:

- Reorient or relocate the receiving antenna.
- Increase the separation between the equipment and receiver.
- Connect the equipment into an outlet on a circuit different from that to which the receiver is connected.
- Consult the dealer or an experienced radio/TV technician for help.

Nomenclature

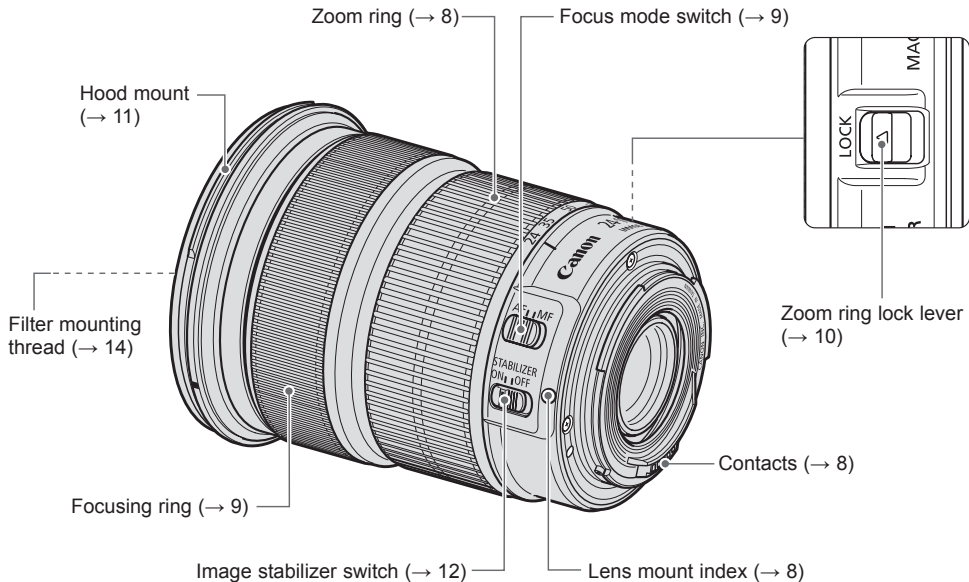

● For detailed information, reference page numbers are provided in parentheses (→ **).

1. Mounting and Detaching the Lens

See your camera's instructions for details on mounting and detaching the lens.

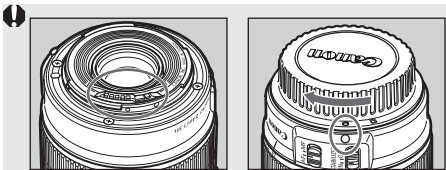

- After detaching the lens, place the lens with the rear end up to prevent the lens surface and contacts from getting scratched.
- If the contacts get soiled, scratched, or have fingerprints on them, corrosion or faulty connections can result. The camera and lens may not operate properly.
- If the contacts get soiled or have fingerprints on them, clean them with a soft cloth.
- If you remove the lens, cover it with the dust cap. To attach it properly, align the lens mount index and the ○ index of the dust cap as shown in the diagram, and turn clockwise. To remove it, reverse the order.

2. Zooming

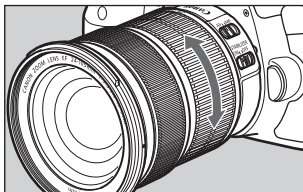

To zoom, turn the lens' zoom ring.

- Be sure to finish zooming before focusing. Zooming after focusing can affect the focus.
- Blurring may temporarily occur if the zoom ring is quickly rotated.
- Zooming when the camera is OFF will result in delayed focus.
- Zooming during still image exposure will result in delayed focus. This causes any streaks of light that are captured during exposure to be blurred.

3. Setting the Focus Mode

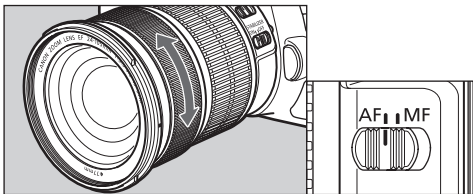

To shoot in autofocus (AF) mode, set the focus mode switch to AF.

To use only manual focusing (MF), set the focus mode switch to MF, and focus by turning the focusing ring.

 After autofocusing in ONE SHOT AF mode, focus manually by pressing the shutter button halfway and turning the focusing ring. (Full-time manual focus)

-  Quickly rotating the focusing ring may result in delayed focus.
- Manual focus adjustments are not possible when the camera is OFF.
- Please make sure that the camera is kept ON after bringing an image into focus. However, there are times when images will become out of focus even when the camera is ON due to changing the camera battery or attaching/detaching the lens. Please use the camera's auto power off function to maintain focus when the camera is OFF.

4. Fixing the Zoom Ring

The zoom ring can be fixed to keep the lens at the shortest point. This function is convenient for carrying a camera on a strap because it prevents the lens from extending.

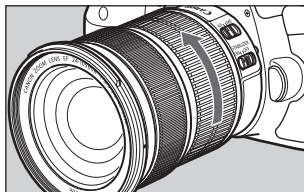
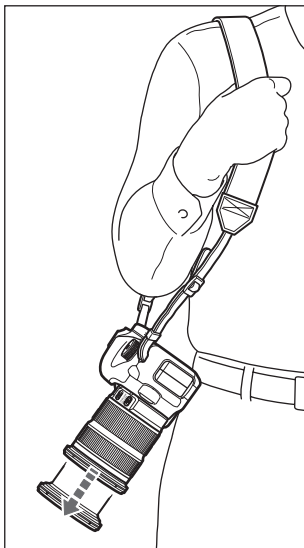

1 Rotate the zoom ring to the widest position (24 mm).

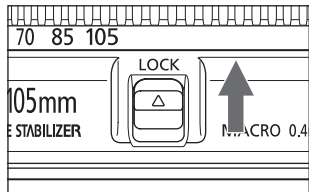

2 Slide the zoom ring lock lever in the direction indicated by the arrow.

- To release the zoom ring, slide the zoom ring lock lever in the direction opposite to the arrow.

H The zoom ring can only be locked at maximum wide angle.

5. Hood (sold separately)

The EW-83M hood cuts out unwanted light and protects the front of the lens from rain, snow, and dust.

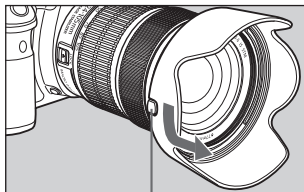
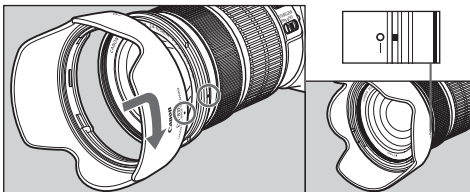

Button

● Attaching

To attach the hood, align the hood's attachment position mark with the red dot on the front of the lens, then turn the hood as shown by the arrow until the lens' red dot is aligned with the hood's stop position mark.

● Removing

To remove the hood, hold down the button on the side and turn the hood in the direction of the arrow until the position mark on the hood aligns with the red dot. The hood can be reverse-mounted on the lens for storage.

⚠ ● If the hood is not attached properly, vignetting (darkening of the perimeter of the picture) may occur.

● When attaching or detaching the hood, grasp the base of the hood to turn it. To prevent deformation, do not grasp the rim of the hood to turn it.

6. Image Stabilizer

You can use the image stabilizer in AF or MF mode.

This function provides optimal image stabilization depending on shooting conditions (such as shooting still subjects and following shots).

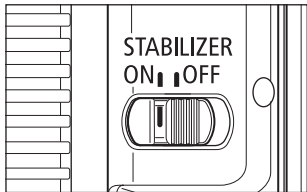

1 Set the **STABILIZER** switch to **ON**.

- If you are not going to use the image stabilizer function, set the switch to OFF.

2 When you press the shutter button halfway, the Image Stabilizer will start operating.

- Make sure the image in the viewfinder is stable, then press the shutter button the rest of the way down to take the picture.

- The Image Stabilizer cannot compensate for a blurred shot caused by a subject that moved.
- The Image Stabilizer may not be fully effective if you shoot from a violently shaking vehicle or other transportation.
- The Image Stabilizer consumes more power than normal shooting, resulting in fewer shots and a shorter movie shooting time.

- When shooting a still subject, it compensates for camera shake in all directions.
- It compensates for vertical camera shake during following shots in a horizontal direction, and compensates for horizontal camera shake during following shots in a vertical direction.
- When you use a tripod, the Image Stabilizer should be turned off to save battery power.
- Even with a monopod, the Image Stabilizer will be as effective as during hand-held shooting. However, depending on the shooting environment, the Image Stabilizer effect may be less effective.
- The image stabilizer function also operates when the lens is used with an Extension Tube EF12 II or EF25 II.
- If you set the camera's Custom Function to change the assigned button to operate the AF, the Image Stabilizer will operate when you press the newly assigned AF button.

Image Stabilizer

The image stabilizer for this lens is effective for hand-held shots in the following conditions.



ON

OFF

- In semi-darkened areas such as indoors or outdoors at night.
- In locations where flash photography is prohibited, such as art museums and theater stages.
- In situations where your footing is uncertain.
- In situations where fast shutter settings cannot be used.



ON

OFF

- When panning subjects in motion.

7. Filters (sold separately)

You can attach filters to the filter mounting thread on the front of the lens.



- Only one filter may be attached.
- If you need a polarizing filter, use the Canon Circular Polarizing Filter PL-C B (77 mm).
- To adjust the polarizing filter, first remove the lens hood.

8. Extension Tubes (sold separately)

You can attach extension tube EF12 II or EF25 II for magnified shots. The shooting distance and magnification are shown below.

		Focusing Distance Range (mm)		Magnification (×)	
		Close distance	Long distance	Close distance	Long distance
EF12 II	24mm	176	188	0.61	0.50
	105mm	323	1041	0.46	0.12
EF25 II	24mm	Incompatible			
	105mm	290	594	0.67	0.27



MF mode is recommended for accurate focusing.

9. Close-up Lenses (sold separately)

Attaching a 500D (77 mm) Close-up Lens enables close-up photography.

Compatibility with Close-up Lenses is as follows.

- Can be used at the 105mm end (magnification 0.41x - 0.21x)
-
- 
- Close-up Lens 250D cannot be attached because there is no size that fits the lens.
 - MF mode is recommended for accurate focusing.

Specifications

Focal Length/Aperture	24-105mm f/3.5-5.6
Lens Construction	13 groups, 17 elements
Minimum Aperture	f/22-36*
Angle of View	Diagonal: 84°- 23° 20', Vertical: 53°- 13°, Horizontal: 74°- 19° 20'
Min. Focusing Distance	0.4 m/1.31 ft.
Max. Magnification	0.3x (at 105 mm)
Field of View	Approx. 291 x 449 - 81 x 121 mm/11.46 x 17.68 - 3.19 x 4.76 inch (at 0.4 m/1.31 ft.)
Filter Diameter	77 mm
Max. Diameter and Length	Approx. 83.4 x 104 mm/3.28 x 4.09 inch
Weight	Approx. 525 g/18.5 oz.
Hood	EW-83M (sold separately)
Lens Cap	E-77 II
Case	LP1219 (sold separately)

* Applies to 1/3-stop increments. With 1/2-stop increments, it will be f/22-38.

- The lens length is measured from the mount surface to the front end of the lens. Add 24.2 mm when including the lens cap and dust cap.
- The size and weight listed are for the lens only, except as indicated.
- Extenders cannot be used with this lens.
- Aperture settings are specified on the camera. The camera automatically compensates for variations in the aperture setting when the camera is zoomed in or out.
- All data listed is measured according to Canon standards.
- Product specifications and appearance are subject to change without notice.

Canon