

iPF850

User's Guide

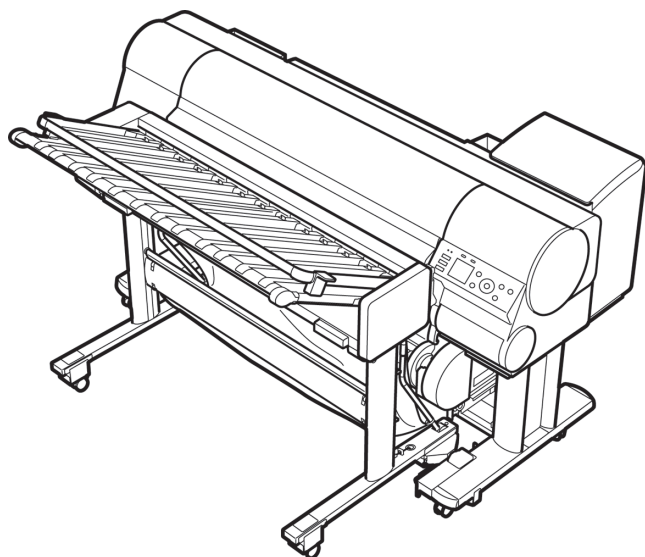

Basic Printing Workflow	15
Enhanced Printing Options	29
Printing CAD Drawings.....	52
Printing enlargements or reductions.....	72
Printing at full size.....	83
Borderless Printing.....	92
Printing banners or at other non-standard sizes.....	101
Tiling and multiple pages per sheet.....	114
Centering originals.....	128
and so on	
Windows Software	157
Printer Driver.....	158
Preview.....	189
Free Layout.....	199
Color imageRUNNER Enlargement Copy.....	221
Print Plug-In for Office.....	230
and so on	
Mac OS Software	267
Printer Driver.....	268
Preview.....	286
Free Layout.....	307
and so on	
Handling and Use of Paper	331
Control Panel	429
Printer Parts	467
Network Setting	481
Print Job Management	501
Adjustments for Better Print Quality	555
Maintenance and Consumables	573
Troubleshooting	617
Error Message	651
Specifications	673
Appendix	677

Manuals for this printer

Setup Guide

Quick Guide

Basic Guide Electronic manual

User's Guide Electronic manual

Paper Reference Guide Electronic manual

Basic Printing Workflow 15

Printing procedure 16

Printing Options Using Rolls and Sheets	16
Turning the Printer On and Off	17
Loading and Printing on Rolls	18
Loading and Printing on Sheets	21
Printing in Windows	22
Printing from Mac OS	22

Canceling print jobs 24

Canceling Print Jobs from the Control Panel	24
Canceling Print Jobs from Windows	25
Canceling Print Jobs from Mac OS	25

Pausing Printing 27

Pausing Printing	27
------------------------	----

Enhanced Printing Options 29

Choosing Paper for Printing 30

Choosing a Paper for Printing	30
Specifying Paper in the Printer Driver	30

Using double-roll printing 31

About Double-roll Switching	31
Loading Roll Paper in the Printer Depending on the Purpose	31
Printing by Automatically Switching Between Upper and Lower Roll Paper	32
Printing by Automatically Switching Between Upper and Lower Roll Paper (Windows)	32
Printing by Automatically Switching Between Upper and Lower Roll Paper (Mac OS)	37
Roll Paper Switching Method	39

Printing Photos and Office Documents 43

Printing Photos and Images	43
Printing Photos and Images (Windows)	43
Printing Photos and Images (Mac OS)	45
Printing Office Documents	47
Printing Office Documents (Windows)	47
Printing Office Documents (Mac OS)	48
Using PosterArtist to Compose Originals	50

Printing CAD Drawings 52

Printing CAD Drawings	52
Printing Line Drawings and Text	52
Printing Line Drawings and Text (Windows)	53
Printing Line Drawings and Text (Mac OS)	54
Printing from AutoCAD	56
Specifying Colors and Printing CAD Drawings	57
Specifying Colors and Printing CAD Drawings (Windows)	58
HP-GL/2 Printing	59

Adjusting Images 60

Adjusting the Color in the Printer Driver	60
Fine-Tuning Colors of Photos and Images (Windows)	61
Fine-Tuning Colors of Photos and Images (Mac OS)	64
Giving Priority to Particular Graphic Elements and Colors for Printing	66
Choosing the Document Type and Printing Conditions (Windows)	68
Choosing the Document Type and Printing Conditions (Mac OS)	70

Printing enlargements or reductions	72
Resizing Originals to Match the Paper Size	72
Resizing Originals to Match the Paper Size (Windows)	72
Resizing Originals to Fit the Roll Width	74
Resizing Originals to Fit the Roll Width (Windows)	74
Resizing Originals to Fit the Roll Width (Mac OS)	76
Resizing Originals by Entering a Scaling Value	78
Resizing Originals by Entering a Scaling Value (Windows)	79
Resizing Originals by Entering a Scaling Value (Mac OS)	80
Printing at full size	83
Printing on Oversize Paper	83
Printing at Full Size (Windows)	84
Printing at Full Size (Mac OS)	85
Borderless Printing at Actual Size	87
Borderless Printing at Actual Size (Windows)	88
Borderless Printing at Actual Size (Mac OS)	90
Borderless Printing	92
Borderless Printing on Paper of Equivalent Size	92
Borderless Printing by Resizing Originals to Match the Paper Size (Windows)	93
Borderless Printing by Resizing Originals to Fit the Roll Width	95
Borderless Printing by Resizing Originals to Fit the Roll Width (Windows)	96
Borderless Printing by Resizing Originals to Fit the Roll Width (Mac OS)	98
Printing banners or at other non-standard sizes	101
Printing Vertical or Horizontal Banners (Large-Format Printing)	101
Printing Vertical or Horizontal Banners (Large-Format Printing; Windows)	102
Printing Vertical or Horizontal Banners (Large-Format Printing; Mac OS)	105
Printing on Non-Standard Paper Sizes	108
Printing on Non-Standard Paper Sizes (Windows)	108
Printing on Non-Standard Paper Sizes (Mac OS)	111
Tiling and multiple pages per sheet	114
Printing Multiple Originals Next to Each Other	114
Printing Multiple Originals Next to Each Other (Windows)	115
Printing Multiple Originals Next to Each Other (Mac OS)	117
Printing Multiple Pages Continuously	118
Printing Multiple Pages Continuously (Windows)	118
Printing Multiple Pages Continuously (Mac OS)	120
Printing Multiple Pages Per Sheet	121
Printing Multiple Pages Per Sheet (Windows)	122
Printing Multiple Pages Per Sheet (Mac OS)	124
Printing Posters in Sections	126
Printing Large Posters (Windows)	126
Centering originals	128
Printing Originals Centered on Rolls	128
Printing Originals Centered on Rolls (Windows)	128
Printing Originals Centered on Rolls (Mac OS)	130
Printing Originals Centered on Sheets	132
Printing Originals Centered on Sheets (Windows)	132
Printing Originals Centered on Sheets (Mac OS)	134
Conserving roll paper	137
Conserving Roll Paper by Rotating Originals 90 Degrees	137
Conserving Roll Paper by Rotating Originals 90 Degrees (Windows)	137
Conserving Roll Paper by Rotating Originals 90 Degrees (Mac OS)	138
Conserving Roll Paper by Printing Originals Without Top and Bottom Margins	140
Conserving Roll Paper by Printing Originals Without Top and Bottom Margins (Windows)	141
Conserving Roll Paper by Printing Originals Without Top and Bottom Margins (Mac OS)	142

Checking Images Before Printing 145

Checking the Layout in a Preview Before Printing 145

Other useful settings 146

Printing With Watermarks 146

Printing with Watermarks—COPY, FILE COPY, and so on (Windows) 147

Making the Original Orientation Match the Paper Orientation 148

Making the Original Orientation Match the Paper Orientation (Windows) 149

Making the Original Orientation Match the Paper Orientation (Mac OS) 150

Using Favorites 152

Cutting Roll Paper After Printing 152

Cutting Roll Paper After Printing (Windows) 153

Cutting Roll Paper After Printing (Mac OS) 154

Windows Software 157**Printer Driver** 158

Printer Driver Settings 158

Specifying Paper in the Printer Driver 160

Confirming Print Settings 161

Checking the Layout in a Preview Before Printing 161

Using Favorites 162

Accessing the Printer Driver Dialog Box from Applications 164

Accessing the Printer Driver Dialog Box from the Operating System Menu 165

Main Sheet 166

Paper Information on Printer Dialog Box 170

Paper Detailed Settings Dialog Box 170

View Settings Dialog Box for the Printing Application 172

Color Adjustment Sheet: Color 172

Object Adjustment Dialog box: Color 173

Matching Sheet 174

Color Adjustment Sheet: Monochrome 176

Object Adjustment Dialog box: Monochrome 177

Page Setup Sheet 177

Output Method Dialog box 180

Paper Size Options Dialog Box 181

Layout Sheet 182

Page Options Dialog Box 183

Special Settings Dialog Box 184

Favorites Sheet 185

Utility Sheet 186

Support Sheet 187

Settings Summaries Dialog Box 187

Device Settings Sheet 188

Preview 189

The Features of Preview 189

Starting Preview 189

Preview Main Window 190

Dialog Area 192

Enlarge/Reduce the screen display 193

Moving a Page 193

Using the ruler 193

Priority setting for rotating 90 degrees 194

Printing with Selecting the Layout 195

Print on the Center 197

Not Print Spaces at the Top/Bottom 198

Free Layout 199

The Features of Free Layout 199

Starting Free Layout 199

Free Layout Main Window 201

Detailed Settings	202
Preferences Dialog Box	203
Page Options Dialog Box	204
Zoom Dialog Box	205
Format Dialog Box	205
Laying out a Multiple-File Document on One Page	207
Laying out a Document Created with Multiple Application Programs on One Page	209
Selecting an Object	211
Changing the Object Size	211
Moving an Object	212
Rotating an Object	212
Laying out Objects Automatically	213
Aligning Objects	213
Changing the Object Overlapping Order	215
Pasting a Copied or Cut Object	216
Folded Duplex Window	217
Finished Size Settings Dialog Box	218
Binding Settings Dialog Box	219
Prints using Folded Duplex	220

Color imageRUNNER Enlargement Copy 221

The Features of Color imageRUNNER Enlargement Copy	221
Starting Color imageRUNNER Enlargement Copy	221
Color imageRUNNER Enlargement Copy Dialog Box	222
Hot Folder	223
Creating a New Hot Folder	223
Specifying an Existing Shared Folder as a Hot Folder	226
Setting the Print Parameters	228
Printing Enlargements of Scanned Originals from a Color imageRUNNER	229

Print Plug-In for Office 230

Print Plug-In for Officefeatures	230
Steps to install	230
Steps to uninstall	233
When Print Plug-In for Office is not displayed	233
To start from Microsoft Word	236
Print Matching Roll Width(Word)	238
Borderless Printing(Word)	240
Multi-Page Printing(Word)	242
Register the settings (Word)	243
Print Using Registered Settings(Word)	244
Portrait Orientation/Landscape Orientation(Word)	246
To start from Microsoft PowerPoint	247
Print Matching Roll Width(PowerPoint)	249
Borderless Printing(PowerPoint)	250
Multi-Page Printing(PowerPoint)	252
Register the settings (PowerPoint)	254
Print Using Registered Settings(PowerPoint)	255
Portrait Orientation/Landscape Orientation(PowerPoint)	256
To start from Microsoft Excel	258
Print Entire Sheet(Excel)	259
Print Selected Area(Excel)	262
Configuring Binding (Excel)	264
Configuring Special Settings	265

Mac OS Software 267

Printer Driver 268

Printer Driver Settings	268
Specifying Paper in the Printer Driver	269
Confirming Print Settings	270
Checking the Layout in a Preview Before Printing	271

Using Favorites	271
Accessing the Printer Driver Dialog Box from Applications	272
Main Pane	272
Paper Detailed Settings Dialog Box	276
View set. Dialog Box for the Printing Application	278
Matching pane	278
Color Settings Pane: Color	280
Object Adjustment dialog box: Color	281
Color Settings Pane: Monochrome	282
Object Adjustment dialog box: Monochrome	283
Page Setup Pane	283
Additional Settings Pane	284

Preview 286

The Features of Preview	286
Starting Preview	286
Preview Main Window	287
Paper Settings Panel	290
Easy Settings	291
Advanced Settings	292
Output Settings Panel	293
Color Settings Panel	295
Color Adjustment	296
Matching	298
Driver Matching Mode	299
ICC Matching Mode	300
ColorSync	301
Preferences Dialog Box	301
Zoom Dialog Box	301
Go to Page Dialog Box	302
Print with No Borders	302
Print on the Center	303
Not Print Spaces at the Top/Bottom	303
Print Page Rotated 90 Degrees	304
Display with Fitting to the Width of the Paper	304
Display with All	304
Display with Actual Size	305
Moving a Page	305

Free Layout 307

The Features of Free Layout	307
Starting Free Layout	307
Free Layout Main Window	308
Paper Settings Panel	310
Easy Settings	311
Advanced Settings	312
Color Settings Panel	313
Color Adjustment	314
Matching	316
Driver Matching Mode	318
ICC Matching Mode	319
ColorSync	320
Preferences Dialog Box	320
Page Setup Dialog Box	321
Zoom Dialog Box	322
Format Dialog Box	323
Laying out a Multiple-File Document on One Page	323
Laying out a Document Created with Multiple Application Programs on One Page	324
Selecting an Object	324
Changing the Object Size	324
Moving an Object	325
Rotating an Object	325
Laying out Objects Automatically	326

Aligning Objects	326
Changing the Object Overlapping Order	328
Pasting a Copied or Cut Object	329

Handling and Use of Paper

331

Paper

332

Types of Paper	332
Paper Sizes	332
Using Paper Other Than Genuine Paper and feed confirmed Paper	334
Printing on Paper Other Than Genuine Paper and feed confirmed Paper Using Existing Settings	335
Displaying the Paper Reference Guide	335
Updating paper information	338

Handling rolls

342

Attaching the Roll Holder to Rolls	342
Loading Rolls in the Printer	345
Changing the Type of Paper	350
Specifying the Paper Length	352
Removing the Roll from the Printer	352
Removing the Roll Holder from Rolls	356
Feeding Roll Paper Manually	357
Keeping Track of the Amount of Roll Paper Left	358
Specifying the Ink Drying Time for Rolls	358
Specifying the Cutting Method for Rolls	360
Cutting the Leading Edge of Roll Paper Automatically	366
Reducing Dust from Cutting Rolls	367
Roll Holder Set	368
Automatic Roll Switching	368

Handling sheets

369

Loading Sheets in the Printer	369
Printing From a Desired Starting Point	371
Removing Sheets	373

Stacker

375

Stacker	375
Installing and Removing the Stacker On the Printer	376
Ejecting to the Stacker	380
Ejecting to the Output Stacker	381

Media Configuration Tool (Windows)

383

The Features of Media Configuration Tool	383
Installation Procedures	383
Updating Media Information After Installation	385
Media Configuration Tool Main Window	389
Editing Media Type Information for Genuine Paper and Feed Confirmed Paper	390
Adding Media Types	391
Changing Media Names	395
Deleting Media Types You Have Added	397
Switching Media Types Display Show/Hide	399
Changing the Display Order of Media Types	401
Applying a Saved Media Information File on Another Computer	403
Checking the update	404

Media Configuration Tool (Mac OS)

405

The Features of Media Configuration Tool	405
Procedures for Installing	405
Updating Media Information After Installation	407

Media Configuration Tool Main Window	411
Editing Media Type Information for Genuine Paper and Feed Confirmed Paper	413
Adding Media Types	414
Changing Media Names	418
Deleting Media Types You Have Added	421
Switching Media Types Display Show/Hide	422
Changing the Display Order of Media Types	424
Applying a Saved Media Information File on Another Computer	426
Checking the update	428

Control Panel 429

Operations and Display Screen 430

Control Panel	430
Control Panel Display	432
How to View Instructions With Navigate	436
Checking Instructions During Printer Operations	438

Printer Menu 439

Printer Menu Operations	439
Menu Operations	440
Menu Structure	443
Menu Settings	449
Status Print	460
Printing Interface Setting Reports	463
Setting Control panel access lock	465

Printer Parts 467

Printer parts 468

Front	468
Printer Front	469
Stacker	470
Back	471
Top Cover (Inside)	472
Carriage	473
Ink Tank Cover (Inside)	474

Hard Disk 475

Printer Hard Disk Operations	475
Checking the Free Hard Disk Space	476
Erasing Data on the Printer's Hard Disk	477

Optional accessories 479

Network Setting 481

Network Environment 482

Network Environment	482
---------------------------	-----

Using RemoteUI 484

Using RemoteUI	484
----------------------	-----

Initial Settings 486

Configuring the IP Address on the Printer	486
Configuring the IP Address Using the Printer Control Panel	486
Configuring the IP Address Using ARP and PING Commands	487
Configuring TCP/IPv6 Network Settings	488
Configuring the Printer Driver Destination (Windows)	489
Configuring the Printer Driver Destination (Mac OS)	489
Configuring the Printer's TCP/IP Network Settings With RemoteUI	490

Mac OS Settings	493
Configuring the Destination in TCP/IP Networks	493
Configuring the Destination for Bonjour Network	493

Other Settings	494
Specifying Printer-Related Information	494
Configuring the Communication Mode Manually	495
Email Notification When Printing is Finished or Errors Occur	496
Initializing the Network Settings	496

Device Setup Utility (Windows)	497
imagePROGRAF Device Setup Utility	497
Installing imagePROGRAF Device Setup Utility	497
Configuring the IP Address Using imagePROGRAF Device Setup Utility	497

Print Job Management **501**

Status Monitor (Windows)	502
The Features of imagePROGRAF Status Monitor	502
Job Management Using imagePROGRAF Status Monitor	503

Printmonitor (Mac OS)	505
The Features of imagePROGRAF Printmonitor	505
Job Management Using imagePROGRAF Printmonitor	506

Accounting (Windows)	507
Accounting Manager	507
Launching the Accounting Manager	507
Accounting Manager Main Window	508
Job List Area	510
Accounting Manager Basic Procedures	511
Configuring Unit Costs in Accounting Manager	511
Setting the Unit Cost for Ink	512
Setting the Unit Cost for Paper	513
Setting the Unit Cost for Items Other Than Ink and Paper	514
Configuring Units and Display Settings in Accounting Manager	515
Automatically Acquiring Print Job Logs at Regular Intervals	515
Canceling Regular Print Job Log Acquisition	516
Switching Between Displaying Jobs on Printer and Regularly Acquired Jobs	516
Exporting Print Job Data as a CSV File	516
Displaying Job Properties or Period Properties	517
Showing, Saving and Loading Selected Unit Cost Data	518
Showing the Total Amount of Ink and Paper Consumed	518

Basic Print Job Operations	519
Using the Printer Hard Disk	519
Saving Print Jobs on the Printer Hard Disk	520
Managing the Job Queue (Deleting or Preempting Other Jobs)	523
Managing Pending Jobs (Printing or Deleting Jobs on Hold)	525
Printing Saved Jobs	527
Deleting Saved Jobs	531
Moving Saved Jobs	534

Advanced Print Job Operations	538
Saving Print Jobs Sent from Sources Other than the Printer Driver	538
Printing Without Saving Jobs in the Common Box	539
Setting Passwords for Personal Boxes	540
Naming Personal Boxes	543
Displaying a List of Saved Jobs	545
Printing a List of Saved Jobs	548
Displaying Details of Saved Jobs	549
Renaming Saved Jobs	551

Adjustments for Better Print Quality 555

Adjusting the Printhead 556

Adjusting the Printhead	556
Automatic Adjustment to Straighten Lines and Colors	556
Manual Adjustment to Straighten Lines and Colors	558
Adjustment When Installing the Printhead	559
Adjusting Line Misalignment	560
Troubleshooting Paper Abrasion and Blurry Images	562

Adjusting the feed amount 564

Adjusting the Feed Amount	564
Selecting a Feed Amount Adjustment Method	564
Automatic Banding Adjustment	565
Manual Banding Adjustment	566
Fine-Tuning the Paper Feed Amount	568
Adjusting Line Length	568
Adjusting the Vacuum Strength	570

Maintenance and Consumables 573

Ink Tanks 574

Ink Tanks	574
Replacing Ink Tanks	574
Checking Ink Tank Levels	583
When to Replace Ink Tanks	583

Printheads 585

Printhead	585
Checking for Nozzle Clogging	585
Cleaning the Printhead	586
Replacing the Printhead	587

Maintenance Cartridge 593

Maintenance Cartridge	593
Replacing the Maintenance Cartridge	593
Checking the Remaining Maintenance Cartridge Capacity	597
When to Replace the Maintenance Cartridge	598

Cleaning the Printer 599

Cleaning the Printer Exterior	599
Cleaning Inside the Top Cover	599
Cleaning the Stacker	601

Other Maintenance 606

Preparing to Transfer the Printer	606
Reinstalling the Printer	611
Updating the Firmware	615

Troubleshooting 617

Frequently Asked Questions 618

Frequently Asked Questions	618
----------------------------------	-----

Problems Regarding Paper 619

Clearing Jammed Roll Paper	619
Clearing a Jammed Sheet	622
If There is a Paper Jam while Using the Stacker	624
Troubleshooting When Paper Jams are not Found	625
Roll paper cannot be inserted into the Paper Feed Slot	628
Cannot load sheets	628

Paper is not cut neatly	628
Paper is not cut	628
The Stacker continues to rotate	629
The size of clear film cannot be detected	629
Printing does not start	630
The Data lamp on the Control Panel does not light up	630
The printer does not respond even if print jobs are sent	630
Ink Filling.. is displayed	631
The display screen indicates Agitating	631
The printer stops during a print job	632
An error message is shown on the Display Screen	632
The printer ejects blank, unprinted paper	632
Problems with the printing quality	633
Printing is faint	633
Paper rubs against the Printhead	634
The edges of the paper are dirty	634
The surface of the paper is dirty	635
The back side of the paper is dirty	635
Printed colors are inaccurate	635
Banding in different colors occurs	636
Colors in printed images are uneven	637
Image edges are blurred or white banding occurs	637
Setting the Blue Switch on the Platen	638
The contrast becomes uneven during printing	640
The length of printed images is inaccurate in the feeding direction	640
Images are printed crooked	641
Documents are printed in monochrome	641
Line thickness is not uniform	641
Lines are misaligned	641
Cannot print over a network	642
Cannot connect the printer to the network	642
Cannot print over a TCP/IP network	642
Cannot print over a Bonjour network	642
Installation problems	643
Removing Installed Printer Drivers	643
HP-GL/2 problems	644
With HP-GL/2, printing is misaligned	644
Lines or images are missing in printed HP-GL/2 jobs.	644
Lines are printed too thick or thin in HP-GL/2 print jobs	644
HP-GL/2 jobs are printed in monochrome (or color)	644
Printed colors of lines are inaccurate during HP-GL/2 printing	645
HP-GL/2 jobs are printed 6 mm larger than specified	645
HP-GL/2 jobs are printed at maximum size, even if a standard size is specified	645
HP-GL/2 printing takes a long time	645
The printer stops when printing a HP-GL/2 job (the carriage stops moving)	645
Other problems	646
The printer does not go on	646
Cannot operate from the Control Panel	646
The printer takes time to start up	646
If the Printer Makes a Strange Sound	647
Messages advising to check the maintenance cartridge are not cleared	647
The printer consumes a lot of ink	647
Ink Level Detection	647

Error Message 651**Error Messages 652****Messages regarding paper 654**

MediaType Mismatch	654
PaprTypeMismatch	654
The paper is too small.	655
The paper is too small.	655
PaprWidth Mismatch	655
Paper size not detected.	656
Insufficient paper for job	656
This paper cannot be used as size is not supported.	657
Cannot print as selected. Another roll is in use.	657
Roll printing is selected.	657
Roll printing is selected, but sheets are loaded.	657
Roll x is selected. (x is 1 (Upper) or 2 (Lower))	657
Roll x is empty. (x is 1 (Upper) or 2 (Lower))	658
No Roll Unit.	658
Sheet removed.	659
Sheet printing is selected.	659
Regular printing is selected, but a roll is loaded.	659
Paper jam.	659
Roll x jam (x is 1 (Upper) or 2 (Lower))	660
Paper loaded askew.	660
Paper cutting failed.	660
End of paper feed.	661
Rel lever is in wrong position.	661
Borderless printing not possible.	661
Paper position not suitable for borderless printing.	662
Roll feed unit error.	662
The roll feed unit is loose.	662
Stacker not ready.	662
Cutting Mode not Automatic.	662

Messages regarding ink 663

Ink insufficient.	663
No ink left.	663
Remaining level of the ink cannot be correctly detected. Check ink tank.	663
Close Ink Tank Cover	663
Ink tank is empty.	663
Not much ink is left.	664
No ink tank loaded.	664
The following ink tanks cannot be recognized.	664
Wrong ink tank.	664

Messages regarding printing or adjustment 665

Cannot print as specified.	665
Borderless printing not possible. Paper stretched or shrank.	665
Before borderless printing, move the blue platen switch.	665
Blue platen switch is dirty.	665
Move the blue platen switch No.xx to the right. (xx represents a number)	665
Check printed document.	665

Messages regarding printheads 666

Cannot adjust printhead.	666
Wrong printhead.	666
Printhead error	666
Cannot recognize print head.	666
Execute printhead cleaning.	667

Messages regarding the maintenance cartridge 668

Insert the maintenance cartridge.	668
--	-----

Wrong maintenance cartridge.	668
Maint. cart. The level is low	668
No Maintenance Cartridge capacity.	668
Maintenance cartridge full.	668
Maintenance cartridge problem.	668

Messages regarding the hard disk 669

Hard disk error.	669
File read error.	669
The mail box is full.	669
Mail box full. Now printing without saving data.	669
Mail box nearly full.	669
Maximum jobs stored.	669
Mail box full. Delete unwanted data	669

Messages regarding HP-GL/2 670

This type of paper is not compatible with HP-GL/2.	670
GL2: Wxxxx The memory is full. (xxxx is 0501, 0903, or 0904)	670
GL2: W0502 The parameter is out of range.	670
GL2: W0504 This command is not supported.	670

Other Messages 671

GARO Wxxxx (x represents a number)	671
ERROR Exxx-xxxx (x represents a letter or number)	671
Hardware error. xxxxxxxx-xxxx (x represents a letter or number)	671
Top cover is open.	671
Prepare for parts replacement.	672
Parts replacement time has passed.	672
Unknown file.	672
Multi-sensor error	672

Specifications 673

Printer Specifications 674

Specifications	674
Print Area	675

Appendix 677

Safety Precautions 678

Safety Precautions	678
Legal Notices	680

Manuals for this printer 682

Manuals for this printer	682
About This User Manual	682

Disposal of the product 684

WEEE Directive	684
----------------------	-----

Memo

Basic Printing Workflow

Printing procedure	16
Canceling print jobs	24
Pausing Printing	27

Enhanced Printing Options	29
Windows Software	157
Mac OS Software	267
Handling and Use of Paper	331
Control Panel	429
Printer Parts	467
Network Setting	481
Print Job Management	501
Adjustments for Better Print Quality	555
Maintenance and Consumables	573
Troubleshooting	617
Error Message	651
Specifications	673
Appendix	677

Printing procedure

Printing Options Using Rolls and Sheets	16
Turning the Printer On and Off	17
Loading and Printing on Rolls	18
Loading and Printing on Sheets	21
→ Specifying Paper in the Printer Driver (Windows)	160
→ Specifying Paper in the Printer Driver (Mac OS)	269
Printing in Windows	22
Printing from Mac OS	22

Printing Options Using Rolls and Sheets

The printer supports both rolls and sheets.

This section introduces the main features of each, as well as the main printing methods available. Select rolls or sheets to suit your particular printing application.



Note

- For information on the types of paper the printer supports, see "Types of Paper." →P.332
- A variety of other ways to print are available besides those introduced here. For details, see "Enhanced Printing Options." →P.29

Roll printing

Media in spooled rolls is generally called Roll Media. Rolls are loaded on the Roll Holder, which are in turn loaded in the printer.

Rolls can be used to print large photos or create posters or banners that cannot be printed on regular sheets.

- Large-format printing
Easily print vertical or horizontal banners from familiar applications such as Microsoft Office applications. (See "Printing Vertical or Horizontal Banners (Large-Format Printing).") →P.101
- Borderless printing
Print without a margin (border) around posters or photos. (See "Borderless Printing on Paper of Equivalent Size.") →P.92
(See "Borderless Printing by Resizing Originals to Fit the Roll Width.") →P.95
(See "Borderless Printing at Actual Size.") →P.87
- Banner printing
You can print multiple pages as a single continuous image, without margins between pages. (See "Printing Multiple Pages Continuously.") →P.118
- 90-degree rotation before printing
Originals in portrait orientation are rotated 90 degrees when possible to use paper more efficiently. (See "Conserving Roll Paper by Rotating Originals 90 Degrees.") →P.137
- Enlarged/reduced printing
You can freely adjust the size of originals by enlarging or reducing originals before printing. (See "Resizing Originals to Match the Paper Size.") →P.72
(See "Resizing Originals to Fit the Roll Width.") →P.74
(See "Resizing Originals by Entering a Scaling Value.") →P.78
- Free Layout (Windows) and imagePROGRAF Free Layout (Mac OS)
Print multiple documents from multiple applications (such as word-processing programs, spreadsheet programs, and so on) next to each other. (See "Printing Multiple Originals Next to Each Other.") →P.114



- Loading two rolls at once (in the Roll 1 (Upper) and Roll 2 (Lower) holders) offers the following advantages.
 - Save the time and effort of switching paper
Loading roll paper of different media types or different sizes in the upper and lower rolls saves you the time and effort of replacing roll paper. You can select the desired roll paper in **Paper Source** in the printer driver.
(See "Page Setup Sheet (Windows).") →P.177
(See "Page Setup Pane (Mac OS).") →P.283
 - Automatic selection of the right paper for the print job
Selecting **Roll Paper (Auto)** in **Paper Source** in the printer driver enables automatic selection and printing on the roll that suits the print job from the loaded rolls.
Additionally, loading two rolls of the same type enables nonstop printing of multiple jobs. After one roll is completely used, the printer switches to the other roll automatically and continues printing.
(See "Using double-roll printing.") →P.31

Sheet printing

Sheets refer to individual sheets of paper.
Insert the sheet between the Platen and the Paper Retainer.

- Enlarged/reduced printing
You can freely adjust the size of originals by enlarging or reducing originals before printing.
(See "Resizing Originals to Match the Paper Size.") →P.72
(See "Resizing Originals by Entering a Scaling Value.") →P.78
- Free Layout (Windows) and imagePROGRAF Free Layout (Mac OS)
Print multiple documents from multiple applications (such as word-processing programs, spreadsheet programs, and so on) next to each other.
(See "Printing Multiple Originals Next to Each Other.") →P.114

Turning the Printer On and Off

Turning the printer on

- 1 Press the **Power** button to turn on the printer.
The printer will now start up.
After the Display Screen shows the Canon logo, "**Starting up Please wait.**" is displayed.

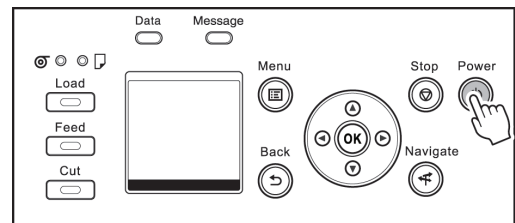

- 2 The printer goes online in preparation for printing after startup, and the Online lamp and paper source section lamp remain lit.

The printer will not go online in the following situations.
Take action as needed.

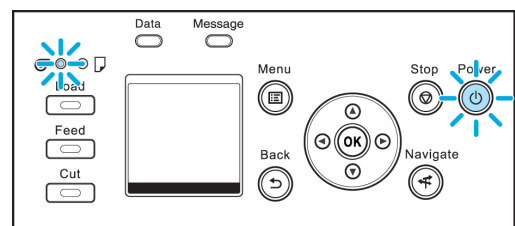

- The Top Cover is open
Close the Top Cover.

- The Ink Tank Cover is open
Close the Ink Tank Cover.
- The Printhead is not installed
Please see "Replacing the Printhead." →P.587
- Ink Tank is not installed
Please see "Replacing Ink Tanks." →P.574
- "ERROR" is shown on the Display Screen
Turn off the printer and contact your Canon dealer.
- The Online lamp and Message lamp are not lit (even once), and nothing appears on the Display Screen
Make sure the printer is plugged in correctly. Check the connection at the plug and electrical outlet.
- No paper is loaded
Load paper. (See "Loading and Printing on Rolls.") →P.18 (See "Loading and Printing on Sheets.") →P.21

Turning the printer off



Important

- Never disconnect the printer's power supply or unplug it during a print job. This may damage the printer.

1

Make sure no print jobs are in progress.
If the **Message Lamp** is flashing, check the message on the Display Screen and take action as necessary. (See "Error Messages.") →P.652

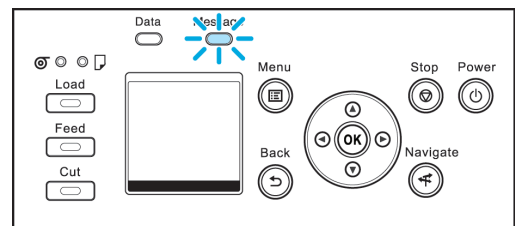

If the **Data Lamp** is flashing, the printer is receiving a print job. Turn off the printer only after printing is finished.

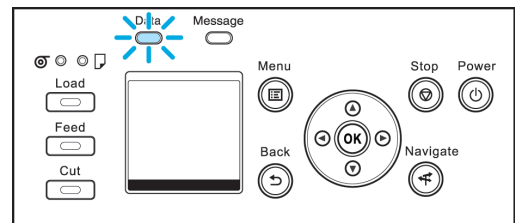

2

Hold down the **Power** button for more than a second.

After "**Shut Down.. Please Wait..**" is shown on the Display Screen, the printer shuts off.

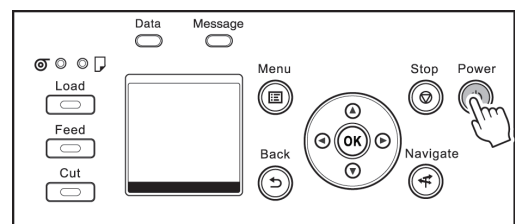

Loading and Printing on Rolls

18

These are the basic steps for loading and printing on rolls.
Follow these steps to load and print on rolls.



Note

- For details on supported sizes and types of rolls, see **Paper Sizes** or the **Paper Reference Guide**. (See "Paper Sizes.") →P.332 (See "Types of Paper.") →P.332
- To wait until the ink dries after printing before cutting the roll, set **Drying Time** in the printer driver. (See "Specifying the Ink Drying Time for Rolls.") →P.358
- Once you have used all the paper on a roll, clean the platen. If the Platen inside the Top Cover becomes dirty, it may soil the underside of paper. (See "Cleaning Inside the Top Cover.") →P.599

1 Turn the printer on. (See "Turning the Printer On and Off.") →P.17

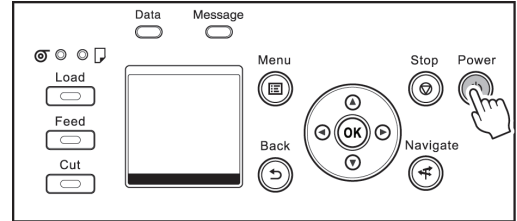

2 Load the roll on the Roll Holder. (See "Attaching the Roll Holder to Rolls.") →P.342

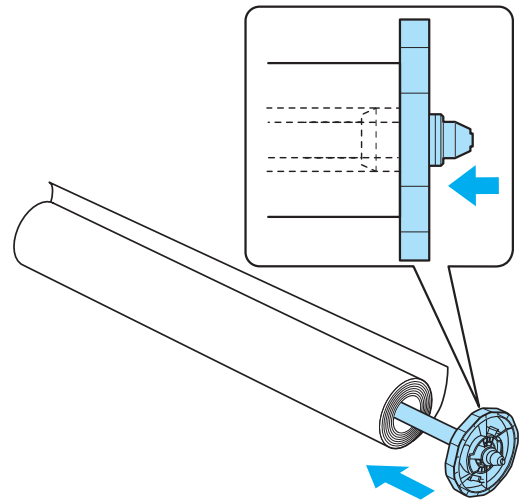

3 Load the roll in the printer. (See "Loading Rolls in the Printer.") →P.345

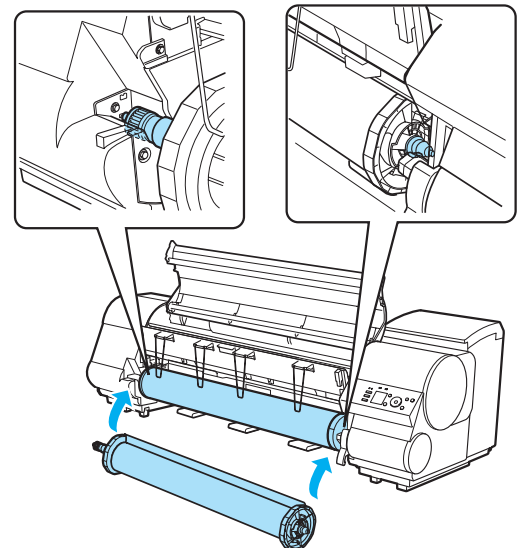

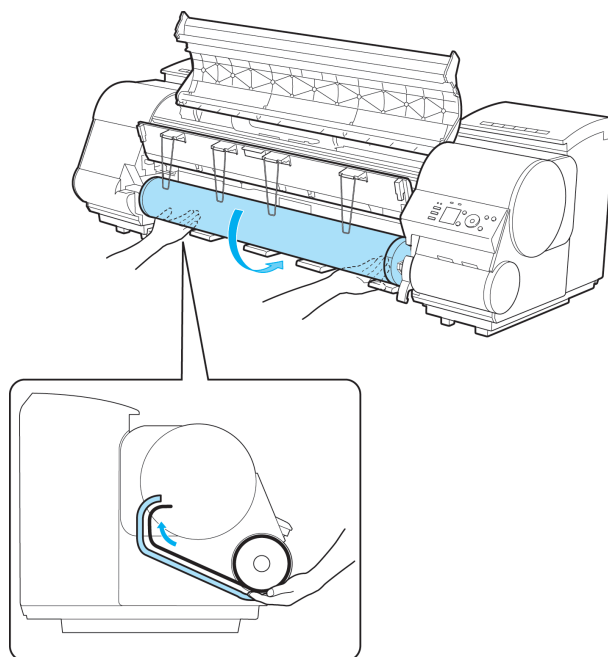

• When printing without borders, definitely set the blue Switch on the platen to the ● side. If the switch is set incorrectly, print quality may deteriorate. (See "Setting the Blue Switch on the Platen.") →P.638

4 Select the type of paper. (See "Changing the Type of Paper.") →P.350

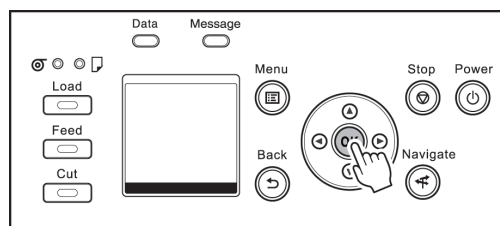

• If no barcode has been printed on the roll and you have set **ManageRemainRoll** to **On**, specify the roll length after the type of paper. (See "Specifying the Paper Length.") →P.352

5 Complete settings in the printer driver for the type of paper and other details.

- Specifying Paper in the Printer Driver (Windows) →P.160
- Specifying Paper in the Printer Driver (Mac OS) →P.269

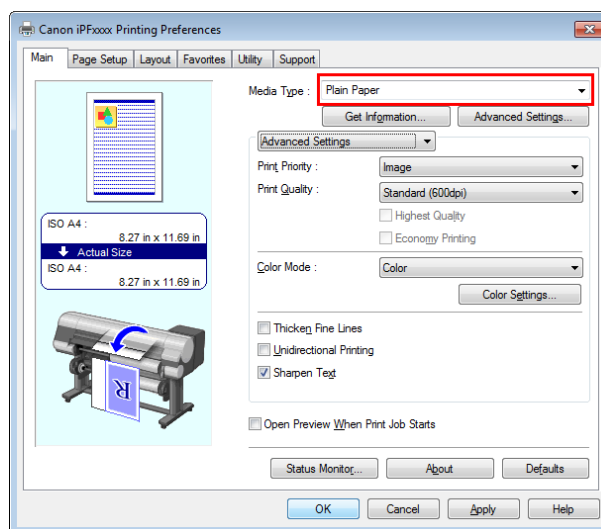

6 Send the print job.

- Printing in Windows →P.22

- **Printing from Mac OS** →P.22

The printer now starts printing the print job.

Loading and Printing on Sheets

These are the basic steps for loading sheets and then printing. Follow the steps below to load and print on sheets.



- For details on supported types and sizes of paper, see **Paper Sizes** or the **Paper Reference Guide**. (See "Paper Sizes.") →P.332 (See "Types of Paper.") →P.332
- Borderless printing is not supported on sheets. For the features and the main printing methods available for sheet printing, see "Printing Options Using Rolls and Sheets." →P.16

- 1** Turn the printer on. (See "Turning the Printer On and Off.") →P.17

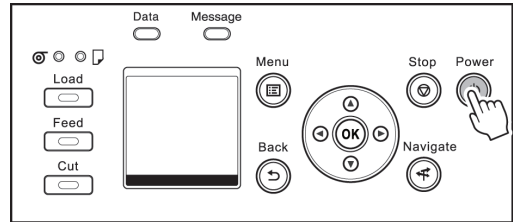

- 2** Complete settings in the printer driver for the type of paper and other details.

- **Specifying Paper in the Printer Driver (Windows)** →P.160
- **Specifying Paper in the Printer Driver (Mac OS)** →P.269

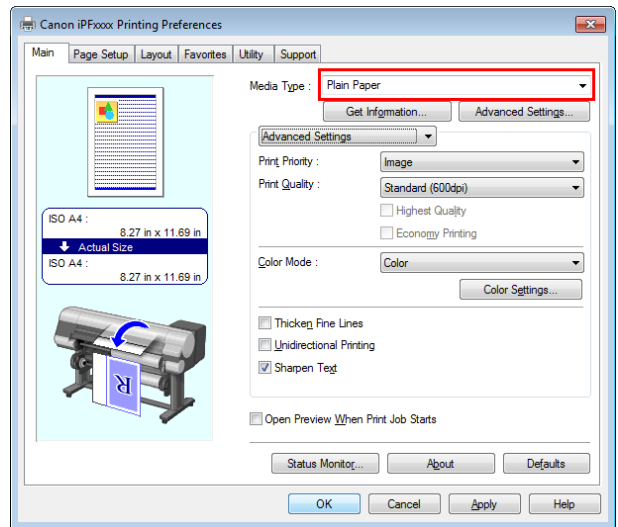

- 3** Send the print job.

- **Printing in Windows** →P.22
- **Printing from Mac OS** →P.22

- 4** Load the sheet. (See "Loading Sheets in the Printer.") →P.369

Start printing.

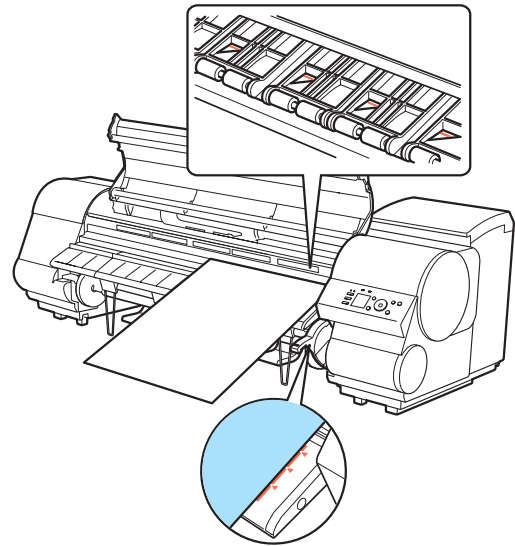

Printing in Windows

Print from the application menu.



Important

- We recommend exiting unnecessary applications before printing. Running several applications while printing may interrupt the transfer of print data and affect printing quality.

- 1** In the source application, select **Print** from the **File** menu to display the dialog box for printing conditions.

- 2** After confirming that the printer is selected in the dialog box, click **Print** or **OK** to start printing.



Note

- The appearance of the dialog box varies depending on the software application. In most cases, the dialog box includes basic printing options and enables you to choose the printer, specify the range of pages, number of copies, and so on.
Example: Print dialog box displayed by the application

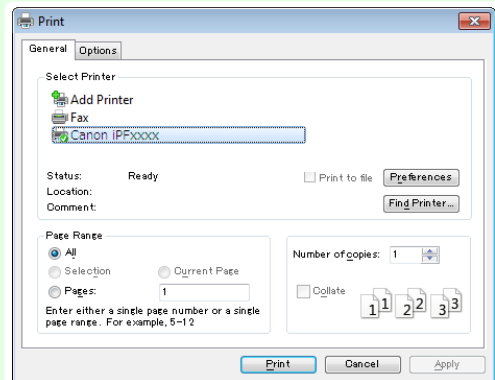

- If another printer is selected, select the printer you want to use under **Select Printer** or in the dialog box displayed after clicking **Printer**.

Settings for many printing methods (including enlarged or reduced printing, borderless printing, and so on) are displayed in the printer driver dialog box. There are two ways to access the printer driver dialog box, as follows.

- From the application
(See "Accessing the Printer Driver Dialog Box from Applications .") →P.164
- From the operating system menu
(See "Accessing the Printer Driver Dialog Box from the Operating System Menu .") →P.165

Printing from Mac OS

Print from the application menu after registering the printer.



Important

- We recommend exiting unnecessary applications before printing. Running several applications while printing may interrupt the transfer of print data and affect printing quality.

Registering the printer

The printer needs to be registered in **Print & Scan** (identified as **Printers & Scanners** or **Print & Fax** in other versions of Mac OS X) in **System Preferences** before printing.

For instructions on registering the printer, see "Configuring the Printer Driver Destination ." →P.489



- During this setup process, the printer will not be listed among available printers if it is off or disconnected.

Printing from the application software

1 In the application software, select **Print** from the **File** menu to display the dialog box for printing conditions.



- This dialog box includes basic printing options and enables you to choose the printer, specify the range of pages, number of copies, and so on.

2 Select the printer in the **Printer** list.

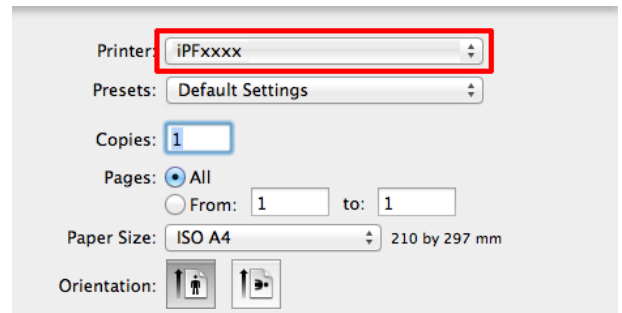

3 Click **Print** to start printing.
As shown in the following illustration, you can switch to other panes in this dialog box to complete settings for various methods of printing, including enlarged and reduced printing, borderless printing, and so on.

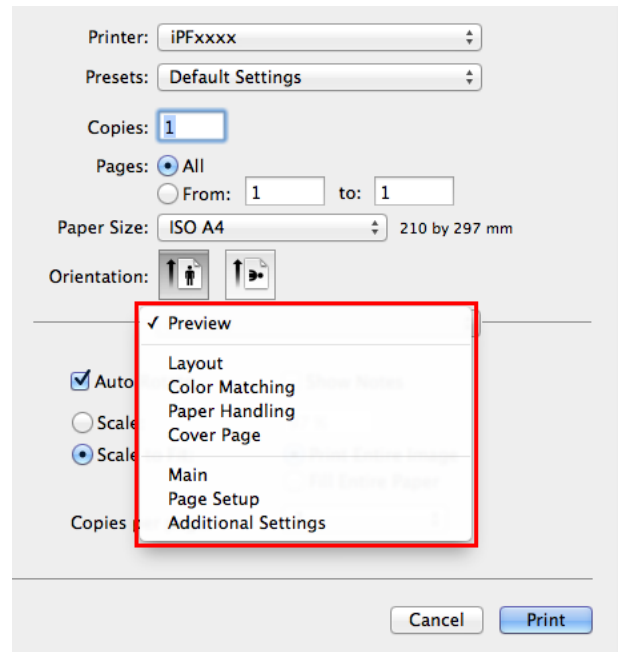

Canceling print jobs

- Canceling Print Jobs from the Control Panel 24
- Canceling Print Jobs from Windows 25
- Canceling Print Jobs from Mac OS 25

Canceling Print Jobs from the Control Panel

To cancel printing or reception of print jobs, press the **Stop** button on the Control Panel.

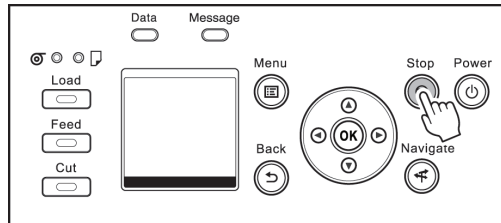

When you press the **Stop** button during printing, printer operation varies depending on the current status.

- If you press the **Stop** button before printing starts

Pressing the **Stop** button before printing starts will display a confirmation message. To cancel the print job, select **Yes**.

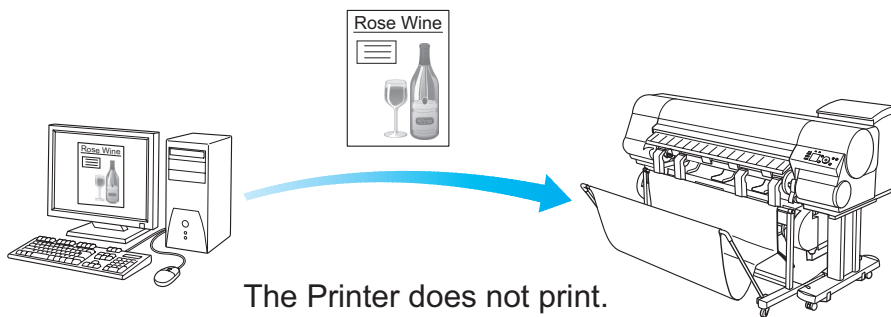

- If you press the **Stop** button during printing

Pressing the **Stop** button during printing will display a confirmation message. To cancel the print job immediately, select **Yes**.

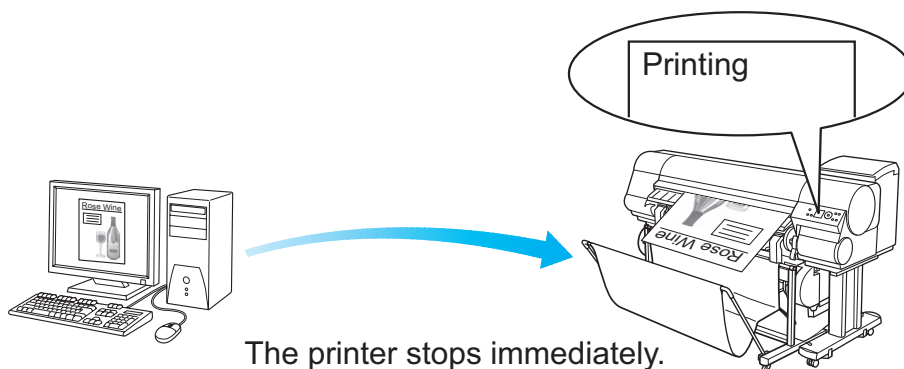

Canceling Print Jobs from Windows

In the printer window, you can cancel jobs that are being sent to the printer. Using **imagePROGRAF Status Monitor**, you can cancel print jobs that have already been received by the printer or that are currently being printed.

1 Click the printer icon in the taskbar to display the printer window.

 **Note**

- You can proceed from the folder for configuring the printer settings in the OS you are using. For example, in Windows 7, open the **Devices and Printers** window from the **start** menu and double-click the printer icon.

2 Right-click the job to cancel and select **Cancel**.

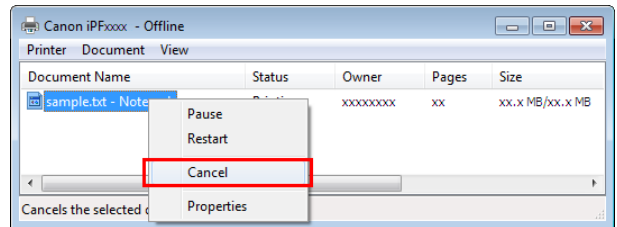

3 If the job to cancel is not shown in the printer window (that is, if the print data has already been received by the printer), double-click the taskbar icon to display **imagePROGRAF Status Monitor**.

4 On the **Printer Status** sheet, click **Cancel Job**.

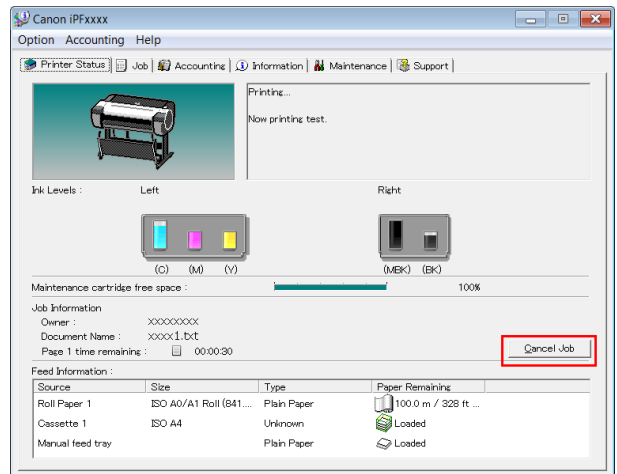

 **Note**

- The screen may differ slightly depending on the model you are using.

Canceling Print Jobs from Mac OS

In the printer window, you can cancel jobs that are being sent to the printer. Otherwise, you can cancel jobs from **imagePROGRAF Printmonitor** if they have been received by the printer or are currently being printed.

 **Note**

- Print jobs are shown in the printer window while they are being sent from the computer. After transmission, jobs are not displayed even during printing.
- Print jobs are displayed in the **imagePROGRAF Printmonitor** window from the moment the printer starts receiving the print data until the moment printing is finished. They are not displayed before print data is sent to the printer, even if the computer has started preparing the print data.

1 Click the printer icon in the **Dock** to display the printer window.

2 Either click **✕** for the job to cancel printing or select the job to cancel printing and then click **Delete** to delete the job.

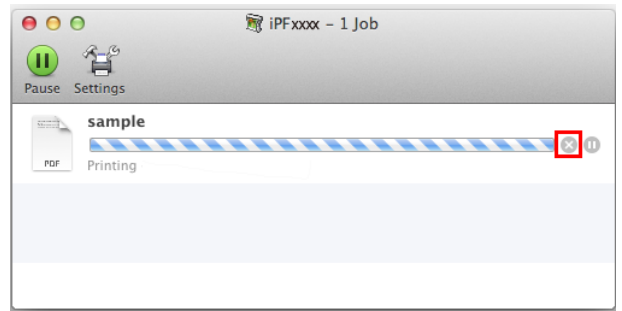

3 If there are no jobs to stop in the printer window (if sending the print data to the printer has finished), either click **Settings**, **Utility**, and then **Open Printer Utility**, or click **Utility** to open the imagePROGRAF Printmonitor.

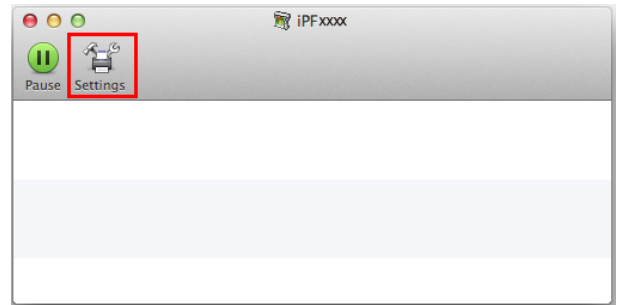

4 Select the print job to cancel and click  to delete the print job.

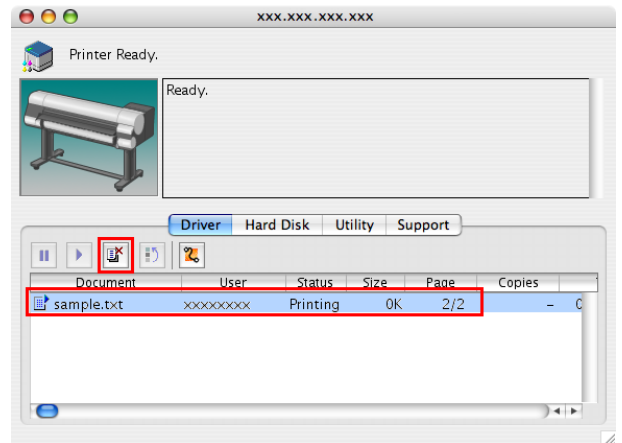

 **Note** • The screen may differ slightly depending on the model you are using.

The job sent to the printer is canceled.

5 Exit imagePROGRAF Printmonitor. In the printer window, click **Resume** or **Resume Printer**.

 **Important** • Always follow these steps if you cancel print jobs from imagePROGRAF Printmonitor. If you do not restart job processing, the next job cannot be printed.

Pausing Printing

Pausing Printing

During printing, if you set **Pause Print** in the Control Panel menu to **On**, printing is stopped at that point and the printer enters a state in which printing is paused. (See "Control Panel Display.") →P.432
Printing from the job queue is not possible in this state.

To restore normal operation after this state, set **Pause Print** to **Off**.



Note

- In the following cases, the status is cleared even if you do not set **Pause Print** to **Off**, and printing from the job queue resumes.
 - When paper is advanced
 - When you execute **Chg. Paper Type** in the **Paper Menu**

- 1 During printing, on the **Tab Selection screen** of the Control Panel, press ◀ or ▶ to select the Job tab ().

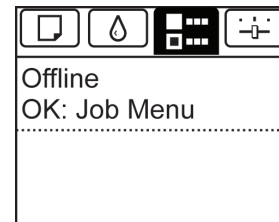

Note

- If the **Tab Selection screen** is not displayed, press the **Menu** button.

- 2 Press the **OK** button.
The **Job Menu** is displayed.
- 3 Press ▲ or ▼ to select **Pause Print**, and then press the **OK** button.
- 4 Press ▲ or ▼ to select **On** or **Off**, and then press the **OK** button.

Memo

Basic Printing Workflow 15

Enhanced Printing Options

- Choosing Paper for Printing 30
- Using double-roll printing 31
- Printing Photos and Office Documents 43
- Printing CAD Drawings 52
- Adjusting Images 60
- Printing enlargements or reductions 72
- Printing at full size 83
- Borderless Printing 92
- Printing banners or at other non-standard sizes 101
- Tiling and multiple pages per sheet 114
- Centering originals 128
- Conserving roll paper 137
- Checking Images Before Printing 145
- Other useful settings 146

Windows Software 157

Mac OS Software 267

Handling and Use of Paper 331

Control Panel 429

Printer Parts 467

Network Setting 481

Print Job Management 501

Adjustments for Better Print Quality 555

Maintenance and Consumables 573

Troubleshooting 617

Error Message 651

Specifications 673

Appendix 677

Choosing Paper for Printing

Choosing a Paper for Printing	30
➔ Changing the Type of Paper	350
Specifying Paper in the Printer Driver	30
➔ Specifying Paper in the Printer Driver (Windows)	160
➔ Specifying Paper in the Printer Driver (Mac OS)	269

Choosing a Paper for Printing

Select the appropriate media type from the printer control panel or printer driver to match the paper loaded in the printer. The appropriate media type differs between the case of genuine Canon paper or Canon feed confirmed paper and the case of paper other than Canon feed confirmed paper. Select the media type by following the description below.

For information on how to select the media type in the printer control panel, see **Changing the Type of Paper** ➔P.350 , and for information on how to select the media type in the printer driver, see **Specifying Paper in the Printer Driver (Windows)** ➔P.160 or **Specifying Paper in the Printer Driver (Mac OS)** ➔P.269 .



- If you use paper other than Canon feed confirmed paper, Canon provides absolutely no guarantees regarding print quality or paper feed properties.



- Genuine Canon paper and Canon feed confirmed paper are detailed in **Paper Reference Guide**.
- An error message is displayed on the printer Control Panel if the media type specified in the printer driver does not match the media type specified in the printer. Although you can print under these conditions, the printing results may not be suitable.

Genuine Canon paper or Canon feed confirmed paper

For genuine Canon paper or Canon feed confirmed paper, select the settings that are optimized for that type of paper. For more information on the settings for genuine Canon paper or Canon feed confirmed paper, see "Displaying the Paper Reference Guide." ➔P.335

Paper other than Canon feed confirmed paper

For paper other than Canon feed confirmed paper, printing can be performed easily by selecting the existing settings provided by the printer control panel or printer driver. For details, see "Using Paper Other Than Genuine Paper and feed confirmed Paper." ➔P.334

Specifying Paper in the Printer Driver

If you replace the paper, complete the printer driver settings for the paper type and size.

For instructions on configuring paper settings in the printer driver, refer to the following topics, as appropriate for your operating system.

- **Specifying Paper in the Printer Driver (Windows)** ➔P.160
- **Specifying Paper in the Printer Driver (Mac OS)** ➔P.269

Using double-roll printing

- About Double-roll Switching 31
- Loading Roll Paper in the Printer Depending on the Purpose 31
- Printing by Automatically Switching Between Upper and Lower Roll Paper 32
 - Printing by Automatically Switching Between Upper and Lower Roll Paper (Windows) 32
 - Printing by Automatically Switching Between Upper and Lower Roll Paper (Mac OS) 37
- Roll Paper Switching Method 39

About Double-roll Switching

With this printer, you can load roll paper in both the upper (roll paper 1) and lower (roll paper 2) rolls, and print by automatically switching between roll paper 1 and roll paper 2 depending on the print job.

This printing by automatically switching between roll paper 1 and roll paper 2 is called "double-roll switching".

- For an example of loading roll paper, see "Loading Roll Paper in the Printer Depending on the Purpose." →P.31
- For details on the procedure for double-roll switching, see "Printing by Automatically Switching Between Upper and Lower Roll Paper." →P.32
- Details on how switching between roll paper 1 and roll paper 2 is performed depending on the case are summarized in "Roll Paper Switching Method" →P.39 . Refer to this as necessary such as when the printing is not as you expected.

Loading Roll Paper in the Printer Depending on the Purpose

When performing double-roll switching, load the roll paper in the upper and lower printer rolls in one of the following ways depending on the purpose.

- When continuously printing large quantities of the same document, etc.

Load roll paper of the same width and same type in the upper and lower rolls.

Printing is performed by automatically switching to the other roll paper once the roll paper is out of paper.

Example of paper to load

Paper source	Roll Paper Width	Media Type
Upper	A1/A2 Roll (594.0 mm)	Plain Paper
Lower	A1/A2 Roll (594.0 mm)	Plain Paper

- When automatically switching between roll paper 1 and roll paper 2 depending on the paper size specified in the print job

Load roll paper of different widths but the same type in the upper and lower rolls.

Example of paper to load

Paper source	Roll Paper Width	Media Type
Upper	36-in. Roll (914.4 mm)	Plain Paper
Lower	A1/A2 Roll (594.0 mm)	Plain Paper

- When automatically switching between roll paper 1 and roll paper 2 depending on the type of media specified in the print job

Load roll paper of the same width but different types in the upper and lower rolls.

Alternately, load roll paper of different widths and different types in the upper and lower rolls.

Example of paper to load 1

Paper source	Roll Paper Width	Media Type
Upper	A1/A2 Roll (594.0 mm)	Plain Paper
Lower	A1/A2 Roll (594.0 mm)	Canon Coated Paper

Example of paper to load 2

Paper source	Roll Paper Width	Media Type
Upper	36-in. Roll (914.4 mm)	Plain Paper
Lower	A1/A2 Roll (594.0 mm)	Canon Coated Paper



Important

- Double-roll switching cannot function if roll paper of a media type that cannot be automatically cut is fed to the platen.
For information on support for automatic cutting, refer to **Paper Reference Guide**. (See "Displaying the Paper Reference Guide.") →P.335



Note

- For details on how to load roll paper in the printer, see "Handling rolls." →P.342
- If roll paper of different widths and different types are loaded in the upper and lower rolls, printing is performed on the roll paper that matches the media types specified in the print job. Since errors may occur or printing may be performed on the unintended roll depending on the settings, it is recommended in this case that you print by specifying the better suited roll paper 1 or roll paper 2 without using double-roll switching.

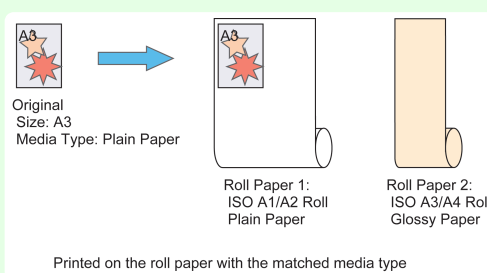

- For more information on how the paper sources are switched, see "Roll Paper Switching Method." →P.39

Printing by Automatically Switching Between Upper and Lower Roll Paper

Prints by automatically switching between roll paper 1 and roll paper 2 depending on the type of media and size specified in the print job.

For details, refer to the following topics depending on the operating system you are using.

- **Printing by Automatically Switching Between Upper and Lower Roll Paper (Windows)** →P.32
- **Printing by Automatically Switching Between Upper and Lower Roll Paper (Mac OS)** →P.37

Printing by Automatically Switching Between Upper and Lower Roll Paper (Windows)

This section describes how to print by automatically switching between roll paper 1 and roll paper 2 depending on the print job.

Normally, refer to Basic Printing Method →P.33 .

If you want to print by reducing as much margin of roll paper as possible, refer to Method of Conserving More Paper →P.34 . In this case, you need to load roll paper of the same media type in the upper and lower rolls.



Important

- If you set **Set./Adj. Menu>System Setup>Roll Switching** to **No RollSwitching** in the control panel, printing may be performed on the unintended roll paper. It is recommended that you set this setting to **Use Optimal Size** in advance.
- Double-roll switching cannot function if roll paper of a media type that cannot be automatically cut is fed to the platen.
For information on support for automatic cutting, refer to **Paper Reference Guide**. (See "Displaying the Paper Reference Guide.") →P.335

Basic Printing Method

Perform using the following procedure.

1 Load roll paper in the upper and lower printer rolls.



- Load roll paper of width and media type that suits your purpose in the printer by referring to **Loading Roll Paper in the Printer Depending on the Purpose** →P.31 .
- For details on how to load roll paper in the printer, see **"Handling rolls."** →P.342

2 Choose **Print** in the application menu.

3 Select the printer in the dialog box, and then display the printer driver dialog box. (See **"Accessing the Printer Driver Dialog Box from Applications ."**) →P.164

4 Make sure the **Main** sheet is displayed.

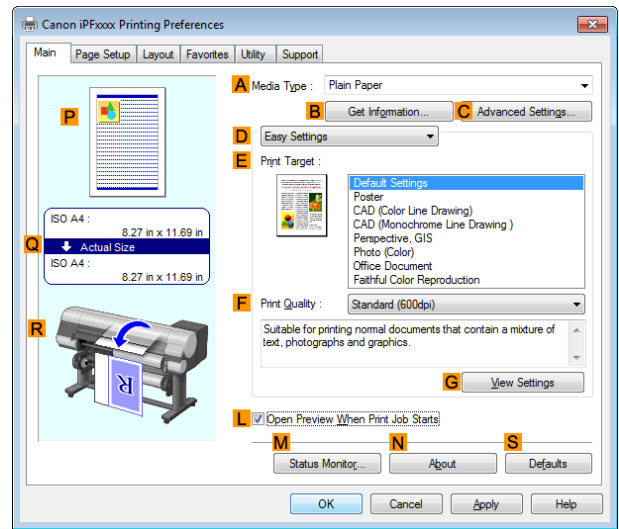

5 Click the type of media to use for printing from the **A Media Type** list.



- Always specify the media type of the roll paper that is loaded in the printer.

6 Click the **Page Setup** tab to display the **Page Setup** sheet.

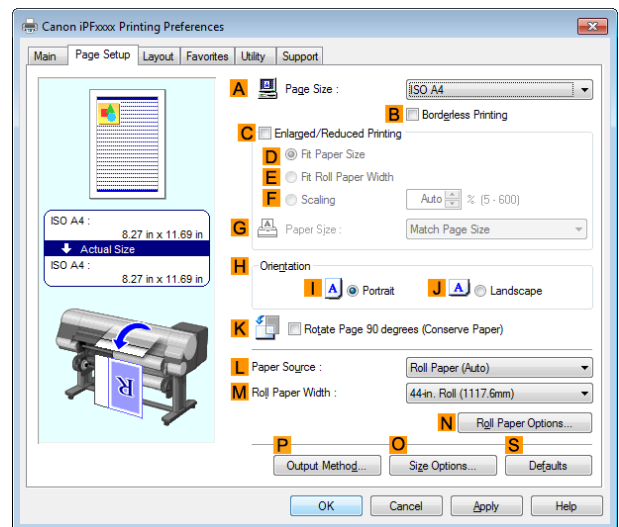

7 In the **A Page Size** list, select and click the size of the original as specified in the application.

8 Select and click **Roll Paper (Auto)** from the **L Paper Source** list.

9 To use the function for automatically rotating portrait documents by 90 degrees, select the **K Rotate Page 90 degrees (Conserve Paper)** check box. Furthermore, select and click the width of the roll paper loaded in the printer from the **M Roll Paper Width** list.



- When **Rotate Page 90 degrees (Conserve Paper)** is selected, pages that were created in the portrait orientation are printed in the landscape orientation by rotating 90 degrees, which may save paper depending on the paper size.



- When the **Rotate Page 90 degrees (Conserve Paper)** is selected, printing by rotating the document by 90 degrees is performed only when the width specified in **Roll Paper Width** accommodates the vertical length of the document. Therefore, when using this function, you should set **Roll Paper Width** correctly to the width of either of the rolls loaded in the printer.

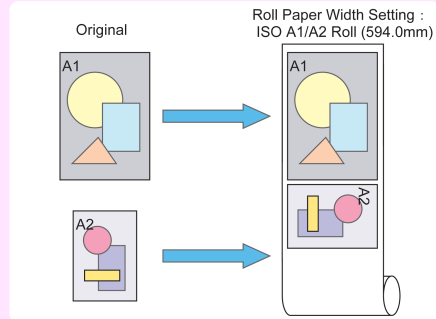

- If the media types of the roll paper loaded in the upper and lower rolls are different, printing is performed on the roll paper that matches the media type specified in the print job. If both the width and media type of the roll paper loaded in the upper and lower rolls are different when using the function for rotating the document by 90 degrees, you should correctly set the combination of roll paper width and media type for any one of the rolls loaded in the printer.

10 Confirm the print settings and print as desired.



- For tips on confirming print settings, see "Confirming Print Settings ." →P.161
- For more information on how the paper sources are switched depending on the print job, see "Roll Paper Switching Method." →P.39

Method of Conserving More Paper

Determine the roll paper that better reduces the margins depending on the paper size specified in the print job. Perform printing using the conditions that most reduce the paper margins among the combinations of roll paper 1 and roll paper 2 for the cases of rotating or not rotating pages by 90 degrees.

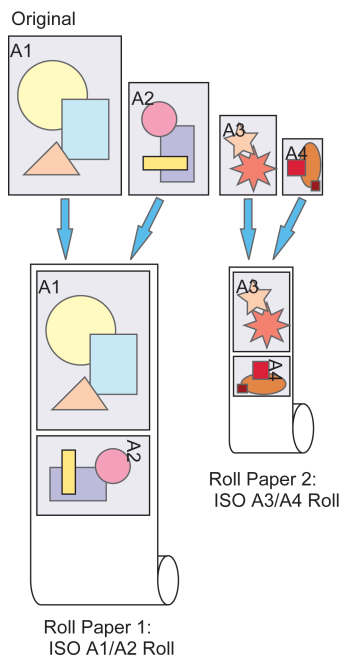



Important

- This function can be used with the Windows driver.
- With this method, the upper and lower rolls are switched depending on the paper size specified in the print job. Therefore, you must use the same media type for the roll paper in the upper and lower rolls of the printer. If you load different media types, an error may occur or the printing might not be as intended.



Note

- If the margin from roll paper 1 and roll paper 2 is the same, printing is performed on roll paper 1.

1

Load roll paper of the same media type in the upper and lower printer rolls.



Note

- For details on how to load roll paper in the printer, see "Handling rolls." →P.342

2

Click **start >Devices and Printers**.

3

Right-click the icon of this printer and choose **Printer Properties** to open the printer properties window.

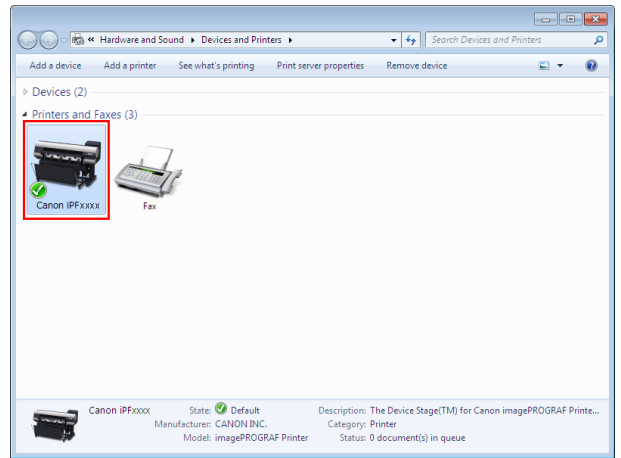

4

Click the **Device Settings** tab to display the **Device Settings** sheet.

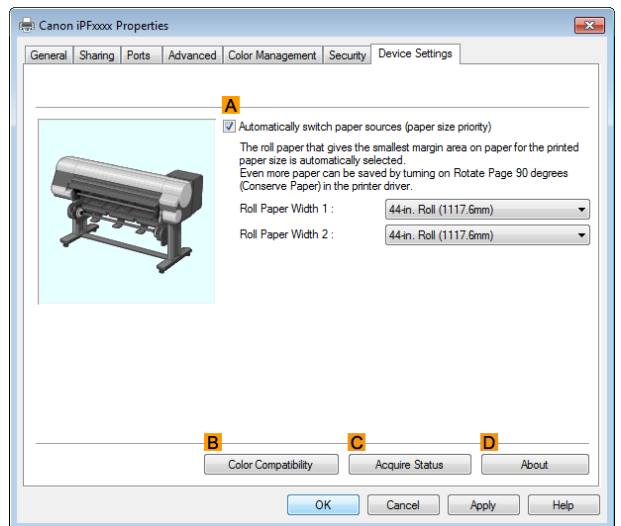

5

Select the **A** **Automatically switch paper sources (paper size priority)** check box.

6

Click **C** **Acquire Status**.

The paper size information is acquired from the printer, and the width of the roll paper that is actually loaded in the printer is displayed.



Important

- When replacing the roll paper loaded in the printer, always click the **Acquire Status** button to get the roll paper width information. If the roll paper width is not set correctly, printing might not be as intended.

- 7** Click **OK** to close the dialog box.
- 8** Choose **Print** in the application menu.
- 9** Select the printer in the dialog box, and then display the printer driver dialog box. (See "Accessing the Printer Driver Dialog Box from Applications .") →P.164
- 10** Make sure the **Main** sheet is displayed.

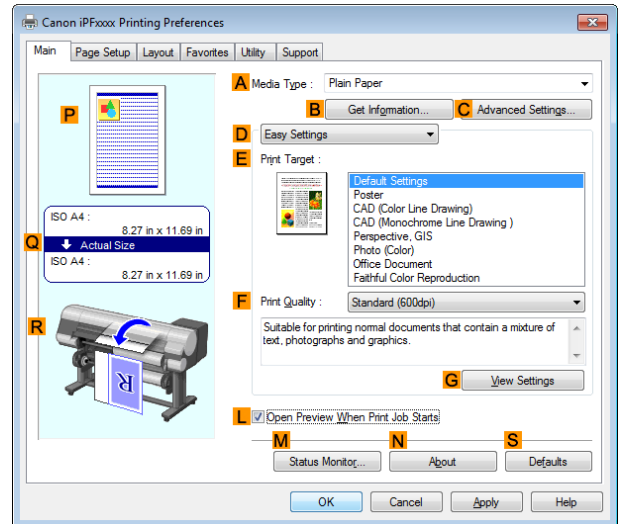

- 11** In the **A Media Type** list, click the type of paper that is loaded.



- Always specify the media type of the roll paper that is loaded in the printer.

Note

- 12** Click the **Page Setup** tab to display the **Page Setup** sheet.

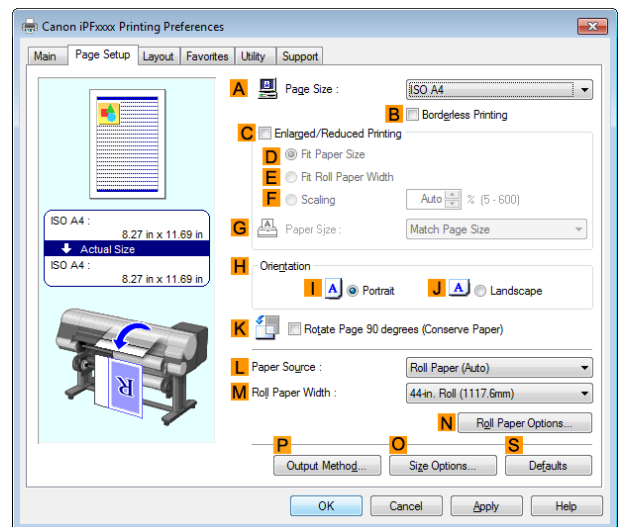

- 13** In the **A Page Size** list, select and click the size of the original as specified in the application.

- 14** Click to select **Roll Paper (Auto)** from the **L Paper Source** list.

- 15** Select the **K Rotate Page 90 degrees (Conserve Paper)** check box as necessary.

- 16** Confirm the print settings and print as desired.



- For tips on confirming print settings, see "Confirming Print Settings ." →P.161

Note



- If the same width and same media type of roll paper is loaded in the upper and lower rolls and **Automatically switch paper sources (paper size priority)** is enabled, printing is always performed on roll paper 1 (upper roll paper). If you want to load roll paper of the same width and media type in the upper and lower rolls and automatically switch between them, clear the **Automatically switch paper sources (paper size priority)** check box.
- If **Fit Roll Paper Width** is selected in **Enlarged/Reduced Printing** and **Roll Paper (Auto)** is selected in **Paper Source** on the **Page Setup** sheet while you are performing enlarged/reduced printing with **Automatically switch paper sources (paper size priority)** enabled, printing is always performed from roll paper 1 (the upper roll paper).
- If you are performing borderless printing with **Automatically switch paper sources (paper size priority)** enabled, only **Scale to fit Roll Paper Width** can be selected in **Borderless Printing Method** on the **Page Setup** sheet. In this case, printing is always performed from roll paper 1 (the upper roll paper). If a paper size or media type that does not support borderless printing is loaded in roll paper 1, you cannot perform borderless printing.

Printing by Automatically Switching Between Upper and Lower Roll Paper (Mac OS)

This section describes how to print by automatically switching between roll paper 1 and roll paper 2 depending on the print job.



- If you set **Set./Adj. Menu>System Setup>Roll Switching** to **No RollSwitching** in the control panel, printing may be performed on the unintended roll paper. It is recommended that you set this setting to **Use Optimal Size** in advance.
- Double-roll switching cannot function if roll paper of a media type that cannot be automatically cut is fed to the platen.
For information on support for automatic cutting, refer to **Paper Reference Guide**. (See "Displaying the Paper Reference Guide.") →P.335

1 Load roll paper in the upper and lower printer rolls.



- Load roll paper of width and media type that suits your purpose in the printer by referring to **Loading Roll Paper in the Printer Depending on the Purpose** →P.31 .
- For details on how to load roll paper in the printer, see "**Handling rolls.**" →P.342

2 Choose **Page Setup** from the application menu to display the **Page Attributes** dialog box.

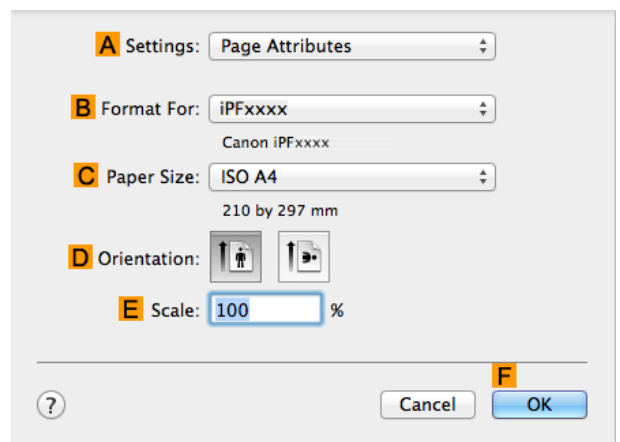

- **Page Setup** might not be displayed in the menu depending on the OS you are using and the application software. In this case, select **Print** from the menu in the application software, and configure the settings in the upper part of the printer driver screen that is displayed.

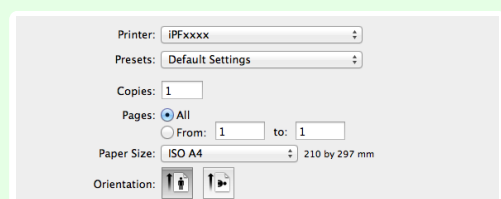

- 3** Select the printer in the **B Format for** list.
- 4** In the **C Paper Size** list, click the size of the original as specified in the application.
- 5** Click **F OK** to close the dialog box.
- 6** Choose **Print** in the application menu.
- 7** Access the **Main** pane.

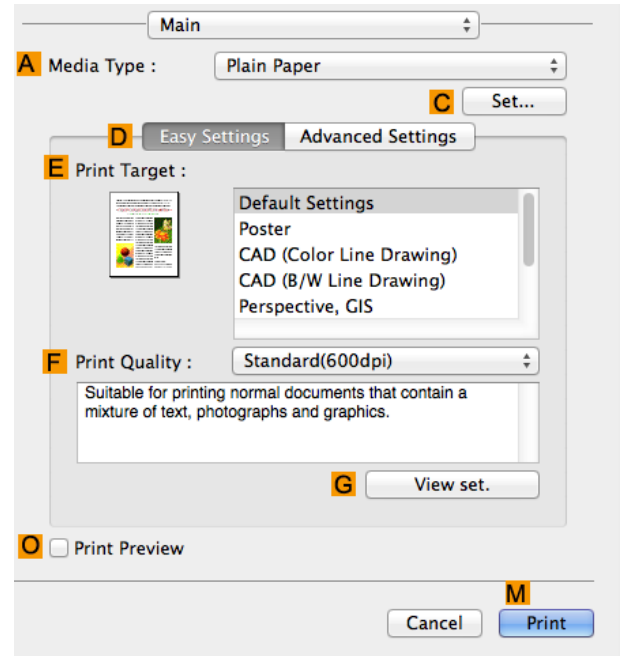

- 8** Select the type of media to use for printing from the **A Media Type** list.

 **Note** • Always specify the media type of the roll paper that is loaded in the printer.

- 9** Access the **Page Setup** pane.

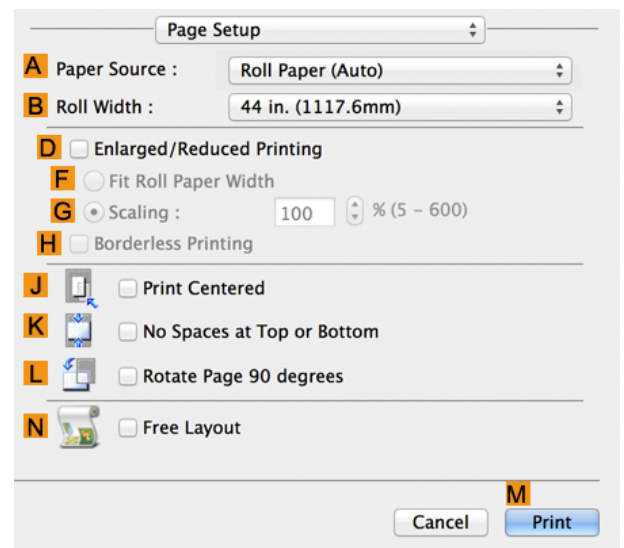

- 10** Click to select **Roll Paper (Auto)** from the **A Paper Source** list.

11 To use the function for automatically rotating portrait documents by 90 degrees, select the **L Rotate Page 90 degrees** check box. Furthermore, select and click the width of the roll paper loaded in the printer from the **B Roll Width** list.

Note • When **Rotate Page 90 degrees** is selected, pages that were created in the portrait orientation are printed in the landscape orientation by rotating 90 degrees, which may save paper depending on the paper size.

Important • When the **Rotate Page 90 degrees** is selected, printing by rotating the document by 90 degrees is performed only when the width specified in **Roll Width** accommodates the vertical length of the document. Therefore, when using this function, you should set **Roll Width** correctly to the width of either of the rolls loaded in the printer.

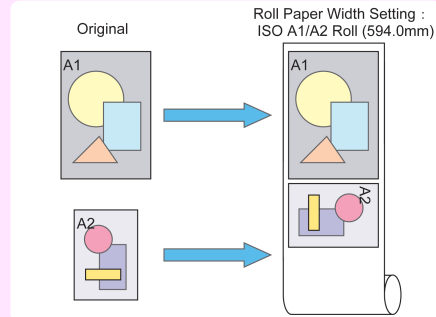

• If the media types of the roll paper loaded in the upper and lower rolls are different, printing is performed on the roll paper that matches the media type specified in the print job. If both the width and media type of the roll paper loaded in the upper and lower rolls are different when using the function for rotating the document by 90 degrees, you should correctly set the combination of roll paper width and media type for any one of the rolls loaded in the printer.

12 Confirm the print settings, and then click **M Print** to start printing.

Note • For tips on confirming print settings, see "Confirming Print Settings ." →P.270
 • For more information on how the paper sources are switched depending on the print job, see "Roll Paper Switching Method." →P.39

Roll Paper Switching Method

This section describes how the printer switches between roll paper 1 and roll paper 2 depending on the case. Refer to this as necessary such as when the printing is not as you expected.

When **Roll Paper (Auto)** is selected from the **Paper Source** list in the printer driver, the more suitable roll paper loaded in the upper or lower roll of the printer is automatically selected depending on the print job.

Whether to use roll paper 1 or roll paper 2 is determined in order from "Condition 1" to "Condition 7" in the following table.

At this time, the result of the determination changes depending on the **Set./Adj. Menu>System Setup>Warning>Detect Mismatch** setting in the printer control panel is set to which one of the following.

- The If the **Detect Mismatch** setting is set to **Pause** or **Hold Job** →P.39
- The If the **Detect Mismatch** setting is set to **Warning** or **None** →P.41

Note • If an error or a hold occurs, change the paper to match the print job.
 • The following setting in the printer control panel is recommended in order to reduce paper waste.

- **Set./Adj. Menu>System Setup>Roll Switching** is set to **Use Optimal Size**
- **Paper Menu>Paper Details>(Each media type)>Width Detection** is set to **On**

• If the **Automatically switch paper sources (paper size priority)** check box is selected in the **Device Settings** sheet in the Windows driver, the following table should not be followed.

If the **Detect Mismatch** setting is set to **Pause** or **Hold Job**

Condition	Status	Judgment result
Condition 1 Is the roll paper loaded in the printer long enough to print the paper size specified in the print job?	Only either roll paper 1 or roll paper 2 is long enough	The roll paper with enough length is selected

Condition		Status	Judgment result
Condition 1	Is the roll paper loaded in the printer long enough to print the paper size specified in the print job?	Neither roll paper 1 nor roll paper 2 is long enough	Error
		Both roll paper 1 and roll paper 2 are long enough	Go to Condition 2
		ManageRemainRoll is set to Off in the printer menu (the roll paper length cannot be identified)	
Condition 2	Does the roll paper loaded in the printer match the media type specified in the print job?	Only either roll paper 1 or roll paper 2 matches	The roll paper with the matched media type is selected
		Neither roll paper 1 nor roll paper 2 matches	Error or hold
		Both roll paper 1 and roll paper 2 match	Go to Condition 3
Condition 3	What is the Roll Switching setting in the printer menu?	Set to No RollSwitching	The roll paper currently fed to the platen is selected (*1)
		Set to Use Optimal Size	Go to Condition 4
Condition 4	Borderless printing is specified in the print job (if not specified, go to Condition 5)	Only either roll paper 1 or roll paper 2 is paper that can be used for borderless printing	The roll paper that can be used for borderless printing is selected
		Neither roll paper 1 nor roll paper 2 is paper that can be used for borderless printing	Error
		Both roll paper 1 and roll paper 2 are paper that can be used for borderless printing	Go to Condition 5
Condition 5	Does the roll paper width specified in the print job match the width of roll paper loaded in the printer? (Only for borderless printing or enlarged/reduced printing)	Only either roll paper 1 or roll paper 2 is roll paper of the width specified in the print job	The roll paper with the matched roll paper width is selected
		Neither roll paper 1 nor roll paper 2 is roll paper of the width specified in the print job	Error or hold
		Both roll paper 1 and roll paper 2 are roll paper of the width specified in the print job	Go to Condition 6
		The roll paper width is not specified in the print job	
Condition 6	Does the width of roll paper loaded in the printer accommodate the width of the paper size specified in the print job?	Only either roll paper 1 or roll paper 2 accommodates the paper size width specified in the print job	The roll paper that accommodates the paper size width is selected
		Neither roll paper 1 nor roll paper 2 accommodates the paper size width specified in the print job	Error
		Both roll paper 1 and roll paper 2 accommodate the paper size width specified in the print job	Go to Condition 7
Condition 7	Are the widths of roll paper 1 and roll paper 2 different?	The roll paper widths are different	The roll paper with the smaller difference between the paper size width and the width specified in the print job is selected

Condition		Status	Judgment result
Condition 7	Are the widths of roll paper 1 and roll paper 2 different?	The roll paper width is the same	The roll paper currently fed to the platen is selected (*1)

*1: In the following case, neither roll paper 1 nor roll paper 2 is fed to the platen. In this case, roll paper 1 is selected.

- When the printer enters sleep mode and then resumes
- When the printer is turned on
- When cut sheet is supplied and ejected

If the **Detect Mismatch** setting is set to **Warning** or **None**

Condition		Status	Judgment result
Condition 1	Is the roll paper loaded in the printer long enough to print the paper size specified in the print job?	Only either roll paper 1 or roll paper 2 is long enough	The roll paper with enough length is selected
		Neither roll paper 1 nor roll paper 2 is long enough	Error
		Both roll paper 1 and roll paper 2 are long enough	Go to Condition 2
		ManageRemainRoll is set to Off in the printer menu (the roll paper length cannot be identified)	
Condition 2	Does the roll paper loaded in the printer match the media type specified in the print job?	Only either roll paper 1 or roll paper 2 matches	The roll paper with the matched media type is selected
		Neither roll paper 1 nor roll paper 2 matches	Go to Condition 3
		Both roll paper 1 and roll paper 2 match	
Condition 3	What is the Roll Switching setting in the printer menu?	Set to No RollSwitching	The roll paper currently fed to the platen is selected (*1)
		Set to Use Optimal Size	Go to Condition 4
Condition 4	Borderless printing is specified in the print job (if not specified, go to Condition 5)	Only either roll paper 1 or roll paper 2 is paper that can be used for borderless printing	The roll paper that can be used for borderless printing is selected
		Neither roll paper 1 nor roll paper 2 is paper that can be used for borderless printing	Error
		Both roll paper 1 and roll paper 2 are paper that can be used for borderless printing	Go to Condition 5
Condition 5	Does the roll paper width specified in the print job match the width of roll paper loaded in the printer? (Only for borderless printing or enlarged/reduced printing)	Only either roll paper 1 or roll paper 2 is roll paper of the width specified in the print job	The roll paper with the matched roll paper width is selected
		Neither roll paper 1 nor roll paper 2 is roll paper of the width specified in the print job	Go to Condition 6
		Both roll paper 1 and roll paper 2 are roll paper of the width specified in the print job	
		The roll paper width is not specified in the print job	
Condition 6	Does the width of roll paper loaded in the printer accommodate the width of the paper size specified in the print job?	Only either roll paper 1 or roll paper 2 accommodates the paper size width specified in the print job	The roll paper that accommodates the paper size width is selected

	Condition	Status	Judgment result
Condition 6	Does the width of roll paper loaded in the printer accommodate the width of the paper size specified in the print job?	Neither roll paper 1 nor roll paper 2 accommodates the paper size width specified in the print job	Go to Condition 7
		Both roll paper 1 and roll paper 2 accommodate the paper size width specified in the print job	
Condition 7	Are the widths of roll paper 1 and roll paper 2 different?	The roll paper widths are different	The roll paper with the smaller difference between the paper size width and the width specified in the print job is selected
		The roll paper width is the same	The roll paper currently fed to the platen is selected (*1)

*1: In the following case, neither roll paper 1 nor roll paper 2 is fed to the platen. In this case, roll paper 1 is selected.



- When the printer enters sleep mode and then resumes
- When the printer is turned on
- When cut sheet is supplied and ejected

Printing Photos and Office Documents

- Printing Photos and Images 43
 - Printing Photos and Images (Windows) 43
 - Printing Photos and Images (Mac OS) 45
- Printing Office Documents 47
 - Printing Office Documents (Windows) 47
 - Printing Office Documents (Mac OS) 48
- Using PosterArtist to Compose Originals 50

Printing Photos and Images

By selecting the following **Print Target** from **Easy Settings** of the printer driver, you can easily configure the printing of illustrations and photos.

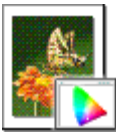
	Print Target	Description
	Photo (Color)	Print photographic images from digital cameras with an optimal setting.
	Poster	An optimal setting for posters. Print in vivid colors with impact and high saturation.
	Faithful Color Reproduction	Print with minimum color difference. Suitable for printing scanner images and when print results are too vivid.

 **Important** • Depending on the **Media Type** setting, some **Print Target** options may not be available.

 **Note** • You can check the settings values for each print target by clicking **View Settings**.
 • You can also fine-tune these values as needed. (**Advanced Settings**)
 For details on **Advanced Settings**, see "Giving Priority to Particular Graphic Elements and Colors for Printing." →P.66

For instructions on printing photos and images, refer to the following topics, as appropriate for your operating system.

- **Printing Photos and Images (Windows)** →P.43
- **Printing Photos and Images (Mac OS)** →P.45

Printing Photos and Images (Windows)

This topic describes how to print photos based on the following example.

- Document: Photo image from a digital camera
- Page size: 10×12 inches (254.0×304.8 mm)
- Paper: Roll
- Paper type: **Canon Glossy Photo Paper 170gsm**
- Roll paper width: 10 inches (254.0 mm)

1 Choose **Print** in the application menu.

2 Select the printer in the dialog box, and then display the printer driver dialog box. (See "Accessing the Printer Driver Dialog Box from Applications .") →P.164

3 Make sure the **Main** sheet is displayed.

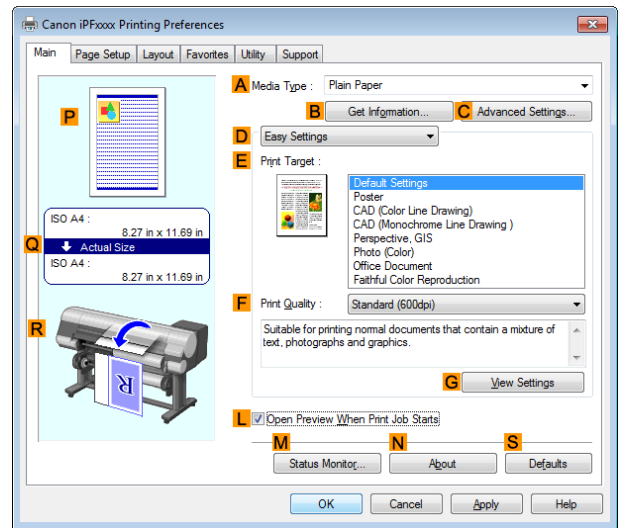

4 In the **A Media Type** list, select the type of paper that is loaded. In this case, click **Canon Glossy Photo Paper 170gsm**.

In the **A Media Type**, choose the type of paper used for printing, such as **Glossy Paper**, **Canon Coated Paper**, and so on. Make sure the paper you select is loaded in the printer.



- The paper type setting in the printer driver and related software (as well as on the Control Panel) is updated when you install the Media Configuration Tool from the User Software CD-ROM or if you change paper information by using the Media Configuration Tool. For details, see "Media Configuration Tool (Windows)." →P.383

5 After confirming that **D Easy Settings** is selected, click **Photo (Color)** in the **E Print Target** list.



- You can check the settings values selected in the **E Print Target** list by clicking **G View Settings**.

6 Click the **Page Setup** tab to display the **Page Setup** sheet.

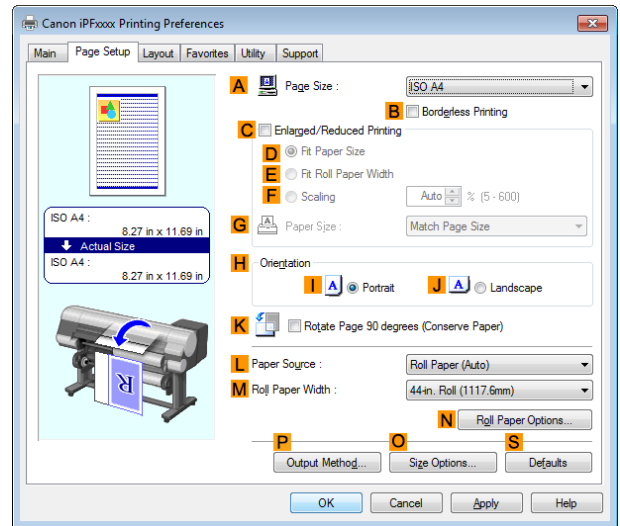

7 In the **A Page Size** list, click the size of the original as specified in the application. In this case, click **10"x12"**.

8 Select and click a roll paper in the **L Paper Source** list.

9 Select the width of the loaded roll in the **M Roll Paper Width** list—in this case, **10-in. Roll (254.0mm)**.

- 10** Specify additional printing conditions.
For details on available printing conditions, see "Printer Driver Settings ." →P.158

- 11** Confirm the print settings and print as desired.



Note

- For instructions on confirming print settings, see "Confirming Print Settings ." →P.161

Printing Photos and Images (Mac OS)

This topic describes how to print photos based on the following example.

- Document: Photo image from a digital camera
- Page size: 10×12 inches (254.0×304.8 mm)
- Paper: Roll paper
- Paper type: **Canon Glossy Photo Paper 170gsm**
- Roll paper width: 10 inches (254.0 mm)

- 1** Choose **Page Setup** from the application menu to display the **Page Attributes** dialog box.

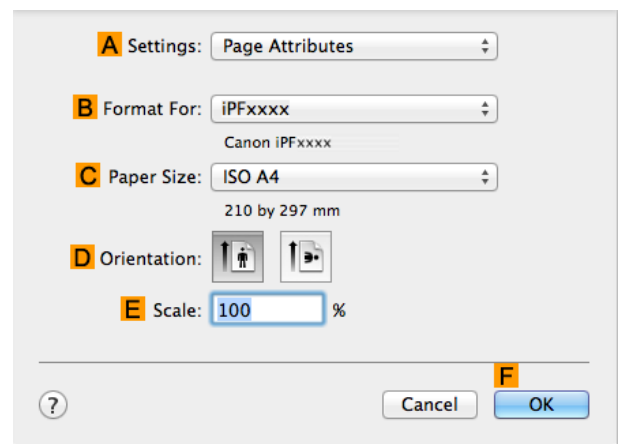

Note

- **Page Setup** might not be displayed in the menu depending on the OS you are using and the application software. In this case, select **Print** from the menu in the application software, and configure the settings in the upper part of the printer driver screen that is displayed.

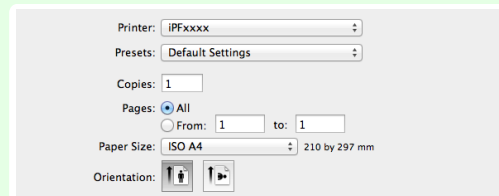

- 2** Select the printer in the **B Format for** list.

- 3** In the **C Paper Size** list, click the size of the original. In this case, click **10"x12"**.

- 4** Click **F OK** to close the dialog box.

- 5** Choose **Print** in the application menu.

6 Access the **Main** pane.

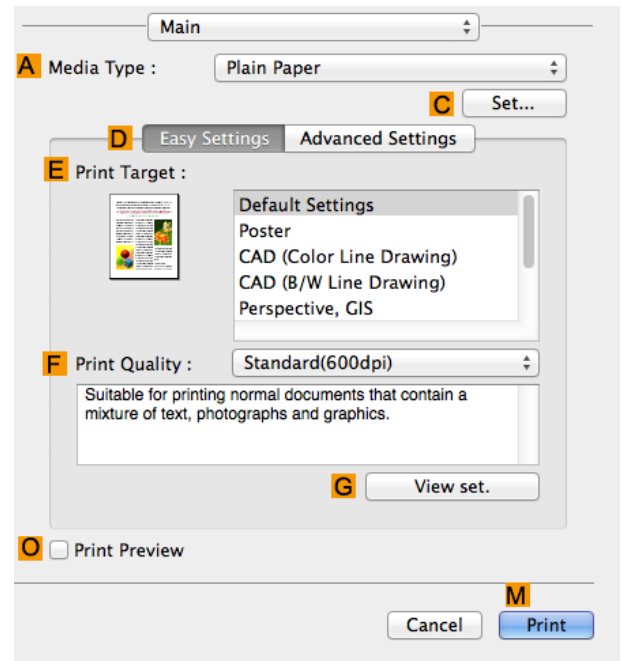

7 In the **A Media Type** list, select the type of paper that is loaded. In this case, click **Canon Glossy Photo Paper 170gsm**.
Make sure the paper you select is loaded in the printer.



- The types of paper indicated in the printer driver and related software (as well as on the Control Panel) are updated when you install the Media Configuration Tool from the User Software CD-ROM or if you change paper information by using the Media Configuration Tool. For details, see "Media Configuration Tool (Mac OS)." →P.405

8 After confirming that **D Easy Settings** is selected, click **Photo (Color)** in the **E Print Target** list.



- For information on settings optimized for printing photos and images, see "Printing Photos and Images." →P.43
- You can check the settings values selected in the **E Print Target** list by clicking **G View set.**

9 Make your selection in the **F Print Quality** list.

10 Access the **Page Setup** pane.

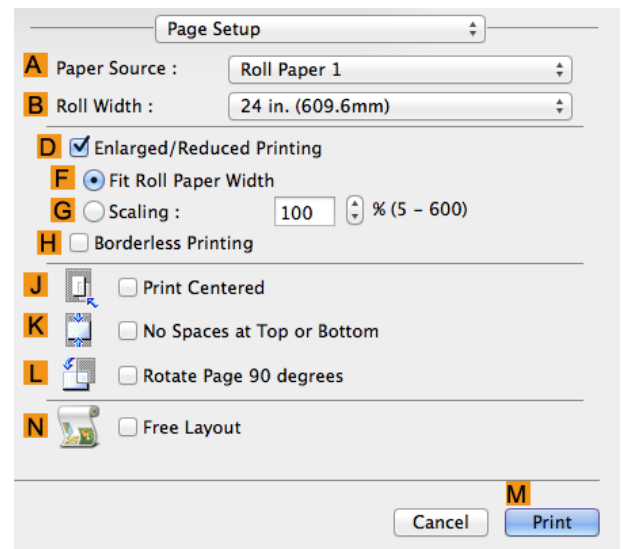

11 Select and click a roll paper in the **A Paper Source** list.

12 Select the paper width of the roll loaded in the printer for **B Roll Width**. In this case, **10 in. (254.0mm)** is selected.

13 Specify additional printing conditions.
For details on available printing conditions, see "Printer Driver Settings ." →P.268

14 Confirm the print settings, and then click **M Print** to start printing.



• For tips on confirming print settings, see "Confirming Print Settings ." →P.270

Printing Office Documents

By selecting **Office Document** from **Easy Settings** of the printer driver, you can easily configure settings for printing office documents.

	Print Target	Description
	Office Document	Setting optimized for printing general office documents such as materials for distribution so that they can be viewed easily.



Note

- You can check the settings values for each print target by clicking **View Settings**.
- You can also fine-tune these values as needed. (Advanced Settings)
For details on Advanced Settings, see "Giving Priority to Particular Graphic Elements and Colors for Printing." →P.66

Printing Office Documents (Windows)

This topic describes how to print office documents based on the following example.

- Document: Office document created using word-processing or spreadsheet programs
- Page size: A4 (210.0 × 297.0 mm [8.3 × 11.7 in])
- Paper: Sheets
- Paper type: Plain Paper
- Paper size: A4 (210.0 × 297.0 mm [8.3 × 11.7 in])

1 Choose **Print** in the application menu.

2 Select the printer in the dialog box, and then display the printer driver dialog box. (See "Accessing the Printer Driver Dialog Box from Applications ." →P.164)

3 Make sure the **Main** sheet is displayed.

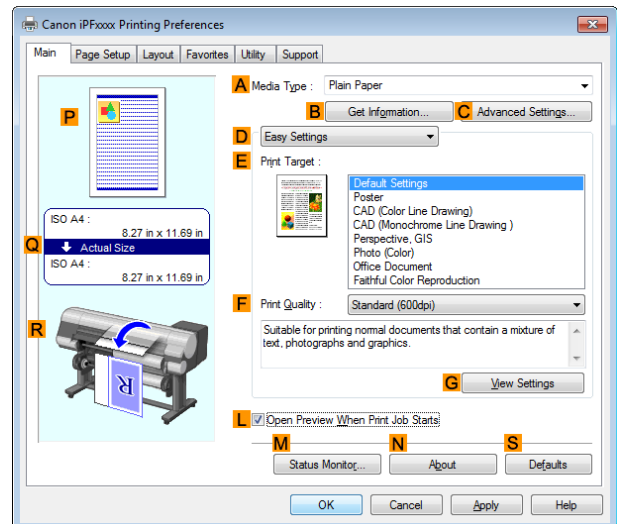

4 In the **A Media Type** list, select the type of paper that is loaded. In this case, click Plain Paper.

5 After confirming that **D Easy Settings** is selected, click **Office Document** in the **E Print Target** list.



Note

- You can check the settings values selected in the **E Print Target** list by clicking **G View Settings**.

6 Click the **Page Setup** tab to display the **Page Setup** sheet.

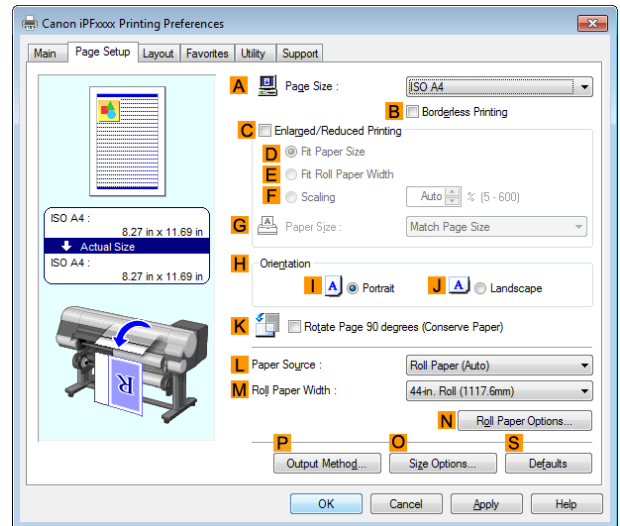

7 In the **A Page Size** list, click the size of the original as specified in the application. In this case, click **ISO A4**.

8 Click **Cut Sheet** in the **L Paper Source** list.

9 Specify additional printing conditions.

For details on available printing conditions, see "Printer Driver Settings ." →P.158

10 Confirm the print settings and print as desired.



Note

- For tips on confirming print settings, see "Confirming Print Settings ." →P.161

Printing Office Documents (Mac OS)

This topic describes how to print office documents based on the following example.

- Document: Office document created using word-processing or spreadsheet programs
- Page size: A4 (210.0 × 297.0 mm [8.3 × 11.7 in])
- Paper: Sheets
- Paper type: Plain Paper
- Paper size: A4 (210.0 × 297.0 mm [8.3 × 11.7 in])

- 1 Choose **Page Setup** from the application menu to display the **Page Attributes** dialog box.

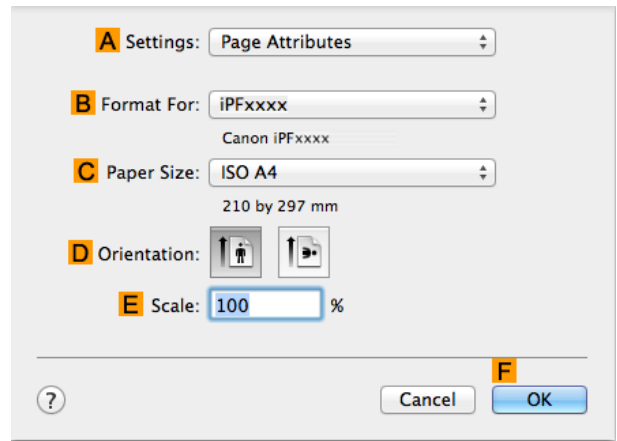

Note

- **Page Setup** might not be displayed in the menu depending on the OS you are using and the application software. In this case, select **Print** from the menu in the application software, and configure the settings in the upper part of the printer driver screen that is displayed.

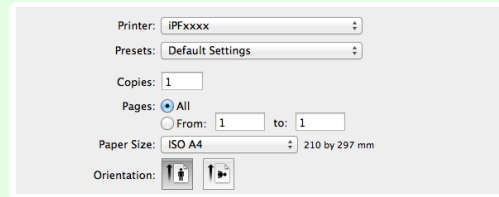

- 2 Select the printer in the **B Format for** list.
- 3 In the **C Paper Size** list, click the size of the original. In this case, click **ISO A4 - Cut Sheet**.
- 4 Click **F OK** to close the dialog box.
- 5 Choose **Print** in the application menu.
- 6 Access the **Main** pane.

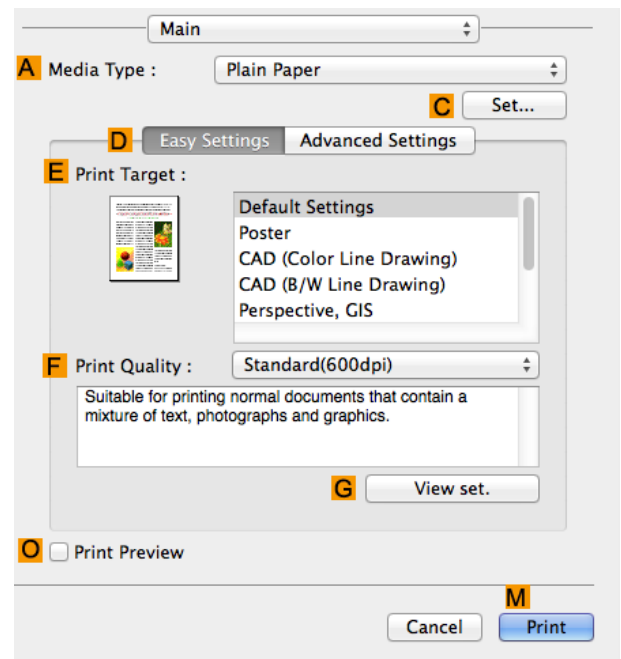

- 7 In the **A Media Type** list, select the type of paper that is loaded. In this case, click Plain Paper.
- 8 After confirming that **D Easy Settings** is selected, click **Office Document** in the **E Print Target** list.



Note

- You can check the settings values selected in the **E Print Target** list by clicking **G View set.**

9 Make your selection in the **F Print Quality** list.

10 Access the **Page Setup** pane.

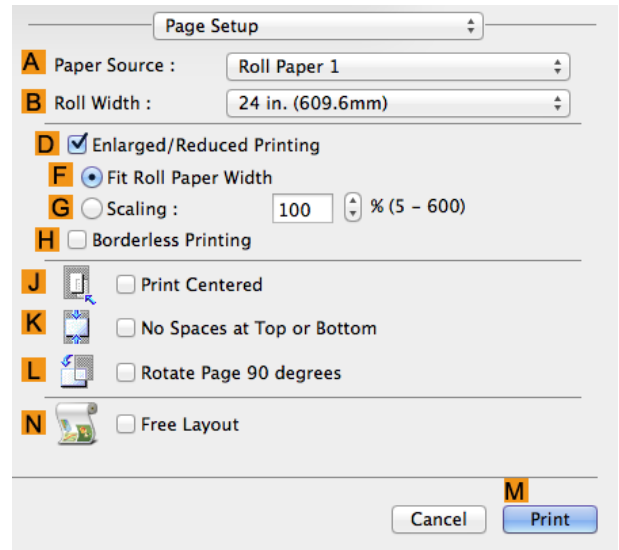

11 Click **Cut Sheet** in the **A Paper Source** list.

12 Specify additional printing conditions.
For details on available printing conditions, see "Printer Driver Settings ." →P.268

13 Confirm the print settings, and then click **M Print** to start printing.

 • For tips on confirming print settings, see "Confirming Print Settings ." →P.270

Note

Using PosterArtist to Compose Originals

You can print a variety of source documents from word-processing or spreadsheet programs or screen shots from web browsers after composing an original with them using PosterArtist. This topic describes how to use PosterArtist to compose originals from multiple applications, creating a poster layout for printing.

1 Choose **Print** in the application menu.

2 Select the printer in the dialog box, and then open the printer driver dialog box. (See "Accessing the Printer Driver Dialog Box from Applications (Windows).") →P.164

3 Make sure the **Main** sheet is displayed.

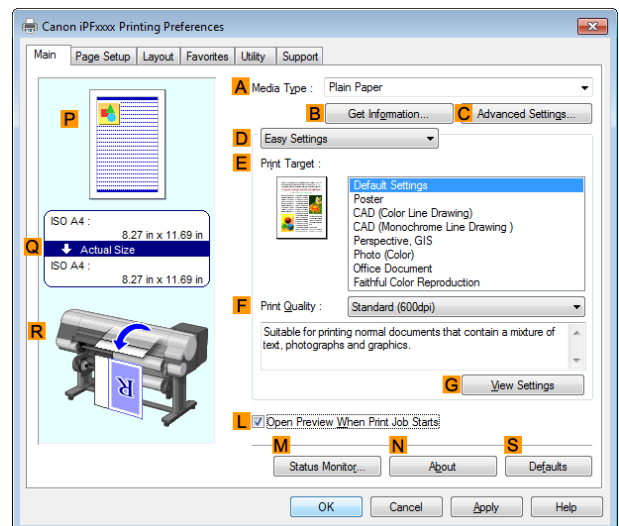

- 4** Click the **Layout** tab to display the **Layout** sheet.

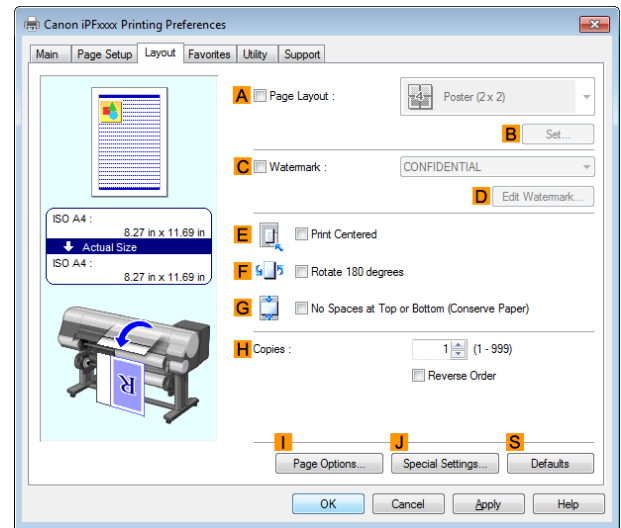

- 5** Select the **A Page Layout** check box.

- 6** Click in the **Edit Using PosterArtist** in the **A Page Layout** list.



- This function cannot be used with a 64-bit version OS.

Note

- 7** When you attempt to print, PosterArtist starts up and the PageCapture window is displayed. (At this point, the document will not be printed yet.)

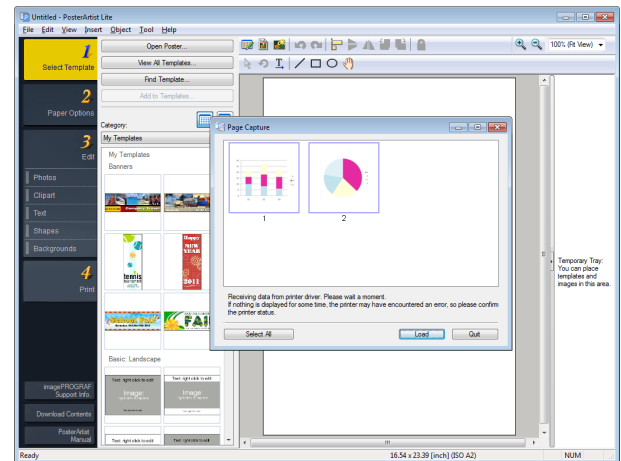

- 8** Choose the page to load in PosterArtist.

- 9** Edit and rearrange the image in the PosterArtist window as desired. Without closing the PosterArtist window, repeat steps 1-8 to arrange originals from multiple applications on the same page.



- For details on how to edit and sort images, refer to the PosterArtist Manual.

Note

- 10** Print from the PosterArtist menu.

Printing CAD Drawings

- Printing CAD Drawings 52
- Printing Line Drawings and Text 52
 - Printing Line Drawings and Text (Windows) 53
 - Printing Line Drawings and Text (Mac OS) 54
- Printing from AutoCAD 56
- Specifying Colors and Printing CAD Drawings 57
 - Specifying Colors and Printing CAD Drawings (Windows) 58
- HP-GL/2 Printing 59

Printing CAD Drawings

Using this printer, you can print fine lines and text clearly and sharply. It's easy to produce highly precise drawings from CAD applications.

For instructions on CAD printing, refer to the following topics, as appropriate for your operating system.



- **Printing Line Drawings and Text (Windows)** →P.53
- **Printing Line Drawings and Text (Mac OS)** →P.54

Printing Line Drawings and Text

Printing is easy when you simply choose the type of original to print.

- **Easy Settings**
Simply choose the printing application in the list for optimal printing results.
- **Print Target**
Choose presets that match the type of document to be printed.

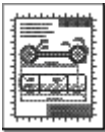
Print targets for line drawings and text

	Print Target	Description
	CAD (Color Line Drawing)	Settings optimized to print intricate lines in CAD drawings clearly.
	CAD (Monochrome Line Drawing)	Settings optimized to print black lines in CAD drawings clearly.
	Perspective, GIS	Settings optimized for printing 3D CAD drawings, perspective drawings, and maps, including GIS maps.



Note

- You can check the settings values for each print target by clicking **View Settings**.
- You can also fine-tune these values as needed. (**Advanced Settings**)
For details on **Advanced Settings**, see "Giving Priority to Particular Graphic Elements and Colors for Printing." →P.66

- **Print Quality**
Choose the print quality.

The printing mode is determined by a combination of the print quality and resolution.

Print Quality	Description
Highest	A setting for printing at the highest resolution when quality is most important. Printing takes longer and consumes more ink than in other modes, but this mode offers superior printing quality.
High	Choose this setting to print at high resolution when quality is most important. Printing takes longer and consumes more ink than in Standard or Fast modes, but this mode offers exceptional printing quality.
Standard	Choose this setting to print at standard resolution when quality and speed are both important. Printing takes less time than in Highest or High mode.
Fast	Choose this setting to print faster. Printing in draft mode can help you work more efficiently when checking layouts.

For instructions on printing line drawings and text, refer to the following topics, as appropriate for your operating system.

- **Printing Line Drawings and Text (Windows)** → P.53
- **Printing Line Drawings and Text (Mac OS)** → P.54

Printing Line Drawings and Text (Windows)

This topic describes how to print line drawings based on the following example.

- Document: CAD drawing
- Page size: A3 (297.0 × 420.0 mm [11.7 × 16.5 in])
- Paper: Roll paper
- Paper type: Plain Paper
- Roll paper width: A2/A3 roll (420.0 mm [16.5 in])

- 1 Choose **Print** in the application menu.
- 2 Select the printer in the dialog box, and then display the printer driver dialog box. (See "**Accessing the Printer Driver Dialog Box from Applications .**") → P.164
- 3 Make sure the **Main** sheet is displayed.

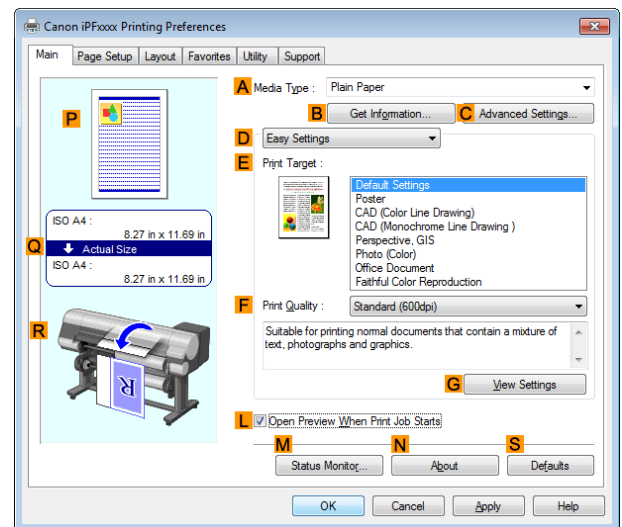

- 4 In the **A Media Type** list, select the type of paper that is loaded. In this case, click Plain Paper.
- 5 After confirming that **D Easy Settings** is selected, click **CAD (Color Line Drawing)** or **CAD (Monochrome Line Drawing)** in the **E Print Target** list.



Note

- You can check the settings values selected in the **E Print Target** list by clicking **G View Settings**.

6 Click the **Page Setup** tab to display the **Page Setup** sheet.

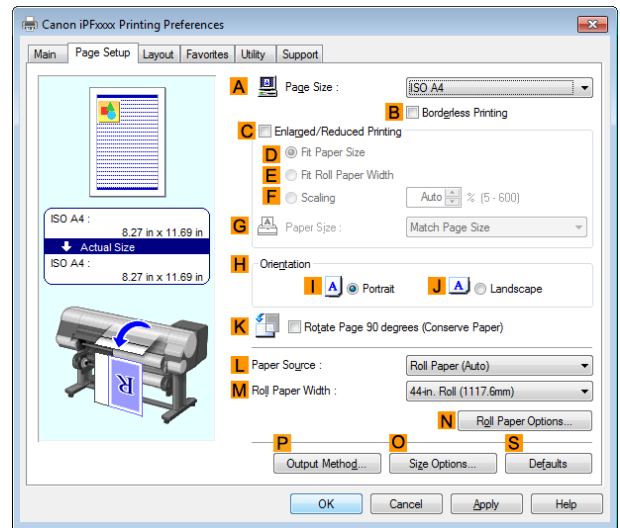

7 In **A Page Size**, click the size of the original as specified in the application. In this case, click **ISO A3**.

8 Select and click a roll paper in the **L Paper Source** list.

9 Select the width of the loaded roll in the **M Roll Paper Width** list—in this case, **ISO A2/A3 Roll (420.0mm)**.

10 Specify additional printing conditions.
For details on available printing conditions, see "Printer Driver Settings ." →P.158

11 Confirm the print settings and print as desired.

 **Note** • For tips on confirming print settings, see "Confirming Print Settings ." →P.161

Printing Line Drawings and Text (Mac OS)

This topic describes how to print line drawings based on the following example.

- Document: CAD drawing
- Page size: A3 (297.0 × 420.0 mm [11.7 × 16.5 in])
- Paper: Roll
- Paper type: Plain Paper
- Roll paper width: A2/A3 roll (420.0 mm [16.5 in])

1 Choose **Page Setup** from the application menu to display the **Page Attributes** dialog box.

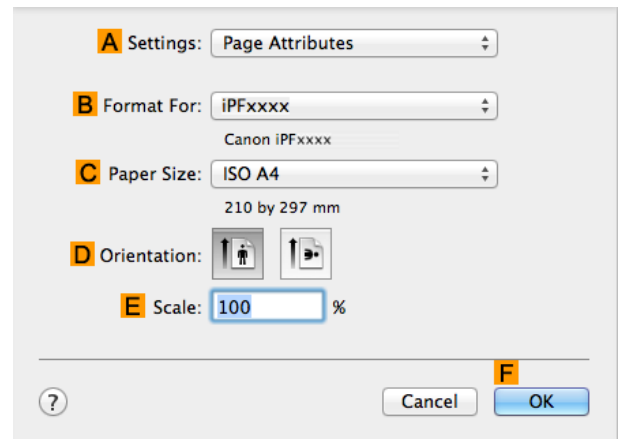



Note

- **Page Setup** might not be displayed in the menu depending on the OS you are using and the application software. In this case, select **Print** from the menu in the application software, and configure the settings in the upper part of the printer driver screen that is displayed.

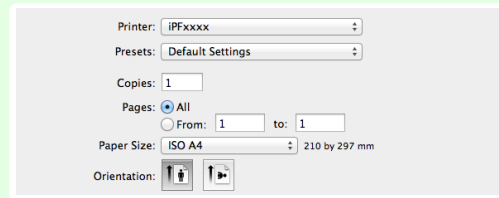

- 2 Select the printer in the **B Format for** list.
- 3 In the **C Paper Size** list, click the size of the original. In this case, click **ISO A3**.
- 4 Click **F OK** to close the dialog box.
- 5 Choose **Print** in the application menu.
- 6 Access the **Main** pane.

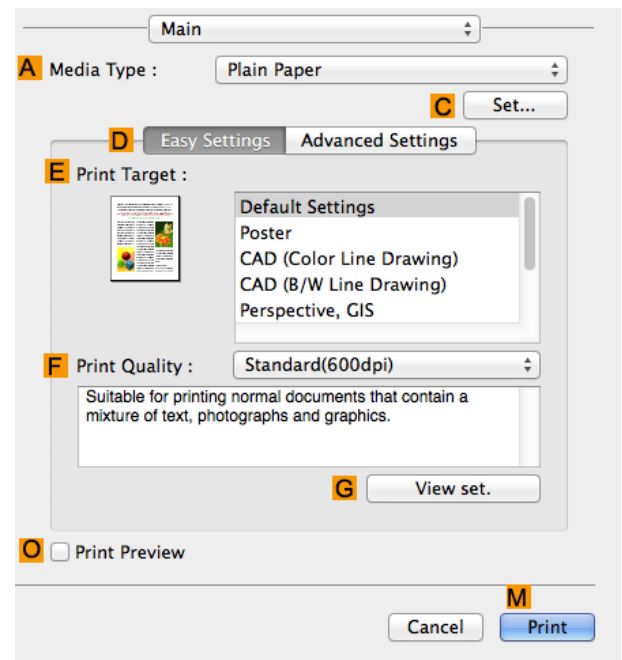

- 7 In the **A Media Type** list, select the type of paper that is loaded. In this case, click Plain Paper.
- 8 After confirming that **D Easy Settings** is selected, click **CAD (Color Line Drawing)** or **CAD (Monochrome Line Drawing)** in the **E Print Target** list.



Note

- You can check the settings values selected in the **E Print Target** list by clicking **G View set.**

- 9 Make your selection in the **F Print Quality** list.

10 Access the **Page Setup** pane.

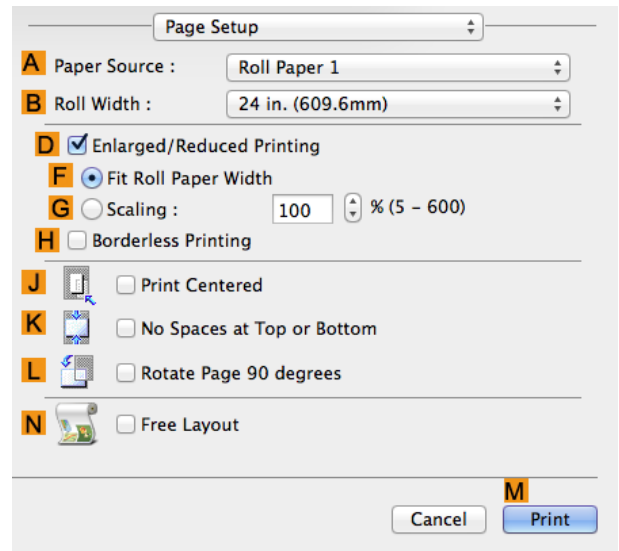

11 Select and click a roll paper in the **A Paper Source** list.

12 Select the paper width of the roll loaded in the printer for **B Roll Width**. In this case, **ISO A2/A3 (420.0mm)** is selected.

13 Specify additional printing conditions.
For details on available printing conditions, see "Printer Driver Settings ." →P.268

14 Confirm the print settings, and then click **M Print** to start printing.

 • For tips on confirming print settings, see "Confirming Print Settings ." →P.270

Note • You can conserve roll paper by configuring settings suitable for the document.
For details on how to conserve paper and print, see "Conserving Roll Paper by Rotating Originals 90 Degrees ." →P.138

Printing from AutoCAD

Printer Driver Optimization Module for AutoCAD is software for printing optimally from AutoCAD with the printer driver.
By optimally controlling the processing resolution of raster data and the memory to be used in image processing of AutoCAD, printing superior in reliability and productivity is realized.
If you install Printer Driver Optimization Module for AutoCAD on a computer on which supported AutoCAD is installed, it will be installed automatically.

 **Note** • Printer Driver Optimization Module for AutoCAD is applied automatically when you print from AutoCAD, and optimal printing is performed.

• Printer Driver Optimization Module for AutoCAD can be used on Windows.

Confirming the Installation of Printer Driver Optimization Module for AutoCAD

You can confirm whether Printer Driver Optimization Module for AutoCAD is installed by the following method.

1 From the **File** menu of AutoCAD, select **Print**.

- 2** The **Printing** dialog box is displayed. Printer Driver Optimization Module for AutoCAD is installed if in **Plotter** of **Printer/plotter** this is displayed: **iPFxxxx - Optimized driver - by Canon Inc..**

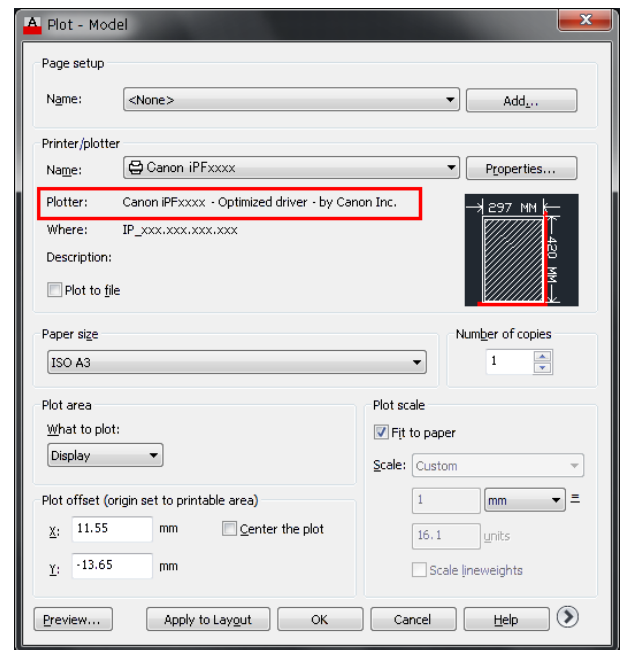

Installation of Printer Driver Optimization Module for AutoCAD

If Printer Driver Optimization Module for AutoCAD is not installed, install it by the following method.

- 1** Insert User Software CD-ROM in the CD-ROM drive and start the installer.
- 2** In the **Setup Menu** window, click **Install Individual Software**.
- 3** Click **Install** of Printer Driver Optimization Module for AutoCAD.
- 4** Follow the instructions on the screen.

Specifying Colors and Printing CAD Drawings

You can complete color settings when **Color (CAD)** is selected in **Color Mode**.

Colors can be adjusted before printing as follows when **Color Compatibility** is selected.



- **Color (CAD)** is displayed when you select **Advanced Settings** on the **Main** sheet and set **Print Priority** to **Line Drawing/Text**.

Color Compatibility

Color Setting Item

Color Setting	Description
Color (CAD) 1	Print in standard colors.
Color (CAD) 2	Print with approximate colors emulating Canon iPF750, iPF755, iPF650, iPF655, iPF760, iPF765.
Color (CAD) 3	Print with approximate colors emulating Canon iPF500, iPF600, iPF700, iPF510, iPF610, iPF710, iPF605, iPF720, iPF810, iPF820, iPF815, iPF825.
Color (CAD) 4	Print emulating the HP Designjet 4000/4500, in colors resembling colors produced by these printers.
Color (CAD) 5	Print emulating the HP Designjet T1100, in colors resembling colors produced by this printer.
Color (CAD) 6	Print emulating the Oce ColorWave 300, in colors resembling colors produced by this printer.



If you have selected **Color (CAD) 2**, **Color (CAD) 3**, **Color (CAD) 4**, **Color (CAD) 5**, or **Color (CAD) 6**, it is not possible to match the colors and image quality produced by the specified printer exactly.

For instructions on configuring **Color Compatibility**, refer to the following topics.

- **Specifying Colors and Printing CAD Drawings (Windows)** → P.58

Specifying Colors and Printing CAD Drawings (Windows)

You can complete color settings when **Color (CAD)** is selected in **Color Mode**.



- **Color (CAD)** is displayed when you select **Advanced Settings** on the **Main** sheet and set **Print Priority** to **Line Drawing/Text**.
- This section describes the procedure in Windows 7.

1 Click **start >Devices and Printers**.

2 Right-click the icon of this printer and choose **Printer Properties** to open the printer properties window.

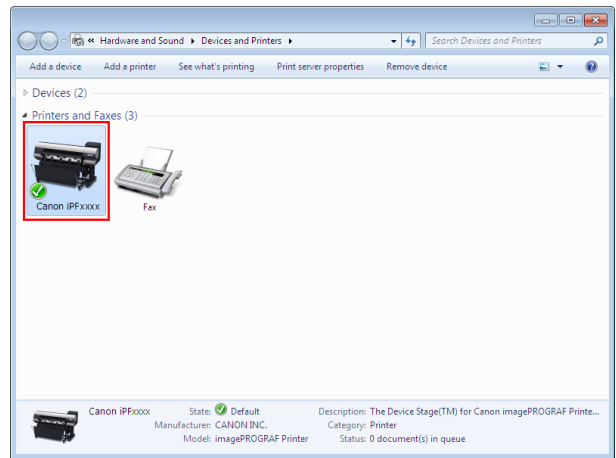

3 Click the **Device Settings** tab to display the **Device Settings** sheet.

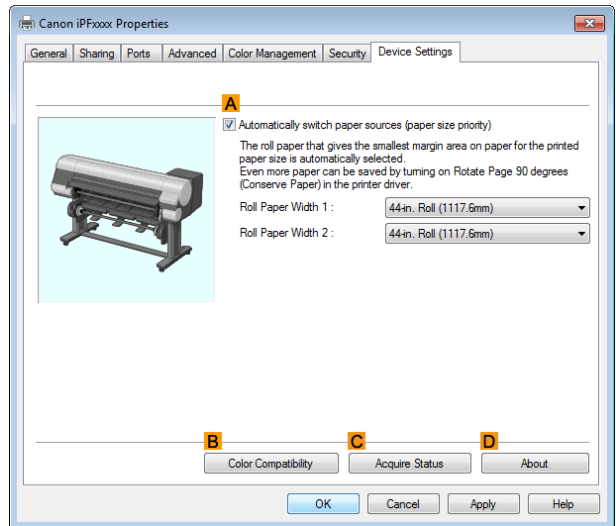

4 Click **B Color Compatibility** to display the **Color Compatibility** dialog box.

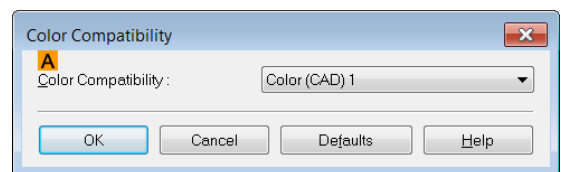

5 Select the desired color settings in the **A Color Compatibility** list.



Note

- For details on color settings, see "Specifying Colors and Printing CAD Drawings." →P.57

For printing instructions, refer to the following topic.

- **Choosing the Document Type and Printing Conditions** →P.68

HP-GL/2 Printing

This printer supports printing using the original Canon GARO printer control language and printing using HP-GL/2 and HP RTL emulation to print in colors resembling the colors produced by printers from other companies. The printer automatically switches to the corresponding processing depending on whether a GARO or HP-GL/2 and HP RTL emulation job is received.



Note

- GARO is an abbreviation of Graphic Arts Language with Raster Operations.
- HP-GL/2 is an abbreviation of Hewlett-Packard Graphics Language/2, and HP RTL is an abbreviation of Hewlett-Packard Raster Transfer Language.
- Emulation is good for obtaining results similar to printing on other printers.

When printing from applications that support HP-GL/2 output, specify HP-GL/2 in the application's plotter output settings.

HP-GL/2 and HP RTL emulation related settings such as the printer to emulate are configured from the printer Control Panel. (Refer to "Menu Structure →P.443 " and "Menu Settings →P.449 ")



Note

- For instructions on configuring these settings, refer to the software documentation. It may not be possible to print jobs with excessively large amounts of data correctly.
- For information on CAD colors other than HP-GL/2 and HP RTL emulation, see "Menu Settings." →P.449

Adjusting Images

- Adjusting the Color in the Printer Driver 60
 - Fine-Tuning Colors of Photos and Images (Windows) 61
 - Fine-Tuning Colors of Photos and Images (Mac OS) 64
- Giving Priority to Particular Graphic Elements and Colors for Printing 66
 - Choosing the Document Type and Printing Conditions (Windows) 68
 - Choosing the Document Type and Printing Conditions (Mac OS) 70

Adjusting the Color in the Printer Driver

Color settings specified in the application for your documents are essentially given priority over other settings for each print job, but further color adjustment is possible in the printer driver.

• Color Mode

Choose how the printer driver processes color, as desired.
The available options vary depending on the color mode.

Color Mode	Description	Color Adjustment
Color	Print in color.	You can select the color balance and color matching functions.
Monochrome	Print in grayscale.	You can adjust the color balance.
Color (CAD)	A color mode optimized for line drawings (2D-CAD). Lines in red, yellow, and other colors are printed especially clearly.	You can adjust the color balance.
Monochrome (BK ink)	A color mode for printing line drawings. Only Black ink is used.	You can adjust the color balance.
Monochrome Bitmap	Print in a color mode for CAD, using Color Ink, with all non-white portions printed in black.	No color adjustment is supported.
No color correction (*1)	Prints without performing color-matching in the printer driver.	You can adjust the color balance.

*1: If **No color correction** is selected, the **Matching** sheet / **Matching** pane is not displayed.

• Color Adjustment

You can adjust colors separately for images, graphics, and text documents.

Adjustment Item	Description
Cyan	Fine-tune color tones by adjusting the levels of Cyan , Magenta , and Yellow .
Magenta	
Yellow	
Gray Tone	Adjust the grayscale, in a range from cool, blue tones to warm, red tones.
Brightness	Adjust the brightness of printed images while keeping the darkest and lightest portions intact.
Contrast	Adjust the contrast of the darkest and lightest portions relative to each other. For soft gradation, decrease the contrast. For hard gradation, increase the contrast.
Saturation	Adjust the level of color saturation, in a range from subdued to vivid.



Note

• Click **Object Adjustment** to open the **Object Adjustment** dialog box, which allows you to select the color adjustment target from **Image**, **Graphics**, and **Text**.

• Matching

You can choose the color-matching mode and method.

By adjusting the color-matching mode and method, you can make printed colors match the colors of on-screen images more closely.



Important

- If **No color correction** is selected under **Color Mode**, the **Matching** cannot be changed.

Matching Mode	Description	Remarks
Driver Matching Mode	Enables printing of optimal color tones using a driver specific color profile.	You should normally select this mode.
ICC Matching Mode	Enables color matching using ICC profiles. Select this if you want to print by specifying the input profile, printer profile, and matching method in detail.	This allows you to use ICC profiles for digital cameras and scanners, ICC profiles created using the profile creation tool, etc.
Host ICM Mode	Enables color matching by the host computer using the ICM function of Windows. Select this if you want to print from an application that supports the ICM function.	Available when using Windows.
ColorSync	Enables color matching by using the ColorSync function of Mac OS. Select this if you want to perform soft proofing using ColorSync before printing.	Available when using Mac OS. To select ColorSync , choose ColorSync on the Color Matching panel.

Matching Method	Description	Remarks
Auto	Color-matching optimized for images, graphics, or text.	The available options and their display order vary depending on your selected color-matching mode, as well as the operating system.
Perceptual	Color-matching optimized for printing typical photos attractively. Smooth gradation is a feature. This is also an easy-to-use mode when performing color adjustment using application software.	
Colorimetric	Color-matching optimized for printing image data with accurate colors in input color space. This is the easiest-to-use mode when you want to adjust the color and print. However, gradation may be lost for colors of wider range than the color reproduction range of the printer. Generally, this is also called relative colorimetric.	
Colorimetric (No Wht-pnt Corr)	The processing method of color-matching is identical to Colorimetric. Use this when you want to further reproduce the target paper material color of the image data. Generally, this also is called absolute colorimetric	
Saturation	Color-matching optimized for printing posters, etc., vividly.	

For instructions on color adjustment, refer to the following topics, as appropriate for your operating system.

- [Fine-Tuning Colors of Photos and Images \(Windows\)](#) →P.61
- [Fine-Tuning Colors of Photos and Images \(Mac OS\)](#) →P.64

Fine-Tuning Colors of Photos and Images (Windows)

You can specify your own print settings instead of using the **Print Target** presets. This topic describes how to fine-tune the color tone of photos before printing.

- 1 Choose **Print** in the application menu.

2 Select the printer in the dialog box, and then display the printer driver dialog box. (See "Accessing the Printer Driver Dialog Box from Applications .") →P.164

3 Make sure the **Main** sheet is displayed.

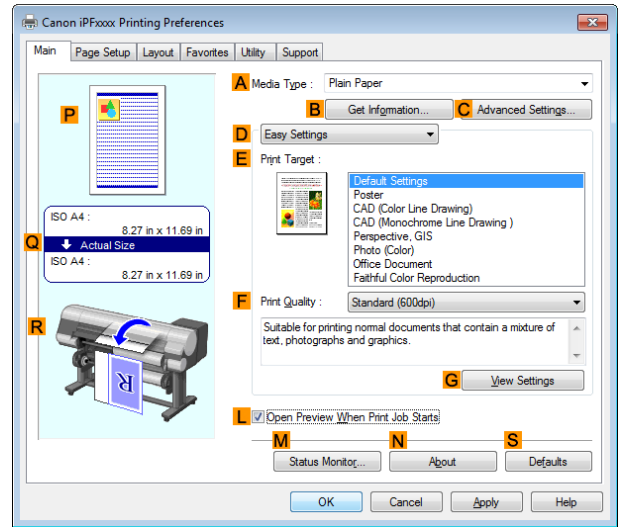

4 In the **A Media Type** list, select the type of paper that is loaded.

5 Click **D Advanced Settings** to switch the print mode.

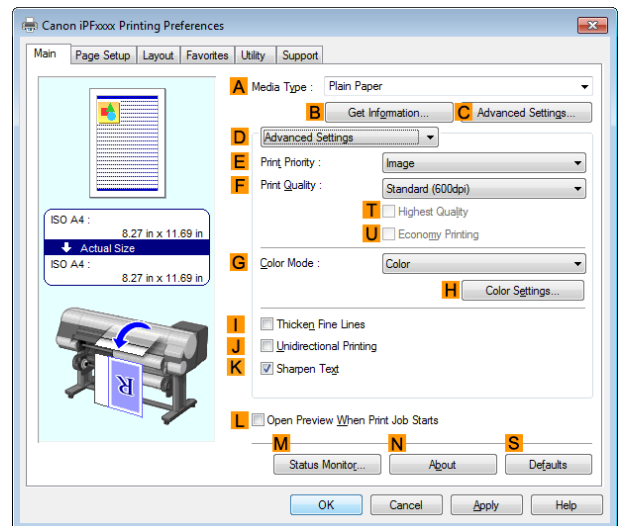

6 Click **Color** in the **G Color Mode** list.

7 Click **H Color Settings** to display the **Color Settings** dialog box.

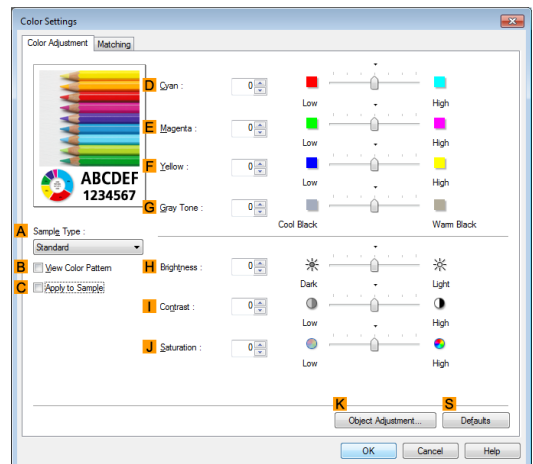

8 On the **Color Adjustment** sheet, adjust the color tones, brightness, and so on as desired.

Adjustment Item	Description
D Cyan	Fine-tune color tones by adjusting the levels of Cyan, Magenta, and Yellow.
E Magenta	
F Yellow	
G Gray Tone	Adjust the gray tone. Choose cool black (tinged with blue), pure black (neutral), warm black (tinged with red), and so on.
H Brightness	Adjust the brightness of printed images while keeping the darkest and lightest portions intact.
I Contrast	Adjust the contrast of the darkest and lightest portions relative to each other. For soft gradation, decrease the contrast. For hard gradation, increase the contrast.
J Saturation	Adjust the level of color saturation, in a range from subdued to vivid.

 **Note** • Click **Object Adjustment** to open the **Object Adjustment** dialog box, which allows you to select the color adjustment target from **Image**, **Graphics**, and **Text**.

9 Close the **Color Settings** dialog box.

10 Click the **Page Setup** tab to display the **Page Setup** sheet.

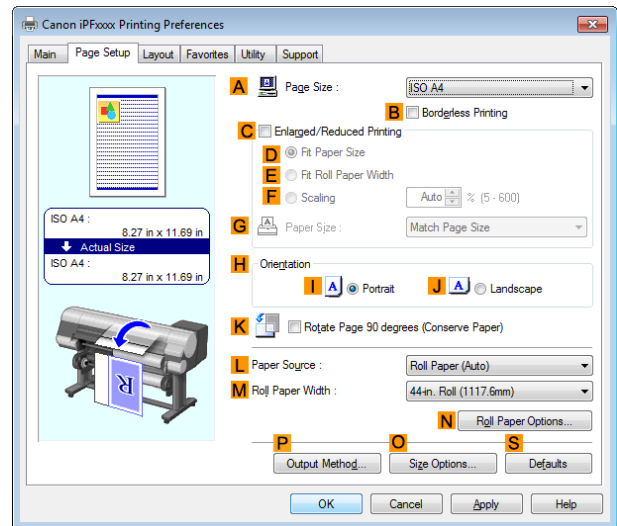

11 Confirm the settings of **A Page Size**, **L Paper Source**, and so on.

12 Confirm the print settings and print as desired.

 **Note** • For tips on confirming print settings, see "Confirming Print Settings ." →P.161

Fine-Tuning Colors of Photos and Images (Mac OS)

You can specify your own print settings instead of using the **Print Target** presets. This topic describes how to fine-tune the color tone of photos before printing.

- 1 Choose **Page Setup** from the application menu to display the **Page Attributes** dialog box.

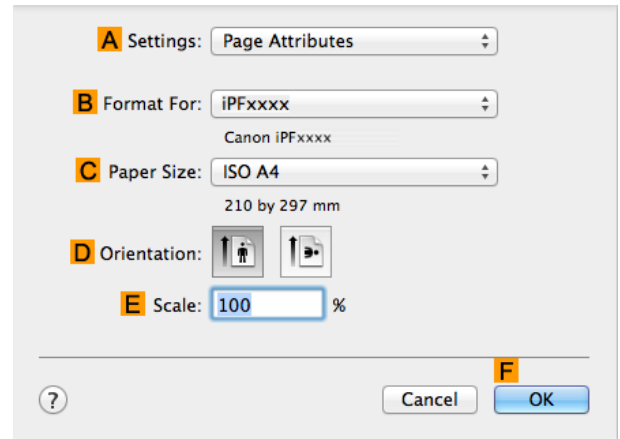

- **Page Setup** might not be displayed in the menu depending on the OS you are using and the application software. In this case, select **Print** from the menu in the application software, and configure the settings in the upper part of the printer driver screen that is displayed.

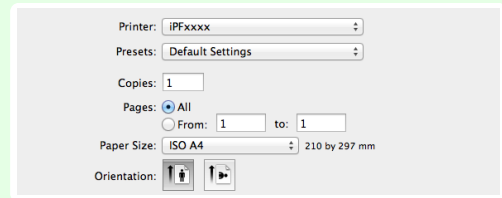

- 2 Select the printer in the **B Format for** list.
- 3 Choose the original size in the **C Paper Size** list.
- 4 Click **F OK** to close the dialog box.
- 5 Choose **Print** in the application menu.
- 6 Access the **Main** pane.

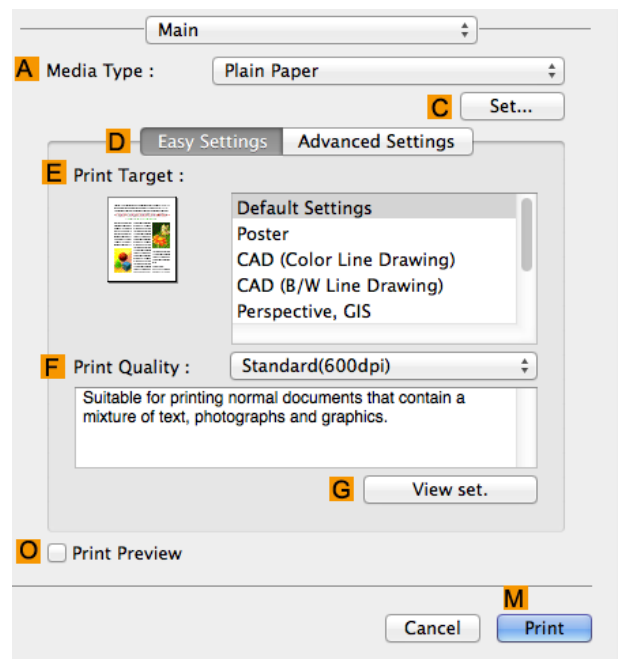

- 7 In the **A Media Type** list, select the type of paper that is loaded.

8 Click **D Advanced Settings** to switch the print mode.

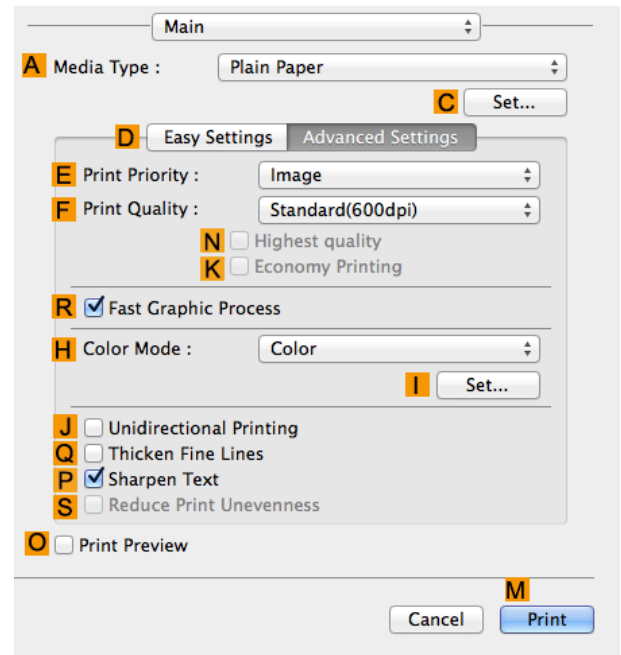

9 Click **Color** in the **H Color Mode** list.

10 Click **I Set** to display the **Color Settings** dialog box.

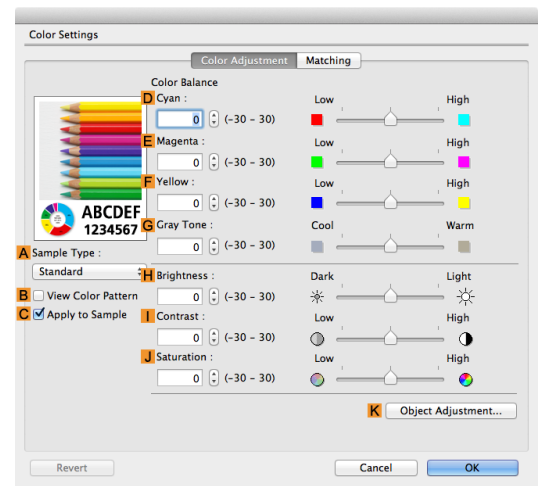

11 On the **Color Adjustment** pane, adjust the color tones, brightness, and so on as desired.

Adjustment Item	Description
D Cyan	Fine-tune color tones by adjusting the levels of Cyan, Magenta, and Yellow.
E Magenta	
F Yellow	
G Gray Tone	Adjust the gray tone. Choose cool black (tinged with blue), pure black (neutral), warm black (tinged with red), and so on.
H Brightness	Adjust the brightness of printed images while keeping the darkest and lightest portions intact.
I Contrast	Adjust the contrast of the darkest and lightest portions relative to each other. For soft gradation, decrease the contrast. For hard gradation, increase the contrast.
J Saturation	Adjust the level of color saturation, in a range from subdued to vivid.

 **Note** • Click **Object Adjustment** to open the **Object Adjustment** dialog box, which allows you to select the color adjustment target from **Images**, **Graphics**, and **Text**.

12 Click **OK** to close the **Color Settings** dialog box.

13 Access the **Page Setup** pane.

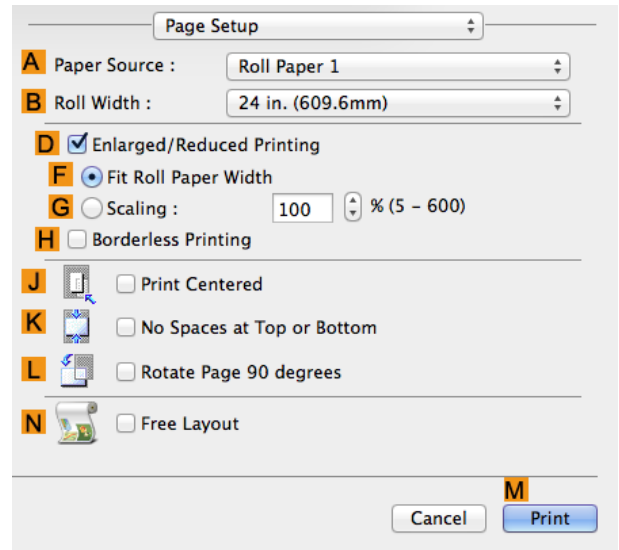

14 Confirm the print settings, and then click **M Print** to start printing.



• For tips on confirming print settings, see "Confirming Print Settings ." →P.270

Note

Giving Priority to Particular Graphic Elements and Colors for Printing

You can specify detailed print settings as desired for the quality level, colors, and other criteria.

• Advanced Settings

For printing results that appear just as expected for your original, you can specify which graphic elements and colors to prioritize for printing.



Note

• **Easy Settings** are also available, providing convenient presets. To use the presets, simply choose the printing application.

For details on **Easy Settings**, refer to the following topics.

- **Printing Photos and Images** →P.43
- **Printing Line Drawings and Text** →P.52
- **Printing Office Documents** →P.47

• Print Priority

Choose the graphic elements that you want to emphasize for printing.

Print Priority (*1)	Description
Image	A setting for posters or other documents made up mainly of photos or images, or for emphasizing photos or images in printed documents.
Line Drawing/Text	Choose this setting for CAD drawings made up mainly of intricate lines, or wall newspapers and other notices with a large amount of text. Suitable for emphasizing detailed text in printed documents. However, the quality may not be sufficient when printing photos or images that require a lot of color coverage. In this case, choose Image instead.
Office Document	Choose this setting for better legibility of documents combining text and graphics, such as documents and presentation material created with typical office applications.

*1: Options suitable for the selected type of paper are listed under Print Priority.

• Print Quality

Choose the print quality.

The printing mode is determined by a combination of the print quality and resolution.

Print Quality (*1)	Description	Print Priority
Highest	A setting for printing at the highest resolution when quality is most important. Printing takes longer and consumes more ink than in other modes, but this mode offers superior printing quality.	Image
High	Choose this setting to print at high resolution when quality is most important. Printing takes longer and consumes more ink than in Standard or Fast modes, but this mode offers exceptional printing quality.	Image Line Drawing/Text
Standard	Choose this setting to print at standard resolution when quality and speed are both important. Printing takes less time than in Highest or High mode.	Image Line Drawing/Text Office Document
Fast	Choose this setting to print faster. Printing in draft mode can help you work more efficiently when checking layouts.	Image Line Drawing/Text

*1: Options suitable for the selected Print Priority are listed under Print Quality.

• Color Settings

Setting Item	Options	Description
Color Mode (*1)	Color Monochrome Color (CAD) Monochrome (BK ink) Monochrome Bitmap No color correction	Choose whether to print in color or monochrome. (See "Adjusting the Color in the Printer Driver." → P.60)
Color Adjustment	Cyan Magenta Yellow Gray Tone Brightness Contrast Saturation	You can adjust the levels of cyan, magenta, and yellow as well as the brightness, contrast, saturation, and gray tones. If you choose Monochrome or Monochrome (BK ink) in Color Mode only Brightness and Contrast can be adjusted. Image , Graphics , and Text are available as Object Adjustment options.
Color-Matching Modes	Driver Matching Mode ICC Matching Mode Host ICM Mode (Windows) ColorSync (Mac OS)	Choose the color-matching mode.
Color-Matching Method (*2)	Auto Perceptual Colorimetric Saturation	Choose the color-matching method. The available options vary depending on your selection in Color-Matching Mode .
Gamma	2.2 1.8	You can adjust the gradation of intermediate tones in an image. You can select only after Driver Matching Mode has been selected in Matching Mode .

*1: Options suitable for the selected Print Priority are listed under Color Mode.

*2: The order of options displayed varies depending on the operating system.

• Enhancing printing quality

Setting Item	Description
Highest quality	This prints at the highest resolution. Printing takes longer and consumes more ink than in other modes, but this mode offers superior printing quality.
Thicken Fine Lines	Prints making fine lines appear thicker.
Sharpen Text	Choose this option to print intricate text more distinctly.

Setting Item	Description
Reduce Print Unevenness (*1)	Choose this option to counteract uneven printing.
Unidirectional Printing	Prints by suppressing color variations and misaligned ruled lines. However, this takes more time than regular printing.
Economy Printing	When this mode is selected, less ink is consumed than in regular printing, but the quality is diminished. Select this mode if you want to conserve ink when checking drawings, for example. Depending on the Media Type and Print Quality settings, this mode may not be available.

*1: Displayed in Mac OS.



- To print at a higher level of quality, in the printer driver, choose **High** or **Highest** in **Print Quality**, and select the **Unidirectional Printing** check box.

For instructions on specifying the print quality and color settings before printing, refer to the following topics, as appropriate for your operating system.

- **Choosing the Document Type and Printing Conditions (Windows)** → P.68
- **Choosing the Document Type and Printing Conditions (Mac OS)** → P.70

Choosing the Document Type and Printing Conditions (Windows)

You can specify your own print settings instead of using the **Print Target** presets. As an example, this topic describes how to print CAD drawings as clearly as possible, with sharp lines and text.

- 1 Choose **Print** in the application menu.
- 2 Select the printer in the dialog box, and then display the printer driver dialog box. (See "Accessing the Printer Driver Dialog Box from Applications .") → P.164
- 3 Make sure the **Main** sheet is displayed.

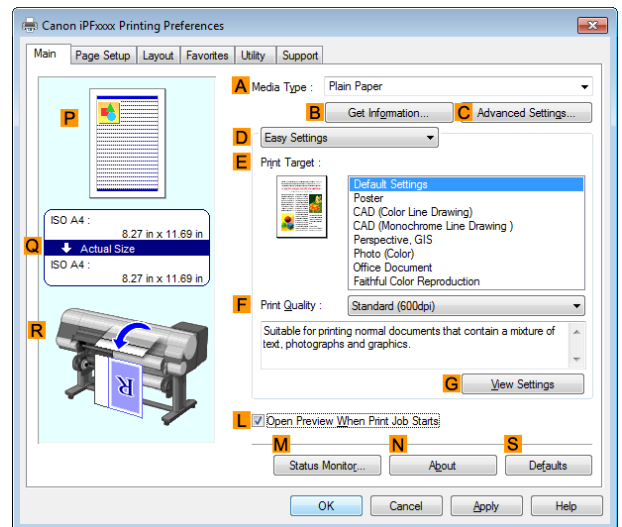

- 4 In the **A Media Type** list, select the type of paper that is loaded.

5 Click **D Advanced Settings** to switch the print mode.

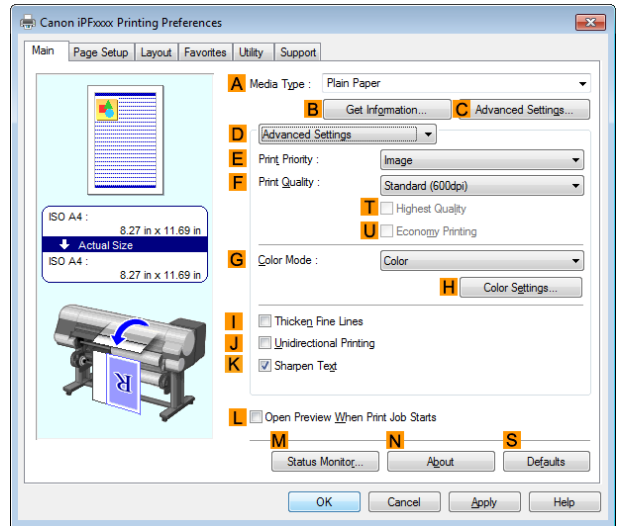

6 Click **Line Drawing/Text** in the **E Print Priority** list.

7 Click **High (1200dpi)** in the **F Print Quality** list.



Options displayed in the **F Print Quality** list vary depending on the paper type.

Note

8 Click **Color (CAD)** in the **G Color Mode** list.

9 To adjust the color, click **H Color Settings**.



For instructions on adjusting color, see "Adjusting the Color in the Printer Driver." →P.60

Note

10 Select the **K Sharpen Text** check box.

11 Click the **Page Setup** tab to display the **Page Setup** sheet.

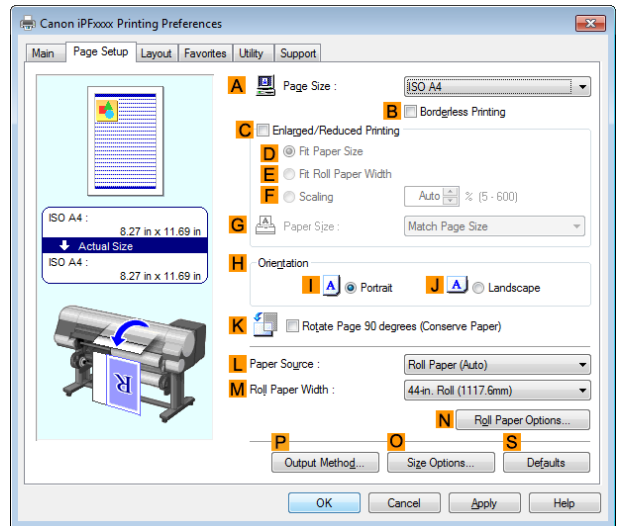

12 Confirm the settings of **A Page Size**, **L Paper Source**, and so on.

13 Confirm the print settings and print as desired.



For tips on confirming print settings, see "Confirming Print Settings ." →P.161

Note

Choosing the Document Type and Printing Conditions (Mac OS)

You can specify your own print settings instead of using the **Print Target** presets. This topic describes how print photographic images in monochrome.

- 1 Choose **Page Setup** from the application menu to display the **Page Attributes** dialog box.

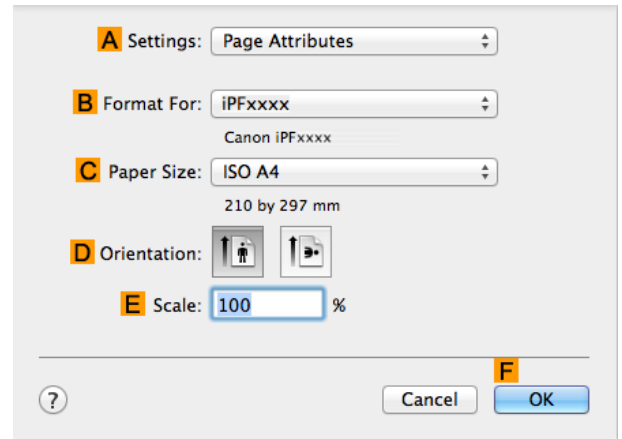

Note

- **Page Setup** might not be displayed in the menu depending on the OS you are using and the application software. In this case, select **Print** from the menu in the application software, and configure the settings in the upper part of the printer driver screen that is displayed.

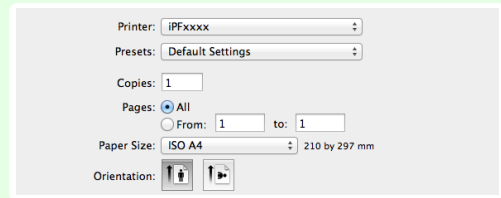

- 2 Select the printer in the **B Format for** list.
- 3 Choose the original size in the **C Paper Size** list.
- 4 Click **F OK** to close the dialog box.
- 5 In the application menu, choose **Print**.
- 6 Access the **Main** pane.

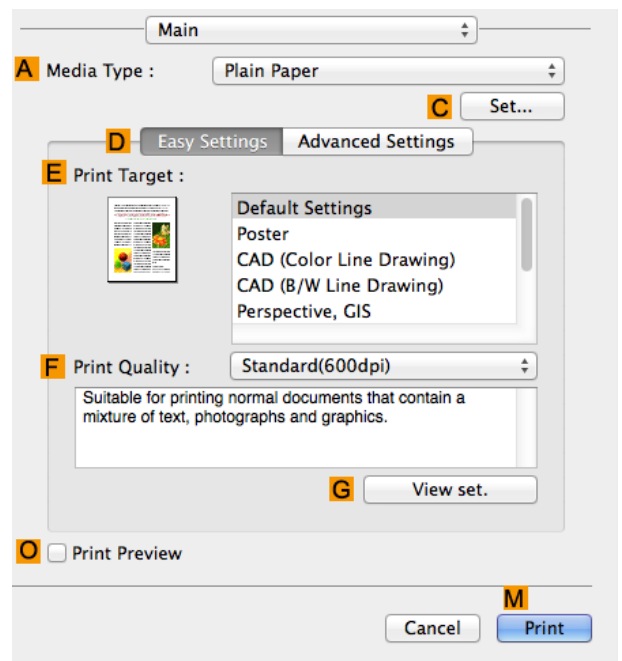

- 7 In the **A Media Type** list, select the type of paper that is loaded.

8 Click **D Advanced Settings** to switch the print mode.

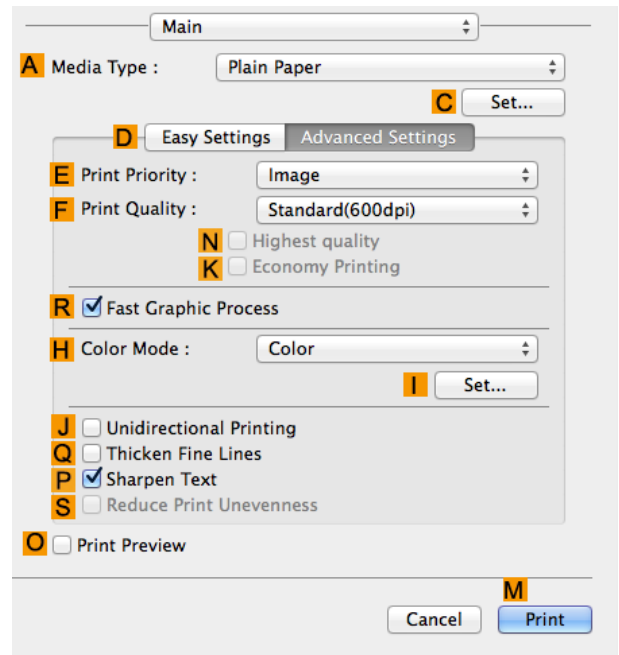

9 Click **Image** in the **E Print Priority** list.

10 Click **High (600dpi)** in the **F Print Quality** list.

 • Options displayed in the **F Print Quality** list vary depending on the paper type.

11 Click **Monochrome** in the **H Color Mode** list.

12 To adjust the brightness and contrast, click **I Set**.

 • For instructions on adjusting brightness and contrast, see "Adjusting the Color in the Printer Driver." →P.60

13 Access the **Page Setup** pane.

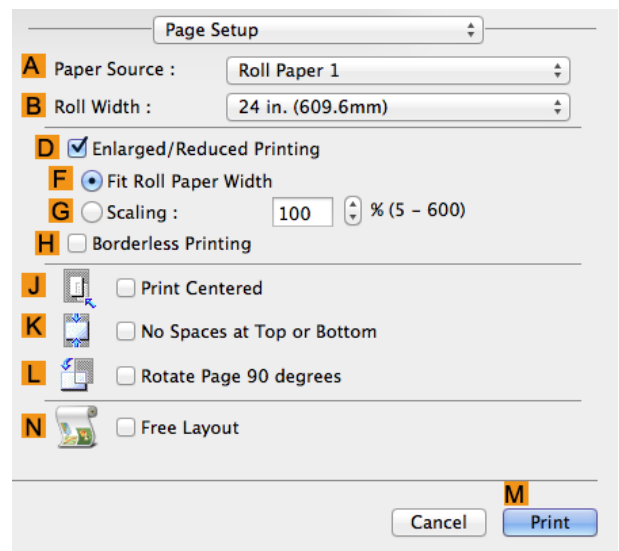

14 Confirm the print settings, and then click **M Print** to start printing.

 • For tips on confirming print settings, see "Confirming Print Settings ." →P.270

Printing enlargements or reductions

- Resizing Originals to Match the Paper Size 72
 - Resizing Originals to Match the Paper Size (Windows) 72
- Resizing Originals to Fit the Roll Width 74
 - Resizing Originals to Fit the Roll Width (Windows) 74
 - Resizing Originals to Fit the Roll Width (Mac OS) 76
- Resizing Originals by Entering a Scaling Value 78
 - Resizing Originals by Entering a Scaling Value (Windows) 79
 - Resizing Originals by Entering a Scaling Value (Mac OS) 80

Resizing Originals to Match the Paper Size

You can freely adjust the size of originals by enlarging or reducing them as desired.

• Enlarged/Reduced Printing

Enlarge or reduce the original in the printer driver, as desired.

• Fit Paper Size

Enlarge or reduce the original to match the size of the paper you are using.

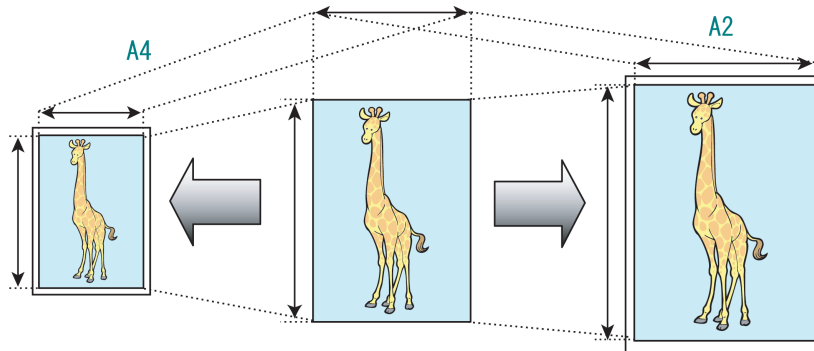

For instructions on printing with resizing to fit the paper size, refer to the following topics.

• Resizing Originals to Match the Paper Size (Windows) → P.72



Note

- To print with resizing to fit the paper size on Mac OS, use **Scale to fit paper size** in the **Paper Handling** panel provided by the OS. For more information, see the Mac OS User Manual.

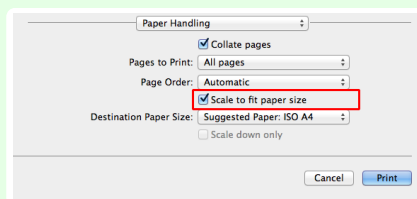

- For better printing results when enlarging photos from a digital camera in TIFF or JPEG format, use an image-editing application software such as Adobe Photoshop to specify an image resolution of 150 dpi or more at actual size.

Resizing Originals to Match the Paper Size (Windows)

This topic describes how to enlarge originals before printing to match the paper size, based on the following example.

- Document: Any Type
- Page size: A4 (210.0×297.0 mm)/Letter (8.3 × 11.7 in)
- Paper: Roll
- Paper type: Plain Paper

- Roll paper width: A2/A3 roll (420.0 mm [16.5 in])

- 1 Choose **Print** in the application menu.
- 2 Select the printer in the dialog box, and then open the printer driver dialog box. (See "Accessing the Printer Driver Dialog Box from Applications.") →P.164
- 3 Make sure the **Main** sheet is displayed.

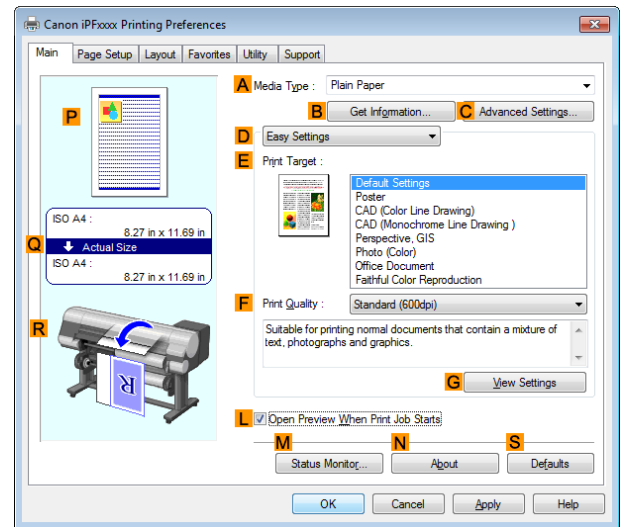

- 4 In the **A Media Type** list, select the type of paper that is loaded. In this case, click Plain Paper.
- 5 Select the printing application in the **E Print Target** list.
- 6 Click the **Page Setup** tab to display the **Page Setup** sheet.

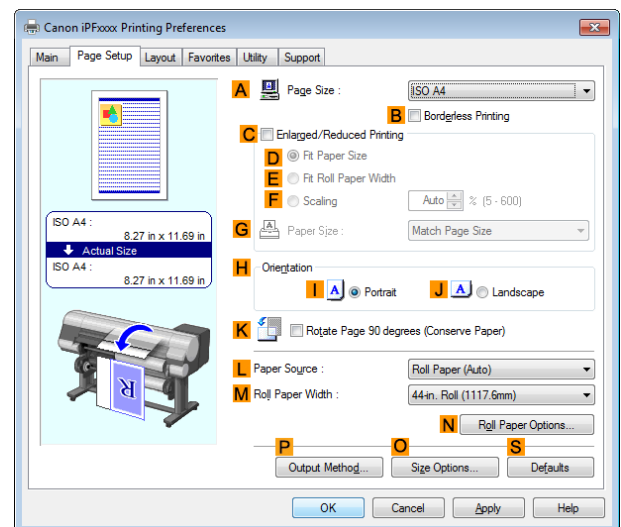

- 7 Select and click a roll paper in the **L Paper Source** list.
- 8 Select the width of the loaded roll in the **M Roll Paper Width** list—in this case, **ISO A2/A3 Roll (420.0mm)**.
- 9 In the **A Page Size** list, click the size of the original as specified in the application. In this case, click **ISO A4**.
- 10 Select the **C Enlarged/Reduced Printing** check box.
- 11 Select the **D Fit Paper Size** check box.
- 12 Click **ISO A3** in the **G Paper Size** list.

13 Confirm the print settings and print as desired.



Note

- For tips on confirming print settings, see "Confirming Print Settings ." →P.161

Resizing Originals to Fit the Roll Width

You can freely adjust the size of originals by enlarging or reducing them as desired.

• Enlarged/Reduced Printing

Enlarge or reduce the original in the printer driver, as desired.

• Fit Roll Paper Width

Enlarge or reduce the original as a whole to match the roll paper width, as desired.

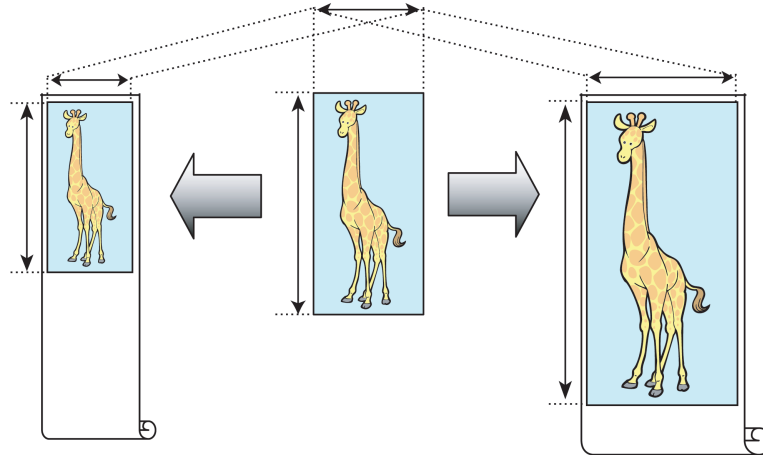

Resizing Originals to Fit the Roll Width (Windows)

This topic describes how to enlarge originals before printing to match the roll width, based on the following example.

- Document: Any type
- Page size: A4 (210.0×297.0 mm)/Letter (8.3 × 11.7 in)
- Paper: Roll
- Paper type: Plain Paper
- Roll paper width: 16 inches (406.4 mm)

1 Choose **Print** in the application menu.

2 Select the printer in the dialog box, and then display the printer driver dialog box. (See "Accessing the Printer Driver Dialog Box from Applications ." →P.164)

3 Make sure the **Main** sheet is displayed.

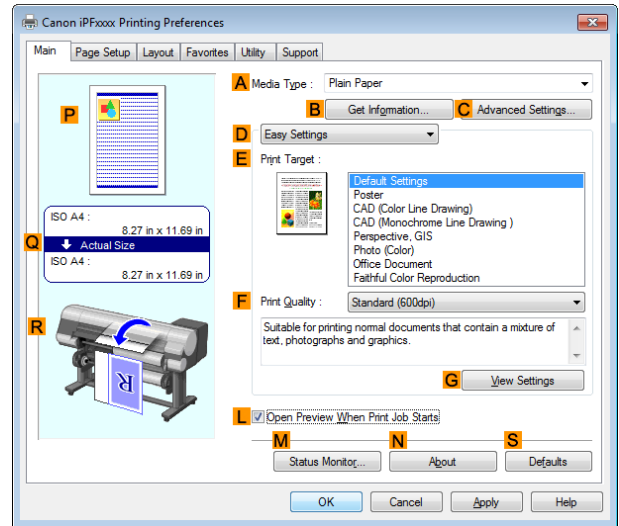

4 In the **A Media Type** list, select the type of paper that is loaded. In this case, click Plain Paper.

5 Select the printing application in the **E Print Target** list.

6 Click the **Page Setup** tab to display the **Page Setup** sheet.

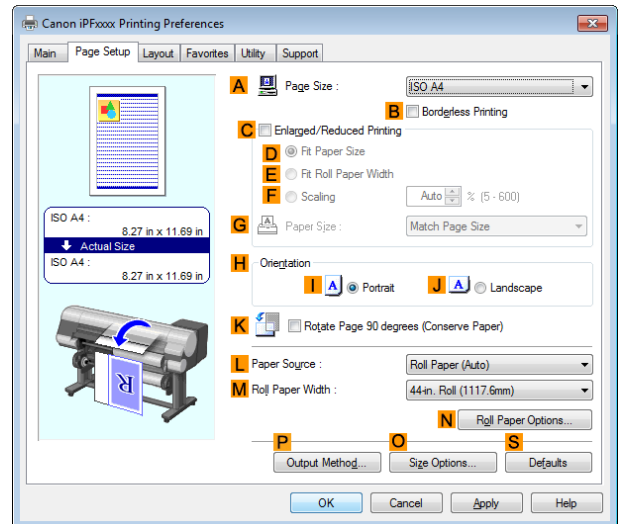

7 Select and click a roll paper in the **L Paper Source** list.

8 In the **A Page Size** list, click the size of the original as specified in the application. In this case, click **ISO A4** or **Letter (8.5"x11")**.

9 Select the **C Enlarged/Reduced Printing** check box.



Note

- If the **C Enlarged/Reduced Printing** check box is not displayed on the **Page Setup** sheet, clear the **B Borderless Printing** check box.

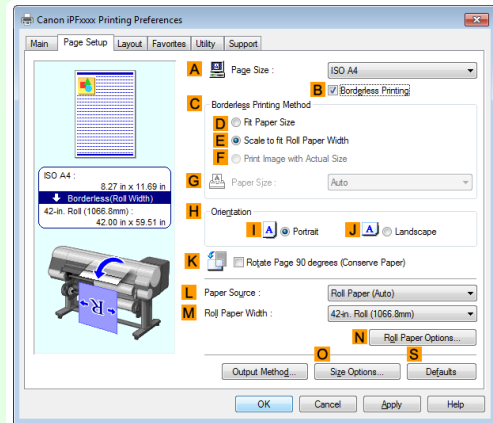

10 Click **E Fit Roll Paper Width**.



Note

- After you click **E Fit Roll Paper Width**, the **Information** dialog box is displayed. Select the width of the loaded roll in the **Roll Paper Width** list and click **OK**.
- Make sure the roll paper width you specify matches the width of the loaded roll.

11 Confirm the print settings and print as desired.



Note

- For tips on confirming print settings, see "Confirming Print Settings ." →P.161

Resizing Originals to Fit the Roll Width (Mac OS)

This topic describes how to enlarge originals before printing to match the roll width, based on the following example.

- Document: Any Type
- Page size: A4 (210.0 × 297.0 mm [8.3 × 11.7 in])
- Paper: Roll paper
- Paper type: Plain Paper
- Roll paper width: 16 inches (406.4 mm)

1 Choose **Page Setup** from the application menu to display the **Page Attributes** dialog box.

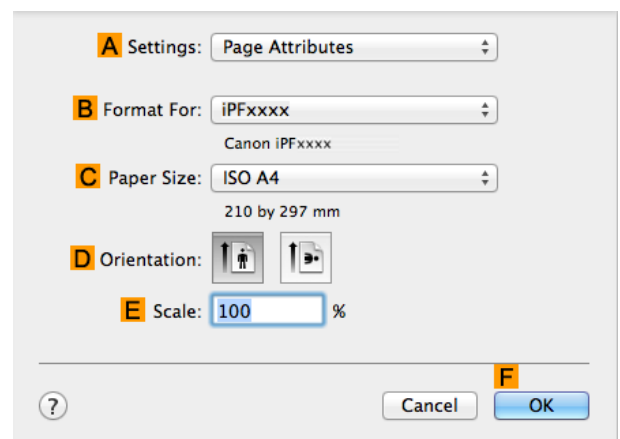



Note

- **Page Setup** might not be displayed in the menu depending on the OS you are using and the application software. In this case, select **Print** from the menu in the application software, and configure the settings in the upper part of the printer driver screen that is displayed.

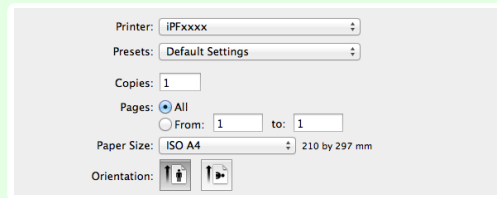

- 2 Select the printer in the **B Format for** list.
- 3 In **C Paper Size**, click the size of the original. In this case, click **ISO A4**.
- 4 Click **F OK** to close the dialog box.
- 5 Choose **Print** in the application menu.
- 6 Access the **Main** pane.

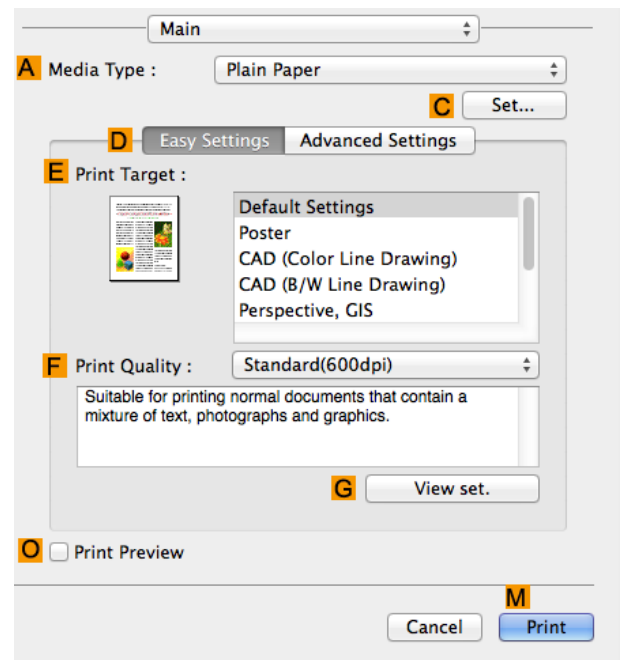

- 7 In the **A Media Type** list, select the type of paper that is loaded. In this case, click Plain Paper.
- 8 Make your selection in the **E Print Target** list.
- 9 Make your selection in the **F Print Quality** list.

10 Access the **Page Setup** pane.

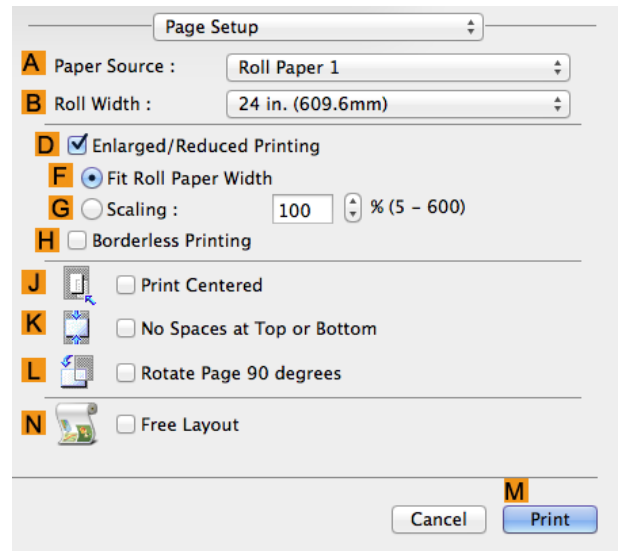

11 Select and click a roll paper in the **A Paper Source** list.

12 Select the paper width of the roll loaded in the printer for **B Roll Width**. In this case, **16 in. (406.4mm)** is selected.

13 Select the **D Enlarged/Reduced Printing** check box.

14 Click **F Fit Roll Paper Width**.

15 Confirm the print settings, and then click **M Print** to start printing.

 **Note** • For tips on confirming print settings, see "Confirming Print Settings ." [→P.270](#)

Resizing Originals by Entering a Scaling Value

You can freely adjust the size of originals by enlarging or reducing them as desired.

- **Enlarged/Reduced Printing**
Enlarge or reduce the original in the printer driver, as desired.
- **Scaling**
Enlarge or reduce originals by a particular amount, as desired.

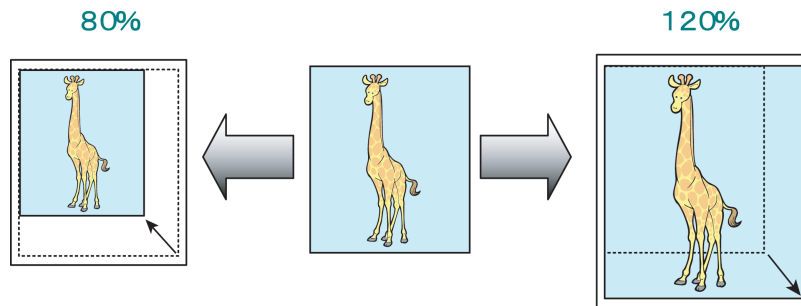

For instructions on entering a scaling value to resize originals, refer to the following topics, as appropriate for your operating system.

- **Resizing Originals by Entering a Scaling Value (Windows)** [→P.79](#)
- **Resizing Originals by Entering a Scaling Value (Mac OS)** [→P.80](#)



- For better printing results when enlarging photos from a digital camera in TIFF or JPEG format, use an image-editing application software such as Adobe Photoshop to specify an image resolution of 150 dpi or more at actual size.

Resizing Originals by Entering a Scaling Value (Windows)

This topic describes how to enlarge originals before printing by entering a scaling value, based on the following example.

- Document: Any Type
- Page size: A4 (210.0 × 297.0 mm [8.3 × 11.7 in])
- Paper: Roll paper
- Paper type: Plain Paper
- Roll paper width: A2/A3 roll (420.0 mm [16.5 in])



Important

- In borderless printing, you cannot resize originals by entering a scaling value.

1

Choose **Print** in the application menu.

2

Select the printer in the dialog box, and then display the printer driver dialog box. (See "Accessing the Printer Driver Dialog Box from Applications .") →P.164

3

Make sure the **Main** sheet is displayed.

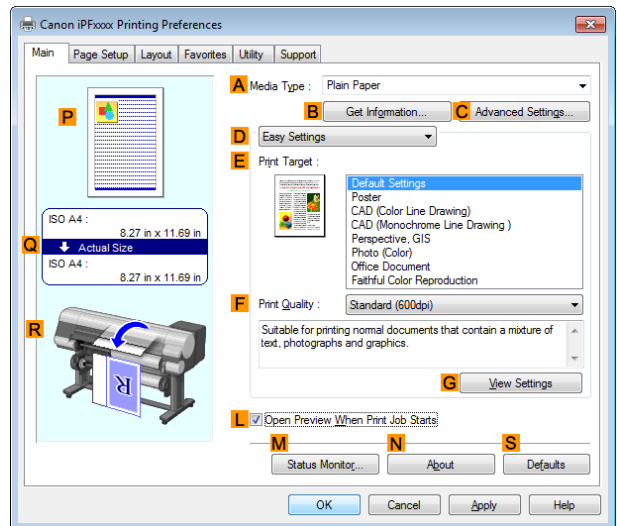

4

In the **A Media Type** list, select the type of paper that is loaded. In this case, click Plain Paper.

5

Select the printing application in the **E Print Target** list.

6 Click the **Page Setup** tab to display the **Page Setup** sheet.

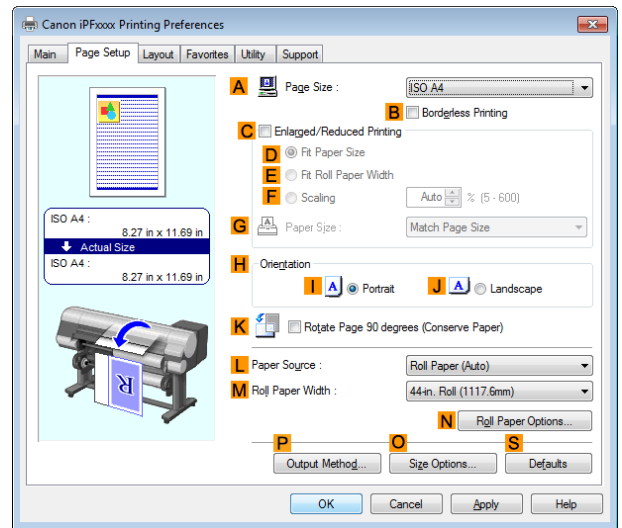

7 Select and click a roll paper in the **L Paper Source** list.

8 Select the width of the loaded roll in the **M Roll Paper Width** list—in this case, **ISO A2/A3 Roll (420.0mm)**.

9 In the **A Page Size** list, click the size of the original as specified in the application. In this case, click **ISO A4**.

10 Select the **C Enlarged/Reduced Printing** check box.

11 Click **ISO A4** in the **G Paper Size** list.

12 Click **F Scaling** and enter **120**.



- You can specify enlargement that exceeds the paper size, but in this case, the portions off the bottom and right edges of the paper will not be printed.
- If the original size after enlargement or reduction is smaller than the paper size, the original is printed in the upper-left corner. In this case, you can center originals by selecting **E Print Centered** on the **Layout** sheet.

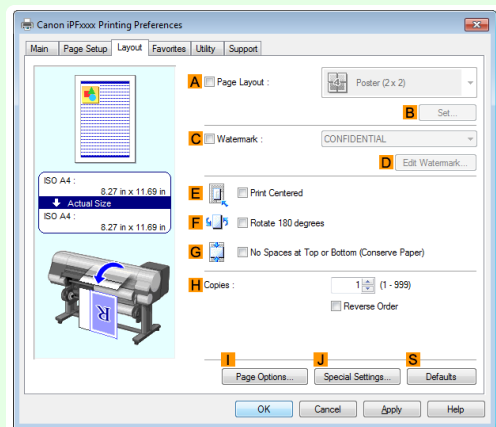

13 Confirm the print settings and print as desired.



- For tips on confirming print settings, see "Confirming Print Settings ." →P.161

Resizing Originals by Entering a Scaling Value (Mac OS)

This topic describes how to enlarge originals before printing by entering a scaling value, based on the following example.

- Document: Any Type
- Page size: A4 (210.0 × 297.0 mm [8.3 × 11.7 in])
- Paper: Roll paper
- Paper type: Plain Paper
- Roll paper width: A2/A3 roll (420.0 mm [16.5 in])

1 Choose **Page Setup** from the application menu to display the **Page Attributes** dialog box.

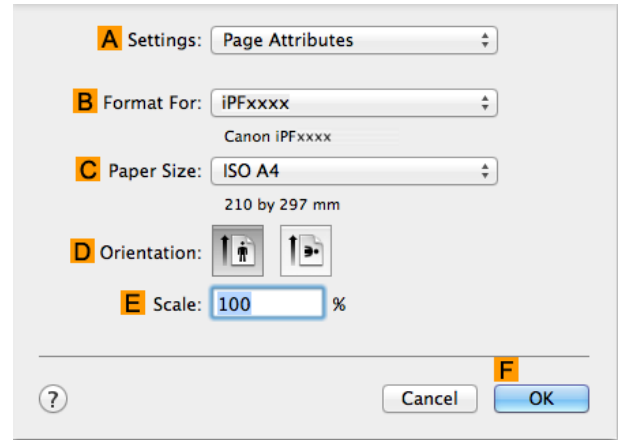

• **Page Setup** might not be displayed in the menu depending on the OS you are using and the application software. In this case, select **Print** from the menu in the application software, and configure the settings in the upper part of the printer driver screen that is displayed.

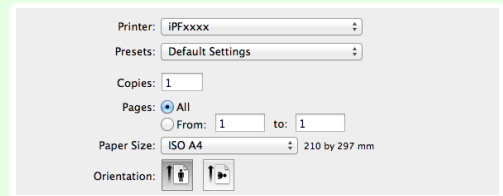

2 Select the printer in the **B Format for** list.

3 In **C Paper Size**, click the size of the original. In this case, click **ISO A4**.

4 Click **F OK** to close the dialog box.

5 Choose **Print** in the application menu.

6 Access the **Main** pane.

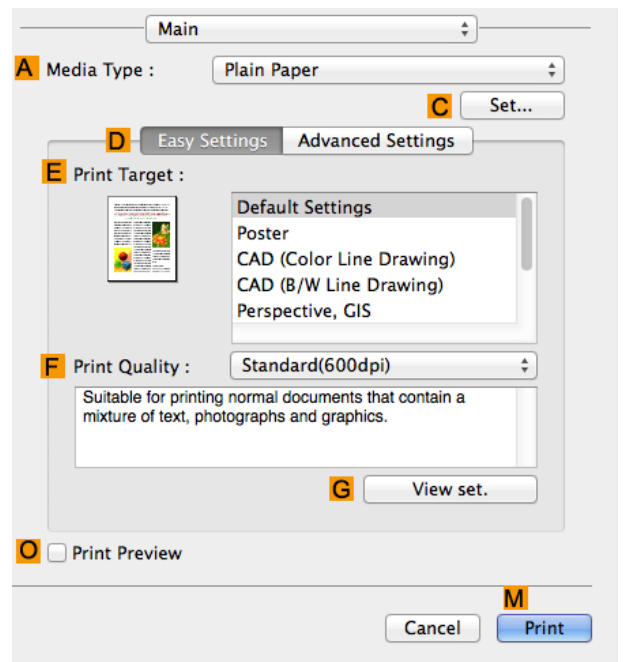

7 In the **A Media Type** list, select the type of paper that is loaded. In this case, click Plain Paper.

8 Make your selection in the **E Print Target** list.

9 Make your selection in the **F Print Quality** list.

10 Access the **Page Setup** pane.

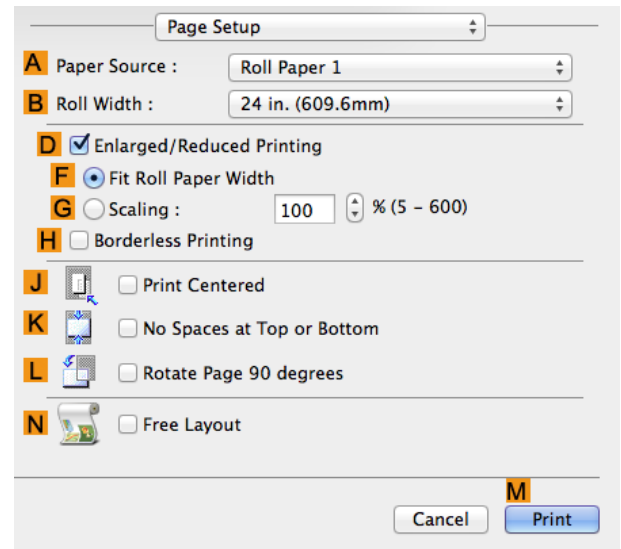

11 Select and click a roll paper in the **A Paper Source** list.

12 Select the paper width of the roll loaded in the printer for **B Roll Width**. In this case, **ISO A2/A3 (420.0mm)** is selected.

13 Select the **D Enlarged/Reduced Printing** check box.

14 Click **G Scaling** and enter **120**.



Note

- You can specify enlargement that exceeds the paper size, but in this case, the portion off the edge of the paper will not be printed.
- If the original size after enlargement or reduction is smaller than the paper size, the original is printed in the upper-left corner. In this case, you can center originals by selecting the **J Print Centered** check box.

15 Confirm the print settings, and then click **M Print** to start printing.



Note

- For tips on confirming print settings, see "Confirming Print Settings ." [→P.270](#)

Printing at full size

Printing on Oversize Paper	83
Printing at Full Size (Windows)	84
Printing at Full Size (Mac OS)	85
Borderless Printing at Actual Size	87
Borderless Printing at Actual Size (Windows)	88
Borderless Printing at Actual Size (Mac OS)	90

Printing on Oversize Paper

You can print all areas of the original at full scale by selecting the paper size from **Oversize** (sizes where the margins needed for printer operation have been added to the page size). We recommend when printing with a focus on image.



Note • If you prepare an original for printing without a margin and print it on paper of regular size, the image near the edge will not be printed.

• Oversize

When printing on standard paper sizes, printing is performed by taking the margins necessary for printer operations inside the region of the original. (See "Print Area.") →P.675 For example, printing the A4 size (210 x 297 mm) original shown in Figure (b) gives the result as shown in Figure (a).

However, if **Oversize** paper is selected, printing is performed by taking the margins necessary for printer operations outside of the region of the original to give the result as shown in Figure (c).

The A4 size print as shown in Figure (b) can then be obtained by trimming the margins from the periphery after printing.

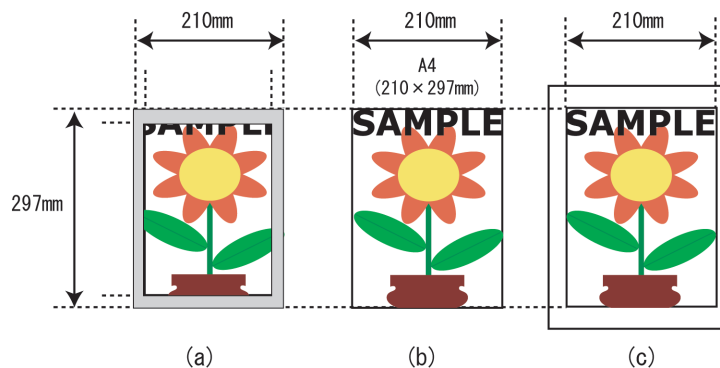

Important

- When printing on **Oversize** paper, load paper larger than the page size—a size that includes the margin required by the printer.
 - Sheets: Load paper that is at least 10 mm (0.39 in) wider and 28 mm (1.10 in) higher than the page size
 - Rolls: Load paper that is at least 10 mm (0.39 in) wider and 10 mm (0.39 in) higher than the page size



Note

- Paper larger than the maximum size supported by the printer cannot be used as paper for oversized printing. (See "Paper Sizes.") →P.332
- Oversized printing (selecting **Oversize** in **Page Size**) is only available in Windows.
- If you are performing oversized printing in Mac OS, you need to configure printing on non-standard paper sizes.
- To specify a non-standard paper size in oversized printing, register the paper size as a Custom Paper Size. Oversized printing is not available with **Custom Size**. (See "Printing on Non-Standard Paper Sizes.") →P.108

For instructions on oversize printing, refer to the following topics, as appropriate for your operating system.

- **Printing at Full Size (Windows)** →P.84

- **Printing at Full Size (Mac OS)** →P.85

Printing at Full Size (Windows)

This topic describes how to print at full size based on the following example. (Oversized Printing)

- Document: Any Type
- Page size: A4 (210.0×297.0 mm)/Letter (8.3 × 11.7 in)
- Paper: Roll
- Paper type: Plain Paper
- Roll paper width: A2/A3 roll (420.0 mm [16.5 in])

1 Choose **Print** in the application menu.

2 Select the printer in the dialog box, and then display the printer driver dialog box. (See "Accessing the Printer Driver Dialog Box from Applications .") →P.164

3 Make sure the **Main** sheet is displayed.

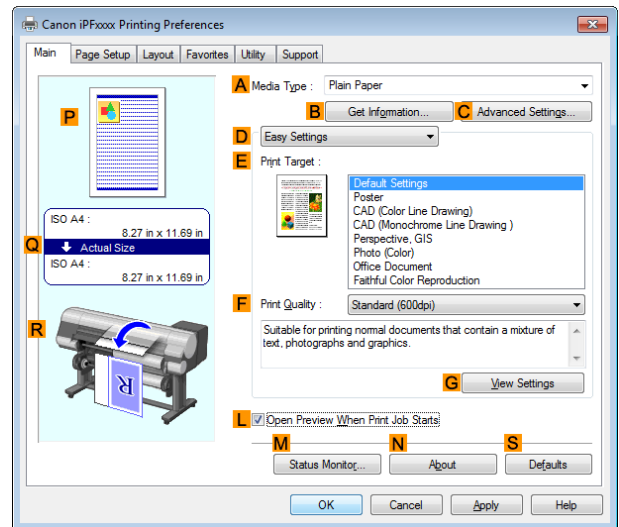

4 In the **A Media Type** list, select the type of paper that is loaded. In this case, click Plain Paper.

5 Click the **Page Setup** tab to display the **Page Setup** sheet.

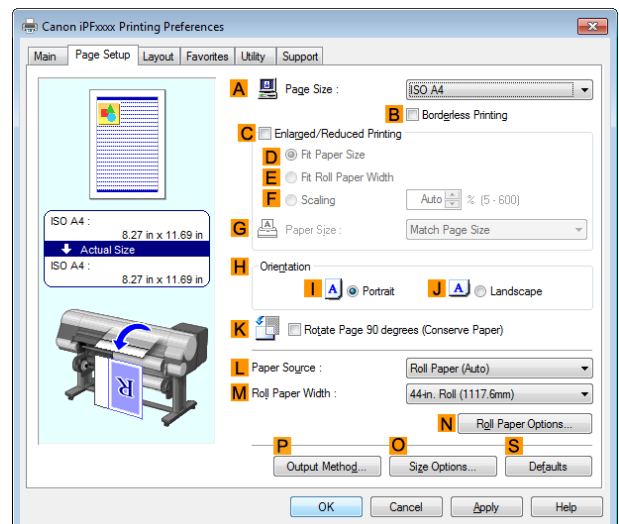

6 Click **O Size Options** to display the **Paper Size Options** dialog box.

7 In the **Paper Size Options** dialog box, select the **Oversize** check box in **Display Series**.

8 Click **OK** to close the **Paper Size Options** dialog box.

- 9** Click **Oversize - ISO A4** in the **A Page Size** list.
- 10** Select and click a roll paper in the **L Paper Source** list.
- 11** Select the width of the loaded roll in the **M Roll Paper Width** list—in this case, **ISO A2/A3 Roll (420.0mm)**.
- 12** Confirm the print settings and print as desired.

 • For tips on confirming print settings, see "Confirming Print Settings ." [→P.161](#)

Note

Printing at Full Size (Mac OS)

This topic describes how to print at full size based on the following example. (Oversized Printing)

- Document: Any Type
- Page size: A4 (210.0 × 297.0 mm [8.3 × 11.7 in])
- Paper: Roll paper
- Paper type: Plain Paper
- Roll paper width: A2/A3 roll (420.0 mm [16.5 in])

- 1** Choose **Page Setup** from the application menu to display the **Page Attributes** dialog box.

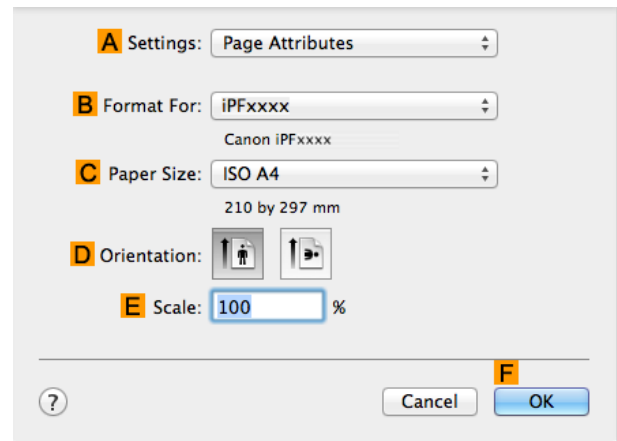

 • **Page Setup** might not be displayed in the menu depending on the OS you are using and the application software. In this case, select **Print** from the menu in the application software, and configure the settings in the upper part of the printer driver screen that is displayed.

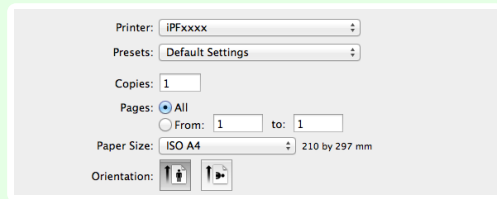

- 2** Select the printer in the **B Format for** list.
- 3** In **C Paper Size**, click the size of the original. In this case, click **ISO A4 - Oversize**.
- 4** Click **F OK** to close the dialog box.
- 5** Choose **Print** in the application menu.

6 Access the **Main** pane.

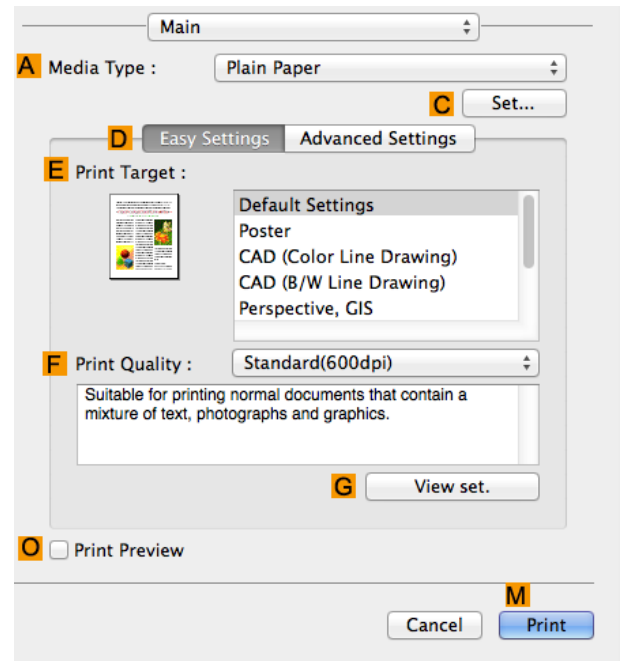

7 In the **A Media Type** list, select the type of paper that is loaded. In this case, click Plain Paper.

8 Make your selection in the **E Print Target** list.

9 Make your selection in the **F Print Quality** list.

10 Access the **Page Setup** pane.

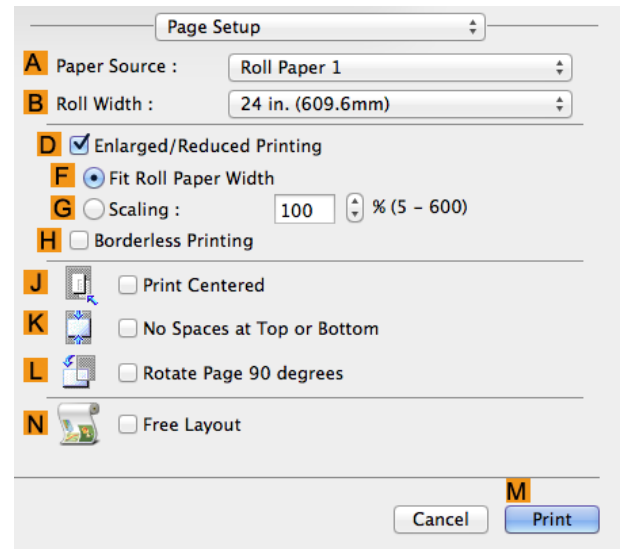

11 Select and click a roll paper in the **A Paper Source** list.

12 Select the paper width of the roll loaded in the printer for **B Roll Width**. In this case, **ISO A2/A3 (420.0mm)** is selected.

13 Confirm the print settings, and then click **M Print** to start printing.



• For tips on confirming print settings, see "Confirming Print Settings ." →P.270

Note

Borderless Printing at Actual Size

Take advantage of borderless printing to print documents such as posters (made up mainly of photos or images) without a surrounding margin, or border. In regular printing, a margin required by the printer is added around the original. With borderless printing, you can print documents without the margin, so that the printed image covers the entire surface of the paper.

- Borderless printing is only available with rolls.
- Paper you can use for borderless printing is restricted to particular types of paper and rolls of particular widths. (See "Displaying the Paper Reference Guide." → P.335)
- Although it normally prints borderless on the top, bottom, left, and right (4-edge borderless), in the following cases, it becomes borderless only on the left and right (2-edge borderless) because the top and bottom of the printed image are not automatically cut.
 - When paper where the borderless printing is described as two edges only in the **Paper Reference Guide** (paper where printed image areas cannot be cut cleanly) is selected
 - When the following settings are made in the printer control panel
 - **Cutting Mode is Manual**
 - **CutDustReduct. is On**
 - When auto cut is configured as not performed in the printer driver



Important

- Borderless printing is not possible if details such as crop marks and margins are included as data on the periphery of the original.
- If the length of the image to print is short, then since the roll paper is fed out to a prescribed length before cutting in order to prevent cutting problems and ejection problems, the trailing edge of the roll paper might not be printed borderless.
- These features cannot be used in combination with borderless printing: special page layouts, centering originals, and printing cut lines on rolls.
- If **Fit Paper Size** or **Print Image with Actual Size** (Windows only) is selected while performing borderless printing, **Rotate Page 90 degrees (Conserve Paper)** cannot be selected. Note that if borderless printing is possible, then even if the original is rotated 90 degrees, it will be printed by automatically rotating the page by 90 degrees.
- Do not perform borderless printing when using the stacker. Doing so may cause a paper jam.

Choose the method of borderless printing that suits the original, as desired.

Print Image with Actual Size

Prints originals at actual size, without enlarging or reducing them. We recommend when focusing on image quality. You should create the original at a size larger by 3 mm on each side than the paper size.

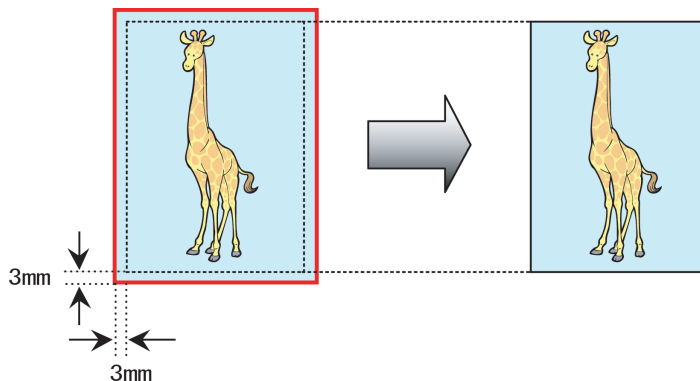

Note

- Not all page sizes are available.
- When performing borderless printing without using **Print Image with Actual Size**, the image deteriorates slightly because the image is automatically enlarged.

For instructions on borderless printing of photos and images at actual size, refer to the following topics, as appropriate for your operating system.

- **Borderless Printing at Actual Size (Windows)** →P.88
- **Borderless Printing at Actual Size (Mac OS)** →P.90

Borderless Printing at Actual Size (Windows)

This topic describes how to print borderlessly at actual size based on the following example.



- When borderless printing is used, the edge of the paper is cut during printing. Thus, ink density may be uneven at the edges. If you require higher image quality, select **No** from the **Automatic Cutting** list in the **Roll Paper Options** dialog box. In this case, the paper can be printed without borders on the left and right sides only. Once printed and cut, please cut the upper and lower bands with scissors.

- Document: Any type
- Page size: 10×12 inches (254.0×304.8 mm)
- Paper: Roll
- Paper type: **Canon Glossy Photo Paper 170gsm**
- Roll paper width: 10 inches (254.0 mm)

1 Create the original in the source application 3 mm (0.12 in) larger on each side than 254.0×304.8 mm (10 × 12 in)—that is, 260.0×310.8 mm (10.2 × 12.2 in)



- If you can specify the margin, as in Microsoft Word, set the margin at 0 mm. For instructions on specifying the margin, refer to the software documentation.
- The extra 3 mm (0.12 in) on each side will not be printed. Create the original so that it fits inside the paper area to be printed on.

2 Choose **Print** in the application menu.

3 Select the printer in the dialog box, and then display the printer driver dialog box. (See "Accessing the Printer Driver Dialog Box from Applications .") →P.164

4 Make sure the **Main** sheet is displayed.

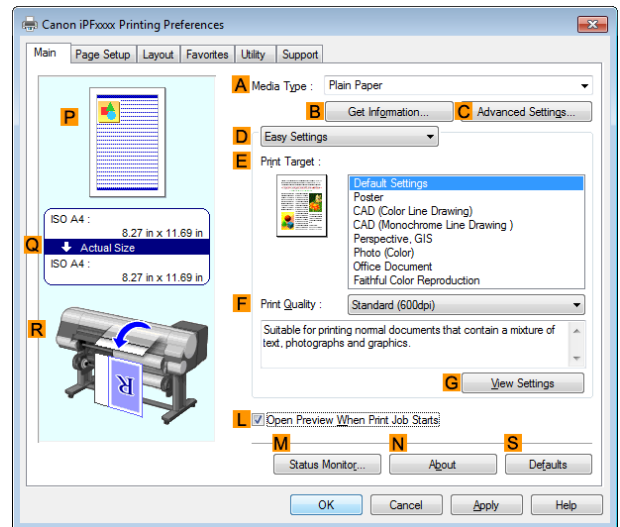

5 In the **A Media Type** list, select the type of paper that is loaded. In this case, click **Canon Glossy Photo Paper 170gsm**.

6 Select the print target in the **E Print Target** list.



- When you are using paper that takes longer for ink to adhere for borderless printing and the Cutter Unit touches printing surfaces that are not dry yet, it may damage the paper or the edge of the document that is cut, depending on frequency of use. In this kind of situation, change the ink drying time using the following procedure.

- Click **Advanced Settings** in **Media Type**.
- Select an ink drying time in the list for the **Between Pages** setting of **Drying Time**.

7 Click the **Page Setup** tab to display the **Page Setup** sheet.

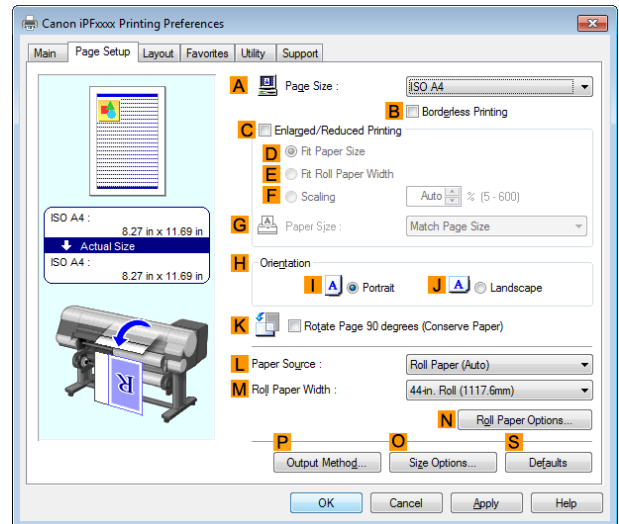

8 In the **A Page Size** list, click the size of the original as specified in the source application. In this case, click **10"x12"**.

9 Select and click a roll paper in the **L Paper Source** list.

10 Select the **B Borderless Printing** check box to display the **Information** dialog box.

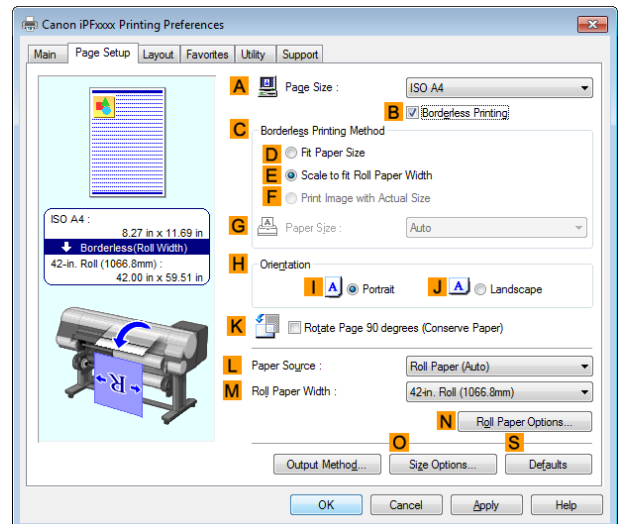

11 Select the width of the loaded roll in the **Roll Paper Width** list—in this case, click **10-in. Roll (254.0mm)**.

12 Click **OK** to close the **Information** dialog box.

13 In **C Borderless Printing Method**, click **F Print Image with Actual Size**.

14 Confirm the print settings and print as desired.



• For tips on confirming print settings, see "Confirming Print Settings ." →P.161

Borderless Printing at Actual Size (Mac OS)

This topic describes how to print borderlessly at actual size based on the following example.



• When borderless printing is used, the edge of the paper is cut during printing. Thus, ink density may be uneven at the edges. If you require higher image quality, select **No** from the **Automatic Cutting** list in the **Paper Detailed Settings** dialog box. In this case, the paper can be printed without borders on the left and right sides only. Once printed and cut, please cut the upper and lower bands with scissors.

- Document: Any type
- Page size: 10 × 12 inches (254.0×304.8 mm)–Borderless
- Paper: Roll
- Paper type: **Canon Glossy Photo Paper 170gsm**
- Roll paper width: 10 inches (254.0 mm)

1 Choose **Page Setup** from the application menu to display the **Page Attributes** dialog box.

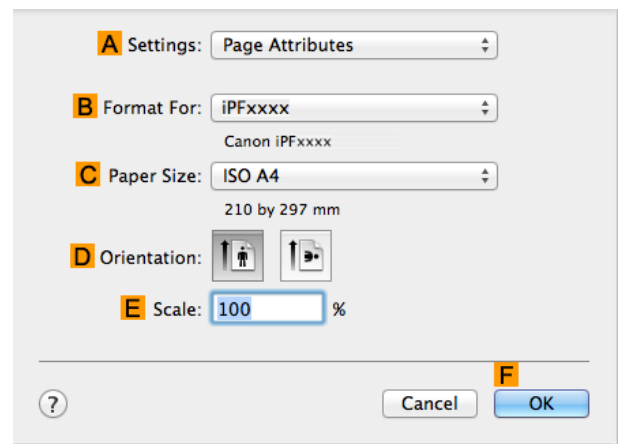

• **Page Setup** might not be displayed in the menu depending on the OS you are using and the application software. In this case, select **Print** from the menu in the application software, and configure the settings in the upper part of the printer driver screen that is displayed.

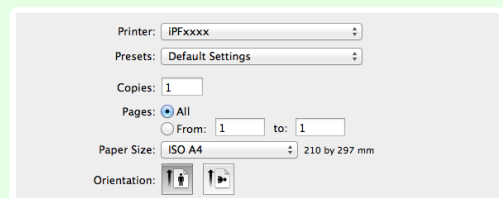

2 Select the printer in the **B Format for** list.

3 In the **C Paper Size** list, choose a paper size supported for borderless printing. Here, click **10"x12" - Borderless**.



• Paper sizes supported for borderless printing are indicated by **-Borderless**.

4 Click **F OK** to close the dialog box.

5 In the application, create an original that takes up the entire space of the paper size.

6 Choose **Print** in the application menu.

7 Access the **Main** pane.

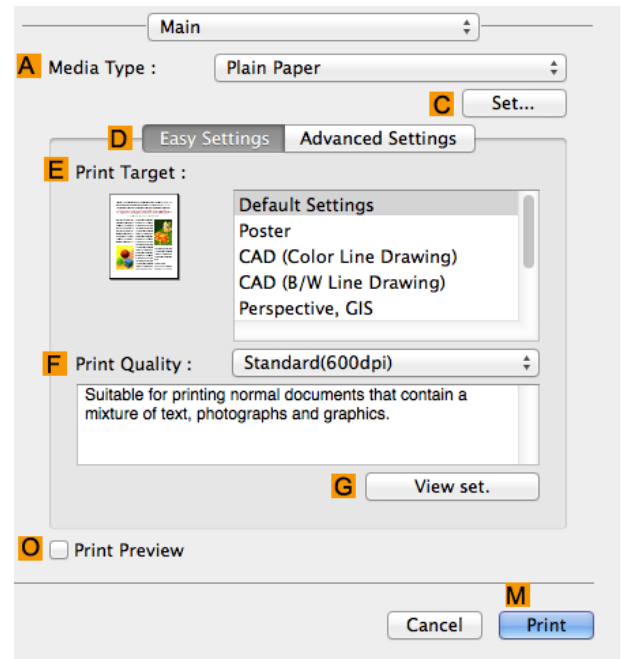

8 In the **A Media Type** list, select the type of paper that is loaded. In this case, click **Canon Glossy Photo Paper 170gsm**.

9 Select the print target in the **E Print Target** list.



Important

- When you are using paper that takes longer for ink to adhere for borderless printing and the Cutter Unit touches printing surfaces that are not dry yet, it may damage the paper or the edge of the document that is cut, depending on frequency of use. In this kind of situation, change the ink drying time in **Between Pages** in the **Paper Detailed Settings** dialog box.

10 Access the **Page Setup** pane.

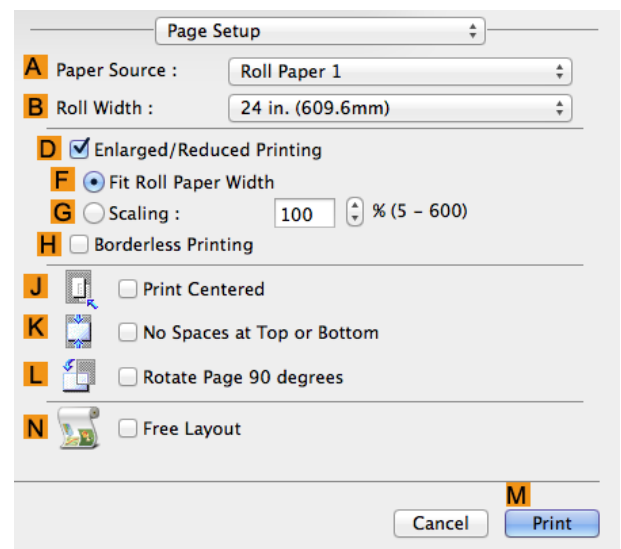

11 Select and click a roll paper in the **A Paper Source** list. Select the paper width of the roll loaded in the printer for **B Roll Width**. In this case, **10 in. (254.0mm)** is selected.

12 Confirm the print settings, and then click **M Print** to start printing.



Note

- For tips on confirming print settings, see "Confirming Print Settings ." → P.270

Borderless Printing

- Borderless Printing on Paper of Equivalent Size 92
 - Borderless Printing by Resizing Originals to Match the Paper Size (Windows) 93
- Borderless Printing by Resizing Originals to Fit the Roll Width 95
 - Borderless Printing by Resizing Originals to Fit the Roll Width (Windows) 96
 - Borderless Printing by Resizing Originals to Fit the Roll Width (Mac OS) 98
- Borderless Printing at Actual Size 87
 - Borderless Printing at Actual Size (Windows) 88
 - Borderless Printing at Actual Size (Mac OS) 90

Borderless Printing on Paper of Equivalent Size

Take advantage of borderless printing to print documents such as posters (made up mainly of photos or images) without a surrounding margin, or border.

In regular printing, a margin required by the printer is added around the original. With borderless printing, you can print documents without the margin, so that the printed image covers the entire surface of the paper.

- Borderless printing is only available with rolls.
- Paper you can use for borderless printing is restricted to particular types of paper and rolls of particular widths. (See "Displaying the Paper Reference Guide." → P.335)
- Although it normally prints borderless on the top, bottom, left, and right (4-edge borderless), in the following cases, it becomes borderless only on the left and right (2-edge borderless) because the top and bottom of the printed image are not automatically cut.
 - When paper where the borderless printing is described as two edges only in the **Paper Reference Guide** (paper where printed image areas cannot be cut cleanly) is selected
 - When the following settings are made in the printer control panel
 - **Cutting Mode** is **Manual**
 - **CutDustReduct.** is **On**
 - When auto cut is configured as not performed in the printer driver



Important

- Borderless printing is not possible if details such as crop marks and margins are included as data on the periphery of the original.
- If the length of the image to print is short, then since the roll paper is fed out to a prescribed length before cutting in order to prevent cutting problems and ejection problems, the trailing edge of the roll paper might not be printed borderless.
- These features cannot be used in combination with borderless printing: special page layouts, centering originals, and printing cut lines on rolls.
- If **Fit Paper Size** or **Print Image with Actual Size** (Windows only) is selected while performing borderless printing, **Rotate Page 90 degrees (Conserve Paper)** cannot be selected. Note that if borderless printing is possible, then even if the original is rotated 90 degrees, it will be printed by automatically rotating the page by 90 degrees.
- Do not perform borderless printing when using the stacker. Doing so may cause a paper jam.

Choose the method of borderless printing that suits the original, as desired.

• **Fit Paper Size**

Enlarge or reduce the original to match the size of the paper you are using.

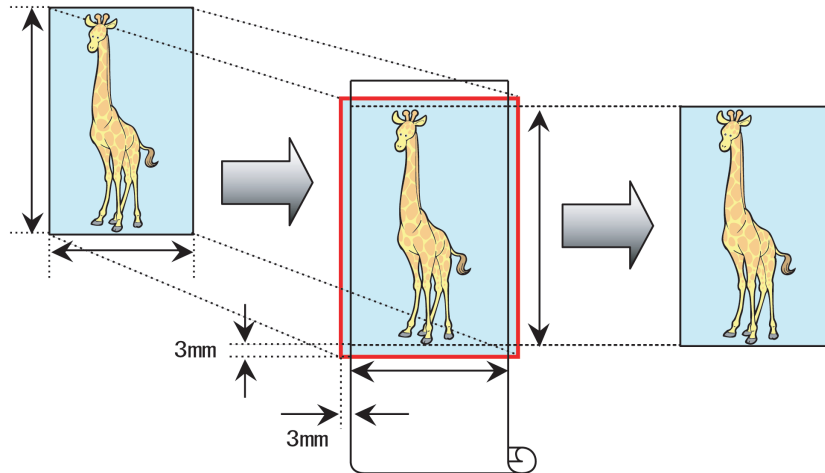

• The printer driver automatically enlarges originals 3 mm (0.12 in) past the dimensions of the paper on each side. The 3 mm portion beyond the edge on each side is not printed.

For instructions on borderless printing of photos, images, and other documents to match the paper size, refer to the following topics, as appropriate for your operating system.

- **Borderless Printing by Resizing Originals to Match the Paper Size (Windows)** → P.93



• To perform borderless printing with resizing to fit the paper size on Mac OS, select borderless in **Paper Size** and use **Scale to fit paper size** in the **Paper Handling** panel provided by the OS. For more information, see the Mac OS User Manual.

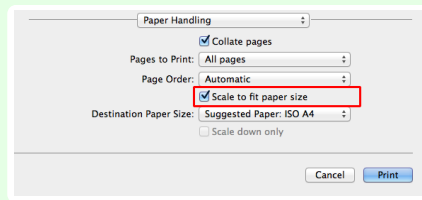

Borderless Printing by Resizing Originals to Match the Paper Size (Windows)

This topic describes how to enlarge originals before borderless printing to match the paper size, based on the following example.



• When borderless printing is used, the edge of the paper is cut during printing. Thus, ink density may be uneven at the edges. If you require higher image quality, select **No** from the **Automatic Cutting** list in the **Roll Paper Options** dialog box. In this case, the paper can be printed without borders on the left and right sides only. Once printed and cut, please cut the upper and lower bands with scissors.

- Document: Any type
- Page size: 10×12 inches (254.0×304.8 mm)
- Paper: Roll
- Paper type: **Canon Glossy Photo Paper 170gsm**
- Roll paper width: 10 inches (254.0 mm)

1 In the application, create an original that takes up the entire space of the paper size.



• If you can specify the margin, as in Microsoft Word, set the margin at 0 mm. For instructions on specifying the margin, refer to the software documentation.

2 Choose **Print** in the application menu.

3 Select the printer in the dialog box, and then display the printer driver dialog box. (See "Accessing the Printer Driver Dialog Box from Applications .") →P.164

4 Make sure the **Main** sheet is displayed.

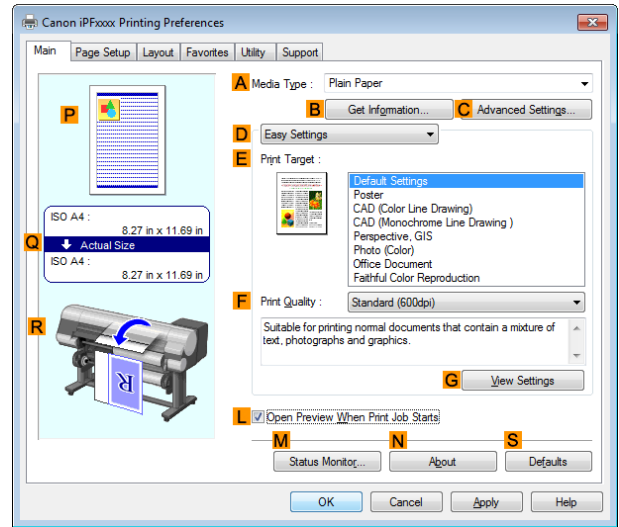

5 In the **A Media Type** list, select the type of paper that is loaded. In this case, click **Canon Glossy Photo Paper 170gsm**.

6 Select the print target in the **E Print Target** list.



- When you are using paper that takes longer for ink to adhere for borderless printing and the Cutter Unit touches printing surfaces that are not dry yet, it may damage the paper or the edge of the document that is cut, depending on frequency of use. In this kind of situation, change the ink drying time using the following procedure.
 - Click **Advanced Settings** in **Media Type**.
 - Select an ink drying time in the list for the **Between Pages** setting of **Drying Time**.

7 Click the **Page Setup** tab to display the **Page Setup** sheet.

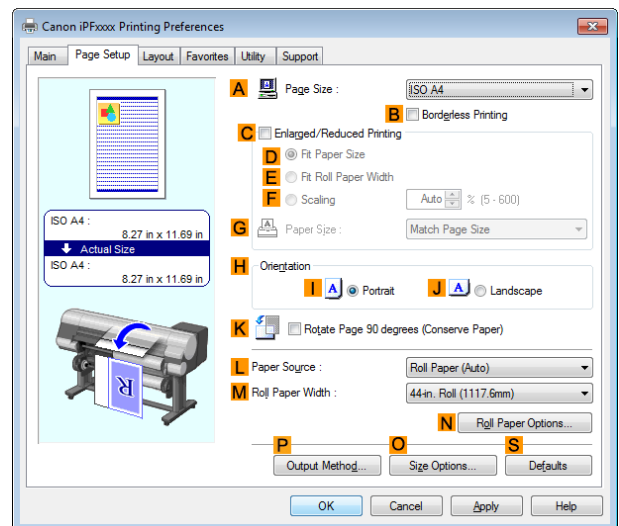

8 In the **A Page Size** list, click the size of the original as specified in the application. In this case, click **10"x12"**.

9 Select and click a roll paper in the **L Paper Source** list.

- 10** Select the **B Borderless Printing** check box to display the **Information** dialog box.

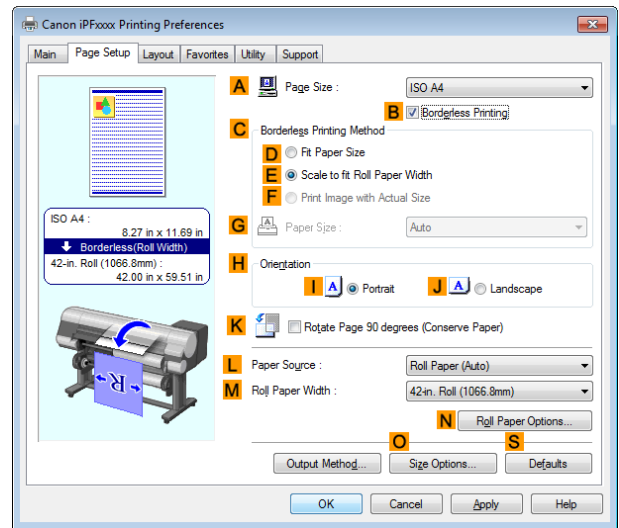

- 11** Select the width of the loaded roll in the **Roll Paper Width** list—in this case, click **10-in. Roll (254.0mm)**.
- 12** Click **OK** to close the **Information** dialog box.
- 13** In **C Borderless Printing Method**, click **D Fit Paper Size**.
- 14** Click **Match Page Size** in the **G Paper Size** list.
- 15** Confirm the print settings and print as desired.



Note

- For tips on confirming print settings, see "Confirming Print Settings ." →P.161

Borderless Printing by Resizing Originals to Fit the Roll Width

Take advantage of borderless printing to print documents such as posters (made up mainly of photos or images) without a surrounding margin, or border.

In regular printing, a margin required by the printer is added around the original. With borderless printing, you can print documents without the margin, so that the printed image covers the entire surface of the paper.

- Borderless printing is only available with rolls.
- Paper you can use for borderless printing is restricted to particular types of paper and rolls of particular widths. (See "Displaying the Paper Reference Guide.") →P.335
- Although it normally prints borderless on the top, bottom, left, and right (4-edge borderless), in the following cases, it becomes borderless only on the left and right (2-edge borderless) because the top and bottom of the printed image are not automatically cut.
 - When paper where the borderless printing is described as two edges only in the **Paper Reference Guide** (paper where printed image areas cannot be cut cleanly) is selected
 - When the following settings are made in the printer control panel
 - **Cutting Mode** is **Manual**
 - **CutDustReduct.** is **On**
 - When auto cut is configured as not performed in the printer driver



- Borderless printing is not possible if details such as crop marks and margins are included as data on the periphery of the original.
- If the length of the image to print is short, then since the roll paper is fed out to a prescribed length before cutting in order to prevent cutting problems and ejection problems, the trailing edge of the roll paper might not be printed borderless.
- These features cannot be used in combination with borderless printing: special page layouts, centering originals, and printing cut lines on rolls.
- If **Fit Paper Size** or **Print Image with Actual Size** (Windows only) is selected while performing borderless printing, **Rotate Page 90 degrees (Conserve Paper)** cannot be selected. Note that if borderless printing is possible, then even if the original is rotated 90 degrees, it will be printed by automatically rotating the page by 90 degrees.
- Do not perform borderless printing when using the stacker. Doing so may cause a paper jam.

Choose the method of borderless printing that suits the original, as desired.

Scale to fit Roll Paper Width

Enlarge or reduce the original as a whole to match the roll paper width.

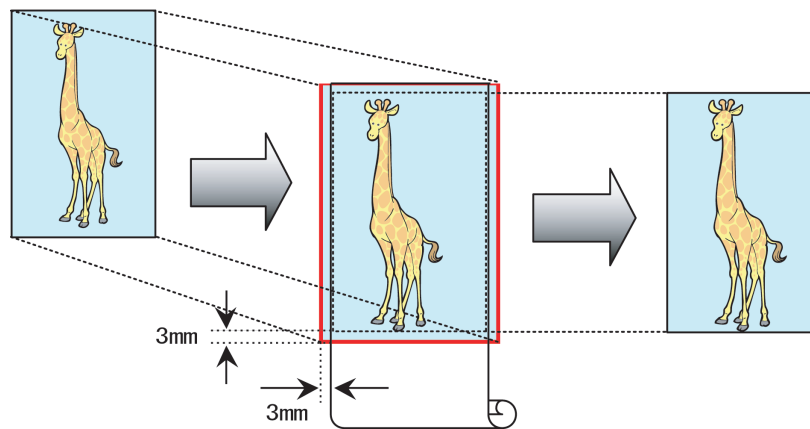

- You can combine this function with rotating pages 90 degrees before printing so that the original width (relative to portrait orientation) matches the roll paper width in borderless printing.

For instructions on borderless printing of photos, images, and other documents to match the roll paper width, refer to the following topics, as appropriate for your operating system.

- **Borderless Printing by Resizing Originals to Fit the Roll Width (Windows)** → P.96
- **Borderless Printing by Resizing Originals to Fit the Roll Width (Mac OS)** → P.98

Borderless Printing by Resizing Originals to Fit the Roll Width (Windows)

This topic describes how to enlarge originals before borderless printing to match the roll width, based on the following example.



- When borderless printing is used, the edge of the paper is cut during printing. Thus, ink density may be uneven at the edges. If you require higher image quality, select **No** from the **Automatic Cutting** list in the **Roll Paper Options** dialog box. In this case, the paper can be printed without borders on the left and right sides only. Once printed and cut, please cut the upper and lower bands with scissors.

- Document: Any type
- Page size: A4 (210.0×297.0 mm)/Letter (8.3 × 11.7 in)
- Paper: Roll
- Paper type: **Canon Glossy Photo Paper 170gsm**
- Roll paper width: 10 inches (254.0 mm)

1 In the application, create an original that takes up the entire space of the paper size.



- If you can specify the margin, as in Microsoft Word, set the margin at 0 mm. For instructions on specifying the margin, refer to the software documentation.

2 Choose **Print** in the application menu.

3 Select the printer in the dialog box, and then display the printer driver dialog box. (See "Accessing the Printer Driver Dialog Box from Applications .") → P.164

4 Make sure the **Main** sheet is displayed.

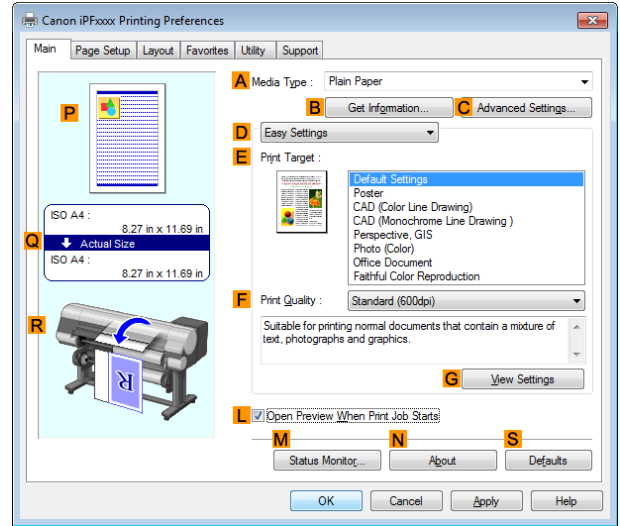

5 In the **A Media Type** list, select the type of paper that is loaded. In this case, click **Canon Glossy Photo Paper 170gsm**.

6 Select the print target in the **E Print Target** list.



- When you are using paper that takes longer for ink to adhere for borderless printing and the Cutter Unit touches printing surfaces that are not dry yet, it may damage the paper or the edge of the document that is cut, depending on frequency of use. In this kind of situation, change the ink drying time using the following procedure.

- Click **Advanced Settings** in **Media Type**.
- Select an ink drying time in the list for the **Between Pages** setting of **Drying Time**.

7 Click the **Page Setup** tab to display the **Page Setup** sheet.

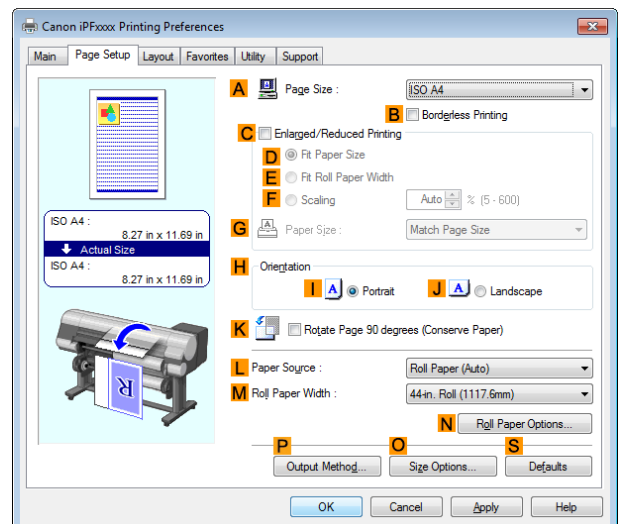

- 8** In the **A Page Size** list, click the size of the original as specified in the application. In this case, click **ISO A4**.
- 9** Select and click a roll paper in the **L Paper Source** list.
- 10** Select the **B Borderless Printing** check box to display the **Information** dialog box.

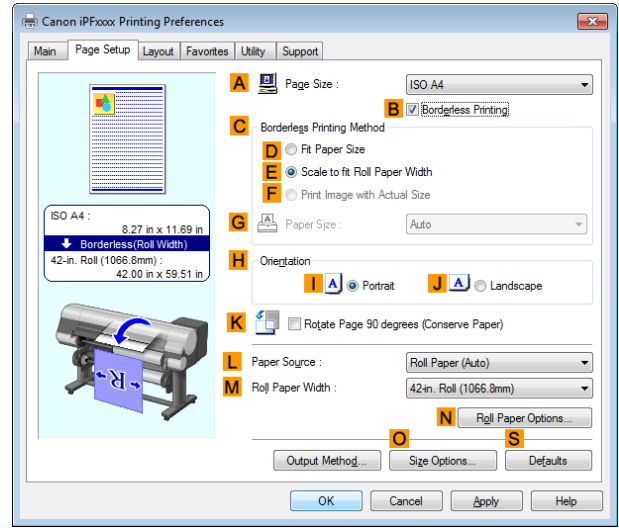

- 11** Select the width of the loaded roll in the **Roll Paper Width** list—in this case, click **10-in. Roll (254.0mm)**.
- 12** Click **OK** to close the **Information** dialog box.
- 13** In **C Borderless Printing Method**, make sure **E Scale to fit Roll Paper Width** is selected.
- 14** Confirm the print settings and print as desired.

 **Note** • For tips on confirming print settings, see "Confirming Print Settings ." →P.161

Borderless Printing by Resizing Originals to Fit the Roll Width (Mac OS)

This topic describes how to enlarge originals before borderless printing to match the roll width, based on the following example.

 **Important** • When borderless printing is used, the edge of the paper is cut during printing. Thus, ink density may be uneven at the edges. If you require higher image quality, select **No** from the **Automatic Cutting** list in the **Paper Detailed Settings** dialog box. In this case, the paper can be printed without borders on the left and right sides only. Once printed and cut, please cut the upper and lower bands with scissors.

- Document: Any type
- Page size: A4 (210.0×297.0 mm)/Letter (8.3 × 11.7 in)
- Paper: Roll
- Paper type: **Canon Glossy Photo Paper 170gsm**
- Roll paper width: 10 inches (254.0 mm)

1 Choose **Page Setup** from the application menu to display the **Page Attributes** dialog box.

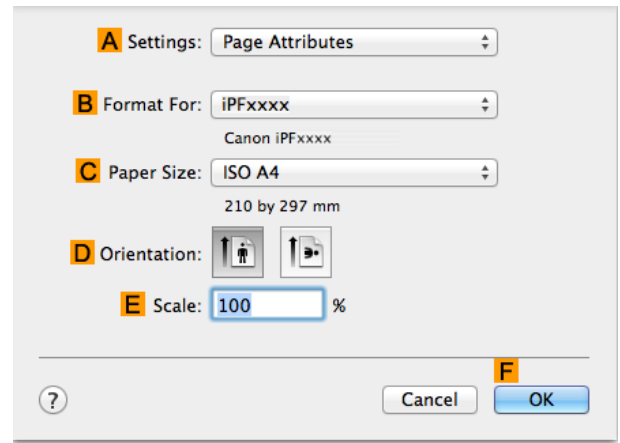

• **Page Setup** might not be displayed in the menu depending on the OS you are using and the application software. In this case, select **Print** from the menu in the application software, and configure the settings in the upper part of the printer driver screen that is displayed.

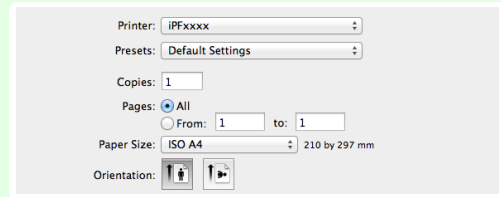

2 Select the printer in the **B Format for** list.

3 In **C Paper Size**, click the size of the original. In this case, click **ISO A4**.



• All sizes are available in borderless printing if you resize originals to fit the roll width.

4 Click **F OK** to close the dialog box.

5 In the application, create an original that takes up the entire space of the paper size.

6 Choose **Print** in the application menu.

7 Access the **Main** pane.

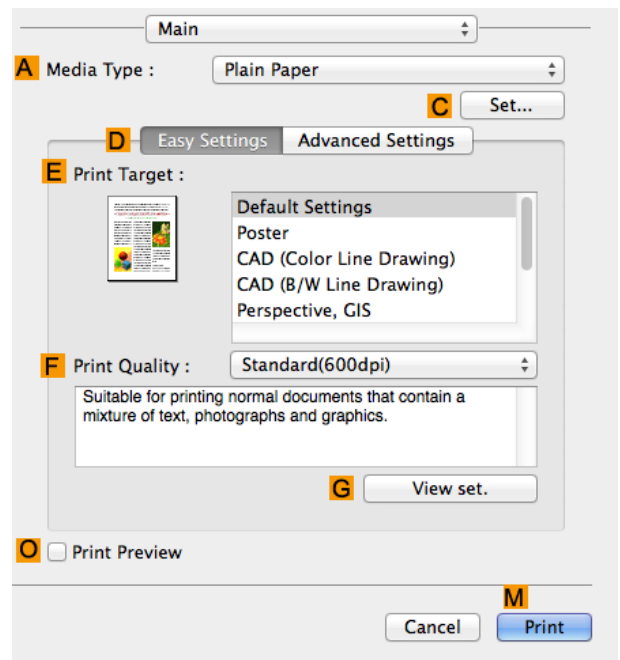

8 In the **A Media Type** list, select the type of paper that is loaded. In this case, click **Canon Glossy Photo Paper 170gsm**.

9 Select the print target in the **E Print Target** list.



• When you are using paper that takes longer for ink to adhere for borderless printing and the Cutter Unit touches printing surfaces that are not dry yet, it may damage the paper or the edge of the document that is cut, depending on frequency of use. In this kind of situation, change the ink drying time in **Between Pages** in the **Paper Detailed Settings** dialog box.

10 Access the **Page Setup** pane.

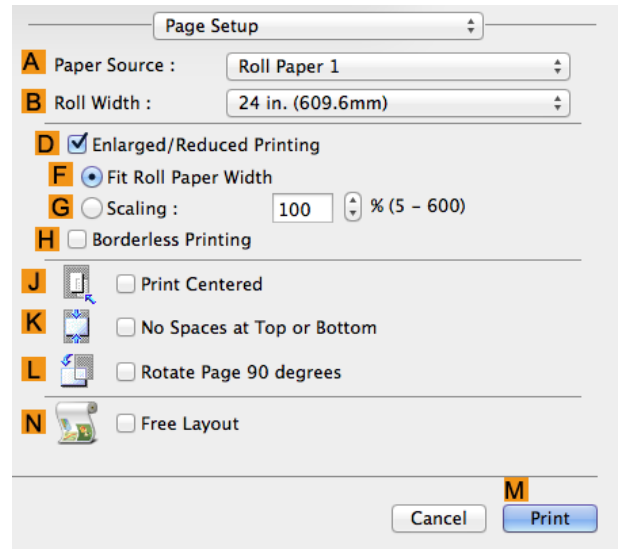

11 In the **A Paper Source** list, click **Roll Paper 1** or **Roll Paper 2**.

12 Select the paper width of the roll loaded in the printer for **B Roll Width**. In this case, **10 in. (254.0mm)** is selected.

13 Select the **D Enlarged/Reduced Printing** check box.

14 Select **F Fit Roll Paper Width**.

15 Select the **H Borderless Printing** check box.

16 Confirm the print settings, and then click **M Print** to start printing.



• For tips on confirming print settings, see "Confirming Print Settings ." [→P.270](#)

Note

Printing banners or at other non-standard sizes

- Printing Vertical or Horizontal Banners (Large-Format Printing) 101
 - Printing Vertical or Horizontal Banners (Large-Format Printing; Windows) 102
 - Printing Vertical or Horizontal Banners (Large-Format Printing; Mac OS) 105
- Printing on Non-Standard Paper Sizes 108
 - Printing on Non-Standard Paper Sizes (Windows) 108
 - Printing on Non-Standard Paper Sizes (Mac OS) 111

Printing Vertical or Horizontal Banners (Large-Format Printing)

On this printer, large-format printing of up to 18.0 m is available using rolls.

If you use Print Plug-In for Office or PosterArtist, you can easily print maximum 18.0 m vertical or horizontal banners. (Refer to "Print Plug-In for Office/features (Windows)" →P.230 and "Using PosterArtist to Compose Originals" →P.50 .)

However, you may not be able to print 18.0 m due to restrictions in the settable document size according to the application software.

Fit Roll Paper Width

To match the width of vertical and horizontal banners with the width of rolls, use the printer driver function for automatically enlarging/reducing and printing.

For example, if you automatically enlarge a document created with application software such as Microsoft Word, you can print the full width of the roll easily.

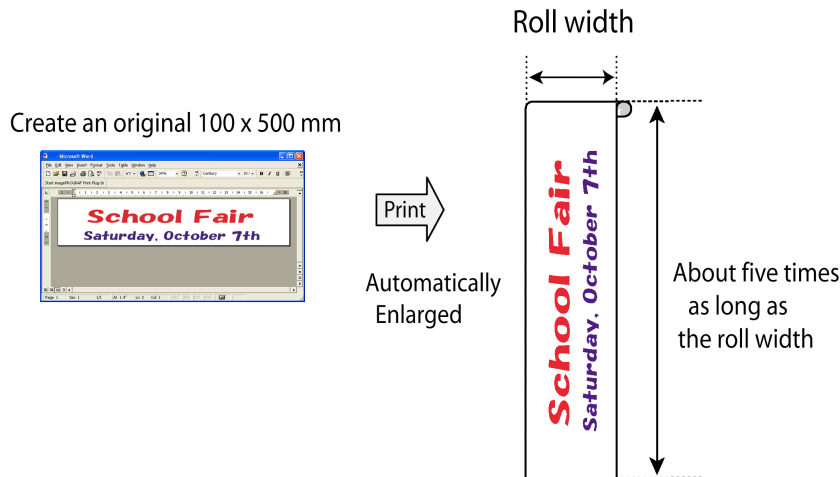

For instructions on printing vertical or horizontal banners, refer to the following topics, as appropriate for your operating system.

- **Printing Vertical or Horizontal Banners (Large-Format Printing; Windows)** →P.102
- **Printing Vertical or Horizontal Banners (Large-Format Printing; Mac OS)** →P.105



- Before printing, check how much of the roll paper is left. If you have activated automatic detection of the remaining roll paper, a warning message is displayed when there is not enough roll paper left.
- If not much ink is left, prepare replacement ink tanks.
- To print at a higher level of quality, in the printer driver, choose **High** or **Highest** in Print Quality, and choose **Unidirectional Printing** as the direction of printing.

Printing Vertical or Horizontal Banners (Large-Format Printing; Windows)

By automatic enlargement of a document created with an application software by the printer driver, you can print maximum 18.0 m vertical or horizontal banners.

However, you may not be able to print 18.0 m due to restrictions in the settable document size according to the application software.

This topic describes how to print a banner about five times as long as the roll width based on the following example.

- Document: A horizontal banner created in Microsoft Word
- Page size: Non-standard (100×500 mm [3.9×19.7 in])
- Paper: Roll
- Paper type: Plain Paper
- Roll paper width: 16 in (406.4 mm)

The print procedure is as follows.

1. Register a Custom Paper Size in the printer driver.
Call a non-standard paper size registered in the printer driver with Custom Paper Size. Once you register Custom Paper Size, you then can select it repeatedly from the paper size list. Custom Paper Size can be set up to 18.0 m.
2. In the application, create an original in the size you registered.
3. Print the banner, using the settings that correspond to banners.

Registering a Custom Paper Size

This example describes how to register a paper size that is horizontally elongated and suitable for banners in either horizontal or vertical format.

- 1 Display the printer driver dialog box. (See "Accessing the Printer Driver Dialog Box from the Operating System Menu .") → P.165
- 2 Click the **Page Setup** tab to display the **Page Setup** sheet.

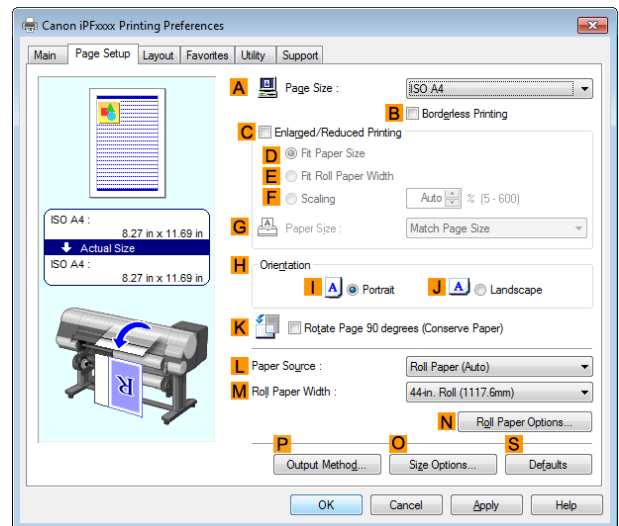

- 3 Select and click a roll paper in the **L Paper Source** list.
- 4 Click **O Size Options** to display the **Paper Size Options** dialog box.
- 5 Enter a desired paper name in **Custom Paper Size Name**. **My Horizontal Banner** is used in this example.
- 6 In **Units**, click **mm**.
- 7 Under **Paper Size**, enter **100** in **Width** and **500** in **Height**.
- 8 Click **Add** to add the paper size of **My Horizontal Banner**.

9 Click **OK** to close the **Paper Size Options** dialog box.

10 Close the printer driver dialog box.



Note

- Although you can even set **Custom Size** for the paper size, the maximum settable size is 3.2 m. The setting of **Custom Size** is disabled when you exit the application software. For more information, see "Printing on Non-Standard Paper Sizes ." → P.108

Creating the banner in the application

Follow the steps below to create the banner in Microsoft Word using the Custom Paper Size you registered.

1 Start Microsoft Word.

2 Choose **Page Setup** from the **File** menu to display the **Page Setup** dialog box.

3 Under **Paper Size**, click the Custom Paper Size you registered—**My Horizontal Banner** in this example.



Important

- If **My Horizontal Banner** is not listed, make sure this printer is selected as the printer to use.
- In applications such as Microsoft PowerPoint that do not enable you to choose registered paper sizes, use the custom paper size setting in **Custom** and specify 100×500 mm (3.9×19.7 in)

4 Set the printing orientation to horizontal.

5 Create the banner.

Printing the banner

Follow these steps to print the banner using the corresponding banner settings.

1 Choose **Print** in the Microsoft Word menu.

2 Select the printer in the dialog box, and then display the printer driver dialog box. (See "Accessing the Printer Driver Dialog Box from Applications .") → P.164

3 Make sure the **Main** sheet is displayed.

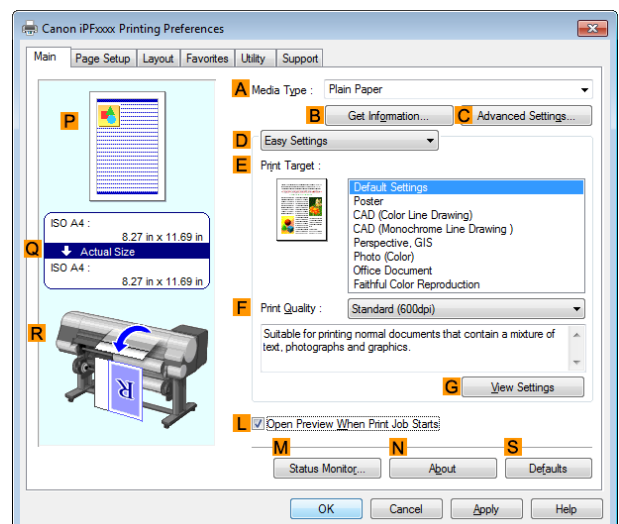

4 In the **A Media Type** list, select the type of paper that is loaded. In this case, click Plain Paper.

5 After confirming that **D Easy Settings** is selected, click **Poster** in the **E Print Target** list.

6 Click the **Page Setup** tab to display the **Page Setup** sheet.

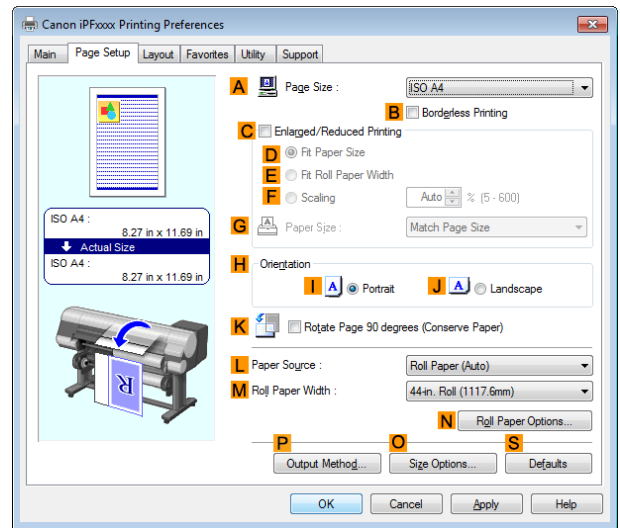

7 In the **A Page Size** list, click the size you registered, **My Horizontal Banner**.

8 Select the **C Enlarged/Reduced Printing** check box.

Note

- If the **C Enlarged/Reduced Printing** check box is not displayed on the **Page Setup** sheet, clear the **B Borderless Printing** check box.

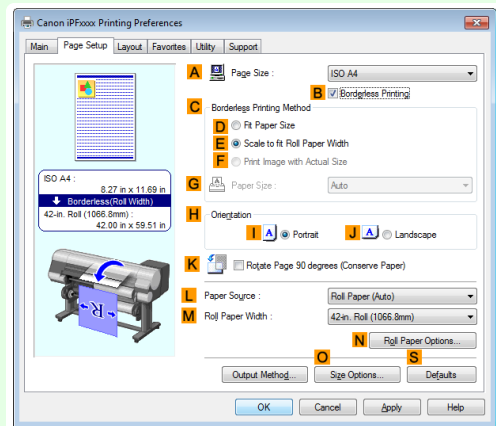

9 Select and click a roll paper in the **L Paper Source** list.

10 After you click **E Fit Roll Paper Width**, the **Information** dialog box is displayed.

11 Select the width of the loaded roll in the **Roll Paper Width** list. In this case, click **16-in. Roll (406.4mm)**, and then click **OK**.

12 Confirm the print settings and print as desired.

Note

- For tips on confirming print settings, see "Confirming Print Settings ." → P.161

If printing is unsuccessful, you may be able to print after completing the following setting.

- 1 On the **Layout** sheet, click **J Special Settings** to display the **Special Settings** dialog box.

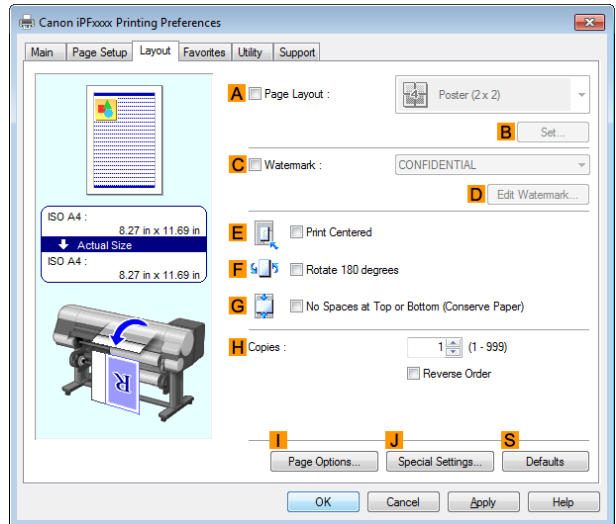

- 2 In the **FineZoom Settings** list, click **Yes**.

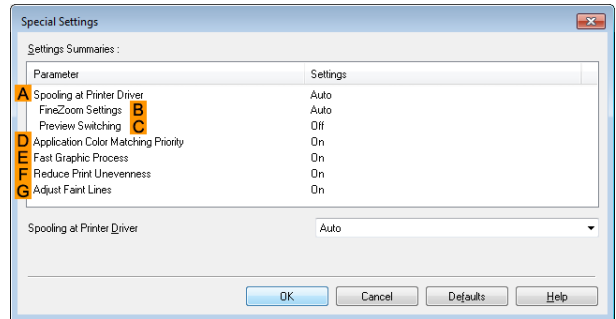

Printing Vertical or Horizontal Banners (Large-Format Printing; Mac OS)

By automatic enlargement of a document created with an application software by the printer driver, you can print maximum 18.0 m vertical or horizontal banners.

This topic describes how to print a banner about five times as long as the roll width based on the following example.

- Document: An original designed for a horizontal banner
- Page Size: Non-standard (100×500 mm [3.9×19.7 in])
- Paper: Roll
- Paper type: Plain Paper
- Roll paper width: 16 inches (406.4 mm)

The print procedure is as follows.

1. In the application, create an original in the format of a horizontal or vertical banner.
2. In **Page Setup**, register **Custom Paper Sizes**.
Once you register **Custom Paper Sizes**, you then can select it repeatedly from the paper size list.
Custom Paper Sizes can be set up to 18.0 m.
3. Print the banner, using the settings that correspond to banners.

 • The following instructions are for OS X v10.7. The method of setting up non-standard paper sizes varies depending on the version and settings of Mac OS X.

Register a Custom Paper Sizes

This example describes how to register and print using a page size that is horizontally elongated and suitable for banners in either horizontal or vertical format.

1 Create the document in the application.

2 Choose **Print** in the application menu.

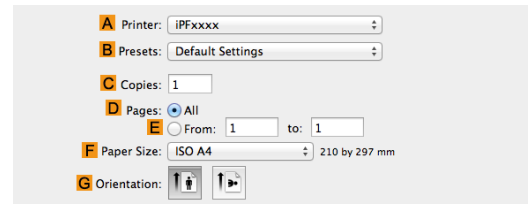

3 Select the printer in the **A Printer** list.

4 Click **Manage Custom Sizes** in the **F Paper Size** list to display the **Custom Paper Sizes** dialog box.

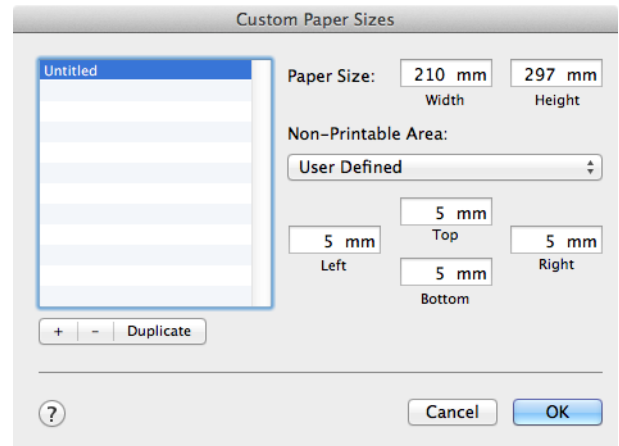

5 Double-click **Untitled** in the list at left, and then enter a name for the page size you want to register. Here, enter **100*500**.

If the **Untitled** size is not listed at left, click **+** below the list.

6 Under **Paper Size**, enter **100** in **Width** and **500** in **Height**. Here, measurements are entered in millimeters.

7 Specify the margins by entering **3** in **Non-Printable Area**. Here, too, measurements are entered in millimeters.

8 Click **OK** to close the **Custom Paper Sizes** dialog box.

9 In the **F Paper Size** list, click the size of the original. In this case, click **100*500**, the size you registered.

10 In **G Orientation**, click the icon of the document in landscape orientation.

11 If you configured the settings using the **Page Attributes** dialog box, click **OK** to close the dialog box.

Print the banner

Follow the steps below to print the banner using the corresponding banner settings.

1 Choose **Print** in the application menu.

2 Access the **Main** pane.

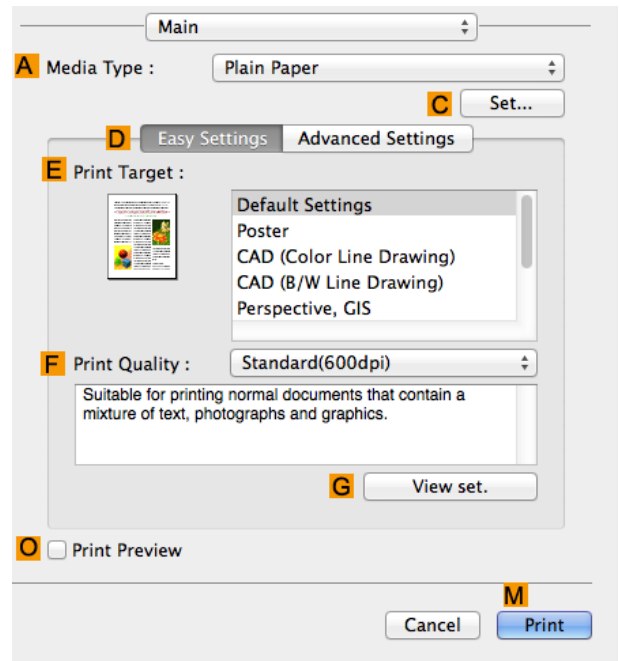

3 In the **A Media Type** list, select the type of paper that is loaded. In this case, click Plain Paper.

4 Make your selection in the **E Print Target** list.

5 Make your selection in the **F Print Quality** list.

6 Access the **Page Setup** pane.

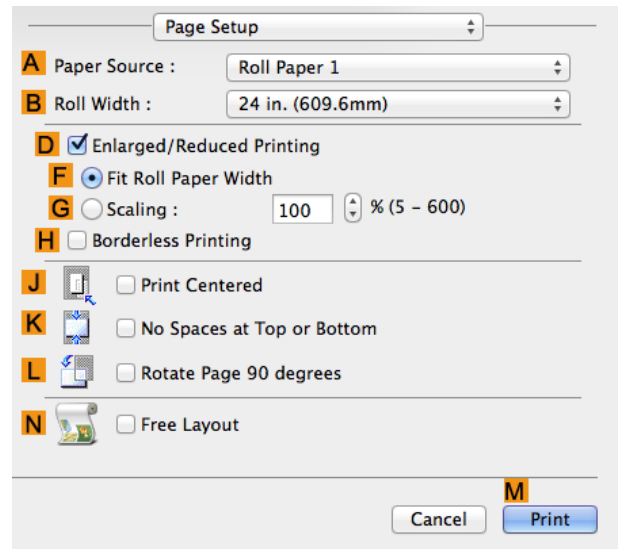

7 Select and click a roll paper in the **A Paper Source** list.

8 Select the paper width of the roll loaded in the printer for **B Roll Width**. In this case, **16 in. (406.4mm)** is selected.

9 Select the **D Enlarged/Reduced Printing** check box.

10 Click **F Fit Roll Paper Width**.

11 Confirm the print settings, and click **M Print** to start printing.



Note

- For tips on confirming print settings, see "Confirming Print Settings ." [→P.270](#)

Printing on Non-Standard Paper Sizes

For printing on non-standard size paper, first register the paper size in the printer driver. Once you register a paper size, you then can select it repeatedly from the paper size list. The paper size can be set up to 18.0 m.



Note

- In Windows, although you can even set **Custom Size** for the paper size, the maximum settable size is 3.2 m. The setting of **Custom Size** is disabled when you exit the application software.

For instructions on specifying non-standard paper sizes for printing, refer to the following topics, as appropriate for your operating system.

- [Printing on Non-Standard Paper Sizes \(Windows\)](#) [→P.108](#)
- [Printing on Non-Standard Paper Sizes \(Mac OS\)](#) [→P.111](#)

Printing on Non-Standard Paper Sizes (Windows)

For printing on non-standard size paper, first register the paper size in the printer driver. Call a non-standard paper size registered in the printer driver with Custom Paper Size. Once you register Custom Paper Size, you then can select it repeatedly from the paper size list. Custom Paper Size can be set up to 18.0 m.



Note

- Although you also can set **Custom Size** for the paper size temporarily, the maximum settable size is 3.2 m. Also, the setting of **Custom Size** is disabled when you exit the application software.

Registering and Printing With a Custom Paper Size

This topic describes how to register a non-standard paper size by the name of **430 mm Square** and print based on the following example.

- Document: Any Type
- Page Size: A square sheet (430 × 430 mm [16.9 × 16.9 in])
- Paper: Sheets
- Media Type: Any type
- Paper Size: A square sheet (430 × 430 mm [16.9 × 16.9 in])

1 Load the square paper (430 × 430 mm [16.9 × 16.9 in]) in the printer.

2 Choose **Print** in the application menu.

3 Select the printer in the dialog box, and then display the printer driver dialog box. (See "[Accessing the Printer Driver Dialog Box from Applications .](#)") [→P.164](#)

- 4** Make sure the **Main** sheet is displayed.

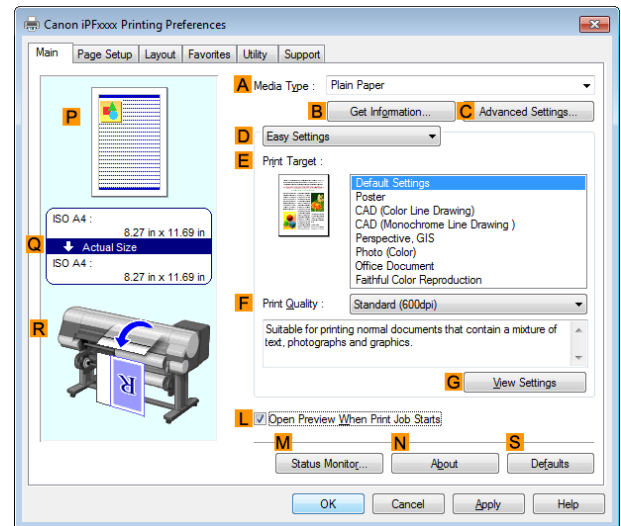

- 5** In the **A Media Type** list, select the type of paper that is loaded.

- 6** After confirming that **D Easy Settings** is selected, select from the **E Print Target** list.

- 7** Click the **Page Setup** tab to display the **Page Setup** sheet.

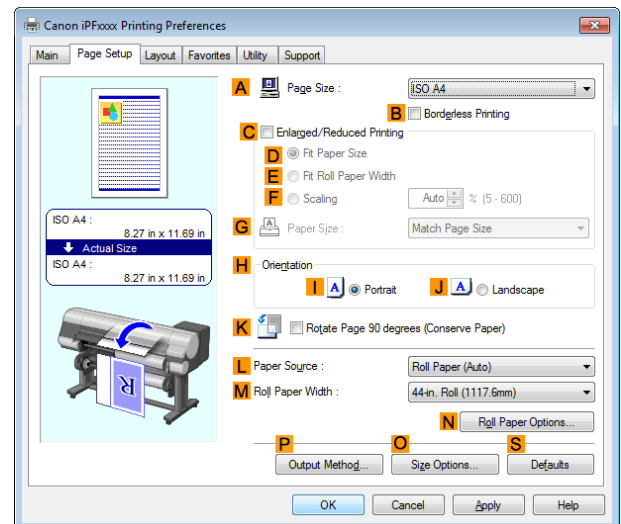

- 8** Click **O Size Options** to display the **Paper Size Options** dialog box.

- 9** Enter a desired paper name in **Custom Paper Size Name**. **430 mm Square** is used in this example.

- 10** Select **mm** in **Units**.

- 11** Enter **430** (16.9 in) in both **Width** and **Height**.



- If you select the **Fix the Ratio of the Width to Height** check box, after you enter a value in either **Width** or **Height**, the other value will be automatically applied based on the original aspect ratio.

- 12** Click **Add** to register **430 mm Square**.

- 13** Click **OK** to close the **Paper Size Options** dialog box.

- 14** Click **Cut Sheet** in the **L Paper Source** list.

- 15** In the **A Page Size** list, click the size you added, **430 mm Square**.

16 Confirm the print settings and print as desired.



• For tips on confirming print settings, see "Confirming Print Settings ." →P.161

Note

Printing by using Custom Size

This section describes how to print using **Custom Size** based on the following example.

- Document: Any Type
- Page size: Square of non-standard dimensions (430×430 mm [16.9×16.9 in])
- Paper: Sheets
- Paper type: Any type
- Paper Size: A square sheet (430 × 430 mm [16.9 × 16.9 in])

1 Load the square paper (430 × 430 mm [16.9 × 16.9 in]) in the printer.

2 Choose **Print** in the application menu.

3 Select the printer in the dialog box, and then display the printer driver dialog box. (See "Accessing the Printer Driver Dialog Box from Applications .") →P.164

4 Make sure the **Main** sheet is displayed.

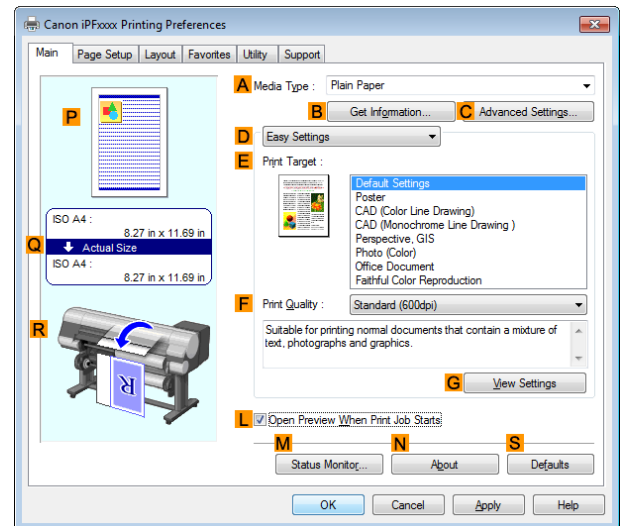

5 In the **A Media Type** list, select the type of paper that is loaded.

6 After confirming that **D Easy Settings** is selected, select from the **E Print Target** list.

- Click the **Page Setup** tab to display the **Page Setup** sheet.

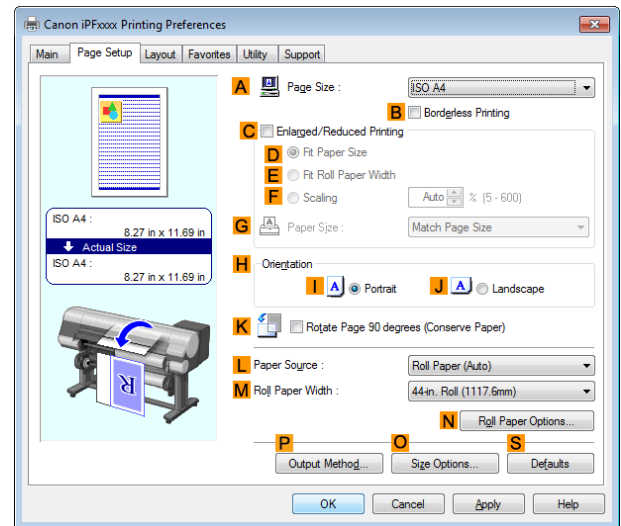

- Click **Cut Sheet** in the **L Paper Source** list.
- Click **Custom Size** in the **A Page Size** list to display the **Custom Size Settings** dialog box.
- Confirm that **mm** is selected in **Units**.
- Enter **430** (16.9 in) in both **Width** and **Height**.
- Click **OK** to close the **Custom Size Settings** dialog box.
- Confirm the print settings and print as desired.



Note

- For tips on confirming print settings, see "Confirming Print Settings ." →P.161

Printing on Non-Standard Paper Sizes (Mac OS)

For printing on non-standard size paper, first register the paper size in the printer driver.

Call a non-standard paper size registered in the printer driver with **Custom Paper Sizes** .

Once you register **Custom Paper Sizes**, you then can select it repeatedly from the paper size list.

Custom Paper Sizes can be set up to 18.0 m.

This topic describes how to register a non-standard paper size by the name of **430*430** and print based on the following example.

- Document: Any Type
- Page Size: A square sheet (430 × 430 mm [16.9 × 16.9 in])
- Paper: Sheets
- Media Type: Any type
- Paper Size: A square sheet (430 × 430 mm [16.9 × 16.9 in])



Note

- The following instructions are for OS X v10.7. The method of setting up non-standard paper sizes varies depending on the version and settings of Mac OS X.

- Create the document in the application.
- Load the square paper (430 × 430 mm [16.9 × 16.9 in]) in the printer.

3 Choose **Print** in the application menu.

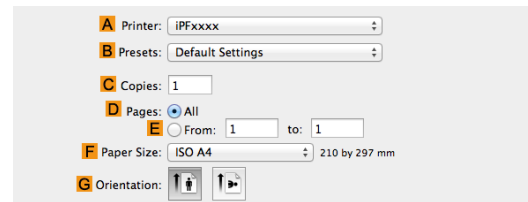

4 Select the printer in the **A Printer** list.

5 Click **Manage Custom Sizes** in the **F Paper Size** list to display the **Custom Paper Sizes** dialog box.

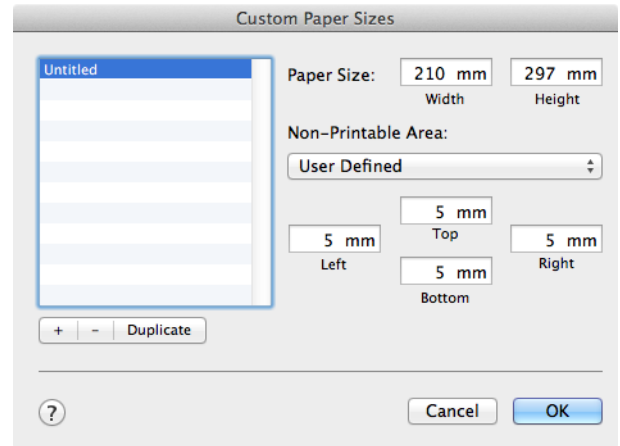

6 In **Paper Size**, enter the height and width of the original. Here, enter **430 mm** in **Height** and **Width**.

7 In **Non-Printable Area**, enter **5** for the top and side margins and **23** for the bottom margin. Here, measurements are entered in millimeters.

8 Double-click **Untitled** in the list at left in the **Custom Paper Sizes** dialog box and enter the paper name—in this case, **430*430**.

9 Click **OK** to close the **Custom Paper Sizes** dialog box.

10 In the **F Paper Size** list, click the size of the original. In this case, click **430*430**, the size you registered.

11 If you configured the settings using the **Page Attributes** dialog box, click **OK** to close the dialog box, and then select **Print** from the application software menu.

12 Access the **Main** pane.

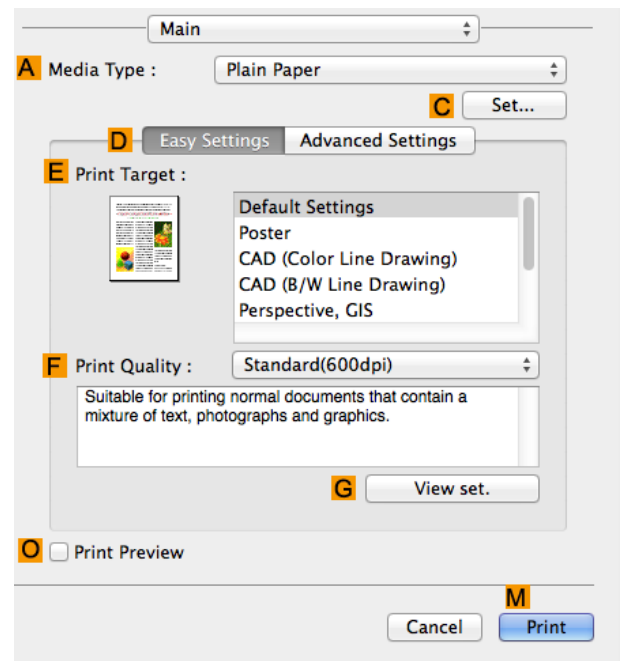

13 In the **A Media Type** list, select the type of paper that is loaded.

14 After confirming that **D Easy Settings** is selected, select from the **E Print Target** list.

15 Make your selection in the **F Print Quality** list.

16 Access the **Page Setup** pane.

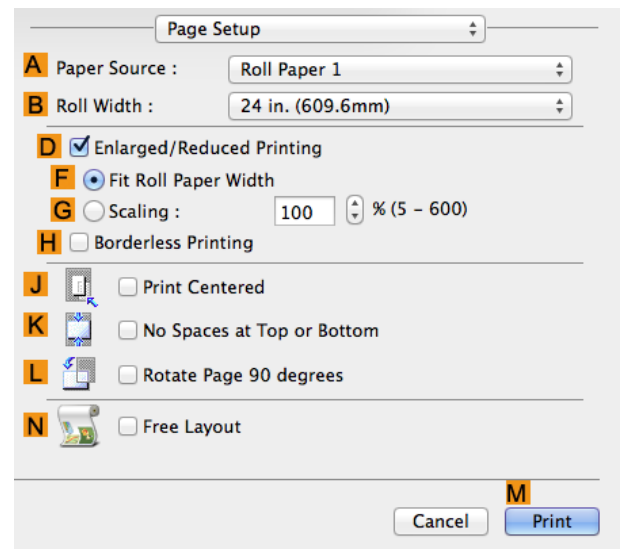

17 Click **Cut Sheet** in the **A Paper Source** list.

18 Confirm the print settings, and then click **M Print** to start printing.



Note

- For tips on confirming print settings, see "Confirming Print Settings ." →P.270

Tiling and multiple pages per sheet

Printing Multiple Originals Next to Each Other	114
Printing Multiple Originals Next to Each Other (Windows)	115
Printing Multiple Originals Next to Each Other (Mac OS)	117
Printing Multiple Pages Continuously	118
Printing Multiple Pages Continuously (Windows)	118
Printing Multiple Pages Continuously (Mac OS)	120
Printing Multiple Pages Per Sheet	121
Printing Multiple Pages Per Sheet (Windows)	122
Printing Multiple Pages Per Sheet (Mac OS)	124
Printing Posters in Sections	126
Printing Large Posters (Windows)	126

Printing Multiple Originals Next to Each Other

By arranging originals from word-processing or spreadsheet programs or web browser screen shots next to each other on single sheets, you can create highly expressive presentation materials, easy-to-understand meeting materials, and a variety of other printed documents.

- **Free Layout (Windows)**

Besides combining multiple pages in a single-page layout, you can combine originals from multiple files—even multiple source applications—in a single-page layout.

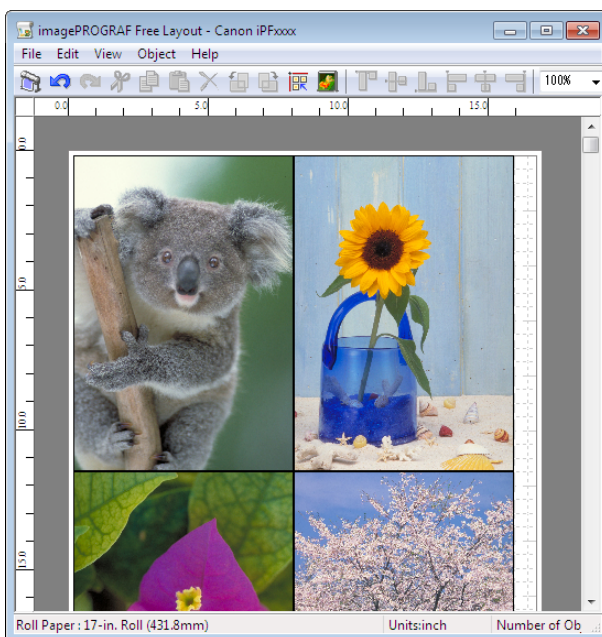

- **Free Layout (Mac OS)**

Besides combining multiple pages in a single-page layout, you can combine originals from multiple files—even multiple source applications—in a single-page layout.

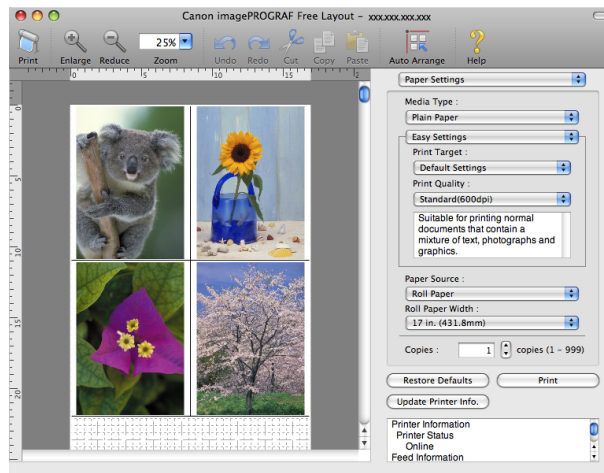

For instructions on arranging originals from multiple applications, refer to the following topics.

- **Printing Multiple Originals Next to Each Other (Windows)** → P.115
- **Printing Multiple Originals Next to Each Other (Mac OS)** → P.117

Printing Multiple Originals Next to Each Other (Windows)

This topic describes how to arrange multiple originals using the **Free Layout** function.

- 1 Choose **Print** in the application menu.
- 2 Select the printer in the dialog box, and then display the printer driver dialog box. (See "**Accessing the Printer Driver Dialog Box from Applications .**") → P.164
- 3 Make sure the **Main** sheet is displayed.

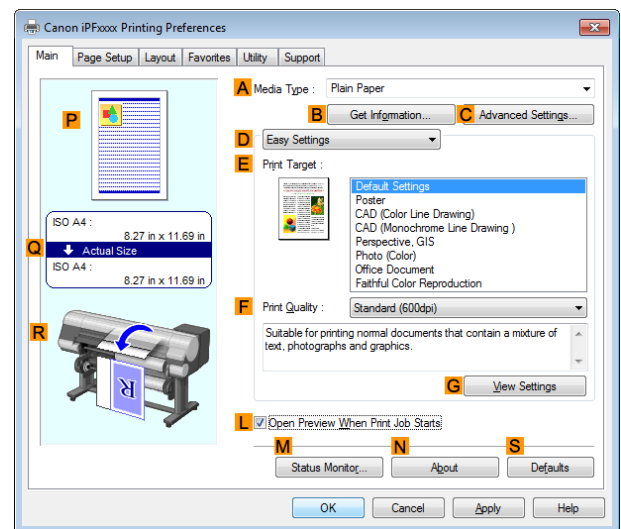

4 Click the **Layout** tab to display the **Layout** sheet.

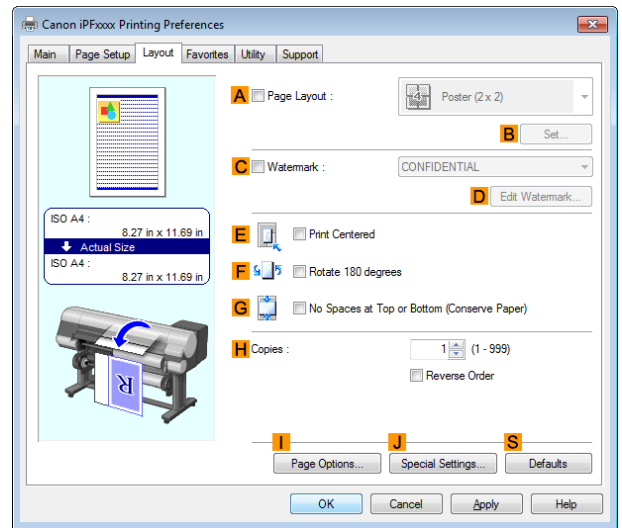

5 Select the **Page Layout** check box.

6 Click **Free Layout** in the **Page Layout** list.

7 When you attempt to print, the **imagePROGRAF Free Layout** window is displayed. (At this point, the document will not be printed yet.)

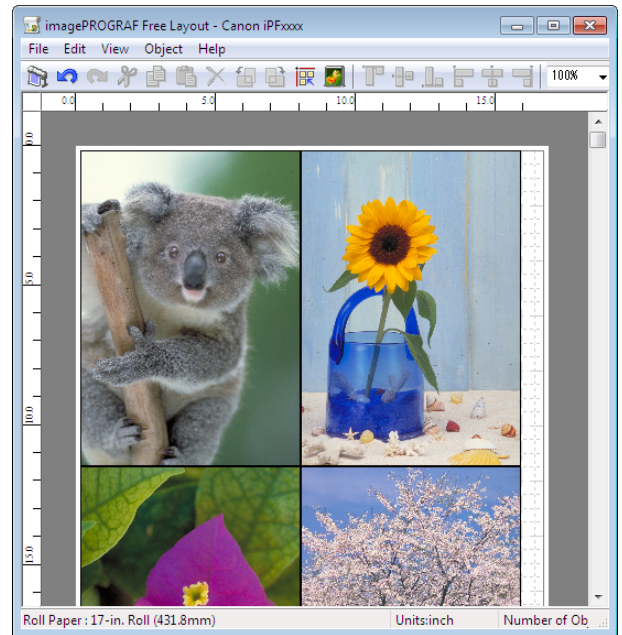

8 Edit and rearrange the image in the **imagePROGRAF Free Layout** window as desired.



- Without closing the **imagePROGRAF Free Layout** window, repeat steps 1–7 to arrange originals from multiple applications on the same page.
- For instructions on editing and rearranging images, refer to the **imagePROGRAF Free Layout** help topic.

9 Print from the **imagePROGRAF Free Layout** menu.



- For details on **imagePROGRAF Free Layout** functions, see "Free Layout." →P.199

Printing Multiple Originals Next to Each Other (Mac OS)

This topic describes how to use the **Free Layout** function to arrange multiple originals next to each other before printing.

1 Choose **Print** in the application menu.

2 Access the **Page Setup** pane.

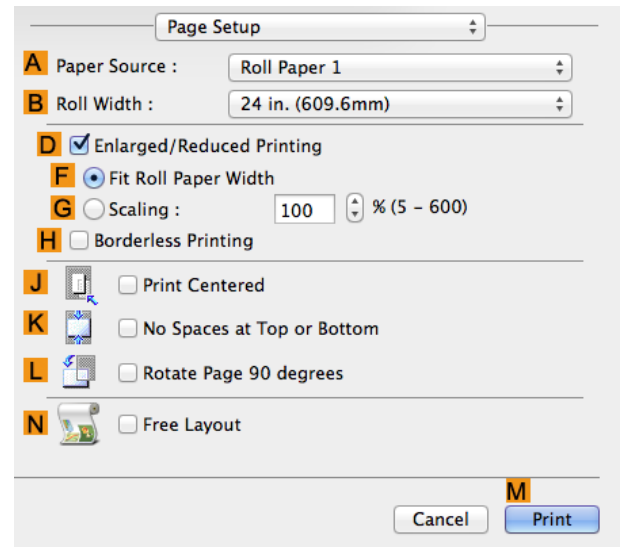

3 Select the **N Free Layout** check box.

4 Click **M Print**.

5 The **Canon imagePROGRAF Free Layout** window is displayed.

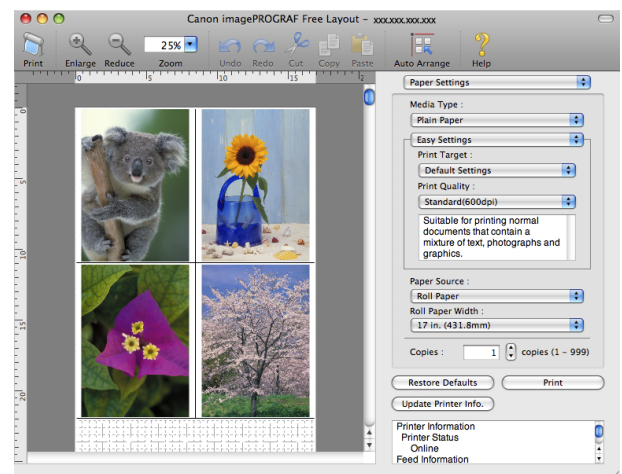

6 Edit and rearrange the image in the **Canon imagePROGRAF Free Layout** window as desired.



Note

- Without closing the **Canon imagePROGRAF Free Layout** window, repeat steps 1 to 4 to arrange originals from multiple applications on the same page.
- For instructions on editing and rearranging images, refer to the **Canon imagePROGRAF Free Layout** help topic.

7 Print from the **Canon imagePROGRAF Free Layout** menu.



Note

- For details on **Canon imagePROGRAF Free Layout** functions, see "Free Layout." →P.307

Printing Multiple Pages Continuously

You can print multiple pages as a single continuous image, without margins between pages.

- **Banner Printing**

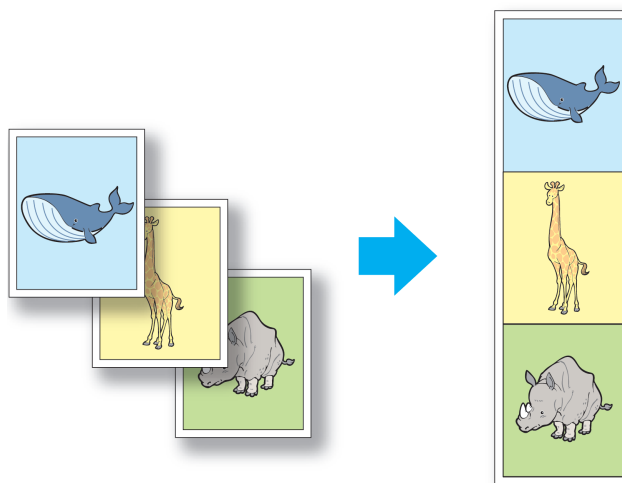

- This feature is only available with rolls. It cannot be used when printing on sheets.
- Important** • When using Banner Printing, some of the settings are disabled, including Borderless Printing, Enlarge/Reduce Printing, and Layout.

For instructions on printing multiple pages continuously, refer to the following topics, as appropriate for your operating system.

- **Printing Multiple Pages Continuously (Windows)** →P.118
- **Printing Multiple Pages Continuously (Mac OS)** →P.120

Printing Multiple Pages Continuously (Windows)

This topic describes how to print multiple pages as a single continuous image, without margins between pages.



- This feature is only available with rolls. It cannot be used when printing on sheets.
- Important** • When using Banner Printing, some of the settings are disabled, including Borderless Printing, Enlarge/Reduce Printing, and Layout.

- 1** Choose **Print** in the application menu.
- 2** Select the printer in the dialog box, and then display the printer driver dialog box. (See "**Accessing the Printer Driver Dialog Box from Applications .**") →P.164

3 Make sure the **Main** sheet is displayed.

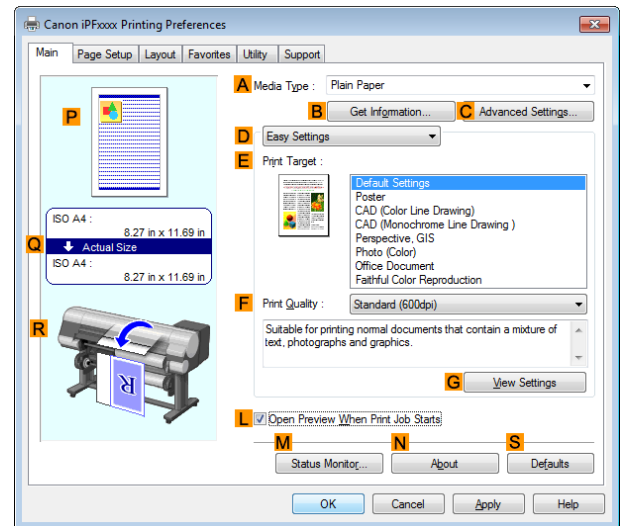

4 In the **A Media Type** list, click the type of paper that is loaded.

5 Click the **Page Setup** tab to display the **Page Setup** sheet.

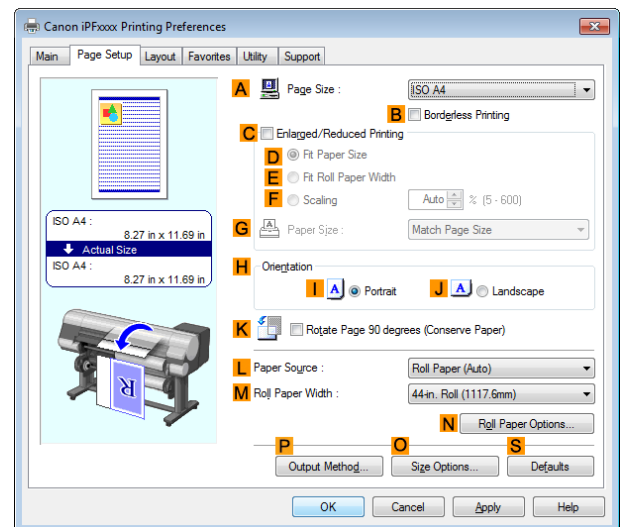

6 Select and click a roll paper in the **L Paper Source** list.

7 Click **N Roll Paper Options** to display the **Roll Paper Options** dialog box.

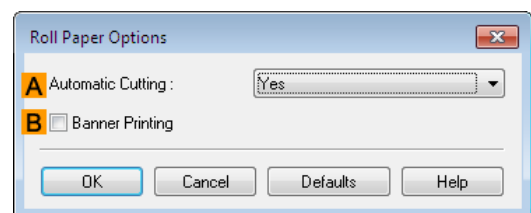

8 Select the **B Banner Printing** check box.

9 Click **OK**.

10 Confirm the print settings and print as desired.



Note

- For tips on confirming print settings, see "Confirming Print Settings ." →P.161

Printing Multiple Pages Continuously (Mac OS)

This topic describes how to print multiple pages as a single continuous image, without margins between pages.



Important

- This feature is only available with rolls. It cannot be used when printing on sheets.
- When using Banner Printing, some of the settings are disabled, including Borderless Printing, Enlarge/Reduce Printing, and Layout.

- 1 Choose **Page Setup** from the application menu to display the **Page Attributes** dialog box.

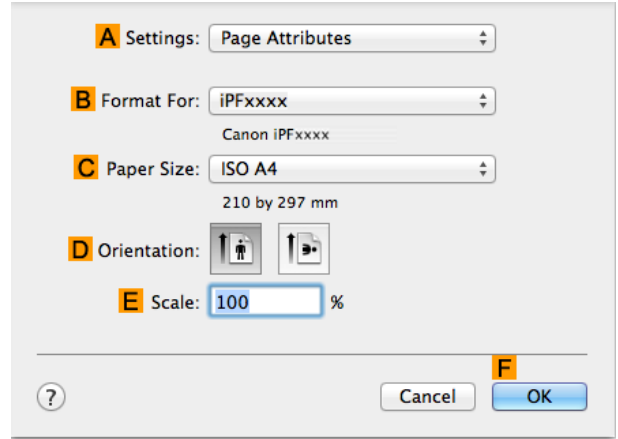

Note

- **Page Setup** might not be displayed in the menu depending on the OS you are using and the application software. In this case, select **Print** from the menu in the application software, and configure the settings in the upper part of the printer driver screen that is displayed.

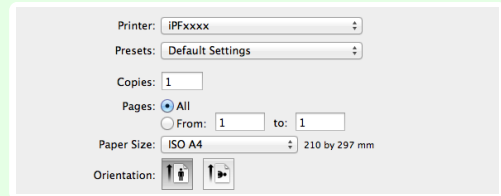

- 2 Select the printer in the **B Format for** list.
- 3 Choose the original size in the **C Paper Size** list.
- 4 Click **F OK** to close the dialog box.
- 5 Choose **Print** in the application menu.
- 6 Access the **Main** pane.

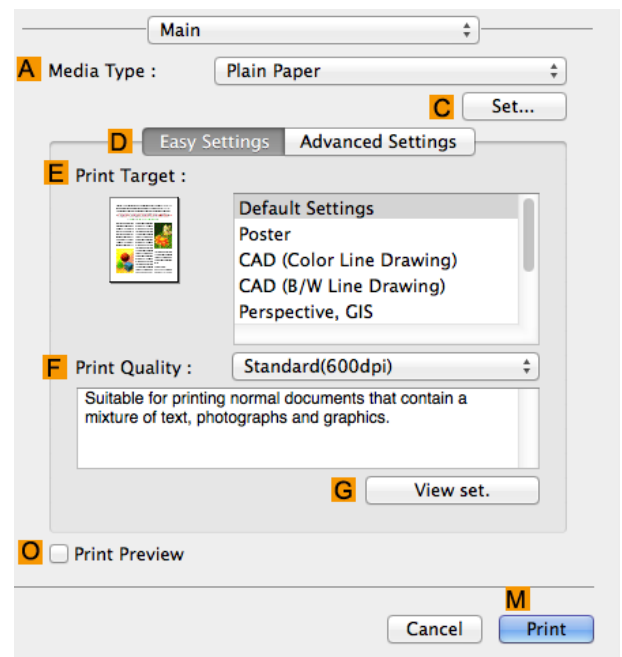

- 7** In the **A Media Type** list, click the type of paper that is loaded.
- 8** Make your selection in the **E Print Target** list.
- 9** Make your selection in the **F Print Quality** list.
- 10** Access the **Page Setup** pane.

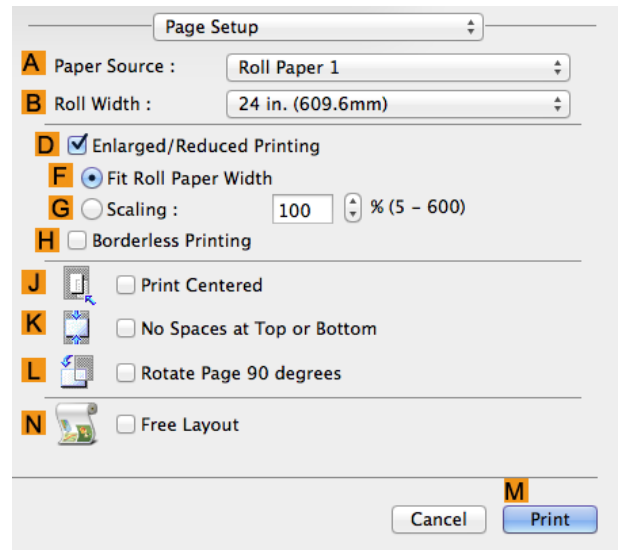

- 11** In the **A Paper Source** list, click **Roll Paper 1 (Banner)** or **Roll Paper 2 (Banner)**.
- 12** Confirm the print settings, and then click **M Print** to start printing.

 • For tips on confirming print settings, see "Confirming Print Settings ." →P270

Printing Multiple Pages Per Sheet

To conserve paper, you can print several pages of the original on a single sheet by reducing the original and dividing the sheet into areas for each page.

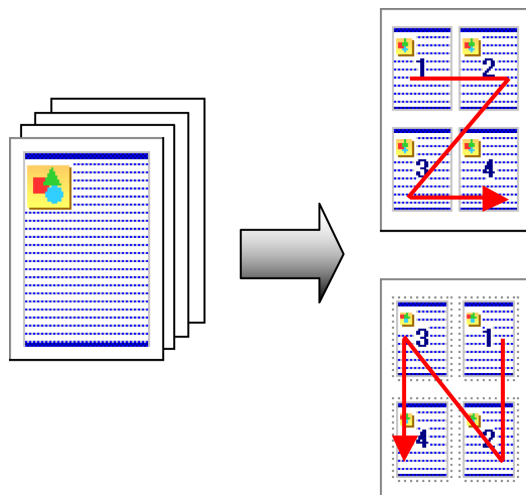

• Page Layout

Specify a number of pages of the original to print on a single sheet, in a layout of multiple pages per sheet.



Important

- This function cannot be combined with the following options.
 - Borderless Printing
 - Scaling Originals (Windows)
 - Banner Printing (Windows)
- When printing using this function, the **Print Centered** setting is disabled.



Note

- You can print up to 16 pages of the original on a single sheet.
- You can also change the page layout order and print page boundary lines, as desired.

For instructions on printing multiple pages per sheet, refer to the following topics, as appropriate for your operating system.

- **Printing Multiple Pages Per Sheet (Windows)** →P.122
- **Printing Multiple Pages Per Sheet (Mac OS)** →P.124

Printing Multiple Pages Per Sheet (Windows)

This topic describes how to print four pages of originals together on a single sheet based on the following example.

- Document: Any Type
- Page size: A3 (297.0×420.0 mm [11.7×16.5 in])
- Paper: Roll
- Paper type: Plain Paper
- Roll paper width: A2/A3 roll (420.0 mm [16.5 in])

1 Choose **Print** in the application menu.

2 Select the printer in the dialog box, and then open the printer driver dialog box. (See "Accessing the Printer Driver Dialog Box from Applications.") →P.164

3 Make sure the **Main** sheet is displayed.

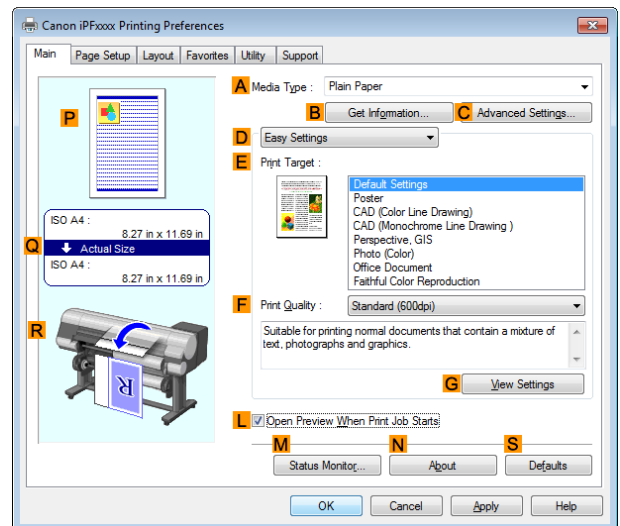

4 In the **A Media Type** list, select the type of paper that is loaded. In this case, click Plain Paper.

5 Make your selection in the **E Print Target** list.

6 Make your selection in the **F Print Quality** list.

- 7** Click the **Page Setup** tab to display the **Page Setup** sheet.

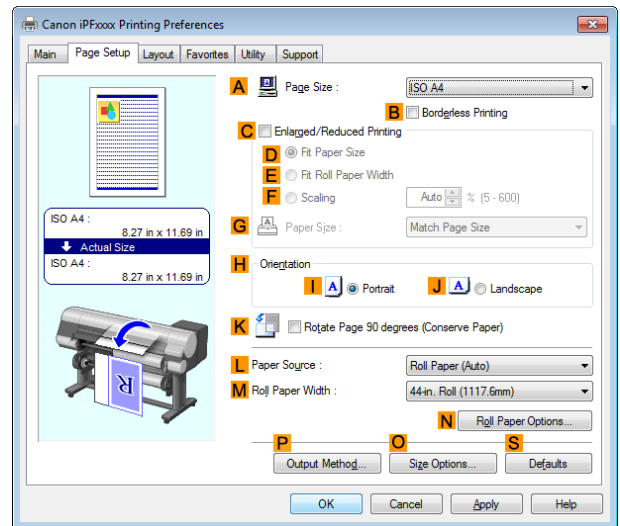

- 8** In **A Page Size**, click the size of the original as specified in the application software. In this case, click **ISO A3**.

- 9** Select and click a roll paper in the **L Paper Source** list.

- 10** Select the width of the loaded roll in the **M Roll Paper Width** list—in this case, **ISO A2/A3 Roll (420.0mm)**.

- 11** Click the **Layout** tab to display the **Layout** sheet.

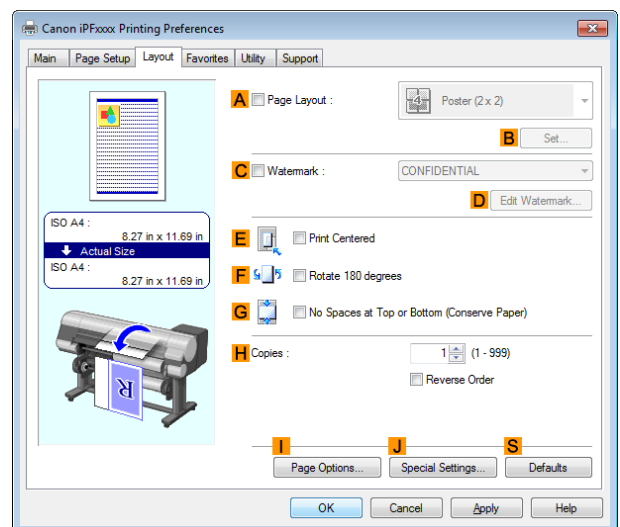

- 12** Select the **A Page Layout** check box.

- 13** Click **4 Pages/Sheet** in the **A Page Layout** list.



Note

- You can select the layout order for placing four pages on a sheet and a frame border in the **Page Layout Printing** dialog box by clicking **B Set**. If you select a pattern to print borders, the size of the images are reduced about 5% to create space for the printed border. If **None** is selected, then the images are not reduced for printing.

- 14** Confirm the print settings and print as desired.



Note

- For tips on confirming print settings, see "Confirming Print Settings ." →P.161

Printing Multiple Pages Per Sheet (Mac OS)

This topic describes how to print four pages of an original on a single sheet, based on the following example.

- Document: Any Type
- Page size: A3 (297.0 × 420.0 mm [11.7 × 16.5 in])
- Paper: Roll paper
- Paper type: Plain Paper
- Roll paper width: A2/A3 roll (420.0 mm [16.5 in])

1 Choose **Page Setup** from the application menu to display the **Page Attributes** dialog box.

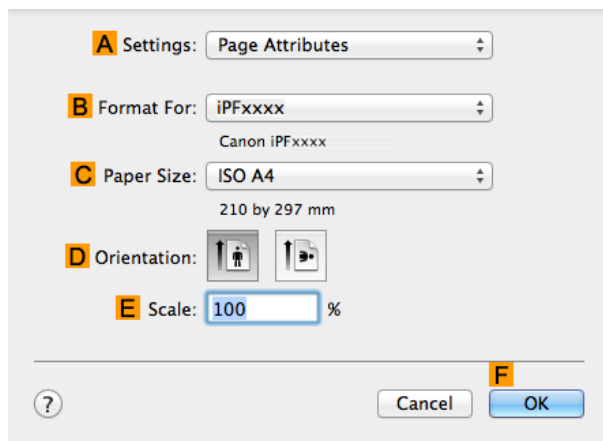

- **Page Setup** might not be displayed in the menu depending on the OS you are using and the application software. In this case, select **Print** from the menu in the application software, and configure the settings in the upper part of the printer driver screen that is displayed.

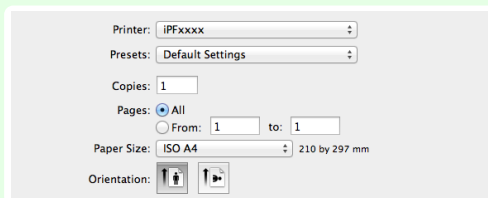

2 Select the printer in the **B Format for** list.

3 In the **C Paper Size** list, click the size of the original. In this case, click **ISO A3**.

4 Click **F OK** to close the dialog box.

5 Choose **Print** in the application menu.

6 Access the **Layout** pane.

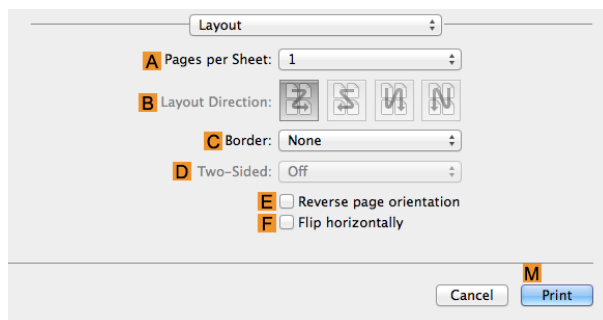

7 Click **4** in the **A Pages per Sheet** list.



- You can choose the layout order and specify a boundary line for the four pages in **B Layout Direction** and **C Border**.

8 Access the **Main** pane.

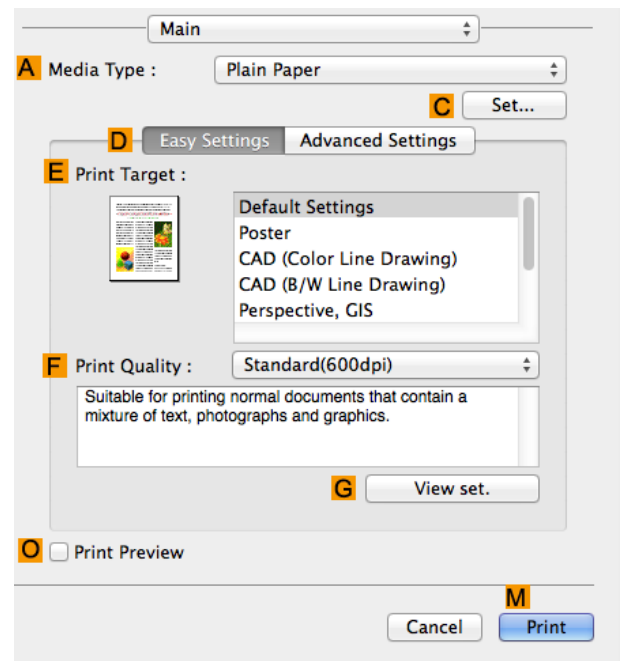

9 In the **A Media Type** list, select the type of paper that is loaded. In this case, click Plain Paper.

10 Make your selection in the **E Print Target** list.

11 Make your selection in the **F Print Quality** list.

12 Access the **Page Setup** pane.

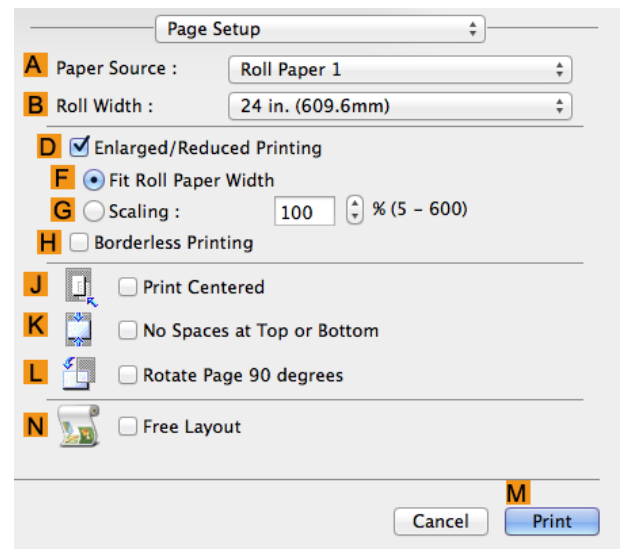

13 Select and click a roll paper in the **A Paper Source** list.

14 Select the paper width of the roll loaded in the printer for **B Roll Width**. In this case, **ISO A2/A3 (420.0mm)** is selected.

15 Confirm the print settings, and then click **M Print** to start printing.



Note

- For tips on confirming print settings, see "Confirming Print Settings." →P.270

Printing Posters in Sections

You can enlarge an original to print it in sections on several sheets. By assembling the printed sheets, you can create a poster larger than the maximum supported paper size of the printer.

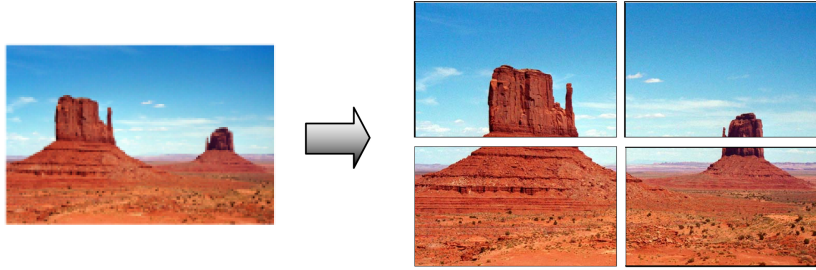

• Page Layout

Choose poster printing.



• When printing using this function, the **Print Centered**, **Watermark**, **No Spaces at Top or Bottom (Conserve Paper)**, and **Page Options** settings are disabled.

For instructions on printing large posters, refer to the following topics, as appropriate for your operating system.

- **Printing Large Posters (Windows)** →P.126



Note

- This method of poster printing is supported in Windows.

Printing Large Posters (Windows)

You can enlarge an original to print it in sections on several sheets. By assembling the printed sheets, you can create a poster larger than the maximum supported paper size of the printer. This topic describes how to enlarge an A2 original for printing it in sections on four sheets, based on the following example.

- Document: Poster
- Page size: A2 (420.0×594.0 mm [16.5 × 23.4 in])
- Paper: Sheets
- Paper Size: A2 (420.0 × 594.0 mm [16.5 × 23.4 in])

1 Choose **Print** in the application menu.

2 Select the printer in the dialog box, and then display the printer driver dialog box. (See "**Accessing the Printer Driver Dialog Box from Applications .**") →P.164

3 Make sure the **Main** sheet is displayed.

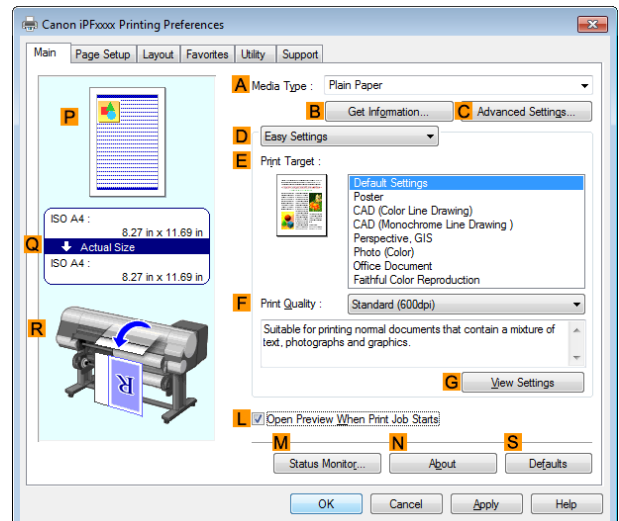

4 In the **A Media Type** list, select the type of paper that is loaded.

5 Click **Poster** in the **E Print Target** list.

6 Click the **Page Setup** tab to display the **Page Setup** sheet.

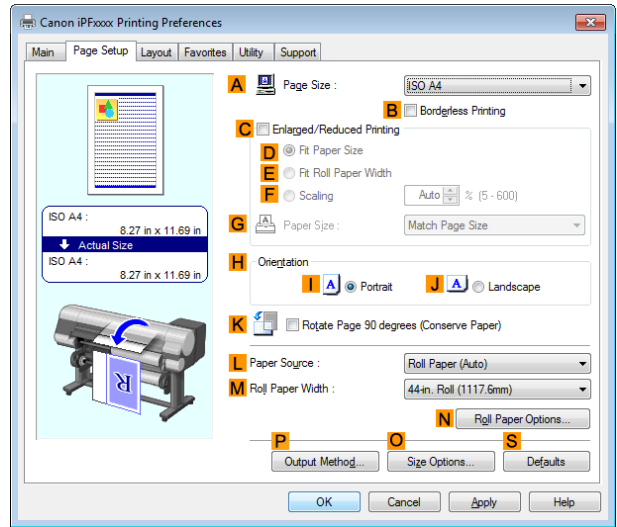

7 In **A Page Size**, click the size of the original as specified in the application. In this case, click **ISO A2**.

8 Click **Cut Sheet** in the **L Paper Source** list.

9 Click the **Layout** tab to display the **Layout** sheet.

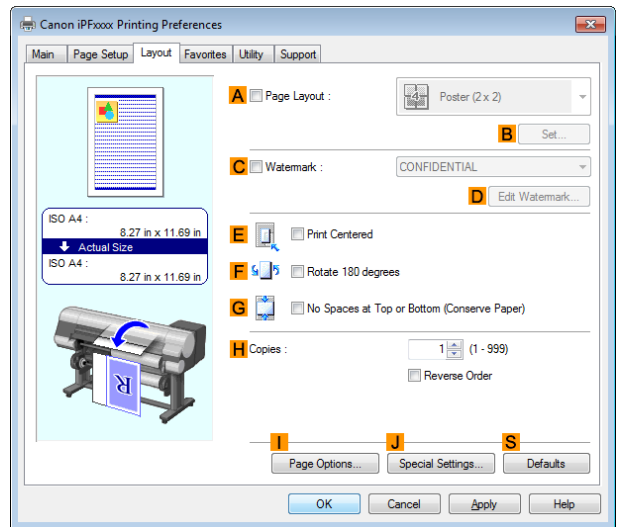

10 Select the **A Page Layout** check box.

11 Click **Poster (2 x 2)** in the **A Page Layout** list.



Note

- Follow the steps below to print only a portion of the poster as divided for printing.
- Click **B Set** under **A Page Layout** to display the **Pages to Print** dialog box.
- On the **Pages to Print** dialog box, clear the check boxes of the portion you do not want to print.
- Click **OK** to close the **Pages to Print** dialog box.

12 Confirm the print settings and print as desired.



Note

- For tips on confirming print settings, see "Confirming Print Settings ." →P.161

Centering originals

Printing Originals Centered on Rolls	128
Printing Originals Centered on Rolls (Windows)	128
Printing Originals Centered on Rolls (Mac OS)	130
Printing Originals Centered on Sheets	132
Printing Originals Centered on Sheets (Windows)	132
Printing Originals Centered on Sheets (Mac OS)	134

Printing Originals Centered on Rolls

You can print originals centered on a page—for example, if the paper is larger than the original, or if you are reducing the original.

- **Print Centered**

If you use originals smaller than the roll paper width, you can center them relative to the width when printing.

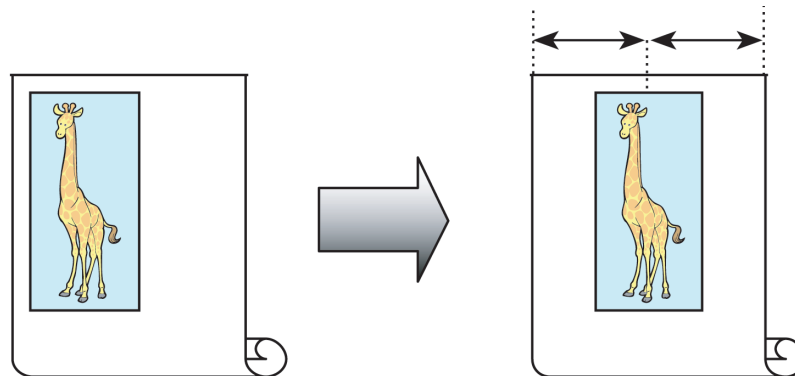

For instructions on centering originals when printing on roll paper, refer to the following topics, as appropriate for your operating system.

- [Printing Originals Centered on Rolls \(Windows\)](#) →P.128
- [Printing Originals Centered on Rolls \(Mac OS\)](#) →P.130

Printing Originals Centered on Rolls (Windows)

This topic describes how to center originals before printing on rolls based on the following example.

- Document: Any type
- Page size: A4 (210.0×297.0 mm)/Letter (8.3 × 11.7 in)
- Paper: Roll
- Paper type: Plain Paper
- Roll width: A3/A4 roll (297.0 mm [11.7 in])

1 Choose **Print** in the application menu.

2 Select the printer in the dialog box, and then display the printer driver dialog box. (See "[Accessing the Printer Driver Dialog Box from Applications](#) .") →P.164

- 3** Make sure the **Main** sheet is displayed.

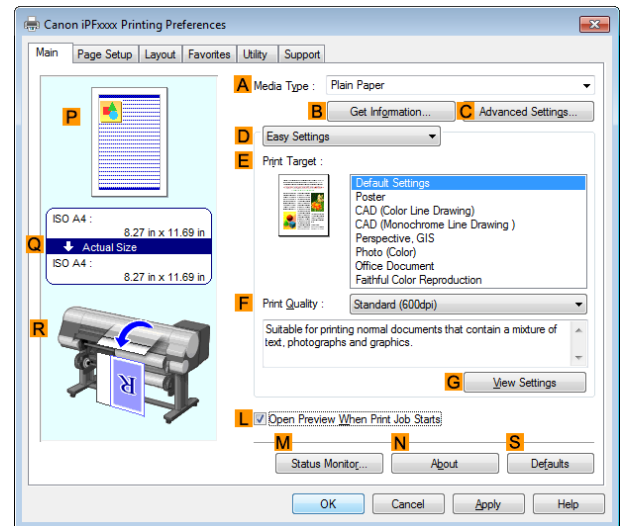

- 4** In the **A Media Type** list, select the type of paper that is loaded. In this case, click Plain Paper.

- 5** Select the print target in the **E Print Target** list.

- 6** Click the **Page Setup** tab to display the **Page Setup** sheet.

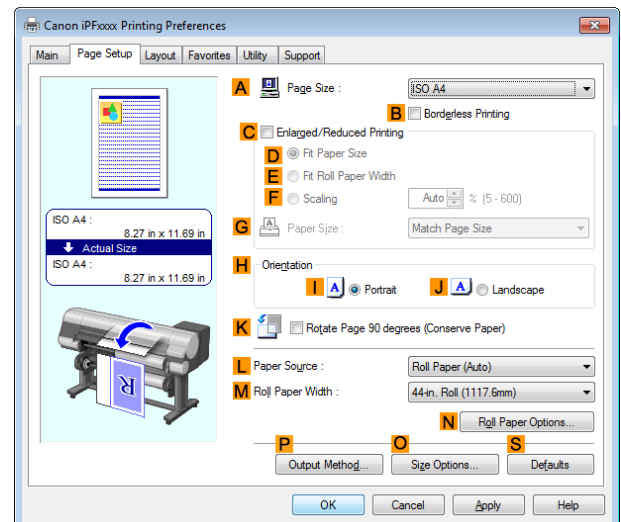

- 7** In the **A Page Size** list, click the size of the original as specified in the application. In this case, click **ISO A4** or **Letter (8.5"x11")**.

- 8** Select and click a roll paper in the **L Paper Source** list.

- 9** Select the width of the loaded roll in the **M Roll Paper Width** list—in this case, **ISO A3/A4 Roll (297.0mm)**.

10 Click the **Layout** tab to display the **Layout** sheet.

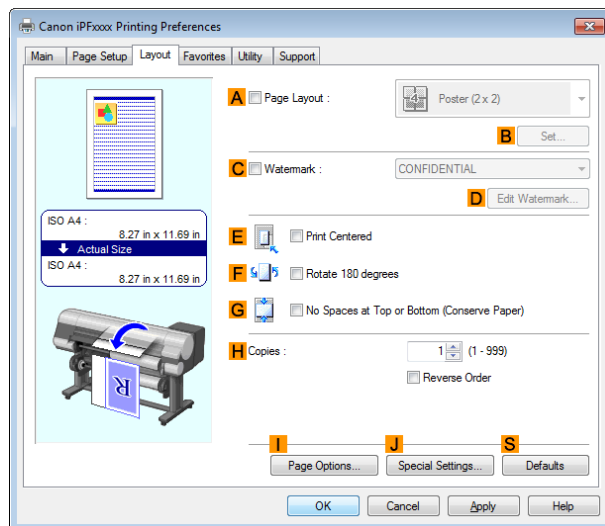

11 Select the **E Print Centered** check box.

12 Confirm the print settings and print as desired.



• For tips on confirming print settings, see "Confirming Print Settings ." →P.161

Printing Originals Centered on Rolls (Mac OS)

This topic describes how to center originals before printing on rolls based on the following example.

- Document: Any Type
- Page size: A4 (210.0 × 297.0 mm [8.3 × 11.7 in])
- Paper: Roll paper
- Paper type: Plain Paper
- Roll paper width: A3/A4 roll (297.0 mm [11.7 in])

1 Choose **Page Setup** from the application menu to display the **Page Attributes** dialog box.

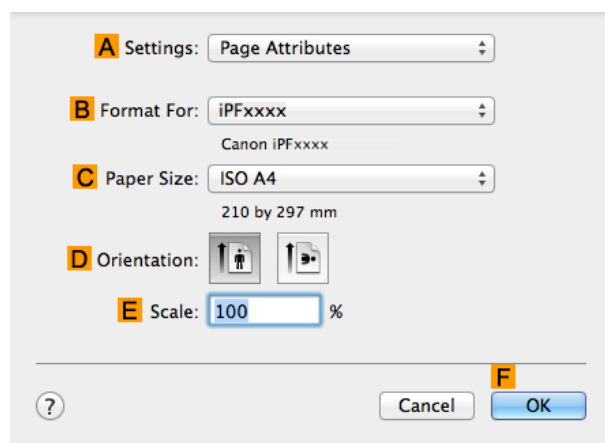

• **Page Setup** might not be displayed in the menu depending on the OS you are using and the application software.

In this case, select **Print** from the menu in the application software, and configure the settings in the upper part of the printer driver screen that is displayed.

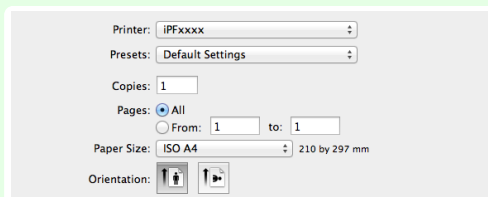

2 Select the printer in the **B Format for** list.

- 3 In **C Paper Size**, click the size of the original. In this case, click **ISO A4**.
- 4 Click **F OK** to close the dialog box.
- 5 Choose **Print** in the application menu.
- 6 Access the **Main** pane.

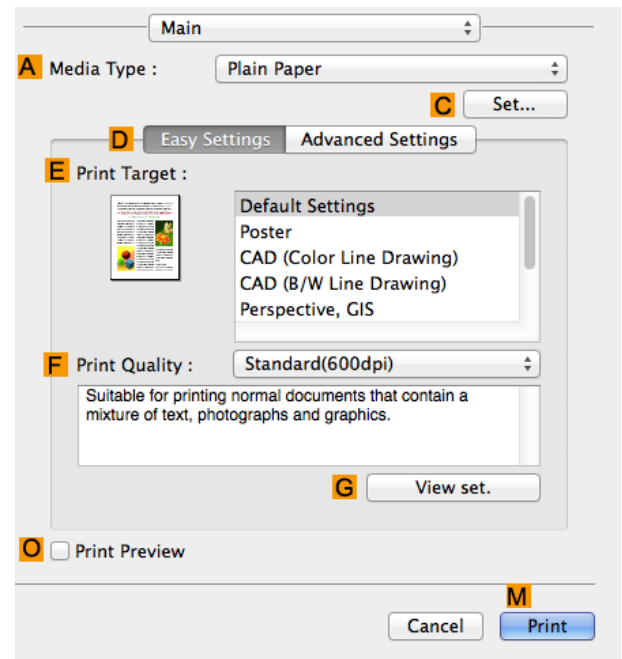

- 7 In the **A Media Type** list, select the type of paper that is loaded. In this case, click Plain Paper.
- 8 Make your selection in the **E Print Target** list.
- 9 Make your selection in the **F Print Quality** list.
- 10 Access the **Page Setup** pane.

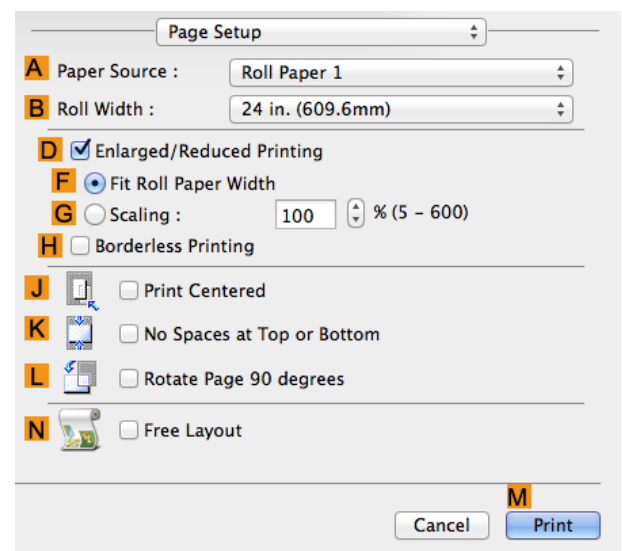

- 11 Select and click a roll paper in the **A Paper Source** list.
- 12 Select the paper width of the roll loaded in the printer for **B Roll Width**. In this case, **ISO A3/A4 (297.0mm)** is selected.
- 13 Select the **J Print Centered** check box.

14 Confirm the print settings, and then click **M Print** to start printing.



• For tips on confirming print settings, see "Confirming Print Settings ." [→P.270](#)

Note

Printing Originals Centered on Sheets

You can print originals centered on a page—for example, if the paper is larger than the original, or if you are reducing the original.

• Print Centered

If you use paper larger than the original size or print originals after reduction, the printed images may be aligned in the upper-left corner of the paper. In this case, you can center originals on sheets when printing.

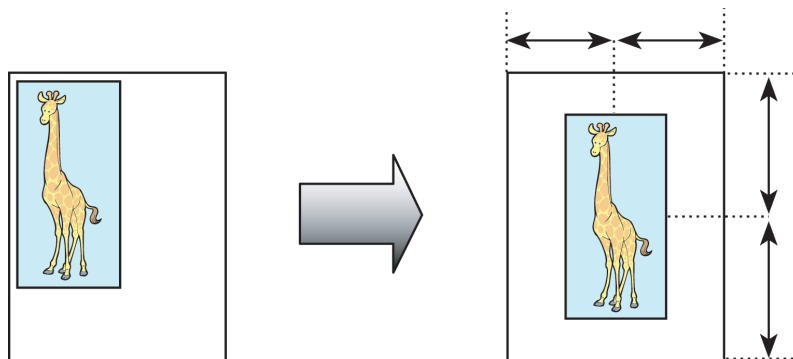

For instructions on centering originals when printing on cut sheets, refer to the following topics, as appropriate for your operating system.

- [Printing Originals Centered on Sheets \(Windows\) →P.132](#)
- [Printing Originals Centered on Sheets \(Mac OS\) →P.134](#)

Printing Originals Centered on Sheets (Windows)

This topic describes how to reduce an original 50% for printing centered on a sheet.

- Document: Any Type
- Page size: A4 (210.0 × 297.0 mm [8.3 × 11.7 in])
- Paper: Sheets
- Paper type: Plain Paper
- Paper size: A4 (210.0 × 297.0 mm [8.3 × 11.7 in])

1 Choose **Print** in the application menu.

2 Select the printer in the dialog box, and then display the printer driver dialog box. (See "Accessing the Printer Driver Dialog Box from Applications .") [→P.164](#)

- 3** Make sure the **Main** sheet is displayed.

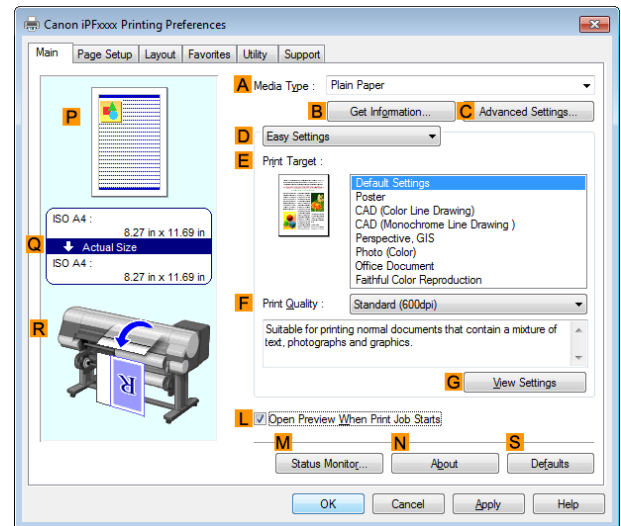

- 4** In the **A Media Type** list, select the type of paper that is loaded. In this case, click Plain Paper.

- 5** Make your selection in the **E Print Target** list.

- 6** Click the **Page Setup** tab to display the **Page Setup** sheet.

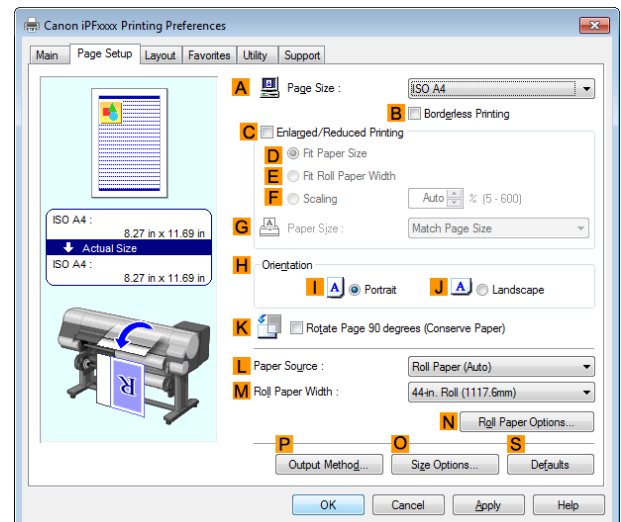

- 7** In the **A Page Size** list, click the size of the original as specified in the application. In this case, click **ISO A4**.

- 8** Select the **C Enlarged/Reduced Printing** check box.

- 9** Click **Match Page Size** in the **G Paper Size** list.

- 10** Click **F Scaling** and enter **50**.

- 11** Click **Cut Sheet** in the **L Paper Source** list.

12 Click the **Layout** tab to display the **Layout** sheet.

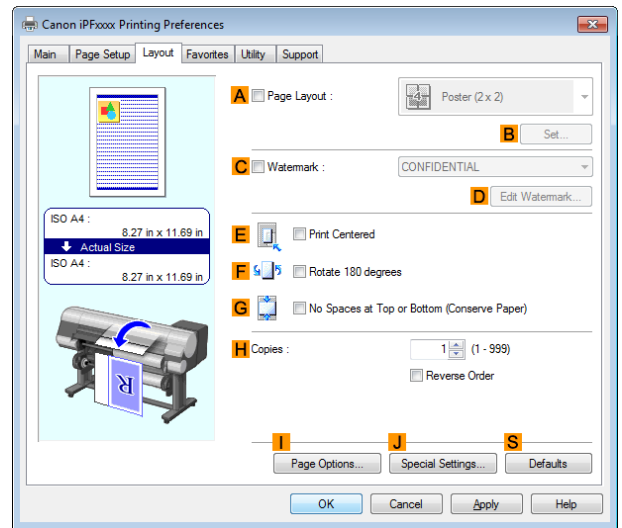

13 Select the **E Print Centered** check box.

14 Confirm the print settings and print as desired.



- If you have selected **Cut Sheet** as the paper source, follow the instructions on the printer control panel to enter the paper size.



- For tips on confirming print settings, see "Confirming Print Settings ." →P.161

Printing Originals Centered on Sheets (Mac OS)

This topic describes how to center originals for printing on sheets, based on the following example.

- Document: Any Type
- Page size: A4
- Paper: Sheets
- Paper type: Plain Paper
- Paper size: Non-standard

1 Choose **Page Setup** from the application menu to display the **Page Attributes** dialog box.

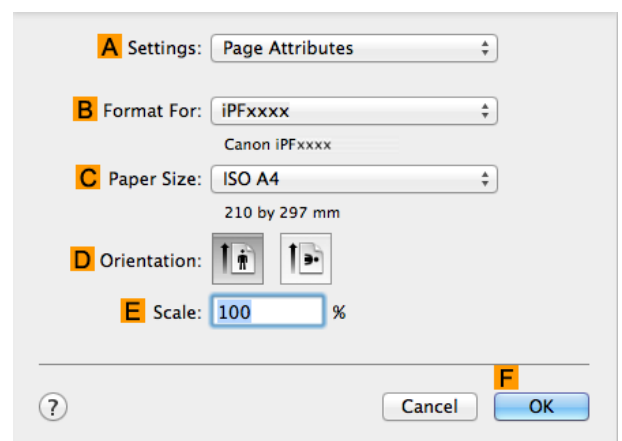

- **Page Setup** might not be displayed in the menu depending on the OS you are using and the application software. In this case, select **Print** from the menu in the application software, and configure the settings in the upper part of the printer driver screen that is displayed.

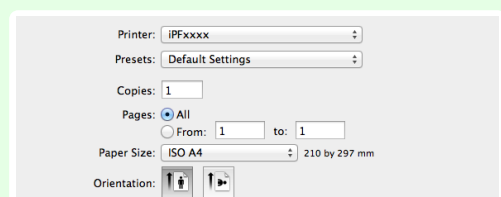

- 2 Select the printer in the **B Format for** list.
- 3 In the **C Paper Size** list, click the size of the original. In this case, click **ISO A4 - Cut Sheet**.
- 4 Click **F OK** to close the dialog box.
- 5 Choose **Print** in the application menu.
- 6 Access the **Main** pane.

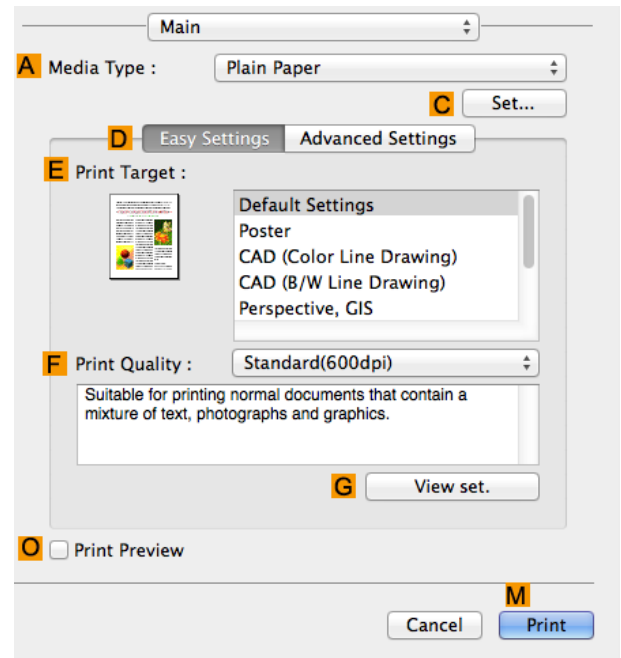

- 7 In the **A Media Type** list, select the type of paper that is loaded. In this case, click Plain Paper.
- 8 Make your selection in the **E Print Target** list.
- 9 Make your selection in the **F Print Quality** list.
- 10 Access the **Page Setup** pane.

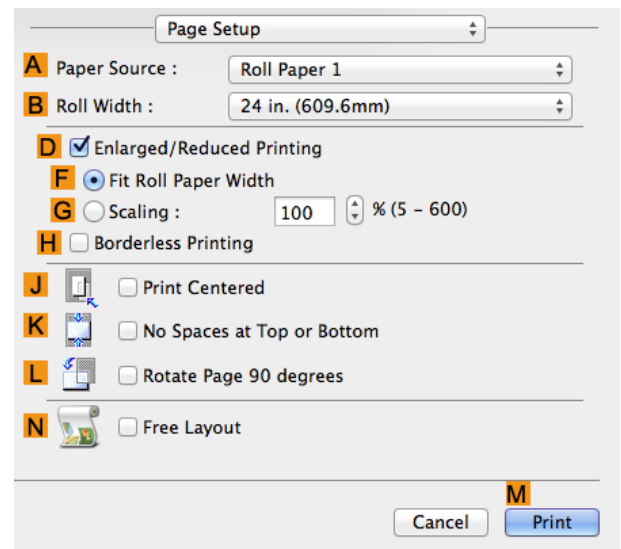

- 11 Click **Cut Sheet** in the **A Paper Source** list.
- 12 Select the **J Print Centered** check box.

13 Confirm the print settings, and then click **MPrint** to start printing.



Note

- For tips on confirming print settings, see "Confirming Print Settings ." [→P.270](#)



Important

- If you have selected **Cut Sheet** as the paper source, follow the instructions on the printer control panel to enter the paper size.

Conserving roll paper

- Conserving Roll Paper by Rotating Originals 90 Degrees 137
 - Conserving Roll Paper by Rotating Originals 90 Degrees (Windows) 137
 - Conserving Roll Paper by Rotating Originals 90 Degrees (Mac OS) 138
- Conserving Roll Paper by Printing Originals Without Top and Bottom Margins 140
 - Conserving Roll Paper by Printing Originals Without Top and Bottom Margins (Windows) 141
 - Conserving Roll Paper by Printing Originals Without Top and Bottom Margins (Mac OS) 142

Conserving Roll Paper by Rotating Originals 90 Degrees

You can conserve roll paper by specifying particular settings as suitable for your original.

• Rotate Page 90 degrees (Conserve Paper)

When originals are printed in portrait orientation, the original is rotated 90 degrees before printing if it fits within the roll width. This enables you to conserve paper.

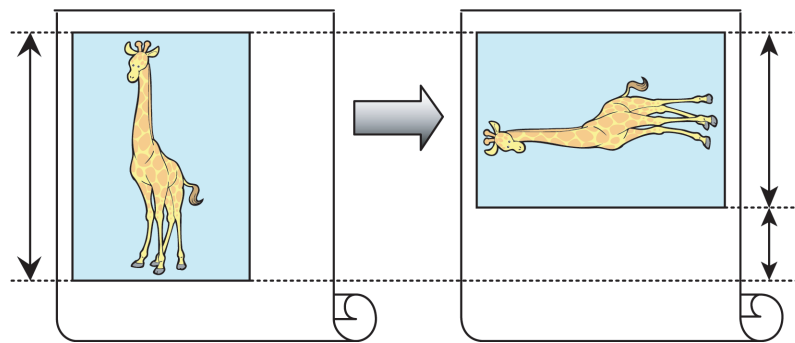

Important • If the page would exceed the roll paper width after rotation, use this function with Scale to fit Roll Paper Width to print rotated pages.

For tips on conserving roll paper, refer to the following topics, as appropriate for your operating system.

- [Conserving Roll Paper by Rotating Originals 90 Degrees \(Windows\)](#) →P.137
- [Conserving Roll Paper by Rotating Originals 90 Degrees \(Mac OS\)](#) →P.138

Conserving Roll Paper by Rotating Originals 90 Degrees (Windows)

This topic describes how to conserve paper by rotating originals 90 degrees before printing, based on the following example.

- Document: Any type
- Page size: A4 (210.0×297.0 mm)/Letter (8.3×11.7 in)
- Paper: Roll
- Paper type: Plain Paper
- Roll paper width: A3/A4 roll (297.0 mm [11.7 in])

This example illustrates how to rotate an A4 (210.0×297.0 mm)/Letter (8.3×11.7 in) original in portrait orientation 90 degrees to fit within the width of A3/A4 roll paper (297.0 mm [11.7 in]), which enables you to conserve paper.

- 1** Choose **Print** in the application menu.
- 2** Select the printer in the dialog box, and then open the printer driver dialog box. (See "Accessing the Printer Driver Dialog Box from Applications.") →P.164

3 Make sure the **Main** sheet is displayed.

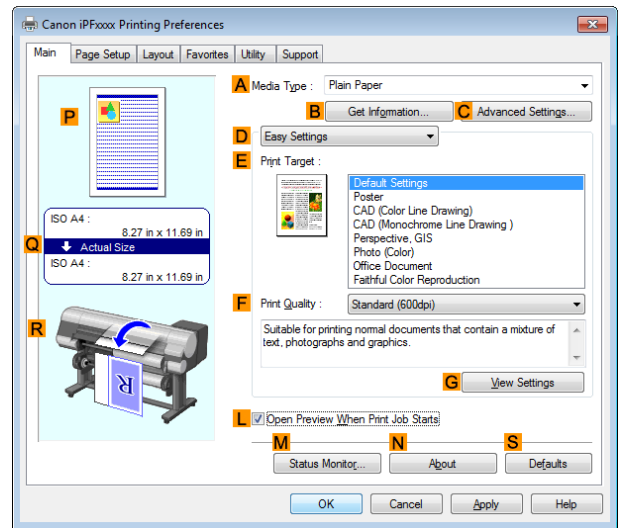

4 In the **A Media Type** list, select the type of paper that is loaded. In this case, click Plain Paper.

5 Click the **Page Setup** tab to display the **Page Setup** sheet.

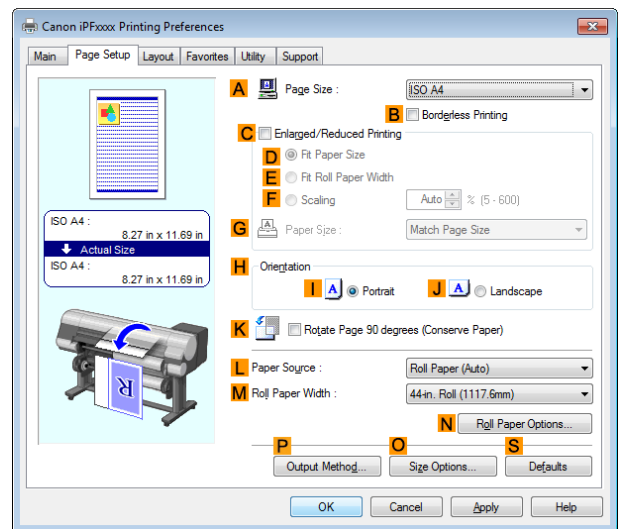

6 In the **A Page Size** list, click the size of the original as specified in the application. In this case, click **ISO A4** or **Letter (8.5"x11")**.

7 Select and click a roll paper in the **L Paper Source** list.

8 Select the width of the loaded roll in the **M Roll Paper Width** list—in this case, **ISO A3/A4 Roll (297.0mm)**.

9 Select the **K Rotate Page 90 degrees (Conserve Paper)** check box.

10 Confirm the print settings and print as desired.



• For tips on confirming print settings, see "Confirming Print Settings ." →P.161

Note

Conserving Roll Paper by Rotating Originals 90 Degrees (Mac OS)

This topic describes how to conserve roll paper by rotating originals 90 degrees before printing, based on the following example.

- Document: Any Type
- Page size: A4 (210.0 × 297.0 mm [8.3 × 11.7 in])

- Paper: Roll paper
- Paper type: Plain Paper
- Roll paper width: A3/A4 roll (297.0 mm [11.7 in])

This example illustrates how to rotate an A4 (210.0×297.0 mm)/Letter (8.3 × 11.7 in) original in portrait orientation 90 degrees to fit within the width of A3/A4 roll (297.0 mm [11.7 in]), which enables you to conserve paper.

1 Choose **Page Setup** from the application menu to display the **Page Attributes** dialog box.

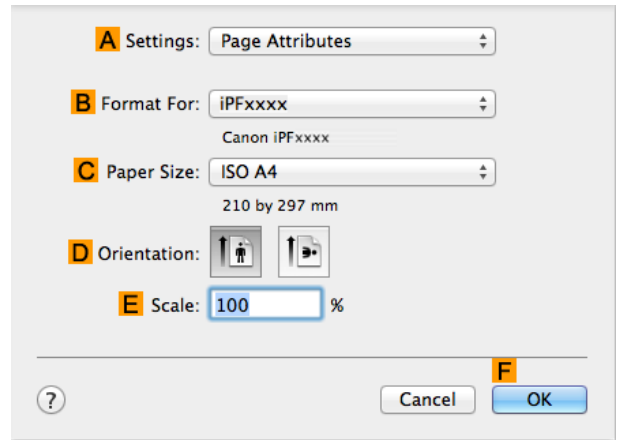

Note • **Page Setup** might not be displayed in the menu depending on the OS you are using and the application software. In this case, select **Print** from the menu in the application software, and configure the settings in the upper part of the printer driver screen that is displayed.

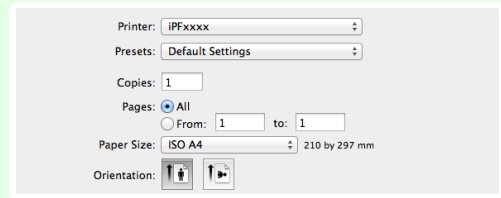

2 Select the printer in the **B Format for** list.

3 In **C Paper Size**, click the size of the original. In this case, click **ISO A4**.

4 Click **F OK** to close the dialog box.

5 Choose **Print** in the application menu.

6 Access the **Main** pane.

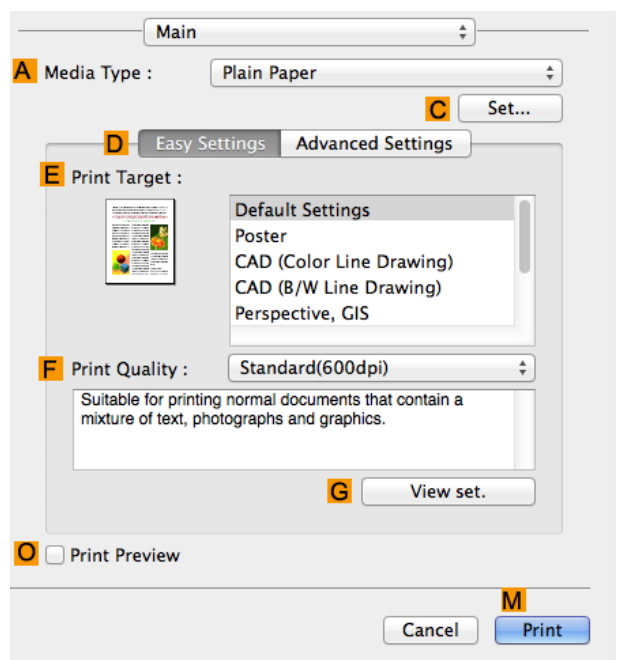

7 In the **A Media Type** list, select the type of paper that is loaded. In this case, click Plain Paper.

8 Access the **Page Setup** pane.

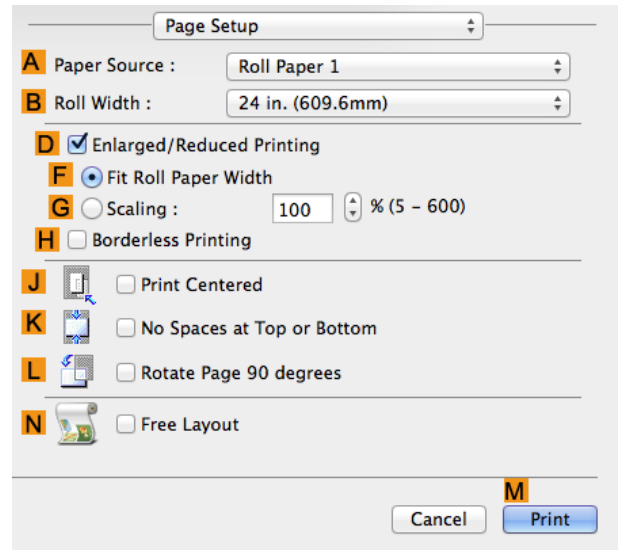

9 Select and click a roll paper in the **A Paper Source** list.

10 Select the paper width of the roll loaded in the printer for **B Roll Width**. In this case, **ISO A3/A4 (297.0mm)** is selected.

11 Select the **L Rotate Page 90 degrees** check box.

12 Confirm the print settings, and then click **M Print** to start printing.

 **Note** • For tips on confirming print settings, see "Confirming Print Settings ." [→P270](#)

Conserving Roll Paper by Printing Originals Without Top and Bottom Margins

You can conserve roll paper by specifying particular settings as suitable for your original.

• No Spaces at Top or Bottom (Conserve Paper)

You can print without feeding the paper for blank portions of originals if there are top and bottom margins in originals. This enables you to conserve as much paper as the size of the margins.

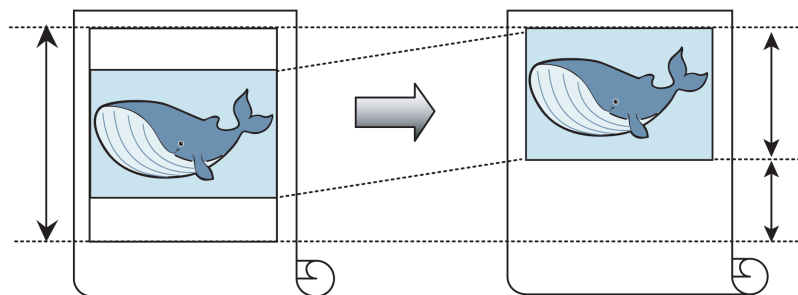

 **Important** • Printing without the top and bottom margins is not supported in the following cases.
 • If you have chosen poster as the type of page layout

 **Note** • Even during borderless printing, you can print without the top and bottom margins.
 • Printing without the top and bottom margins may cause inconsistency in the size of printed documents, depending on the layout of images or text in your originals.

For tips on conserving roll paper, refer to the following topics, as appropriate for your operating system.

- Conserving Roll Paper by Printing Originals Without Top and Bottom Margins (Windows) →P.141
- Conserving Roll Paper by Printing Originals Without Top and Bottom Margins (Mac OS) →P.142

Conserving Roll Paper by Printing Originals Without Top and Bottom Margins (Windows)

This topic describes how to conserve roll paper when printing originals that have a top and bottom margin, based on the following example.

- Document: Any type
- Page size: A4 (210.0×297.0 mm)/Letter (8.3 × 11.7 in)
- Paper: Roll
- Paper type: Plain Paper
- Roll paper width: A3/A4 roll (297.0 mm [11.7 in])

- 1** Choose **Print** in the application menu.
- 2** Select the printer in the dialog box, and then display the printer driver dialog box. (See "Accessing the Printer Driver Dialog Box from Applications .") →P.164
- 3** Make sure the **Main** sheet is displayed.

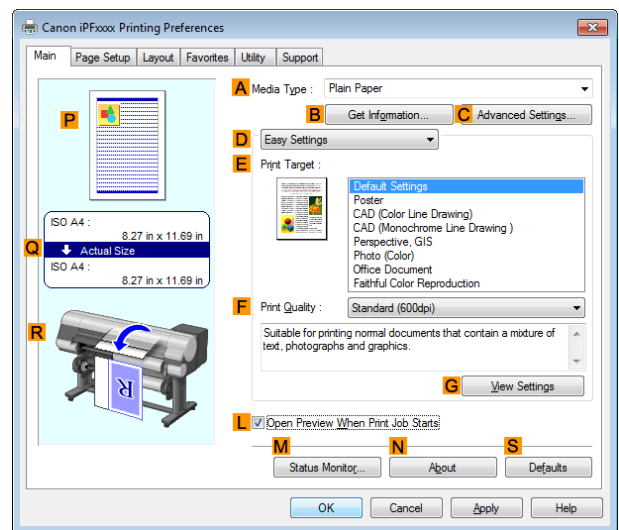

- 4** In the **A Media Type** list, select the type of paper that is loaded. In this case, click Plain Paper.
- 5** Click the **Page Setup** tab to display the **Page Setup** sheet.

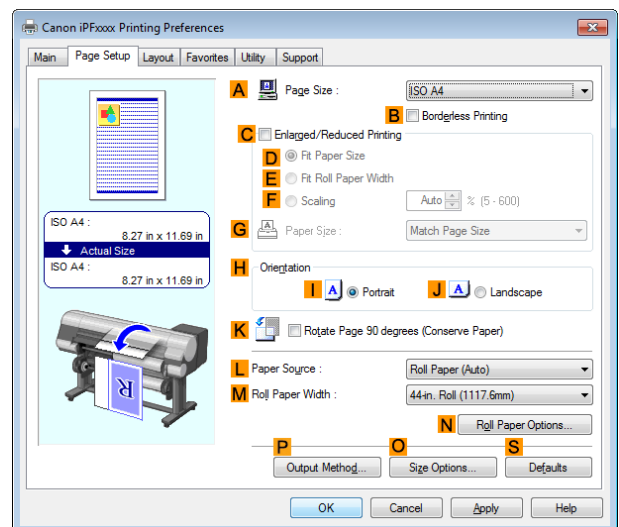

- 6** In the **A Page Size** list, click the size of the original as specified in the application. In this case, click **ISO A4** or **Letter (8.5"x11")**.

7 Select and click a roll paper in the **L Paper Source** list.

8 Select the width of the loaded roll in the **M Roll Paper Width** list—in this case, **ISO A3/A4 Roll (297.0mm)**.

9 Click the **Layout** tab to display the **Layout** sheet.

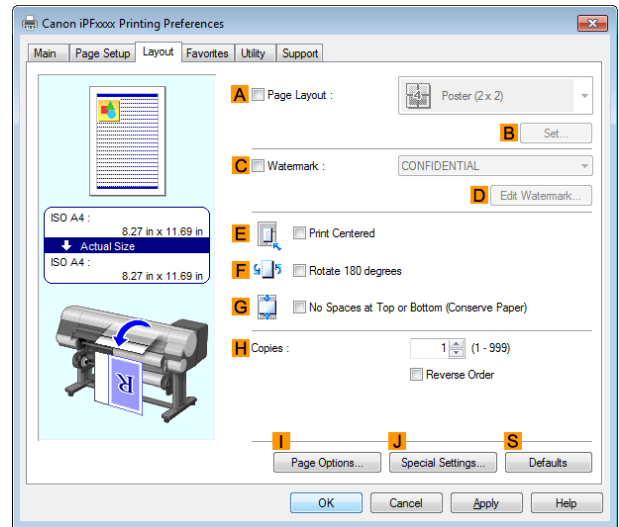

10 Select the **G No Spaces at Top or Bottom (Conserve Paper)** check box.

11 Confirm the print settings and print as desired.

 **Note** • For tips on confirming print settings, see "Confirming Print Settings ." →P.161

Conserving Roll Paper by Printing Originals Without Top and Bottom Margins (Mac OS)

This topic describes how to conserve roll paper when printing originals that have a top and bottom margin, based on the following example.

- Document: Any Type
- Page size: A4 (210.0 × 297.0 mm [8.3 × 11.7 in])
- Paper: Roll paper
- Paper type: Plain Paper
- Roll paper width: A3/A4 roll (297.0 mm [11.7 in])

1 Choose **Page Setup** from the application menu to display the **Page Attributes** dialog box.

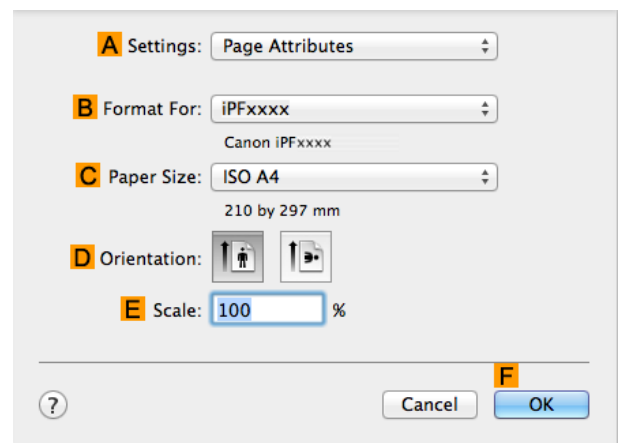



• **Page Setup** might not be displayed in the menu depending on the OS you are using and the application software. In this case, select **Print** from the menu in the application software, and configure the settings in the upper part of the printer driver screen that is displayed.

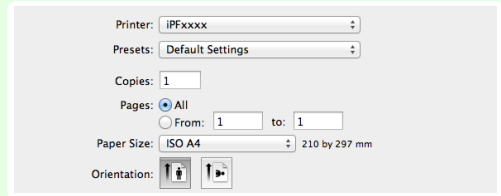

- 2** Select the printer in the **B Format for** list.
- 3** In **C Paper Size**, click the size of the original. In this case, click **ISO A4**.
- 4** Click **F OK** to close the dialog box.
- 5** Choose **Print** in the application menu.
- 6** Access the **Main** pane.

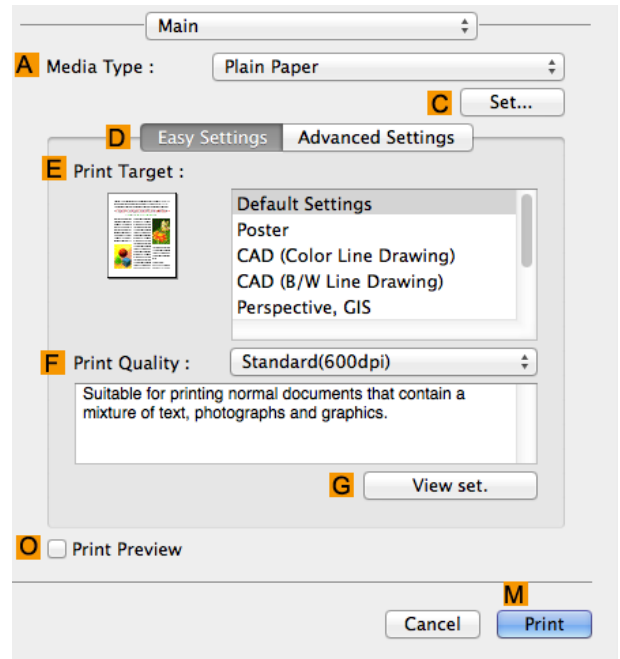

- 7** In the **A Media Type** list, select the type of paper that is loaded. In this case, click Plain Paper.
- 8** Access the **Page Setup** pane.

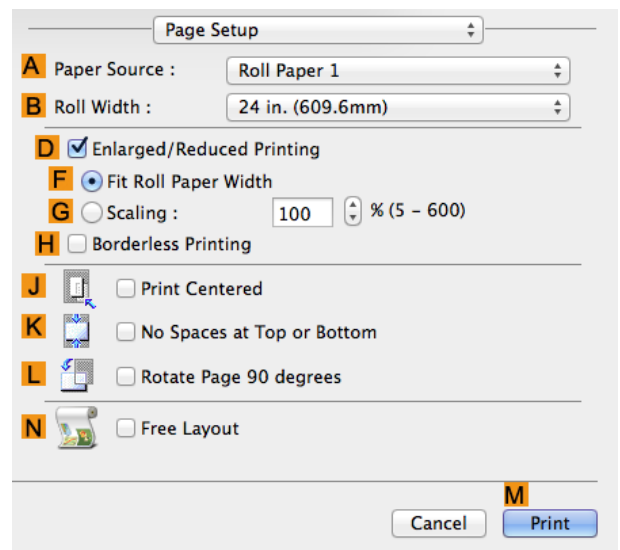

- 9 Select and click a roll paper in the **A Paper Source** list.
- 10 Select the paper width of the roll loaded in the printer for **B Roll Width**. In this case, **ISO A3/A4 (297.0mm)** is selected.
- 11 Select the **K No Spaces at Top or Bottom** check box.
- 12 Confirm the print settings, and then click **M Print** to start printing.



Note

- For tips on confirming print settings, see "Confirming Print Settings ." [→P.270](#)

Checking Images Before Printing

Checking the Layout in a Preview Before Printing

You can check the print layout on the preview screen.

- **Open Preview When Print Job Starts (Windows)**

While viewing the preview screen, you can also adjust orientation or other settings, and your changes will be instantly applied on the preview screen.

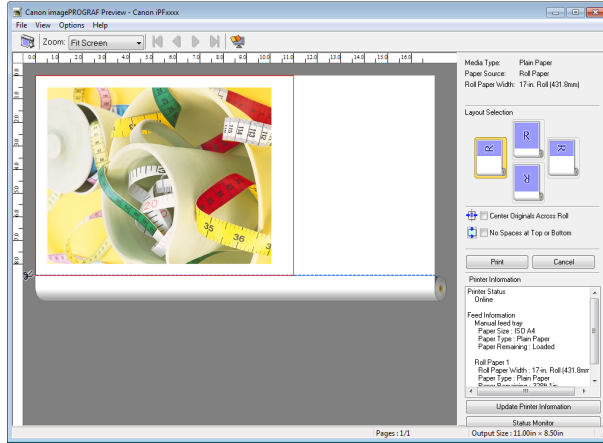

 **Note** • Under some settings and in some environments, PageComposer may be started.

- **Preview (Mac OS)**

While viewing the preview screen, you can also adjust layout or size settings, and your changes will be instantly applied on the preview screen.

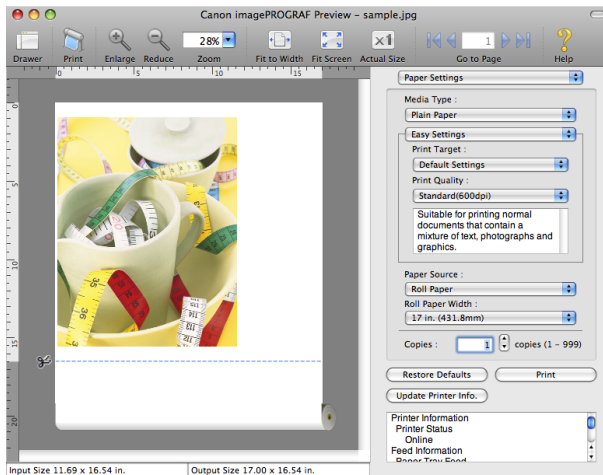

For instructions on how to check the layout before printing, refer to the following topics:

- **Checking the Layout in a Preview Before Printing (Windows)** →P.161
- **Checking the Layout in a Preview Before Printing (Mac OS)** →P.271

Other useful settings

Printing With Watermarks	146
Printing with Watermarks—COPY, FILE COPY, and so on (Windows)	147
Making the Original Orientation Match the Paper Orientation	148
Making the Original Orientation Match the Paper Orientation (Windows)	149
Making the Original Orientation Match the Paper Orientation (Mac OS)	150
Using Favorites	152
→ Using Favorites (Windows)	162
→ Using Favorites (Mac OS)	271
Cutting Roll Paper After Printing	152
Cutting Roll Paper After Printing (Windows)	153
Cutting Roll Paper After Printing (Mac OS)	154

Printing With Watermarks

You can add watermarks (background images) to documents that require special handling.

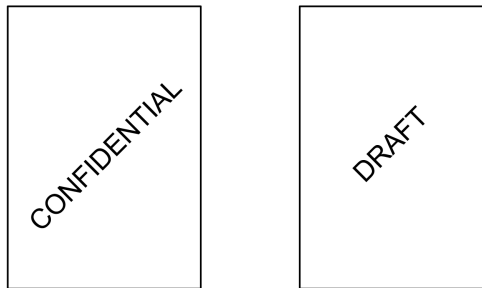

• Watermark

Watermarks are applied to all pages of your document.

 • Watermarks are not printed if you select poster as the type of page layout.

Important

The following watermarks are provided:

- CONFIDENTIAL
- COPY
- DRAFT
- FILE COPY
- FINAL
- PRELIMINARY
- PROOF
- TOP SECRET

You can also create your own watermarks. Specify the following options to customize your watermark.

- Watermark string: Specify the font, size, color, and so on. Surround the watermark with a frame, if desired.
- Watermark position: Specify the position on the page, the angle, and so on.
- Watermark printing method: Specify whether to print the watermark superimposed or under the document image. You can also print the watermark only on the first page, if desired.

 • Watermarks are supported in Windows.

Note • In addition to the provided watermarks, you can create up to 50 original watermarks.

For detailed instructions on printing with watermarks, refer to the following topics:

- **Printing with Watermarks—COPY, FILE COPY, and so on (Windows)** →P.147

Printing with Watermarks—COPY, FILE COPY, and so on (Windows)

This topic describes how to print with watermarks, based on the following example of printing with a **FILE COPY** watermark.

- Document: Any type
- Page size: A2 (420.0×594.0 mm [16.5 × 23.4 in])
- Paper: Roll paper
- Paper type: Plain Paper
- Roll paper width: A2/A3 roll (420.0 mm [16.5 in])

1 Choose **Print** in the application menu.

2 Select the printer in the dialog box, and then display the printer driver dialog box. (See "Accessing the Printer Driver Dialog Box from Applications .") →P.164

3 Make sure the **Main** sheet is displayed.

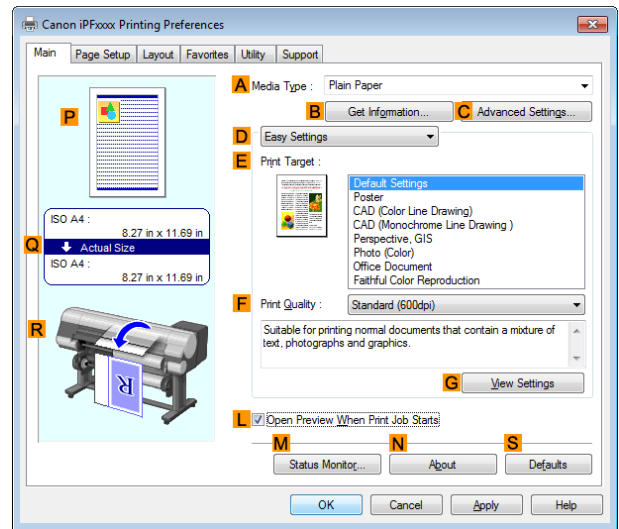

4 In the **A Media Type** list, select the type of paper that is loaded. In this case, click Plain Paper.

5 Make your selection in the **E Print Target** list.

Note • You can check the settings values selected in the **E Print Target** list by clicking **G View Settings**.

6 Click the **Page Setup** tab to display the **Page Setup** sheet.

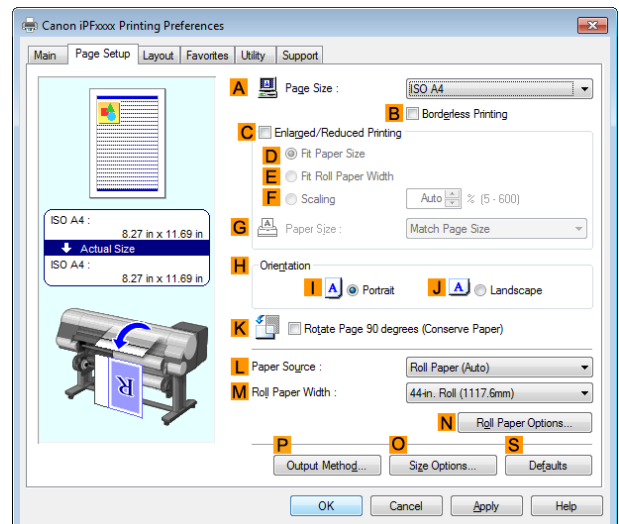

- 7** In **A Page Size**, click the size of the original as specified in the application software. In this case, click **ISO A2**.
- 8** Select and click a roll paper in the **L Paper Source** list.
- 9** Select the width of the loaded roll in the **M Roll Paper Width** list—in this case, **ISO A2/A3 Roll (420.0mm)**.
- 10** Click the **Layout** tab to display the **Layout** sheet.

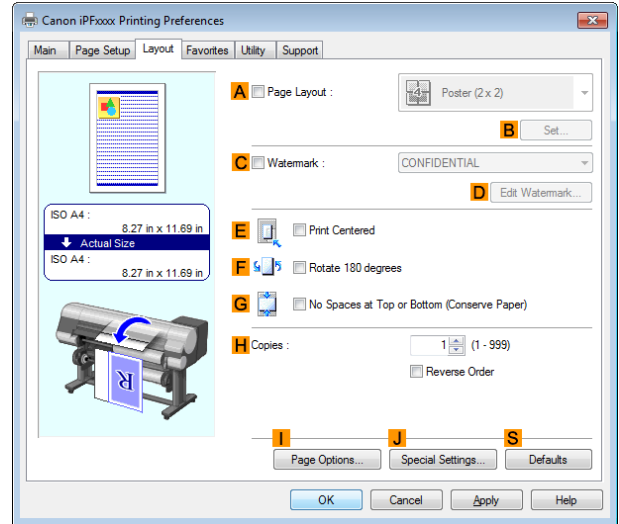

- 11** Select the **C Watermark** check box.

- 12** Click **FILE COPY** in the **Watermarks** list.

 **Note** • Click **D Edit Watermark** to open the **Edit Watermark** dialog box. In the **Edit Watermark** dialog box, you can create custom watermarks and change the position and angle of watermarks.

- 13** Confirm the print settings and print as desired.

 **Note** • For tips on confirming print settings, see "Confirming Print Settings ." [→P.161](#)

Making the Original Orientation Match the Paper Orientation

You can specify the original orientation to match the orientation of the paper for printing.

• Orientation

Paper is usually loaded in the printer in portrait orientation. When you have an original in landscape orientation, you can specify the printing orientation so that the original is printed in landscape orientation.

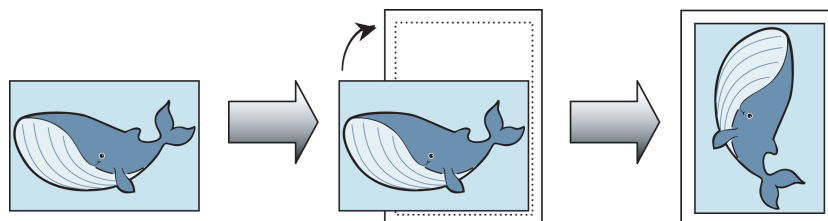

• Rotate 180 degrees

The original is rotated 180 degrees to print it upside down.

• Mirror

A mirror image of the original is printed.

For instructions on specifying the original orientation before printing, refer to the following topics, as appropriate for your operating system.

- Making the Original Orientation Match the Paper Orientation (Windows) →P.149
- Making the Original Orientation Match the Paper Orientation (Mac OS) →P.150

Making the Original Orientation Match the Paper Orientation (Windows)

This topic describes how to print an original in landscape orientation after matching the paper orientation, based on the following example.

- Document: An original in landscape orientation
- Page size: A4 (210.0 × 297.0 mm)/Letter (8.3 × 11.7 in)
- Paper: Roll
- Paper type: Plain Paper
- Roll paper width: A2/A3 roll (420.0 mm [16.5 in])

- 1 Choose **Print** in the application menu.
- 2 Select the printer in the dialog box, and then open the printer driver dialog box. (See "Accessing the Printer Driver Dialog Box from Applications .") →P.164
- 3 Make sure the **Main** sheet is displayed.

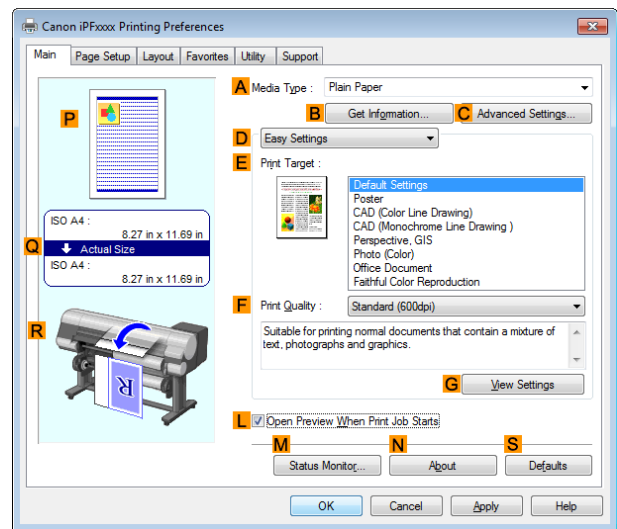

- 4 In the **A Media Type** list, select the type of paper that is loaded. In this case, click Plain Paper.
- 5 Make your selection in the **E Print Target** list.
- 6 Make your selection in the **F Print Quality** list.

7 Click the **Page Setup** tab to display the **Page Setup** sheet.

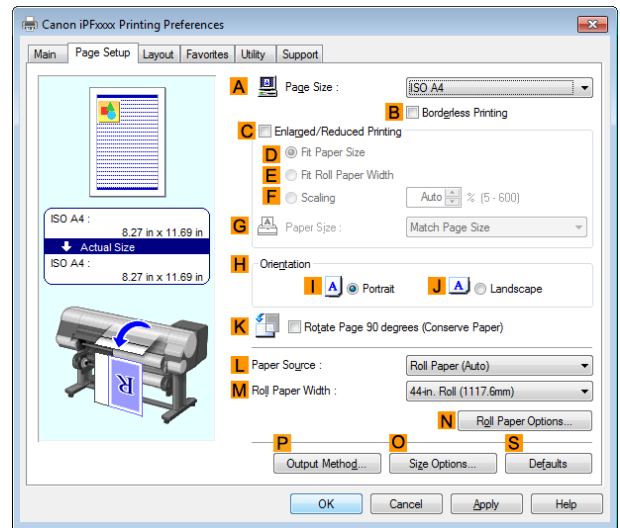

8 In the **A Page Size** list, click the size of the original as specified in the application. In this case, click **ISO A4** or **Letter (8.5"x11")**.

9 In **H Orientation**, click **J Landscape**.

10 Select and click a roll paper in the **L Paper Source** list.

11 Select the width of the loaded roll in the **M Roll Paper Width** list—in this case, **ISO A2/A3 Roll (420.0mm)**.

12 Confirm the print settings and print as desired.



• For tips on confirming print settings, see "Confirming Print Settings ." →P.161

Note

Making the Original Orientation Match the Paper Orientation (Mac OS)

This topic describes how to print an original in landscape orientation after matching the paper orientation, based on the following example.

- Document: An original in landscape orientation
- Page size: A4 (210.0 × 297.0 mm [8.3 × 11.7 in])
- Paper: Roll paper
- Paper type: Plain Paper
- Roll paper width: A2/A3 roll (420.0 mm [16.5 in])

1 Choose **Page Setup** from the application menu to display the **Page Attributes** dialog box.

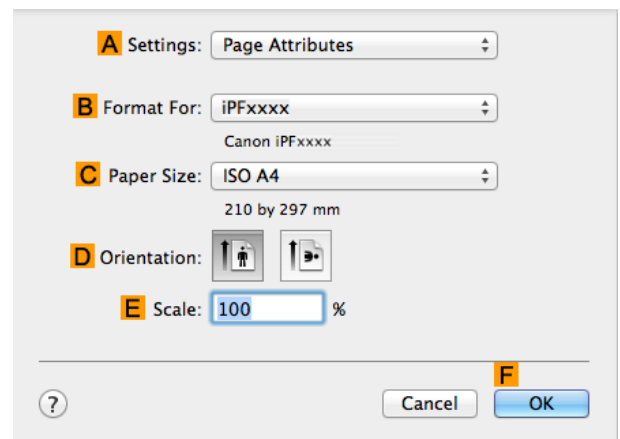



• **Page Setup** might not be displayed in the menu depending on the OS you are using and the application software. In this case, select **Print** from the menu in the application software, and configure the settings in the upper part of the printer driver screen that is displayed.

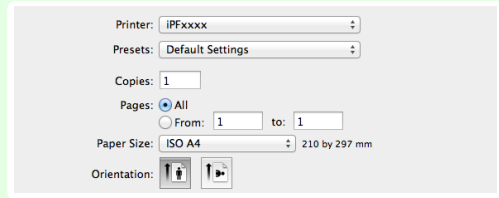

- 2** Select the printer in the **B Format for** list.
- 3** In **C Paper Size**, click the size of the original. In this case, click **ISO A4**.
- 4** In **D Orientation**, click the icon of the document in landscape orientation.
- 5** Click **F OK** to close the dialog box.
- 6** Choose **Print** in the application menu.
- 7** Access the **Main** pane.

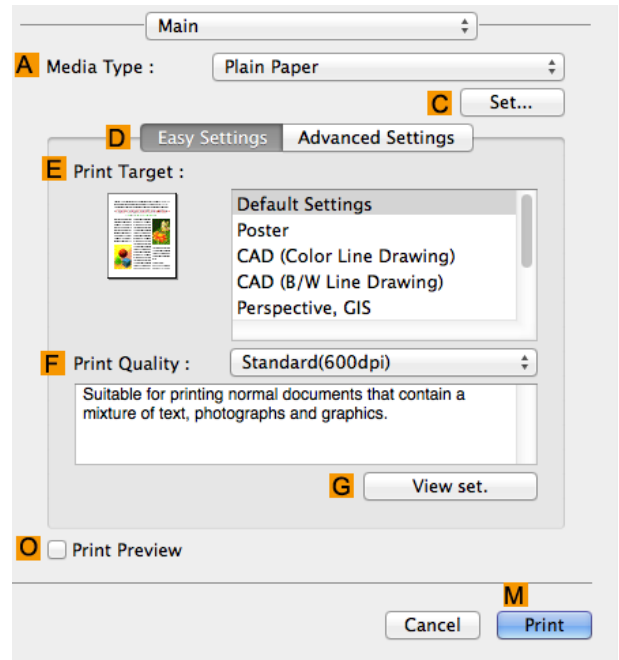

- 8** In the **A Media Type** list, select the type of paper that is loaded. In this case, click Plain Paper.
- 9** Make your selection in the **E Print Target** list.
- 10** Make your selection in the **F Print Quality** list.

11 Access the **Page Setup** pane.

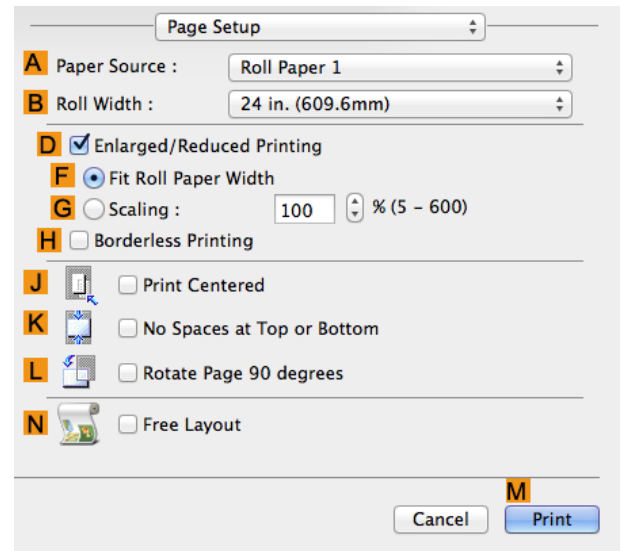

12 Select and click a roll paper in the **A Paper Source** list.

13 Select the paper width of the roll loaded in the printer for **B Roll Width**. In this case, **ISO A2/A3 (420.0mm)** is selected.

14 Confirm the print settings, and then click **M Print** to start printing.



Note

- For tips on confirming print settings, see "Confirming Print Settings ." [→P.270](#)

Using Favorites

You can register print settings as **Favorites** to reuse settings from a particular job that met your expectations, or settings for a particular page size that you will use repeatedly.

• Favorites

Registering a favorite for later use. You can choose the settings you have registered from a list before printing, and you can check the settings details.



Note

- You can also save the favorite settings as files. Using these files is a convenient way to print under the same conditions on another computer. (In Windows.)

For instructions on using favorites to print, refer to the following topics, as appropriate for your operating system.

- [Using Favorites \(Windows\) →P.162](#)
- [Using Favorites \(Mac OS\) →P.271](#)

Cutting Roll Paper After Printing

Roll paper can be automatically cut after printing.



Note

- It may not be possible to cut certain types of paper, such as adhesive paper. For details on types of paper that cannot be used with the auto cut feature, see the **Paper Reference Guide**. (See "Types of Paper.") [→P.332](#)

• Automatic Cutting

Roll paper is cut automatically after printing. If you prefer, you can print continuously without cutting the roll, or you can print a cut line.

For instructions on cutting roll paper after printing, refer to the following topics, as appropriate for your operating system.

- **Cutting Roll Paper After Printing (Windows)** →P.153
- **Cutting Roll Paper After Printing (Mac OS)** →P.154

Cutting Roll Paper After Printing (Windows)

This topic describes how to cut roll paper automatically after printing (using the auto cut function), as well as how to print a cut line for manual cutting.

Enhanced Printing Options

Other useful settings



Note

- The auto cut function is activated on the printer by default and when the printer driver is installed. Follow the steps below to reactivate the function if it is disabled, or to select the setting for printing a cut line instead.

- 1** Choose **Print** in the application menu.
- 2** Select the printer in the dialog box, and then display the printer driver dialog box. (See "**Accessing the Printer Driver Dialog Box from Applications .**") →P.164
- 3** Click the **Page Setup** tab to display the **Page Setup** sheet.

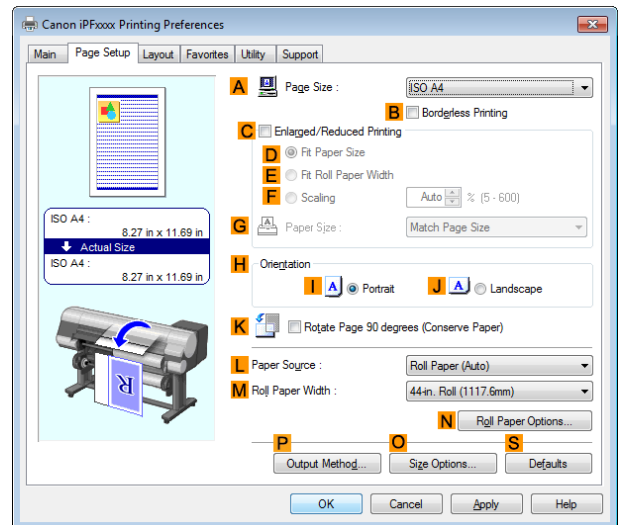

- 4** Select and click a roll paper in the **L Paper Source** list.

- 5** Click **N Roll Paper Options** to display the **Roll Paper Options** dialog box.

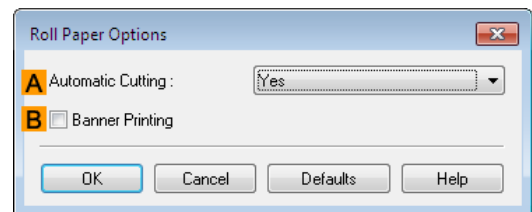

- 6** To enable automatic cutting, click **Yes** in the **A Automatic Cutting** list. If you prefer to cut the paper later yourself, click **Print Cut Guideline**.

- 7** Click **OK** to close the **Roll Paper Options** dialog box.

- 8** Confirm the print settings and print as desired.



Note

- For tips on confirming print settings, see "**Confirming Print Settings .**" →P.161

Roll paper will be automatically cut after printing.

Cutting Roll Paper After Printing (Mac OS)

This topic describes how to cut roll paper automatically after printing (using the auto cut function), as well as how to print a cut line for manual cutting.



- The auto cut function is activated on the printer by default and when the printer driver is installed. Follow the steps below to reactivate the function if it is disabled, or to select the setting for printing a cut line instead.

1 Choose **Page Setup** from the application menu to display the **Page Attributes** dialog box.

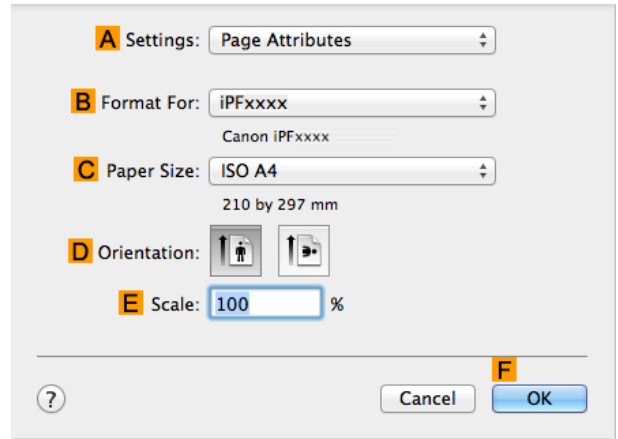

- Page Setup** might not be displayed in the menu depending on the OS you are using and the application software. In this case, select **Print** from the menu in the application software, and configure the settings in the upper part of the printer driver screen that is displayed.

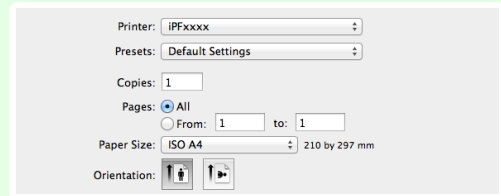

2 Select the printer in the **B Format for** list.

3 Choose the original size in the **C Paper Size** list.

4 Click **F OK** to close the dialog box.

5 Choose **Print** in the application menu.

6 Access the **Page Setup** pane.

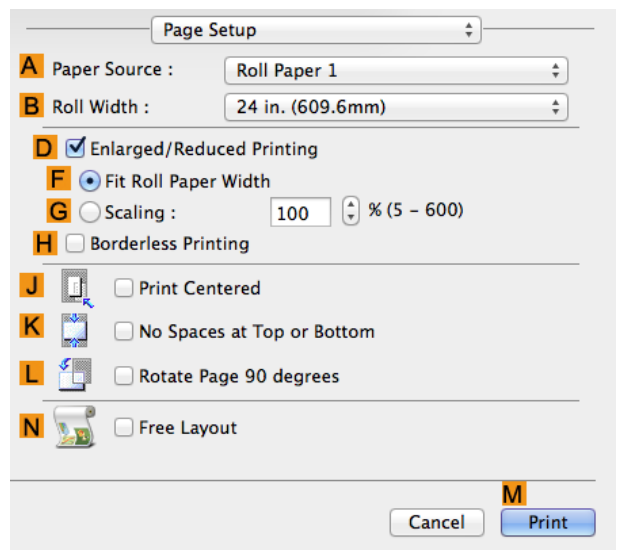

7 Select and click a roll paper in the **A Paper Source** list.

8 Access the **Main** pane.

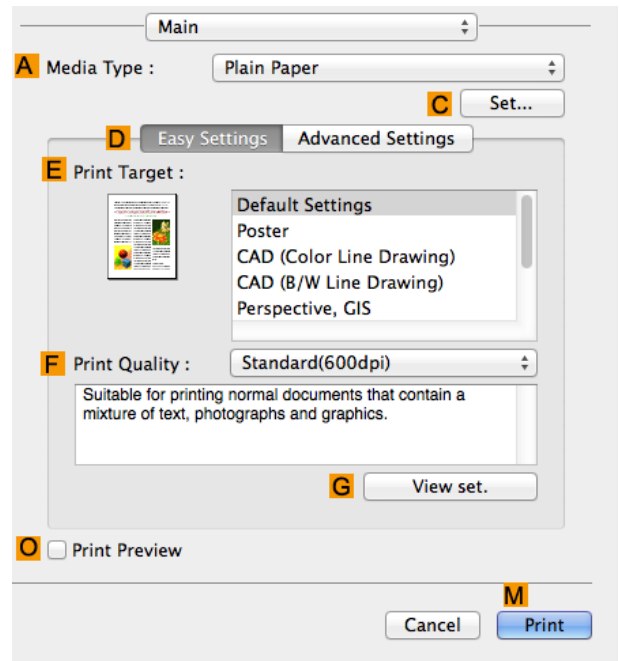

9 In the **A Media Type** list, select the type of paper that is loaded.

10 Click **C Set** to display the **Paper Detailed Settings** dialog box.

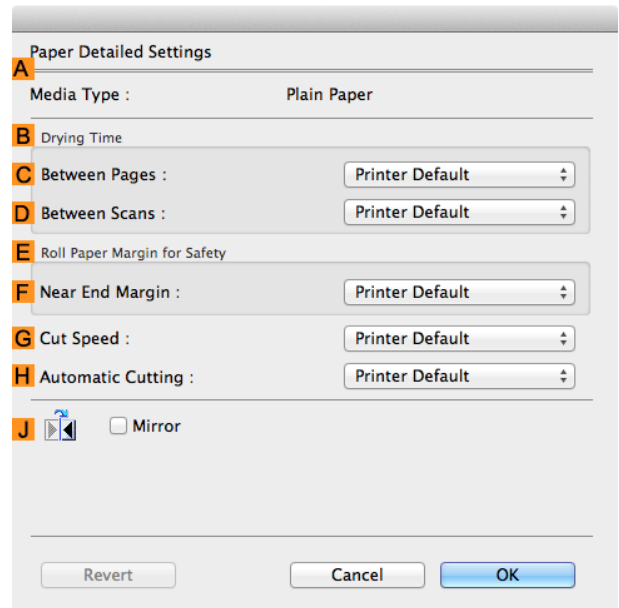

11 To enable automatic cutting, click **Printer Default** in the **H Automatic Cutting** list. If you prefer to cut the paper later yourself, click **Print Cut Guideline**.

Important

- If the automatic cut function has been deactivated on the printer, change the auto cut setting on the printer Control Panel.

12 Click **OK** to close the **Paper Detailed Settings** dialog box.

13 Confirm the print settings, and then click **M Print** to start printing.

Note

- For tips on confirming print settings, see "Confirming Print Settings ." →P270

Memo

Basic Printing Workflow	15
-------------------------	----

Enhanced Printing Options	29
---------------------------	----

Windows Software

Printer Driver	158
Preview	189
Free Layout	199
Color imageRUNNER Enlargement Copy	221
Print Plug-In for Office	230
→ Status Monitor	502
→ Accounting	507
→ Device Setup Utility	497
→ Media Configuration Tool	383

Mac OS Software	267
-----------------	-----

Handling and Use of Paper	331
---------------------------	-----

Control Panel	429
---------------	-----

Printer Parts	467
---------------	-----

Network Setting	481
-----------------	-----

Print Job Management	501
----------------------	-----

Adjustments for Better Print Quality	555
--------------------------------------	-----

Maintenance and Consumables	573
-----------------------------	-----

Troubleshooting	617
-----------------	-----

Error Message	651
---------------	-----

Specifications	673
----------------	-----

Appendix	677
----------	-----

Printer Driver

Printer Driver Settings	158
Specifying Paper in the Printer Driver	160
Confirming Print Settings	161
Checking the Layout in a Preview Before Printing	161
Using Favorites	162
Accessing the Printer Driver Dialog Box from Applications	164
Accessing the Printer Driver Dialog Box from the Operating System Menu	165
Main Sheet	166
Paper Information on Printer Dialog Box	170
Paper Detailed Settings Dialog Box	170
View Settings Dialog Box for the Printing Application	172
Color Adjustment Sheet: Color	172
Object Adjustment Dialog box: Color	173
Matching Sheet	174
Color Adjustment Sheet: Monochrome	176
Object Adjustment Dialog box: Monochrome	177
Page Setup Sheet	177
Output Method Dialog box	180
Paper Size Options Dialog Box	181
Layout Sheet	182
Page Options Dialog Box	183
Special Settings Dialog Box	184
Favorites Sheet	185
Utility Sheet	186
Support Sheet	187
Settings Summaries Dialog Box	187
Device Settings Sheet	188

Windows Software

Printer Driver

Printer Driver Settings

For instructions on accessing the Windows printer driver, refer to the following topics.

- **Accessing the Printer Driver Dialog Box from Applications** →P.164
- **Accessing the Printer Driver Dialog Box from the Operating System Menu** →P.165

For information on the Windows printer driver settings, refer to the following topics.

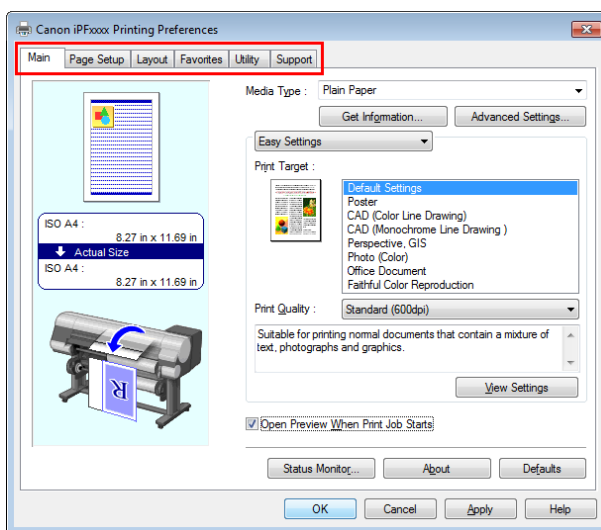

- **Main Sheet** →P.166

You can specify the type of paper, color processing, print quality, print preview, and other settings. Choose **Easy Settings** to specify basic print settings based on the printing application or **Advanced Settings** to complete more detailed settings as desired.

- Paper Detailed Settings Dialog Box →P.170
- View Settings Dialog Box for the Printing Application →P.172
- Color Adjustment Sheet: Color →P.172
- Object Adjustment Dialog box: Color →P.173
- Matching Sheet →P.174
- Color Adjustment Sheet: Monochrome →P.176
- Object Adjustment Dialog box: Monochrome →P.177
- Page Setup Sheet →P.177

You can specify the page size of the original, borderless printing, enlargement or reduction, the orientation, the paper size and feed source, and automatic cutting.

 - Output Method Dialog box →P.180
 - Paper Size Options Dialog Box →P.181
- Layout Sheet →P.182

You can specify the page layout, watermarks, the orientation, the number of copies, and print processing options.

 - Page Options Dialog Box →P.183
 - Special Settings Dialog Box →P.184
- Favorites Sheet →P.185

Groups of print settings you select on each sheet can be saved as a favorite. Favorites you have added can be edited or used at the time of printing as desired.
- Utility Sheet →P.186

You can specify settings related to maintenance for the Printhead and feed amount, as well as settings for **Color imageRUNNER Enlargement Copy**.
- Support Sheet →P.187

You can view support information and the user manual.

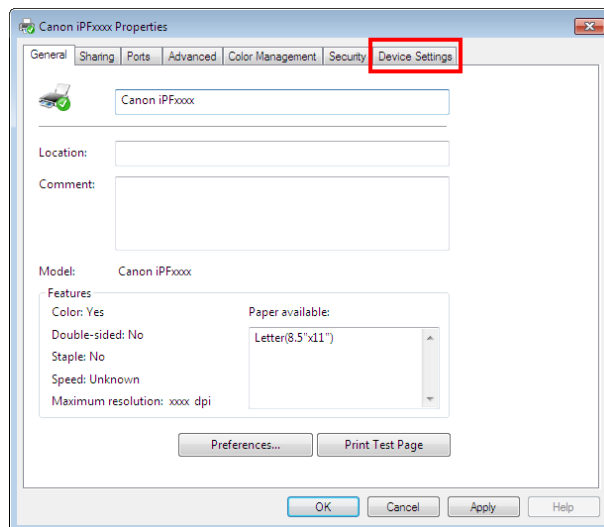

- Device Settings Sheet →P.188

You can display settings for optional equipment installed on the printer and see the version information for the printer driver.

imagePROGRAF Free Layout is a feature for freely arranging originals from various source applications on a single page as desired before printing. For details, see "Free Layout." →P.199

Color imageRUNNER Enlargement Copy is a feature for automatic enlargement and printing of scanned originals from a **Color imageRUNNER**. For details, see "Color imageRUNNER Enlargement Copy." →P.221



Note

- **Color imageRUNNER Enlargement Copy** is not displayed in 64-bit editions of Windows.

Specifying Paper in the Printer Driver

If you have replaced the paper, you must complete the following settings in the printer driver.



Important

- Always specify the same type and size of paper in the printer menu and printer driver.

1 Choose **Print** in the application menu.

2 Select the printer in the dialog box, and then display the printer driver dialog box. (See "Accessing the Printer Driver Dialog Box from Applications .") → P.164

3 Make sure the **Main** sheet is displayed.

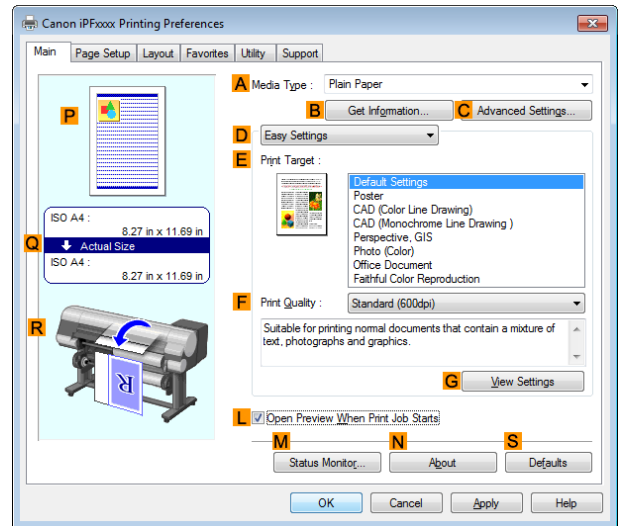

4 In the **A Media Type** list, select the type of paper that is loaded.



Note

- Click the **B Get Information** button to display the **Paper Information on Printer** dialog box. On the **Paper Information on Printer** dialog box, you can obtain information on the paper in the printer and configure printer driver settings for the feed source and type of paper. This function requires that the **Status Monitor** be installed.

5 Click the **Page Setup** tab to display the **Page Setup** sheet.

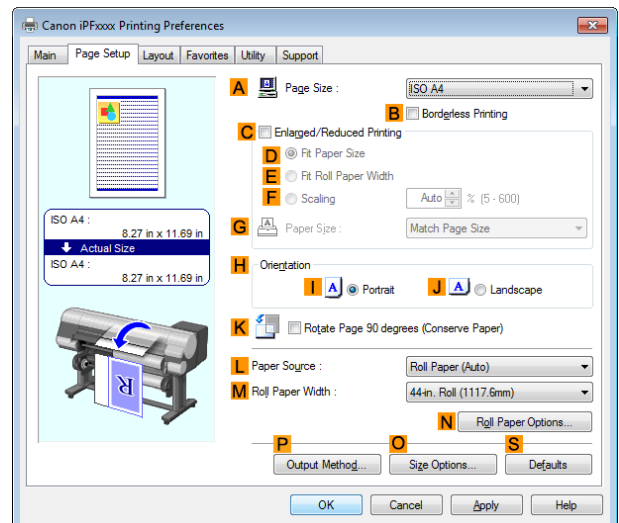

6 In the **A Page Size** list, select the size of the original as specified in the application.

7 In the **L Paper Source** list, select how paper is supplied.

8 If you have selected roll paper in **L Paper Source**, select the width of the loaded roll in **M Roll Paper Width**.



- A variety of settings are available in the printer driver to suit different printing applications. For details on available printing conditions, see "Printer Driver Settings ." →P.158

Confirming Print Settings

There are two ways to confirm the print settings, as follows.

- Checking a preview of the settings

A preview of the settings is displayed on the left side of the **Main**, **Page Setup**, and **Layout** sheets. By checking illustrations and numerical values in the preview, you can confirm current settings for the page size, orientation, paper source, layout, and so on.

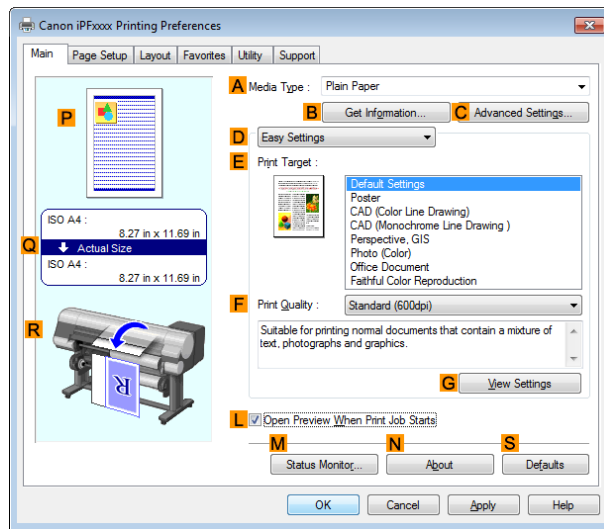

Display Area	Information Displayed
P Top illustrations	Illustrations indicate the orientation, page layout, borderless printing selection, color mode, and other settings information.
Q Middle, bordered area	The page size, paper size, and method and percentage of enlargement or reduction are indicated.
R Bottom illustrations	Illustrations indicate the feed source, orientation, borderless printing selection, and other settings information.



- To confirm the **Print Target** specified in **Easy Settings**, click **G View Settings** on the **Main** sheet to display the **View Settings** dialog box.

- Checking a print preview

You can check an image of the original just as it will be printed.

When you activate this feature, **imagePROGRAF Preview** or PageComposer is started before printing. Confirming how documents will be printed this way helps prevent printing errors.

For details on print previews, see "Checking the Layout in a Preview Before Printing." →P.145

Checking the Layout in a Preview Before Printing

This topic describes how to preview images of print jobs before actually printing them.

1 Choose **Print** in the application menu.

2 Select the printer in the dialog box, and then display the printer driver dialog box. (See "Accessing the Printer Driver Dialog Box from Applications .") →P.164

3 Make sure the **Main** sheet is displayed.

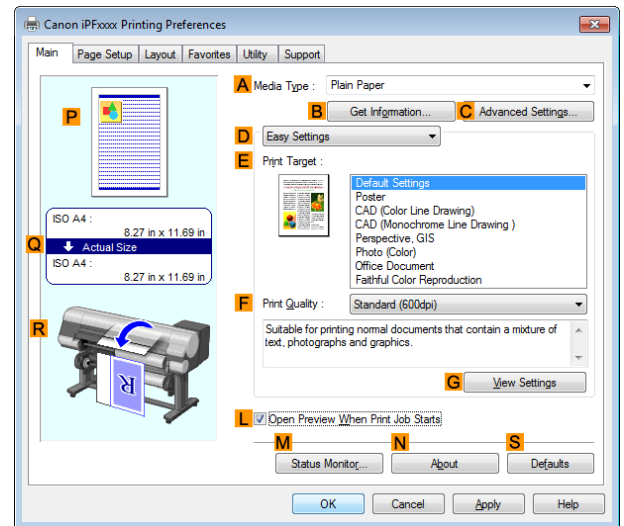

4 Select the **L Open Preview When Print Job Starts** check box.

5 After you click **OK**, when you print a job, the **imagePROGRAF Preview** window will be displayed.

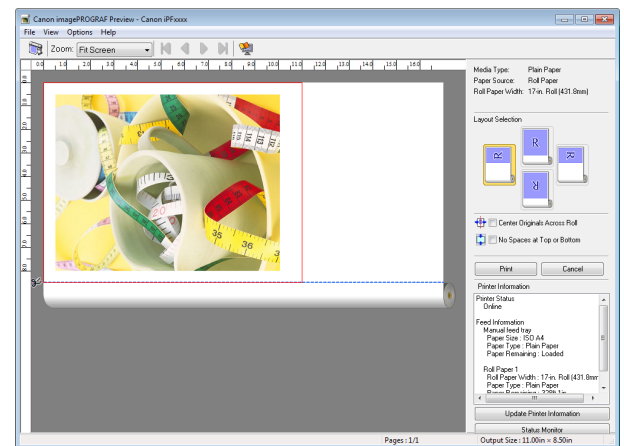

Note

- If PageComposer is running, access the **Special Settings** dialog box from the **Layout** sheet and clear **Preview Switching**.

6 On the main window, you can check the layout and change settings as needed.

7 To print, click **Print** in the **File** menu.



Note

- For details on **imagePROGRAF Preview** functions, see "Preview." →P.189

Using Favorites

This topic describes how to register favorites and print using favorite settings.

Registering a favorite

162

This section describes the procedure for registering printing settings that have been changed in the driver as **Favorites**.

1 Choose **Print** in the application menu.

2 Select the printer in the dialog box, and then display the printer driver dialog box. (See "**Accessing the Printer Driver Dialog Box from Applications** .") →P.164

3 Perform normal printing settings.
The favorite is registered from here.

4 Click the **Favorites** tab to display the **Favorites** sheet.

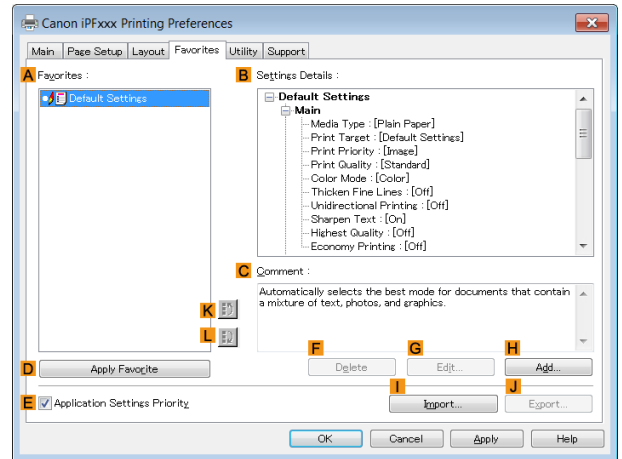

5 Click **Add** to display the **Add** dialog box.

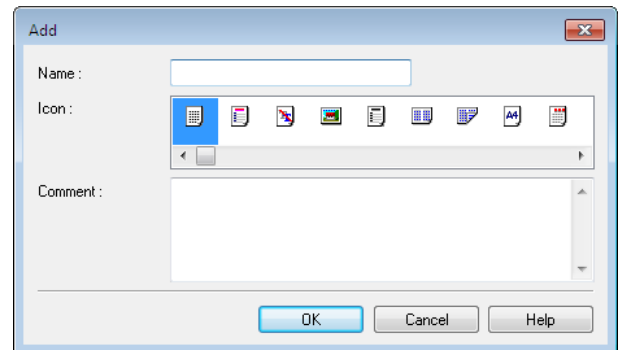

6 Enter a desired name in **Name**, such as **Photos for Presentations** or **Monthly Report**.

7 Choose a fitting icon for these print settings in the Icon list.

8 In **Comment**, enter a description of the favorite to be added, as desired.

9 Click **OK** to close the **Add** dialog box.
The favorite you have added is now displayed in **Favorites**.

 **Note** • To save a favorite as a file, click **Export** and specify the file to save.

Printing using the favorite

Follow the steps below to print using the favorite you have registered.

1 Choose **Print** in the application menu.

2 Select the printer in the dialog box, and then display the printer driver dialog box. (See "Accessing the Printer Driver Dialog Box from Applications .") →P.164

3 Click the **Favorites** tab to display the **Favorites** sheet.

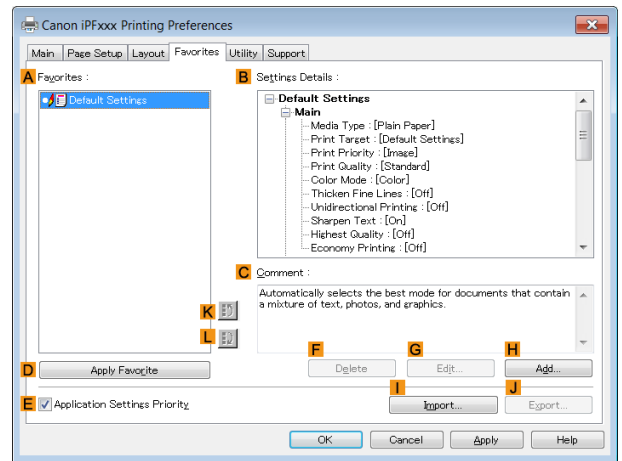

4 In the **A Favorites**, choose the favorite you registered.

 • To import a favorite, click **I Import** and specify the favorite file.

5 Click **D Apply Favorite** to replace the favorite settings with the current print settings.

6 Confirm the print settings and print as desired.

 • For instructions on confirming print settings, see "Confirming Print Settings ." →P.161

Accessing the Printer Driver Dialog Box from Applications

1 Choose **Print** from the **File** menu to display the dialog box for printing conditions.

2 Select the printer, and then display the printer driver dialog box.

 • The dialog box for specifying printing conditions varies depending on the source application. In some cases, when you select the printer, a sheet for configuring the printer driver is added to the dialog box. In the following case, click **Preferences**.

- Example: **Print** dialog box displayed by the application software

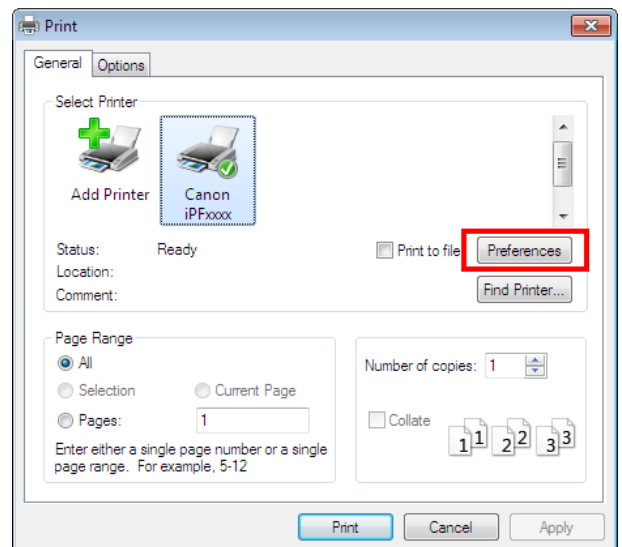

Six sheets of print settings are displayed by the printer driver: **Main**, **Page Setup**, **Layout**, **Favorites**, **Utility**, and **Support**.

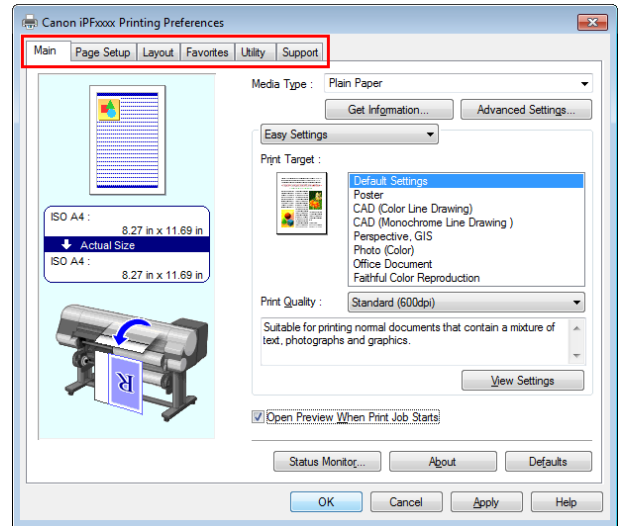

Note • The titles of dialog boxes may vary depending on the application, and sheets other than these six sheets may be displayed.

Important • If you access the printer driver dialog box from the source application, changes you make to the settings will only apply temporarily to that application. Because these are sizes you specify temporarily in the printer driver, the sizes will not be available after you exit the application.
• You can also access the printer driver dialog box from the Windows system menu. To use the settings continuously in all applications, open the printer driver from the system menu to make the settings. (See "Accessing the Printer Driver Dialog Box from the Operating System Menu .") →P.165

Accessing the Printer Driver Dialog Box from the Operating System Menu

1 Open the folder of the OS you are using for configuring printers. For example, on Windows 7, click the **start** button on the Desktop and open the **Devices and Printers** window.

2 Right-click the icon of this printer and choose **Printer Properties** to open the printer properties window.

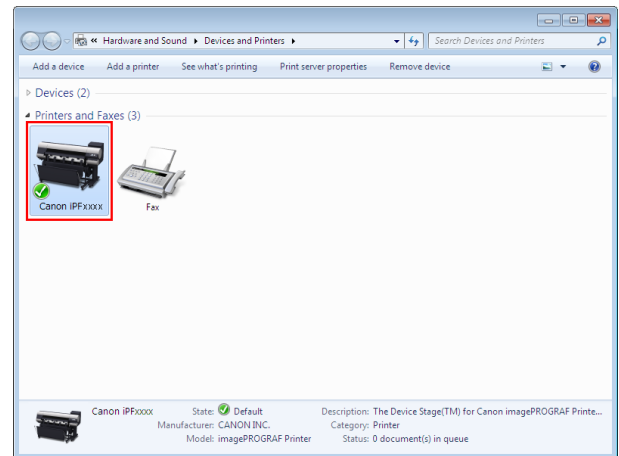

3 Click **Preferences** to display the **Printing Preferences** dialog box, titled with the name of this printer.

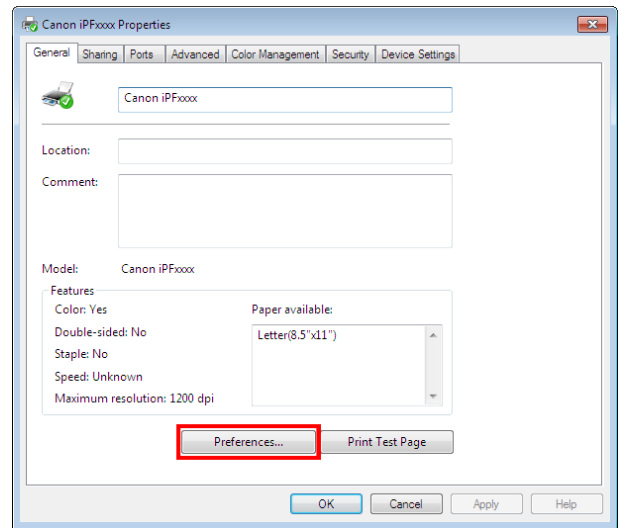

Note • The **Device Settings** sheet is also an extension of the printer driver. (See "Device Settings Sheet .") →P.188

Six sheets of print settings are displayed by the printer driver: **Main**, **Page Setup**, **Layout**, **Favorites**, **Utility**, and **Support**.

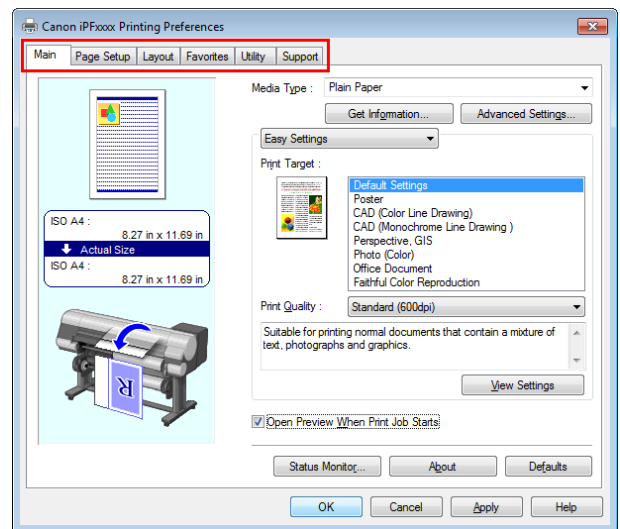

Important • If you access the printer driver dialog box from the operating system menu, changes you make to the settings will apply to all applications you use for printing.
• You can also access the printer driver dialog box from applications. (See "Accessing the Printer Driver Dialog Box from Applications .") →P.164

Main Sheet

The following settings are available on the **Main** sheet. For details on settings items, refer to the printer driver help file.

Note • On the **Main** sheet, choose **Easy Settings** to specify basic print settings based on the particular printing application, or switch to **Advanced Settings** to complete more detailed settings as desired.

Common Items

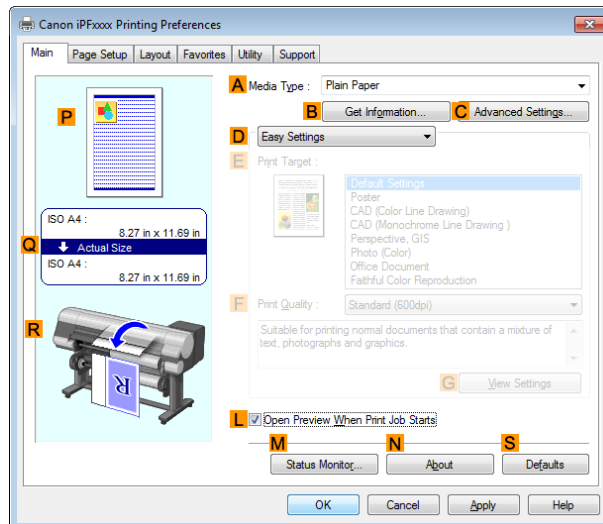

- **A Media Type**

Select the type of paper.

For information on the types of paper the printer supports, refer to the **Paper Reference Guide**. (See "Displaying the Paper Reference Guide.") →P.335

- **B Get Information**

Displays **Paper Information on Printer**. You can update the printer driver settings for the feed source, media type, and roll width by selecting the feed source.

- Paper Information on Printer Dialog Box →P.170

- **C Advanced Settings**

Displays **Paper Detailed Settings**. You can configure the printing settings to match the type of media, such as the ink drying time.

- Paper Detailed Settings Dialog Box →P.170

- **L Open Preview When Print Job Starts**

When the check box is selected, **imagePROGRAF Preview** is launched before printing.

This allows you to check on-screen previews of documents before printing.

- Checking the Layout in a Preview Before Printing →P.145

- **M Status Monitor**

Starts **imagePROGRAF Status Monitor**.

You can check the printer status, job status, and other conditions.

You can also set up email notification if printer errors occur by completing the **Email Notice** settings.

For details, refer to the **Status Monitor** help file.

- **N About**

Displays version information for the printer driver.

- **S Defaults**

Restores all settings on the sheet to the default values.

Configuration using **Easy Settings**

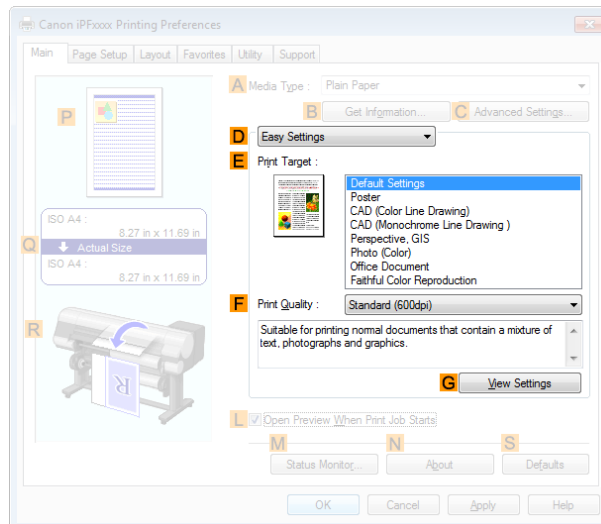

• **E Print Target**

Choose presets that match the type of document to be printed.

- **Printing Photos and Images** →P.43
- **Printing Line Drawings and Text** →P.52
- **Printing Office Documents** →P.47

Depending on the **A Media Type** setting, some **E Print Target** options may not be available.

• **F Print Quality**

Choose the level of print quality.

- **Giving Priority to Particular Graphic Elements and Colors for Printing** →P.66

• **G View Settings**

Displays the **E Print Target** setting values.

You can view and change the order of **E Print Target** setting values.

- **View Settings Dialog Box for the Printing Application** →P.172

Configuration using **Advanced Settings**

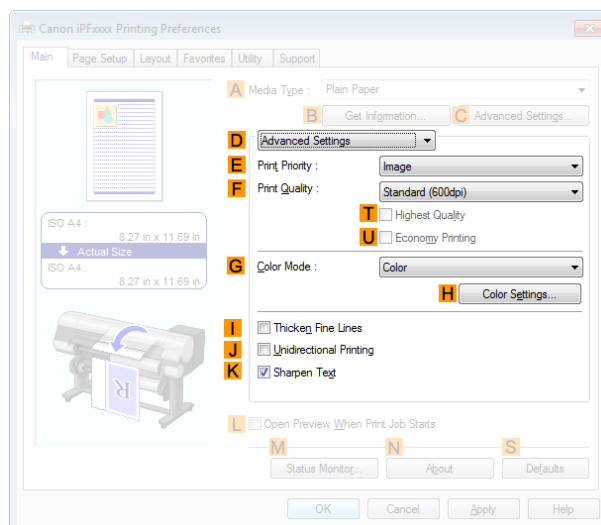

• **E Print Priority**

Choose the graphic elements that you want to emphasize for printing.

- **Giving Priority to Particular Graphic Elements and Colors for Printing** →P.66

- **F Print Quality**

Choose the level of print quality.

- Giving Priority to Particular Graphic Elements and Colors for Printing →P.66

- **T Highest quality**

When the check box is selected, printing is performing focusing on quality. Printing takes longer and consumes more ink than in other modes, but this mode offers superior printing quality.



Note

- If you set **F Print Quality** to **High**, you can select **T Highest quality**. However, depending on **A Media Type** and **E Print Priority**, you may not be able to select **T Highest quality**.

- **U Economy Printing**

If you select this option, you can print with less ink consumed. However, print quality is lower than in regular printing.

Select this option to save ink, such as when printing to check drawings. Depending on the settings of **A Media Type** and **F Print Quality**, you may not be able to select this option.



Note

- If you set **F Print Quality** to **Fast**, you can select **U Economy Printing**. However, depending on **A Media Type** and **E Print Priority**, you may not be able to select **U Economy Printing**.

- **G Color Mode**

Choose the color mode.

- Giving Priority to Particular Graphic Elements and Colors for Printing →P.66



Note

- Depending on the **A Media Type** setting, some **G Color Mode** options may not be available.

- **H Color Settings**

Click to display the **Color Settings** dialog box for more advanced color settings.

- Adjusting the Color in the Printer Driver →P.60

- **I Thicken Fine Lines**

Select this option to print fine lines more distinctly.

- **J Unidirectional Printing**

Select this checkbox to prevent problems such as misaligned lines and improve the print quality. However, the printing speed becomes slower.

Paper Information on Printer Dialog Box

On the **Paper Information on Printer** dialog box, you can obtain information on the paper in the printer and configure printer driver settings for the paper source and media type.

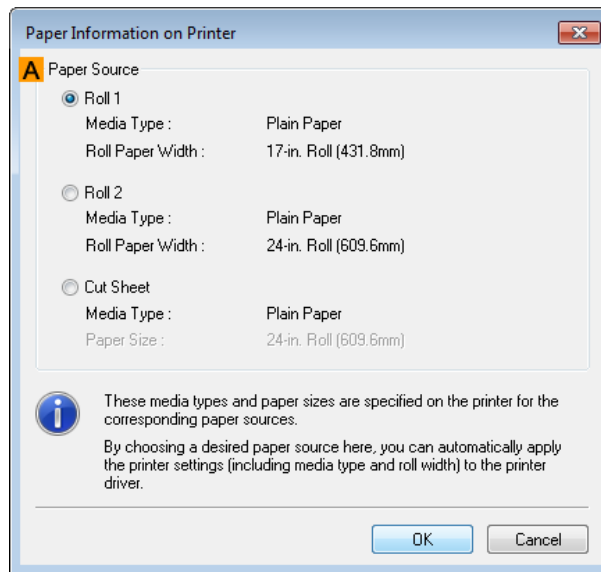

Note

- To display the **Paper Information on Printer** dialog box, on the **Main** sheet, click **Get Information by Media Type**. (See "Main Sheet .") →P.166

• A Paper Source

Shows the paper source supported by the printer, as well as information about the loaded paper. To update the paper source and media type settings in the printer driver, select the desired **Paper Source** option and click **OK**.

Paper Detailed Settings Dialog Box

In the **Paper Detailed Settings** dialog box, you can set **Drying Time** for the paper selected with **Media Type** of the **Main** sheet, etc.

You can display this dialog box by clicking **Advanced Settings** of **Media Type** on the **Main** sheet. (See "Main Sheet .") →P.166

As for the items for which you can select **Printer Default** in this dialog box, you also can set them from the control panel of the printer. (See "Menu Settings.") →P.449

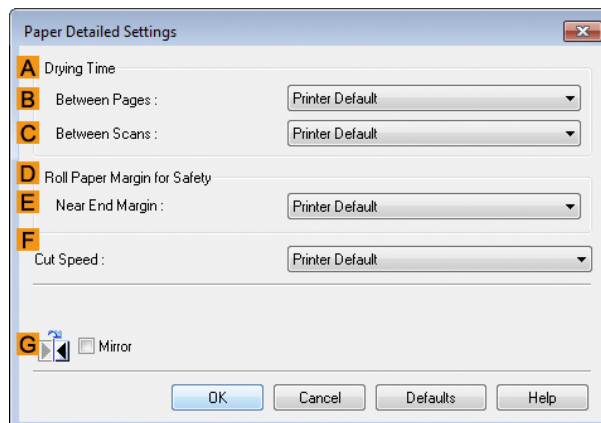

A Drying Time

Specify the time that the printer waits for ink to dry, as needed. The **Between Pages** setting is only valid for rolls.

B Between Pages

You can set the time to wait after printing 1 document page until ejecting the paper. Since waiting time is required for ink to dry before a roll is cut, you can deliver paper in the Output Stacker with the ink dried even if **Cutting Mode** is set to **Automatic**.

Setting Item	Details
Printer Default	The setting of the control panel of the printer is applied.
Off	Paper is ejected immediately after printing completes.
30 sec. / 1 min. / 3 min. / 5 min. / 10 min. / 30 min. / 60 min.	Paper is ejected when the set time elapses after printing completes.

C Between Scans

You can set the time to wait after printing 1 line on a page until printing the next line. Set this to avoid bleeding or color unevenness such as when bleeding occurs on a page or when color unevenness occurs during borderless printing.

Setting Item	Details
Printer Default	The setting of the control panel of the printer is applied.
Off	The next line is printed immediately after a line is printed.
1 sec. / 3 sec. / 5 sec. / 7 sec. / 9 sec.	The next line is printed when the set time elapses after a line is printed. * Increase the time according to the occurrence condition of bleeding or unevenness.

D Roll Paper Margin for Safety

You can specify the length of a margin on the leading edge of paper to ensure that paper susceptible to curling is held firmly against the Platen.

E Near End Margin

Specify the length of the **Near End Margin** (the leading edge margin) of the roll, as needed.

Setting Item	Details
Printer Default	The setting of the control panel of the printer is applied.
3 mm (0.12 in)	The document is printed in the standard size. * Select this when you do not have any problems in printing.
20 mm (0.8 in)	Select this when rubbing against the printhead occurs such as when using paper that tends to curl.

F Cut Speed

Select the speed of automatic cutting, as needed. You can adjust this setting if paper is not cut well when automatic cutting is used.

Setting Item	Details
Printer Default	The setting of the control panel of the printer is applied.
High Speed	When the Standard setting does not result in cutting the surface cleanly, select this.
Standard	Select this when you do not have any problems in automatic cutting.
Low Speed	This helps prevent adhesive from sticking to the cutter and keeps the cutter sharp if you select it when using adhesive paper.

G Mirror

Specify whether to print a mirror image, as needed. Select this option to print a version of the document or image with the left and right sides inverted.

View Settings Dialog Box for the Printing Application

In the **View Settings** dialog box, you can check details of the selected printing application.

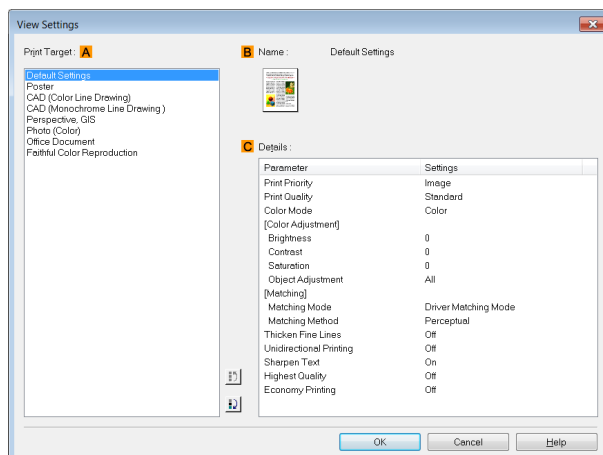

Note

- To display the **View Settings** dialog box, on the **Main** sheet, click **View Settings** by **Print Target**. (See "Main Sheet .") →P.166

- A Print Target**

Shows all **Print Target** options (settings items for the printing application).

- B Name**

Identifies the item selected in **Print Target** by its name and an icon.

- C Details**

Here, you can confirm detailed settings values for each listed item for the selected **Print Target**.

Color Adjustment Sheet: Color

If the color tone as printed is not as you expected, you can adjust it on the **Color Adjustment** sheet.

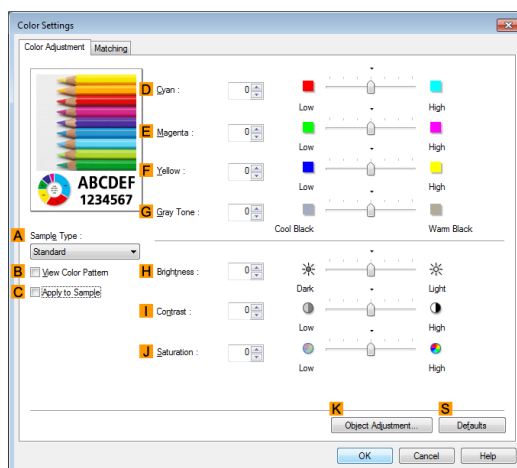

Note

- To display the **Color Adjustment** sheet, on the **Main** sheet, click **Color Settings** by **Color Mode** in **Advanced Settings**. (See "Main Sheet .") →P.166

- A Sample Type**

Choose a sample image from **Standard**, **Portrait**, **Landscape**, or **Graphics**.

- B View Color Pattern**

Select this checkbox to display the color pattern.

- **C Apply to Sample**

Select this checkbox to apply the changed settings to the sample image.

- **D Cyan/E Magenta/F Yellow**

Fine-tune color tones by adjusting the levels of each color.

- **G Gray Tone**

Adjust the color tone of grays as desired. Choose **Cool Black** (tinged with blue) or **Warm Black** (tinged with red).

- **H Brightness**

Adjust the overall image brightness as desired. You can adjust the brightness if the printed document is lighter or darker than the original image (that is, the original photo that was scanned or the original graphic as it appears on the computer screen).

- **I Contrast**

Adjust the contrast of the darkest and lightest portions relative to each other, as desired. Increasing the **Contrast** makes images sharper, and reducing the **Contrast** softens images.

- **J Saturation**

Adjust the color intensity as desired. Increasing the **Saturation** setting makes colors more vivid, and reducing the **Saturation** makes colors more subdued.

- **K Object Adjustment**

Select this option to display the **Object Adjustment** dialog box, in which you can specify objects subject to color adjustment.

- Object Adjustment Dialog box: Color → P.173

- **S Defaults**

Click to restore all settings on the sheet to the default values.



Note

- For details on settings items, see "Adjusting the Color in the Printer Driver." → P.60

Object Adjustment Dialog box: Color

In the **Object Adjustment** dialog box, you can specify what type of print jobs to apply color adjustment to. If an original comprises images, graphics, and text, you can specify which portion to apply color adjustment to.

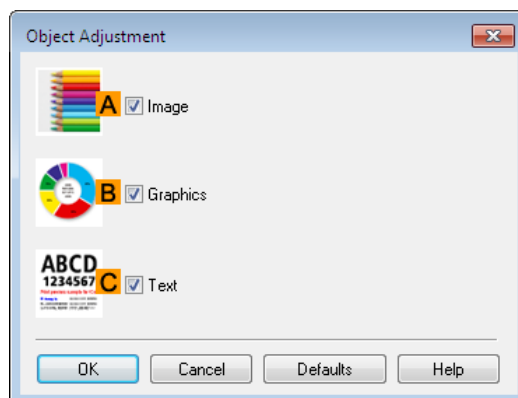

Note

- To display the **Object Adjustment** dialog box, click **Object Adjustment** on the **Color Adjustment** sheet.

- **A Image**

Select this option to apply color adjustment to image areas, such as photos.

- **B Graphics**

Select this option to apply color adjustment to graphics, such as lines and circles.

- **C Text**

Select this option to apply color adjustment to text.

Matching Sheet

On the **Matching** sheet, you can specify color matching to compensate for differences in the appearance of colors on various devices.



Important

- If **No color correction** is selected under **Color Mode**, the **Matching** sheet is not displayed.



Note

- To display the **Matching** sheet, on the **Main** sheet, click **Color Settings** in **Color Mode** in **Advanced Settings**, and then click the **Matching** sheet. (See "Main Sheet .") →P.166

Driver Matching Mode

The following options are available when you select **Driver Matching Mode** in the **A Matching Mode** list.

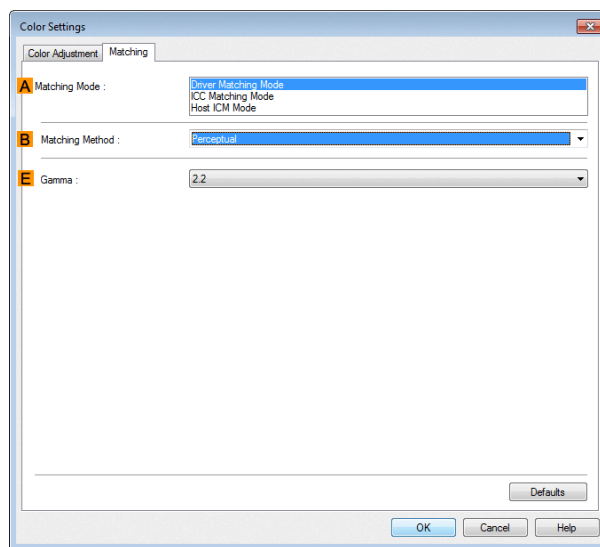

- **A Matching Mode**

Select the color matching mode to use, as desired.

Normally, select **Driver Matching Mode**. For color matching based on ICC profiles, select **ICC Matching Mode** or **Host ICM Mode**, depending on your color matching system.

- **B Matching Method**

Select the color matching method that suits the document to be printed. Various **Matching Method** options are available depending on your selection in **Matching Mode**.

- **E Gamma**

You can adjust the gradation of intermediate tones in an image.

2.2 is normally selected. If you want a softer impression than **2.2**, select **1.8**.

ICC Matching Mode and Host ICM Mode

The following options are available when you select **ICC Matching Mode** or **Host ICM Mode** in the **Matching Mode** list.

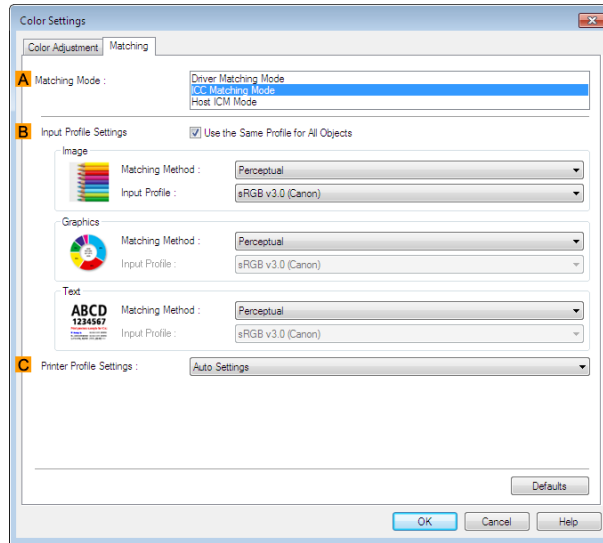

• **A Matching Mode**

Select the color matching mode to use, as desired.

• **B Input Profile Settings**

You can select **Image**, **Graphics**, or **Text**. You can choose **Matching Method** and **Input Profile**. Various options are available depending on your selected **Matching Mode**.

To apply the same input profile automatically for **Graphics** and **Text**, select **Use the Same Profile for All Objects**. To apply separate input profiles to **Graphics** and **Text**, clear **Use the Same Profile for All Objects** and specify the individual settings.

• **C Printer Profile Settings**

Specify the printer profile as desired. Normally, select **Auto Settings**.

We recommend that you select an ICC profile created using commercially available profile creation software in order to perform color management accurately on paper other than genuine Canon paper and feed confirmed paper.

The created ICC profile needs to be saved in the following folder on the computer you are using.

C:\Windows\system32\spool\drivers\color folder



• C: may vary according to the user environment.

Note



• For details on settings items, see "Adjusting the Color in the Printer Driver." → P.60

Note

Color Adjustment Sheet: Monochrome

On the **Color Adjustment** sheet for monochrome printing, you can adjust the brightness and contrast.

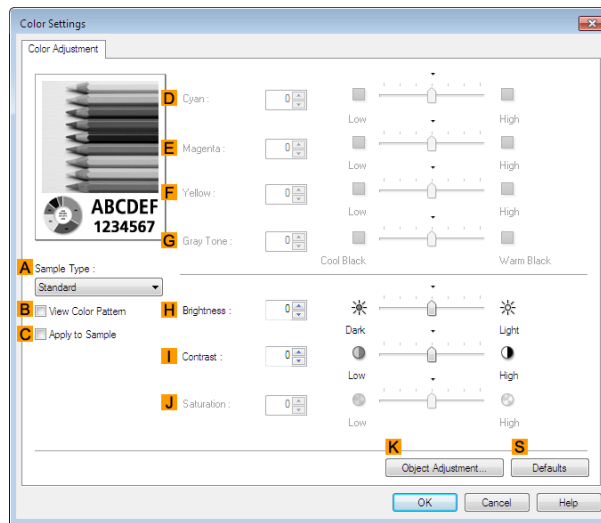

- To display the **Color Adjustment** sheet, on the **Main** sheet, click **Color Settings** by **Color Mode** in **Advanced Settings**. (See "Main Sheet .") →P.166

• **A Sample Type**

Choose a sample image from **Standard**, **Portrait**, **Landscape**, or **Graphics**.

• **B View Color Pattern**

Select this checkbox to display the color pattern.

• **C Apply to Sample**

Select this checkbox to apply the changed settings to the sample image.

• **D Cyan/ E Magenta/ F Yellow**

Not available.

• **G Gray Tone**

Not available.

• **H Brightness**

Adjust the overall image brightness as desired. You can adjust the brightness if the printed document is lighter or darker than the original image (that is, the original photo that was scanned or the original graphic as it appears on the computer screen).

• **I Contrast**

Adjust the contrast of the darkest and lightest portions relative to each other, as desired. Increasing the **Contrast** makes images sharper, and reducing the **Contrast** softens images.

• **J Saturation**

Not available.

• **K Object Adjustment**

Select this option to display the **Object Adjustment** dialog box, in which you can specify objects subject to color adjustment.

- Object Adjustment Dialog box: **Monochrome** →P.177

• **S Defaults**

Click to restore all settings on the sheet to the default values.





- For details on settings items, see "Adjusting the Color in the Printer Driver." →P.60

Note

Object Adjustment Dialog box: Monochrome

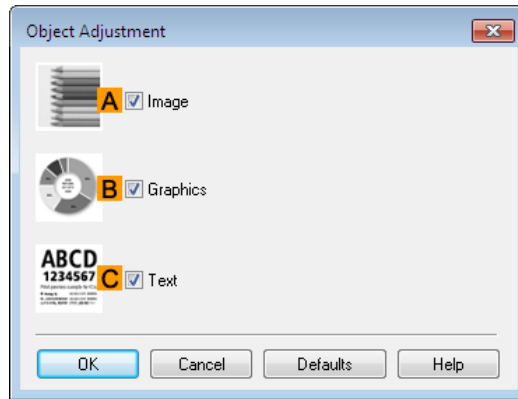
In the **Object Adjustment** dialog box, you can specify what type of print jobs to apply color adjustment to. If an original comprises images, graphics, and text, you can specify which portion to apply color adjustment to.



 **Note** • To display the **Object Adjustment** dialog box, click **Object Adjustment** on the **Color Adjustment** sheet.

- **A Image**

Select this option to apply color adjustment to image areas, such as photos.

- **B Graphics**

Select this option to apply color adjustment to graphics, such as lines and circles.

- **C Text**

Select this option to apply color adjustment to text.

Page Setup Sheet

The following settings are available on the **Page Setup** sheet. For details on settings items, refer to the printer driver help file.

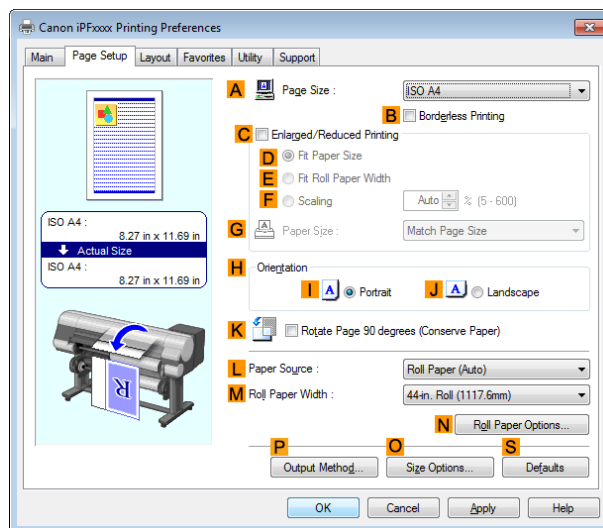

- **A Page Size**

Select the page size as specified in the source application.

For details on available page sizes, see "Paper Sizes." →P.332

- **B Borderless Printing**

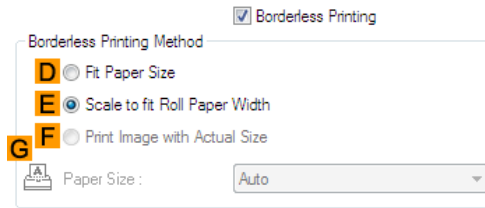

Borderless printing is available if roll paper is selected in the **L Paper Source** list. Choose from the following options when this setting is activated.

- **Borderless Printing on Paper of Equivalent Size** →P.92
- **Borderless Printing by Resizing Originals to Fit the Roll Width** →P.95
- **Borderless Printing at Actual Size** →P.87

- **D Fit Paper Size**

Scales the document image to match the paper size.

- **E Scale to fit Roll Paper Width**

Scales the document image to match the roll width.

- **F Print Image with Actual Size**

Prints documents at their actual size. This function is available when you have selected the size same as the width of **Roll Paper** for either the length or width of the document from the **A Page Size** list.

- **G Paper Size**

Available when **D Fit Paper Size** is selected.

Choose the size of the paper you will print on.

For details on available paper sizes, see "Paper Sizes." →P.332

Paper sizes compatible with borderless printing are shown in the list.

- **C Enlarged/Reduced Printing**

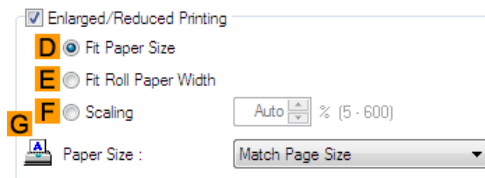

Choose from the following options when this setting is activated.

- **Resizing Originals to Match the Paper Size** →P.72
- **Resizing Originals to Fit the Roll Width** →P.74
- **Resizing Originals by Entering a Scaling Value** →P.78

- **D Fit Paper Size**

Scales the document image to match the paper size.

- **E Fit Roll Paper Width**

Scales the document image to match the roll width.

- **F Scaling**

Resizes the document image based on a specified scaling value. Enter a value in a range of **5–600**.

- **G Paper Size**

Choose the size of the paper you will print on.

For details on available paper sizes, see "Paper Sizes." →P.332

- **H Orientation**

Choose the printing orientation.

- **Making the Original Orientation Match the Paper Orientation** →P.148

- **K Rotate Page 90 degrees (Conserve Paper)**

Activate this setting to rotate the document image by 90 degrees before printing.

- **Conserving Roll Paper by Rotating Originals 90 Degrees** →P.137

- **L Paper Source**

Choose the feed source, as desired.

Options displayed in the list vary depending on the selection in **Media Type** on the **Main** sheet.

- **M Roll Paper Width**

Choose the roll width.

For details on available roll widths, see "Paper Sizes." →P.332

- **N Roll Paper Options**

Complete optional roll paper settings. Click to display the **Roll Paper Options** dialog box.

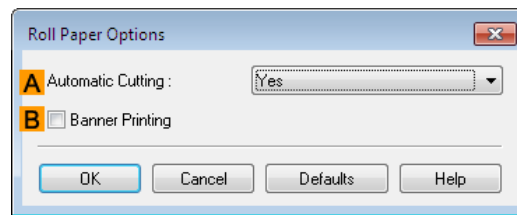

Under **A Automatic Cutting**, you can specify **Yes** or **No** and **Print Cut Guideline**.

- **Cutting Roll Paper After Printing** →P.152

Select **B Banner Printing** when printing multiple pages continuously.

- **Printing Multiple Pages Continuously** →P.118

- **P Output Method**

Click to display the **Output Method** dialog box, which enables you to complete the **Output Method** and **Name of data to be saved** settings.

- **Output Method Dialog box** →P.180

- **O Size Options**

Click to display the **Paper Size Options** dialog box, which enables you to register additional paper sizes or select the size system for use.

- **Paper Size Options Dialog Box** →P.181

- **S Defaults**

Restores all settings on the sheet to the default values.

Output Method Dialog box

The **Output Method** dialog box allows you to select the **Output Method** and set the save settings when saving to the box.

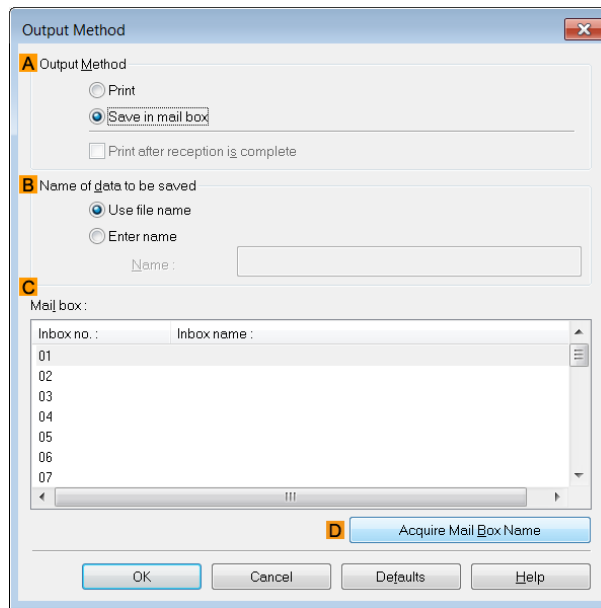

Note

- To display the **Output Method** dialog box, on the **Page Setup** sheet, click **Output Method**. (See "Page Setup Sheet.") →P.177

• **A Output Method**

If **Print** is selected, the print job is saved to the printer hard disk after printing has finished.

If **Save in mail box** is selected, the print job is saved to the printer hard disk. If you choose **Save in mail box**, also specify the destination personal box in the **Mail box** list.

If **Print after reception is complete** is checked, you can prevent degradation of print quality that occurs when receiving a print job is interrupted and printing is aborted in the middle.

These can be selected as **Print** options.

• **B Name of data to be saved**

To use the file name, choose **Use file name**.

Otherwise choose **Enter name** and enter a name in **Name**.

• **C Mail box**

Displays a list of mail boxes. If you choose **Save in mail box**, also specify the destination personal box from the list.

• **D Acquire Mail Box Name**

When this is clicked, the box name acquired from the printer main unit is displayed in **Mail box**.

Paper Size Options Dialog Box

In the **Paper Size Options** dialog box, you can create and register your own Custom Paper Size. The sizes you define are listed with standard paper sizes for selection later as needed.

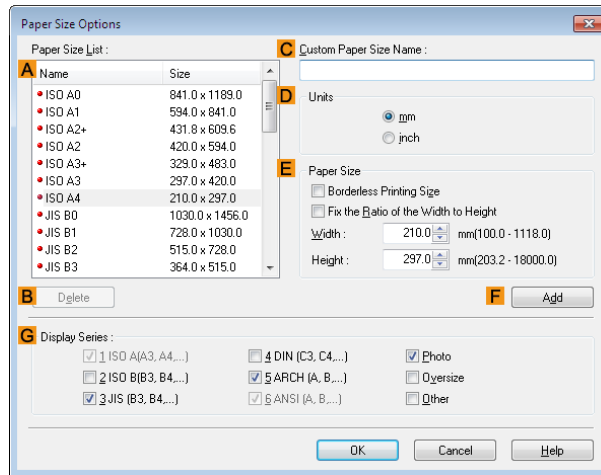

Important

- You cannot create any arbitrary roll paper width as a Custom Paper Size.
- If you select a **Paper Size** from **Paper Size Options**, load paper of a size equal to or larger than the **Paper Size Options** into the printer. If the size of the loaded paper is smaller than the **Paper Size Options**, an incomplete output image may be printed.



Note

- To display the **Paper Size Options** dialog box, on the **Page Setup** sheet, click **Paper Size Options**. (See "Page Setup Sheet .") →P.177

A Paper Size List

Shows the names and sizes of paper that can be used with the printer driver.

B Delete

Custom paper sizes created by users can be deleted from the **A Paper Size List**, as needed. However, they cannot be deleted in the following situations.

- If a standard paper size of the printer driver is selected.
- If an oversized paper size is selected.
- If a paper size marked with a red circle is selected.

C Custom Paper Size Name

You can name Custom Paper Size as desired.

D Units

Specify the desired unit of measure for the Custom Paper Size height and width.

E Paper Size

Specify the desired **Width** and **Height**. You can make your selection from sizes that are compatible with **Borderless Printing** by selecting **Borderless Printing Size**. To maintain the aspect ratio of the **Width** and **Height** as you resize the paper, select **Fix the Ratio of the Width to Height**.

F Add

Enables you to register the custom paper size you have specified or overwrite an existing custom paper size.

G Display Series

You can limit the number of options shown in **Page Size**, **Paper Size**, and **Paper Size List**.

Layout Sheet

The following settings are available on the **Layout** sheet. For details on settings items, refer to the printer driver help.

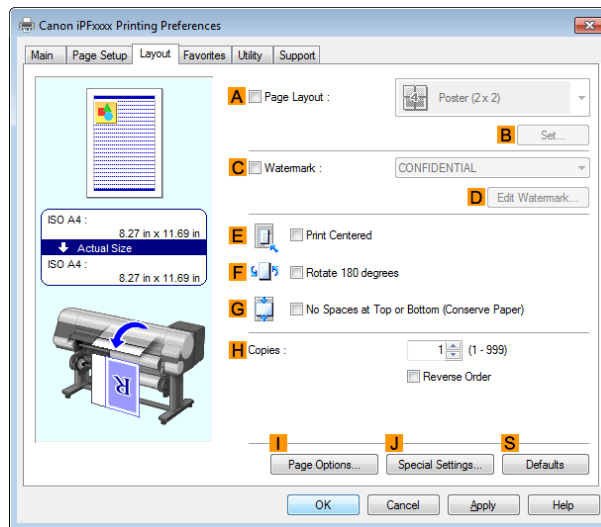

• **A Page Layout**

Activate this setting to select a particular page layout.

- **Printing Multiple Pages Per Sheet** →P.121
- **Printing Posters in Sections** →P.126
- **Printing Multiple Originals Next to Each Other** →P.114
- **Using PosterArtist to Compose Originals** →P.50

• **B Set**

Click to display one of the following dialog boxes depending on the selection in **A Page Layout**. In these dialog boxes, you can specify layout details and which pages to print, as well as other settings.

- **Page Layout Printing**
- **Pages to Print**
- **Free Layout Settings**

• **C Watermark**

Activating this option makes two settings available, **Watermarks** and **D Edit Watermark**.

- **Printing With Watermarks** →P.146
- **Watermarks**
Lists the provided watermarks. Choose the watermark to print.

• **D Edit Watermark**

Click to display the **Edit Watermark** dialog box for creating your own, original watermark.

• **E Print Centered**

Activate this setting to print document images in the center of the paper.

- **Printing Originals Centered on Rolls** →P.128
- **Printing Originals Centered on Sheets** →P.132

• **F Rotate 180 degrees**

Activate this option to rotate document images by 180 degrees before printing.

• **G No Spaces at Top or Bottom (Conserve Paper)**

Activate this setting to print the next image skipping blank areas above and below printable data in documents, which enables you to conserve the paper.

- **Conserving Roll Paper by Printing Originals Without Top and Bottom Margins** →P.140

• **H Copies**

Enter the number of copies to print, in a range of **1–999**.

• **Reverse Order**

Activate this option to print pages in reverse order.

• **I Page Options**

Click to display the **Page Options** dialog box, which enables you to complete settings for printing the user name, date, or page number in the header or footer.

• **Page Options Dialog Box** →P.183

• **J Special Settings**

If the printing results are not as you expected, click this option to display the **Special Settings** dialog box and change how printing is processed.

• **Special Settings Dialog Box** →P.184

• **S Defaults**

Click to restore all settings on the sheet to the default values.

Page Options Dialog Box

The **Page Options** dialog box offers the following settings.

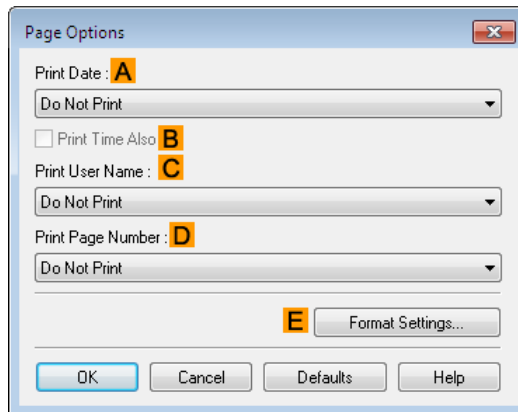

• To display the **Page Options** dialog box, on the **Layout** sheet, click **Page Options**. (See "Layout Sheet .") →P.182

• **A Print Date**

Select where the date is printed, as desired. To print the time as well, select **B Print Time Also**.

• **C Print User Name**

Select where the user name is printed, as desired.

• **D Print Page Number**

Select where the page number is printed, as desired.

• **E Format Settings**

Click to display the **Format Settings** dialog box, which enables you to complete format-related settings.

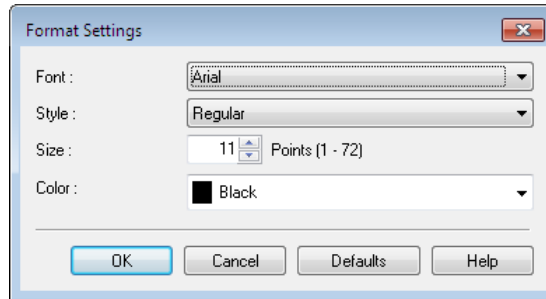

Note

- If you specify the same position for multiple items, the items are printed from left to right in this order: date, user name, and page number.
- When you print multiple pages per sheet using **Page Layout Printing** or similar functions, these items will be printed for each page.

Special Settings Dialog Box

If the printing results are not as you expected, you can change how printing is processed in the **Special Settings** dialog box.

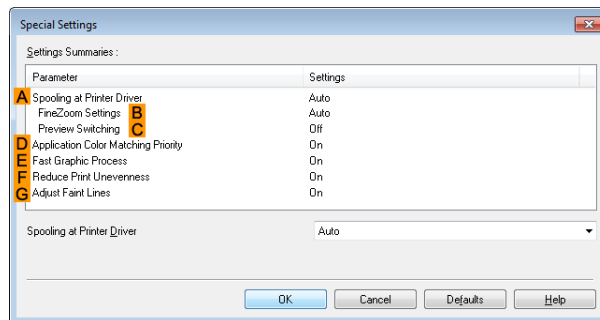

Note

- To display the **Special Settings** dialog box, on the **Layout** sheet, click **Special Settings**. (See "Layout Sheet .") →P.182
- Click the processing method for **Parameter** within the **Settings Summaries** frame to display a list of the setting details under the frame.

• **A Spooling at Printer Driver**

Sets whether or not print jobs are spooled in the printer driver and processed by PageComposer. Printing results may be improved in some cases by setting this to **No** or **No (EMF Spooling)**.



Note

- When set to **No** or **No (EMF Spooling)**, functions such as **Page Layout**, **Watermark**, **Reverse Order**, **Page Options**, **FineZoom Settings**, and **Preview Switching** can no longer be used.

• **B FineZoom Settings**

This function is used in large-format printing. If it is set to **Yes**, problems in the printing may be improved. If it is set to **No**, image distortions such as fine lines disappearing may be improved.

• **C Preview Switching**

When this setting is turned on, PageComposer starts when printing is performed with the **Open Preview When Print Job Starts** check box selected in the **Main** sheet.

• **D Application Color Matching Priority**

When this is on, you can give applications priority in color management.

• **E Fast Graphic Process**

Turning this setting on may help produce the expected results if image colors are inconsistent in printed documents or if lines are printed in varying thicknesses.



Note

- This function cannot be used on 64-bit version of Windows.

• **F Reduce Print Unevenness**

If you want to reduce unevenness of the printed image, turn this on to improve the print result. However, printing may take longer for some images.

• **G Adjust faint lines**

Turn this off to obtain expected results when fine lines have been printed in a color different from other diagrams and illustrations. However, lines in some colors may appear broken.

Favorites Sheet

The following settings are available on the **Favorites** sheet. For details on settings items, refer to the printer driver help.

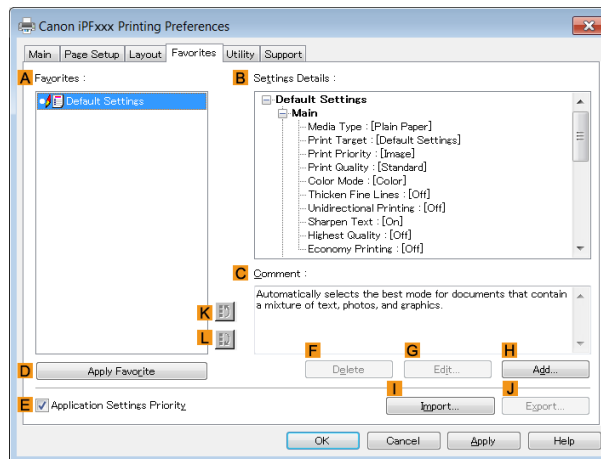

• **A Favorites**

Printing favorites you have created are listed with **Default Settings** favorites.

- Using Favorites → P.152

• **B Settings Details**

Displays details of the favorite selected in the **A Favorites**.

• **C Comment**

Displays notes registered in the favorite.

• **D Apply Favorite**

Click to change the current print settings to those of the favorite selected in the **A Favorites**.

• **E Application Settings Priority**

Activate this setting to use settings values specified in the source application in preference to favorite settings selected in the **A Favorites**, when clicking **D Apply Favorite**. For details on the settings items used in preference, refer to the printer driver help.

• **F Delete**

Click to delete the selected favorite from the **A Favorites** list.

• **G Edit**

Click to display the **Edit** dialog box, which enables you to change the name and icon for the favorite selected in the **A Favorites** list.

- **H Add**

Click to display the **Add** dialog box, which enables you to add the current print settings as a favorite.

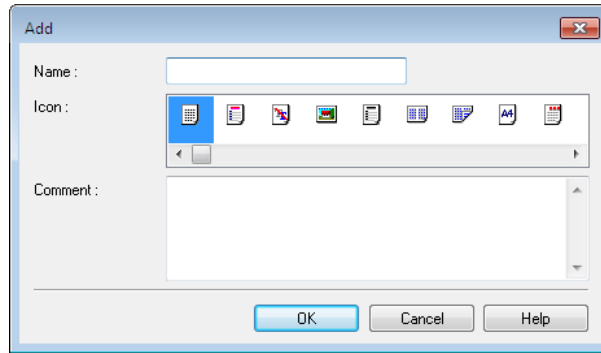

- **I Import**

Click to display the **Open** dialog box, which enables you to import favorite settings saved as a file.

- **J Export**

Click to display the **Save As** dialog box, which enables you to save the favorite settings as a file.

- **K Up**

Click to move the selected favorite up in the **A Favorites** list.

- **L Down**

Click to move the selected favorite down in the **A Favorites** list.

Utility Sheet

The following items can be executed on the **Utility** sheet. For details on the utilities, refer to the relevant utility help.

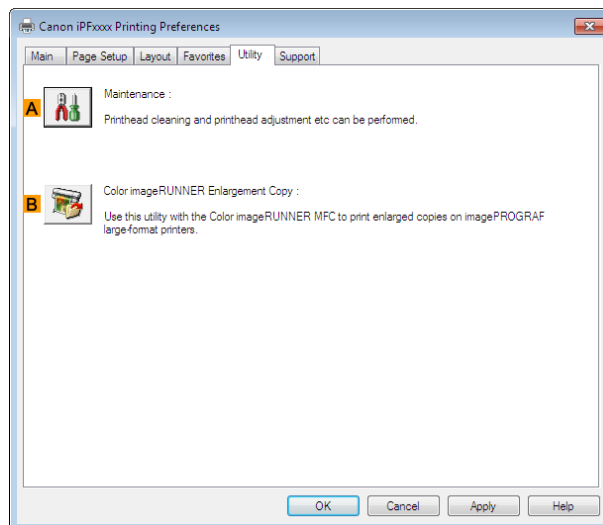

- **A Maintenance**

Click to start the **imagePROGRAF Status Monitor**, which offers the following maintenance for the printer.

- Nozzle (ink ejecting outlet) check
- Nozzle (ink ejecting outlet) cleaning
- Head alignment adjustment
- Feed amount adjustment

- **B Color imageRUNNER Enlargement Copy**

Click to launch **Color imageRUNNER Enlargement Copy** (iR enlargement copy), which enables you to create hot folders used for **Color imageRUNNER Enlargement Copy** and assign print settings to hot folders.

- **Printing Enlargements of Scanned Originals from a Color imageRUNNER** → P.229

For details, see "Color imageRUNNER Enlargement Copy." → P.221

 • **Color imageRUNNER Enlargement Copy** is not displayed in 64-bit editions of Windows.

Note

Support Sheet

On the **Support** sheet, you can view support information and the user's manual.

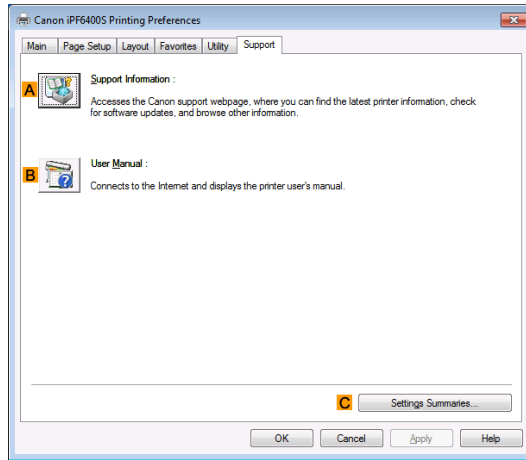

- **A Support Information**

Click to access the Canon support webpage, where you can find the latest information on the printer and consumables, check for printer driver updates, and browse other information.

- **B User Manual**

Click to connect to the Internet and display the printer user's manual.

- **C Settings Summaries**

Click to display the **View Settings** dialog box, which enables you to confirm the settings for the **Main**, **Page Setup**, **Layout**, and **Favorites** sheets.

Settings Summaries Dialog Box

The **Settings Summaries** dialog box enables you to confirm the settings for the **Main**, **Page Setup**, **Layout**, and **Favorites** sheets.

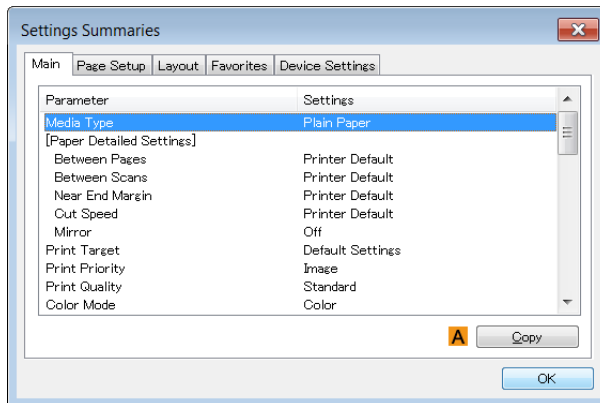

- **A Copy**

Click to copy the settings information to the clipboard. You can paste the settings information into a file created with a text editor or similar application.

Device Settings Sheet

Many settings items on the printer properties sheets are controlled by Windows applications. However, the **Device Settings** sheet is for configuring the printer, and it is an extension of the printer driver. The following settings are available on the **Device Settings** sheet.

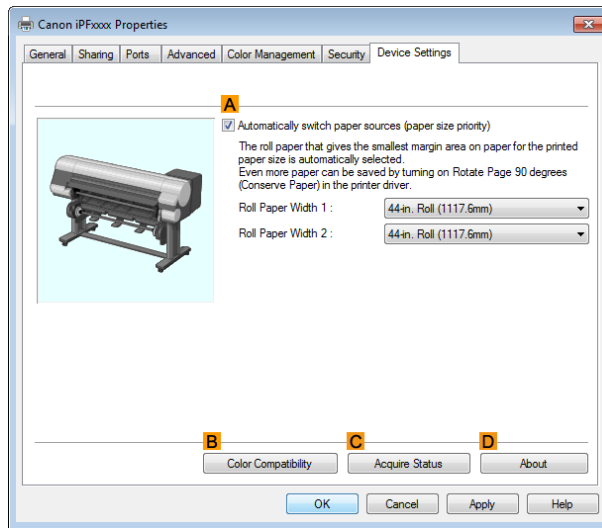

- **A Automatically switch paper sources (paper size priority)**

When turned on, printing is performed by automatically switching between roll paper 1 and roll paper 2 to minimize the roll paper margins depending on the paper size being printed.

Always check "Printing by Automatically Switching Between Upper and Lower Roll Paper " →P.32 before using the function.

- **B Color Compatibility**

Click to display the **Color Compatibility** dialog box, which enables you to adjust colors if you have selected **Color Mode > Color (CAD)**.

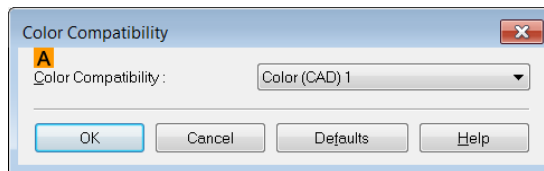

- For details on color settings, see "Specifying Colors and Printing CAD Drawings." →P.57

- **C Acquire Status**

The paper size information is acquired from the printer, and the width of the roll paper that is actually loaded in the printer is displayed.

- **D About**

You can display version information for the printer driver.

Preview

- The Features of Preview 189
- Starting Preview 189
- Preview Main Window 190
- Dialog Area 192
- Enlarge/Reduce the screen display 193
- Moving a Page 193
- Using the ruler 193
- Priority setting for rotating 90 degrees 194
- Printing with Selecting the Layout 195
- Print on the Center 197
- Not Print Spaces at the Top/Bottom 198

The Features of Preview

The main features of Preview are as follows.

- While viewing this screen, you can adjust layout settings of a document created with application software.
- You can not only adjust layout settings but also your changes will be instantly applied on the preview screen, and you can print the preview screen as it is seen.

 • The media type, image size, detailed media settings, and the printer settings can cause the actual print output to differ from the Preview settings.

Starting Preview

Follow the procedure below to start the Preview.

- 1** Start the application software which you use.
- 2** From the application software's **File** menu, select the printer setup menu to open the **Print** dialog box.

 • Normally, select **Print** from the **File** menu.

- 3** On the **Main** sheet, click on the **Open Preview When Print Job Starts** check box. Click the **OK** button to save the settings.

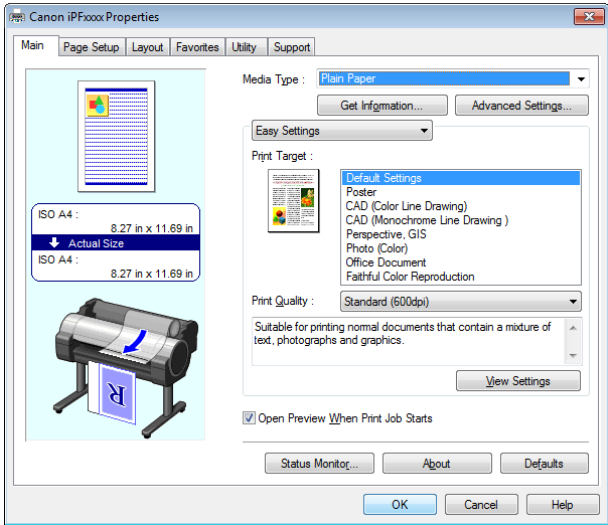

 • Your printer is depicted in the lower-left area of this screen.

- 4 On the **Print** dialog box in the application software, click the **Print** button.
- 5 Preview main window is displayed.

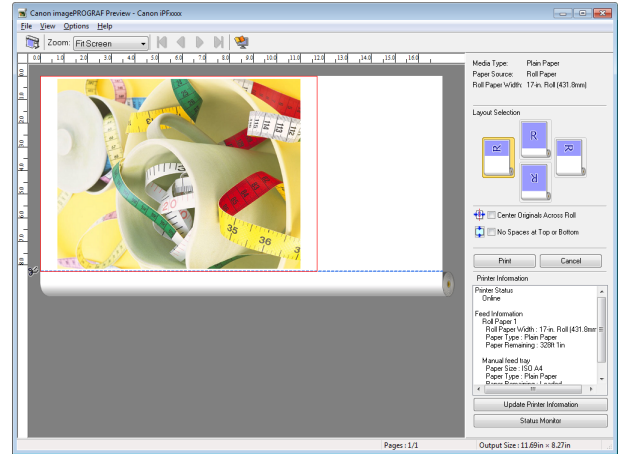

Preview Main Window

The Preview main window consists of the menu and tool bars, preview and dialog area and status bar.

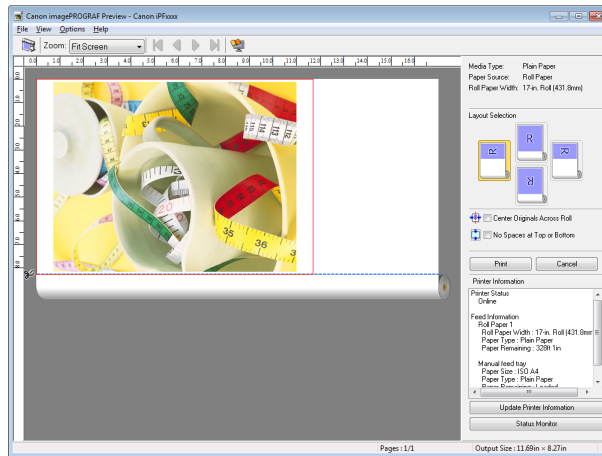

- You can use the **View** menu to show or hide the tool bar.

• Menu Bar

This allows you to select menus required for operations.

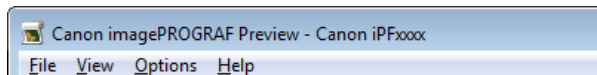

• Tool Bar

This allows you to select tool buttons required for major operations.

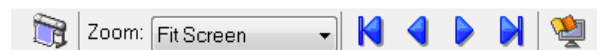

• Preview Area

You can check the settings you made in this area.

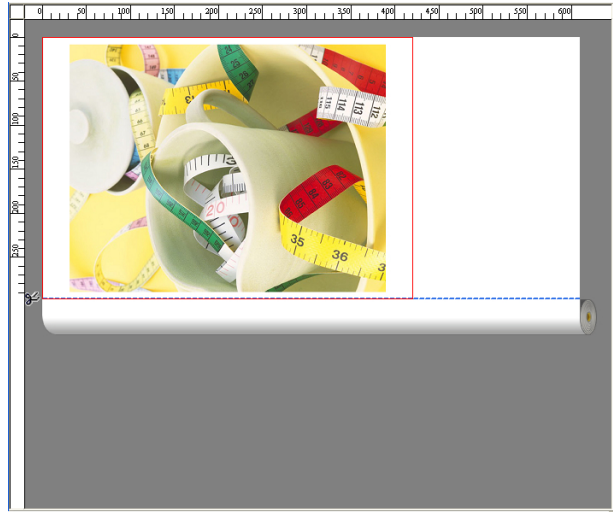

• Dialog Area

This allows you to set the print conditions and perform a print job.

For more information about Dialog Area, see "Dialog Area." → P.192

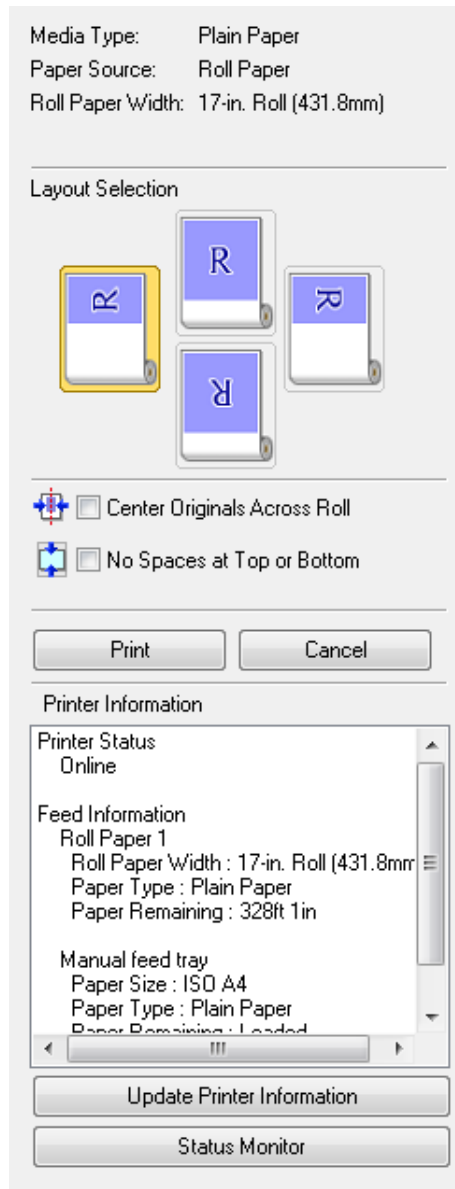

• **Status Bar**

This shows the message, **Pages** and **Output Size**.

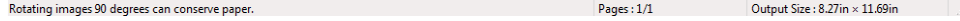

Dialog Area

You can select the layout and print on the center.

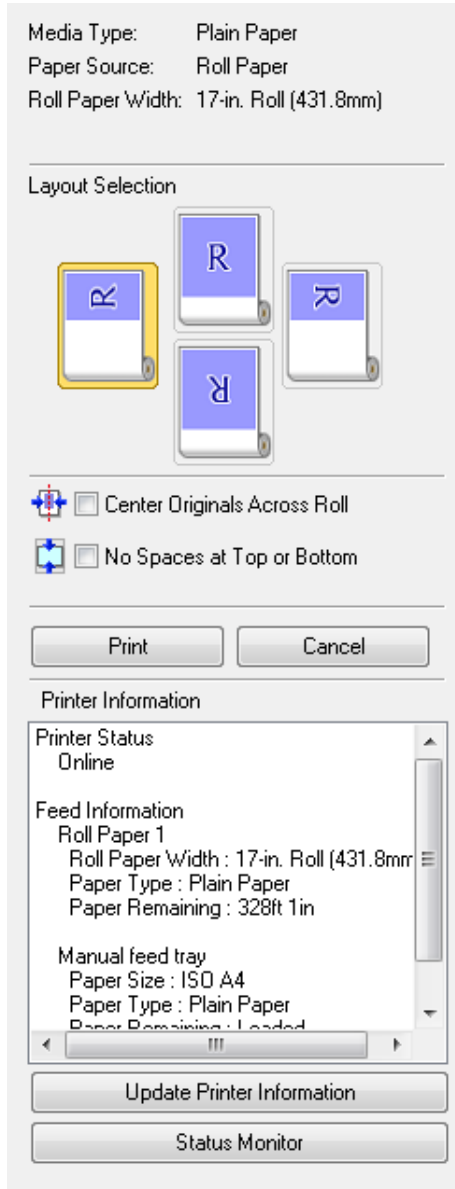

• **Media Type/Paper Source/Paper Size**

You can confirm the information that is set.

• **Layout Selection**

You can print which conserves paper by selecting the layout.

For more information about **Layout Selection**, see "Printing with Selecting the Layout." →P.195

• **Center Originals Across Roll**

You can print on the center of the media loaded in the printer.

For more information about **Center Originals Across Roll**, see "Print on the Center." →P.197



Note

• Available only if rolls are selected in **Paper Source**.

No Spaces at Top or Bottom

You can save paper on not to feed roll paper for the empty spaces when the print data contains spaces at the top or bottom.

For more information about **No Spaces at Top or Bottom**, see "Not Print Spaces at the Top/Bottom." → P.198



• Available only if rolls are selected in **Paper Source**.

Print Button

Click the button to start printing.

Cancel Button

Click the button to stop printing.

Printer Information

You can confirm the information acquired from the printer.

Update Printer Information Button

Click the button to update the printer information with connecting to the printer.

Status Monitor Button

Click the button to start **Status Monitor**.

Enlarge/Reduce the screen display

You can enlarge or reduce the screen display when you select **Zoom** from the **View** menu.

Setting	Details
Fit Screen	Display all.
Fit to Width	Display to the width of the paper.
Reduce	Display at half of the standard size.
Standard	Display at the standard size.
Enlarge	Display with the double of the standard size.
Enlarge More	Display with the triple of the standard size.



• This item can be selected even if you have clicked the ▼ button in the toolbar **Zoom**.

Moving a Page

You can move a page to display when you select **Go to Page** from the **View** menu.

Setting	Details
First Page	Go to the first page.
Previous Page	Go to the previous page.
Next Page	Go to the next page.
Last Page	Go to the last page.
Go To Page	Go to the specified page.



• You can also move a page by clicking



on the tool bar.

Using the ruler

You can confirm the layout with using the ruler.

- Switching the ruler Show/Hide
In the **View** menu, select **Ruler** to switch the ruler Show/Hide.

- Changing the ruler unit
You can set the ruler unit when you select **Units** from the **View** menu.

Setting	Details
mm	Use mm as the ruler unit.
inch	Use inches as the ruler unit.

Priority setting for rotating 90 degrees

You can select **Rotate 90 Degrees If Possible** or **Use Driver Settings** from the **Options** menu.

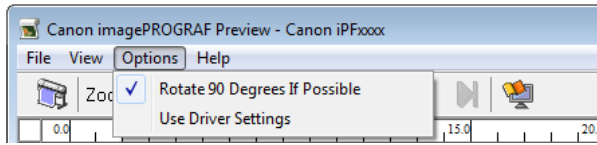

Setting	Details
Rotate 90 Degrees If Possible	Rotates pages in portrait orientation 90 degrees before printing. Pages are only rotated if they can fit lengthwise across the roll.
Use Driver Settings	Follows printer driver settings when determining whether to rotate pages.

Selecting **Rotate 90 Degrees If Possible** or Placing a checkmark for **Rotate Page 90 degrees (Conserve Paper)** on the printer driver

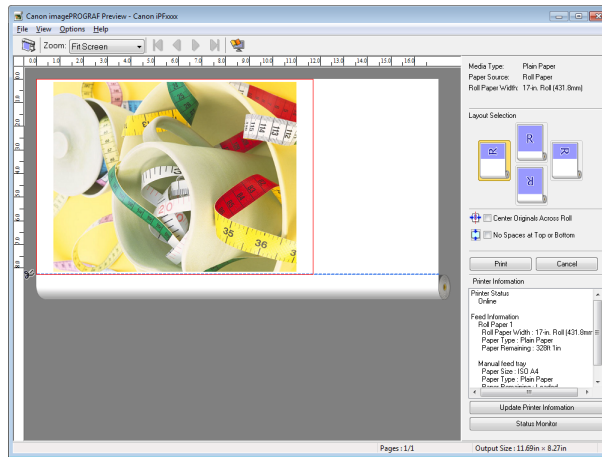

Selecting **Use Driver Settings**

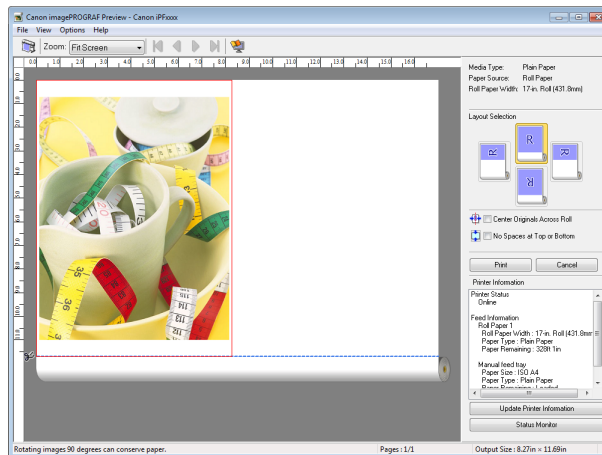



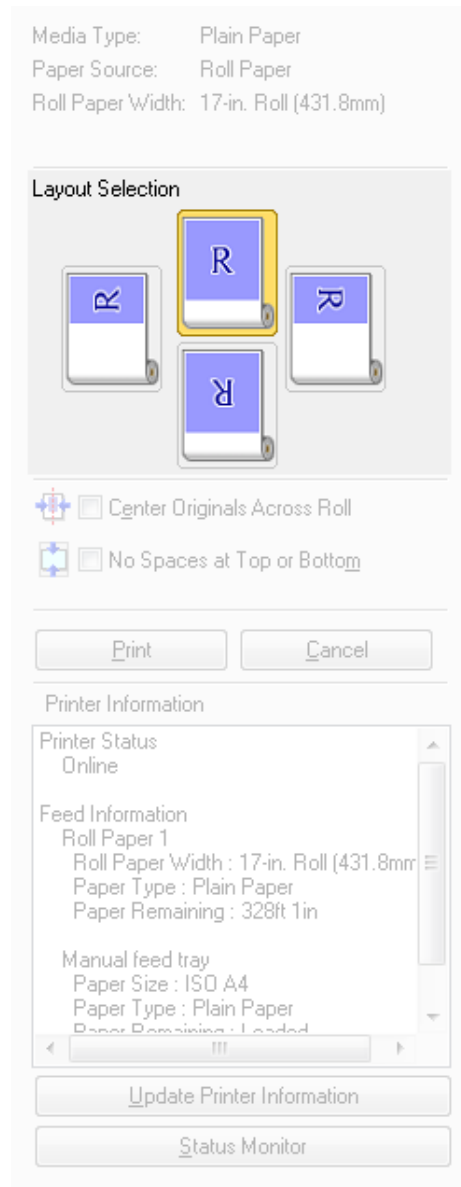

Printing with Selecting the Layout

You can print which conserves paper by selecting the layout.

1 In **Layout Selection**, click the layout button to use.



Button	Details
Upper Button	Turn at the position of 
Right Button	Turn at the position of 
Left Button	Turn at the position of 



Button	Details
Lower Button	 <p>Turn at the position of</p>

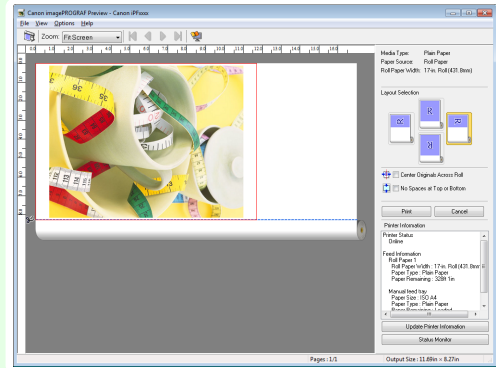

Note

- **Right Button** or **Left Button** can be selected only when the rotated pages can fit lengthwise across the roll.
- By clicking **Right Button** or **Left Button**, you can save paper by printing in landscape orientation on roll paper.
- You can select only **Upper Button** or **Lower Button** if **Cut Sheet** is selected.



Button	Details
	The button is selected currently.
	The button can be selected.
	The button can not be selected.

2

Click the **Print** button.

Printing on the selected layout begins.

Print on the Center

You can print on the center of the media loaded in the printer.

- 1 Click the **Center Originals Across Roll** check box on.

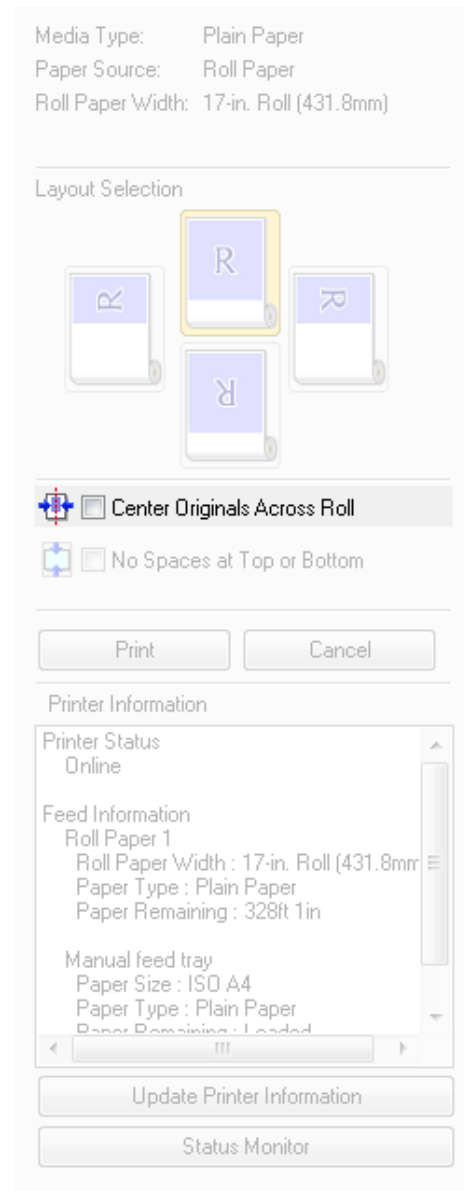

- 2 Click the **Print** button.

Printing on the center begins.



Note

- Available only if rolls are selected in **Paper Source**.

Not Print Spaces at the Top/Bottom

You can save paper on not to feed roll paper for the empty spaces when the print data contains spaces at the top or bottom.

- 1 Click the **No Spaces at Top or Bottom** check box on.

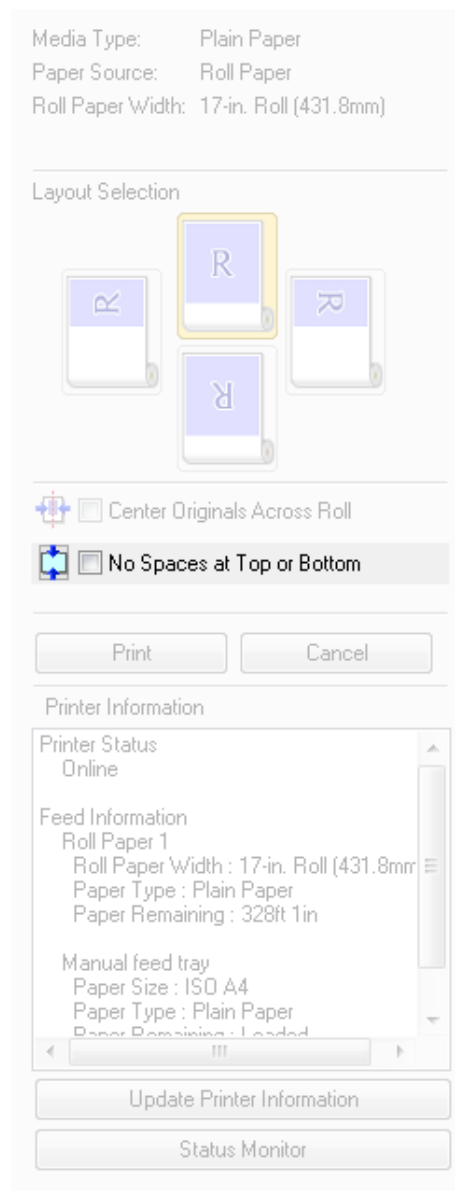

- 2 Click the **Print** button.

Printing on the settings with no spaces at top or bottom begins.

Free Layout

- The Features of Free Layout 199
- Starting Free Layout 199
- Free Layout Main Window 201
- Detailed Settings 202
- Preferences Dialog Box 203
- Page Options Dialog Box 204
- Zoom Dialog Box 205
- Format Dialog Box 205
- Laying out a Multiple-File Document on One Page 207
- Laying out a Document Created with Multiple Application Programs on One Page 209
- Selecting an Object 211
- Changing the Object Size 211
- Moving an Object 212
- Rotating an Object 212
- Laying out Objects Automatically 213
- Aligning Objects 213
- Changing the Object Overlapping Order 215
- Pasting a Copied or Cut Object 216
- Folded Duplex Window 217
- Finished Size Settings Dialog Box 218
- Binding Settings Dialog Box 219
- Prints using Folded Duplex 220

The Features of Free Layout

The main features of Free Layout are as follows.

- Allows you to lay out at will and print a document created with application software.
- You can not only lay out multiple pages on one page but also lay out and print a multiple-file document on one page, or lay out and print a document created with multiple application programs on one page.
- Any two pages can be arranged and printed in a layout that becomes duplex on folding. This can be used such as for advertising posters that are suspended from the ceiling.

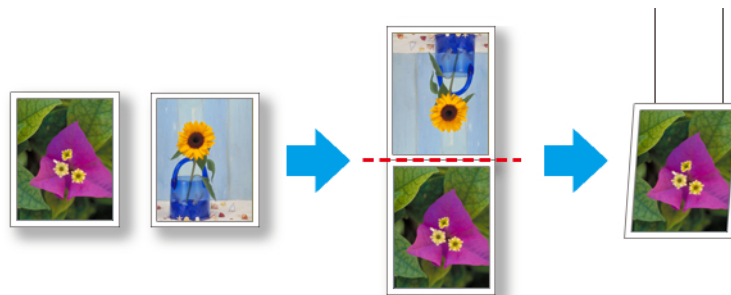

• The media type, image size, detailed media settings, and the printer settings can cause the actual print output to differ from the Free Layout settings.

Starting Free Layout

Follow the procedure below to start the Free Layout.

- 1** Start the application software which you use.

2 From the application software's **File** menu, select the printer setup menu to open the **Print** dialog box.



- Normally, select **Print** from the **File** menu.

3 From the list, select the printer and select the **Layout** sheet.

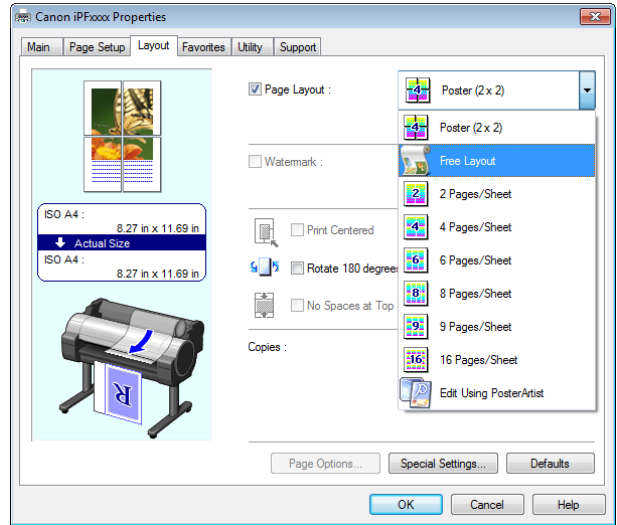

- Your printer is depicted in the lower-left area of this screen.

4 In the **Layout** sheet, click on the **Page Layout** check box and select **Free Layout** from the list. Click the **OK** button to save the settings.



- When you select **Free Layout**, all other setting items will be disabled.

5 On the **Print** dialog box in the application software, click the **Print** button. **Free Layout** main window is displayed.

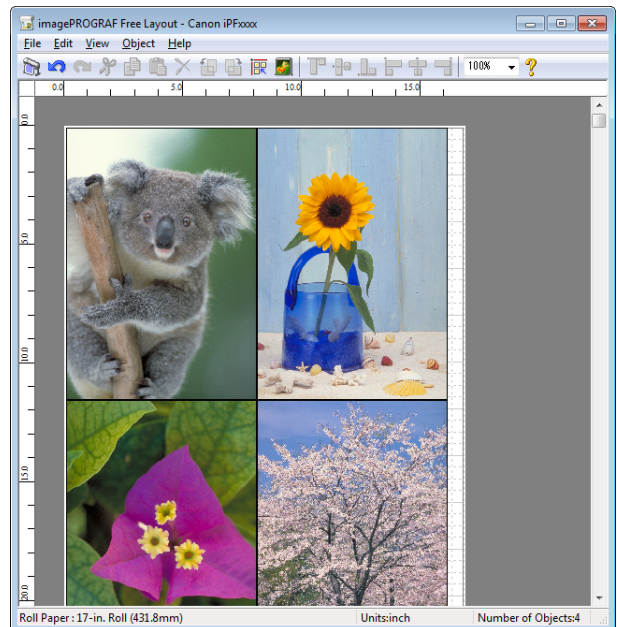

Free Layout Main Window

The Free Layout main window consists of the menu and tool bars, layout area and status bar.

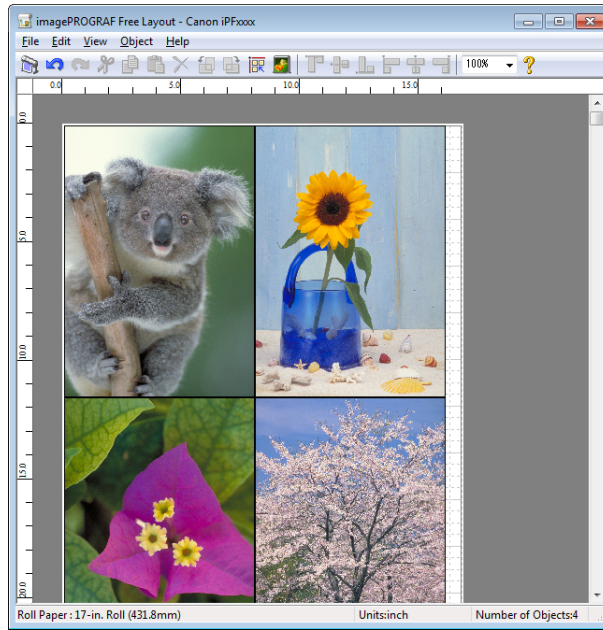

 • You can use the **View** menu to show or hide the tool and status bar.

Note

• Menu Bar

This allows you to select menus required for operations.

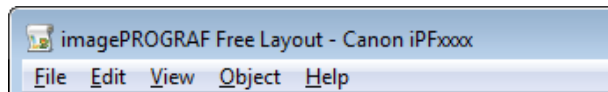

• Tool Bar

This allows you to select tool buttons required for major operations.



• **Layout Area**

This allows you to lay out objects and edit the object size and orientation.

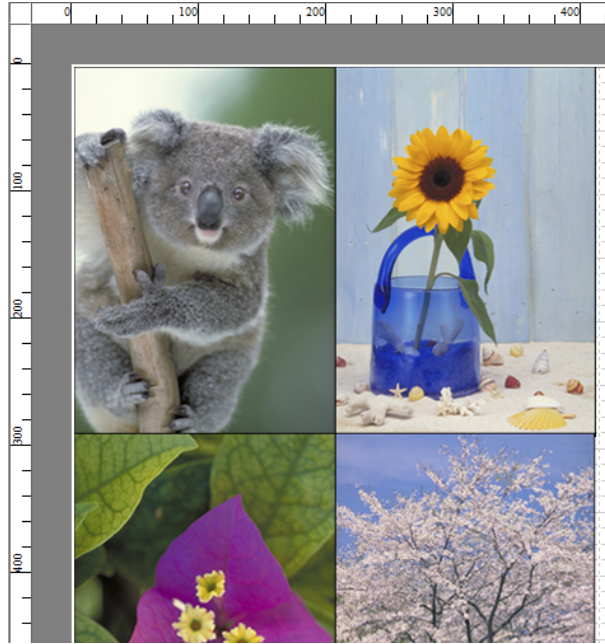

• **Status Bar**

This shows the paper size, unit of length, and number of objects.



Detailed Settings

The printer driver opens when you select **Detailed Settings** from the **File** menu. The printer driver is used to configure basic settings to match the type of media loaded in the printer.

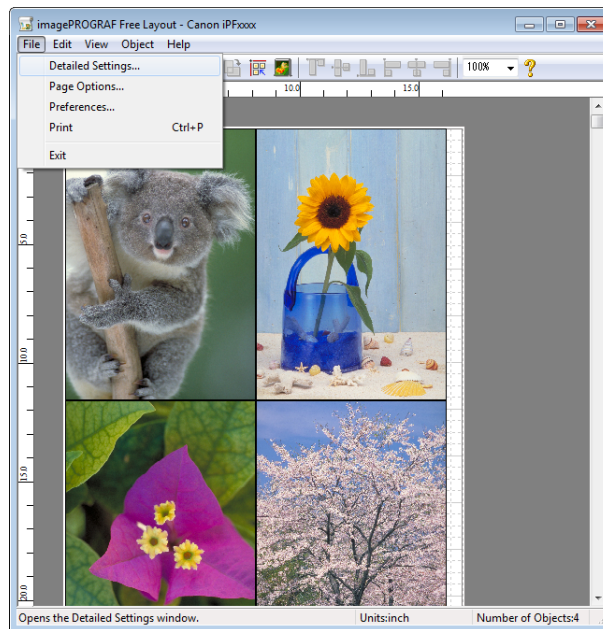

202 Refer to "Printer Driver" →P.158 for details on the printer driver.



- When you select the **Detailed Settings**, the only three sheets displayed are the **Main** sheet, the **Page Setup** sheet, and the **Layout** sheet. Some of the printer driver settings may be disabled.

Preferences Dialog Box

This dialog box appears when you select **Preferences** from the **File** menu. This allows you to configure the preferences of Free Layout.

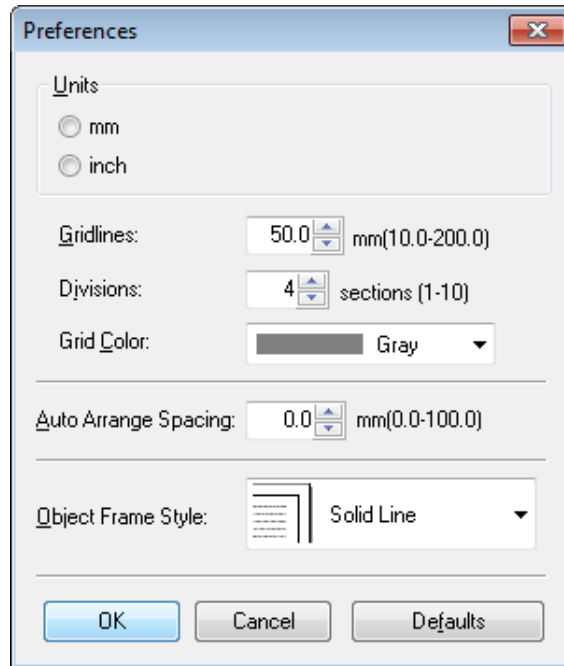

• Units

Set the unit for paper length, margins, and so on.

• Gridlines

You can input a grid line width value in numerical characters so that they serve as a guide to laying out objects.



Note

- You can input between 10.0 and 200.0(mm) (between 0.39 and 7.88(inch)).
- You can change the numbers by clicking either ▲ button or ▼ button.

• Divisions

You can change the number of divisions of grid lines so that they serve as a guide to laying out objects.



Note

- You can input between 1 and 10.
- You can change the numbers by clicking either ▲ button or ▼ button.

• Grid Color

Select the grid line color.

• Auto Arrange Spacing

Change the object-to-object spacing to be applied in the operation of laying out objects automatically.



Note

- You can input between 0.0 and 100.0(mm) (between 0.00 and 3.94(inch)).
- You can change the numbers by clicking either ▲ button or ▼ button.

• Object Frame Style

You can select the object frame style for printing.

The following settings are available for the object frame style.

Setting	Details
None	You can print with no frame style.
Solid Line	You can print the solid line as the frame style.
Dotted Line	You can print the dotted line as the frame style.
Dashed Line	You can print the dashed line as the frame style.

Setting	Details
Crop Marks	You can print with the crop marks.

Page Options Dialog Box

This dialog box appears when you select **Page Options** from the **File** menu. This allows you to configure the roll paper length, object layout order, and margins of Free Layout.

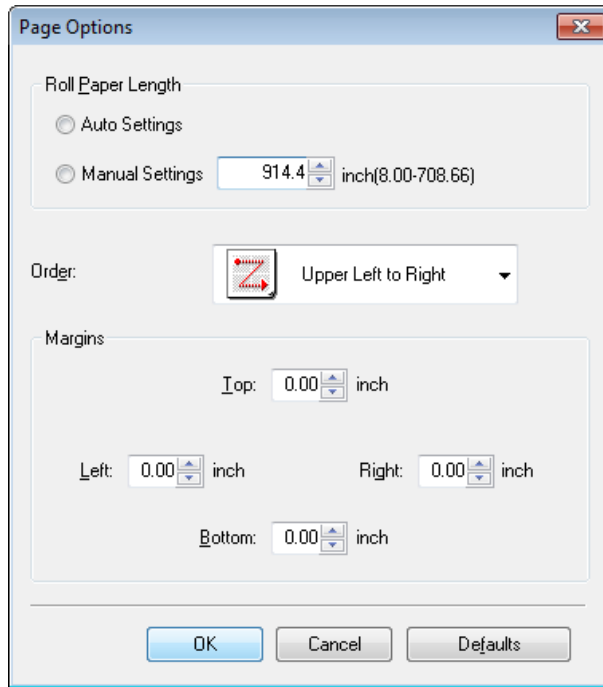

• Roll Paper Length

Set the length of one page to print on roll paper. The following settings are available for roll paper length.

Setting	Details
Auto Settings	The one-page length to be printed on roll paper is automatically set so that the laid-out objects are printed on one page.
Manual Settings	You can input the length of one page to print on roll paper in numerical characters.



- Available only if rolls are selected in **Paper Source**.
- You can input between 203.2 and 18000.0(mm) (between 8.00 and 708.66(inch)).
- You can change the numbers by clicking either ▲ button or ▼ button.

• Order

Set the object layout order. The following settings are available for order.

Setting	Details
Upper Left to Right	The objects are laid out from upper left to right.
Upper Left to Bottom	The objects are laid out from upper left to bottom.
Upper Right to Left	The objects are laid out from upper right to left.
Lower Left to Top	The objects are laid out from lower left to top.



- When you have selected **Roll Paper Length > Auto Settings** and **Paper Orientation > Vertical**, you can choose **Upper Left to Right** or **Upper Right to Left**.
- When you have selected **Roll Paper Length > Auto Settings** and **Paper Orientation > Horizontal**, you can choose **Upper Left to Bottom** or **Lower Left to Top**.

• **Margins**

You can input the paper margins in numerical characters.



- You can input between 0.0 and 50.0(mm) (between 0.00 and 1.97(inch)).
- You can change the numbers by clicking either ▲ button or ▼ button.

Zoom Dialog Box

This dialog box appears when you select **Zoom** from the **View** menu. You can enlarge or reduce the screen display.

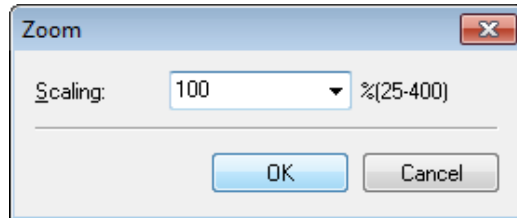

• **Scaling**

Set the magnification for enlargement or reduction of the screen display.



- You can input between 25 and 400.
- You can change the numbers by clicking ▼ button.

Format Dialog Box

This dialog box appears when you select **Format** from the **Object** menu after you select an object.

Size Sheet

You can rotate, enlarge, or reduce an object.

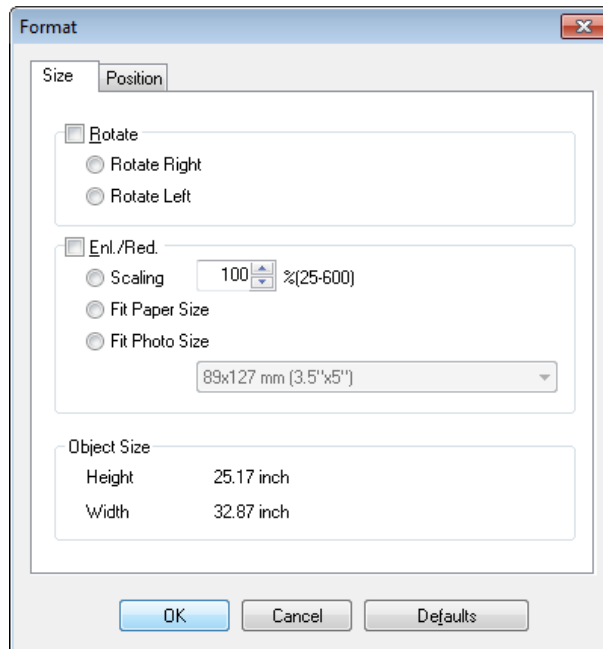

- When the objects are not selected, you can not select **Format**.

• **Rotate**

When you place a checkmark here, you can select **Rotate Right** or **Rotate Left**.

Setting	Details
Rotate Right	Rotates the object 90 degrees clockwise.
Rotate Left	Rotates the object 90 degrees counterclockwise.



Note

- When several objects are selected, you cannot select **Rotate**.

• **Enl./Red.**

When you place a checkmark here, you can select **Scaling**, **Fit Paper Size**, or **Fit Photo Size**.

Setting	Details
Scaling	Allows you to input the value of the enlargement or reduction ratio of an object.
Fit Paper Size	Prints by enlarging or reducing each object to match the paper size. If you are using roll paper, objects are enlarged or reduced so that the width of each object matches the width of the roll paper.
Fit Photo Size	Prints all of the objects at the specified photo size.



Note

- You can input between 25 and 600.
- You can change the numbers by clicking either ▲ button or ▼ button.

Position Sheet

You can rotate, enlarge, or reduce an object.

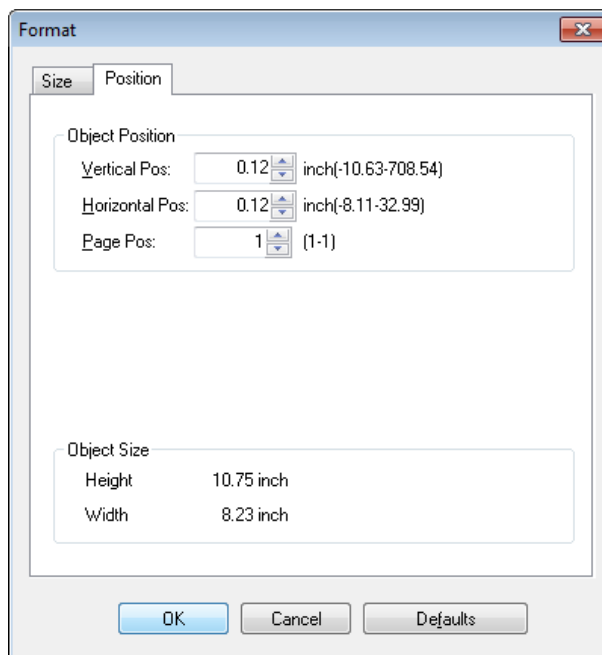

Note

- When the objects are not selected, you can not select **Format**.

• **Object Position**

You can move the object position by changing the values.

Setting	Details
Vertical Pos	You can input the number of the vertical position in numerical characters.
Horizontal Pos	You can input the number of the horizontal position in numerical characters.
Page Pos	You can input the number of the page position in numerical characters.

• **Object Size**

You can confirm the object size.



- When several objects are selected, you cannot display **Object Size**.

Laying out a Multiple-File Document on One Page

You can lay out and print a multiple-file document on one page.

1 From the application software's **File** menu, select the printer setup menu to open the **Print** dialog box.



- Normally, select **Print** from the **File** menu.

2 Click **Properties** to open the **Properties** dialog box.

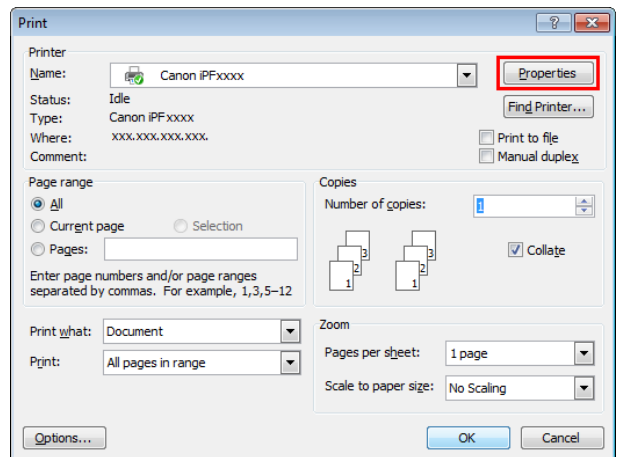

3 In the **Page Setup** sheet, select **Paper Source**.

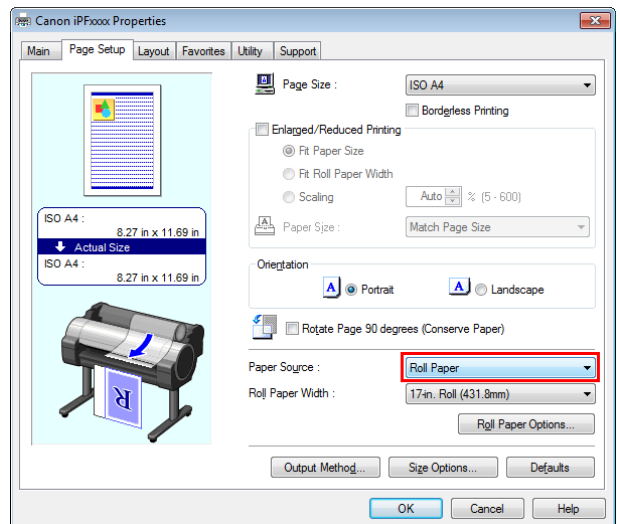

- Your printer is depicted in the lower-left area of this screen.

4 In the **Layout** sheet, click on the **Page Layout** check box and select Free Layout from the list.

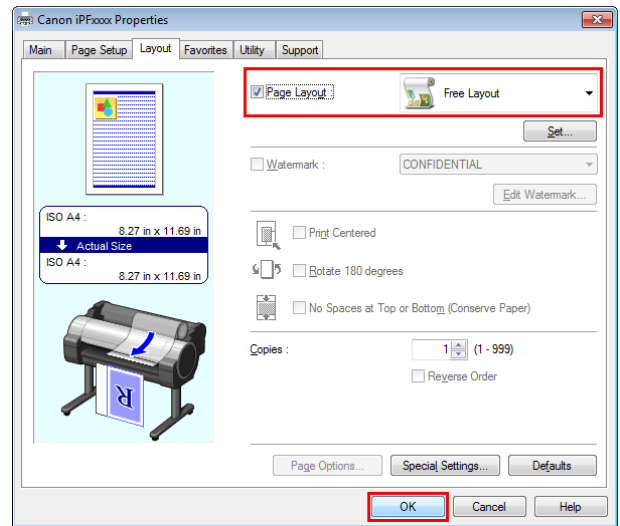

- Your printer is depicted in the lower-left area of this screen.
- When you select Free Layout, all other setting items will be disabled.

5 Click the **OK** button to save the settings.

6 In the **Print** dialog box, select the pages to print and the number of copies, and click the **OK** button.

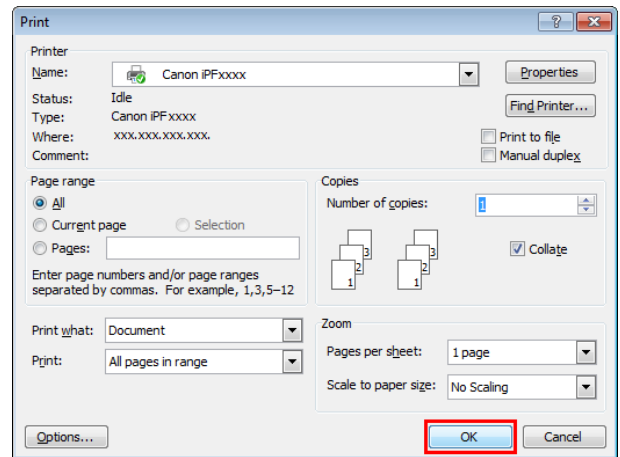

Free Layout starts, laying out the document created with application software in the layout area as an object.

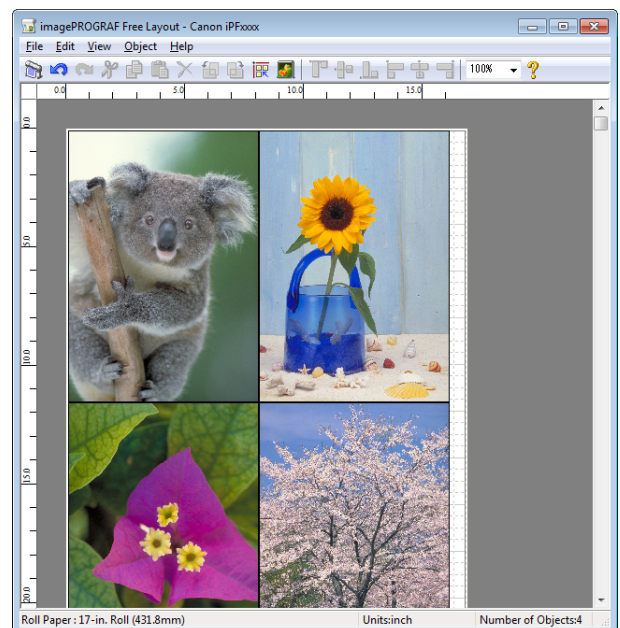

7 Leaving Free Layout running, open other files with the application software and repeat the above steps.

Laying out a Document Created with Multiple Application Programs on One Page

You can lay out and print a document created with multiple application programs on one page.

1 From the application software's **File** menu, select the printer setup menu to open the **Print** dialog box.



• Normally, select **Print** from the **File** menu.

2 Click **Properties** to open the **Properties** dialog box.

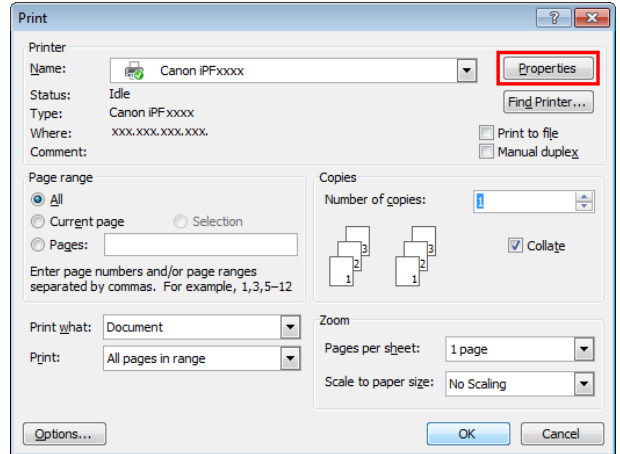

3 In the **Page Setup** sheet, select **Paper Source**.

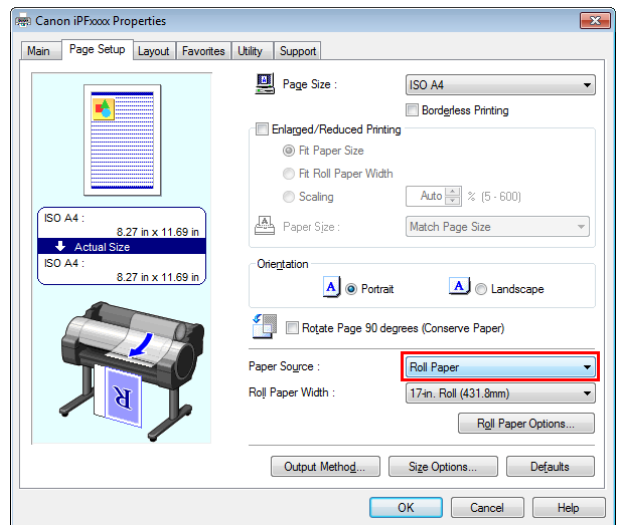

• Your printer is depicted in the lower-left area of this screen.

4 In the **Layout** sheet, click on the **Page Layout** check box and select Free Layout from the list.

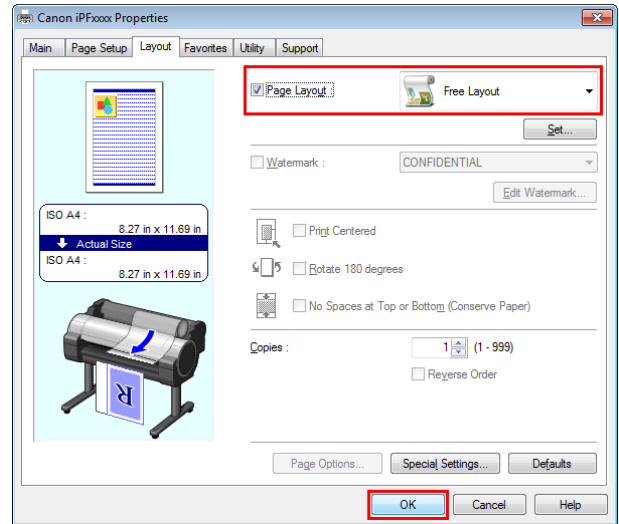

- Your printer is depicted in the lower-left area of this screen.
- When you select Free Layout, all other setting items will be disabled.

5 Click the **OK** button to save the settings.

6 In the **Print** dialog box, select the pages to print and the number of copies, and click the **OK** button.

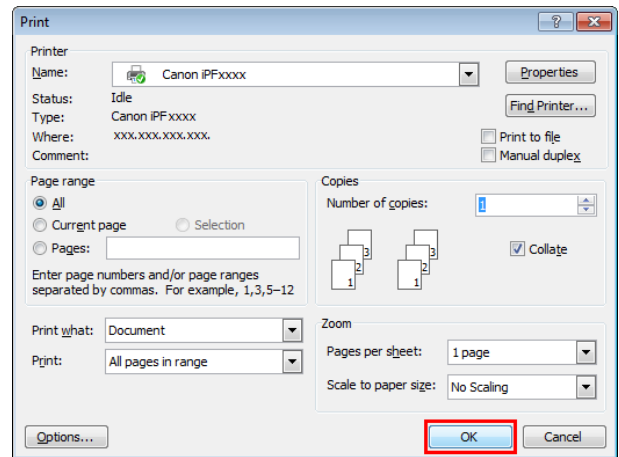

Free Layout starts, laying out the document created with application software in the layout area as an object.

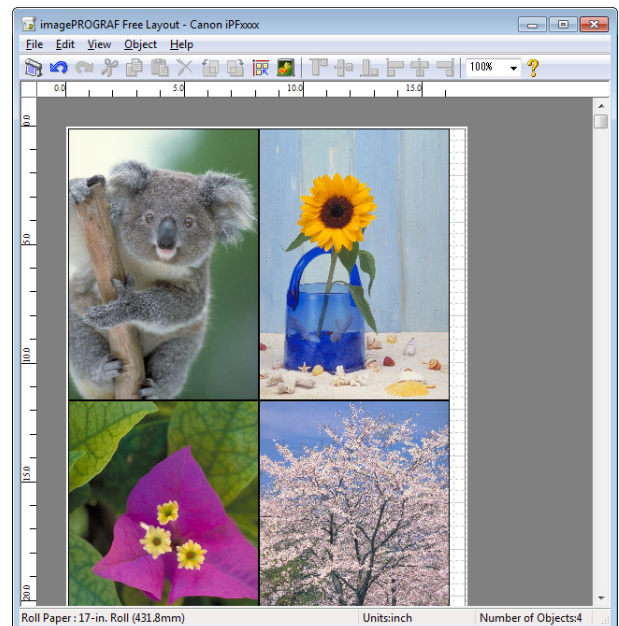

7 Leaving Free Layout running, open other files with other application software and repeat the above steps.

Selecting an Object

When an object is selected, a select box (blue border) appears around the object.



Note

- To select an object, click that object.
- To select multiple successive objects, click them while holding down the Shift key.
- To select multiple arbitrary objects, click them while holding down the Ctrl key.
- To select all objects, select **Select All** from the **Edit** menu.
- When you specify the area with dragging the mouse, the object in the area is selected.

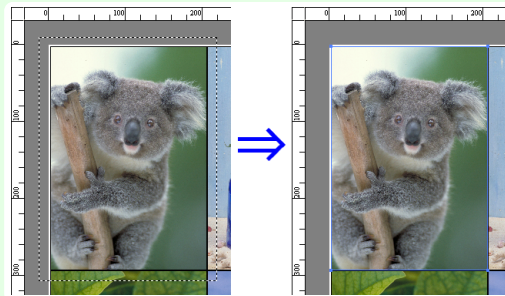

Changing the Object Size

You can change the object size by means of mouse operation or by specifying a scaling value.



Note

- The vertical-to-horizontal ratio remains unchanged when the object is enlarged or reduced.

Resizing by means of mouse operation

- 1 Select an object.

- 2 Place the pointer at a corner of the selection box around the object to show the arrow handle, and drag this handle to change the object size.

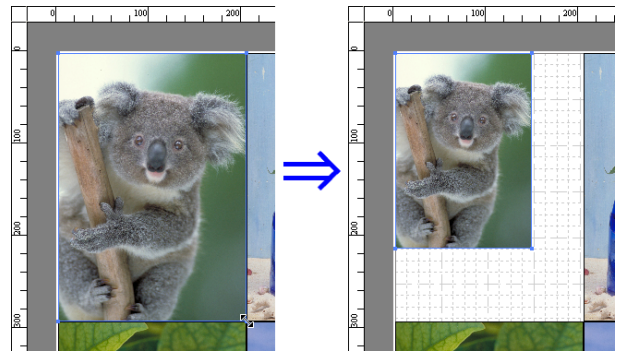

Resizing by specifying a scaling value

- 1 Select an object. Click on the **Enl./Red.** checkbox in the **Format Dialog Box** →P.205 and select **Scaling**.

- 2 You either enter numbers directly.

Note

- You can input between 25 and 600.
- You can change the numbers by clicking either ▲ button or ▼ button.

- 3 Click the **OK** button.

Moving an Object

You can move the object position.

- 1 Select an object.
- 2 Place the pointer inside the selection box of the object to show the crosshair handle, and drag it to move the object. Alternatively, you can move the **Object Position** by changing the values in **Vertical Pos**, **Horizontal Pos** and **Page Pos** in the **Format Dialog Box** →P.205 .

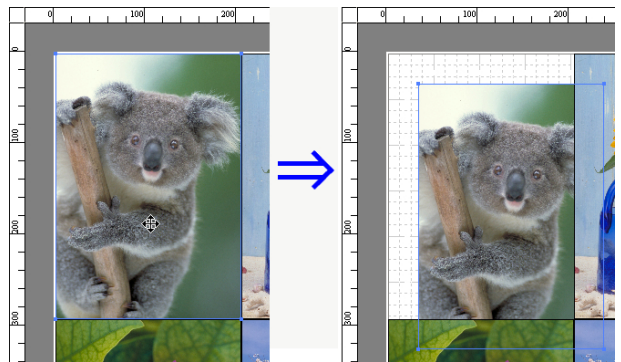

Rotating an Object

You can rotate the object.

- 1 Select an object.

- 2 Select **Rotate Left 90 Degrees** or **Rotate Right 90 Degrees** from the toolbar. Alternatively, you may click on the **Rotate** check box in the **Format Dialog Box** → P.205 then select **Rotate Right** or **Rotate Left**, and click the **OK** button.

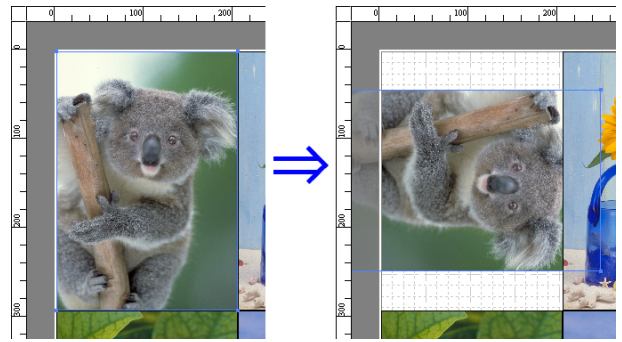

Laying out Objects Automatically

Click **Auto Arrange Object** in the tool bar. This automatically lays out objects. Alternatively, you may select **Auto Arrange Object** from the **Object** menu.

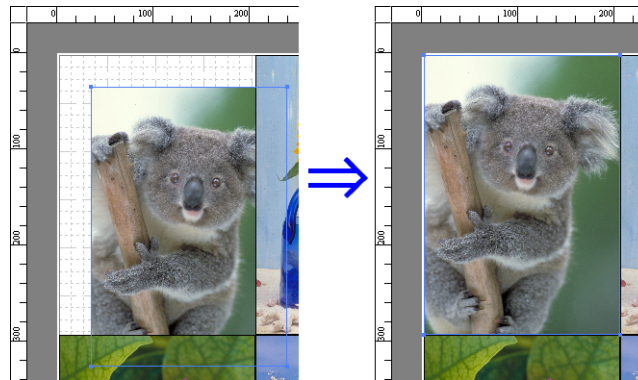

- The object layout order varies depending on the **Order** setting in the **Page Options Dialog Box** → P.204 dialog box.

Note

Aligning Objects

You can align objects systematically.

- 1 Select multiple objects.
- 2 Click the align button from the toolbar. Alternatively, you may select the align menu from the **Object** menu.

- **Align Top**

Lays out the objects, justifying them to the top.

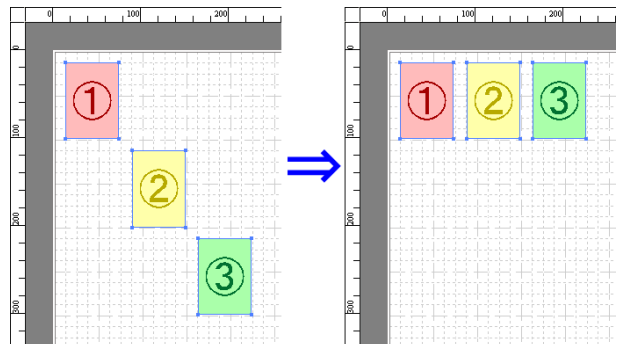

- **Center Vertically**

Lays out the objects, justifying them to the vertical center.

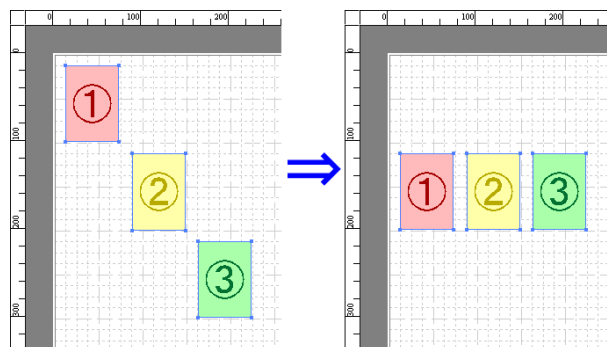

- **Align Bottom**

Lays out the objects, justifying them to the bottom.

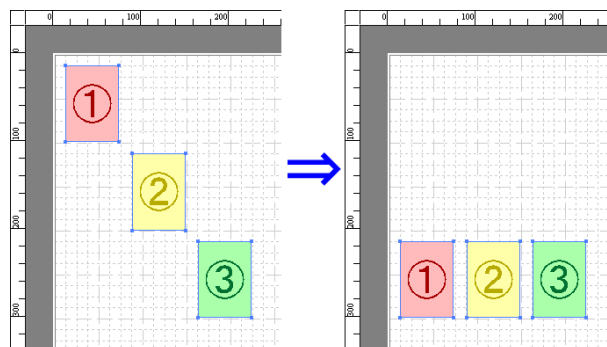

- **Align Left**

Lays out the objects, justifying them to the left.

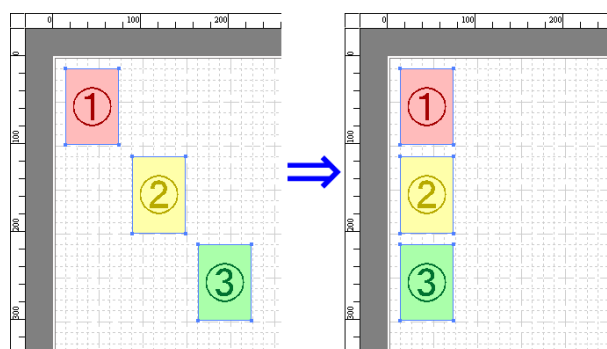

- **Center Horizontally**

Lays out the objects, justifying them to the horizontal center.

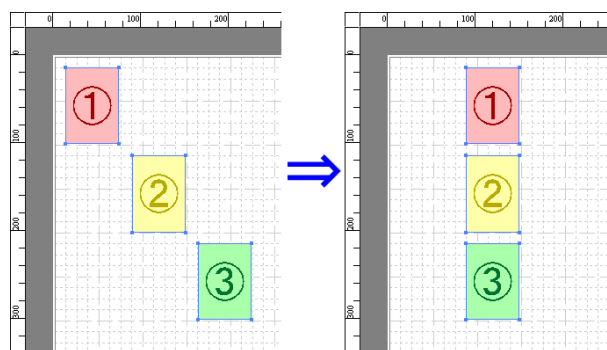

• **Align Right**

Lays out the objects, justifying them to the right.

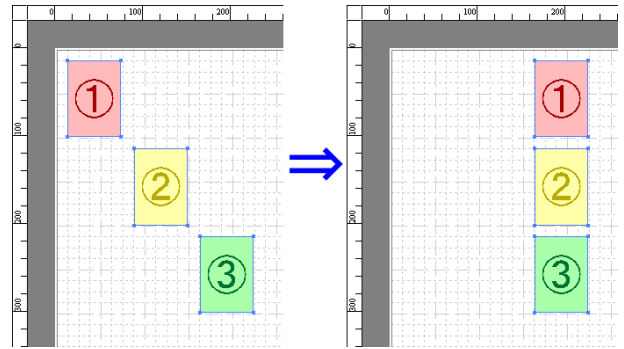

Changing the Object Overlapping Order

You can change the object overlapping order.

1 Select an object.

2 Select the Overlapping Order menu from the **Object** menu.



Note

- The order of overlapping affects the order of objects automatically laid out.
- You can also select by clicking the right button of the mouse on an object.

• **Bring to Front**

Moves the object to the frontmost position.

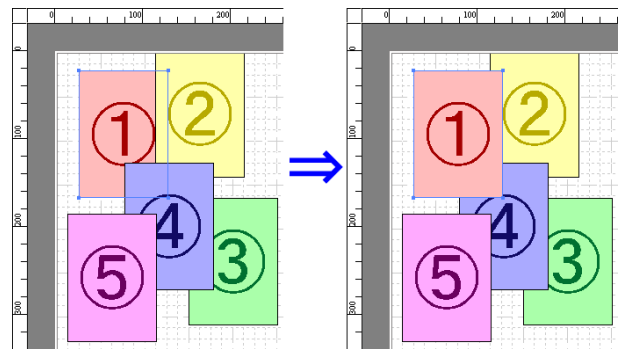

• **Send to Back**

Moves the object to the backmost position.

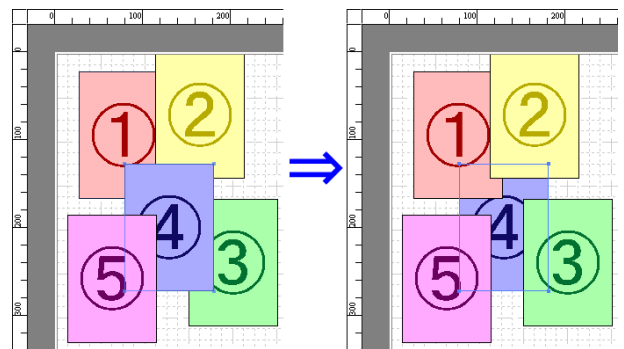

• **Bring Forward**

Moves the object one position to the front.

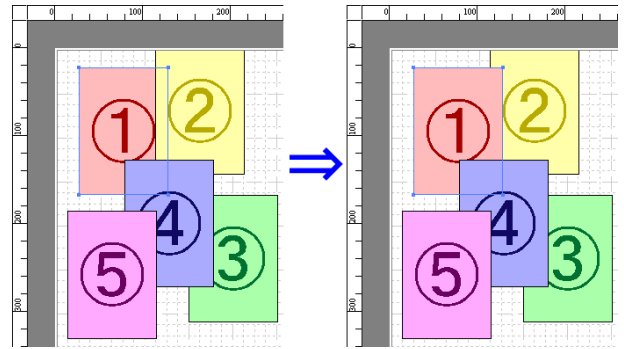

• **Send Backward**

Moves the object one position to the back.

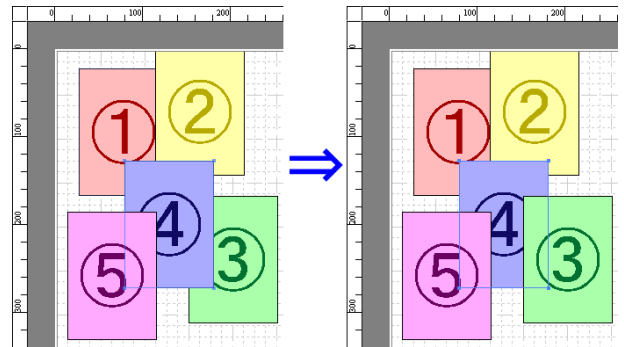

Pasting a Copied or Cut Object

- 1** Click **Copy** or **Cut** from the toolbar.
Alternatively, you may select **Copy** or **Cut** from the **Edit** menu.
- 2** Click **Paste** from the toolbar.
Alternatively, you may select **Paste** from the **Edit** menu.



Note

- The copied or cut object is laid out at the end of the page.
- You can also select by clicking the right button of the mouse on an object.
- In order to paste an object on any position that you like, you can paste the object with **Pointed Paste** by clicking the right button of the mouse on any position that you want.

Folded Duplex Window

This window is displayed if you select **Folded Duplex** from the **Edit** menu after selecting an object. Using the **Folded Duplex** function allows you to print with fold lines added.

The **Folded Duplex** window consists of the menu and tool bars, layout area and status bar.

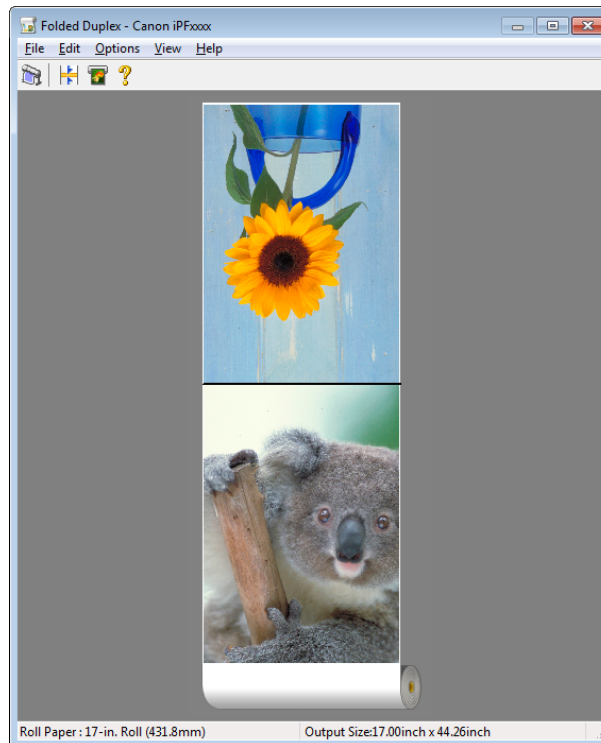

Note

- The toolbar and status bar can be toggled between hidden and displayed from the **View** menu.

• Menu Bar

This allows you to select menus required for operations.

File Edit Options View Help

• Tool Bar

This allows you to select tool buttons required for major operations.



• **Layout Area**

This allows you to check the arrangement and orientation of objects.

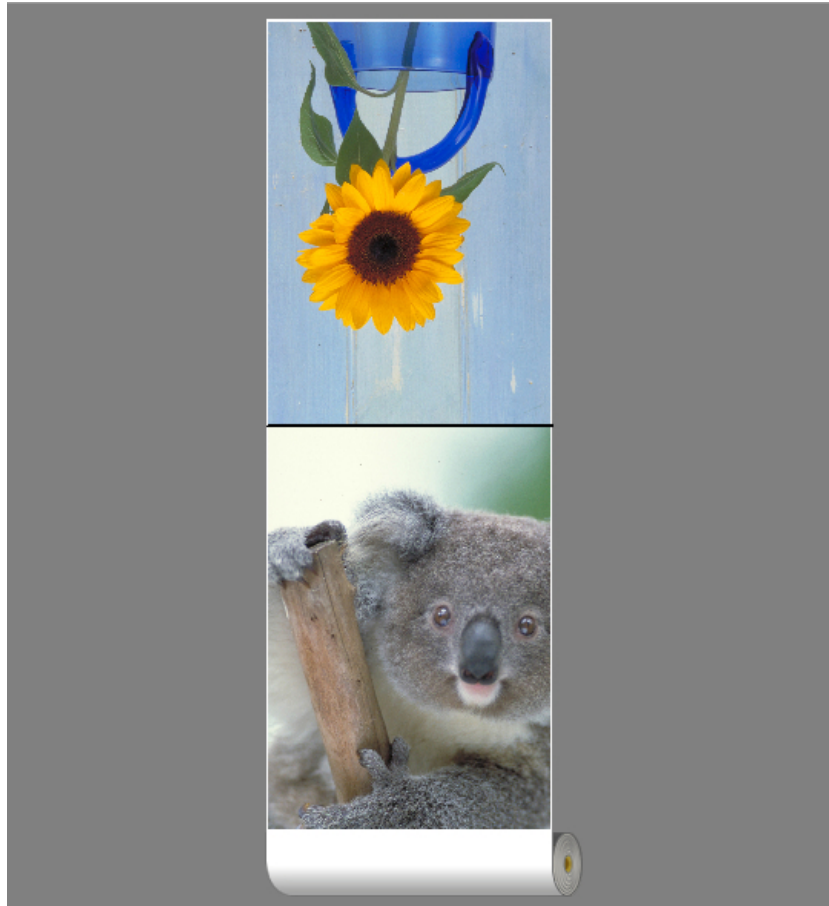

• **Status Bar**

This shows the paper source, roll paper width, and output size.

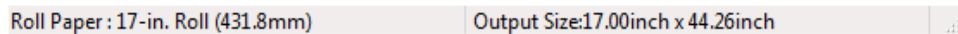

Finished Size Settings Dialog Box

This dialog box is displayed when you select **Finished Size Settings** from the **Edit** menu. This allows you to configure finished size settings.

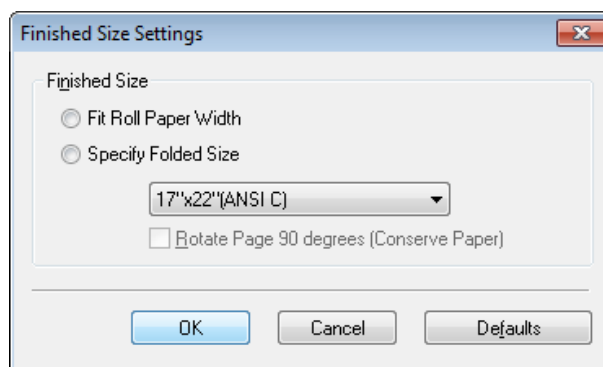

• **Finished Size**

Selects the method for setting the finished size.

The following settings are available for the finished size.

Setting	Details
Fit Roll Paper Width	Prints by automatically enlarging or reducing the entire document so that the width of the document matches the roll paper width.

Setting	Details
Specify Folded Size	Prints by automatically enlarging or reducing the entire document to match the size of the paper. Select the actual size of the paper you want to print on in Fit Paper Size .
Rotate Page 90 degrees (Conserve Paper)	Prints by rotating pages by 90 degrees. Pages are automatically rotated if they will fit within the roll paper width when rotated, and are not rotated if they will not fit within the roll paper width.

Binding Settings Dialog Box

This is displayed when you select **Binding Settings** from the **Edit** menu. This allows you to configure the binding edge settings.

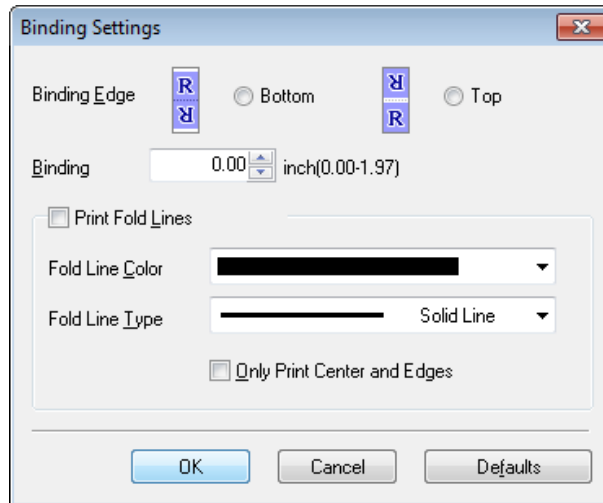

• Binding Edge

Configures the binding edge when folding paper. The following settings are available for the binding edge.

Setting	Details
Bottom	Prints by placing the binding margin (gutter) at the bottom of the document.
Top	Prints by placing the binding margin (gutter) at the top of the document.

• Binding

Configures the binding margin (gutter). Prints by creating a binding margin (gutter) of the specified size. Enter the margin size as a number.

Note • The values that can be entered are 0 to 50 (mm).

• Print Fold Lines

Configures the color and type of fold lines.

Note • To not print fold lines, clear the **Print Fold Lines** checkbox.

• Fold Line Color

You can select the fold lines.

• Fold Line Type

You can select the fold lines. The following settings are available for the fold line type.

Setting	Details
Solid Line	You can print the solid line as the frame style.
Dotted Line	You can print the dotted line as the frame style.
Dashed Line	You can print the dashed line as the frame style.

- **Only Print Center and Edges**

To print fold lines at the center and both edges, select the **Only Print Center and Edges** checkbox.

Prints using Folded Duplex

This prints 2 pages consecutively. Folding back the paper at the fold lines of the center substitutes for duplex printing.

- 1 Select two objects from the layout area of Free Layout.
- 2 Select **Folded Duplex** from the **Edit** menu of Free Layout. Open the **Folded Duplex** window and arrange the selected objects in the layout area.
- 3 Open the **Finished Size Settings** dialog box from the **Edit** menu.
- 4 Select **Fit Roll Paper Width** or **Specify Folded Size** in **Finished Size**.



- **Rotate Page 90 degrees (Conserve Paper)** is also available when **Specify Folded Size** is selected.

Note

- 5 Click **OK** to save the settings.
- 6 Open the **Binding Settings** dialog box from the **Edit** menu.
- 7 Select **Bottom** or **Top** in **Binding Edge**.
- 8 Specify the **Binding** width in **Binding**.
- 9 Configure the **Fold Line Color** and **Fold Line Type** from **Print Fold Lines**.



- When the **Only Print Center and Edges** checkbox is selected, fold lines are only printed at the three locations of the center and both edges.

Note

- 10 Click **OK** to save the settings.
- 11 Confirm the print setting and begin printing.

Color imageRUNNER Enlargement Copy

The Features of Color imageRUNNER Enlargement Copy	221
Starting Color imageRUNNER Enlargement Copy	221
Color imageRUNNER Enlargement Copy Dialog Box	222
Hot Folder	223
Creating a New Hot Folder	223
Specifying an Existing Shared Folder as a Hot Folder	226
Setting the Print Parameters	228
Printing Enlargements of Scanned Originals from a Color imageRUNNER	229

The Features of Color imageRUNNER Enlargement Copy

The main features of Color imageRUNNER Enlargement Copy are as follows.

- Allows the document scanned with the Color imageRUNNER to be automatically enlarged and printed.
- You can perform basic printer settings such as printer selection, media type and output profile selection, and matching methods, in addition to borderless printing and enlargement/reduction process without growing through the printer driver.



Note

- The media type, image size, detailed media settings, and the printer settings can cause the actual print output to differ from the Color imageRUNNER Enlargement Copy settings.

Starting Color imageRUNNER Enlargement Copy

Follow the procedure below to start the Color imageRUNNER Enlargement Copy.

To start by selecting **Devices and Printers** from the **start** button

- 1 Open the folder of the OS you are using for configuring printers.
For example, on Windows 7, click the **start** button on the Desktop and open the **Devices and Printers** window.

- 2 Right-click the Printers icon and select **Printing Preferences** to open the **Printing Preferences** dialog box.
In the **Utility** sheet, click the **Color imageRUNNER Enlargement Copy** button.

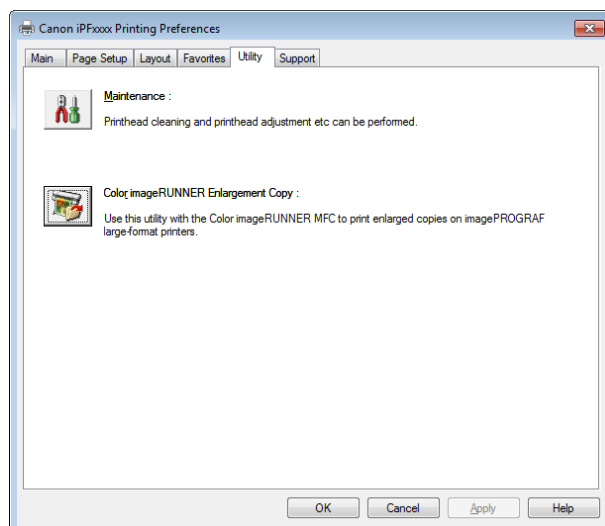

3 The **Color imageRUNNER Enlargement Copy** dialog box displays.

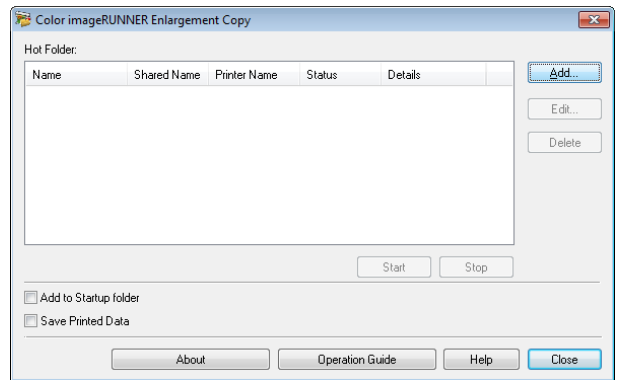

Note

- If you click on the **Add to Startup folder** check box in the **Color imageRUNNER Enlargement Copy** dialog box, the icon of Color imageRUNNER Enlargement Copy utility will appear on the task bar when starting Windows thereafter.
- This function cannot be used on 64-bit version of Windows.

To start by selecting **Color imageRUNNER Enlargement Copy** from the **start** button

1 From the Windows **start** button, select **Color imageRUNNER Enlargement Copy**.

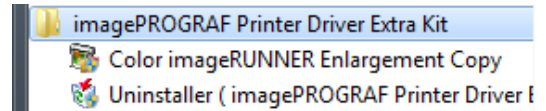

2 The **Color imageRUNNER Enlargement Copy** dialog box displays.

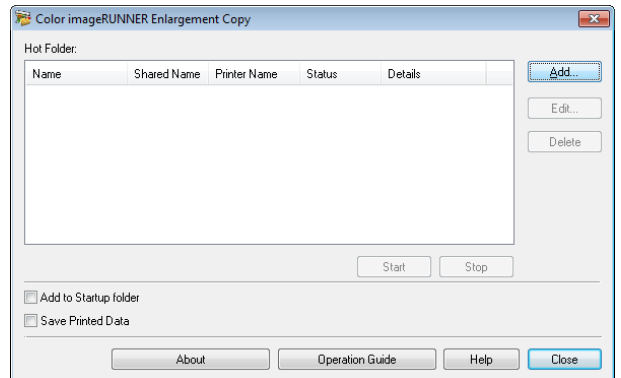

Color imageRUNNER Enlargement Copy Dialog Box

The explanation below is on the **Color imageRUNNER Enlargement Copy** dialog box.

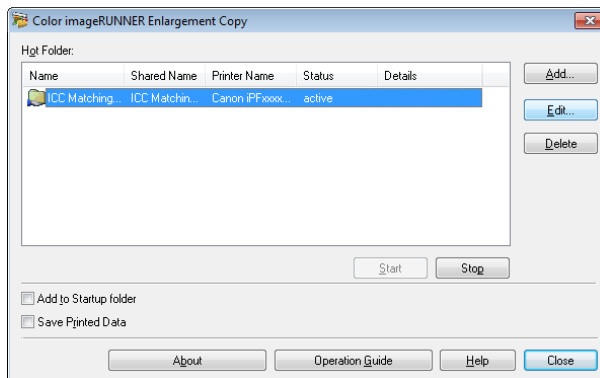

Note

- For the step to open the **Color imageRUNNER Enlargement Copy** dialog box, see "Starting Color imageRUNNER Enlargement Copy." →P.221

• **Hot Folder**

The hot folder list appears.

• **Add Button**

Click the button to open the **Easy Setup Wizard** dialog box so that you can add a hot folder.

• **Edit Button**

From the **Hot Folder** list, select a hot folder and click the button to open the **Add/Edit Hot Folder** dialog box that allows you to edit the hot folder.

• **Delete Button**

From the **Hot Folder** list, select a hot folder and click the button to delete the hot folder.

• **Start Button**

Clicking the button changes the status of the selected **inactive** Hot Folder to **active**.

• **Stop Button**

Clicking the button changes the status of the selected **active** Hot Folder to **inactive**.

• **Add to Startup folder**

Register the application in the Windows startup menu.

• **Save Printed Data**

Automatically saves printed data.

• **About Button**

Click the button to display the name and the version number of the utility.

• **Operation Guide Button**

Click the button to display the **Color imageRUNNER Enlargement Copy Setup Manual**.

Hot Folder

Hot folder refers to a folder used for Color imageRUNNER Enlargement Copy.

- When transferred to the PC's hot folder, the document data scanned with the Color imageRUNNER is printed in enlarged size from the printer according to the print conditions set in the hot folder.
- You can create a new hot folder, edit or delete an existing one, and set print conditions at will.



• You can create up to 20 hot folders.

Note

Creating a New Hot Folder

- 1 Open the **Color imageRUNNER Enlargement Copy** dialog box, and then click the **Add** button.

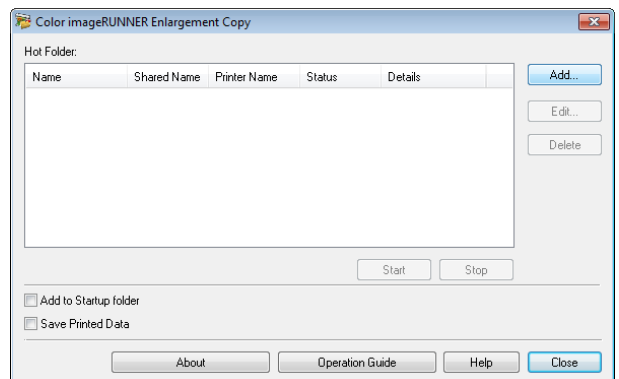

• For the step to open the **Color imageRUNNER Enlargement Copy** dialog box, see "Starting Color imageRUNNER Enlargement Copy." →P.221

Note

2 The **Easy Setup Wizard** dialog box displays. Click the **Next** button.

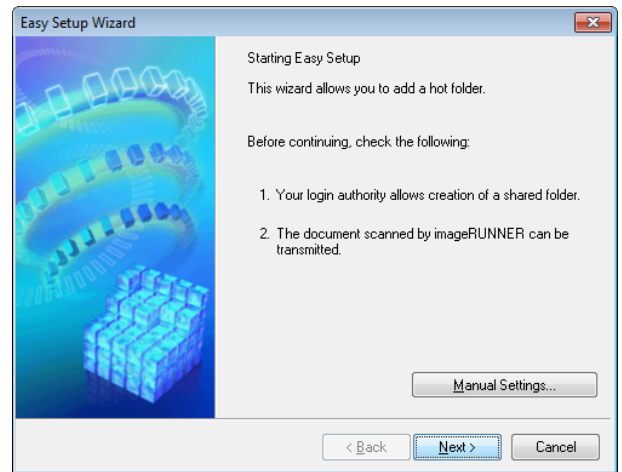

3 Select the type of printer to use. Click the **Next** button.

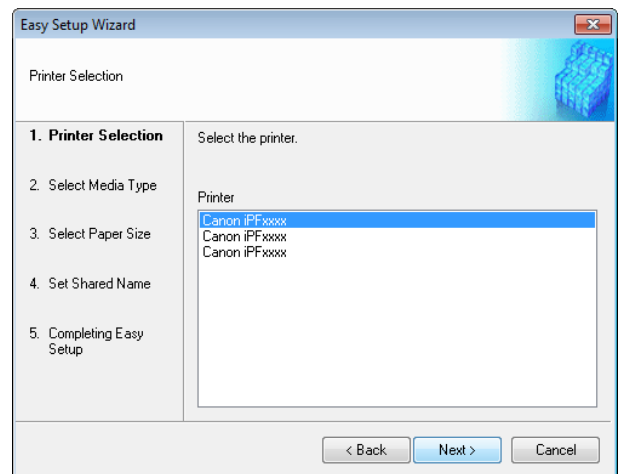

4 Select the media type to print.



- If the **Borderless Printing** checkbox is checked, only media types that can be used for borderless printing are displayed in the list.

Click the **Next** button.

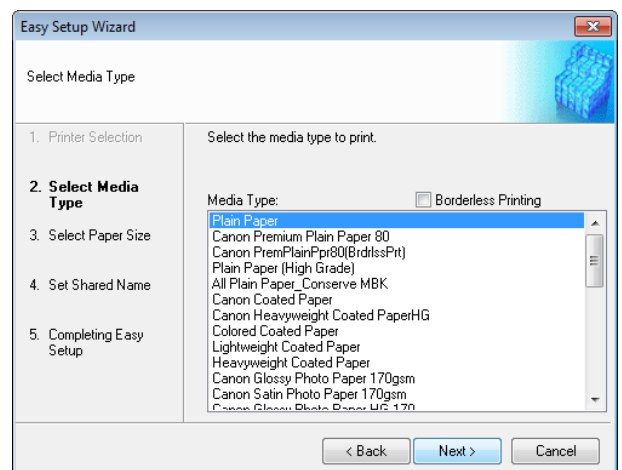

5 Select roll paper or cut sheet to print. Also, select the media size to print. Click the **Next** button.

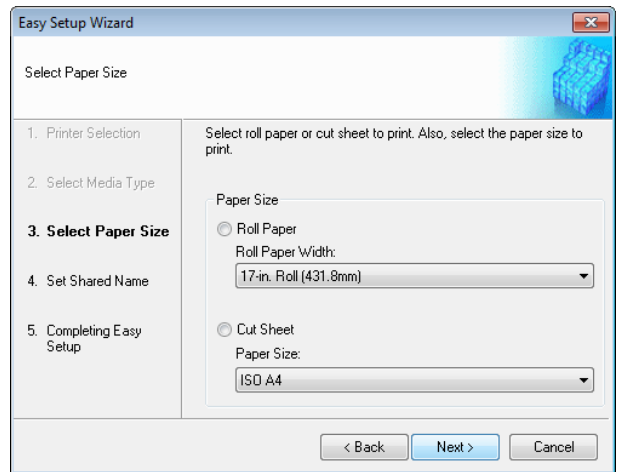

6 To receive a document scanned with the Color imageRUNNER, you need to share a folder. Enter the folder shared name in **Shared Name**. Click the **Next** button.

Note

- This shared name is used as the name of the hot folder.
- You cannot use the **Back** button, after clicking the **Next** button here.

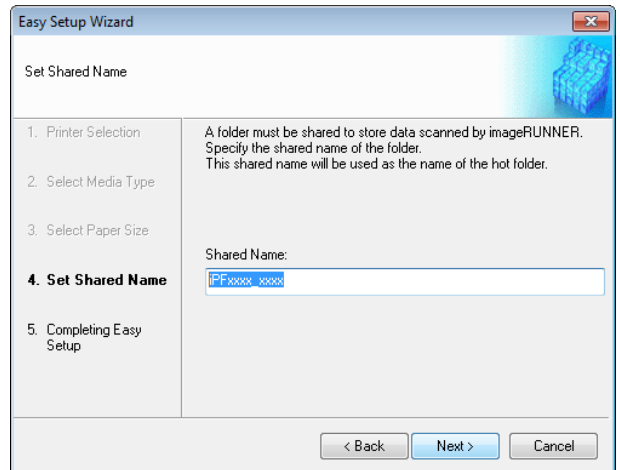

7 Click **Finish** button to close the **Easy Setup Wizard** dialog box.

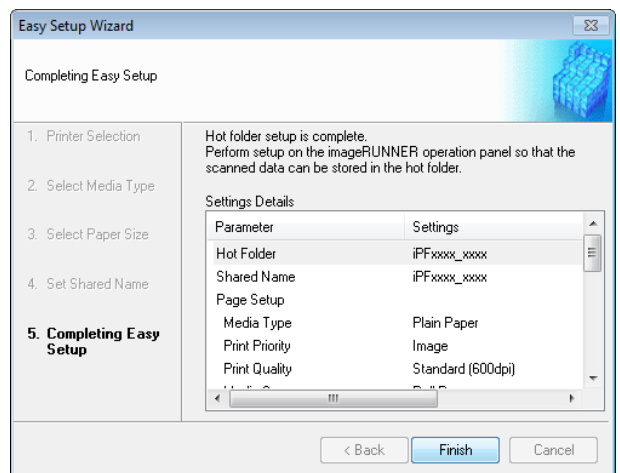

The hot folder you have created appears in the **Hot Folder** list in the **Color imageRUNNER Enlargement Copy** dialog box.

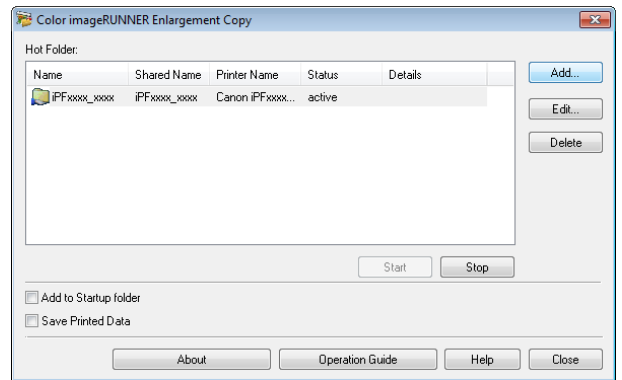

Specifying an Existing Shared Folder as a Hot Folder

- 1 Share the folder you want to specify as a hot folder.
- 2 Open the **Color imageRUNNER Enlargement Copy** dialog box, and then click the **Add** button.

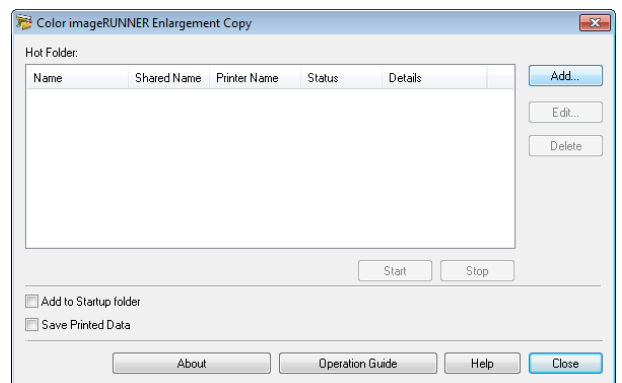

Note • For the step to open the **Color imageRUNNER Enlargement Copy** dialog box, see "Starting Color imageRUNNER Enlargement Copy." → P.221

- 3 The **Easy Setup Wizard** dialog box displays. Click the **Manual Settings** button.

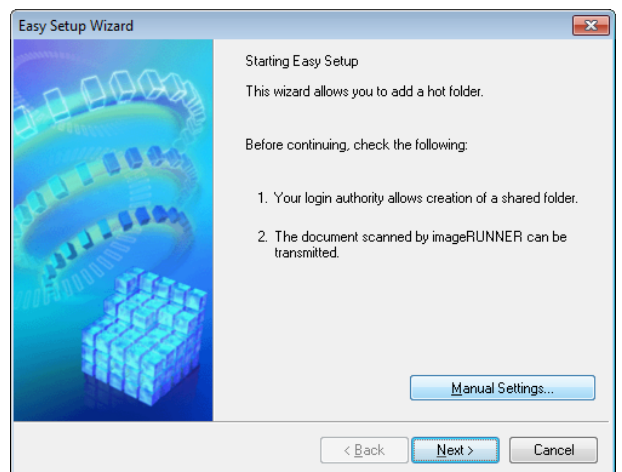

Windows Software
Color imageRUNNER Enlargement Copy

- 4** The **Add/Edit Hot Folder** dialog box displays. Enter the hot folder name in **Name**. Click the **Browse** button, with selecting **Specify a folder**, to set the existing shared folder.

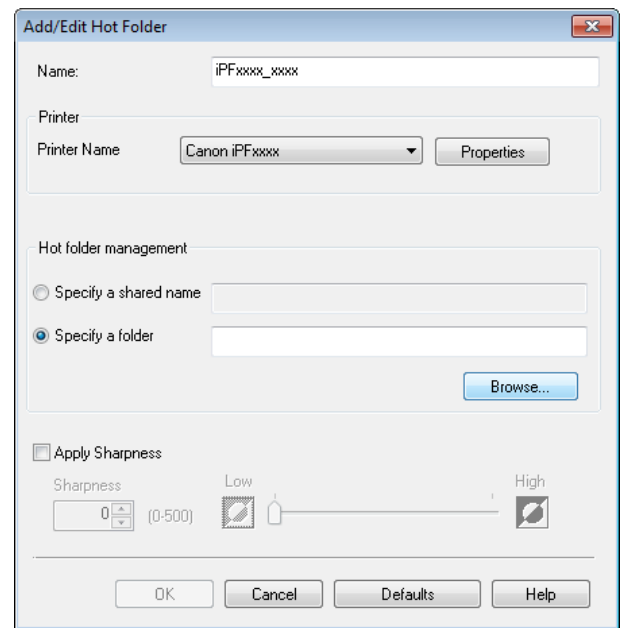

- 5** The location of the folders will appear. Select the folder to specify a hot folder, and click the **OK** button.

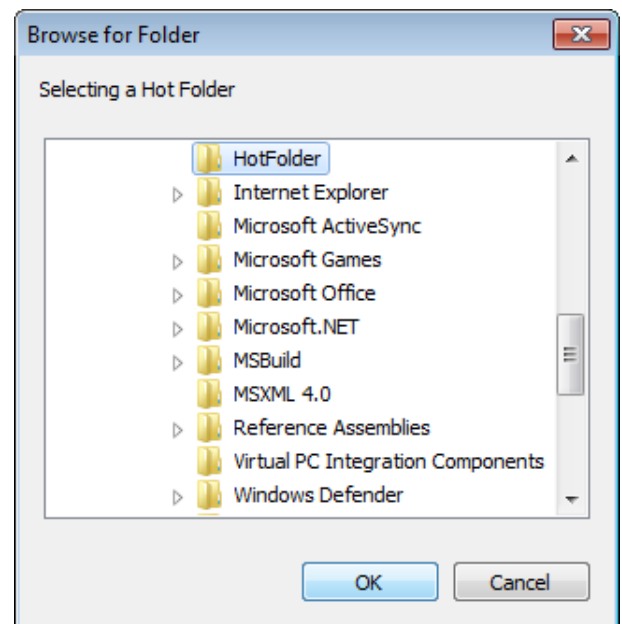

6 As necessary, set the print conditions in the hot folder. (See "Setting the Print Parameters.") →P.228
 Click the **OK** button to close the **Add/Edit Hot Folder** dialog box.

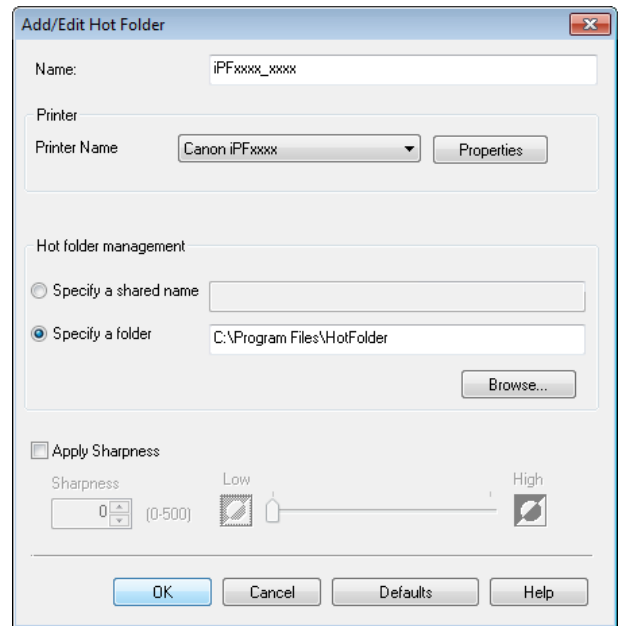

The hot folder you have created appears in the **Hot Folder** list in the **Color imageRUNNER Enlargement Copy** dialog box.

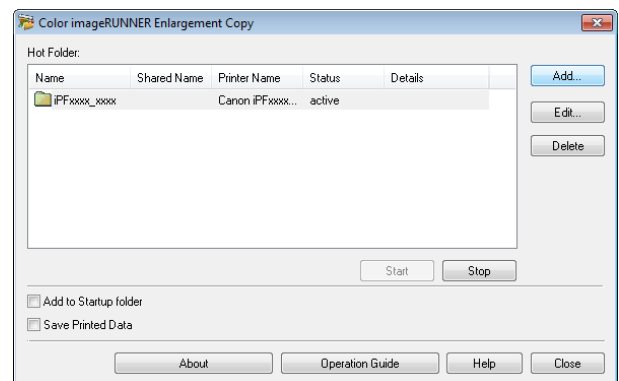

Setting the Print Parameters

The printer driver opens when you click the **Properties** button in the **Add/Edit Hot Folder** dialog box. The printer driver is used to configure basic settings to match the type of media loaded in the printer.

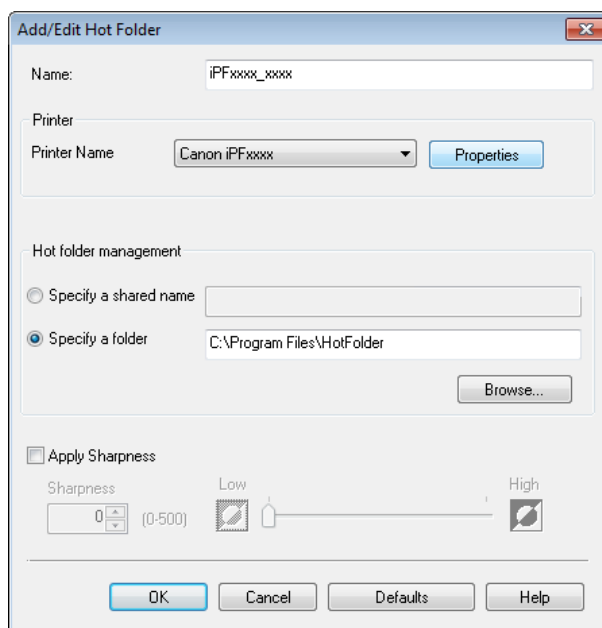

Refer to "Printer Driver" →P.158 for details on the printer driver.



- The only three sheets displayed are the **Main** sheet, the **Page Setup** sheet, and the **Layout** sheet. Some of the printer driver settings may be disabled.

• Apply Sharpness

Place a checkmark here to set the sharpness.

Drag the slider bar to the left or right to adjust. You can also adjust by directly entering a number in the numeric input field.



- You can input between 0 and 500.
- You can change the numbers by clicking either ▲ button or ▼ button.
- You cannot be applied to PDF files.

Printing Enlargements of Scanned Originals from a Color imageRUNNER

Scanned originals from a Color imageRUNNER can be enlarged and printed automatically.

Originals you create by scanning with a Color imageRUNNER are transferred to a "hot folder" and printed automatically after enlargement according to printing conditions you specify for that folder.

This processing sequence is called the **Color imageRUNNER Enlargement Copy** function.

To use **Color imageRUNNER Enlargement Copy**, first complete these settings in the following order.

1. Register a hot folder on your computer.
Register a hot folder on your computer for storing scanned originals from the Color imageRUNNER and complete the settings for enlargement copy. For details, see "**Creating a New Hot Folder.**" →P.223
2. Complete the scanning settings on the Color imageRUNNER.
Configure the Color imageRUNNER to send scanned originals to the hot folder.

After these settings are complete, you can print enlarged copies of scanned originals from the Color imageRUNNER.

Completing the scanning settings on the Color imageRUNNER.

Configure the Color imageRUNNER to send scanned originals to the hot folder. It is easy to send scanned originals to the hot folder if you assign the scanning settings and destination to a **Favorites** button on the Color imageRUNNER.

For instructions on assigning scanning settings and destinations to a **Favorites** button, refer to the setting manual, displayed by clicking **Color imageRUNNER Enlargement Copy Setup Manual** button of **Color imageRUNNER Enlargement Copy** utility, or refer to the Color imageRUNNER manual.

Scanning the original and print an enlargement

Follow the steps below to scan an original on the Color imageRUNNER for enlarged printing on the printer. For detailed instructions, refer to the Color imageRUNNER manual.

- 1 Load the original on the platen glass or document feeder of the Color imageRUNNER.
- 2 Press **Send** to display the screen for transmission.
- 3 Press **Favorites**, and then press the **Favorites** button assigned to the hot folder.
- 4 Press **Start** on the control panel. If you scan originals on the platen glass, after scanning all originals, press **Done** on the touch-panel display.
Scanned originals are sent to the hot folder and automatically enlarged and printed following the conditions you specified for the folder.

Print Plug-In for Office

Print Plug-In for Officefeatures	230
Steps to install	230
Steps to uninstall	233
When Print Plug-In for Office is not displayed	233
To start from Microsoft Word	236
Print Matching Roll Width(Word)	238
Borderless Printing(Word)	240
Multi-Page Printing(Word)	242
Register the settings (Word)	243
Print Using Registered Settings(Word)	244
Portrait Orientation/Landscape Orientation(Word)	246
To start from Microsoft PowerPoint	247
Print Matching Roll Width(PowerPoint)	249
Borderless Printing(PowerPoint)	250
Multi-Page Printing(PowerPoint)	252
Register the settings (PowerPoint)	254
Print Using Registered Settings(PowerPoint)	255
Portrait Orientation/Landscape Orientation(PowerPoint)	256
To start from Microsoft Excel	258
Print Entire Sheet(Excel)	259
Print Selected Area(Excel)	262
Configuring Binding (Excel)	264
Configuring Special Settings	265

Windows Software

Print Plug-In for Office

Print Plug-In for Officefeatures

Print Plug-In for Office is a Plug-In that enables easy printing from **Microsoft Office**.

- It is displayed on the toolbar/ribbon, so it is easily accessible.
- It can be set by just selecting from the Wizard.
- **Large-Format Printing** custom size can also be set in the Wizard from **Microsoft Word** or **Microsoft PowerPoint**.
- Custom size can be set automatically from **Microsoft Excel**.
- The layout can be checked before printing by starting the preview screen.



Note

- 64 bit edition Windows OS operates only on WOW64 (32 bit emulator).



Important

- The **Print Plug-In for Office** toolbar/ribbon might not be displayed in **Microsoft Office** after installing **imagePROGRAF Print Plug-In for Office**. For details, refer to "When Print Plug-In for Office is not displayed" → P.233 .
- If you opened the Office document from **Internet Explorer**, the software will not run correctly.
- If you are editing an embedded object or link object, the software will not run correctly.
- If you added the **imagePROGRAF Print Plug-In** ribbon to the **Microsoft Office** Quick Access toolbar, the software will not run correctly.

Steps to install

Below are the steps to install **Print Plug-In for Office**.



Note

- You must log into Windows as an Administrator before the installation.

1 Insert "User Software CD-ROM" into the CD-ROM drive and start the installer.



- If the installer screen does not appear automatically, open the CD-ROM drive icon of your computer and double-click the **iPFInst.exe** icon.

2 Click the **imagePROGRAF Print Plug-In** button.



3 Click the **Next** button.

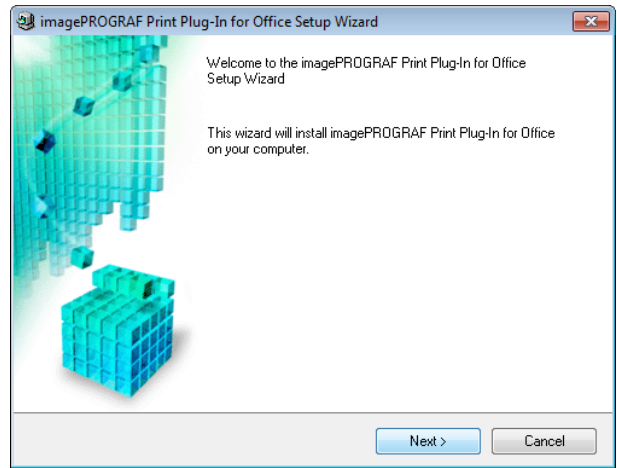

4 Read the **License Agreement**, and click the **Yes** button.

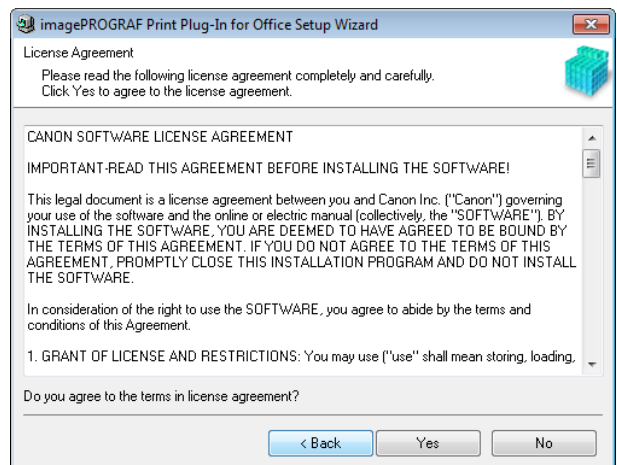

5 Click the **Start** button.

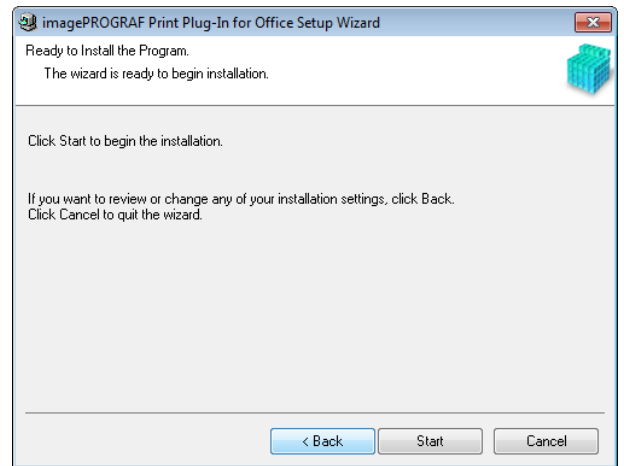

6 Click the **Yes** button.

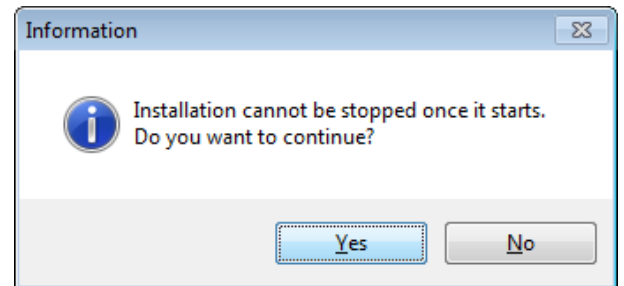

Note

- The following message may be displayed in Windows 8 or a later OS. If this happens, install the **.NET Framework** by following the procedure.

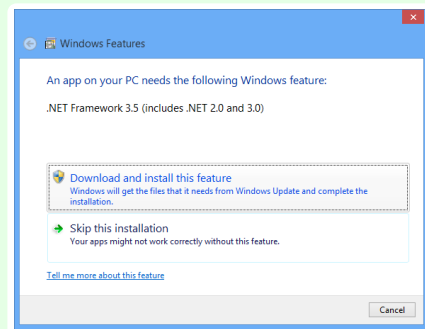

7 Click the **Exit** button.

The installation for **Print Plug-In for Office** is complete.

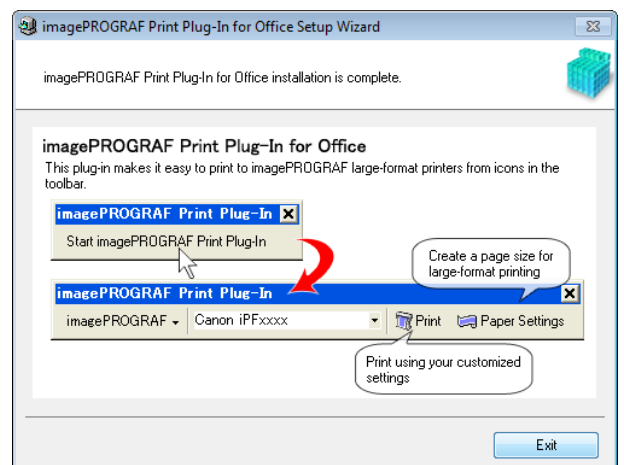



- When you install this software, the virtual printer **Canon imagePROGRAF PrintPlugIn** may be installed. If you want to use this software, do not uninstall the virtual printer **Canon imagePROGRAF PrintPlugIn**.
- The **Print Plug-In for Office** toolbar/ribbon might not be displayed in **Microsoft Office** after installing **imagePROGRAF Print Plug-In for Office**. Refer to the following topic for details on how to display the **imagePROGRAF Print Plug-In for Office** toolbar/ribbon.
 - When Print Plug-In for Office is not displayed →P.233

Steps to uninstall

Below are the steps to uninstall **Print Plug-In for Office**.

- 1** If **Microsoft Office** is open, close it.
- 2** Select **Control Panel** from the **start** menu.
- 3** Select **Uninstall a program**.
- 4** Select **imagePROGRAF Print Plug-In for Office**, and then click the **Uninstall** button.

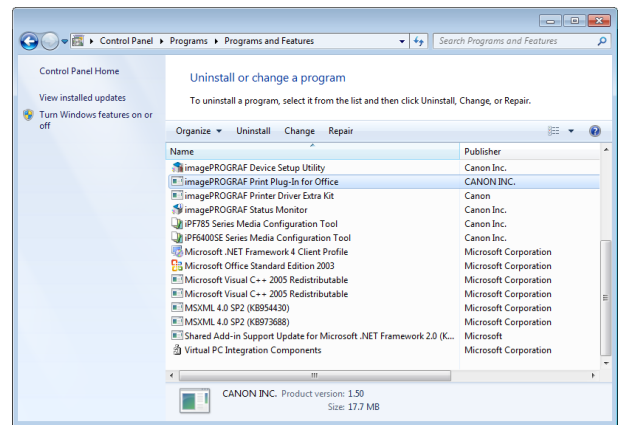

- You cannot uninstall **Print Plug-In for Office** if an Office application is running. When a message appears, select **Cancel** and close all Office applications that are running.

When Print Plug-In for Office is not displayed

Buttons such as **Start imagePROGRAF Print Plug-In** sometimes do not appear in the **Word, PowerPoint** and **Excel** Office applications, and the **Print Plug-In for Office** functions are not available.

In this event, re-install **Print Plug-In for Office**.

If you are using **Microsoft Office 2003** or later, you can also enable add-ins to display **Print Plug-In for Office**. See below for the procedure for re-installing the plug-in or enabling add-ins.

Re-installing Print Plug-In for Office

If a problem occurs, such as the system or an application terminating abnormally, the **Microsoft Office** application disables add-ins as a safety precaution.

In this event, you will need to re-install **Print Plug-In for Office** to display the **imagePROGRAF Print Plug-In** toolbar/ribbon.



- You cannot re-install **Print Plug-In for Office** once an Office application is running. When the message appears, select **Cancel** and close the active Office application.

Re-install **Print Plug-In for Office** as follows:

- 1** Close **Microsoft Office** if it is open.

2 Install **Print Plug-In for Office**.

For information about installing, see "Steps to install." → P.230

Enabling **Print Plug-In for Office** for items disabled in Office applications

If a problem occurs, such as the system or an application terminating abnormally, the **Microsoft Office** application disables add-ins as a safety precaution.

In this event, you will need to restore the disabled add-ins in order to display the **imagePROGRAF Print Plug-In** toolbar/ribbon.

Use the procedure below to restore the add-ins disabled by **Microsoft Office**.

- For **Microsoft Office 2010 or later**

1 Select **Options** from the **File** menu.

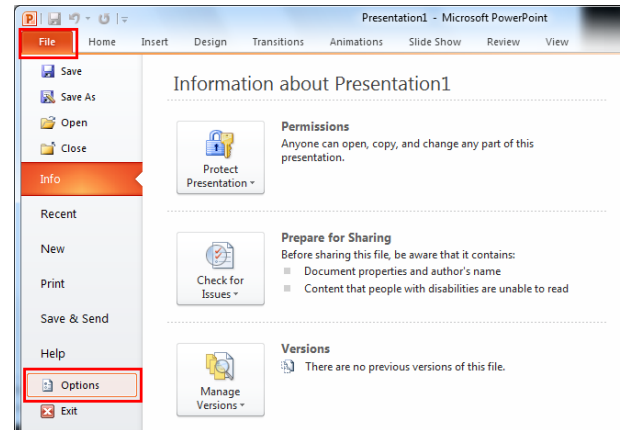

2 From the list on the left side of the <application name> options dialog box, select **Add-ins**.

3 Select **Disabled Items** in the **Manage** combo box and click the **Go** button.

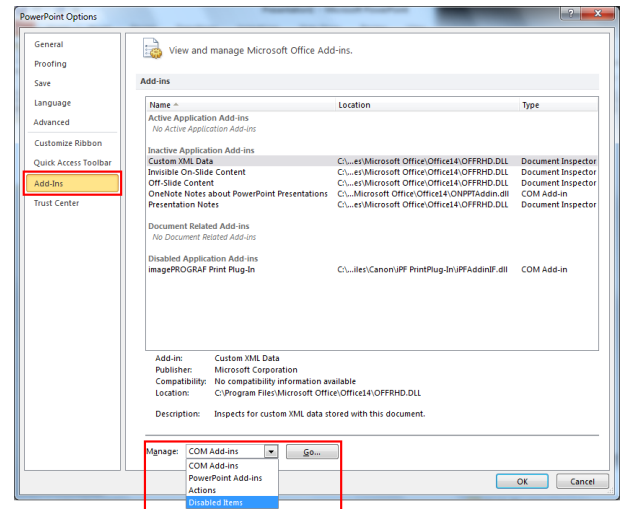

4 If **Addin imageprograf print plug-in (ipfaddinif.dll)** is displayed in the **Disabled Items** dialog box, select it and click the **Enable** button.

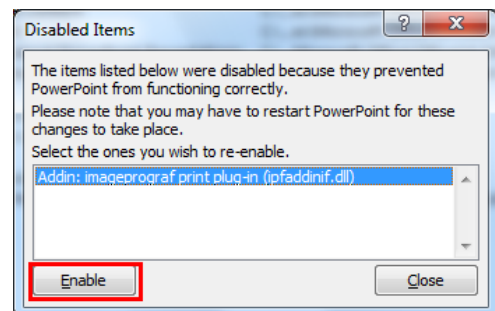

5 Close all the dialog boxes and restart the Office application.

- For **Microsoft Office 2007**

1 Click the **Office** button and then click the **<application name> options** button.

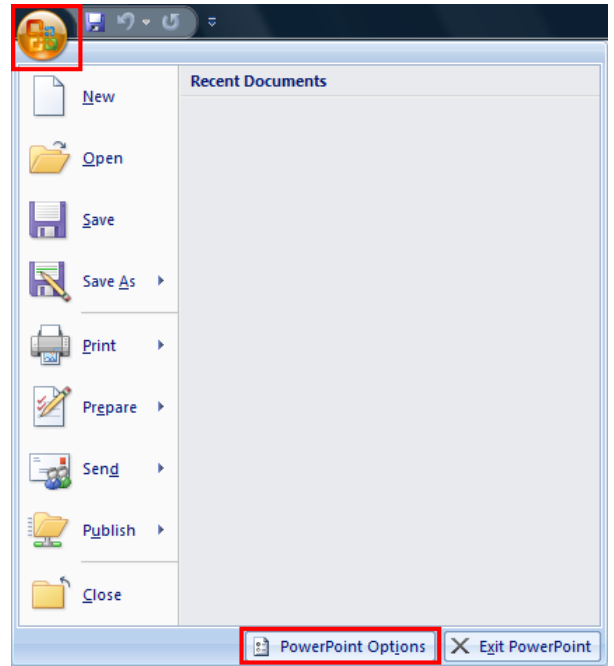

2 From the list on the left side of the **<application name> options** dialog box, select **Add-ins**.

3 Select **Disabled Items** in the **Manage** combo box and click the **Go** button.

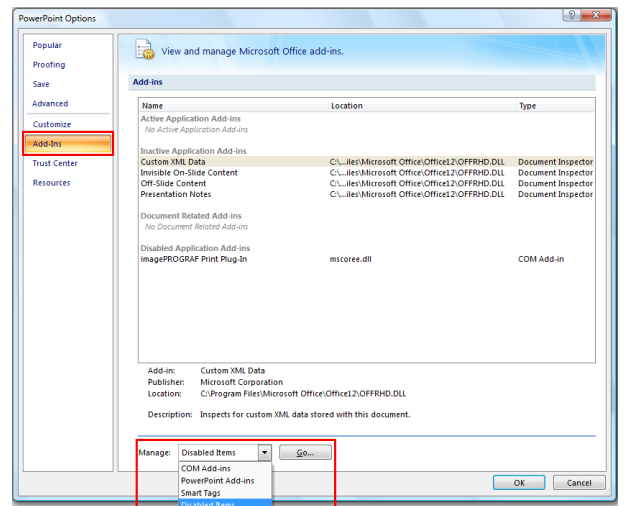

4 If **Addin imageprograf print plug-in (ipfaddinif.dll)** is displayed in the **Disabled Items** dialog box, select it and click the **Enable** button.

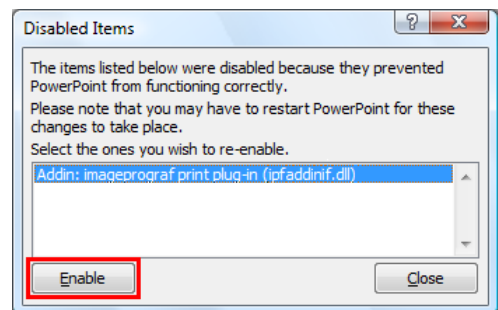

5 Close all the dialog boxes and restart the Office application.

- For **Microsoft Office 2003**

1 Click **About <application name>** in the **Help** menu of application.



2 Click the **Disabled Items** button in the **About <application name>** dialog box.

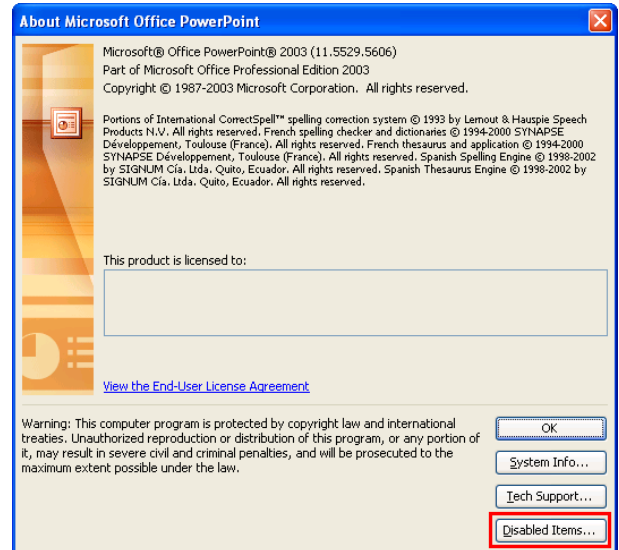

3 If **Addin imageprograf print plug-in (ipfaddinif.dll)** is displayed in the **Disabled Items** dialog box, select it and click the **Enable** button.

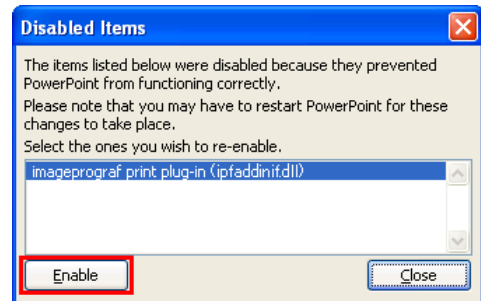

4 Close all the dialog boxes and restart the Office application.

To start from Microsoft Word

Below are the steps to start **Print Plug-In for Office** from **Microsoft Word**.

1 Start **Microsoft Word**.

2 If **Start imagePROGRAF Print Plug-In** is displayed on the toolbar/ribbon, click it.

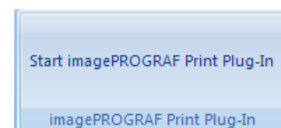

- If the **imagePROGRAF Print Plug-In** toolbar/ribbon is not displayed, refer to the following.
- "When Print Plug-In for Office is not displayed" →P.233

3 Check that the **imagePROGRAF Print Plug-In** toolbar/ribbon is displayed.

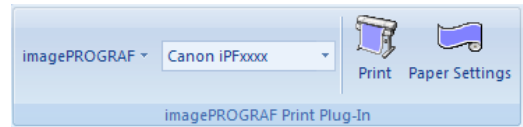

4 Click the buttons on the toolbar/ribbon according to the items you want to set.

Icon	Contents
Menu	Displays the About , Help , and Special Settings dialog boxes. You can change the settings using the Special Settings dialog box. Refer to "Configuring Special Settings" →P.265 for details.
Printer list	Select Printer. If you select Show All Printers , the imagePROGRAF printers will be displayed again. Select this when you want to display all printer drivers or update the display.
Print Button	The print Wizard is displayed. The settings Print Matching Roll Width , Borderless Printing , Multi-Page Printing , and Print Using Registered Settings can be set.
Paper Settings Button	Large-Format Wizard is displayed. Settings for Portrait or Landscape Orientation can be set.

Printing Wizard dialog box

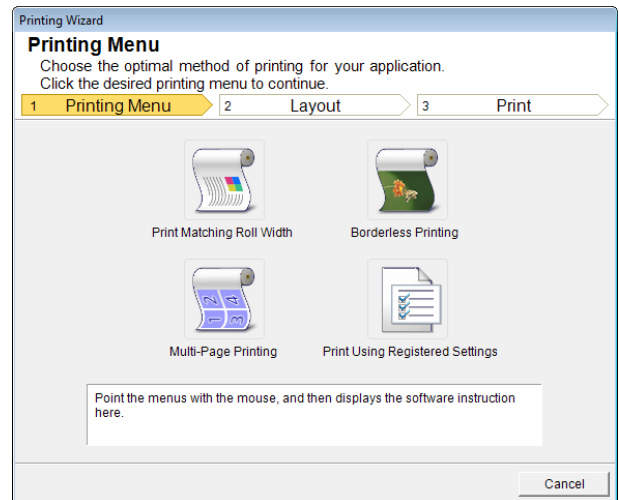

- If you want to change the display to another file or application while the **Printing Wizard** is open, close the **Printing Wizard** dialog box. Otherwise, you may not be able to change displays or operate the toolbar/ribbon.

Large-Format Printing Wizard dialog box

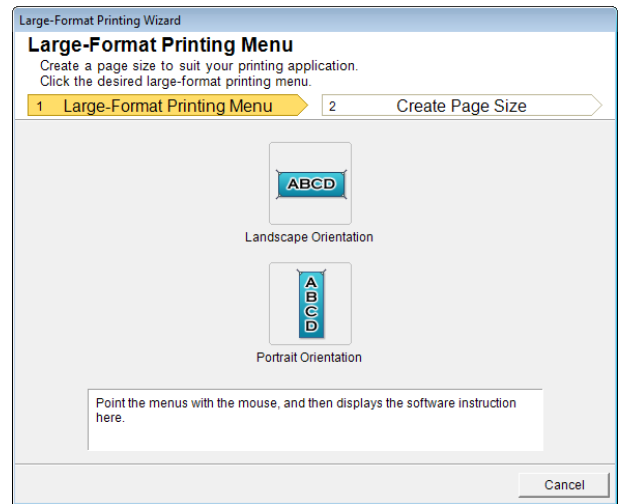

Important

- If you want to change the display to another file or application while the **Large-Format Printing Wizard** is open, close the **Large-Format Printing Wizard** dialog box. Otherwise, you may not be able to change displays or operate the toolbar/ribbon.
- The layout may collapse if you create a form using existing data. If that is the case, modify the data again.

Print Matching Roll Width(Word)

Prints to the edge of the roll width. You can print large exhibits and posters, and also print Portrait and Landscape orientations made in **Large-Format Printing Wizard**.

- 1 Start **Microsoft Word**.
- 2 If **Start imagePROGRAF Print Plug-In** is displayed, click it.

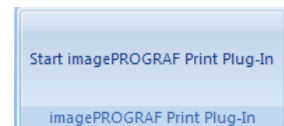

- 3 Click **Print** from the **imagePROGRAF Print Plug-In** toolbar/ribbon. The **Printing Wizard** dialog box is displayed.

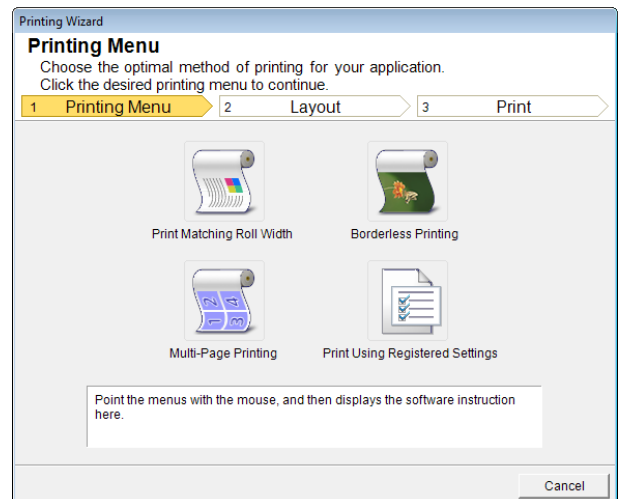

Important

- If you want to change the display to another file or application while the **Printing Wizard** is open, close the **Printing Wizard** dialog box. Otherwise, you may not be able to change displays or operate the toolbar/ribbon.

4 Click **Print Matching Roll Width**.

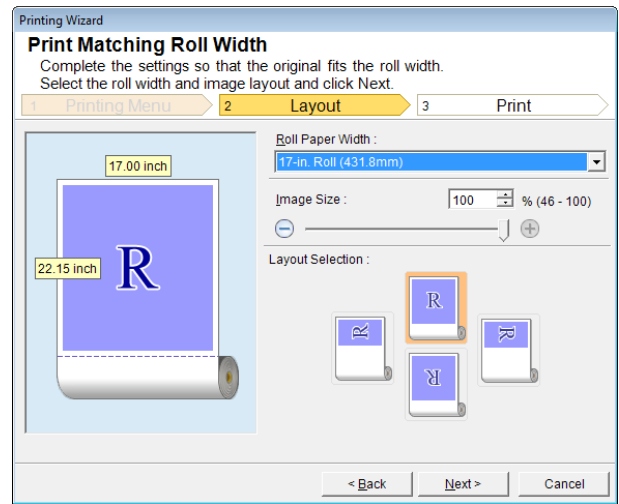

5 Select **Roll Paper Width** that is set in the printer.

6 Select image size.

7 Select layout.

8 Select **Next**.

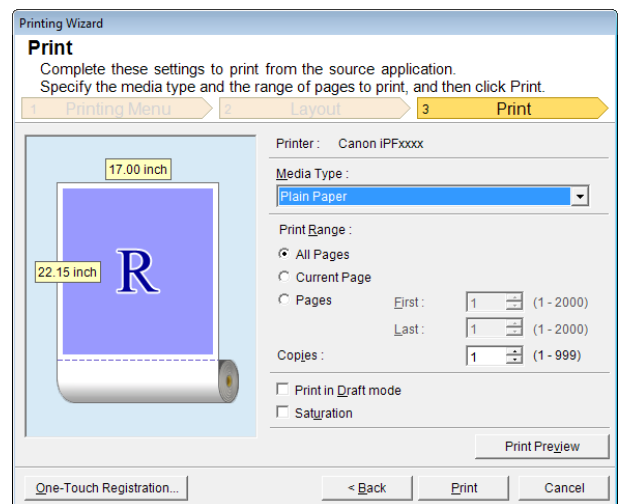

9 Select **Media Type**.

10 Select **Print Range** from **All Pages**, **Current Page**, and **Pages**.
If **Pages** is selected, enter the number of pages.

11 Enter **Copies**.

 **Note**

- When **Print in Draft mode** is selected, printing is fast but the print quality is poor.
- When **Saturation** is selected, you can print posters, etc., vividly.
- The settings are registered when the **One-Touch Registration** is pressed. This is convenient if you to need print multiple times using the same setting.
- Press the **Print Preview** button to display the preview screen. You can check and make changes to the layout in the preview screen.
- When you print to the edge of the roll width, the maximum length will be the lesser of 5.587 times the roll paper width, or 18.0m.

12 Press **Print** to start printing.

Borderless Printing(Word)

Prints up to the border of the media. Photos and posters can be printed without worrying about margins.

1 Start **Microsoft Word**.

2 If **Start imagePROGRAF Print Plug-In** is displayed, click it.

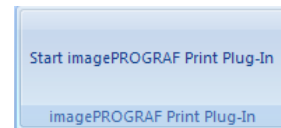

3 Click **Print** from the **imagePROGRAF Print Plug-In** toolbar/ribbon. The **Printing Wizard** dialog box is displayed.

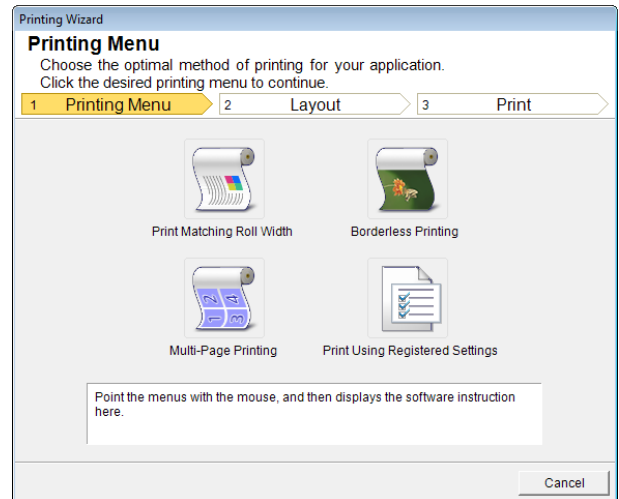

• If you want to change the display to another file or application while the **Printing Wizard** is open, close the **Printing Wizard** dialog box. Otherwise, you may not be able to change displays or operate the toolbar/ribbon.

4 Click **Borderless Printing**.

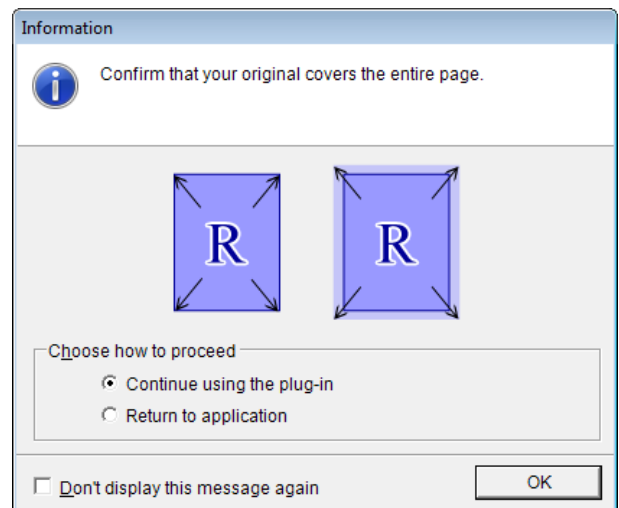

5 A confirmation dialog box is displayed. If the data fills up the page, confirm that **Continue using the plug-in** is selected in **Choose how to proceed** and press **OK**.



• To adjust the data, select **Return to application** and press **OK**. Exit **Print Plug-In for Office** and return to the application.

Windows Software
Print Plug-In for Office

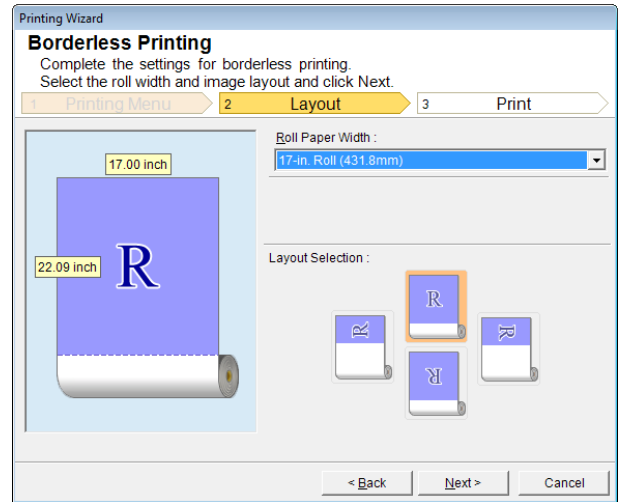

- 6** Select **Roll Paper Width** that is set in the printer.
- 7** Select layout.
- 8** Select **Next**.

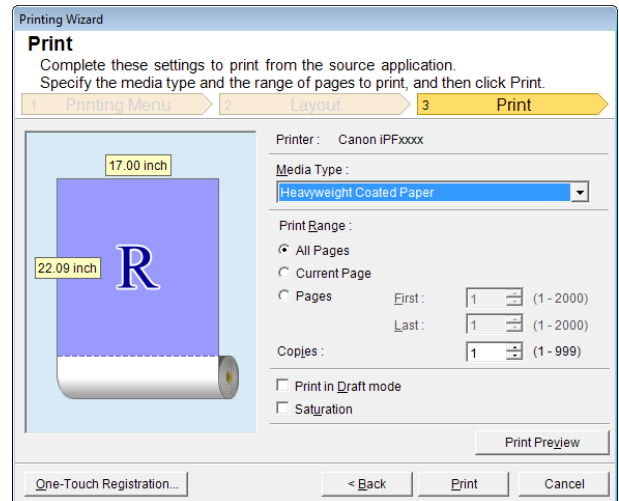

- 9** Select **Media Type**.
- 10** Select **Print Range** from **All Pages**, **Current Page**, and **Pages**. If **Pages** is selected, enter the number of pages.
- 11** Enter **Copies**.

 **Note**

- When **Print in Draft mode** is selected, printing is fast but the print quality is poor.
- When **Saturation** is selected, you can print posters, etc., vividly.
- Press the **One-Touch Registration** button to register the settings. This is useful for multiple printing using the same settings.
- Press the **Print Preview** button to display the preview screen. You can confirm and make changes to the layout in the preview screen.
- The maximum length for Borderless Printing is the lesser of 5.587 times the roll paper width, or 18.0m.

- 12** Press **Print** to start printing.

Multi-Page Printing(Word)

Prints multiple pages as one page. You can print handouts into a single page, or print matter with many pages.

1 Start **Microsoft Word**.

2 If **Start imagePROGRAF Print Plug-In** is displayed, click it.

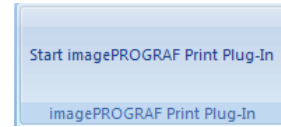

3 Click **Print** from the **imagePROGRAF Print Plug-In** toolbar/ribbon. The **Printing Wizard** dialog box is displayed.

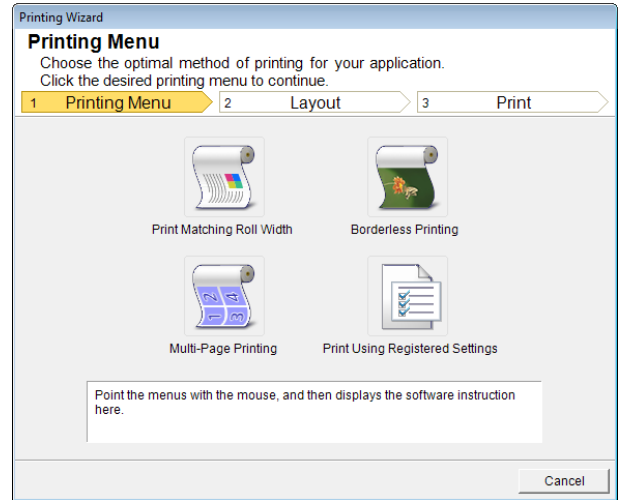

• If you want to change the display to another file or application while the **Printing Wizard** is open, close the **Printing Wizard** dialog box. Otherwise, you may not be able to change displays or operate the toolbar/ribbon.

4 Click **Multi-Page Printing**.

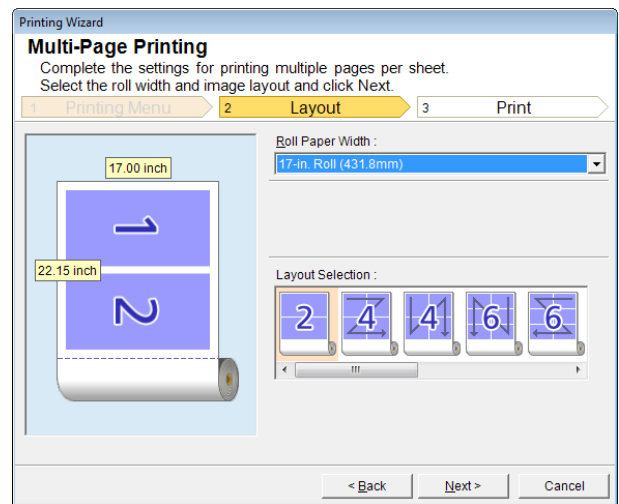

5 Select **Roll Paper Width** that is set in the printer.

6 Select layout from **Layout Selection**.

7 Select Next.

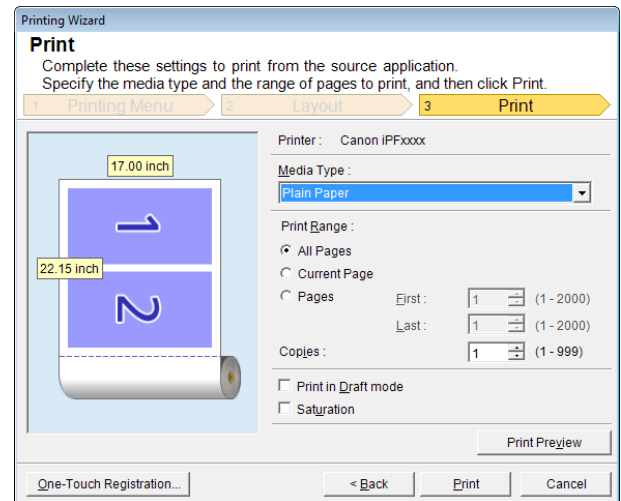

8 Select Media Type.

9 Select Print Range from All Pages, Current Page, and Pages. If Pages is selected, enter the number of pages.

10 Enter Copies.



Note

- When **Print in Draft mode** is selected, printing is fast but the print quality is poor.
- When **Saturation** is selected, you can print posters, etc., vividly.
- The settings are registered when the **One-Touch Registration** is pressed. This is convenient if you need to print multiple times using the same setting.
- Press the **Print Preview** button to display the preview screen. You can check and make changes to the layout in the preview screen.
- The maximum length for Multi-Page Printing is the lesser of 5.587 times the roll paper width, or 18.0m.

11 Press Print to start printing.

Register the settings (Word)

If you are going to print multiple times using the same setting, you can select **One-Touch Registration**. Registered settings can be recalled from **Print Using Registered Settings**.

1 Set up to the Print screen from Print Matching Roll Width, Borderless Printing or Multi-Page Printing of Printing Menu.



Note

- Up to 20 items can be registered.
- The available settings are as follows.
 - **Print Matching Roll Width(Word)** → P.238
 - **Borderless Printing(Word)** → P.240
 - **Multi-Page Printing(Word)** → P.242

2 Click the **One-Touch Registration** button.

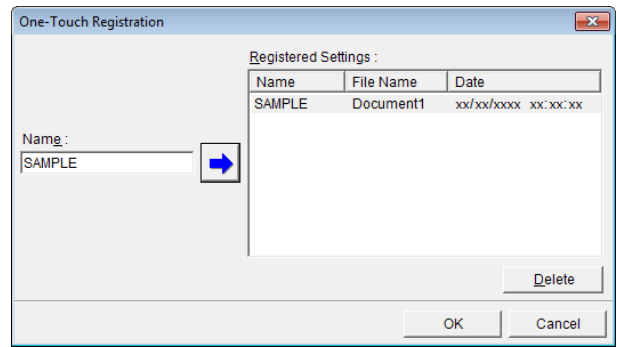

3 Enter name in **Name**.
Up to 31 characters can be entered.

4 Click . The name you entered is displayed in **Registered Settings**.

5 Click **OK**, and return to the **Print** screen.

6 Click **Print** to print, and click **Cancel** to cancel the print.



• Clicking **Cancel** in the **Print** screen will not delete the registered settings.

Note

Print Using Registered Settings(Word)

Prints using the registered settings.

1 Start **Microsoft Word**.

2 If **Start imagePROGRAF Print Plug-In** is displayed, click it.

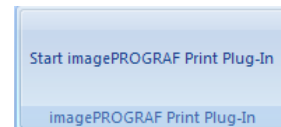

3 Click **Print** from the **imagePROGRAF Print Plug-In** toolbar/ribbon.
The **Printing Wizard** dialog box is displayed.

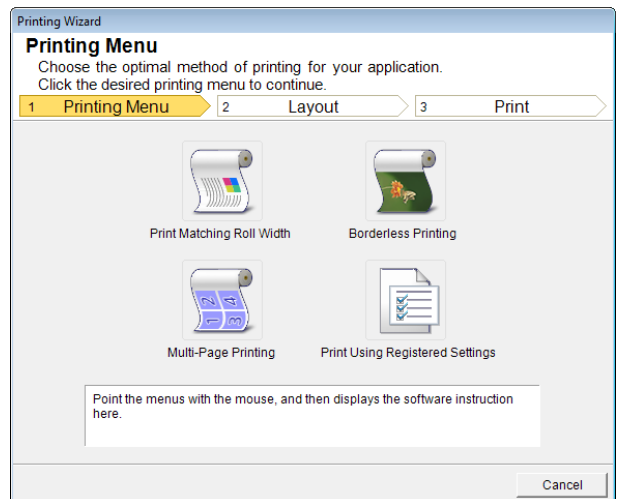

• If you want to change the display to another file or application while the **Printing Wizard** is open, close the **Printing Wizard** dialog box. Otherwise, you may not be able to change displays or operate the toolbar/ribbon.

4 Click **Print Using Registered Settings**.

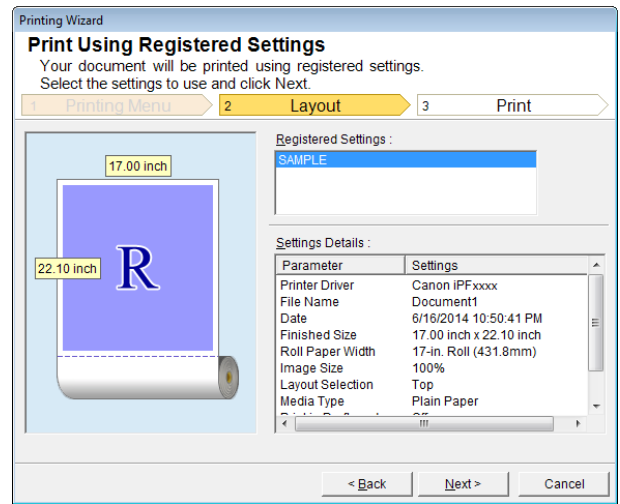

5 Click the **Next** button.

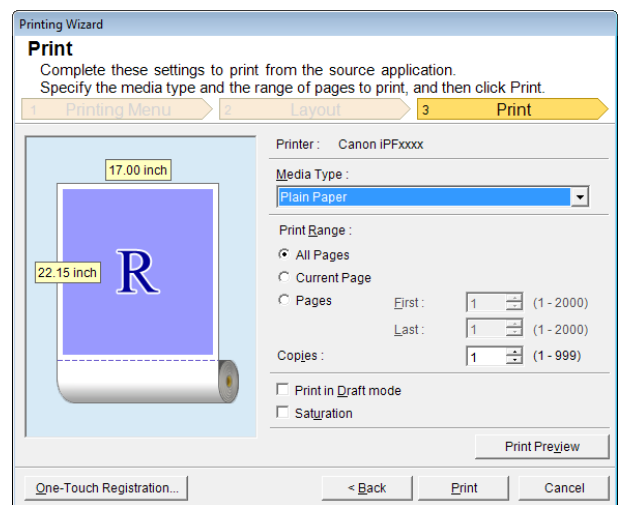

6 Select **Media Type**.

7 Select **Print Range** from **All Pages**, **Current Page**, or **Pages**.
If **Pages** is selected, enter the number of pages.

8 Enter **Copies**.



Note

- When **Print in Draft mode** is selected, printing is fast but the print quality is poor.
- When **Saturation** is selected, you can print posters, etc., vividly.
- Press the **Print Preview** button to display the preview screen. You can check and make changes to the layout in the preview screen.
- The maximum print length when printing with the registered settings is the lesser of 5.587 times the roll paper width, or 18.0m.

9 Press **Print** to start printing.

Portrait Orientation/Landscape Orientation(Word)

Print to the edge of the roll width. You can print large exhibits and posters, or print the Landscape or Portrait Orientation Page Sizes made in the **Large-Format Printing Wizard**.

Create Page Size in Portrait or Landscape Orientation.

Use the **Large-Format Printing Wizard** to create portrait page sizes for Potrait Orientation, and landscape page sizes for Landscape Orientation.

1 Start **Microsoft Word**.

2 If **Start imagePROGRAF Print Plug-In** is displayed, click it.

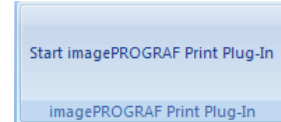

3 Click **Paper Settings** from the **imagePROGRAF Print Plug-In** toolbar/ribbon. The **Large-Format Printing Wizard** dialog box is displayed.



- If you want to change the display to another file or application while the **Large-Format Printing Wizard** is open, close the **Large-Format Printing Wizard** dialog box. Otherwise, you may not be able to change displays or operate the toolbar/ribbon.

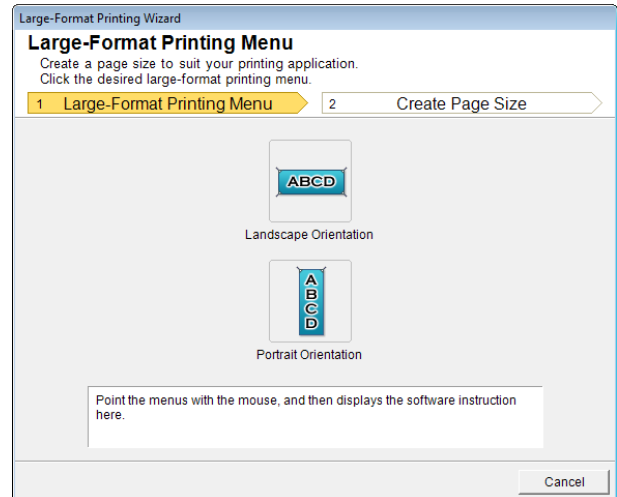

4 Click **Portrait Orientation** or **Landscape Orientation**.



- The steps taken to create a Portrait Page Size will be used as an example to explain the procedure.

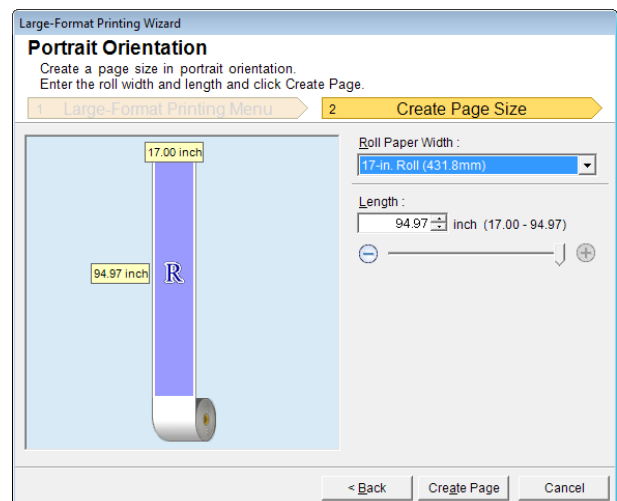

5 Adjust **Length** from the list-box or slide-bar.

6 Click the **Create Page** button.

7 Click **OK** if the message is displayed.

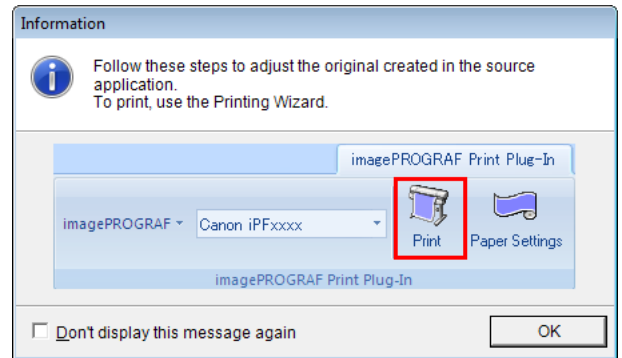

8 Edit and create the document.



• Printing is done in **Print Matching Roll Width** of the **Printing Wizard**. For details on **Print Matching Roll Width**, see "Print Matching Roll Width(Word)." → P.238



Important

• The layout may collapse if you create a form using existing data. If that is the case, modify the data again.

To start from Microsoft PowerPoint

Below are the steps to start **Print Plug-In for Office** from **Microsoft PowerPoint**.

1 Start **Microsoft PowerPoint**.

2 If **Start imagePROGRAF Print Plug-In** is displayed on the toolbar/ribbon, click it.

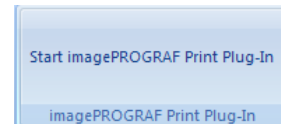

Important



• If the **imagePROGRAF Print Plug-In** toolbar/ribbon is not displayed, refer to the following.

• When **Print Plug-In for Office** is not displayed → P.233

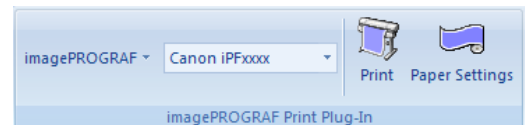
3 Check that the **imagePROGRAF Print Plug-In** toolbar/ribbon is displayed.

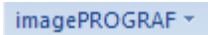
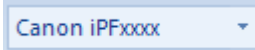

4 Click the buttons on the toolbar/ribbon according to the items you want to set.

Icon	Contents
 Menu	Displays the About , Help , and Special Settings dialog boxes. (See "Configuring Special Settings.") → P.265
 Printer list	Select Printer. If you select Show All Printers , the imagePROGRAF printers will be displayed again. Select this when you want to display all printer drivers or update the display.
 PrintButton	The print Wizard is displayed. The settings Print Matching Roll Width , Borderless Printing , Multi-Page Printing , and Print Using Registered Settings can be set.

Icon	Contents
 <p>Paper Settings Paper Settings Button</p>	<p>Large-Format Wizard is displayed. Settings for Portrait or Landscape Orientation can be set.</p>

Printing Wizard dialog box

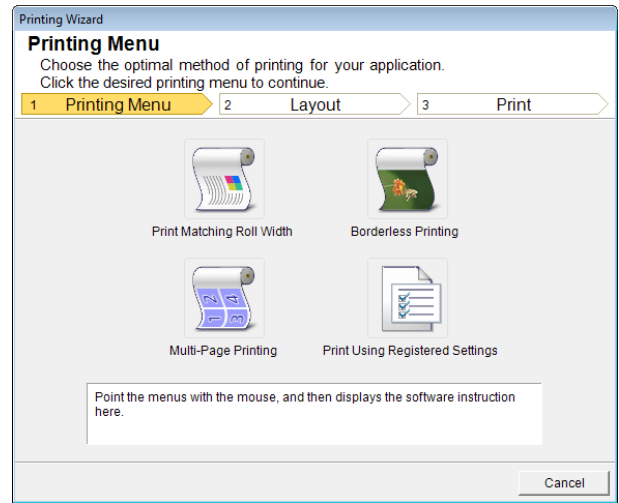

Important • If you want to change the display to another file or application while the **Printing Wizard** is open, close the **Printing Wizard** dialog box. Otherwise, you may not be able to change displays or operate the toolbar/ribbon.

Note • If you open a password protected document as read-only, the **Printing Wizard** cannot be run.

Large-Format Printing Wizard dialog box

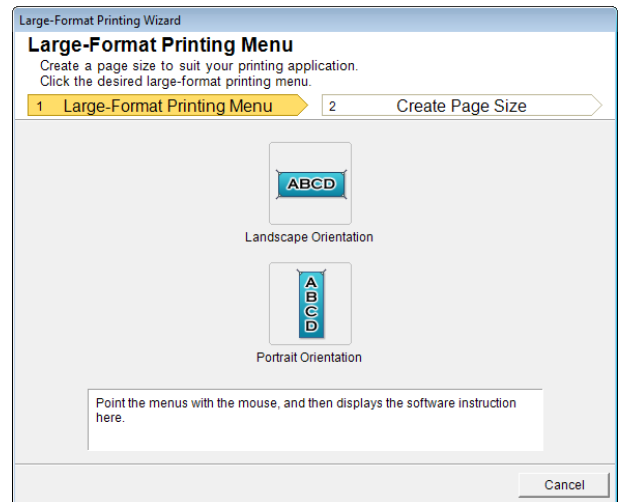

Important • If you want to change the display to another file or application while the **Large-Format Printing Wizard** is open, close the **Large-Format Printing Wizard** dialog box. Otherwise, you may not be able to change displays or operate the toolbar/ribbon.

• The layout may collapse if you create a form using existing data. If that is the case, modify the data again.

Note • If you open a password protected document as read-only, the **Large-Format Printing Wizard** cannot be run. Remove the password protection.

Windows Software
Print Plug-in for Office

Print Matching Roll Width(PowerPoint)

Prints to the edge of the roll width. You can print large exhibits and posters, and also print Portrait and Landscape orientations made in **Large-Format Printing Wizard**.

- 1** Start **Microsoft PowerPoint**.
- 2** If **Start imagePROGRAF Print Plug-In** is displayed, click it.

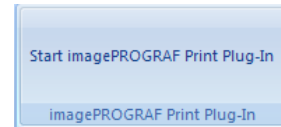

- 3** Click **Print** from the **imagePROGRAF Print Plug-In** toolbar/ribbon. The **Printing Wizard** dialog box is displayed.

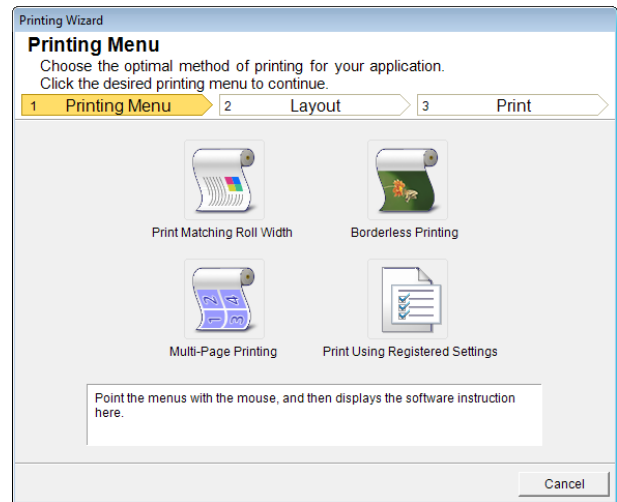

Important • If you want to change the display to another file or application while the **Printing Wizard** is open, close the **Printing Wizard** dialog box. Otherwise, you may not be able to change displays or operate the toolbar/ribbon.

- 4** Click **Print Matching Roll Width**.

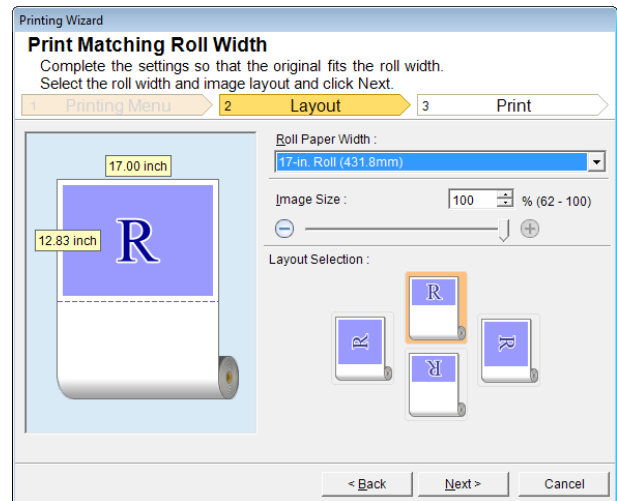

- 5** Select **Roll Paper Width** that is set in the printer.
- 6** Select image size.
- 7** Select layout.

8 Select **Next**.

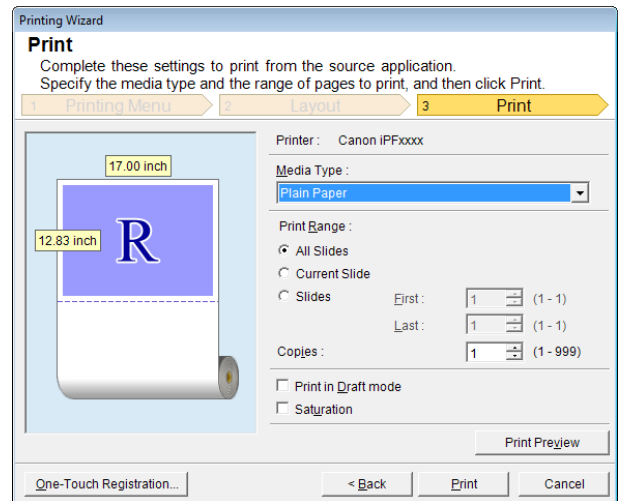

9 Select **Media Type**.

10 Select **Print Range** from **All Slides**, **Current Slide**, and **Slides**.
If **Slides** is selected, enter the slide number.

11 Enter **Copies**.

-  **Note**
- When **Print in Draft mode** is selected, printing is fast but the print quality is poor.
- When **Saturation** is selected, you can print posters, etc., vividly.
- The settings are registered when the **One-Touch Registration** is pressed. This is convenient if you to need print multiple times using the same setting.
- Press the **Print Preview** button to display the preview screen. You can check and make changes to the layout in the preview screen.
- When you print to the edge of the roll width, the maximum length will be the lesser of 14.22 times the roll paper width, or 18.0m.

12 Press **Print** to start printing.

Borderless Printing(PowerPoint)

Prints up to the border of the media. Photos and posters can be printed without worrying about margins.

1 Start **Microsoft PowerPoint**.

2 If **Start imagePROGRAF Print Plug-In** is displayed, click it.

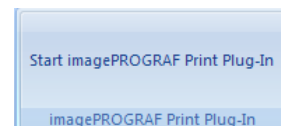

- 3 Click **Print** from the **imagePROGRAF Print Plug-In** toolbar/ribbon. The **Printing Wizard** dialog box is displayed.

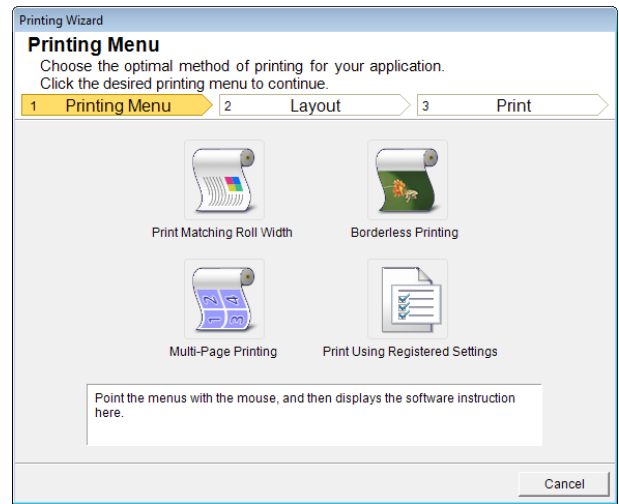

Important

- If you want to change the display to another file or application while the **Printing Wizard** is open, close the **Printing Wizard** dialog box. Otherwise, you may not be able to change displays or operate the toolbar/ribbon.

- 4 Click **Borderless Printing**.

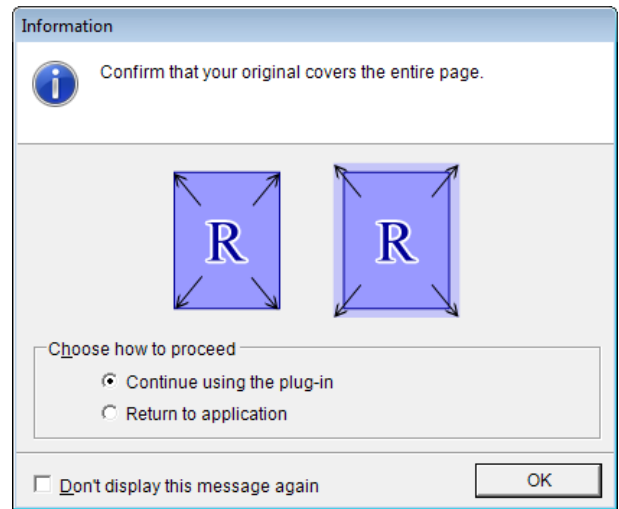

- 5 A confirmation dialog box is displayed. If the data fills up the page, confirm that **Continue using the plug-in** is selected in **Choose how to proceed** and press **OK**.

Note

- To adjust the data, select **Return to application** and press **OK**. Exit **Print Plug-In for Office** and return to the application.

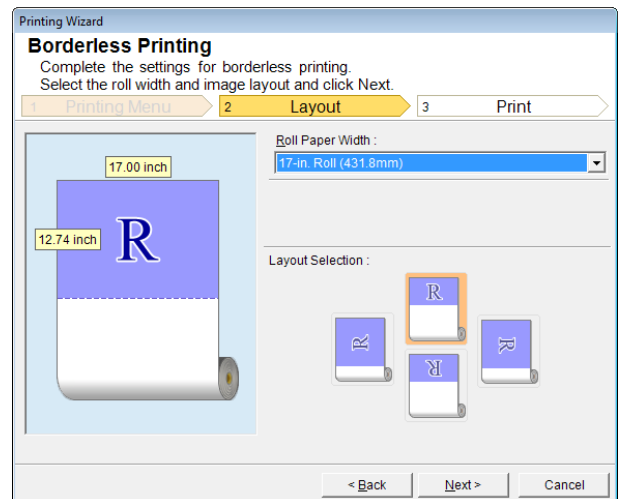

6 Select **Roll Paper Width** that is set in the printer.

7 Select layout.

8 Select **Next**.

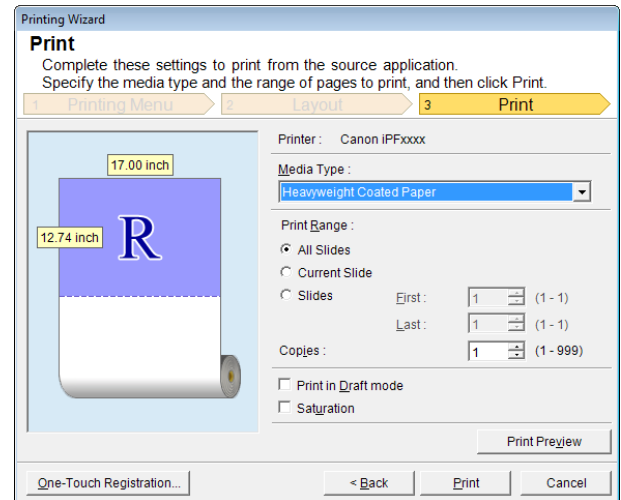

9 Select **Media Type**.

10 Select **Print Range** from **All Slides**, **Current Slide**, and **Slides**.
If **Slides** is selected, enter the slide number.

11 Enter **Copies**.



Note

- When **Print in Draft mode** is selected, printing is fast but the print quality is poor.
- When **Saturation** is selected, you can print posters, etc., vividly.
- Press the **One-Touch Registration** button to register the settings. This is useful for multiple printing using the same settings.
- Press the **Print Preview** button to display the preview screen. You can confirm and make changes to the layout in the preview screen.
- The maximum length for Borderless Printing is the lesser of 14.22 times the roll paper width, or 18.0m.

12 Press **Print** to start printing.

Multi-Page Printing(PowerPoint)

Prints multiple pages as one page. You can print handouts into a single page, or print matter with many pages.

1 Start **Microsoft PowerPoint**.

2 If **Start imagePROGRAF Print Plug-In** is displayed, click it.

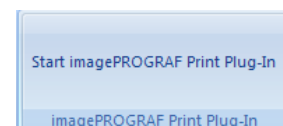

- 3 Click **Print** from the **imagePROGRAF Print Plug-In** toolbar/ribbon. The **Printing Wizard** dialog box is displayed.

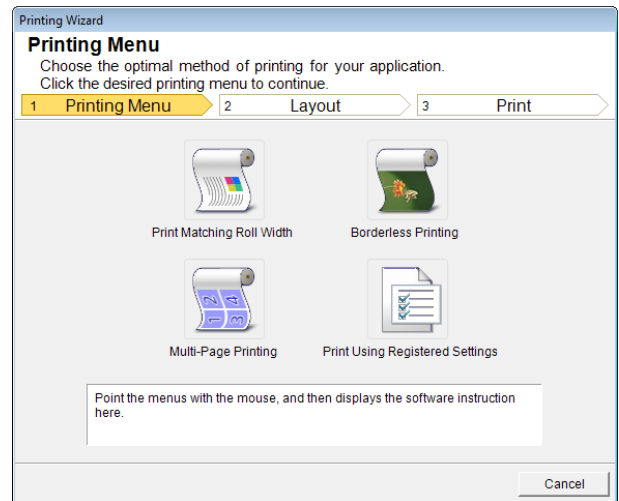

Important • If you want to change the display to another file or application while the **Printing Wizard** is open, close the **Printing Wizard** dialog box. Otherwise, you may not be able to change displays or operate the toolbar/ribbon.

- 4 Click **Multi-Page Printing**.

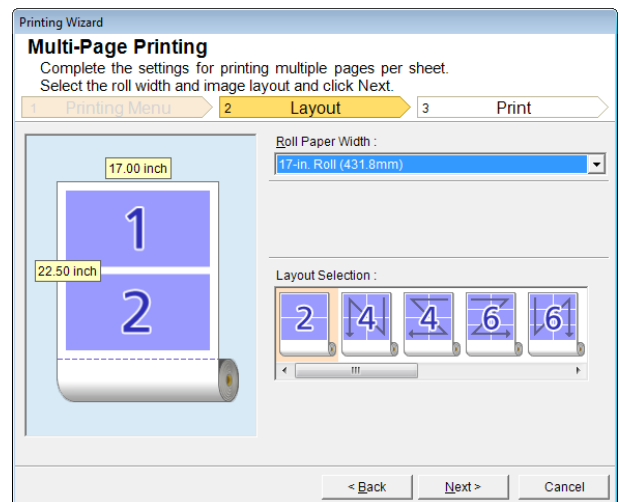

- 5 Select **Roll Paper Width** that is set in the printer.

- 6 Select layout from **Layout Selection**.

- 7 Select **Next**.

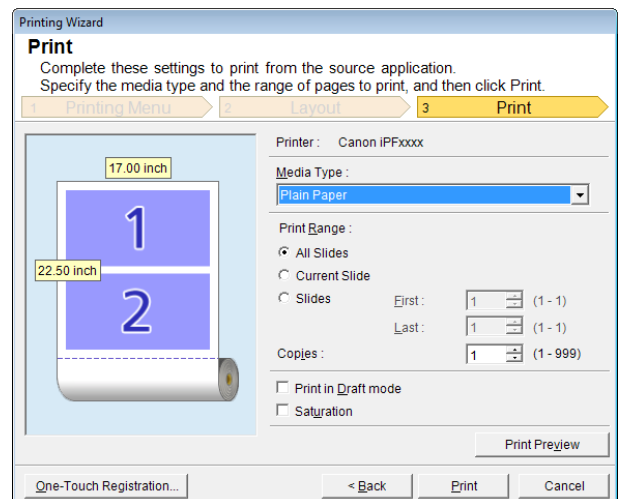

8 Select **Media Type**.

9 Select **Print Range** from **All Slides**, **Current Slide**, and **Slides**.
If **Slides** is selected, enter the slide number.

10 Enter **Copies**.



Note

- When **Print in Draft mode** is selected, printing is fast but the print quality is poor.
- When **Saturation** is selected, you can print posters, etc., vividly.
- The settings are registered when the **One-Touch Registration** is pressed. This is convenient if you need print multiple times using the same setting.
- Press the **Print Preview** button to display the preview screen. You can check and make changes to the layout in the preview screen.
- The maximum length for Multi-Page Printing is the lesser of 14.22 times the roll paper width, or 18.0m.

11 Press **Print** to start printing.

Register the settings (PowerPoint)

If you are going to print multiple times using the same setting, you can select **One-Touch Registration**. Registered settings can be recalled from **Print Using Registered Settings**.

1 Set up to the **Print** screen from **Print Matching Roll Width**, **Borderless Printing** or **Multi-Page Printing** of **Printing Menu**.



Note

- Up to 20 items can be registered.
- The available settings are as follows.
 - **Print Matching Roll Width(PowerPoint)** → P.249
 - **Borderless Printing(PowerPoint)** → P.250
 - **Multi-Page Printing(PowerPoint)** → P.252

2 Click the **One-Touch Registration** button.

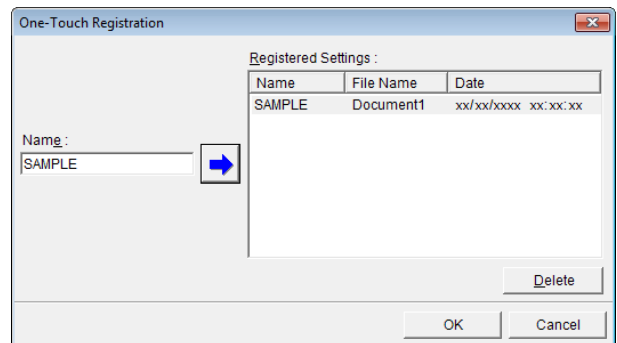

3 Enter name in **Name**.
Up to 31 characters can be entered.

4 Click . The name you entered is displayed in **Registered Settings**.

5 Click **OK**, and return to the **Print** screen.

6 Click **Print** to print, and click **Cancel** to cancel the print.



Note

- Clicking **Cancel** in the **Print** screen will not delete the registered settings.

Print Using Registered Settings(PowerPoint)

Prints using the registered settings.

1 Start **Microsoft PowerPoint**.

2 If **Start imagePROGRAF Print Plug-In** is displayed, click it.

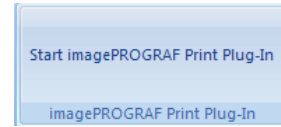

3 Click **Print** from the **imagePROGRAF Print Plug-In** toolbar/ribbon. The **Printing Wizard** dialog box is displayed.

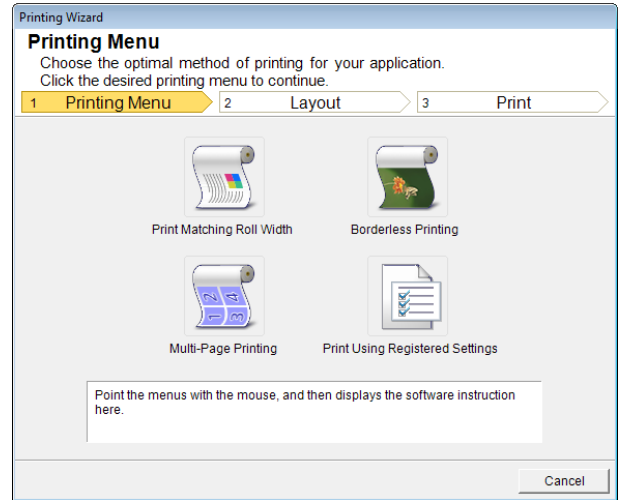

Important • If you want to change the display to another file or application while the **Printing Wizard** is open, close the **Printing Wizard** dialog box. Otherwise, you may not be able to change displays or operate the toolbar/ribbon.

4 Click **Print Using Registered Settings**.

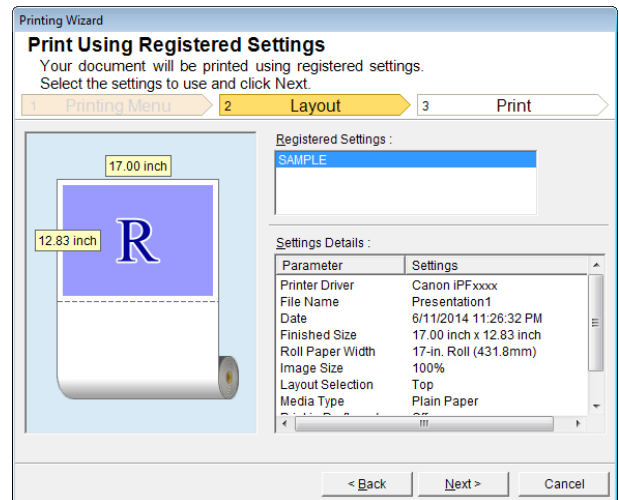

5 Click the **Next** button.

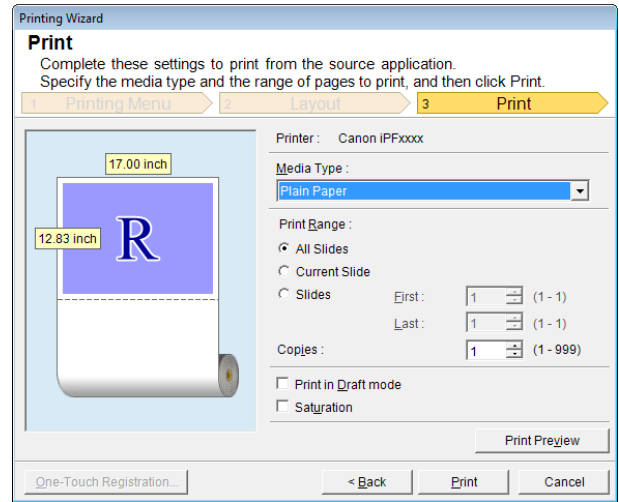

6 Select **Media Type**.

7 Select **Print Range** from **All Slides**, **Current Slide**, and **Slides**. If **Slides** is selected, enter the slide number.

8 Enter **Copies**.



Note

- When **Print in Draft mode** is selected, printing is fast but the print quality is poor.
- When **Saturation** is selected, you can print posters, etc., vividly.
- Press the **Print Preview** button to display the preview screen. You can check and make changes to the layout in the preview screen.
- The maximum print length when printing with the registered settings is the lesser of 14.22 times the roll paper width, or 18.0m.

9 Press **Print** to start printing.

Portrait Orientation/Landscape Orientation(PowerPoint)

Print to the edge of the roll width. You can print large exhibits and posters, or print the Landscape or Portrait Orientation Page Sizes made in the **Large-Format Printing Wizard**.

Create Page Size in Portrait or Landscape Orientation.

Use the **Large-Format Printing Wizard** to create portrait page sizes for Potrait Orientation, and landscape page sizes for Landscape Orientation.

1 Start **Microsoft PowerPoint**.

2 If **Start imagePROGRAF Print Plug-In** is displayed, click it.

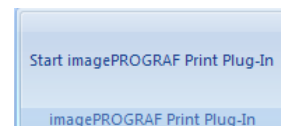

- 3 Click **Paper Settings** from the **imagePROGRAF Print Plug-In** toolbar/ribbon. The **Large-Format Printing Wizard** dialog box is displayed.

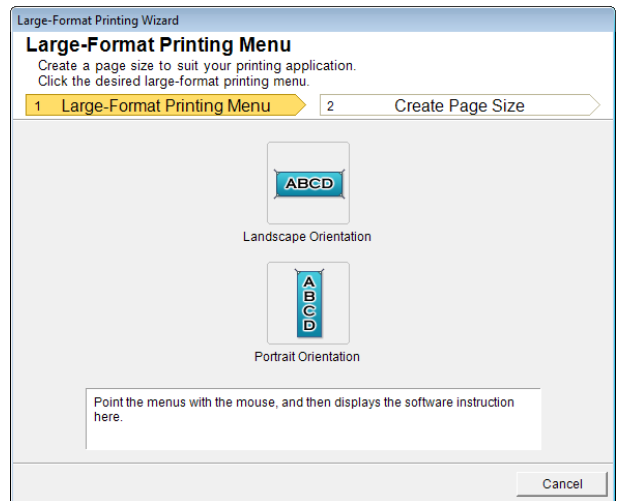

Important

- If you want to change the display to another file or application while the **Large-Format Printing Wizard** is open, close the **Large-Format Printing Wizard** dialog box. Otherwise, you may not be able to change displays or operate the toolbar/ribbon.

- 4 Click **Portrait Orientation** or **Landscape Orientation**.

Note

- The steps taken to create a Portrait Page Size will be used as an example to explain the procedure.

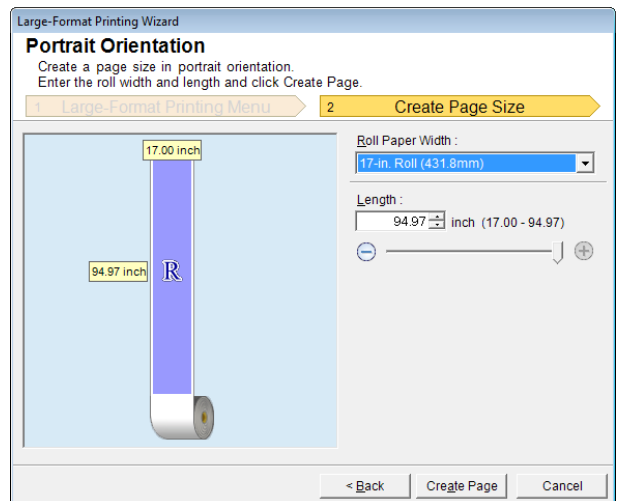

- 5 Adjust **Length** from the list-box or slide-bar.

- 6 Click the **Create Page** button.

- 7 Click **OK** if the message is displayed.

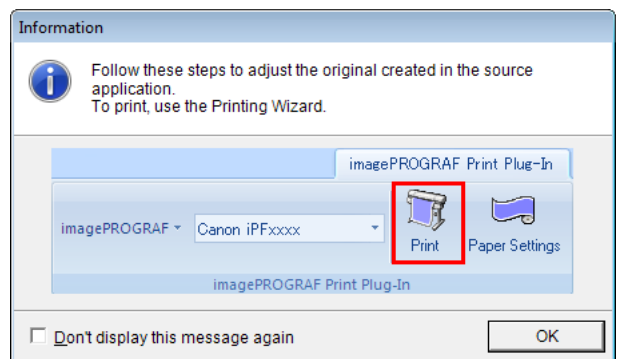

8 Edit and create the document.



• The layout may collapse if you create a form using existing data. If that is the case, modify the data again.



• Printing is done in **Print Matching Roll Width** of the **Printing Wizard**. For details on **Print Matching Roll Width**, see "Print Matching Roll Width(PowerPoint)." →P.249

To start from Microsoft Excel

Below are the steps to start **Print Plug-In for Office** from **Microsoft Excel**.

1 Start Microsoft Excel.

2 If **Start imagePROGRAF Print Plug-In** is displayed on the toolbar/ribbon, click it.

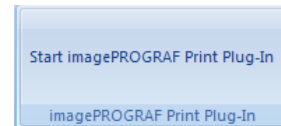

• If the **imagePROGRAF Print Plug-In** toolbar/ribbon is not displayed, refer to the following.
• When **Print Plug-In for Office** is not displayed →P.233

3 Check that the **imagePROGRAF Print Plug-In** toolbar/ribbon is displayed.

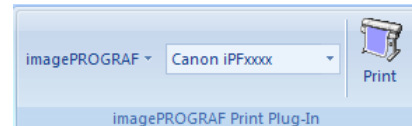

4 Click the buttons on the toolbar/ribbon according to the items you want to set.

Icon	Contents
Menu	Displays the About , Help , and Special Settings dialog boxes. (See "Configuring Special Settings.") →P.265
Printer list	Select Printer. If you select Show All Printers , the imagePROGRAF printers will be displayed again. Select this when you want to display all printer drivers or update the display.
PrintButton	The print Wizard is displayed. The settings Print Entire Sheet and Print Selected Area can be set.

Printing Wizard dialog box

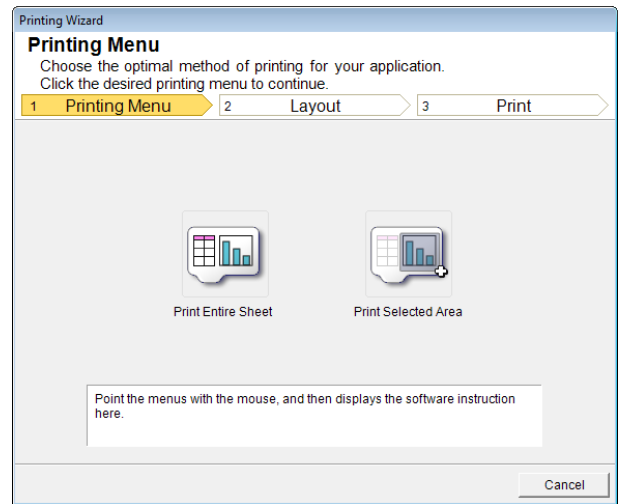

Important

- If you want to change the display to another file or application while the **Printing Wizard** is open, close the **Printing Wizard** dialog box. Otherwise, you may not be able to change displays or operate the toolbar/ribbon.
- The **Printing Wizard** will not start if you click the **Print** button on the toolbar/ribbon while editing a cell.
- When more than one worksheet is selected, the **Printing Wizard** cannot be run. Select only one worksheet and click **Print** again.
- When an object is selected, the **Printing Wizard** is not started if you click the **Print** button on the toolbar/ribbon.
- If the paper size in Excel is blank, the **Printing Wizard** cannot be run. From the **File** menu in Excel, select **Page Setup** and check **Paper size**.



Note

- If you click the **Print** button with a graph selected, a message dialog box will appear asking if you want to continue printing. If you click **No**, you will return to the application.
- If you click the **Print** button with a page break set, a message dialog box will appear asking if you want to continue printing. If you click **No**, you will return to the application. If you do not use the set page break, check the page break preview and change the setting.
- If you click the **Print** button with a page range set, a message dialog box will appear asking if you want to continue printing. If you click **No**, you will return to the application. If you do not use the set page range, check the page break preview and change the setting.
- If you click the **Print** button with a worksheet or cell protected, a message dialog box will appear asking if you want to continue printing. If you click **No**, you will return to the application. If you want to change the setting, remove the protection from the worksheet or cell.

Print Entire Sheet(Excel)

For resizing the entire sheet to fit the roll width. Choose this option to enlarge the currently displayed sheet before printing.

1

Start **Microsoft Excel**.

2

If **Start imagePROGRAF Print Plug-In** is displayed, click it.

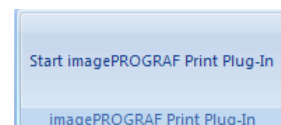

3

Click **Print** from the **imagePROGRAF Print Plug-In** toolbar/ribbon.



Important

- When more than one worksheet is selected, the **Printing Wizard** cannot be run. Select only one worksheet and click **Print** again.

If a print area is set, a confirmation message dialog box will appear.
To print the entire sheet, cancel the setting of the print area.

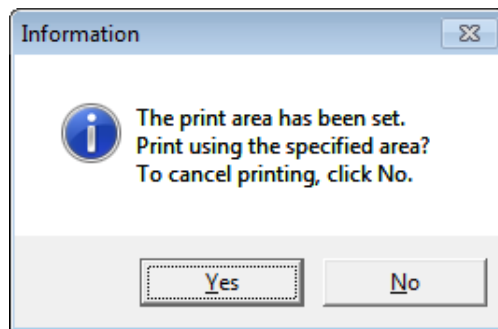

The **Printing Wizard** dialog box is displayed.

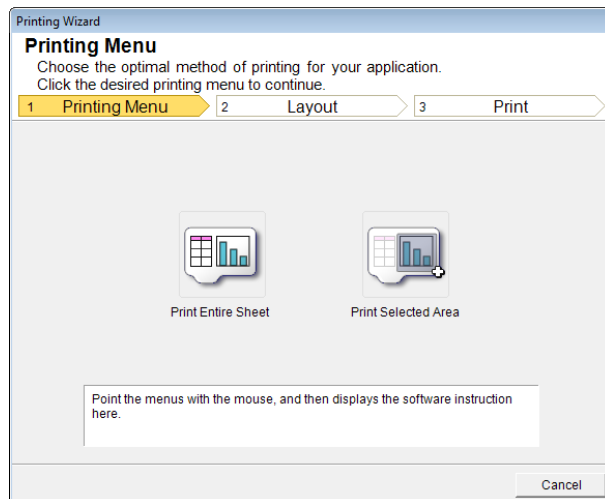

- 4** Click **Print Entire Sheet**.
A message will appear informing you that analysis is in progress.

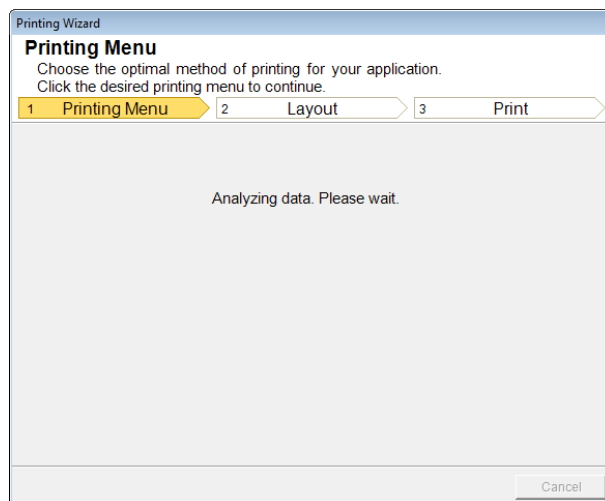

The Layout menu will appear automatically.

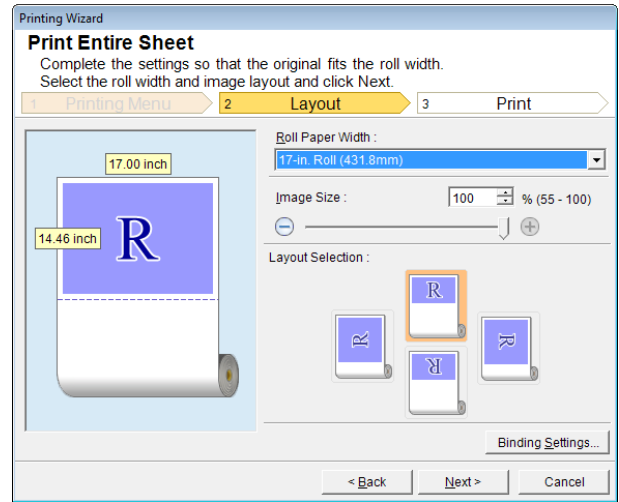

 **Note** • If data analysis requires time, a message dialog will appear. If you select **No**, you will return to the application.

- 5** Select **Roll Paper Width** that is set in the printer.
- 6** Select image size.
- 7** Select layout.
- 8** To configure **Binding**, click the **Binding Settings** button.
Refer to "Configuring Binding (Excel)" →P.264 for details on the procedure for configuring **Binding**.
- 9** Select **Next**.

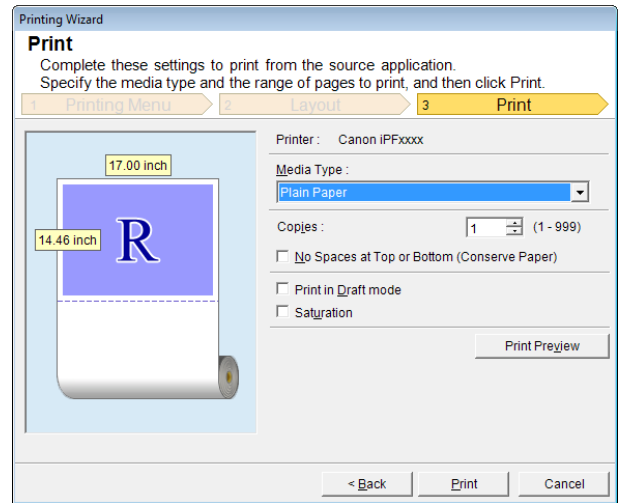

- 10** Select **Media Type**.
- 11** Enter **Copies**.

12 If the upper and lower margins are too wide, check **No Spaces at Top or Bottom (Conserve Paper)**. The upper and lower margins can be checked in **Print Preview**.



Note

- When **Print in Draft mode** is selected, printing is fast but the print quality is poor.
- When **Saturation** is selected, you can print posters, etc., vividly.
- Press the **Print Preview** button to display the preview screen. You can check and make changes to the layout in the preview screen.
- When you print to the edge of the roll width, the maximum print length is 18.0m.

13 Press **Print** to start printing.



Important

- If divided into plural pages, try reducing the data size or the range you select.
- You cannot run **Print** or **Print Preview** if you select it for a worksheet with no data displayed.

Print Selected Area(Excel)

For resizing the selected range of cells to fit the roll width. Choose this option to enlarge a particular part of the sheet before printing.

1 Start **Microsoft Excel**.

2 If **Start imagePROGRAF Print Plug-In** is displayed, click it.

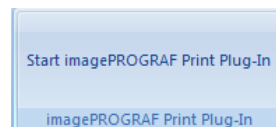

3 Click **Print** from the **imagePROGRAF Print Plug-In** toolbar/ribbon.



Important

- When more than one worksheet is selected, the **Printing Wizard** cannot be run. Select only one worksheet and click **Print** again.

If a print area is set, a confirmation message dialog box will appear.

To print the selected area, cancel the setting of the print area.

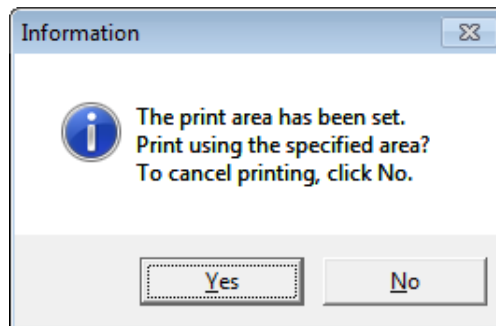

The **Printing Wizard** dialog box is displayed.

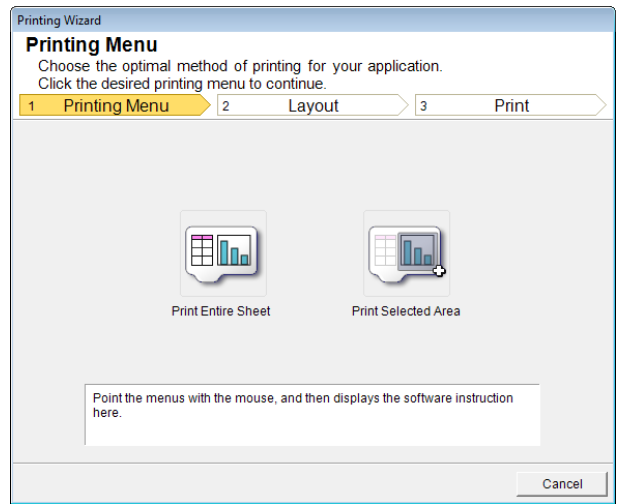

4 Click **Print Selected Area**.

Important

- If only one cell is selected, **Print Selected Area** cannot be selected.

A message will appear informing you that analysis is in progress.

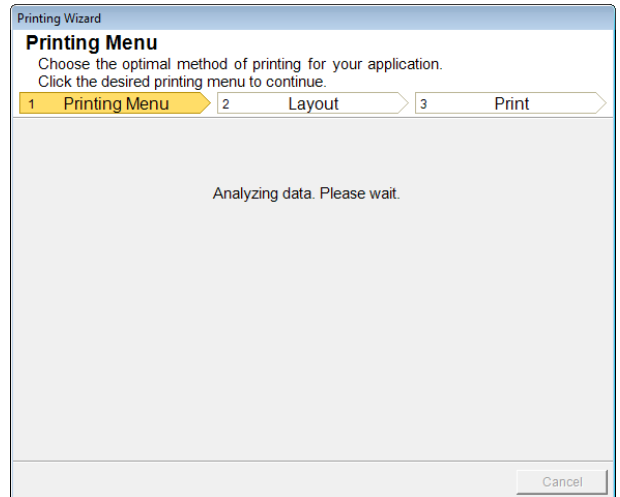

The Layout menu will appear automatically.

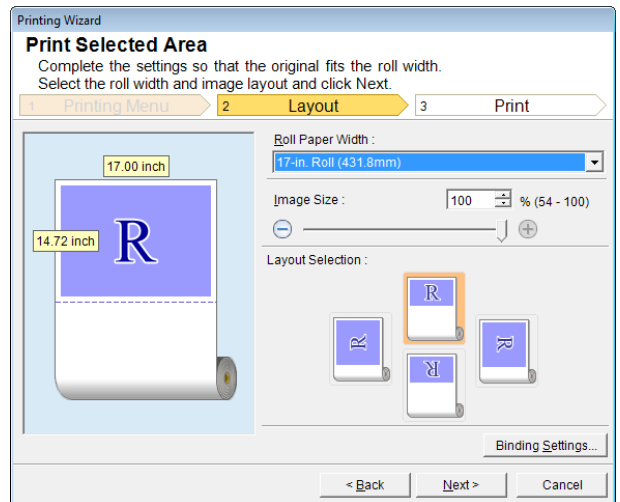

Important

- If the range selected in **Excel 2007 or later** is too large, it will not be possible to analyze the data. Select a smaller range and then run the analysis.



• If data analysis requires time, a message dialog will appear. If you select **No**, you will return to the application.

5 Select **Roll Paper Width** that is set in the printer.

6 Select image size.

7 Select layout.

8 To configure **Binding**, click the **Binding Settings** button. Refer to "Configuring Binding (Excel)" →P.264 for details on the procedure for configuring **Binding**.

9 Select **Next**.

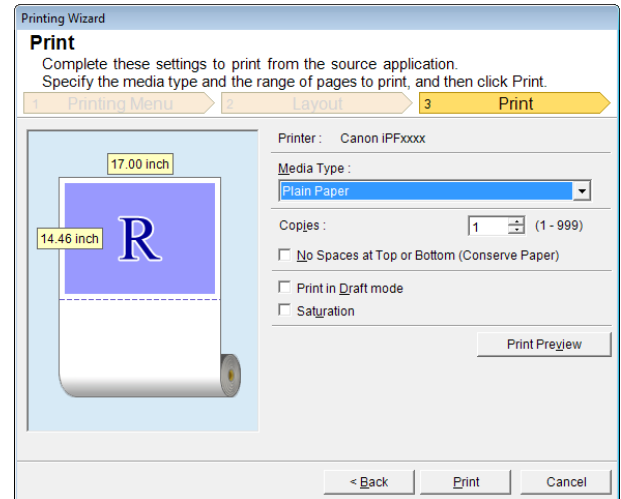

10 Select **Media Type**.

11 Enter **Copies**.

12 If the upper and lower margins are too wide, check **No Spaces at Top or Bottom (Conserve Paper)**. The upper and lower margins can be checked in **Print Preview**.



- When **Print in Draft mode** is selected, printing is fast but the print quality is poor.
- When **Saturation** is selected, you can print posters, etc., vividly.
- Press the **Print Preview** button to display the preview screen. You can check and make changes to the layout in the preview screen.
- When you print to the edge of the roll width, the maximum print length is 18.0m.

13 Press **Print** to start printing.



- If divided into plural pages, try reducing the data size or the range you select.
- You cannot run **Print** or **Print Preview** if you select it for a worksheet with no data displayed.

Configuring Binding (Excel)

You can configure **Binding** margins for binding printouts.

1 Configure the settings up to **Layout Selection** in the **Layout** screen in **Print Entire Sheet** or **Print Selected Area**.

Refer to "Print Entire Sheet(Excel)" →P.259 and "Print Selected Area(Excel)" →P.262 for the configuration methods.

2 Click the **Binding Settings** button.



• You cannot click the **Binding Settings** button in the following situations.

- When the **Image Size** is set to a value smaller than **100%**
- When a graph is selected
- When page breaks have been set
- When a sheet or cell is protected

Open the **Binding Settings** dialog box.

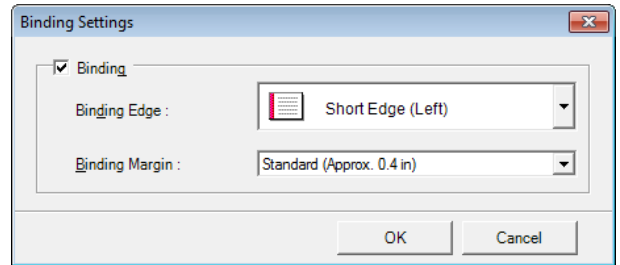

3 If the **Binding** checkbox is not checked, select it to turn binding on.

4 Select **Binding Edge**.

5 Select **Binding Margin**.

6 Click the **OK** button.
Return to the **Layout** screen.

Check that the **Binding** settings are applied in the preview screen.

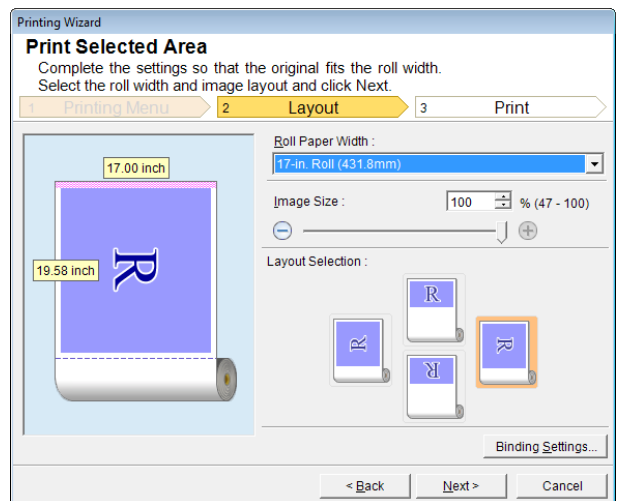

7 Configure the settings in the **Printing Wizard** dialog box.

Configuring Special Settings

You can configure **Special Settings** from the **imagePROGRAF Print Plug-In** toolbar.

1 Click **imagePROGRAF** in the toolbar, and select **Special Settings**.

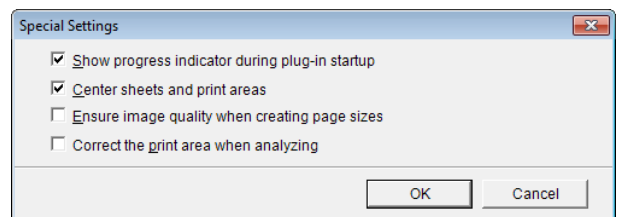

2 Turn the checkbox for the item you want to change on or off.

Item	Details
Show progress indicator during plug-in start-up	When this setting is off, hides the progress indicator that appears while the plug-in is starting up.

Item	Details
Center sheets and print areas	When this setting is off, printing is performed without changing the position. When this setting is on, printing is performed with the top, bottom, left, and right margins layed out equally. When this setting is off, printing is performed without changing the position. This function is only valid in Microsoft Excel .
Ensure image quality when creating page sizes	When this setting is on, documents are created at the maximum size. This reduces the enlargement ratio during actual printing, which minimizes degradation of the quality of photos, etc. This function is only valid in Microsoft PowerPoint .
Correct the print area when analyzing	For data that cannot be processed with usual data analysis, the print area is corrected and then the data is processed. When data analysis fails, you may be able to print by turning on this checkbox. This function is only valid in Microsoft Excel .

3Click **OK** to close the **Special Settings** dialog box.

Basic Printing Workflow	15
Enhanced Printing Options	29
Windows Software	157

Mac OS Software

Printer Driver	268
Preview	286
Free Layout	307
→ Printmonitor	505
→ Media Configuration Tool	405

Handling and Use of Paper	331
Control Panel	429
Printer Parts	467
Network Setting	481
Print Job Management	501
Adjustments for Better Print Quality	555
Maintenance and Consumables	573
Troubleshooting	617
Error Message	651
Specifications	673
Appendix	677

Printer Driver

Printer Driver Settings	268
Specifying Paper in the Printer Driver	269
Confirming Print Settings	270
Checking the Layout in a Preview Before Printing	271
Using Favorites	271
Accessing the Printer Driver Dialog Box from Applications	272
Main Pane	272
Paper Detailed Settings Dialog Box	276
View set. Dialog Box for the Printing Application	278
Matching pane	278
Color Settings Pane: Color	280
Object Adjustment dialog box: Color	281
Color Settings Pane: Monochrome	282
Object Adjustment dialog box: Monochrome	283
Page Setup Pane	283
Additional Settings Pane	284

Mac OS Software

Printer Driver

Printer Driver Settings

For instructions on accessing the Mac OS printer driver, refer to the following topics.

- **Accessing the Printer Driver Dialog Box from Applications** →P.272

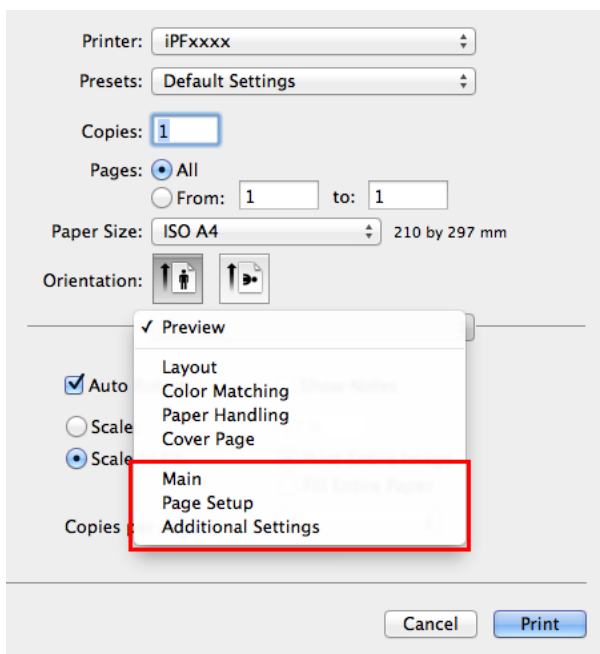

For information on the Mac OS printer driver settings, refer to the following topics.

- **Main Pane** →P.272

You can specify the media type, color processing, print quality, print preview, and other settings. Choose **Easy Settings** to specify basic print settings based on the printing application or **Advanced Settings** to complete more detailed settings as desired.

- **Paper Detailed Settings Dialog Box** →P.276
- **View set. Dialog Box for the Printing Application** →P.278
- **Color Settings Pane: Color** →P.280
- **Object Adjustment dialog box: Color** →P.281
- **Matching pane** →P.278
- **Color Settings Pane: Monochrome** →P.282

- **Object Adjustment dialog box: Monochrome** →P.283
- **Page Setup Pane** →P.283
You can specify the page size of the original, borderless printing, enlargement or reduction, the orientation, the paper size and source, and automatic cutting.
- **Additional Settings Pane** →P.284
You can configure the method of outputting print jobs to the printer.

With the **imagePROGRAF Free Layout** feature, you can arrange originals from various source applications on a single page before printing. For details, see "**Free Layout.**" →P.307
 With the **imagePROGRAF Preview** feature, you can check the layout before printing and adjust layout or size settings while viewing a preview screen. For details, see "**Preview.**" →P.286

Specifying Paper in the Printer Driver

If you have replaced the paper, you must complete the following settings in the printer driver.

- 1** Choose **Page Setup** from the application menu to display the **Page Attributes** dialog box.

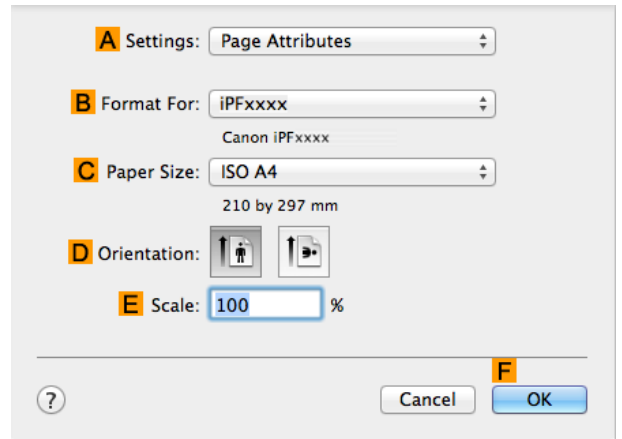

Note

- **Page Setup** might not be displayed in the menu depending on the OS you are using and the application software. In this case, select **Print** from the menu in the application software, and configure the settings in the upper part of the printer driver screen that is displayed.

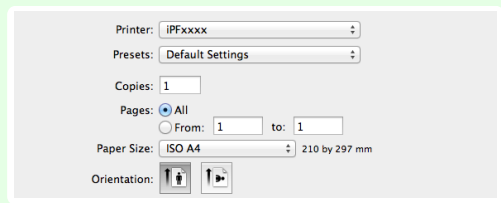

- 2** Select the printer in the **B Format for** list.
- 3** Choose the original size in the **C Paper Size** list.
- 4** Click **F OK** to close the dialog box.
- 5** In the application menu, choose **Print**.

6 Access the **Main** pane.

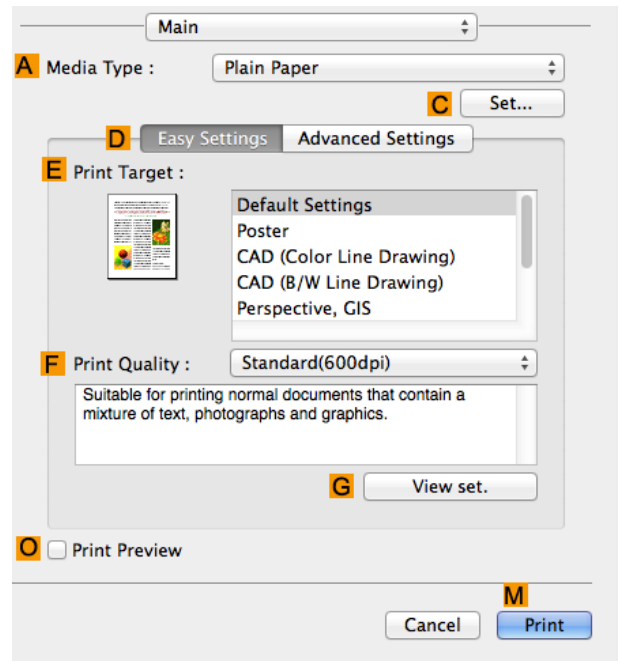

7 In the **A Media Type** list, select the type of paper that is loaded.

8 Access the **Page Setup** pane.

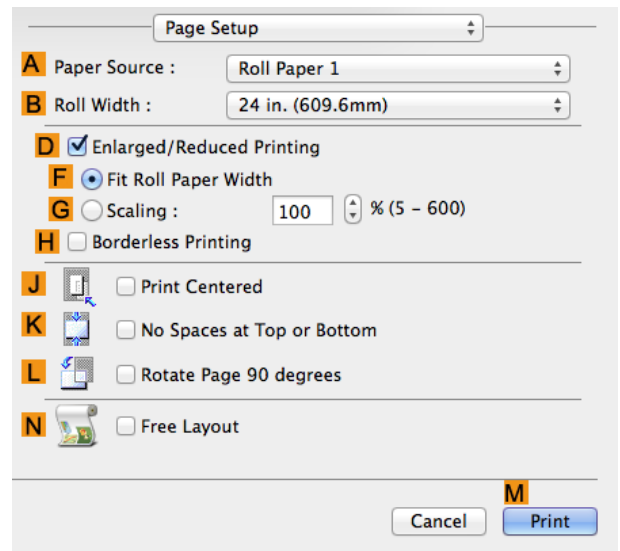

9 In the **A Paper Source** list, select how paper is supplied.

10 If Roll Paper is selected in **A Paper Source**, select the width of the roll paper that is loaded in **B Roll Width**.

Note • A variety of settings are available in the printer driver to suit different printing applications. For details on available printing conditions, see "Printer Driver Settings ." →P.268

Confirming Print Settings

The ways to confirm what printing conditions have been specified are as follows.

Checking a print preview

You can check an image of the original just as it will be printed.

Confirming the image of print jobs beforehand helps prevent printing errors.

For details on print previews, see "Checking the Layout in a Preview Before Printing." →P.145

Checking the Layout in a Preview Before Printing

This topic describes how to check the layout before printing using the **Canon imagePROGRAF Preview** function.

- 1 Choose **Print** in the application menu.
- 2 Access the **Main** pane.

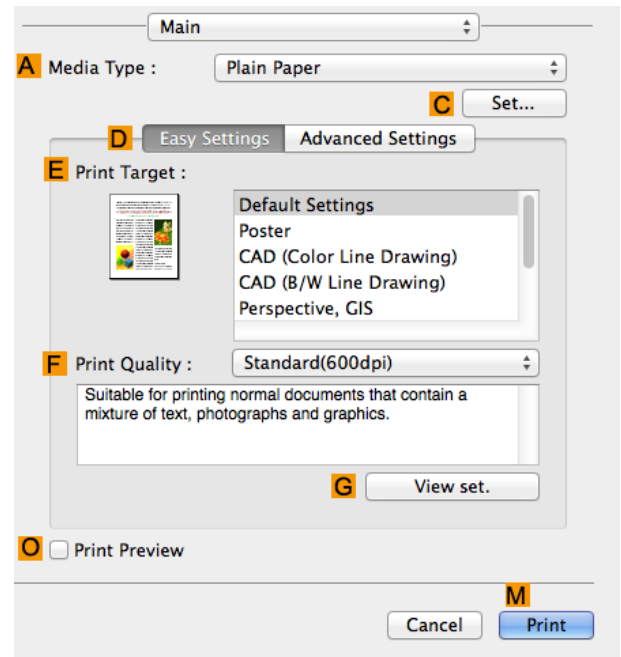

- 3 Select the **Print Preview** check box.
- 4 Click **Print**.
- 5 The **Canon imagePROGRAF Preview** window is displayed.

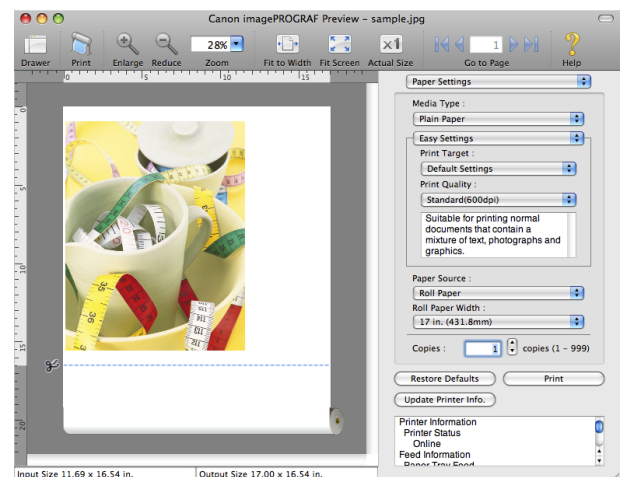

- 6 Check the layout and adjust settings in the **Canon imagePROGRAF Preview** window as desired.
- 7 Print from the **Canon imagePROGRAF Preview** menu.



Note

- For details on **imagePROGRAF Preview** functions, see "Preview." →P.286

Using Favorites

You can use the **Presets** function in Mac OS for favorite-based printing.



- You can save the current print settings by clicking **Save Current Settings as Preset** (or **Save As** depending on your version of operating system) from the **Presets** list in the printing dialog box. This function is supported by the operating system. Refer to the Mac OS manual for details.

Accessing the Printer Driver Dialog Box from Applications

1 In the application software, select **Print** from the **File** menu to display the dialog box for printing conditions.



- This dialog box includes basic printing options and enables you to choose the printer, specify the range of pages, number of copies, and so on.

2 Select the printer in the **Printer** list.

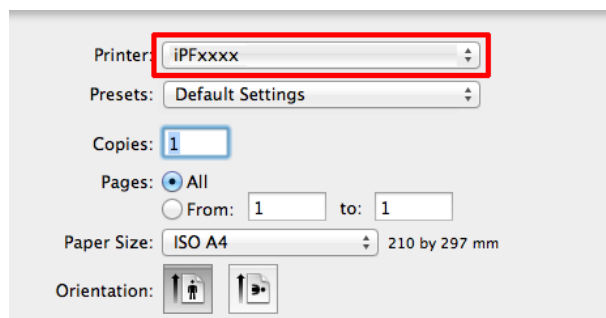

3 Click **Print** to start printing. As shown in the following illustration, you can switch to other panes in this dialog box to complete settings for various methods of printing, including enlarged and reduced printing, borderless printing, and so on.

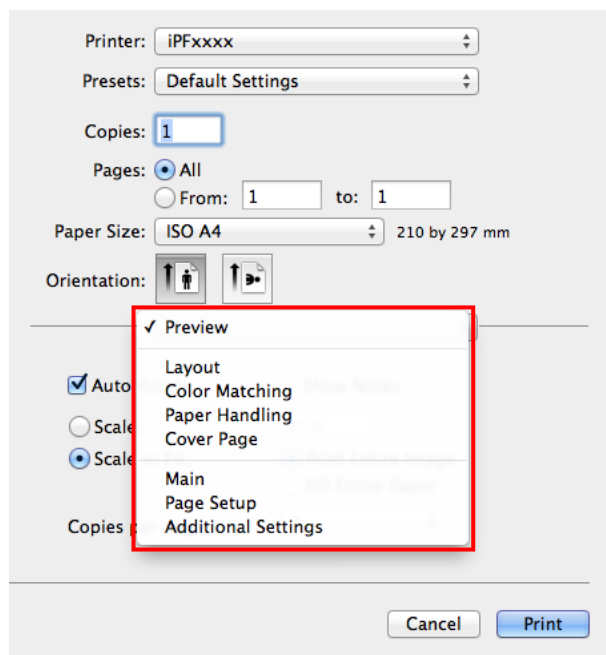

Main Pane

The following settings are available on the **Main** pane. For details on settings items, refer to the printer driver help.



- On the **Main** pane, choose **Easy Settings** to specify basic print settings based on the print target, or switch to **Advanced Settings** to complete more detailed settings as desired.

Common Items

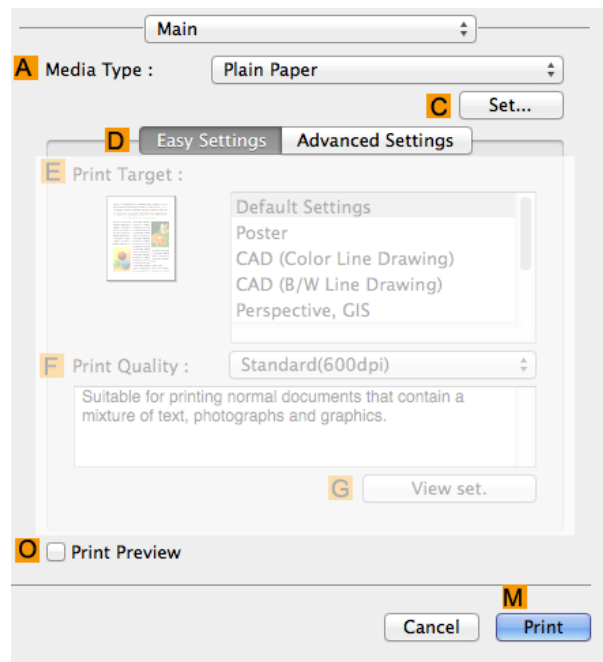

- **A Media Type**

Select the paper type.

For information on the types of paper the printer supports, refer to the **Paper Reference Guide**. (See "Displaying the Paper Reference Guide.") →P.335

- **C Set**

Displays **Paper Detailed Settings**. You can configure the printing settings to match the type of media, such as the ink drying time.

- **Paper Detailed Settings Dialog Box** →P.276

- **O Print Preview**

When the check box is selected, **imagePROGRAF Preview** is launched before printing.

This allows you to check on-screen previews of documents before printing.



Important

- When **Free Layout** is selected on the **Page Setup** panel, **Free Layout** is disabled.

- **Checking the Layout in a Preview Before Printing** →P.145

Configuration using **Easy Settings**

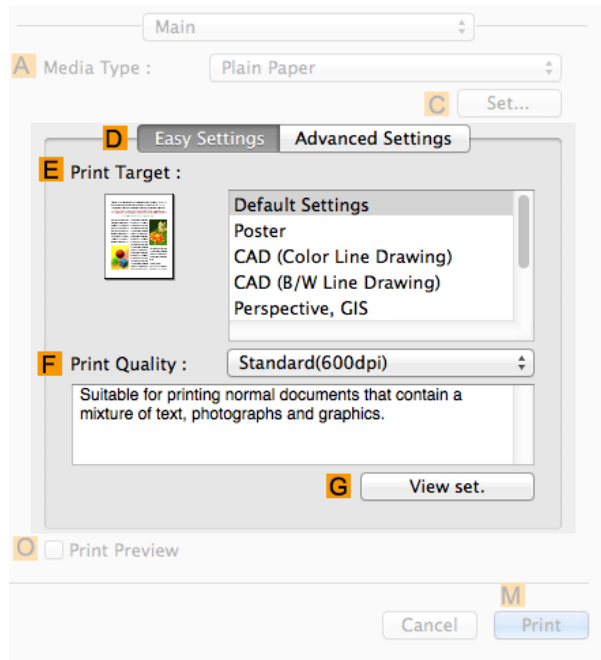

- **E Print Target**

Choose presets that match the type of document to be printed.

- Printing Photos and Images →P.43
- Printing Office Documents →P.47

- **F Print Quality**

Choose the level of print quality.

- **G View set.**

Click to display the **View set.** dialog box, which enables you to confirm the settings for the selected item from the **E Print Target** list or change the order of items listed in **E Print Target**.

- View set. Dialog Box for the Printing Application →P.278

Configuration using **Advanced Settings**

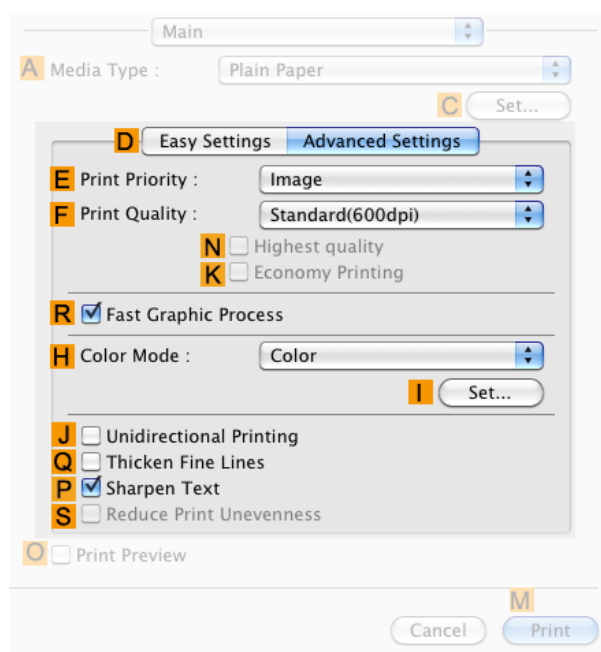

- **E Print Priority**

Choose the graphic elements that you want to emphasize for printing.

- Giving Priority to Particular Graphic Elements and Colors for Printing →P.66

- **F Print Quality**

Choose the level of print quality.

- Giving Priority to Particular Graphic Elements and Colors for Printing →P.66

- **N Highest quality**

When the check box is selected, printing is performing focusing on quality. Printing takes longer and consumes more ink than in other modes, but this mode offers superior printing quality.



Note

- If you set **F Print Quality** to **High**, you can select **N Highest quality**. However, depending on **A Media Type**, you may not be able to select **N Highest quality**.

- **K Economy Printing**

When this mode is selected, you can print with less ink consumed. However, print quality is lower than in regular printing. Select this option to save ink, such as when printing to check drawings. Depending on the **A Media Type** and **F Print Quality** settings, this mode may not be available.



Note

- If you set **F Print Quality** to **Fast**, you can select **K Economy Printing**. However, depending on **A Media Type**, you may not be able to select **K Economy Printing**.

- **R Fast Graphic Process**

Select this option to print faster than usual, when possible.

- **H Color Mode**

Choose the color mode.

- Giving Priority to Particular Graphic Elements and Colors for Printing →P.66

- **I Set**

Click to display the **Color Settings** dialog box for more advanced color settings.

- Adjusting the Color in the Printer Driver →P.60

- **J Unidirectional Printing**

Select this checkbox to prevent problems such as misaligned lines and improve the print quality. However, the printing speed becomes slower.

- **Q Thicken Fine Lines**

Select this check box to print fine lines more distinctly.

- **P Sharpen Text**

Select this check box to print text more sharply.

- **S Reduce Print Unevenness**

Select this checkbox for two-pass printing to reduce color shading.

This option is displayed if you have selected Plain Paper in **Media Type** and **Office Document** in **Print Priority**.

Paper Detailed Settings Dialog Box

The **Paper Detailed Settings** dialog box offers the following settings. For details on settings items, refer to the printer driver help.

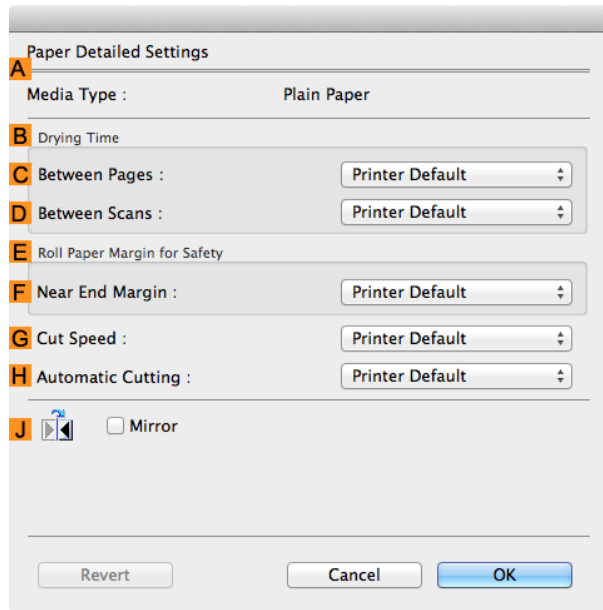

- To display the **Paper Detailed Settings** dialog box, on the **Main** pane, click **Set by Media Type**. (See "Main Pane.") →P.272

A Media Type

The paper selected with **Media Type** of the **Main** panel is displayed. For information on the types of paper the printer supports, refer to the **Paper Reference Guide**. (See "Displaying the Paper Reference Guide.") →P.335

B Drying Time

Specify the time that the printer waits for ink to dry, as needed. The **Between Pages** setting is only valid for rolls.

- C Between Pages**

You can set the time to wait after printing 1 document page until ejecting the paper. Since waiting time is required for ink to dry before a roll is cut, you can deliver paper in the Output Stacker with the ink dried even if **Cutting Mode** is set to **Automatic**.

Setting Item	Details
Printer Default	The setting of the control panel of the printer is applied.
None	Paper is ejected immediately after printing completes.
30 sec. / 1 min. / 3 min. / 5 min. / 10 min. / 30 min. / 60 min.	Paper is ejected when the set time elapses after printing completes.

- D Between Scans**

You can set the time to wait after printing 1 line on a page until printing the next line. Set this to avoid bleeding or color unevenness such as when bleeding occurs on a page or when color unevenness occurs during borderless printing.

Setting Item	Details
Printer Default	The setting of the control panel of the printer is applied.
None	The next line is printed immediately after a line is printed.
1 sec. / 3 sec. / 5 sec. / 7 sec. / 9 sec.	The next line is printed when the set time elapses after a line is printed. * Increase the time according to the occurrence condition of bleeding or unevenness.

E Roll Paper Margin for Safety

You can specify the length of a margin on the leading edge of paper to ensure that paper susceptible to curling is held firmly against the Platen.

• F Near End Margin

Specify the length of the **Near End Margin** (the leading edge margin) of the roll, as needed.

Setting Item	Details
Printer Default	The setting of the control panel of the printer is applied.
3 mm (0.12 in)	The document is printed in the standard size. * Select this when you do not have any problems in printing.
20 mm (0.8 in)	Select this when rubbing against the printhead occurs such as when using paper that tends to curl.

G Cut Speed

Select the speed of automatic cutting, as needed. You can adjust this setting if paper is not cut well when automatic cutting is used.

Setting Item	Details
Printer Default	The setting of the control panel of the printer is applied.
High Speed	When the Standard setting does not result in a clean cut surface, select this.
Standard	Select this when you do not have any problems in automatic cutting.
Low Speed	This helps prevent adhesive from sticking to the cutter and keeps the cutter sharp if you select it when using adhesive paper.

H Automatic Cutting

Set whether to perform roll cutting automatically or print a cut line.
The following settings are available for automatic cutting.

Setting Item	Details
Printer Default	The setting of the control panel of the printer is applied.
None	After printing completes, the roll is not cut per page, and the next page of data is printed successively.
Print Cut Guideline	After printing completes, a line is printed per page, and the next page of data is printed successively.

J Mirror

Specify whether to print a mirror image, as needed. Select this option to print a version of the document or image with the left and right sides inverted.

View set. Dialog Box for the Printing Application

In the **View set.** dialog box, you can check details of the selected printing application.

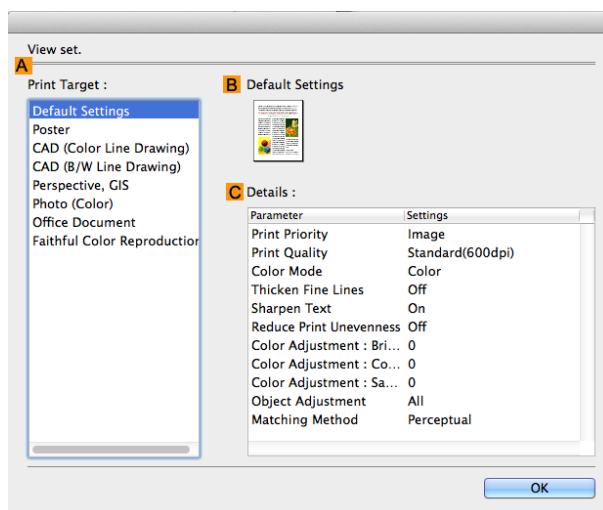

Note

- To display the **View set.** dialog box, on the **Main** pane, click **View set.** by **Print Target.** (See "Main Pane.") →P.272

• **A Print Target**

Shows all **Print Target** options (settings items for the printing application).

• **B Name**

Identifies the item selected in **Print Target** by its name and an icon.

• **C Details**

Here, you can confirm detailed settings values for each item selected in the **Print Target** list.

Matching pane

On the **Matching** pane, you can specify color matching to compensate for differences in the appearance of colors on various devices.



Important

- The **Matching** pane is not displayed when **No color correction** or **Monochrome** is selected in **Color Mode.**



Note

- To display the **Matching** pane, on the **Main** pane click **Color Settings** by **Color Mode** in **Advanced Settings,** and then click the **Matching** tab. (See "Main Pane.") →P.272

Driver Matching Mode

The following options are available when you select **Driver Matching Mode** in the **A Matching Mode** list.

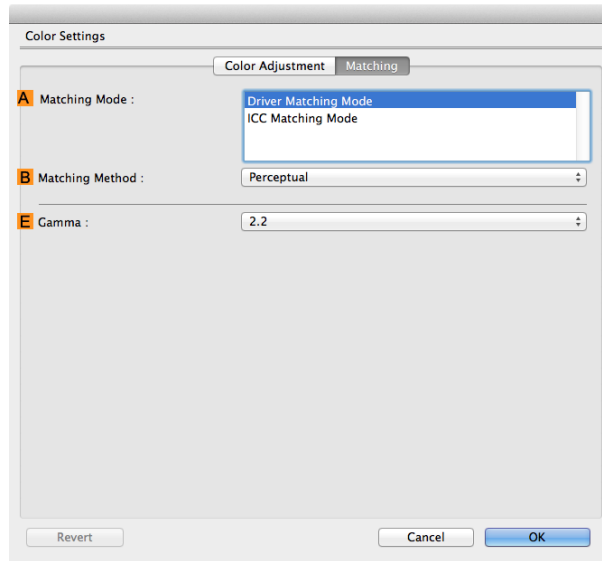

• **A Matching Mode**

Select the color matching mode to use, as desired.

Normally, select **Driver Matching Mode**. For color matching based on ICC profiles, select **ICC Matching Mode** depending on your color matching system.

• **B Matching Method**

Select the color matching method that suits the document to be printed. Various **B Matching Method** options are available depending on your selection in **A Matching Mode**.

• **E Gamma**

You can adjust the gradation of intermediate tones in an image.

2.2 is normally selected. If you want a softer impression than **2.2**, select **1.8**.

ICC Matching Mode

The following options are available when you select **ICC Matching Mode**, in the **A Matching Mode** list.

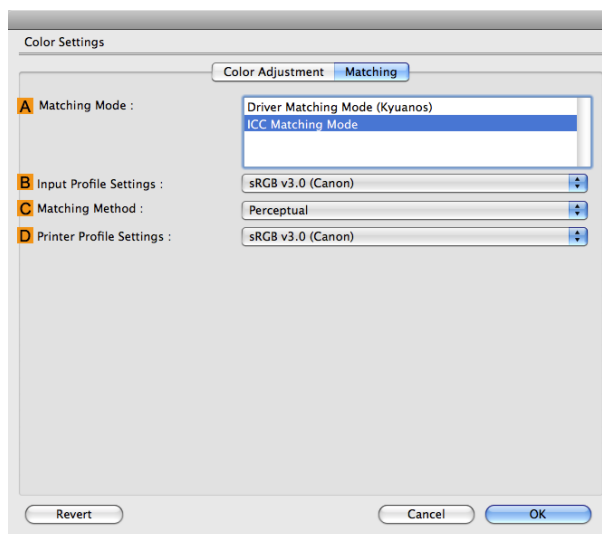

• To display the **Matching** pane, on the **Main** pane, click **Color Settings** by **Color Mode** in **Advanced Settings**, and then click the **Matching** tab. (See "Main Pane .") →P.272

- **A Matching Mode**

Select the color matching mode to use, as desired.

- **B Input Profile Settings**

You can choose **Input Profile**.

Various options are available depending on your selected **A Matching Mode**.

- **C Matching Method**

You can choose **C Matching Method**.

Various options are available depending on your selected **A Matching Mode**.

- **D Printer Profile Settings**

Specify the printer profile as desired.

We recommend that you select an ICC profile created using commercially available profile creation software in order to perform color management accurately on paper other than genuine Canon paper and feed confirmed paper.

The created ICC profile needs to be saved in the following folder on the computer you are using.

/user/(user name)/library/ColorSync/Profiles folder



Note

- For details on settings items, see "Adjusting the Color in the Printer Driver." → P.60

Color Settings Pane: Color

In general, make any needed adjustments to the color of documents in the application used to create them. However, if the color tone as printed is not as you expected, you can also adjust the color in the printer driver.

If the color tone as printed is not as you expected, you can adjust it on the **Color Adjustment** pane.

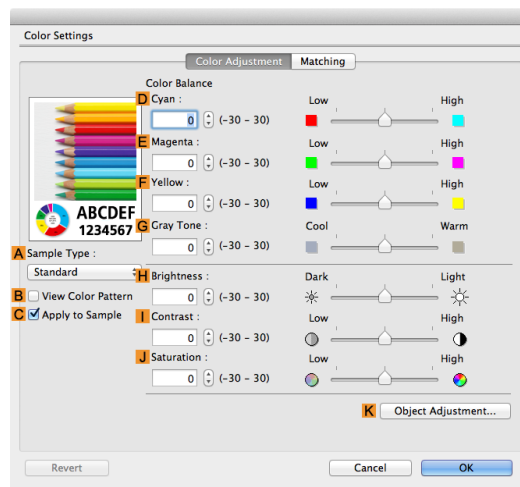

Note

- To display the **Color Adjustment** pane, on the **Main** pane click **Color Settings** by **Color Mode** in **Advanced Settings**. (See "Main Pane.") → P.272
- For details on settings items, see "Adjusting the Color in the Printer Driver." → P.60

- **A Sample Type**

Choose a sample image from **Standard**, **Portrait**, **Landscape**, or **Graphics**.

- **B View Color Pattern**

Select this checkbox to display the color pattern.

- **C Apply to Sample**

Select this checkbox to apply the changed settings to the sample image.

- **D Cyan/E Magenta/F Yellow**

Correct color tones by adjusting the levels of each color.

- **G Gray Tone**

Adjust the color tone of grays as desired. Choose **Cool** (tinged with blue) or **Warm** (tinged with red).

- **H Brightness**

Adjust the overall image brightness as desired. You can adjust the brightness if the printed document is lighter or darker than the original image (that is, the original photo that was scanned or the original graphic as it appears on the computer screen).

- **I Contrast**

Adjust the contrast of the darkest and lightest portions relative to each other, as desired. Increasing the **Contrast** makes images sharper, and reducing the **Contrast** softens images.

- **J Saturation**

Adjust the color intensity as desired. Increasing the **Saturation** setting makes colors more vivid, and reducing the **Saturation** makes colors more subdued.

- **K Object Adjustment**

Select this option to display the **Object Adjustment** dialog box, in which you can specify objects subject to color adjustment.

- Object Adjustment dialog box: Color → P.281

Object Adjustment dialog box: Color

In the **Object Adjustment** dialog box, you can specify what type of print jobs to apply color adjustment to. If an original comprises images, graphics, and text, you can specify which portion to apply color adjustment to.

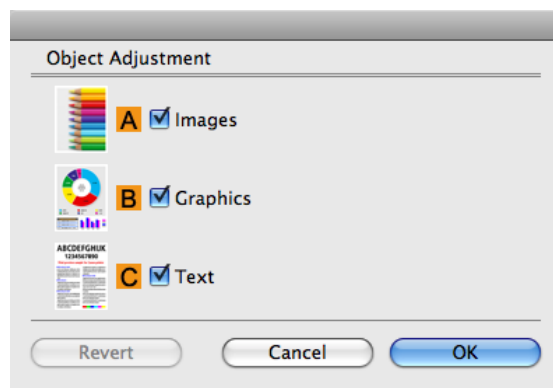

Note

- To display the **Object Adjustment** dialog box, click **Object Adjustment** on the **Color Adjustment** panel.

- **A Images**

Select this option to apply color adjustment to image areas, such as photos.

- **B Graphics**

Select this option to apply color adjustment to graphics, such as lines and circles.

- **C Text**

Select this option to apply color adjustment to text.

Color Settings Pane: Monochrome

On the **Color Adjustment** pane for monochrome printing, you can adjust the brightness and contrast.

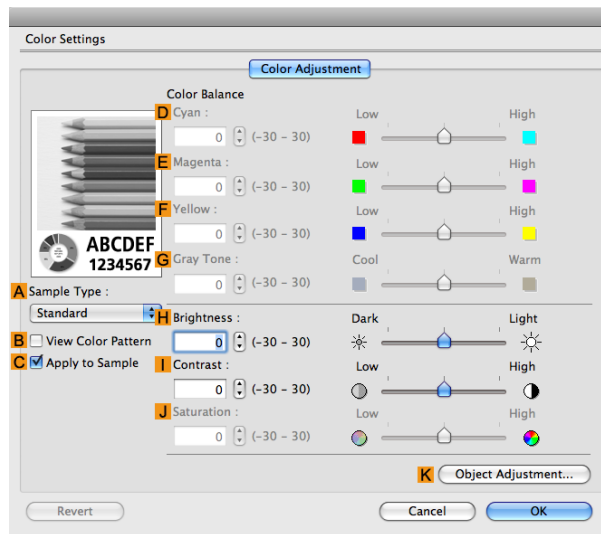

Note

- To display the **Color Adjustment** pane, on the **Main** pane, click **Color Settings** in **Advanced Settings**. (See "Main Pane.") →P.272
- For details on settings items, see "Adjusting the Color in the Printer Driver." →P.60

- **A Sample Type**

Choose a sample image from **Standard**, **Portrait**, **Landscape**, or **Graphics**.

- **B View Color Pattern**

Select this checkbox to display the color pattern.

- **C Apply to Sample**

Select this checkbox to apply the changed settings to the sample image.

- **D Cyan/ E Magenta/ F Yellow**

Not available.

- **G Gray Tone**

Not available.

- **H Brightness**

Adjust the overall image brightness as desired. You can adjust the brightness if the printed document is lighter or darker than the original image (that is, the original photo that was scanned or the original graphic as it appears on the computer screen).

- **I Contrast**

Adjust the contrast of the darkest and lightest portions relative to each other, as desired. Increasing the **Contrast** makes images sharper, and reducing the **Contrast** softens images.

- **J Saturation**

Not available.

- **K Object Adjustment**

Select this option to display the **Object Adjustment** dialog box, in which you can specify objects subject to color adjustment.

- Object Adjustment dialog box: **Monochrome** →P.283

Object Adjustment dialog box: Monochrome

In the **Object Adjustment** dialog box, you can specify what type of print jobs to apply color adjustment to. If an original comprises images, graphics, and text, you can specify which portion to apply color adjustment to.

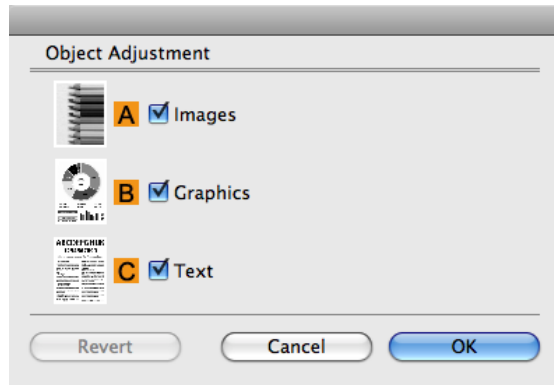

To display the **Object Adjustment** dialog box, click **Object Adjustment** on the **Color Adjustment** panel.

• **A Images**

Select this option to apply color adjustment to image areas, such as photos.

• **B Graphics**

Select this option to apply color adjustment to graphics, such as lines and circles.

• **C Text**

Select this option to apply color adjustment to text.

Page Setup Pane

The following settings are available on the **Page Setup** pane. For details on settings items, refer to the printer driver help.

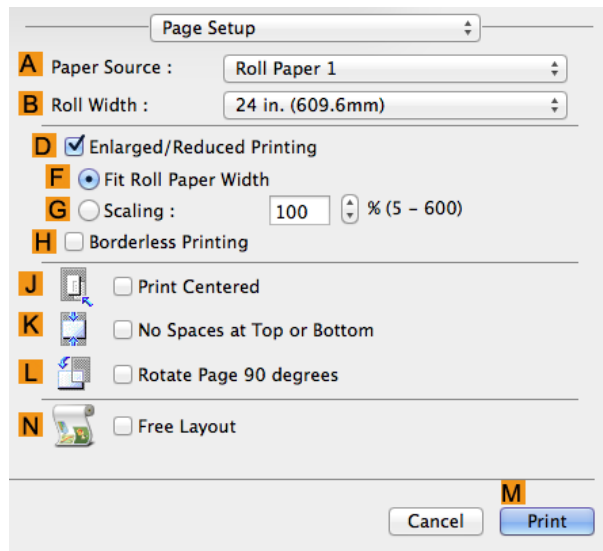

• **A Paper Source**

Choose how paper is supplied.

Options displayed in the list vary depending on the selection in **A Media Type** in the **Main** pane.

• **B Roll Width**

Select the paper width of the roll loaded in the printer.

- **D Enlarged/Reduced Printing**

Select this checkbox to choose the following options.

- Resizing Originals to Fit the Roll Width →P.74
- Resizing Originals by Entering a Scaling Value →P.78

- **F Fit Roll Paper Width**

Resizes the document image to match the roll width.

- **G Scaling**

Resizes the document image based on a specified scaling value. Enter a value in a range of **5–600**.

- **H Borderless Printing**

Borderless printing is available if roll paper is selected in the **A Paper Source** list.

Activate this setting for borderless printing to match the size and width of the paper.

- Borderless Printing by Resizing Originals to Fit the Roll Width →P.95
- Borderless Printing at Actual Size →P.87

- **J Print Centered**

Select this checkbox to print document images in the center of the paper.

- Printing Originals Centered on Rolls →P.128
- Printing Originals Centered on Sheets →P.132

- **K No Spaces at Top or Bottom**

Select this checkbox to print the next image skipping blank areas above and below printable data in documents, which enables you to conserve the paper.

- Conserving Roll Paper by Printing Originals Without Top and Bottom Margins →P.140

- **L Rotate Page 90 degrees**

Select this checkbox to rotate the document image by 90 degrees before printing.

- Conserving Roll Paper by Rotating Originals 90 Degrees →P.137

- **N Free Layout**

Select this checkbox to start **imagePROGRAF Free Layout** before printing.

This allows you to print multiple documents next to each other.



Important

- When **Print Preview** is selected on the **Main** panel, **Print Preview** is disabled.

- Printing Multiple Originals Next to Each Other →P.114

Additional Settings Pane

The following settings are available on the **Additional Settings** pane.

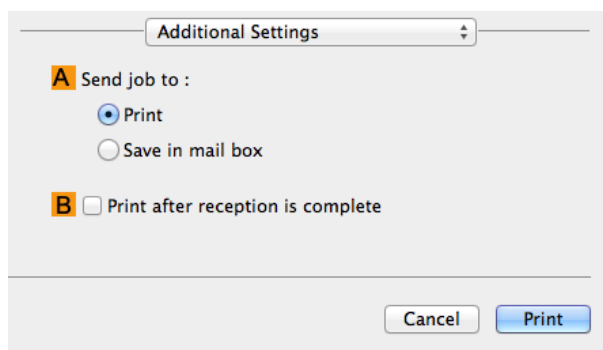

- **A Send job to**

You can configure the method for saving print jobs to the printer hard disk.

- **B Print after reception is complete**

You can prevent degradation of print quality that occurs when receiving a print job is interrupted and printing is aborted in the middle.

Preview

The Features of Preview	286
Starting Preview	286
Preview Main Window	287
Paper Settings Panel	290
Easy Settings	291
Advanced Settings	292
Output Settings Panel	293
Color Settings Panel	295
Color Adjustment	296
Matching	298
Driver Matching Mode	299
ICC Matching Mode	300
ColorSync	301
Preferences Dialog Box	301
Zoom Dialog Box	301
Go to Page Dialog Box	302
Print with No Borders	302
Print on the Center	303
Not Print Spaces at the Top/Bottom	303
Print Page Rotated 90 Degrees	304
Display with Fitting to the Width of the Paper	304
Display with All	304
Display with Actual Size	305
Moving a Page	305

The Features of Preview

The main features of Preview are as follows.

- While viewing this screen, you can adjust layout settings of a document created with application software.
- You can not only adjust layout settings but also your changes will be instantly applied on the preview screen, and you can print the preview screen as it is seen.



Note

- The media type, image size, detailed media settings, and the printer settings can cause the actual print output to differ from the Preview settings.

Starting Preview

Follow the procedure below to start the Preview.

- 1** Start the application software which you use.
- 2** From the application software's **File** menu, select the printer setup menu to open the **Print** dialog box.



Note

- Normally, select **Print** from the **File** menu.

- 3** Click **Print Preview** in the **Main** panel to attach a checkmark.

4 Click the **Print** button in the **Print** dialog box.

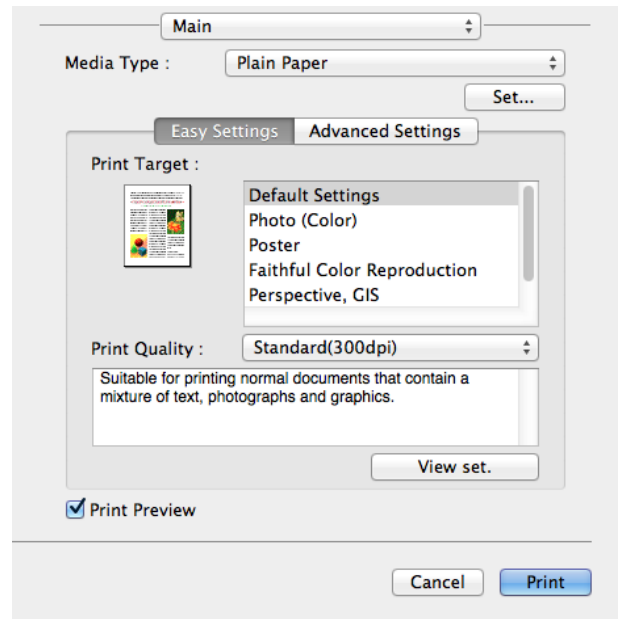

5 Preview main window is displayed.

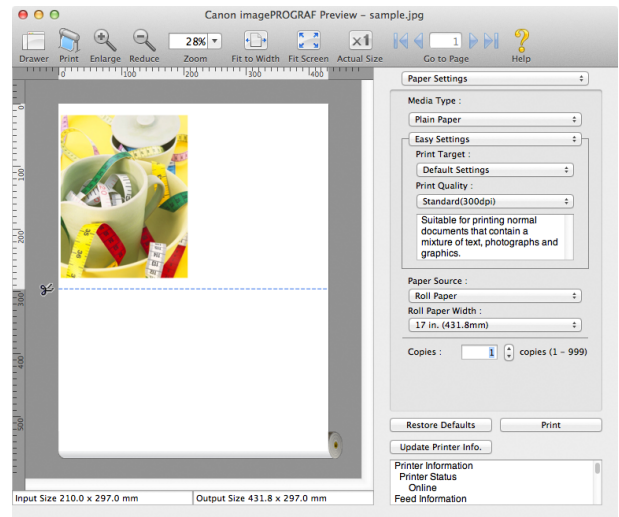

Preview Main Window

The Preview main window consists of the menu and tool bars, and preview, dialog, drawer and status area.

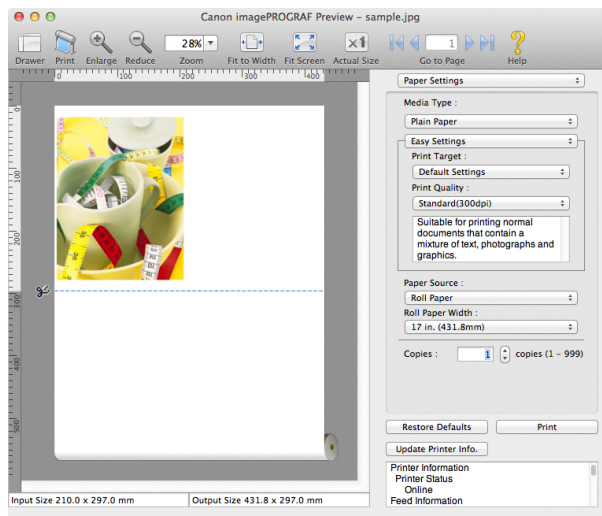



- You can use the **View** menu to show or hide the tool bar.

Note

- **Menu Bar**

This allows you to select menus required for operations.



- **Tool Bar**

This allows you to select tool buttons required for major operations.



- **Preview Area**

You can check the settings you made in this area.

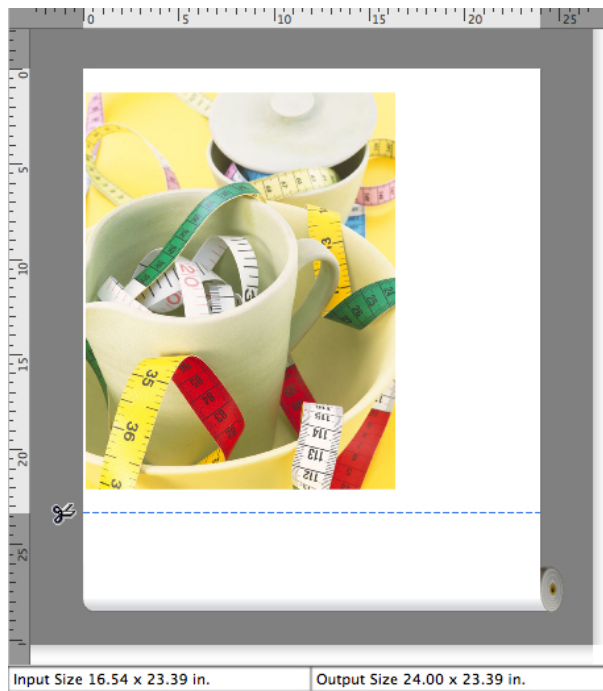

• **Dialog Area**

This allows you to set the print conditions and perform a print job.

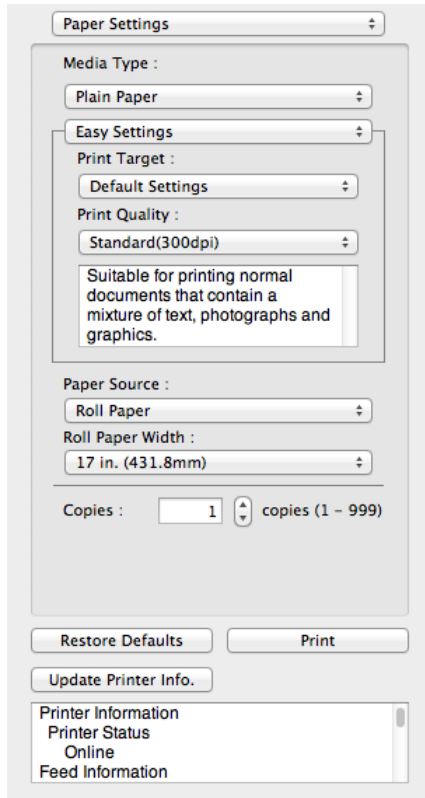

• **Drawer Area**

This allows you to display the thumbnails of a document.

This area appears when you click  **Drawer** from the tool bar.

Alternatively, you may select **Drawer** from the **View** menu.

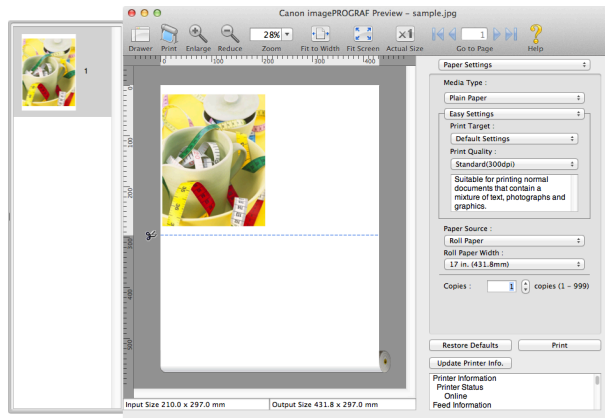

• **Status Area**

This shows **Input Size** and **Output Size**.

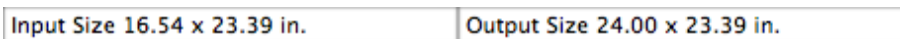

Paper Settings Panel

This panel appears when you select **Paper Settings** in the dialog area.

• Media Type

This allows you to select the media type.



- Always select media type that is actually set in the printer. When the media you chose is different from the media set in the printer, you may not receive the desired print results.

• Easy Settings / Advanced Settings

Two modes are available to provide the optimum print settings for jobs.

The settings available on each mode are as follows.

- Easy Settings → P.291
- Advanced Settings → P.292

• Paper Source

You can select the paper source.

The following settings are available for paper source.

Setting	Details
Cut Sheet	Select to print on the cut sheet.
Roll Paper 1	Select to print on the roll paper of Roll Paper 1 (Upper).
Roll Paper 2	Select to print on the roll paper of Roll Paper 2 (Lower).

• Roll Paper Width

This selects the width of the roll media set to the printer.



- Available only if rolls are selected in **Paper Source**.

• Copies

You can input the number of print copies in numerical characters.



- The maximum value is 999.
- You can change the numbers by clicking either ▲ button or ▼ button.

- **Restore Defaults** Button

Click the button to reset to the setting when starting Preview.

- **Print** Button

Click the button to begin printing.

- **Update Printer Info.** Button

Click the button to acquire printer information.

Easy Settings

You can easily select the best settings for the print job by just selecting an item from the print target list that matches the content of the document.

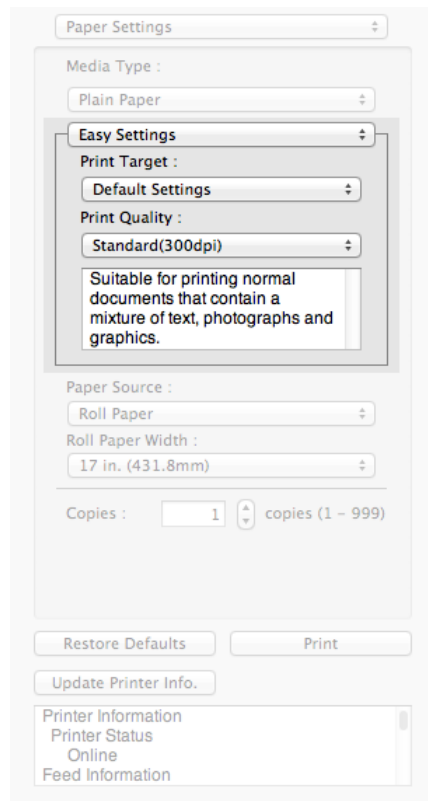

- **Print Target**

You can easily select the best settings for the print job simply.

If you select each **Print Target** item the corresponding comment for that item is displayed below the list.

Setting	Details
Default Settings	Suitable for printing normal documents that contain a mixture of text, photographs, and graphics.
Poster	The best setting for posters. Prints using vivid and high impact colors.
CAD (Color Line Drawing)	Prints the fine lines of CAD drawings and other such documents sharp and clear.
CAD (B/W Line Drawing)	Suitable for printing CAD drawings with sharp, dark lines.
Perspective, GIS	Suitable for attractive printing of 3D-CAD drawings, perspective drawings, and GIS drawings including maps.
Photo (Color)	Suitable for printing photographic images captured with a digital camera.
Office Document	Suitable for printing handouts as well as general office documents for which print clarity is key.
Faithful Color Reproduction	Prints by faithfully reproducing the colors of the original image.

Setting	Details
Custom Settings	Suitable for printing documents for which Advanced Settings have been specified.



- The number of settings available for selection depends on the media type.

Note

• Print Quality

Selecting print quality strikes a balance between the quality of the printed image and printing speed.

The level of the print quality and resolution settings are displayed in the following combinations.

Setting	Details
Print Quality	Highest quality / Highest / High / Standard / Fast
Resolution	1200dpi / 600dpi / 300dpi



Note

- The availability of settings is determined by the media type and print priority selections.
- Printing time is longer and more ink is consumed with **High** than with **Fast**, however, print quality is higher.
- Printing time is shorter and less ink is consumed with **Fast** than with **High**, however, print quality is lower.
- For **Highest quality**, the resolution is not displayed.

Advanced Settings

Presents detailed settings for the print quality, the color mode, and other items so you can select the values for these settings yourself.

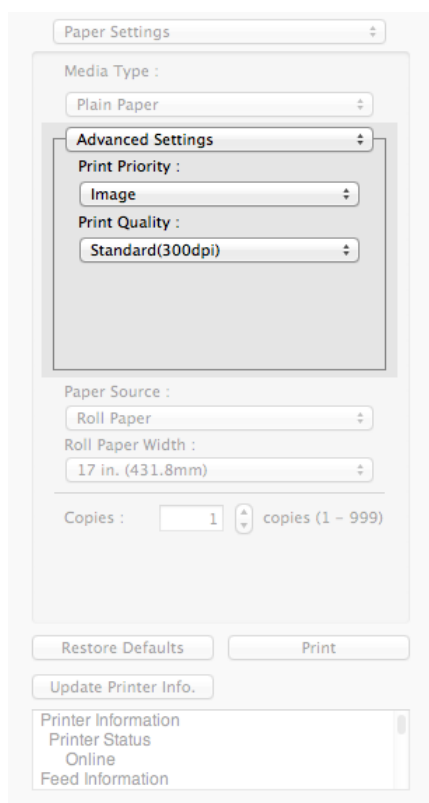

• Print Priority

Select a print quality mode that is appropriate for the print job.

Setting	Details
Image	This mode achieves the best results for printing photographic images and illustrations.

Setting	Details
Line Drawing	This mode is best for printing CAD drawings with fine lines or wall newsheet or other documents that contain large amounts of text. However, you may not achieve the quality you expect with printing photographs or other images with many filled areas. For these types of jobs, select Image .
Office Document	Prints common office documents, such as proposals, memos for distribution, etc., so they are easy to read.

 • The number of settings available for selection depends on the media type.

• Print Quality

Selecting print quality strikes a balance between the quality of the printed image and printing speed. The level of the print quality and resolution settings are displayed in the following combinations.

Setting	Details
Print Quality	Highest quality / Highest / High / Standard / Fast
Resolution	1200dpi / 600dpi / 300dpi

 • The availability of settings is determined by the media type and print priority selections.

 • Printing time is longer and more ink is consumed with **High** than with **Fast**, however, print quality is higher.

• Printing time is shorter and less ink is consumed with **Fast** than with **High**, however, print quality is lower.

• For **Highest quality**, the resolution is not displayed.

Output Settings Panel

This panel appears when you select **Output Settings** in the dialog area.

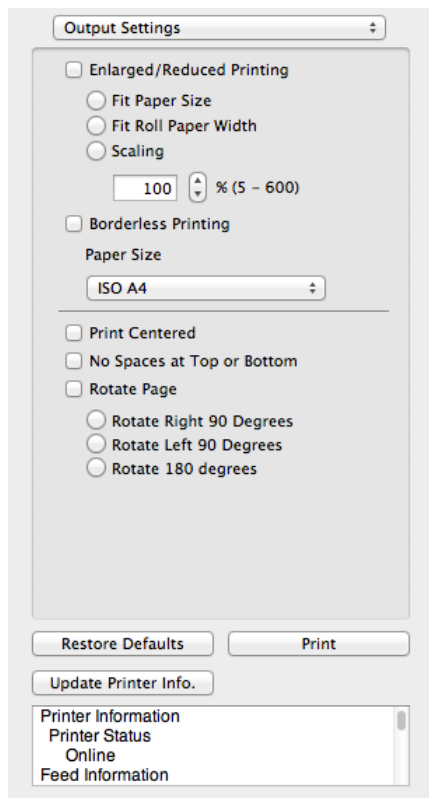

• Enlarged/Reduced Printing

Select the method for enlarged/reduced printing.

The following settings are available for enlarged/reduced printing.

Setting	Details
Fit Paper Size	Enlarges/reduces the whole page automatically to fit the media size selected for output. Select the media size to print from Paper Size .
Fit Roll Paper Width	Enlarges/reduces the whole page automatically to fit the width of the roll paper with the page width. *Make sure that the width of the roll paper in the printer is set correctly for Roll Paper Width in the Paper Settings panel. *Displayed only if rolls are selected in Paper Source .
Scaling	Enlarges/reduces the whole page by the scaling rate as specified. Input the scaling value in numerical characters. You can specify a range between 5 and 600%. *You can change the numbers by clicking either ▲ button or ▼ button. *Although Scaling can be set to make the image larger than the media size, the part that does not fit in the media cannot be printed. *This is not displayed when a checkmark is placed in Borderless Printing .

• Borderless Printing

You can print the media without margins on all sides when the roll paper with the specific width and the specific media type is used.

For more information about **Borderless Printing**, see "Print with No Borders." →P.302



Note

- Available only if rolls are selected in **Paper Source**.
- This is not displayed when a checkmark is placed in **Print Centered**.

• Paper Size

You can select the size of the print media.



Note

- This is not displayed when **Fit Roll Paper Width** is set in **Enlarged/Reduced Printing**.

• Print Centered

You can print on the center of the media loaded in the printer.

For more information about **Print Centered**, see "Print on the Center." →P.303



Note

- This is not displayed when a checkmark is placed in **Borderless Printing**.

• No Spaces at Top or Bottom

You can save paper on not to feed roll paper for the empty spaces when the print data contains spaces at the top or bottom.

For more information about **No Spaces at Top or Bottom**, see "Not Print Spaces at the Top/Bottom." →P.303



Note

- Available only if rolls are selected in **Paper Source**.

• Rotate Page

Select the method for rotating page.

The following settings are available for rotating page.

Setting	Details
Rotate Right 90 Degrees	Rotates the portrait page right 90 degrees and print in landscape orientation. When the rotated page can fit in the width of roll paper, the page is rotated automatically, and when it can not fit in the width of roll paper, the page is not rotated.
Rotate Left 90 Degrees	Rotates the portrait page left 90 degrees and print in landscape orientation. When the rotated page can fit in the width of roll paper, the page is rotated automatically, and when it can not fit in the width of roll paper, the page is not rotated.
Rotate 180 degrees	Allows you to rotate the image 180 degrees from the vertical to the right.

- **Restore Defaults Button**
Click the button to reset to the setting when starting Preview.
- **Print Button**
Click the button to begin printing.
- **Update Printer Info. Button**
Click the button to acquire printer information.

Color Settings Panel

This panel appears when you select **Color Settings** in the dialog area.

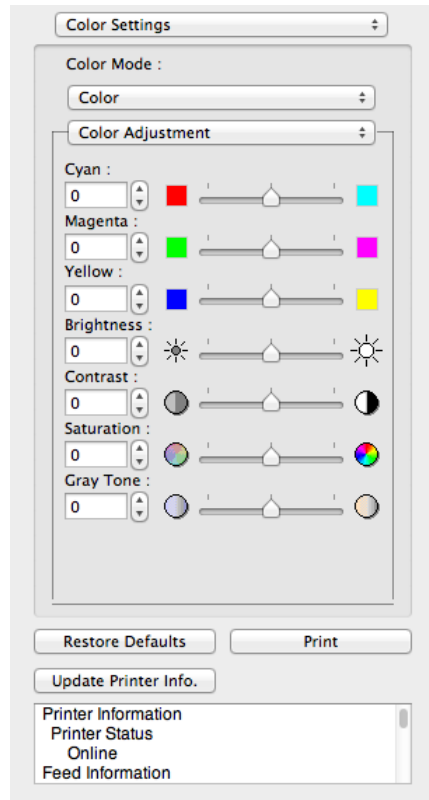

- **Color Mode**
You can select a color mode to suit the print job.

Setting	Details
Color	Enables color printing.
Monochrome	Disables color printing and converts image from continuous color to grayscaled monochrome.
Color (CAD)	Prints lines in the best color possible so they are easy to see.
Monochrome Bitmap	Prints all colors other than white in black.
Monochrome (BK ink)	Select to print all lines with black ink.
No color correction	Prints without performing color matching in the printer driver. Select this when color matching is performed by the application such as Adobe Photoshop or when you want to print color charts using the profile creation tool.

 • The availability of settings depends on the print priority and media type selections.

- **Color Adjustment / Matching**
You can set the color adjustment and matching.
 - **Color Adjustment** → P.296
 - **Matching** → P.298



• **Matching** is not displayed if **No color correction** has been selected in **Color Mode**.

Note

• **Restore Defaults** Button

Click the button to reset to the setting when starting Preview.

• **Print** Button

Click the button to begin printing.

• **Update Printer Info.** Button

Click the button to acquire printer information.

Color Adjustment

You can set the color adjustment.

Adjusting Color

Normally colors should be adjusted in the software application, but if you see colors in the printout that do not match colors on the screen, you can perform color adjustments.

1 Select **Color** on **Color Mode** in the **Color Settings** panel.

2 Select **Color Adjustment**.

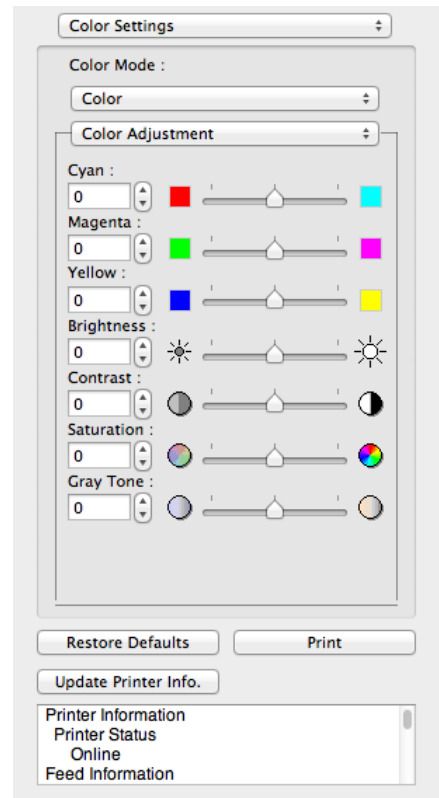

3 Drag each slider to the left or right to adjust.

Setting	Details
Cyan	Adjusts the strength of colors to compensate the hues.
Magenta	Adjusts the strength of colors to compensate the hues.
Yellow	Adjusts the strength of colors to compensate the hues.
Brightness	Adjusts the brightness of the entire image. When the results of the printout are brighter than the original images such as the original photo before scanning and graphics created on the display, or when you want to print in different degrees of brightness, use this feature.
Contrast	Adjusts the relative brightness between the brightest and darkest portions of the image.

Setting	Details
Contrast	*For soft gradation, decrease the contrast. For hard gradation, increase the contrast.
Saturation	Adjusts the hues for vivid color or dark color.
Gray Tone	Adjusts gray from cool black (bluish tones) to warm black (reddish tones).

 • You can also click the up or down arrow, or enter the number directly to increase or decrease the value.

Adjusting Monochrome

Use the monochrome setting to print monochrome images of color photographs captured with a scanner or digital camera or other color images.

- 1 Select **Monochrome** on **Color Mode** in the **Color Settings** panel.
- 2 Select **Color Adjustment**.

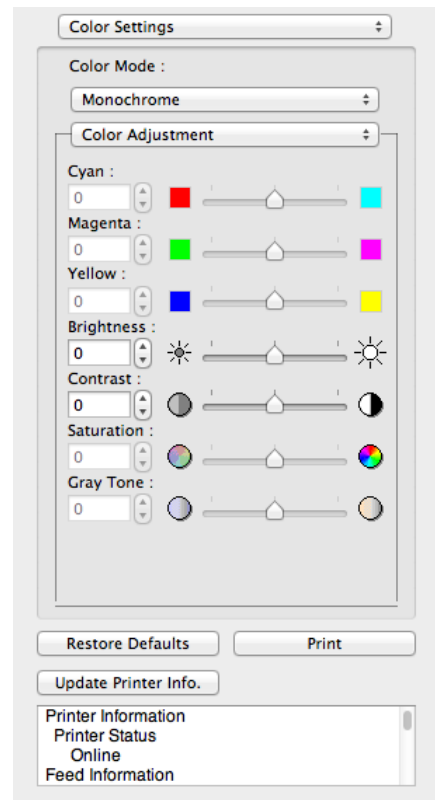

- 3 Drag each slider to the left or right to adjust.

Setting	Details
Brightness	Adjusts the brightness of the entire image. When the results of the printout are brighter than the original images such as the original photo before scanning and graphics created on the display, or when you want to print in different degrees of brightness, use this feature.
Contrast	Adjusts the relative brightness between the brightest and darkest portions of the image. *For soft gradation, decrease the contrast. For hard gradation, increase the contrast.

 • You can also click the up or down arrow, or enter the number directly to increase or decrease the value.

Matching

You can set the matching.



Important

- If **No color correction** is selected under **Color Mode**, the **Matching** is not displayed.

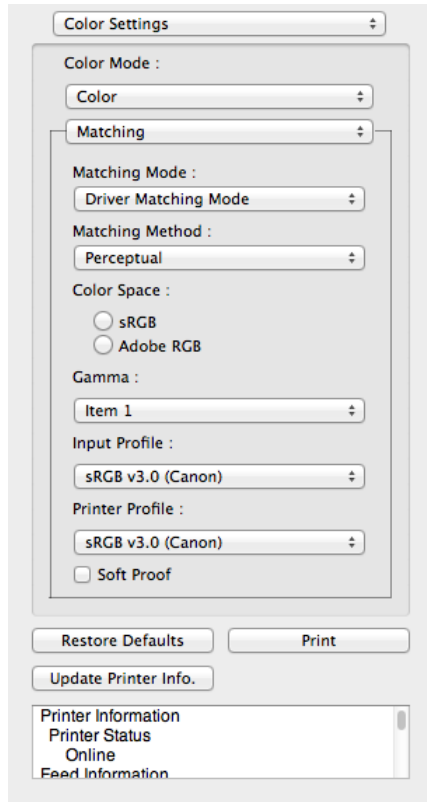

• Matching Mode

You can select a matching mode to suit the print job.

Setting	Details
Driver Matching Mode →P.299	Enables printing of optimal color tones using a driver specific color profile. You should normally select this mode.
ICC Matching Mode →P.300	Enables color matching using ICC profiles. Select this if you want to print by specifying the input profile, printer profile, and matching method in detail. This allows you to use ICC profiles for digital cameras and scanners, ICC profiles created using the profile creation tool, etc.
ColorSync →P.301	Enables color matching by using the ColorSync function of OS X. Select this if you want to perform soft proofing using ColorSync before printing.



Note

- You need to set each correction on the printer driver.
- **ColorSync** needs to be selected in the **Color Matching** panel of the driver in order to select **ColorSync**.

• Matching Method

You can select a matching method to suit the print job.

• Gamma

You can adjust the gradation of intermediate tones in an image. **2.2** is normally selected. If you want a softer impression than **2.2**, select **1.8**.



Note

- You can select only after **Driver Matching Mode** has been selected in **Matching Mode**.

• **Input Profile**

Select the input profile.



• You can select only after **ICC Matching Mode** has been selected in **Matching Mode**.

• **Printer Profile**

Select the printer profile.



• You can select only after **ICC Matching Mode** has been selected in **Matching Mode**.

• **Soft Proof**

When you place a checkmark here, **ColorSync** applies to the preview area.



• You can select only after **ColorSync** has been selected in **Matching Mode**.

Driver Matching Mode

1 Under **Matching Mode**, select **Driver Matching Mode**.

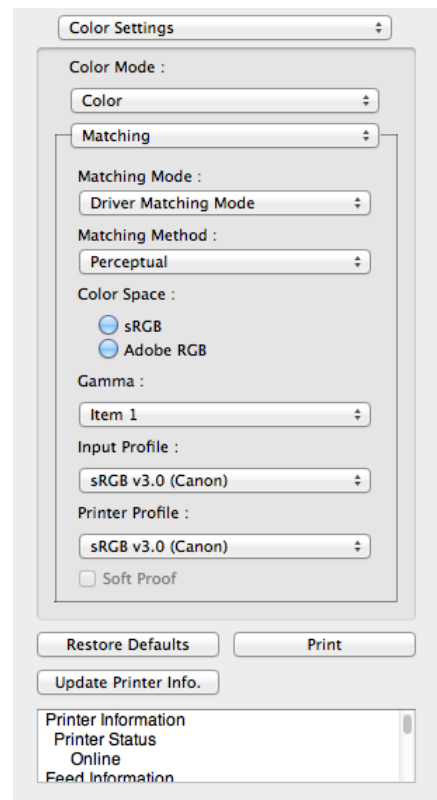

2 Click the **Matching Method** list, and then select a setting.

Setting	Details
Auto	Automatically selects the best color matching method for each Image, Graphics, Text.
Perceptual	Color-matching optimized for printing typical photos attractively. Smooth gradation is a feature. This is also an easy-to-use mode when performing color adjustment using application software.
Saturation	Color-matching optimized for printing posters, etc., vividly.
Colorimetric	Color-matching optimized for printing image data with accurate colors in input color space. This is the easiest-to-use mode when you want to adjust the color and print. However, gradation may be lost for colors of wider range than the color reproduction range of the printer. Generally, this is also called relative colorimetric.

ICC Matching Mode

1 Under **Matching Mode**, select **ICC Matching Mode**.

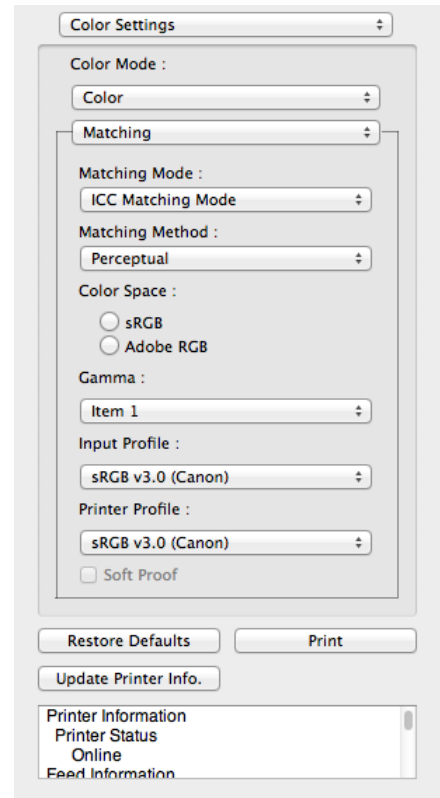

2 Click the **Matching Method** list, and then select a setting.

Setting	Details
Perceptual	Color-matching optimized for printing typical photos attractively. Smooth gradation is a feature. This is also an easy-to-use mode when performing color adjustment using application software.
Saturation	Color-matching optimized for printing posters, etc., vividly.
Colorimetric	Color-matching optimized for printing image data with accurate colors in input color space. This is the easiest-to-use mode when you want to adjust the color and print. However, gradation may be lost for colors of wider range than the color reproduction range of the printer. Generally, this is also called relative colorimetric.
Colorimetric (No White-Point Correction)	The processing method of color-matching is identical to Colorimetric . Use this when you want to further reproduce the target paper material color of the image data. Generally, this also is called absolute colorimetric.

3 Click the **Input Profile** list and select an input profile.

4 Click the **Printer Profile** list and select a printer profile.

ColorSync

1 Check that **ColorSync** is selected in **Matching Mode**.

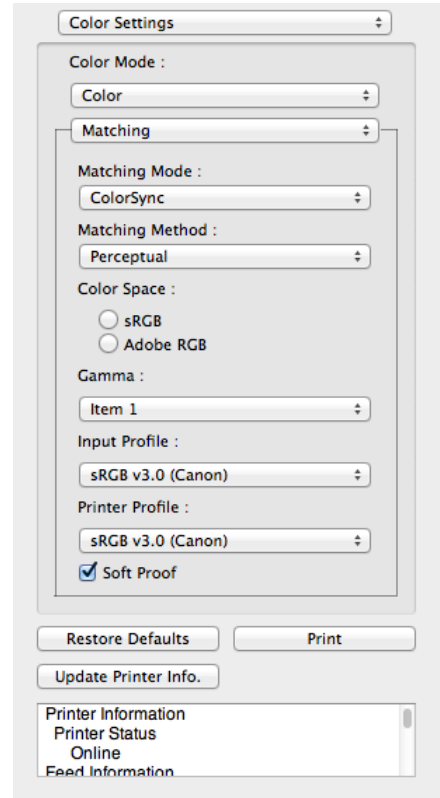

2 To apply **ColorSync** to previews, check the **Soft Proof** check box.

Preferences Dialog Box

This dialog box appears when you select **Preferences** from the **imagePROGRAF Advanced Preview** menu. You can set the preferences for Preview.

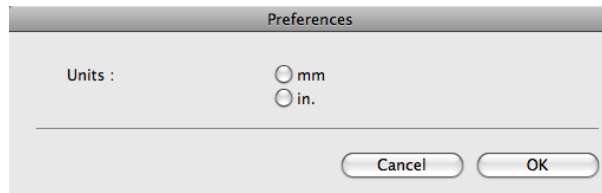

• Units

Set the unit for paper length, margins, and so on.

Zoom Dialog Box

This dialog box appears when you select **Zoom** from the **View** menu. You can enlarge or reduce the screen display.

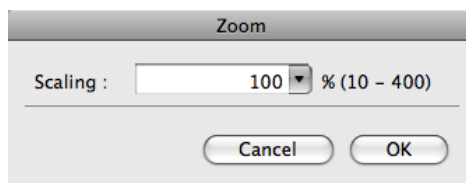

• Scaling

Set the magnification for enlargement or reduction of the screen display.



- You can input between 10 and 400.
- You can change the numbers by clicking ▼ button.

Go to Page Dialog Box

This dialog box appears when you select **Go to Page** from the **View** menu.

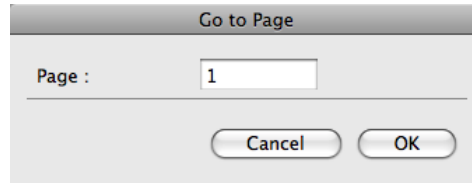

- You can not select **Go to Page** if the document is only one page.

Page

Input the page number in numerical characters to display in the preview area.



- You can change the numbers in the range of the page of the documents.

Print with No Borders

You can use the borderless printing function to print without margins surrounding the image.



- With some media borderless printing can be performed only between two edges.
- To use the borderless printing function, the specified media must be set to the printer.
- Do not perform borderless printing when using the stacker. Doing so may cause a paper jam.

- On the **Paper Settings Panel** (→P.290), select Roll Paper in **Paper Source**.
- On the **Output Settings Panel** (→P.293), click the **Enlarged/Reduced Printing** check box on.
- Select **Fit Roll Paper Width**.
- Click the **Borderless Printing** check box on.

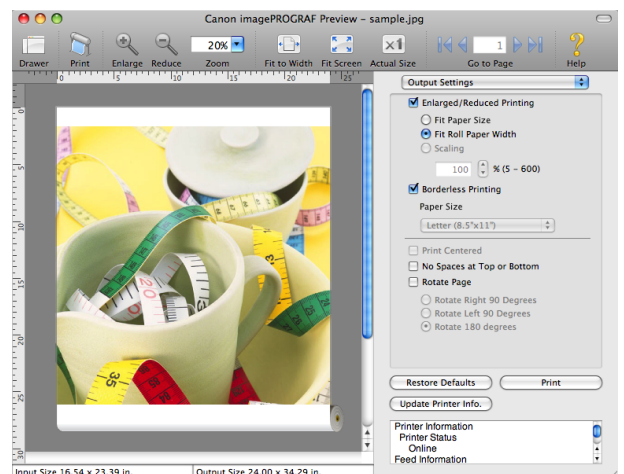

- Click the **Print** button.
Borderless printing begins.

Print on the Center

You can print on the center of the media loaded in the printer.

Note • This is not displayed when a checkmark is placed in **Borderless Printing**.

1 On the Output Settings Panel →P.293 , click the **Print Centered** check box on.

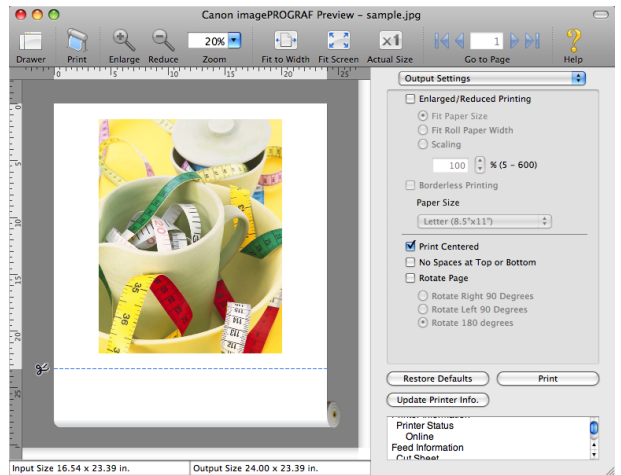

2 Click the **Print** button.
Printing on the center begins.

Not Print Spaces at the Top/Bottom

You can save paper on not to feed roll paper for the empty spaces when the print data contains spaces at the top or bottom.

Note • This is not displayed when a checkmark is placed in **Borderless Printing**.

1 On the Paper Settings Panel →P.290 , select Roll Paper in **Paper Source**.

2 On the Output Settings Panel →P.293 , click the **No Spaces at Top or Bottom** check box on.

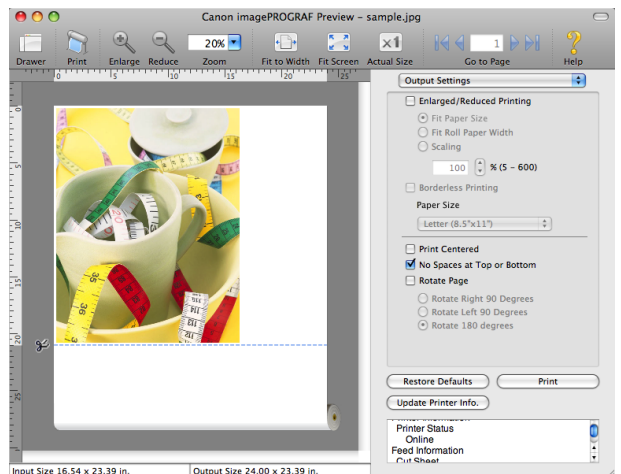

3 Click the **Print** button.
Printing on the settings with no spaces at top or bottom begins.

Print Page Rotated 90 Degrees

You can save paper by printing in landscape orientation on roll paper.

- 1 On the **Paper Settings Panel** → P.290 , select **Roll Paper** in **Paper Source**.
- 2 On the **Output Settings Panel** → P.293 , click the **Rotate Page** check box on.
- 3 Select **Rotate Right 90 Degrees** or **Rotate Left 90 Degrees**.

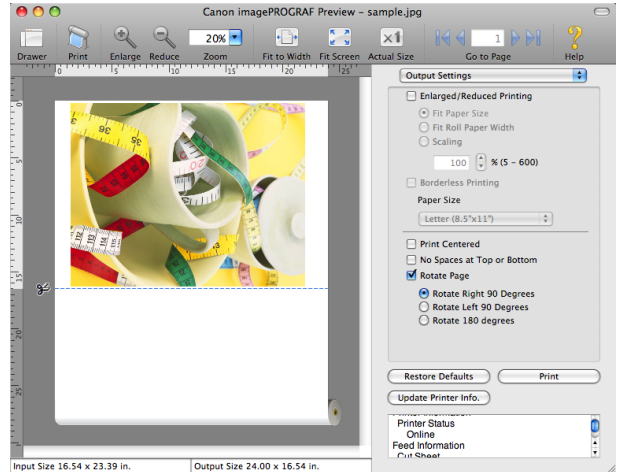

- 4 Click the **Print** button.
Printing on rotating 90 degrees begins.

Display with Fitting to the Width of the Paper

In the preview area, you can display to the width of the paper.

- 1 Select  **Fit to Width** from the tool bar.
- 2 Fitting to the width of the paper, it is displayed.

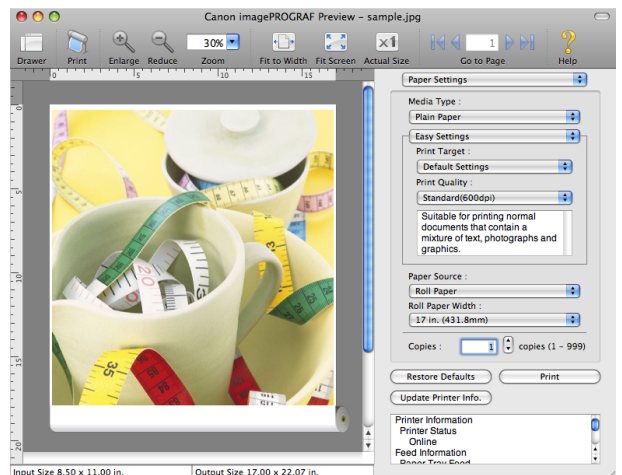

Display with All

In the preview area, you can display all.

- 1 Select  **Fit Screen** from the tool bar.

2 All is displayed.

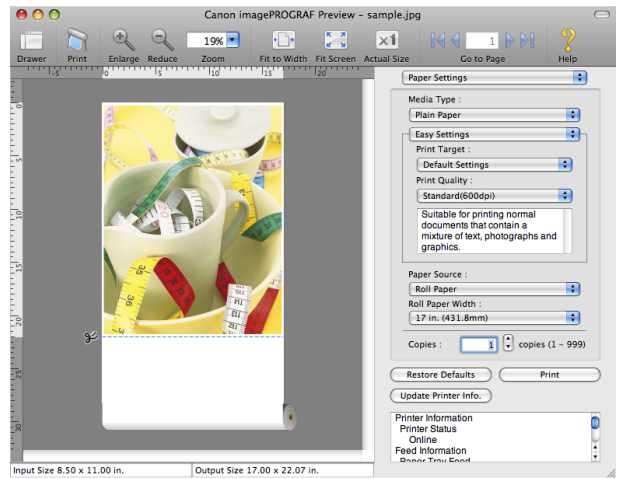

Display with Actual Size

In the preview area, you can display the actual size.

1 Select  **Actual Size** from the tool bar.



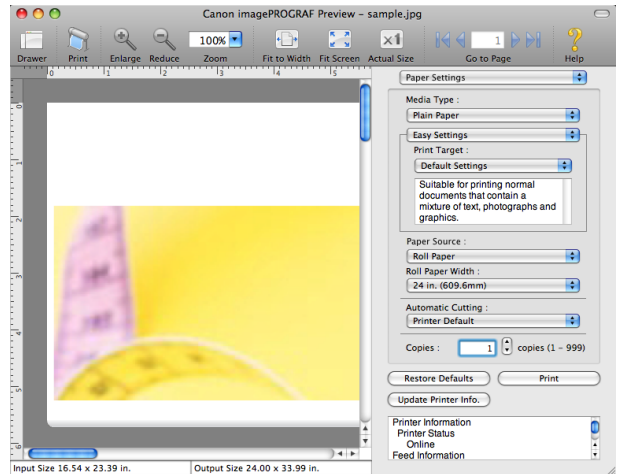

2 Actual size is displayed.



Moving a Page

You can move a page to display in the preview area.

1 Select each button in **Go to Page** on the tool bar.

Setting	Details
	Go to the first page.
	Go to the previous page.
	Go to the next page.
	Go to the last page.

2

The target page appears.

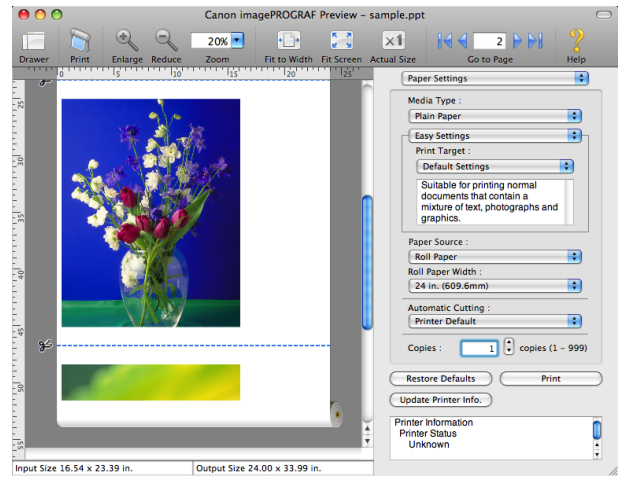

Note

- You can also move a page by clicking the page on the thumbnails.

Free Layout	
The Features of Free Layout	307
Starting Free Layout	307
Free Layout Main Window	308
Paper Settings Panel	310
Easy Settings	311
Advanced Settings	312
Color Settings Panel	313
Color Adjustment	314
Matching	316
Driver Matching Mode	318
ICC Matching Mode	319
ColorSync	320
Preferences Dialog Box	320
Page Setup Dialog Box	321
Zoom Dialog Box	322
Format Dialog Box	323
Laying out a Multiple-File Document on One Page	323
Laying out a Document Created with Multiple Application Programs on One Page	324
Selecting an Object	324
Changing the Object Size	324
Moving an Object	325
Rotating an Object	325
Laying out Objects Automatically	326
Aligning Objects	326
Changing the Object Overlapping Order	328
Pasting a Copied or Cut Object	329

The Features of Free Layout

The main features of Free Layout are as follows.

- Allows you to lay out at will and print a document created with application software.
- You can not only lay out multiple pages on one page but also lay out and print a multiple-file document on one page, or lay out and print a document created with multiple application programs on one page.



Note

- The media type, image size, detailed media settings, and the printer settings can cause the actual print output to differ from the Free Layout settings.

Starting Free Layout

Follow the procedure below to start the Free Layout.

- 1** Start the application software which you use.
- 2** From the application software's **File** menu, select the printer setup menu to open the **Print** dialog box.
 - Normally, select **Print** from the **File** menu.
- 3** Click on **Free Layout** in the **Page Setup** panel to attach a checkmark.



Note

4 Click the **Print** button in the **Print** dialog box.

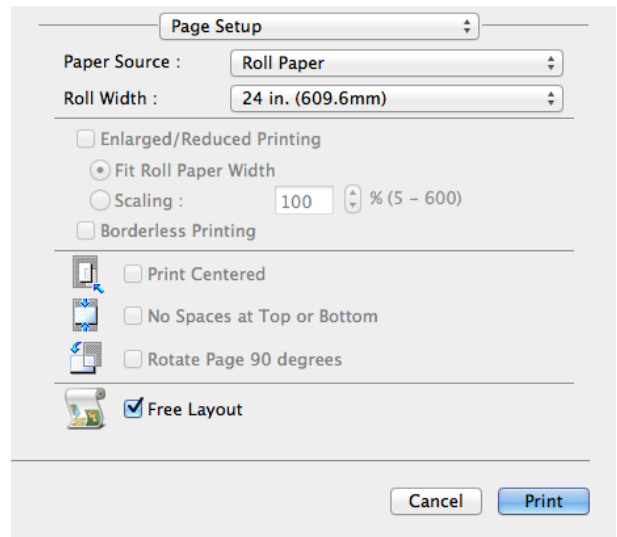

5 Free Layout main window is displayed.

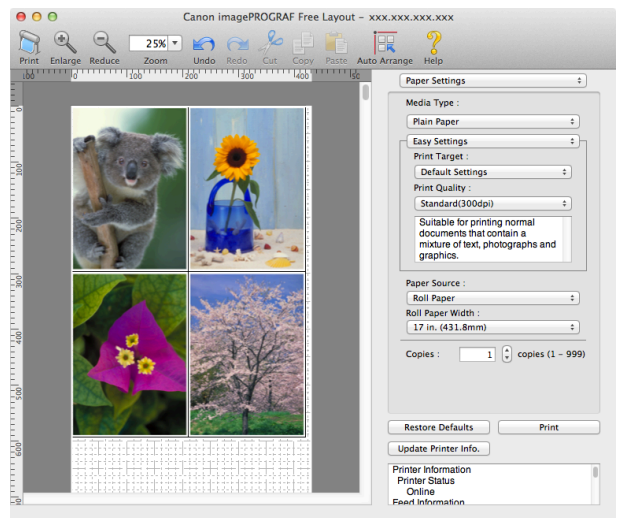

Free Layout Main Window

The Free Layout main window consists of the menu and tool bars, layout area and dialog areas.

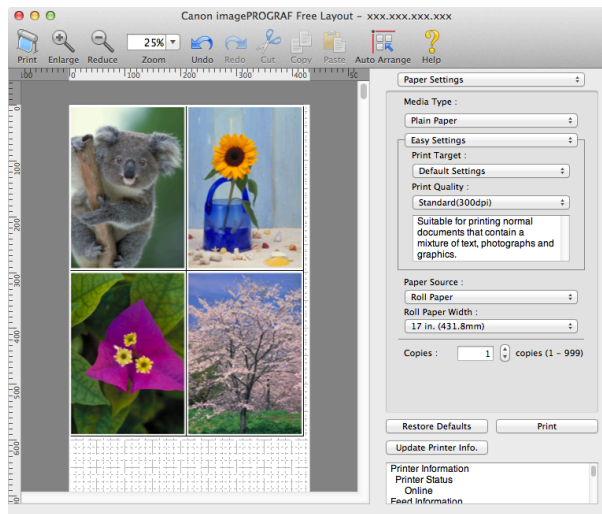

• You can use the **View** menu to show or hide the tool.

Note

• Menu Bar

This allows you to select menus required for operations.



• Tool Bar

This allows you to select tool buttons required for major operations.



• Layout Area

This allows you to lay out objects and edit the object size and orientation.

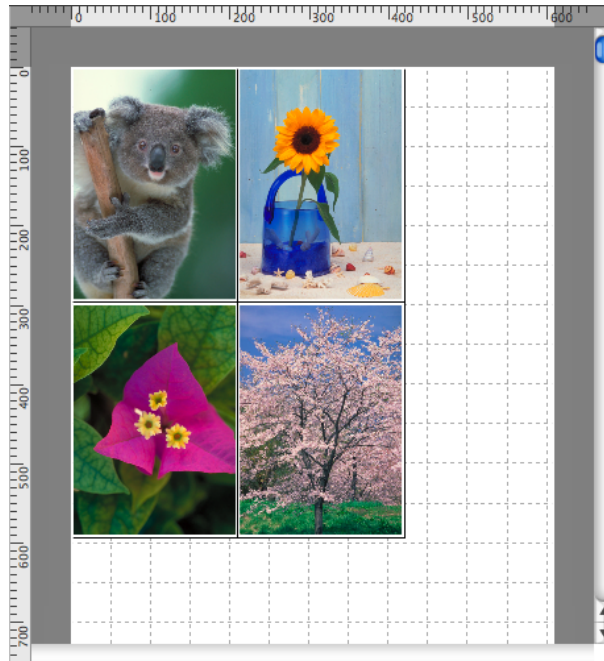

• Dialog Area

This allows you to set the print conditions and perform a print job.

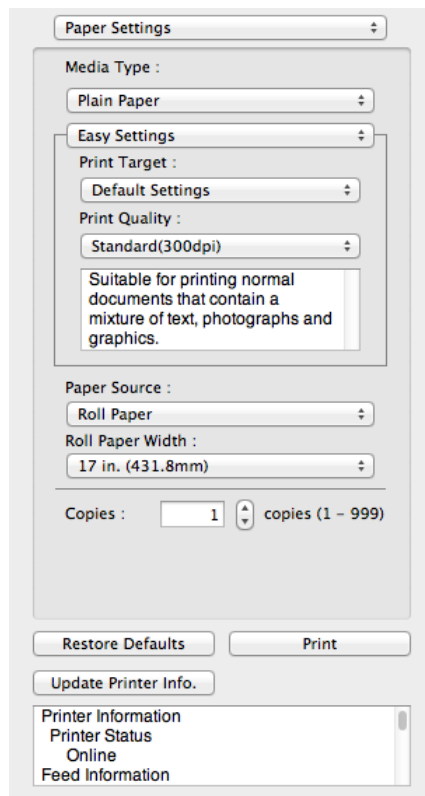

Paper Settings Panel

This panel appears when you select **Paper Settings** in the dialog area.

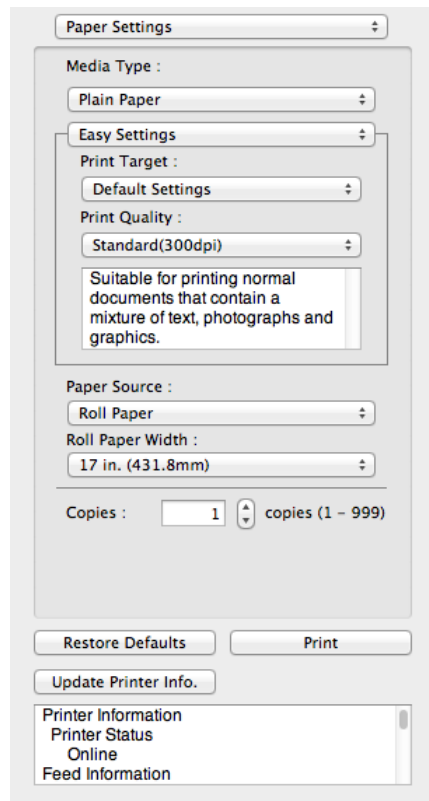

• Media Type

This allows you to select the media type.



- Always select media type that is actually set in the printer. When the media you chose is different from the media set in the printer, you may not receive the desired print results.

• Easy Settings / Advanced Settings

Two modes are available to provide the optimum print settings for jobs. The settings available on each mode are as follows.

- Easy Settings →P.311
- Advanced Settings →P.312

• Paper Source

You can select the paper source. The following settings are available for paper source.

Setting	Details
Cut Sheet	Select to print on the cut sheet.
Roll Paper 1	Select to print on the roll paper of Roll Paper 1 (Upper).
Roll Paper 2	Select to print on the roll paper of Roll Paper 2 (Lower).

• Roll Paper Width

This selects the width of the roll media set to the printer.



- Available only if rolls are selected in **Paper Source**.

• Copies

You can input the number of print copies in numerical characters.



- The maximum value is 999.
- You can change the numbers by clicking either ▲ button or ▼ button.

- **Restore Defaults** Button

Click the button to reset to the setting when starting Free Layout.

- **Print** Button

Click the button to begin printing.

- **Update Printer Info.** Button

Click the button to acquire printer information.

Easy Settings

You can easily select the best settings for the print job by just selecting an item from the print target list that matches the content of the document.

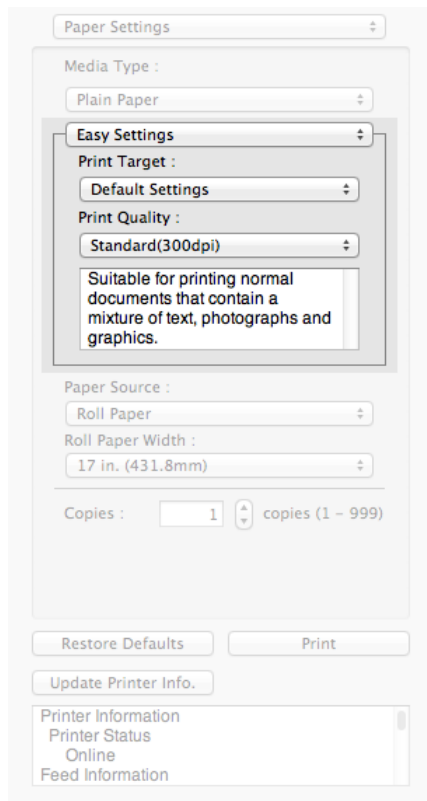

- **Print Target**

You can easily select the best settings for the print job simply.

If you select each **Print Target** item the corresponding comment for that item is displayed below the list.

Setting	Details
Default Settings	Suitable for printing normal documents that contain a mixture of text, photographs, and graphics.
Poster	The best setting for posters. Prints using vivid and high impact colors.
CAD (Color Line Drawing)	Suitable for printing fine lines such as drawings clearly.
CAD (B/W Line Drawing)	Suitable for printing CAD drawings with sharp, dark lines.
Perspective, GIS	Suitable for attractive printing of 3D-CAD drawings, perspective drawings, and GIS drawings including maps.
Photo (Color)	Suitable for printing photographic images captured with a digital camera.
Office Document	Suitable for printing handouts as well as general office documents for which print clarity is key.
Faithful Color Reproduction	Prints by minimizing color differences. Suitable for when the printing results are too vivid or when printing scanned images.

Setting	Details
Custom Settings	Suitable for printing documents for which Advanced Settings have been specified.

 **Note** • The number of settings available for selection depends on the media type.

• **Print Quality**

Selecting print quality strikes a balance between the quality of the printed image and printing speed.

The level of the print quality and resolution settings are displayed in the following combinations.

Setting	Details
Print Quality	Highest quality / Highest / High / Standard / Fast
Resolution	1200dpi / 600dpi / 300dpi

 **Note**

- The availability of settings is determined by the media type and print priority selections.
- Printing time is longer and more ink is consumed with **High** than with **Fast**, however, print quality is higher.
- Printing time is shorter and less ink is consumed with **Fast** than with **High**, however, print quality is lower.
- For **Highest quality**, the resolution is not displayed.

Advanced Settings

Presents detailed settings for the print priority, the print quality, and other items so you can select the values for these settings yourself.

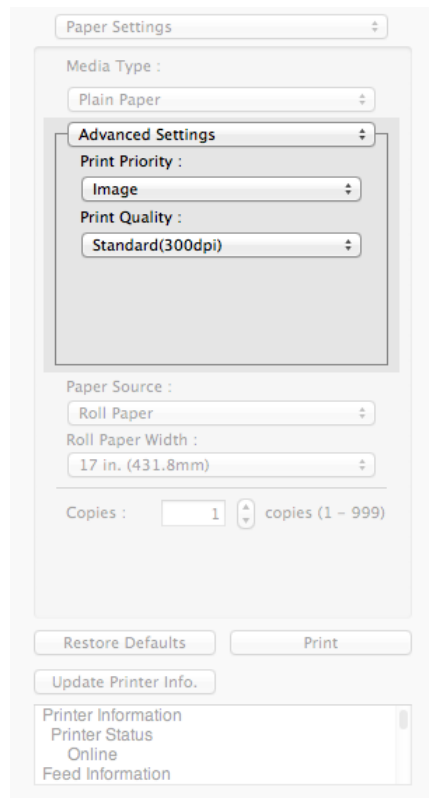

• **Print Priority**

Select a print quality mode that is appropriate for the print job.

Setting	Details
Image	This mode achieves the best results for printing photographic images and illustrations.

Setting	Details
Line Drawing	This mode is best for printing CAD drawings with fine lines or wall newsheet or other documents that contain large amounts of text. However, you may not achieve the quality you expect with printing photographs or other images with many filled areas. For these types of jobs, select Image .
Office Document	Prints common office documents, such as proposals, memos for distribution, etc., so they are easy to read.

 • The number of settings available for selection depends on the media type.

• Print Quality

Selecting print quality strikes a balance between the quality of the printed image and printing speed. The level of the print quality and resolution settings are displayed in the following combinations.

Setting	Details
Print Quality	Highest quality / Highest / High / Standard / Fast
Resolution	1200dpi / 600dpi / 300dpi

-  • The availability of settings is determined by the media type and print priority selections.
- Note** • Printing time is longer and more ink is consumed with **High** than with **Fast**, however, print quality is higher.
- Printing time is shorter and less ink is consumed with **Fast** than with **High**, however, print quality is lower.
- For **Highest quality**, the resolution is not displayed.

Color Settings Panel

This panel appears when you select **Color Settings** in the dialog area.

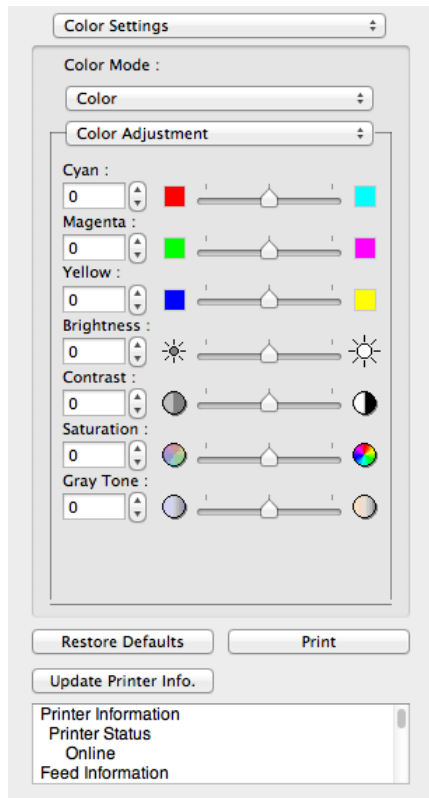

• Color Mode

You can select a color mode to suit the print job.

Setting	Details
Color	Enables color printing.
Monochrome	Disables color printing and converts image from continuous color to grayscaled monochrome.
Color (CAD)	Prints lines in the best color possible so they are easy to see.
Monochrome Bitmap	Prints all colors other than white in black.
Monochrome (BK ink)	Select to print all lines with black ink.
No color correction	Prints without performing color matching in the printer driver. Select this when color matching is performed by the application such as Adobe Photoshop or when you want to print color charts using the profile creation tool.



Note

- The availability of settings depends on the print priority and media type selections.

• Color Adjustment / Matching

You can set the color adjustment and matching.

- **Color Adjustment** →P.314
- **Matching** →P.316



Note

- **Matching** is not displayed if **No color correction** has been selected in **Color Mode**.

• Restore Defaults Button

Click the button to reset to the setting when starting Free Layout.

• Print Button

Click the button to begin printing.

• Update Printer Info. Button

Click the button to acquire printer information.

Color Adjustment

You can set the color adjustment.

Adjusting Color

Normally colors should be adjusted in the software application, but if you see colors in the printout that do not match colors on the screen, you can perform color adjustments.

- 1 Select **Color** on **Color Mode** in the **Color Settings** panel.

2 Select **Color Adjustment**.

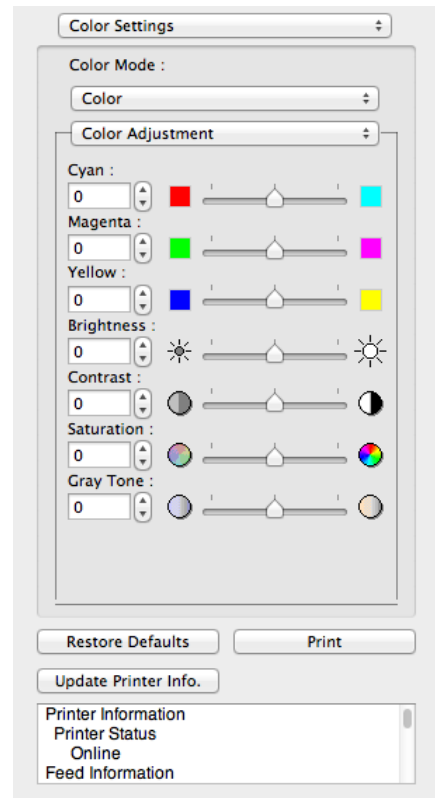

3 Drag each slider to the left or right to adjust.

Setting	Details
Cyan	Adjusts the strength of colors to compensate the hues.
Magenta	Adjusts the strength of colors to compensate the hues.
Yellow	Adjusts the strength of colors to compensate the hues.
Brightness	Adjusts the brightness of the entire image. When the results of the printout are brighter than the original images such as the original photo before scanning and graphics created on the display, or when you want to print in different degrees of brightness, use this feature.
Contrast	Adjusts the relative brightness between the brightest and darkest portions of the image. *For soft gradation, decrease the contrast. For hard gradation, increase the contrast.
Saturation	Adjusts the hues for vivid color or dark color.
Gray Tone	Adjusts gray from cool black (bluish tones) to warm black (reddish tones).

 • You can also click the up or down arrow, or enter the number directly to increase or decrease the value.

Note

Adjusting Monochrome

Use the monochrome setting to print monochrome images of color photographs captured with a scanner or digital camera or other color images.

1 Select **Monochrome** on **Color Mode** in the **Color Settings** panel.

2 Select Color Adjustment.

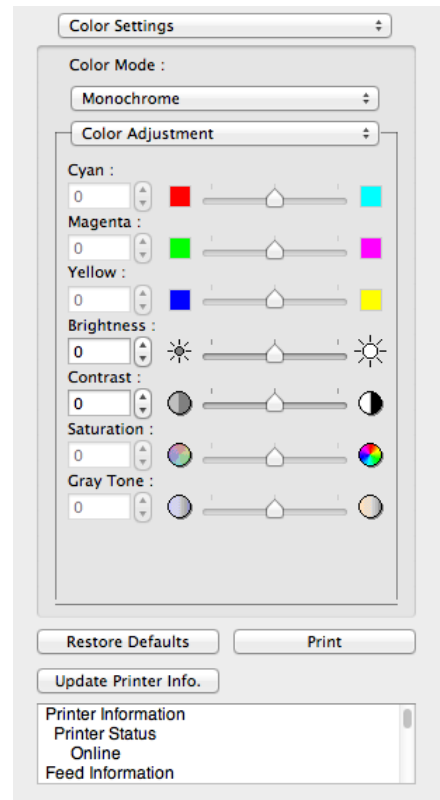

3 Drag each slider to the left or right to adjust.

Setting	Details
Brightness	Adjusts the brightness of the entire image. When the results of the printout are brighter than the original images such as the original photo before scanning and graphics created on the display, or when you want to print in different degrees of brightness, use this feature.
Contrast	Adjusts the relative brightness between the brightest and darkest portions of the image. *For soft gradation, decrease the contrast. For hard gradation, increase the contrast.



- You can also click the up or down arrow, or enter the number directly to increase or decrease the value.

Note

Matching

You can set the matching.



Important

- If **No color correction** is selected under **Color Mode**, the **Matching** is not displayed.

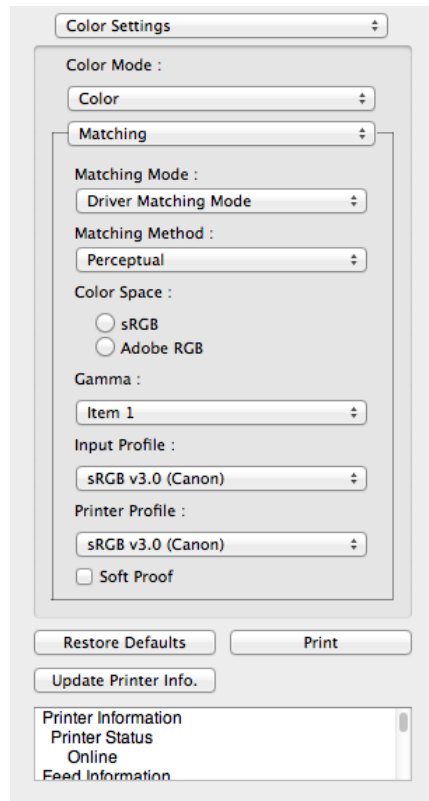

• Matching Mode

You can select a matching mode to suit the print job.

Setting	Details
Driver Matching Mode →P.318	Enables printing of optimal color tones using a driver specific color profile. You should normally select this mode.
ICC Matching Mode →P.319	Enables color matching using ICC profiles. Select this if you want to print by specifying the input profile, printer profile, and matching method in detail. This allows you to use ICC profiles for digital cameras and scanners, ICC profiles created using the profile creation tool, etc.
ColorSync →P.320	Enables color matching by using the ColorSync function of OS X. Select this if you want to perform soft proofing using ColorSync before printing.

• You need to set each correction on the printer driver.
Note • **ColorSync** needs to be selected in the **Color Matching** panel of the driver in order to select **ColorSync**.

• Matching Method

You can select a matching method to suit the print job.

• Gamma

You can adjust the gradation of intermediate tones in an image. **2.2** is normally selected. If you want a softer impression than **2.2**, select **1.8**.

• You can select only after **Driver Matching Mode** has been selected in **Matching Mode**.
Note

• Input Profile

Select the input profile.

• You can select only after **ICC Matching Mode** has been selected in **Matching Mode**.
Note

• Printer Profile

Select the printer profile.



You can select only after **ICC Matching Mode** has been selected in **Matching Mode**.

Soft Proof

When you place a checkmark here, **ColorSync** applies to the layout area.



You can select only after **ColorSync** has been selected in **Matching Mode**.

Driver Matching Mode

1 Under **Matching Mode**, select **Driver Matching Mode**.

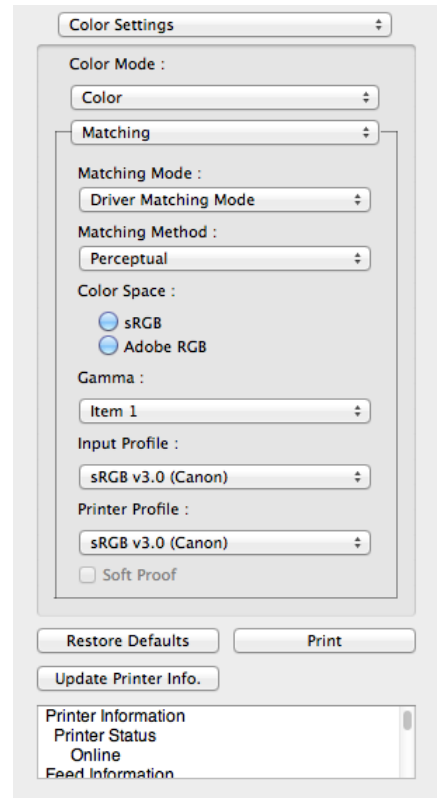

2 Click the **Matching Method** list, and then select a setting.

Setting	Details
Auto	Automatically selects the best color matching method for each Image, Graphics, Text.
Perceptual	Color-matching optimized for printing typical photos attractively. Smooth gradation is a feature. This is also an easy-to-use mode when performing color adjustment using application software.
Saturation	Color-matching optimized for printing posters, etc., vividly.
Colorimetric	Color-matching optimized for printing image data with accurate colors in input color space. This is the easiest-to-use mode when you want to adjust the color and print. However, gradation may be lost for colors of wider range than the color reproduction range of the printer. Generally, this is also called relative colorimetric.

ICC Matching Mode

1 Under **Matching Mode**, select **ICC Matching Mode**.

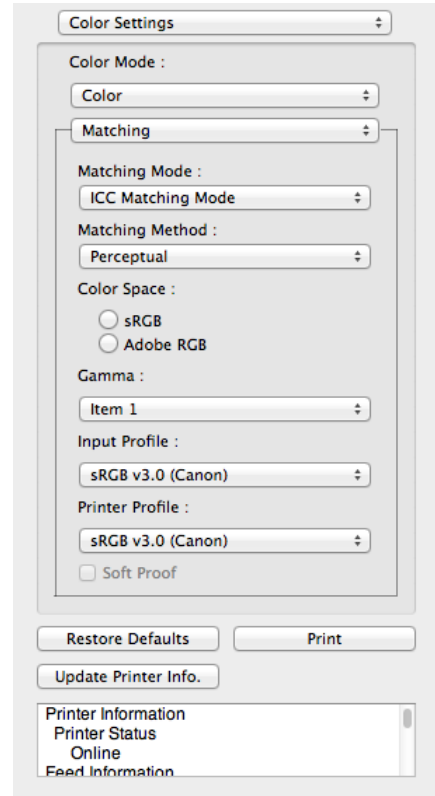

2 Click the **Matching Method** list, and then select a setting.

Setting	Details
Perceptual	Color-matching optimized for printing typical photos attractively. Smooth gradation is a feature. This is also an easy-to-use mode when performing color adjustment using application software.
Saturation	Color-matching optimized for printing posters, etc., vividly.
Colorimetric	Color-matching optimized for printing image data with accurate colors in input color space. This is the easiest-to-use mode when you want to adjust the color and print. However, gradation may be lost for colors of wider range than the color reproduction range of the printer. Generally, this is also called relative colorimetric.
Colorimetric (No White-Point Correction)	The processing method of color-matching is identical to Colorimetric . Use this when you want to further reproduce the target paper material color of the image data. Generally, this also is called absolute colorimetric.

3 Click the **Input Profile** list and select an input profile.

4 Click the **Printer Profile** list and select a printer profile.

ColorSync

1 Check that **ColorSync** is selected in **Matching Mode**.

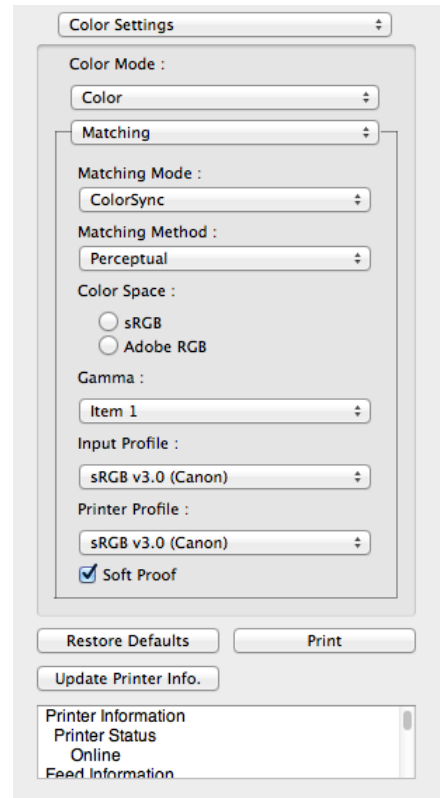

2 Place a checkmark on **Soft Proof** to simulate the output product in Layout Area.

Preferences Dialog Box

This dialog box appears when you select **Preferences** from the imagePROGRAF Advanced Preview menu. You can set the preferences for Free Layout.

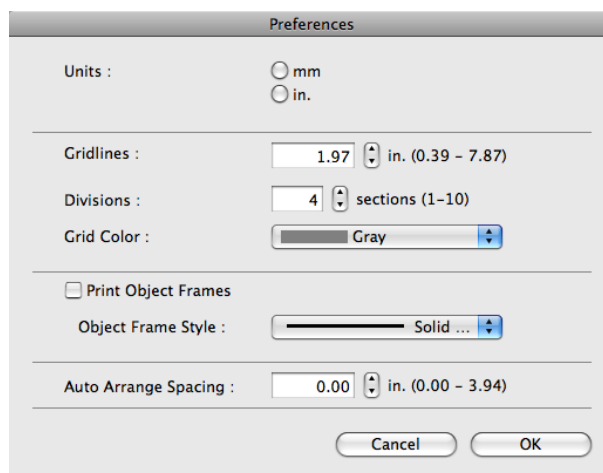

• Units

Set the unit for paper length, margins, and so on.

• Gridlines

You can input a grid line width value in numerical characters so that they serve as a guide to laying out objects.



- You can input between 10.0 and 200.0(mm) (between 0.39 and 7.87(inch)).
- You can change the numbers by clicking either ▲ button or ▼ button.

• Divisions

You can change the number of divisions of grid lines so that they serve as a guide to laying out objects.



- You can input between 1 and 10.
- You can change the numbers by clicking either ▲ button or ▼ button.

• Grid Color

Select the grid line color.

• Print Object Frames

You can print the object border.



- If you do not want to print the object border, deselect the **Print Object Frames** check box.

• Object Frame Style

You can select the object frame style for printing.

The following settings are available for the object frame style.

Setting	Details
Solid Line	You can print the solid line as the frame style.
Dotted Line	You can print the dotted line as the frame style.
Dashed Line	You can print the dashed line as the frame style.

• Auto Arrange Spacing

Change the object-to-object spacing to be applied in the operation of laying out objects automatically.



- You can input between 0.0 and 100.0(mm) (between 0.00 and 3.94(inch)).
- You can change the numbers by clicking either ▲ button or ▼ button.

Page Setup Dialog Box

This dialog box appears when you select **Page Setup** from the **File** menu. This dialog box provides selections for setting the media size, orientation and other important features.

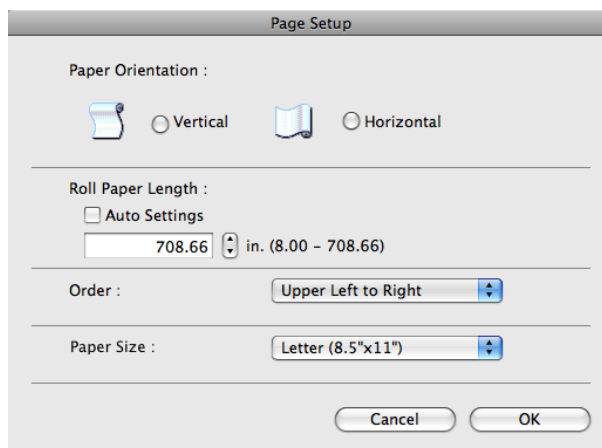

• Paper Orientation

This selects the paper orientation.

The following settings are available for orientation.

Setting	Details
Vertical	Prints the image and text created with the application software in the orientation as it is.
Horizontal	Prints the image and text by rotating sideways 90 degrees from the orientation as specified in the application.

• Roll Paper Length

Set the length of one page to print on roll paper.

When you place a checkmark on **Auto Settings**, the one-page length to be printed on roll paper is automatically set so that the laid-out objects are printed on one page.



Note

- Available only if rolls are selected in **Paper Source**.
- You can input between 203.2 and 18000.0(mm) (between 8.00 and 708.66(inch)).
- You can change the numbers by clicking either ▲ button or ▼ button.

• Order

Set the object layout order.

The following settings are available for order.

Setting	Details
Upper Left to Right	The objects are laid out from upper left to right.
Upper Left to Bottom	The objects are laid out from upper left to bottom.



Note

- When you have selected **Roll Paper Length > Auto Settings** and **Paper Orientation > Vertical**, you can choose only **Upper Left to Right**.
- When you have selected **Roll Paper Length > Auto Settings** and **Paper Orientation > Horizontal**, you can choose only **Upper Left to Bottom**.

• Paper Size

You can select the size of the print media.



Note

- You cannot display this if Roll Paper is selected in **Paper Source**.

Zoom Dialog Box

This dialog box appears when you select **Zoom** from the **View** menu. You can enlarge or reduce the screen display.

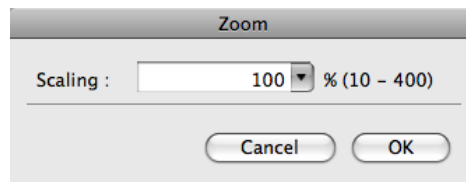

• Scaling

Set the magnification for enlargement or reduction of the screen display.



Note

- You can input between 10 and 400.
- You can change the numbers by clicking ▼ button.

Format Dialog Box

This dialog box appears when you select **Format** from the **Object** menu after you select an object. You can rotate, enlarge, or reduce an object.

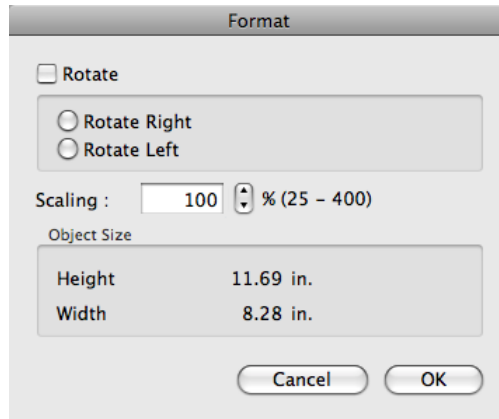

- When the objects are not selected, you can not select **Format**.

• Rotate

When you place a checkmark here, you can select **Rotate Right** or **Rotate Left**.

Setting	Details
Rotate Right	Rotates the object 90 degrees clockwise.
Rotate Left	Rotates the object 90 degrees counterclockwise.



- When several objects are selected, you cannot select **Rotate**.

• Scaling

You can input the value for enlargement or reduction of the object in numerical characters.



- You can input between 25 and 400.
- You can change the numbers by clicking either ▲ button or ▼ button.

• Object Size

You can confirm the object size.



- When several objects are selected, you cannot display **Object Size**.

Laying out a Multiple-File Document on One Page

You can lay out and print a multiple-file document on one page.

1

From the application software's **File** menu, select the printer setup menu to open the **Print** dialog box.



- Normally, select **Print** from the **File** menu.

2

Click on **Free Layout** in the **Page Setup** panel to attach a checkmark.

3

In the **Print** dialog box, select the pages to print and the number of copies, and click the **Print** button. Free Layout starts, laying out the document created with application software in the layout area as an object.

- 4** Leaving Free Layout running, open other files with the application software and repeat the above steps.

Laying out a Document Created with Multiple Application Programs on One Page

You can lay out and print a document created with multiple application programs on one page.

- 1** From the application software's **File** menu, select the printer setup menu to open the **Print** dialog box.



Note

- Normally, select **Print** from the **File** menu.

- 2** Click on **Free Layout** in the **Page Setup** panel to attach a checkmark.

- 3** In the **Print** dialog box, select the pages to print and the number of copies, and click the **Print** button. Free Layout starts, laying out the document created with application software in the layout area as an object.

- 4** Leaving Free Layout running, open the files with other application software and repeat the above steps.

Selecting an Object

When an object is selected, a select box (blue border) appears around the object.

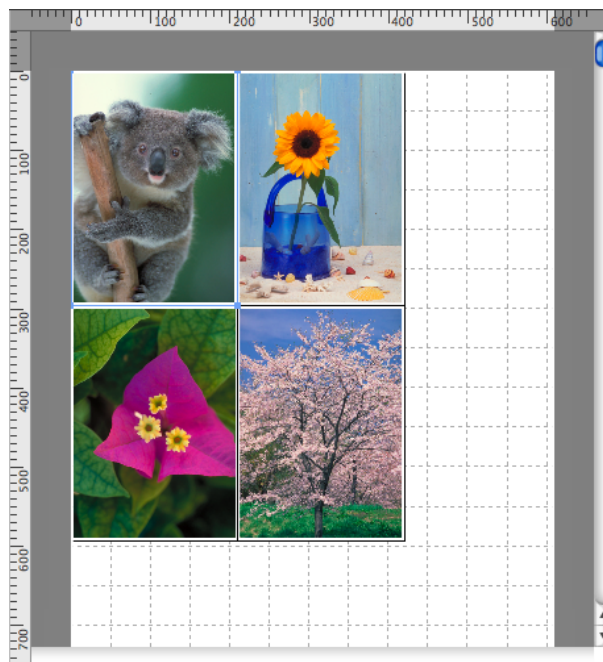

Note

- To select an object, click that object.
- To select multiple successive objects, click them while holding down the shift key.
- To select multiple arbitrary objects, click them while holding down the command key.
- To select all objects, select **Select All** from the **Edit** menu.

Changing the Object Size

You can change the object size by means of mouse operation or by specifying a scaling value.



Note

- The vertical-to-horizontal ratio remains unchanged when the object is enlarged or reduced.

Resizing by means of mouse operation

- 1 Select an object.
- 2 Place the pointer at a corner of the selection box around the object to show the arrow handle, and drag this handle to change the object size.

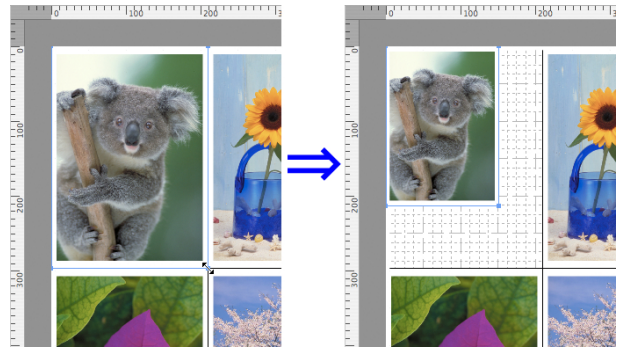

Resizing by specifying a scaling value

- 1 Select an object.
- 2 Open the Format Dialog Box → P.323 .
- 3 Use **Scaling** to set the magnification for enlargement or reduction. You either enter numbers directly.

Note

- You can input between 25 and 400.
- You can change the numbers by clicking either ▲ button or ▼ button.

- 4 Click the **OK** button.

Moving an Object

You can move the object position.

- 1 Select an object.
- 2 Place the pointer inside the selection box of the object to show the crosshair handle, and drag it to move the object.

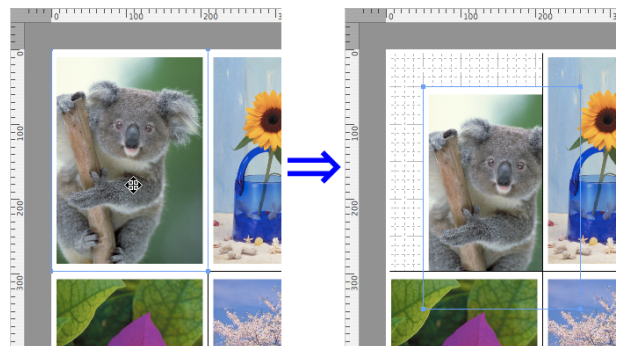

Rotating an Object

You can rotate the object.

- 1 Select an object.

- 2 Select **Rotate Left** or **Rotate Right** from the toolbar. Alternatively, you may click on the **Rotate** check box in the **Format Dialog Box** → P.323 then select **Rotate Right** or **Rotate Left**, and click the **OK** button.

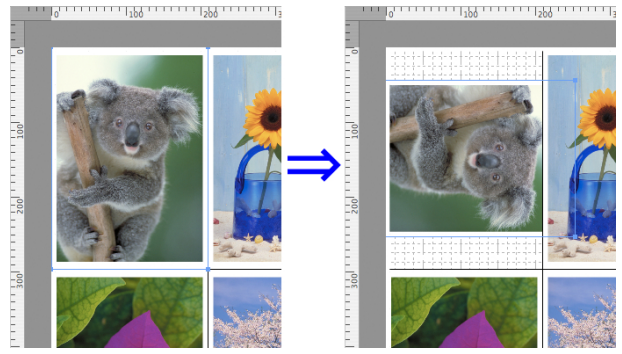

- When several objects are selected, you cannot select **Rotate**.

Note

Laying out Objects Automatically

Click **Auto Arrange** in the tool bar. This automatically lays out objects. Alternatively, you may select **Auto Arrange Object** from the **Object** menu.

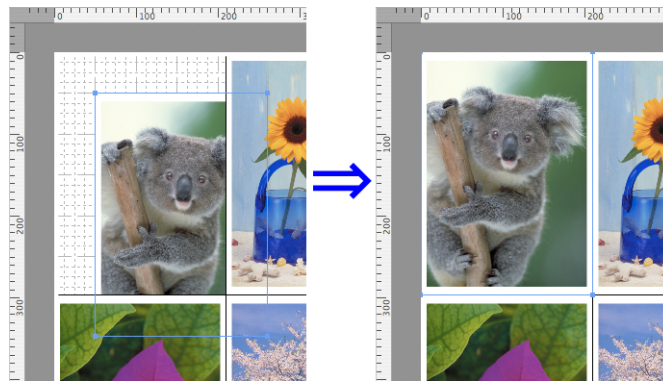

- The object layout order varies depending on the **Order** setting on the **Page Setup Dialog Box** → P.321 .

Note

Aligning Objects

You can align objects systematically.

- 1 Select multiple objects.
- 2 Select the align menu from the **Object** menu.

- **Align Top**

Lays out the objects, justifying them to the top.

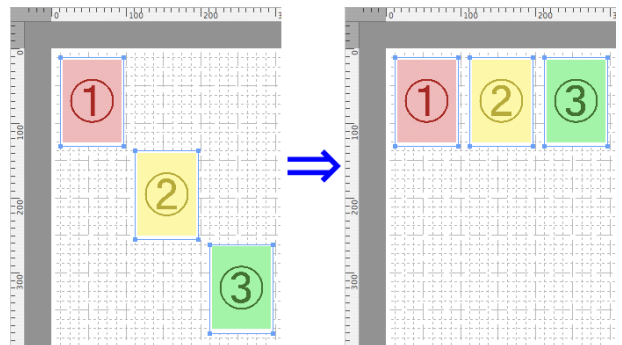

- **Center Vertically**

Lays out the objects, justifying them to the vertical center.

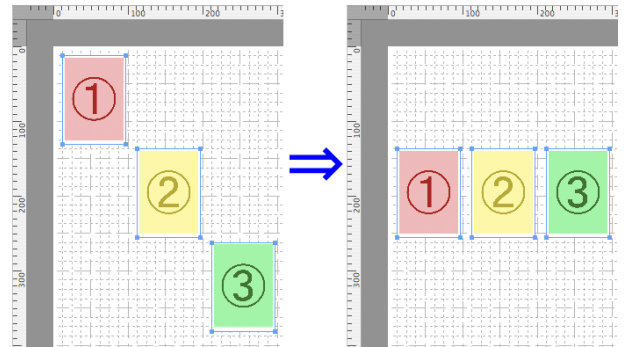

- **Align Bottom**

Lays out the objects, justifying them to the bottom.

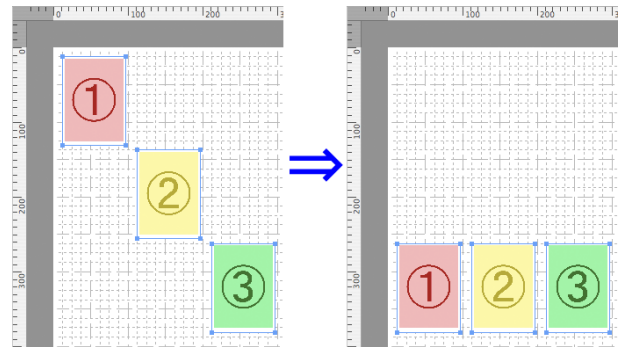

- **Align Left**

Lays out the objects, justifying them to the left.

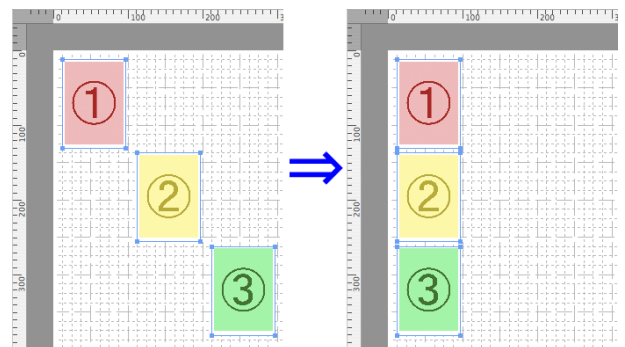

- **Center Horizontally**

Lays out the objects, justifying them to the horizontal center.

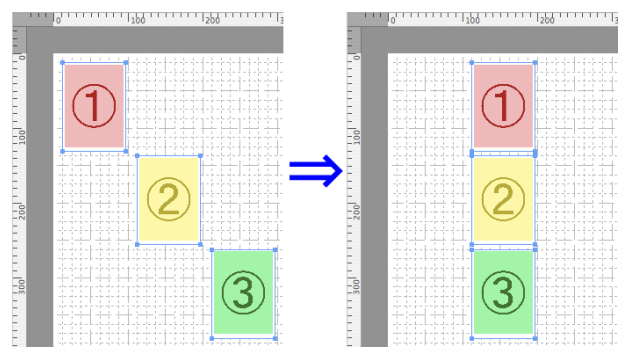

• **Align Right**

Lays out the objects, justifying them to the right.

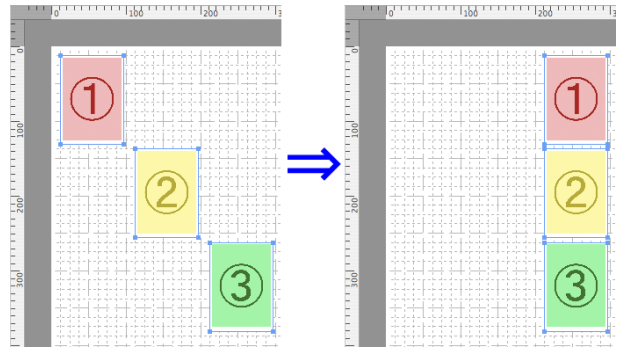

Changing the Object Overlapping Order

You can change the object overlapping order.

- 1 Select an object.
- 2 Select the overlapping order menu from the **Object** menu.

• **Bring to Front**

Moves the object to the frontmost position.

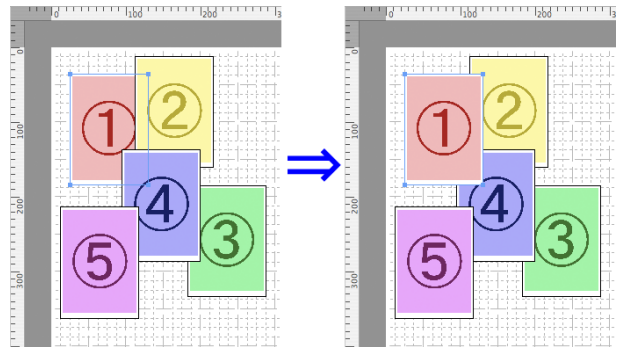

• **Send to Back**

Moves the object to the backmost position.

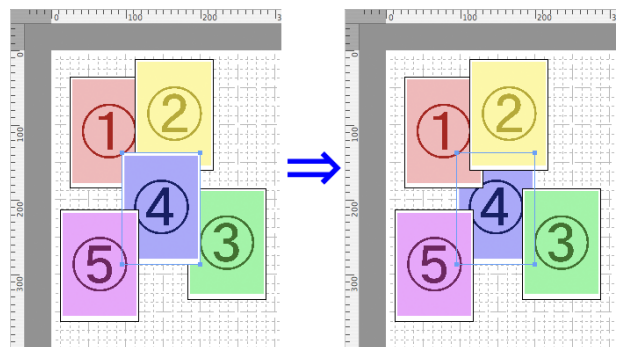

• **Bring Forward**

Moves the object one position to the front.

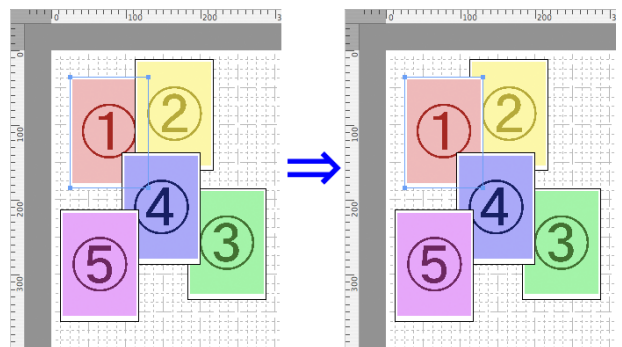

- **Send Backward**

Moves the object one position to the back.

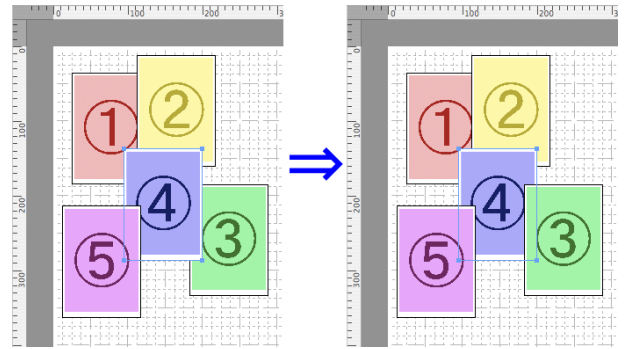

Pasting a Copied or Cut Object

- 1** Click **Copy** or **Cut** from the toolbar.
Alternatively, you may select **Copy** or **Cut** from the **Edit** menu.
- 2** Click **Paste** from the toolbar.
Alternatively, you may select **Paste** from the **Edit** menu.



Note

- The copied or cut object is laid out at the end of the page.

Memo

Basic Printing Workflow	15
Enhanced Printing Options	29
Windows Software	157
Mac OS Software	267

Handling and Use of Paper

Paper	332
Handling rolls	342
Handling sheets	369
Stacker	375
Media Configuration Tool (Windows)	383
Media Configuration Tool (Mac OS)	405

Control Panel	429
Printer Parts	467
Network Setting	481
Print Job Management	501
Adjustments for Better Print Quality	555
Maintenance and Consumables	573
Troubleshooting	617
Error Message	651
Specifications	673
Appendix	677

Paper

Types of Paper	332
Paper Sizes	332
Using Paper Other Than Genuine Paper and feed confirmed Paper	334
Printing on Paper Other Than Genuine Paper and feed confirmed Paper Using Existing Settings	335
Displaying the Paper Reference Guide	335
Updating paper information	338

Types of Paper

The following types of paper are supported by the printer. For details on the paper supported by the printer, refer to the **Paper Reference Guide**. (See "Displaying the Paper Reference Guide.") →P.335

- Plain Paper
- Coated Paper
- Photo Paper
- Glossy Paper
- Proofing Paper
- CAD-dedicated Paper Etc.

The following content is described in the **Paper Reference Guide**.

- Types of paper
- Paper handling
- Paper product specifications
- Use precautions
- Setting of printer driver, control panel etc.

- **Paper Reference Guide** display method

For the procedure for displaying the **Paper Reference Guide**, see "Displaying the Paper Reference Guide." →P.335

- Method of Updating Supported Paper

Paper that is supported by the printer may be newly released on the Canon website.

To use newly released paper, register the latest paper information on the printer with the Media Configuration Tool. (See "Updating paper information.") →P.338



Important

- Even if you are not using the printer driver, you should install the Media Configuration Tool in order to register the media types for your region in the printer.
(See "Media Configuration Tool (Windows).") →P.383
(See "Media Configuration Tool (Mac OS).") →P.405

Paper Sizes

Rolls

Rolls that meet the following conditions are supported.

- Outer diameter: Up to 150 mm (6 in)
- Inner diameter of paper core: 2 or 3 inches
- Printing side out

Roll Width	Roll Paper Width Setting in Printer Driver	Borderless Printing (*1)
1117.6 mm (44.00 in)	44-in. Roll (1117.6mm)	Yes
1066.8 mm (42.00 in)	42-in. Roll (1066.8mm)	Yes
1030.0 mm (40.55 in)	JIS B0/B1 Roll (1030.0mm)	Yes
914.4 mm (36.00 in)	36-in. Roll (914.4mm)	Yes

Roll Width	Roll Paper Width Setting in Printer Driver	Borderless Printing (*1)
841.0 mm (33.11 in)	ISO A0/A1 Roll (841.0mm)	Yes
762.0 mm (30.00 in)	30-in. Roll (762.0mm)	No
728.0 mm (28.66 in)	JIS B1/B2 Roll (728.0mm)	No
609.6 mm (24.00 in)	24-in. Roll (609.6mm)	Yes
594.0 mm (23.39 in)	ISO A1/A2 Roll (594.0mm)	Yes
515.0 mm (20.28 in)	JIS B2/B3 Roll (515.0mm)	Yes
431.8 mm (17.00 in)	17-in. Roll (431.8mm)	Yes
420.0 mm (16.54 in)	ISO A2/A3 Roll (420.0mm)	No
406.4 mm (16.00 in)	16-in. Roll (406.4mm)	No
355.6 mm (14.00 in)	14-in. Roll (355.6mm)	Yes
297.0 mm (11.69 in)	ISO A3/A4 Roll (297.0mm)	No
254.0 mm (10.00 in)	10-in. Roll (254.0mm)	Yes

*1: For information on types of paper compatible with borderless printing, refer to the **Paper Reference Guide**. (See "Types of Paper.") → P.332

Sheets

Sheets of the following sizes are supported.

Paper Sizes	Dimensions
ISO A0	841.0 × 1189.0 mm (33.11 × 46.81 in)
ISO A1	594.0 × 841.0 mm (23.39 × 33.11 in)
ISO A2	420.0 × 594.0 mm (16.54 × 23.39 in)
ISO A2+	431.8 × 609.6 mm (17.00 × 24.00 in)
ISO A3	297.0 × 420.0 mm (11.69 × 16.54 in)
ISO A3+	329.0 × 483.0 mm (12.95 × 19.02 in)
ISO A4	210.0 × 297.0 mm (8.27 × 11.69 in)
ISO B0	1000.0 × 1414.0 mm (39.37 × 55.67 in)
ISO B1	707.0 × 1000.0 mm (27.83 × 39.37 in)
ISO B2	500.0 × 707.0 mm (19.69 × 27.83 in)
ISO B3	353.0 × 500.0 mm (13.90 × 19.69 in)
ISO B4	250.0 × 353.0 mm (9.84 × 13.90 in)
JIS B0	1030.0 × 1456.0 mm (40.55 × 57.32 in)
JIS B1	728.0 × 1030.0 mm (28.66 × 40.55 in)
JIS B2	515.0 × 728.0 mm (20.28 × 28.66 in)
JIS B3	364.0 × 515.0 mm (14.33 × 20.28 in)
JIS B4	257.0 × 364.0 mm (10.12 × 14.33 in)
34"x44"(ANSI E)	863.6 × 1117.6 mm (34.00 × 44.00 in)
28"x40"(ANSI F)	711.2 × 1016.0 mm (28.00 × 40.00 in)
22"x34"(ANSI D)	558.8 × 863.6 mm (22.00 × 34.00 in)
17"x22"(ANSI C)	431.8 × 558.8 mm (17.00 × 22.00 in)
11"x17"(Ledger)	279.4 × 431.8 mm (11.00 × 17.00 in)
13"x19"(Super B)	330.2 × 482.6 mm (13.00 × 19.00 in)
Letter(8.5"x11")	215.9 × 279.4 mm (8.50 × 11.00 in)
Legal(8.5"x14")	215.9 × 355.6 mm (8.50 × 14.00 in)
36"x48"(ARCH E)	914.4 × 1219.2 mm (36.00 × 48.00 in)
30"x42"(ARCH E1)	762.0 × 1066.8 mm (30.00 × 42.00 in)
26"x38"(ARCH E2)	660.4 × 965.2 mm (26.00 × 38.00 in)

Paper Sizes	Dimensions
27"x39"(ARCH E3)	685.8 × 990.6 mm (27.00 × 39.00 in)
24"x36"(ARCH D)	609.6 × 914.4 mm (24.00 × 36.00 in)
18"x24"(ARCH C)	457.2 × 609.6 mm (18.00 × 24.00 in)
12"x18"(ARCH B)	304.8 × 457.2 mm (12.00 × 18.00 in)
9"x12"(ARCH A)	228.6 × 304.8 mm (9.00 × 12.00 in)
DIN C0	917.0 × 1296.0 mm (36.10 × 51.02 in)
DIN C1	648.0 × 917.0 mm (25.51 × 36.10 in)
DIN C2	458.0 × 648.0 mm (18.03 × 25.51 in)
DIN C3	324.0 × 458.0 mm (12.76 × 18.03 in)
DIN C4	229.0 × 324.0 mm (9.02 × 12.76 in)
20"x24"	508.0 × 609.6 mm (20.00 × 24.00 in)
18"x22"	457.2 × 558.8 mm (18.00 × 22.00 in)
14"x17"	355.6 × 431.8 mm (14.00 × 17.00 in)
12"x16"	304.8 × 406.4 mm (12.00 × 16.00 in)
10"x12"	254.0 × 304.8 mm (10.00 × 12.00 in)
10"x15"	254.0 × 381.0 mm (10.00 × 15.00 in)
8"x10"	203.2 × 254.0 mm (8.00 × 10.00 in)
US Photo 16"x20"	406.4 × 508.0 mm (16.00 × 20.00 in)
Poster 20"x30"	508.0 × 762.0 mm (20.00 × 30.00 in)
Poster 30"x40"	762.0 × 1016.0 mm (30.00 × 40.00 in)
Poster 42"x60"	1066.8 × 1524.0 mm (42.00 × 60.00 in)
Poster 44"x62"	1117.6 × 1574.8 mm (44.00 × 62.00 in)
13"x22"	329.0 × 558.0 mm (12.95 × 21.97 in)
Poster 300x900mm	300.0 × 900.0 mm (11.81 × 35.43 in)
Custom Paper Size	203.2 × 203.2 mm (8.00 × 8.00 in) to 1118.0 × 1600.0 mm (44.02 × 62.99 in)



Note

- For details on non-standard paper sizes, see "Printing on Non-Standard Paper Sizes." → P.108
- Borderless printing is not supported on sheets.

Using Paper Other Than Genuine Paper and feed confirmed Paper

When using this printer to print on paper other than genuine Canon paper and feed confirmed paper, use paper that meets the following conditions.



Note

- Refer to **Paper Reference Guide** for details on genuine Canon paper and feed confirmed paper. (See "Displaying the Paper Reference Guide.") → P.335

- Paper where the size is described in "Paper Sizes" (See "Paper Sizes.") → P.332
- Paper where the thickness is described in "Paper Thickness" in "Specifications" (See "Specifications.") → P.674
- Paper where bleeding and ink overflow does not occur when printing
- Paper that does not warp severely when loading the paper or printing



Important

- If you use paper other than genuine Canon paper and feed confirmed paper, Canon provides absolutely no guarantees regarding print quality or paper feed properties. Refer to **Paper Reference Guide** for details on genuine Canon paper and feed confirmed paper. (See "Displaying the Paper Reference Guide.") → P.335

Load paper in the printer and then select the paper type in the control panel and printer driver and print. You can print easily by selecting from existing settings provided in the printer control panel and printer driver. (See "Printing on Paper Other Than Genuine Paper and feed confirmed Paper Using Existing Settings.") → P.335

Printing on Paper Other Than Genuine Paper and feed confirmed Paper Using Existing Settings

You can easily print on paper other than genuine Canon paper and feed confirmed paper without making complicated settings by selecting existing settings provided in the printer control panel and printer driver depending on the media type you are using. The existing settings consist of general-purpose paper settings provided for each media type and special settings that allow you to select the amount of ink to use.



- The genuine Canon paper settings provided in the printer control panel and printer driver are optimized for genuine Canon paper. If these settings are selected for printing on paper other than genuine Canon paper, the ink may bleed or the printhead may rub against the paper. In order to easily print on paper other than genuine Canon paper and feed confirmed paper, we recommend that you select one of the following general-purpose paper settings or special settings.



- For an overview of the media types, see "Types of Paper." →P.332
- For details on how to select the media type in the control panel and printer driver, see "Types of Paper." →P.332

Choosing General-Purpose Paper Settings

Since these settings anticipate a wide variety of paper other than genuine Canon paper and feed confirmed paper, these settings will make it difficult for bleeding ink and the printhead rubbing to occur. Refer to the following table for the relationships between the conditions of the paper other than genuine Canon paper and feed confirmed paper and the media type to select.

Type	Approximate weight	Approximate thickness	Printer control panel	Printer driver
Plain Paper	70 g/m ²	0.09 mm (0.0035 in.)	Plain Paper	Plain Paper
Coated Paper	90 g/m ²	0.13 mm (0.0051 in.)	LW. Coated Paper	Lightweight Coated Paper
	170 g/m ²	0.22 mm (0.0087 in.)	HW. Coated Paper	Heavyweight Coated Paper
Photo Paper	180 g/m ²	0.18 mm (0.0071 in.)	LW. Photo Paper	Lightweight Photo Paper
			LWPhotoPaper(LI)(*1)	Lightweight Photo Paper (LowInk)(*1)
	260 g/m ²	0.26 mm (0.010 in.)	HW. Photo Paper	Heavyweight Photo Paper
			HWPhotoPaper(LI)(*1)	Heavyweight Photo Paper (LowInk)(*1)
Proof	80 g/m ²	0.10 mm (0.0039 in.)	News Proof	(*2)
Sign/CAD Paper	150 g/m ²	0.11 mm (0.0043 in.)	CAD Clear Film	CAD Clear Film
	90 g/m ²	0.08mm (0.0031 in.)	CAD Trce(LowInk)	CAD Tracing Paper (Low Ink)
	100 g/m ²	0.13 mm (0.0051 in.)	Syn.Papr(LowInk)	Synthetic Paper (LowInk)

*1: Print using slightly less ink. Try this if you are concerned about rubbing of ink after printing.

*2: Software RIP is required separately.

Selecting Special Settings

Special settings are provided that allow you to select the amount of ink used in steps. You can fix lackluster colors or bleeding ink by selecting special settings where the amount of ink used is suitable for the paper you are using. "Special 1" uses the least amount of ink, with the amount of ink used increasing through 5 steps as the number increases up to "Special 5" which uses the greatest amount of ink. Although colors become more vivid as the amount of ink used increases, bleeding also occurs more easily. We recommend that you try in order starting from "Special 1" while checking the state of the printing.

Displaying the Paper Reference Guide

The **Paper Reference Guide** are not included. To view, display the **Paper Reference Guide** on the website from the links in the installed software. An Internet connection is required in order to view them.

- Windows

The basic instructions for displaying the **Paper Reference Guide** from the printer driver are as follows.

1. Open the printer driver.
(See "Accessing the Printer Driver Dialog Box from Applications (Windows).") →P.164

(See "Accessing the Printer Driver Dialog Box from the Operating System Menu (Windows).") →P.165

- 2. Select the **Support** sheet and click the **User Manual** button.

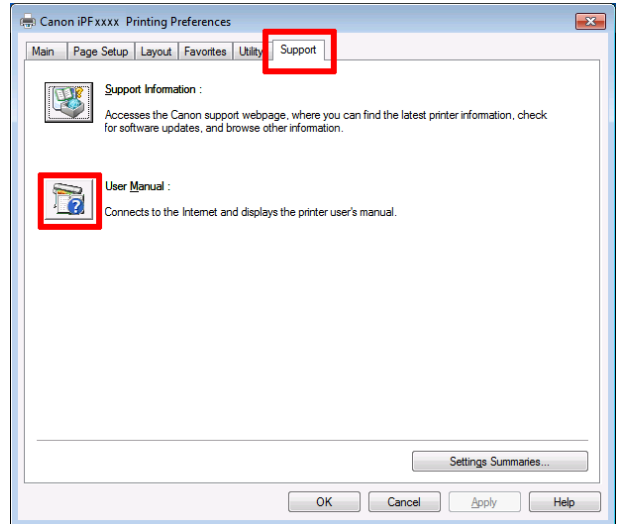

- 3. Click **Paper Reference Guide**.

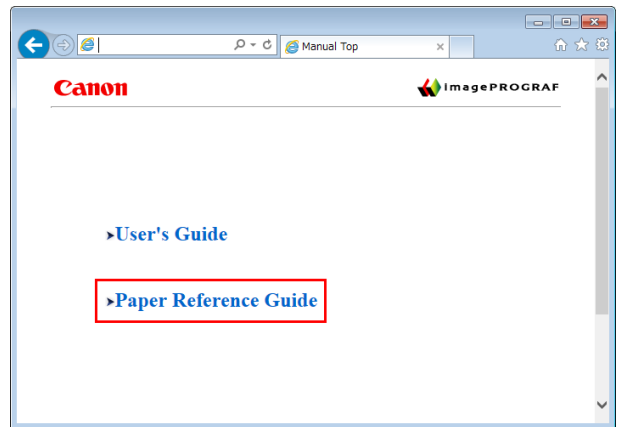

- Mac OS

The basic instructions for displaying the **Paper Reference Guide** from the imagePROGRAF Printmonitor are as follows.

- 1. Click the **System Preferences** icon in the **Dock**.



- 2. Click **Print & Scan**. (This is identified as **Printers & Scanners** or **Print & Fax** in other versions of Mac OS X.)

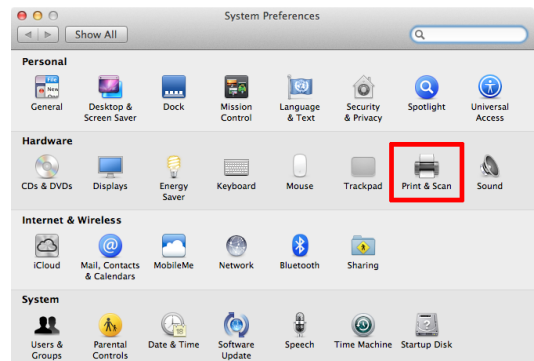

3. Select the printer from the list of printers and click **Options & Supplies**.

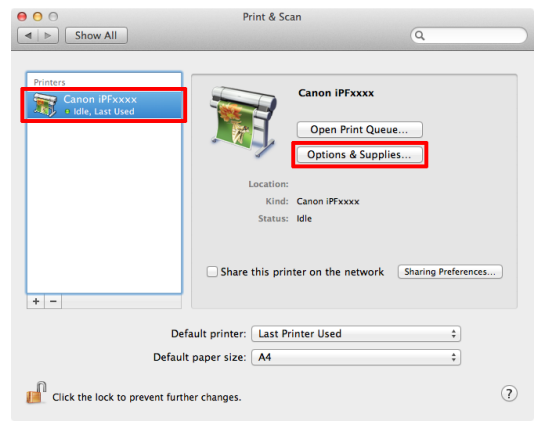

4. Click **Utility**.

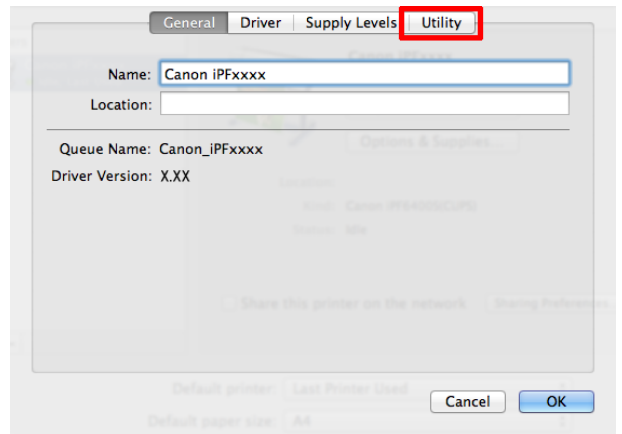

5. Click **Open Printer Utility**.

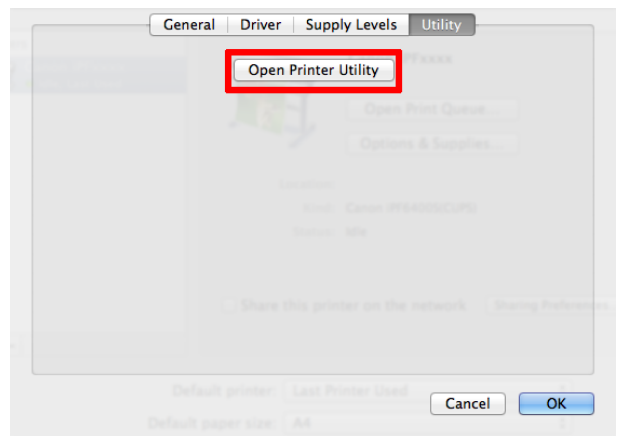

6. Click **Support**.

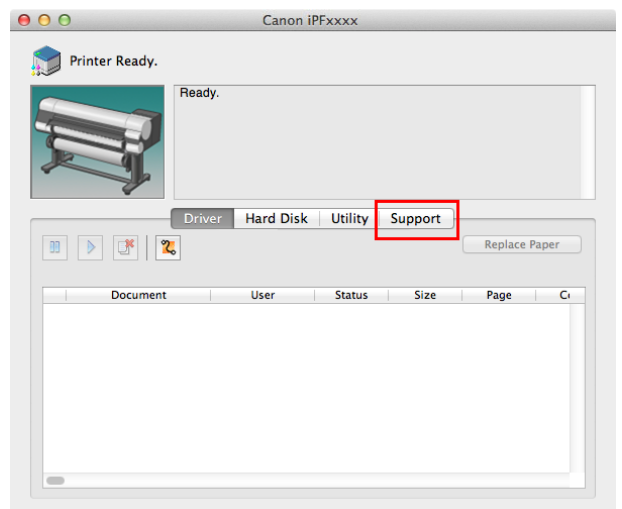

7. Click the **User Manual** button.

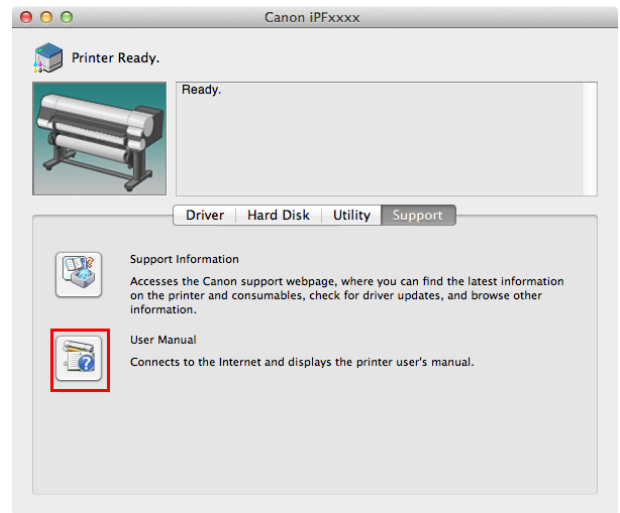

8. Click **Paper Reference Guide**.

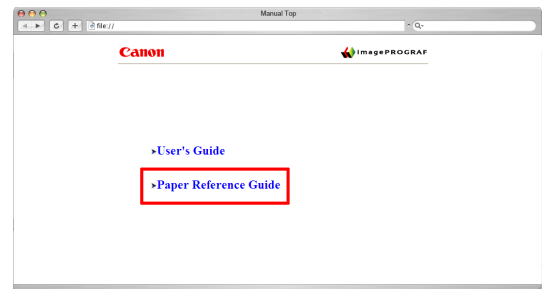

Updating paper information

You can update the media information in the printer Control Panel and printer driver with the latest information by applying the latest version of the **Media Information File**.

For details on the procedure for applying the **Media Information File**, refer to the following.

- **Media Configuration Tool (Windows)** →P.383
- **Media Configuration Tool (Mac OS)** →P.405



• **New Media Information Files** are released on the Canon website. A computer that is able to connect to the Internet is required in order to download the **Media Information File**.

If you are using the Media Configuration Tool, the **Media Information File** is downloaded automatically. To download it manually, access the Canon website. The Canon website can be accessed from the link in the installed software.

Windows

The basic instructions for accessing the Canon website from the printer driver are as follows.

1. Open the printer driver.
 (See "Accessing the Printer Driver Dialog Box from Applications (Windows).") →P.164
 (See "Accessing the Printer Driver Dialog Box from the Operating System Menu (Windows).") →P.165

2. Select the **Support** sheet and click the **Support Information** button.

The default browser on your computer is started and the Canon website is displayed.

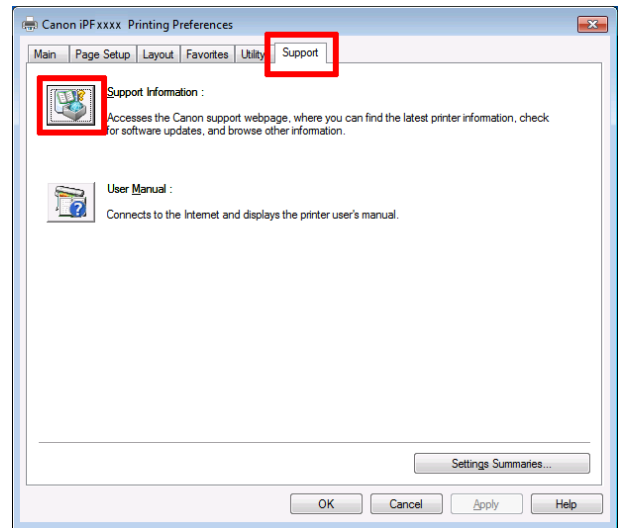

- Mac OS

The basic instructions for accessing the Canon website from imagePROGRAF Printmonitor are as follows.

1. Click the **System Preferences** icon in the **Dock**.



2. Click **Print & Scan**. (This is identified as **Printers & Scanners** or **Print & Fax** in other versions of Mac OS X.)

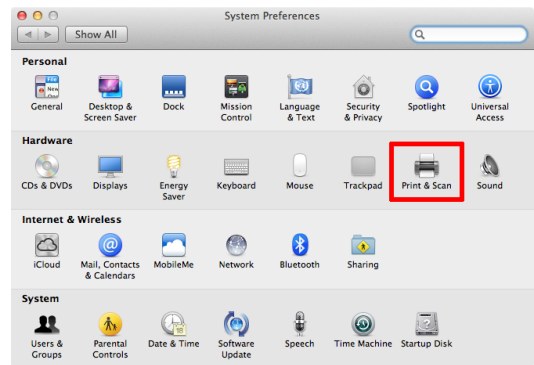

3. Select the printer from the list of printers and click **Options & Supplies**.

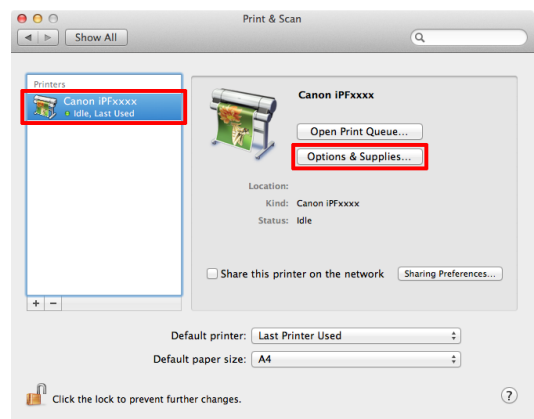

4. Click **Utility**.

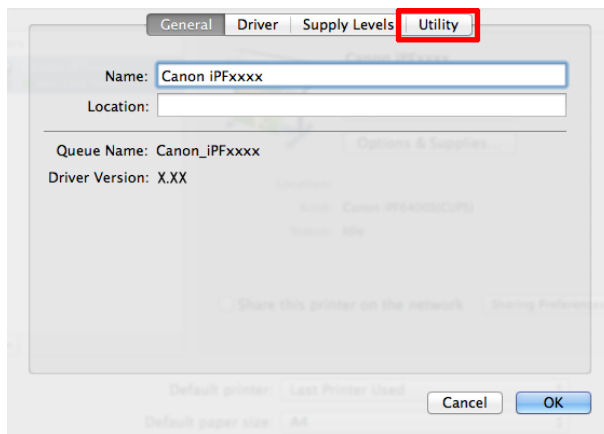

5. Click **Open Printer Utility**.

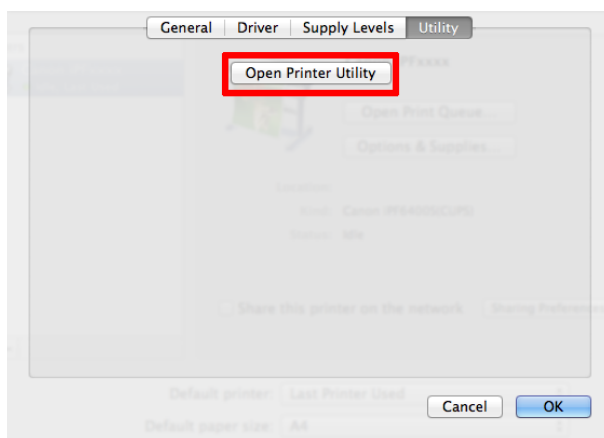

6. Click **Support**.

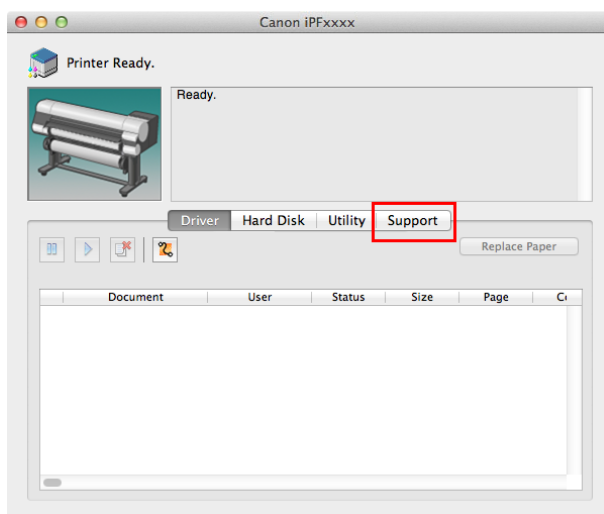

7. Click the **Support Information** button.

The default browser on your computer is started and the Canon website is displayed.

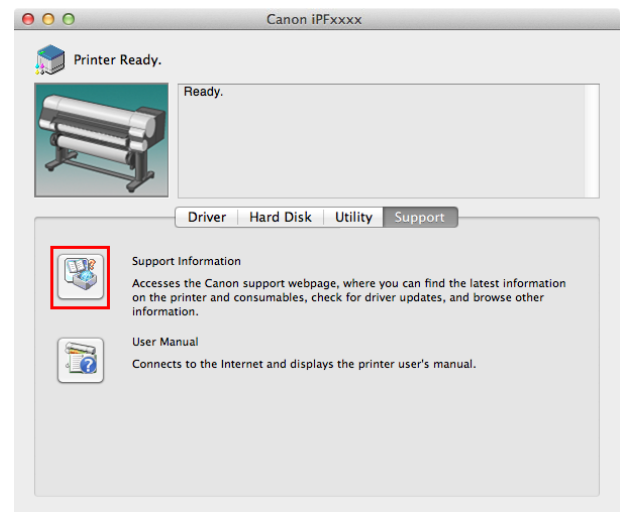

Handling rolls

Attaching the Roll Holder to Rolls	342
Loading Rolls in the Printer	345
Changing the Type of Paper	350
Specifying the Paper Length	352
Removing the Roll from the Printer	352
Removing the Roll Holder from Rolls	356
➔ Clearing Jammed Roll Paper	619
Feeding Roll Paper Manually	357
Keeping Track of the Amount of Roll Paper Left	358
Specifying the Ink Drying Time for Rolls	358
Specifying the Cutting Method for Rolls	360
Cutting the Leading Edge of Roll Paper Automatically	366
Reducing Dust from Cutting Rolls	367
Roll Holder Set	368
Automatic Roll Switching	368

Attaching the Roll Holder to Rolls

When printing on rolls, attach the Roll Holder to the roll.

Rolls have a two- or three-inch paper core. Use the correct attachment for the paper core. The printer comes equipped with the 2-Inch Paper Core Attachment installed.

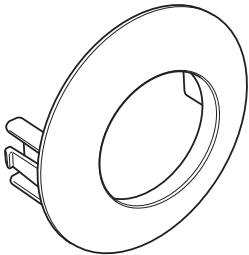
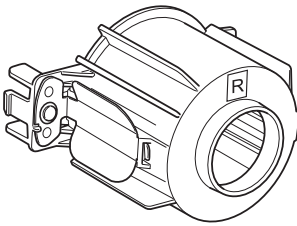
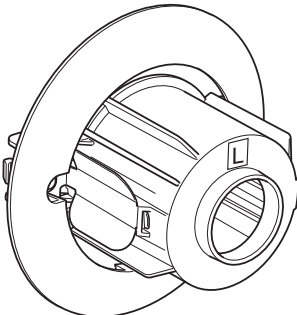
Using the 2-Inch Paper Core Attachment		Using the 3-Inch Paper Core Attachment	
Roll Holder Side	Holder Stopper Side	Roll Holder Side	Holder Stopper Side
No Attachment Needed	2-Inch Paper Core Attachment	3-Inch Paper Core Attachment #1	3-Inch Paper Core Attachment #2
			



- Set the roll on a table or other flat surface so that it does not roll or fall. Rolls are heavy, and dropping a roll may cause injury.



- When handling the roll, be careful not to soil the printing surface. This may affect the printing quality. We recommend wearing clean cloth gloves when handling rolls to protect the printing surface.
- Cut the edge of the roll paper if it is uneven, dirty, or has tape residue. Otherwise, it may cause feeding problems and affect the printing quality. Be careful not to cut through any barcodes printed on the roll.

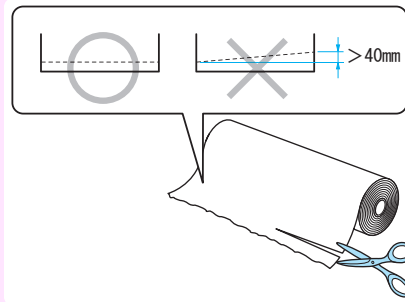

- Align the edges of the paper on both ends of the roll. This may cause feeding problems.

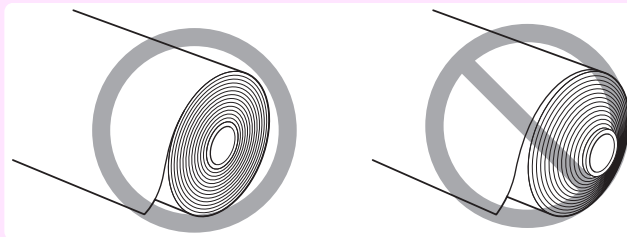

- For details on supported sizes and types of roll paper, see **Paper Sizes** or the **Paper Reference Guide**. (See "Paper Sizes." →P.332 (See "Displaying the Paper Reference Guide." →P.335
- To view instructions as you attach the Roll Holder, press the **Navigate** button. (See "How to View Instructions With Navigate." →P.436)

1 Lift the Holder Stopper lever (a) from the shaft side to unlock it. Holding the Holder Stopper at the position indicated (b), remove it from the Roll Holder.

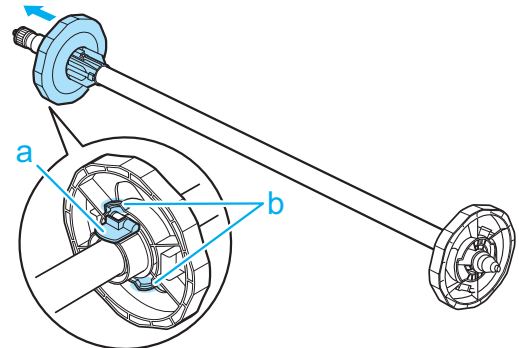

2 When using a 3-inch paper core, align the tips (a) of 3-Inch Paper Core Attachment #1 with the holes (b) of the Roll Holder and insert it firmly.

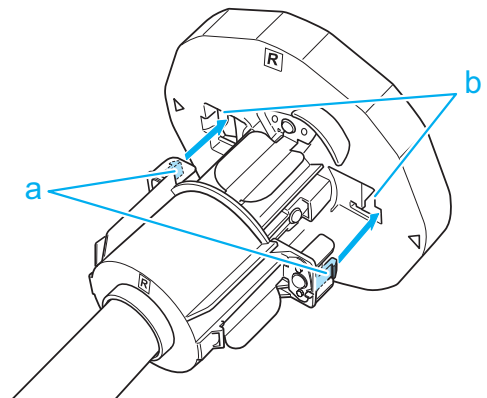

- 3** With the edge of the roll paper facing forward as shown, insert the Roll Holder from the right of the roll. Insert it firmly until the roll touches the flange (a) of the Roll Holder.

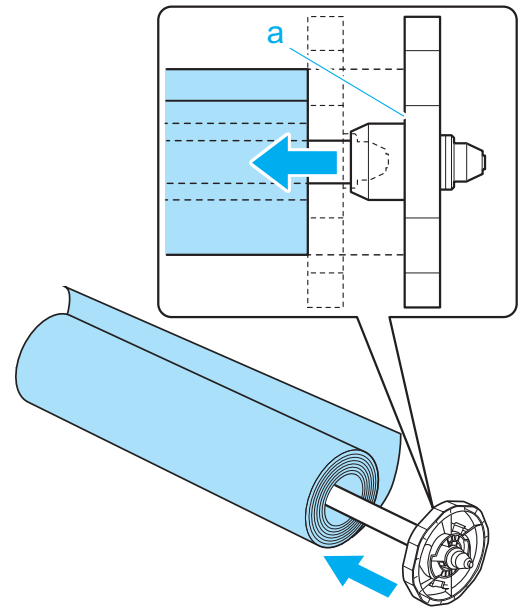

- When loading a roll, be careful to avoid hitting the printer hard with the roll. This may damage the Roll Holder.

- 4** Insert the attachments for the roll paper core on the Holder Stopper. Align the tips (a) of the attachment with the holes (b) of the Holder Stopper and insert it firmly.

- 3-Inch Paper Core Attachment #2

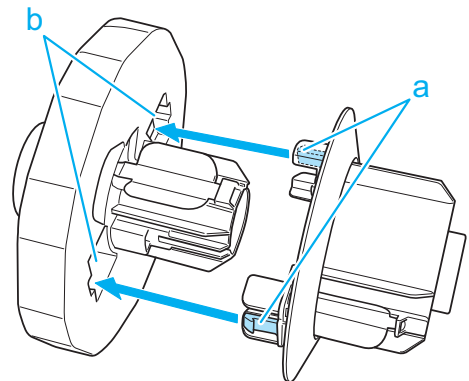

- 2-Inch Paper Core Attachment

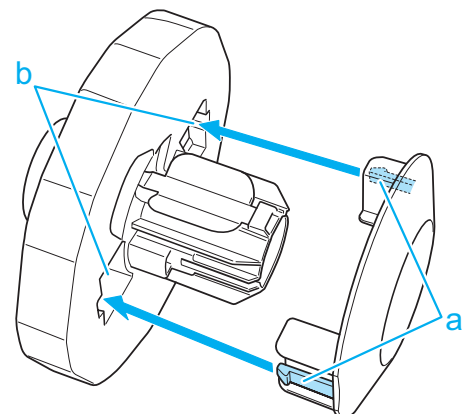

5 Insert the Holder Stopper from the left in the Roll Holder as shown. Holding it at the position shown (b), push it firmly in until the flange (a) of the Holder Stopper touches the roll. Lock the Holder Stopper lever (c) by pushing it down toward the shaft side.

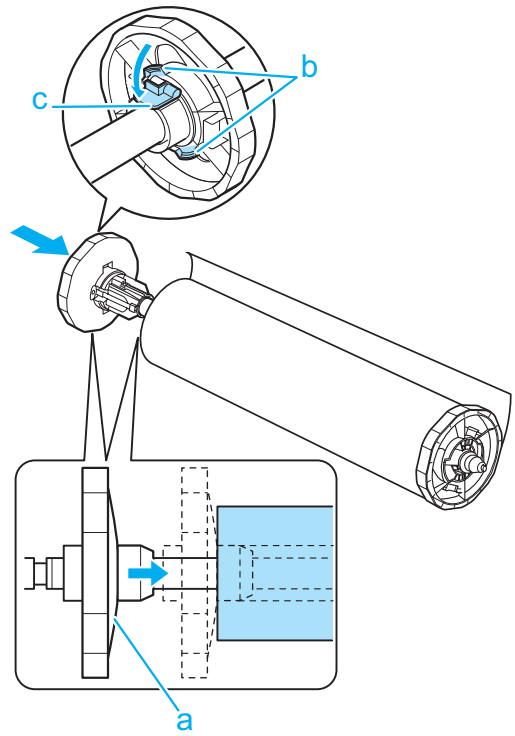

Loading Rolls in the Printer

Follow these steps to load rolls in the printer.

You can load rolls in two positions, in the Roll 1 (Upper) and Roll 2 (Lower) holders.

If the Stacker is installed on the printer, first remove the Stacker from the printer. (See "Installing and Removing the Stacker On the Printer.") →P.376



Important

- Always load rolls when the printer is on. If the printer is off when you load a roll, the paper may not be advanced correctly when you turn the printer on.
- Before loading a roll, confirm whether the inside of the Top Cover or the Ejection Guide is soiled. If soiled, we recommend cleaning in advance. (See "Cleaning Inside the Top Cover.") →P.599

Loading rolls in the Roll 1 (Upper) holder

1 Press the **Load** button.

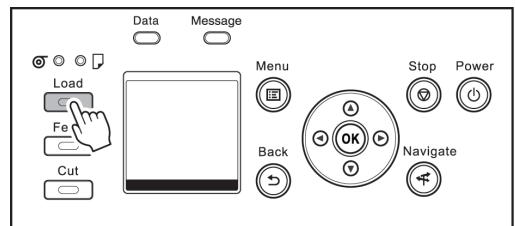

2 Press **▲** or **▼** to select **Roll 1 (Upper)**, and then press the **OK** button.



Note

- If any cut sheet has been fed, or roll paper that will not be used has been fed from Roll 1 (Upper), a message is shown requesting you to remove it. Press **▲** or **▼** to select **Yes**, and then press the **OK** button. Remove the paper and go to the next step.
- If roll paper is loaded in Roll 1 (Upper) but Roll 1 (Upper) is not selected as the paper source, a message asking you whether or not to change paper is displayed. Press **▲** or **▼** to select **Load**, and then press the **OK** button. Remove the paper and proceed to the next step.

3 Open the Top Cover and lift the Ejection Guide.

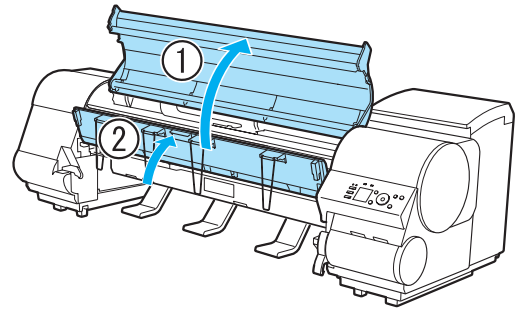

4 Holding the Roll Holder so that the side with the white gear faces the side of the Roll Holder Slot with a white gear, load the Roll Holder shaft (a) into the grooves (b) on both ends of the Roll Holder Slot.

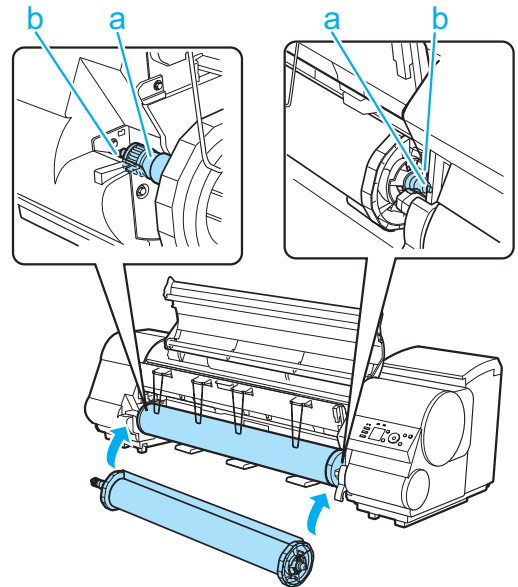

- Be careful not to drop the roll and hurt yourself when loading it.
- Caution** • Be careful not to pinch your fingers between the Roll Holder shaft (a) and the guide grooves (b) when loading rolls.



Note

- For instructions on attaching the Roll Holder to rolls, see "Attaching the Roll Holder to Rolls." → P.342

5 Using both hands, pull out the roll evenly on both ends and insert it in the Paper Feed Slot (a). Advance the roll until the buzzer sounds.

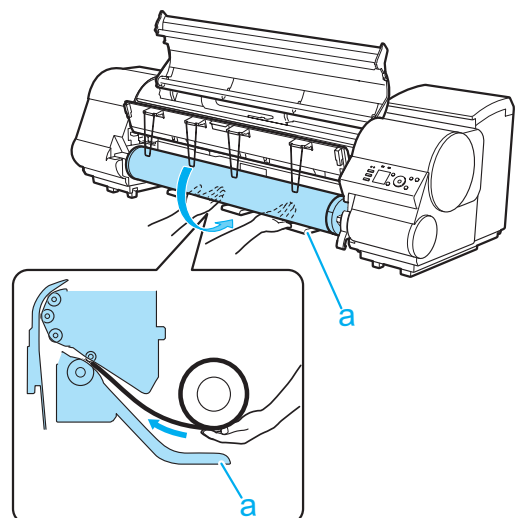



- Be careful not to soil the printing surface of roll paper as you insert it in the slot. This may affect the printing quality. We recommend wearing clean cloth gloves when handling rolls to protect the printing surface.
- If the paper is wrinkled or warped, straighten it out before loading it.
- Load the roll so that there is no gap between the right edge of the paper and the Roll Holder.

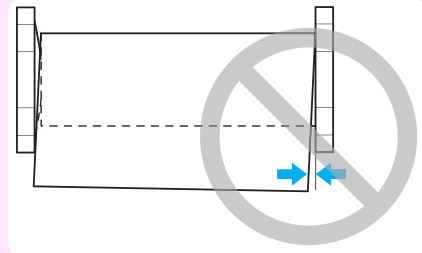

6 Lower the Ejection Guide.

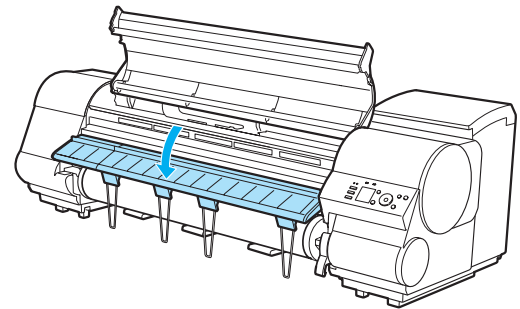

- When lowering the Ejection Guide, lower it slowly. If the Ejection guide is lowered forcefully, the Ejection Supports (a) may hit the roll and scratch the printing surface.

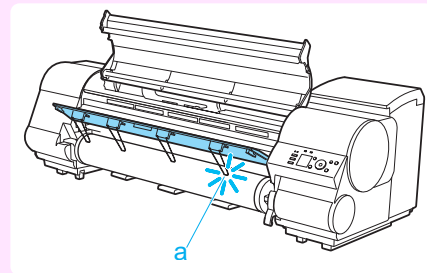

7 Close the Top Cover.

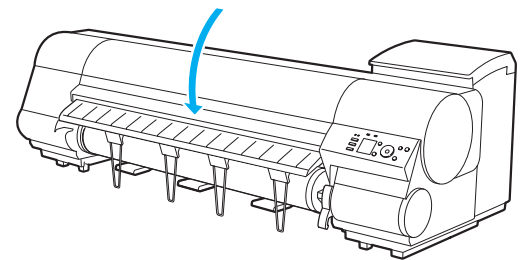

8 Press the **OK** button.
The paper is now advanced.

9 Once paper feeding starts, you will need to do the following, based on the **ManageRemainRoll** setting and the barcode printed on rolls. (See "Keeping Track of the Amount of Roll Paper Left.") →P.358

ManageRemainRoll	Barcodes	Printer Operation After the Paper is Fed
Off	Printed	A menu for selection of the type of paper is shown on the Display Screen. Press ▲ or ▼ to select the type of paper, and then press the OK button.
	Not printed	
On	Printed	The type and amount of paper left is automatically detected based on the barcode printed on the roll. There is no need to specify the type and length of the paper.

ManageR- emainRoll	Barcodes	Printer Operation After the Paper is Fed
On	Not printed	A menu for selection of the type and length of paper is shown on the Display Screen. Press ▲ or ▼ to select the type and length of paper loaded, and then press the OK button.



- Cut the edge of the roll using the **Paper Cutting** function if the edge is creased or soiled. (See "Specifying the Cutting Method for Rolls.") →P.360



- For details on types of paper to select, see the **Paper Reference Guide**. (See "Displaying the Paper Reference Guide.") →P.335
- Adjusting the printhead alignment with the type of paper to be used in printing may enhance printing quality. (See "Automatic Adjustment to Straighten Lines and Colors.") →P.556

Loading rolls in the Roll 2 (Lower) holder



Caution

- Do not detach the Roll Unit in the following cases.
 - During printing
Vibration from removing the Roll Unit may affect the printing quality.
 - If a sheet is loaded in the printer
The sheet may be ejected, and (rarely) it may be bent.

1 Press the **Load** button.

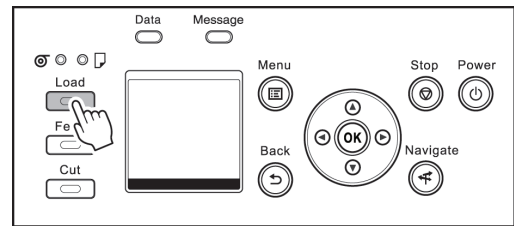

2 Press ▲ or ▼ to select **Roll 2 (Lower)**, and then press the **OK** button.



- If any cut sheet has been fed, or roll paper that will not be used has been fed from Roll 2 (Lower), a message is shown requesting you to remove it. Press ▲ or ▼ to select **Yes**, and then press the **OK** button. Remove the paper and go to the next step.
- If roll paper is loaded in Roll 2 (Lower) but Roll 2 (Lower) is not selected as the paper source, a message asking you whether or not to change paper is displayed. Press ▲ or ▼ to select **Load**, and then press the **OK** button. Remove the paper and proceed to the next step.

3 Holding the Roll Unit Lever (a), pull out the Roll Unit.

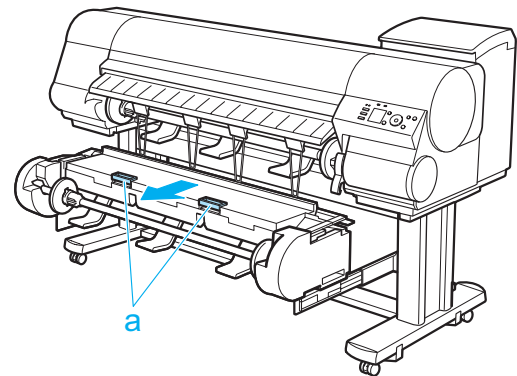

Handling and Use of Paper
Handling rolls

4 Holding the Roll Holder so that the side with the white gear faces the side of the Roll Holder Slot with a white gear, load the Roll Holder shaft (a) into the grooves (b) on both ends of the Roll Holder Slot.

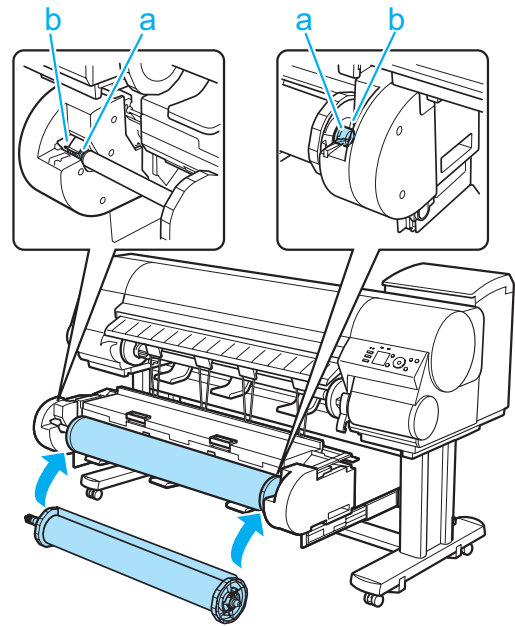

Caution

- Be careful not to drop the roll and hurt yourself when loading it.
- Be careful not to pinch your fingers between the Roll Holder shaft (a) and the guide grooves (b) when loading rolls.

Note

- For instructions on attaching the Roll Holder to rolls, see "Attaching the Roll Holder to Rolls." → P.342

5 Pull out the roll evenly on both ends and insert it in the Paper Feed Slot (a). Advance the roll until the buzzer sounds.

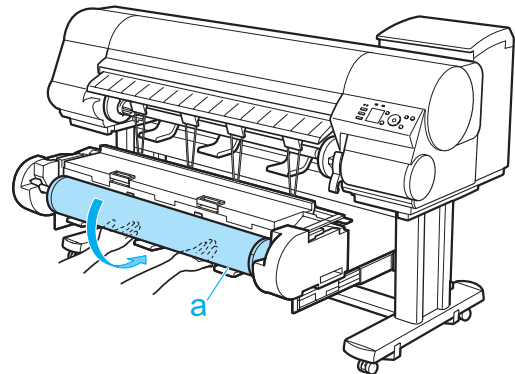

Important

- Be careful not to soil the printing surface of roll paper as you insert it in the slot. This may affect the printing quality. We recommend wearing clean cloth gloves when handling rolls to protect the printing surface.
- If the paper is wrinkled or warped, straighten it out before loading it.
- Load the roll so that there is no gap between the right edge of the paper and the Roll Holder.

6 In a crouching position, push the Roll Unit into the printer.

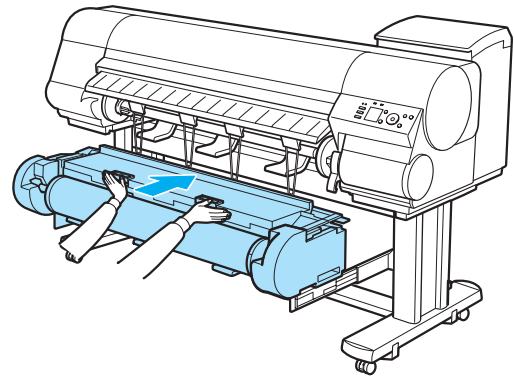

7 Press the **OK** button.
The paper is now advanced.

8 Once paper feeding starts, you will need to do the following, based on the **ManageRemainRoll** setting and the barcode printed on rolls. (See "Keeping Track of the Amount of Roll Paper Left.") →P.358

ManageRemainRoll	Barcodes	Printer Operation After the Paper is Fed
Off	Printed	A menu for selection of the type of paper is shown on the Display Screen. Press ▲ or ▼ to select the type of paper, and then press the OK button.
	Not printed	
On	Printed	The type and amount of paper left is automatically detected based on the barcode printed on the roll. There is no need to specify the type and length of the paper.
	Not printed	A menu for selection of the type and length of paper is shown on the Display Screen. Press ▲ or ▼ to select the type and length of paper loaded, and then press the OK button.



- Cut the edge of the roll using the **Paper Cutting** function if the edge is creased or soiled. (See "Specifying the Cutting Method for Rolls.") →P.360



- For details on types of paper to select, see the **Paper Reference Guide**. (See "Displaying the Paper Reference Guide.") →P.335
- Adjusting the printhead alignment with the type of paper to be used in printing may enhance printing quality. (See "Automatic Adjustment to Straighten Lines and Colors.") →P.556

Changing the Type of Paper

Follow these steps to change the type of paper specified on the printer after you have loaded paper. If you will continue using this type of paper later, selecting **Keep Paper Type > On** will save the time and effort of configuring the media type setting when you load the paper again. The current media type settings before you select **On** will be automatically selected at that time. (See "Using the Same Type of Paper Regularly.") →P.351



- For best printing results, the printer fine-tunes the print head height and the feed amount for each type of paper. Be sure to select the type of paper to use correctly before printing.
- Because the printer fine-tunes the feed amount for each type of paper, the margins and the size of printed images may vary depending on the type of paper used. If margins and the size of images are not as you expected, adjust the paper feed amount. (See "Adjusting the Feed Amount.") →P.564
- Rolls and sheets have different printing areas, and sheets having a larger bottom margin than rolls. (See "Print Area.") →P.675

Changing the Type of Paper



- When you load a roll, a menu for selection of the type of paper is shown on the Display Screen. Select the type of paper, and then press the **OK** button.
If no barcode has been printed on the roll and you have set **ManageRemainRoll** to **On**, specify the roll length after the type of paper. (See "Specifying the Paper Length.") → P.352

1 On the **Tab Selection screen** of the Control Panel, press ◀ or ▶ to select the Paper tab ().

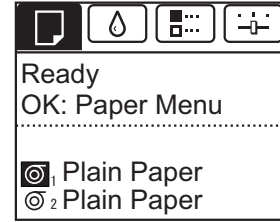

- If the **Tab Selection screen** is not displayed, press the **Menu** button.

2 Press the **OK** button.
The **Paper Menu** is displayed.

3 Press ▲ or ▼ to select **Chg. Paper Type**, and then press the **OK** button.

4 Press the ▲ button or the ▼ button to select the media type (**Roll 1 (Upper)**, **Roll 2 (Lower)**, or **Cut Sheet**), and then press the **OK** button.

5 Press ▲ or ▼ to select the type of paper loaded in the printer, and then press the **OK** button.



- Be sure to select the correct paper type. If this setting does not match the loaded paper, it may cause feed errors and affect printing quality.



- For details on types of paper, see the **Paper Reference Guide**. (See "Types of Paper.") → P.332 By default, Plain Paper is selected.
- If you move the Release Lever, the setting automatically reverts to the previously selected paper.

Using the Same Type of Paper Regularly

Configure this setting so that current media type settings will be automatically selected when you load the same type of paper later.

1 On the **Tab Selection screen** of the Control Panel, press ◀ or ▶ to select the Paper tab ().



- If the **Tab Selection screen** is not displayed, press the **Menu** button.

2 Press the **OK** button.
The **Paper Menu** is displayed.

3 Press ▲ or ▼ to select **Keep Paper Type**, and then press the **OK** button.

4 Press ▲ or ▼ to select **On**, and then press the **OK** button.



- The specified media type setting is updated in the following situations.
 - When using sheets, if you send a print job before loading a sheet, the media type setting is updated to match the type of paper specified by the print job.
 - When you have selected **ManageRemainRoll > On** on the Control Panel and a barcode is printed on the roll, the media type setting is updated to match the type of paper specified by the barcode.
 - To change the media type setting, see "Changing the Type of Paper." →P.351

Specifying the Paper Length

When changing the length of paper after the paper has been advanced, specify the length as follows.



- Specify the paper length when you have set **ManageRemainRoll** to **On**. (See "Keeping Track of the Amount of Roll Paper Left.") →P.358

- 1 On the **Tab Selection screen** of the Control Panel, press ◀ or ▶ to select the Paper tab ().

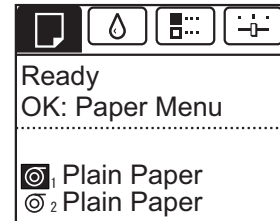

- If the **Tab Selection screen** is not displayed, press the **Menu** button.

- 2 Press the **OK** button.
The **Paper Menu** is displayed.
- 3 Press ▲ or ▼ to select **Chg. Paper Size**, and then press the **OK** button.
- 4 Press the ▲ button or the ▼ button to select **Roll1(Uppr)Length** or **Roll2(Lwr) Length**, and then press the **OK** button.
- 5 Press ▲ or ▼ to select the length of paper loaded in the printer, and then press the **OK** button.
Specify the roll length as follows.
 1. Press the ◀ or ▶ button to move to the next field for input.
 2. Press the ▲ or ▼ button to enter the value.
 3. Repeat steps 1 and 2 to finish entering the value, and then press the **OK** button.

Removing the Roll from the Printer

Remove rolls from the printer as follows.

If the Stacker is installed on the printer, first remove the Stacker from the printer. (See "Installing and Removing the Stacker On the Printer.") →P.376



- If you need to cut a printed roll, select **Paper Cutting** in the printer menu and cut the roll at the desired position. (See "Specifying the Cutting Method for Rolls.") →P.360

Removing rolls from the Roll 1 (Upper) position

- 1 On the **Tab Selection screen** of the Control Panel, press ◀ or ▶ to select the Paper tab ().

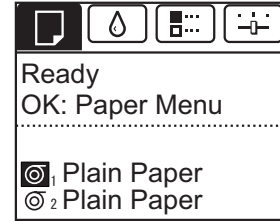

• If the **Tab Selection screen** is not displayed, press the **Menu** button.

- 2 Press the **OK** button.
The **Paper Menu** is displayed.
- 3 Press ▲ or ▼ to select **Remove Roll**, and then press the **OK** button.
- 4 Press ▲ or ▼ to select **Roll 1 (Upper)**, and then press the **OK** button.
- 5 Press ▲ or ▼ to select **Yes**, and then press the **OK** button.
The roll is rewound.



• If you have selected **ManageRemainRoll > On** in the Control Panel menu, a barcode is printed on the leading edge of the roll. Do not remove the roll before the barcode is printed. You will be unable to keep track of the amount of roll paper left. (See "Keeping Track of the Amount of Roll Paper Left.") →P.358

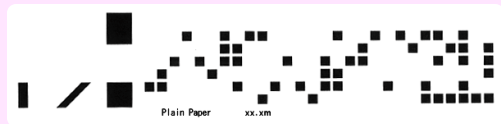

- 6 Open the Top Cover and lift the Ejection Guide.

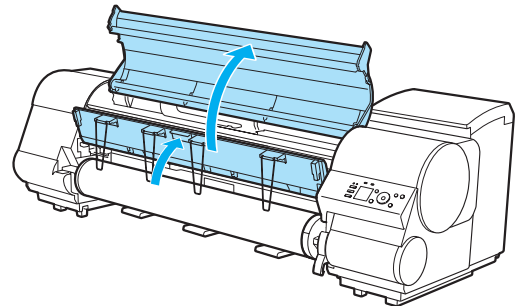

- 7 Using both hands, rotate the Roll Holder in the direction of the arrow to rewind the roll.

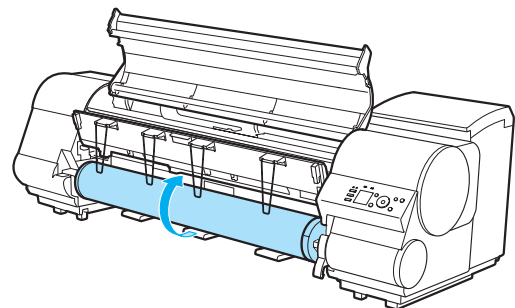

8 Holding the Roll Holder flange (a), remove the holder from the Roll Holder Slot.

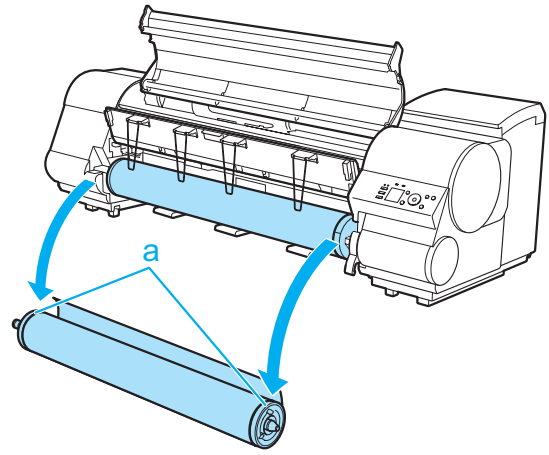

• For instructions on removing the Roll Holder from rolls, see "Removing the Roll Holder from Rolls." →P.356

9 Lower the Ejection Guide and close the Top Cover.

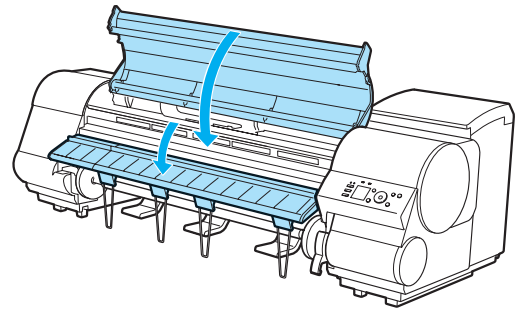

• To load new paper in the printer at this point, see "Loading Rolls in the Printer." →P.345
• Clean inside the top cover before loading paper. (See "Cleaning Inside the Top Cover.") →P.599

Removing rolls from the Roll 2 (Lower) position

1 On the **Tab Selection screen** of the Control Panel, press ◀ or ▶ to select the Paper tab ().

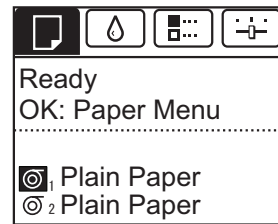

• If the **Tab Selection screen** is not displayed, press the **Menu** button.

2 Press the **OK** button.
The **Paper Menu** is displayed.

3 Press ▲ or ▼ to select **Remove Roll**, and then press the **OK** button.

4 Press ▲ or ▼ to select **Roll 2 (Lower)**, and then press the **OK** button.

5 Press ▲ or ▼ to select **Yes**, and then press the **OK** button. The roll is rewind.



- If you have selected **ManageRemainRoll > On** in the Control Panel menu, a barcode is printed on the leading edge of the roll. Do not remove the roll before the barcode is printed. You will be unable to keep track of the amount of roll paper left. (See "Keeping Track of the Amount of Roll Paper Left.") →P.358

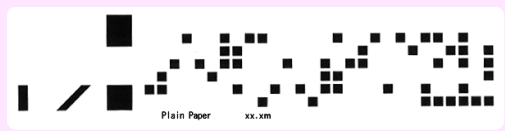

6 Check that "**No Paper Loaded**" is displayed on the Display Screen, and then grasp the Roll Unit Lever (a) and pull out the Roll Unit.

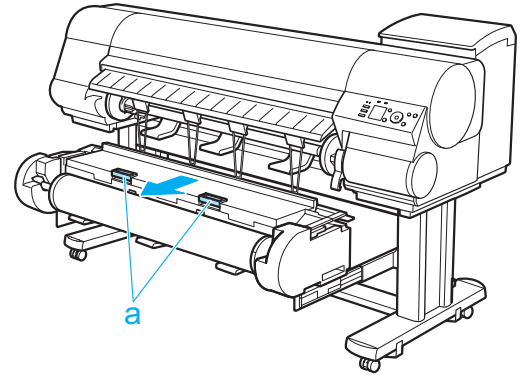

7 Using both hands, rotate the Roll Holder in the direction of the arrow to rewind the roll.

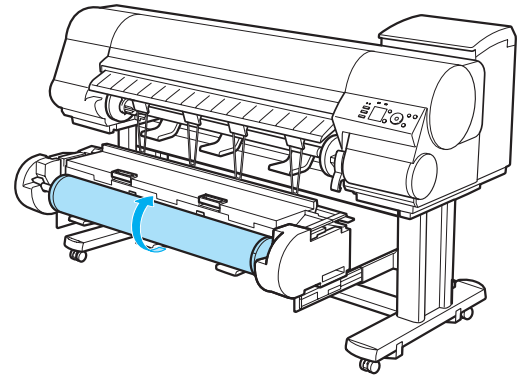

8 Holding the Roll Holder flange (a), remove the holder from the Roll Holder Slot.

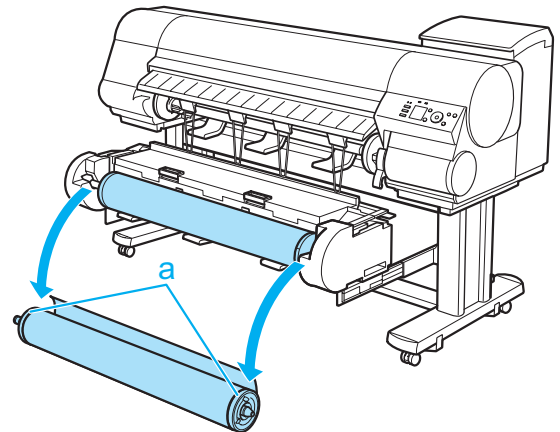

- For instructions on removing the Roll Holder from rolls, see "Removing the Roll Holder from Rolls." →P.356
- To load new paper in the printer at this point, see "Loading Rolls in the Printer." →P.345

- 9 In a crouching position, push the Roll Unit in with both hands.

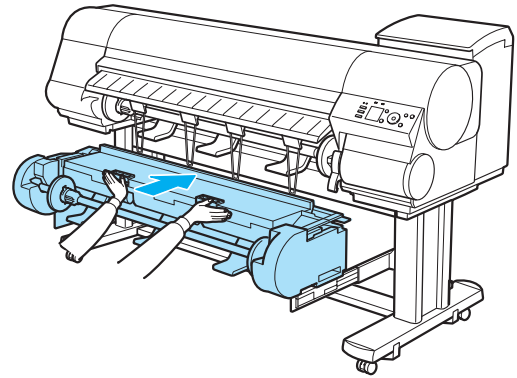

Removing the Roll Holder from Rolls

- 1 Lift the Holder Stopper lever (a) from the shaft side to unlock it. Holding the Holder Stopper at the position indicated (b), remove it from the Roll Holder.

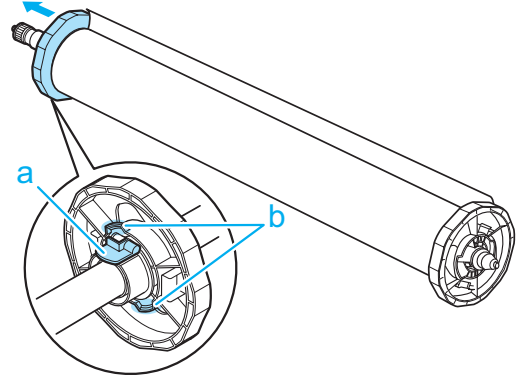

- 2 Remove the Roll Holder from the roll.

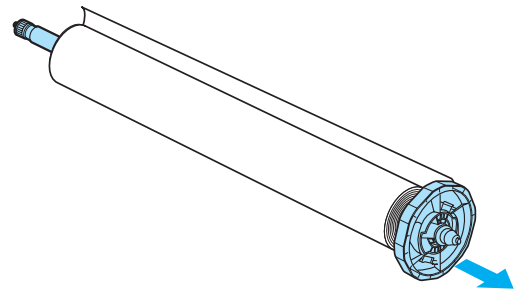

- 3 When removing attachments, push the tips (a) in as you remove the attachment.
 - 3-Inch Paper Core Attachment #1 (Roll Holder side)

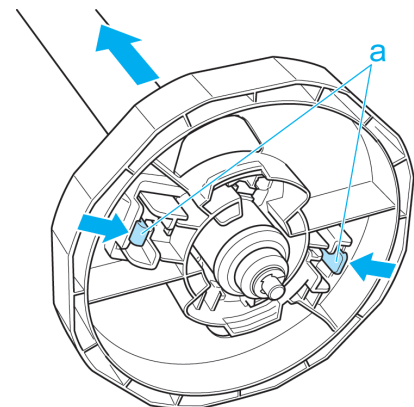

- 3-Inch Paper Core Attachment #2 (Holder Stopper side)

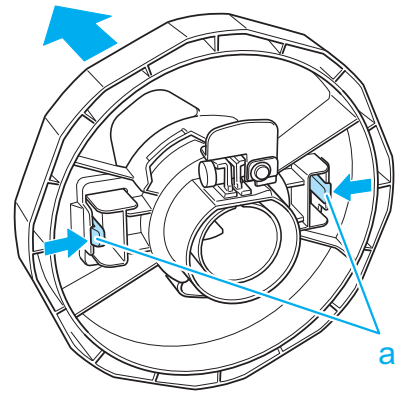

- 2-Inch Paper Core Attachment

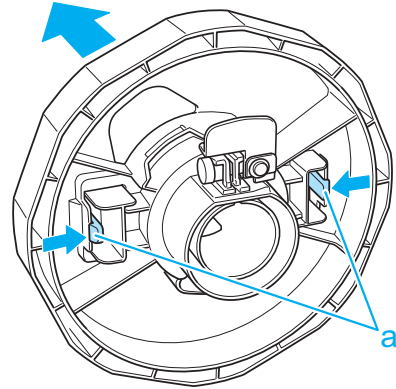

Important

- Store the roll in the original bag or box, away from high temperature, humidity, and direct sunlight. If paper is not stored properly, the printing surface may become scratched, which may affect the printing quality when you use it again.

Feeding Roll Paper Manually

After a roll has been advanced, you can press the **Feed** button to feed or retract the roll with the ▲ and ▼ buttons.

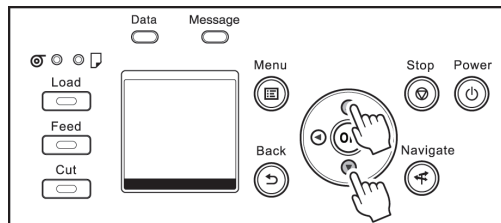

- 1 Press the **Feed** button.
- 2 Press the ▲ or ▼ button to advance or retract the roll.
Press ▲ to retract the roll manually.
Press ▼ to advance the roll manually.



Note

- If you hold down ▲ or ▼ for less than a second, the roll will move about 1 mm (0.04 in). If you hold down ▲ or ▼ for more than a second, the roll will move until you release the button. Release the button when the Display Screen indicates "**End of paper feed. Cannot feed paper more.**"
- Paper can be fed even when the Stacker is attached. However, if paper is left for some period of time caught in the Stacker, the Stacker will stop. If this happens, first remove the paper from the Stacker and then turn the Stacker power off and then on again.

Keeping Track of the Amount of Roll Paper Left

Setting **ManageRemainRoll** to **On** in the **Paper Menu** of the Control Panel will print a barcode with text on the roll when the roll is removed that identifies the type of paper and amount left. When **ManageRemainRoll** is **On** and you load rolls with printed barcodes, the type of paper and amount left are automatically detected after rolls are loaded. The barcode will be cut off after it has been read.

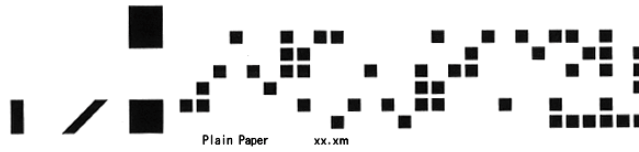

- If the barcode on the roll is not detected, enter the type and length of paper on the Control Panel.

Follow these steps to set **ManageRemainRoll** to **On** as follows.

- 1 On the **Tab Selection screen** of the Control Panel, press ◀ or ▶ to select the Paper tab ().

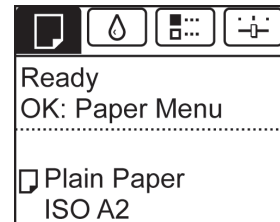

- If the **Tab Selection screen** is not displayed, press the **Menu** button.

- 2 Press the **OK** button.
The **Paper Menu** is displayed.
- 3 Press ▲ or ▼ to select **ManageRemainRoll**, and then press the **OK** button.
- 4 Press ▲ or ▼ to select **On**, and then press the **OK** button.

Specifying the Ink Drying Time for Rolls

When you are using paper that takes longer for ink to adhere, ink may be transferred onto the paper surface during ejection, soiling it. In that case, you may be able to improve the condition by setting the time to wait for the ink to dry after printing.



- If the Cutter touches the print surface on which the ink is not dry, the paper surface may become scratched or soiled, or the paper surface may rub when the paper falls and the surface may become soiled. To wait for the ink to dry without allowing printed documents to fall after printing, set **Cutting Mode** on the menu of the printer to **Eject**. (See "Specifying the Cutting Method for Rolls.") →P.360
- The settings can also be made from the Control Panel on the printer. Select the type of paper from **Paper Details** in **Paper Menu**. (See "Menu Settings.") →P.449

Windows

- 1 Display the printer driver dialog box.
(See "Accessing the Printer Driver Dialog Box from the Operating System Menu (Windows).") →P.165

- 2 Select the **Main** sheet and click **C Advanced Settings** in **A Media Type**.

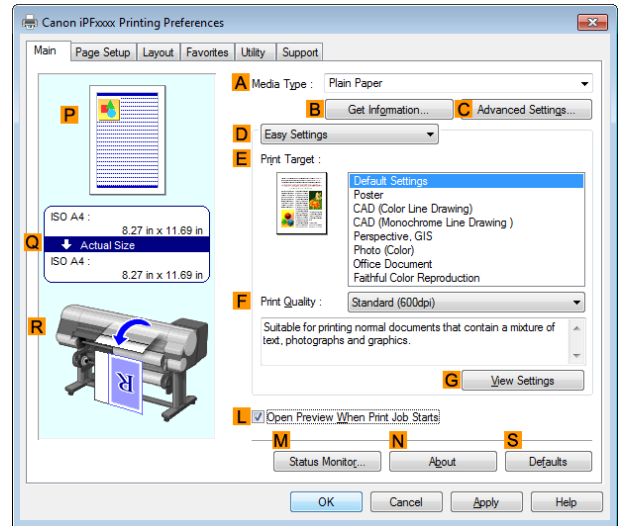

- 3 In the **Paper Detailed Settings** dialog box displayed next, select the desired settings values in **B Between Pages** and **C Between Scans** in **A Drying Time**, and then click **OK**.
(See "Paper Detailed Settings Dialog Box (Windows).") →P.170

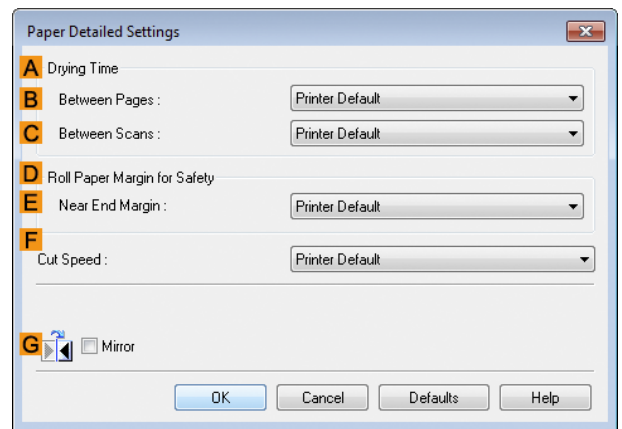

Mac OS

- 1 Choose **Print** in the application menu.
- 2 Select the **Main** pane and click **C Settings** in **A Media Type**.

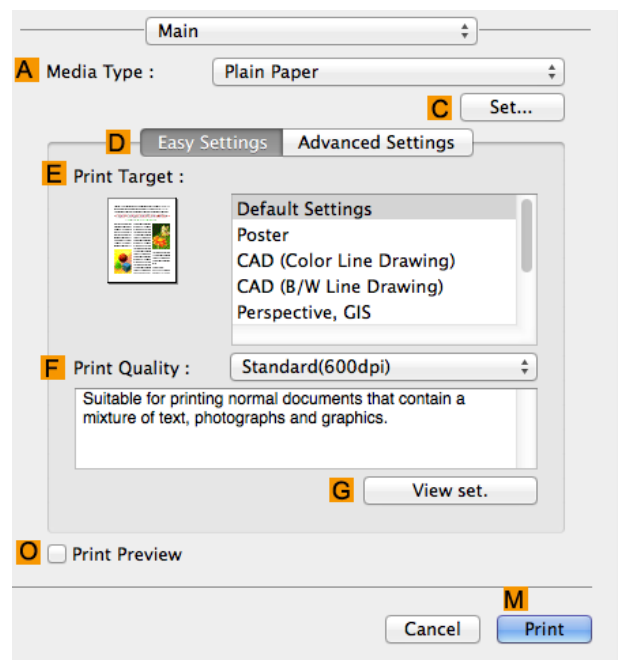

3 In the **Paper Detailed Settings** dialog box displayed next, select the desired settings values in **C Between Pages** and **D Between Scans** in **B Drying Time**, and then click **OK**.
(See "Paper Detailed Settings Dialog Box (Mac OS).") → P.276

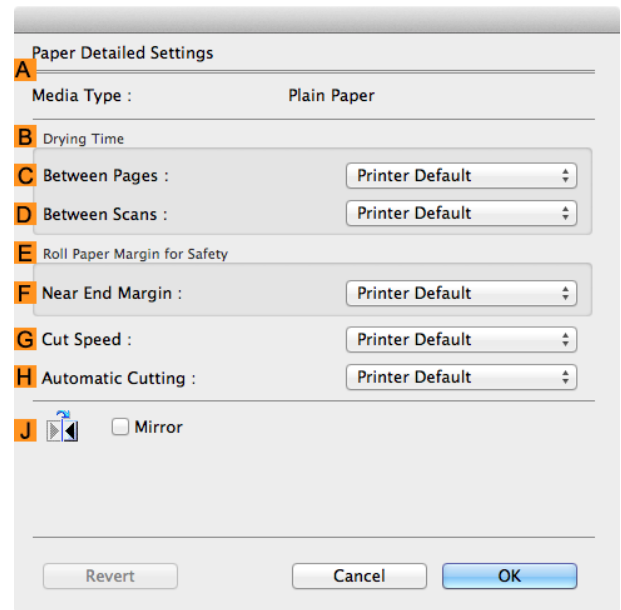

Specifying the Cutting Method for Rolls

How rolls are cut after ejection varies depending on printer settings.

Cutting Method		Printer Setting		Driver Setting	
Automatic	The roll is automatically cut by the Cutter Unit following printer driver settings.	Media Menu > Paper Details > (Various Types of Paper) > Cutting Mode	Automatic	Automatic Cutting (See "Cutting Roll Paper After Printing.") → P.152	Yes
Eject (when the paper surface is being scratched / to wait for ink to dry)	Select this to move the cutter by key operation and cut paper. Although there are cases with Automatic in which the paper falls and the paper surface is scratched when the paper rubs the Output Stacker, you can avoid damaging the paper with this method since you can cut by holding the paper with your hand so that the paper does not fall when cutting, Also, since you can cut while visually confirming the drying of the ink, you can avoid ejecting paper before the ink has dried. To cut the roll with the Cutter Unit, press the Cut button.		Eject		Yes
Manual (when using media that cannot be cut with the Cutter Unit)	Select this for paper that cannot be cut with the Cutter Unit and for paper of which the leading edge curls strongly and rubs the printhead. Cut each page from the roll using scissors. For continuous printing (if you will cut each page later), select Automatic Cutting > Yes or select Print Cut Guideline .		Manual	No, Yes, Print Cut Guideline	
Paper cutting (to have the roll cut at your specified position)	Choose this option if you want to cut pages by pressing Cutter Unit buttons for manual cutting after printing when Automatic Cutting > No is selected or Print Cut Guideline is selected in the printer driver. Otherwise choose this option if you want to cut the roll edge after loading a roll.	Cut button pressed	Yes	No, Print Cut Guideline	



Note

- Automatic and Eject are valid only when you have selected **Automatic Cutting > Yes** in the printer driver.
- With Eject, printing does not resume after a series of jobs have been printed continuously until the roll is cut.
- **Eject** is the preset selection in **Cutting Mode** for some types of paper. For this paper, we recommend keeping the preset cutting mode.
- If documents printed using Automatic, Eject, or manual cutting are short, rolls are advanced a specific amount before cutting to prevent problems with cutting and paper ejection. This may create a wider bottom margin, in some cases.

Cut rolls manually in the following cases:

Eject (when the paper surface is being scratched / to wait for ink to dry)

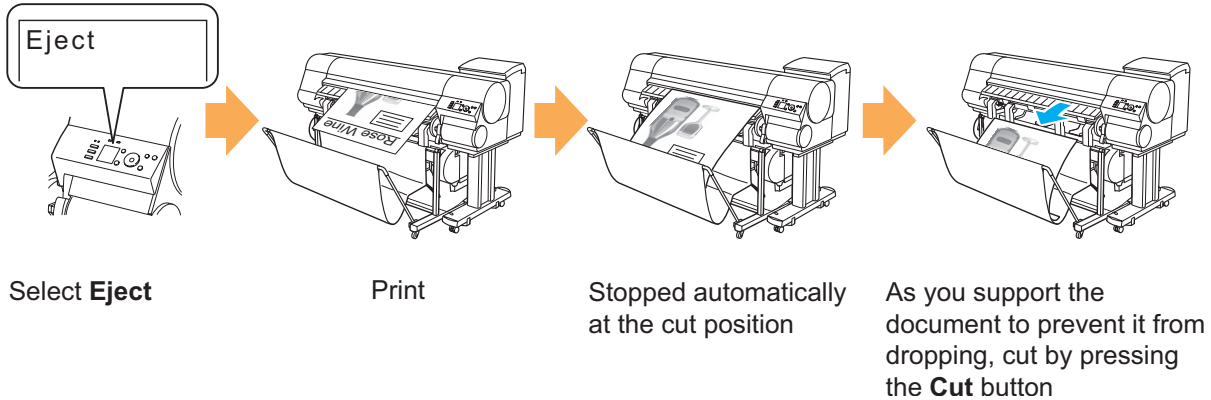

Important

- When cutting wide printed documents after ejection, have two people support the documents. If the paper drops, printed documents may be damaged.
- Do not lift the paper when holding printed documents before cutting. If the paper rises, it may affect the printing quality or cause rough cut edges.



Note

- Once the following step has been performed, the procedure can be started from step 7 the next time.
 - Printing the second and subsequent times
 - Printing after replacing with the same type of paper

1 On the **Tab Selection screen** of the Control Panel, press ◀ or ▶ to select the Paper tab ().

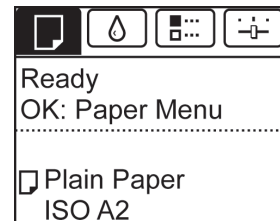

Note

- If the **Tab Selection screen** is not displayed, press the **Menu** button.

2 Press the **OK** button. The **Paper Menu** is displayed.

3 Press ▲ or ▼ to select **Paper Details**, and then press the **OK** button.

4 Press ▲ or ▼ to select the type of paper, and then press the **OK** button.

5 Press ▲ or ▼ to select **Cutting Mode**, and then press the **OK** button.

6 Press ▲ or ▼ to select **Eject**, and then press the **OK** button.

7 Print the job.
When printing is finished, the printer will stop without cutting.

8 Holding the printed document to prevent it from dropping, press the **Cut** button to cut the roll.

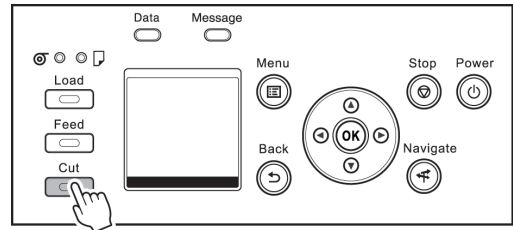

Manual (when using media that cannot be cut with the Cutter Unit)

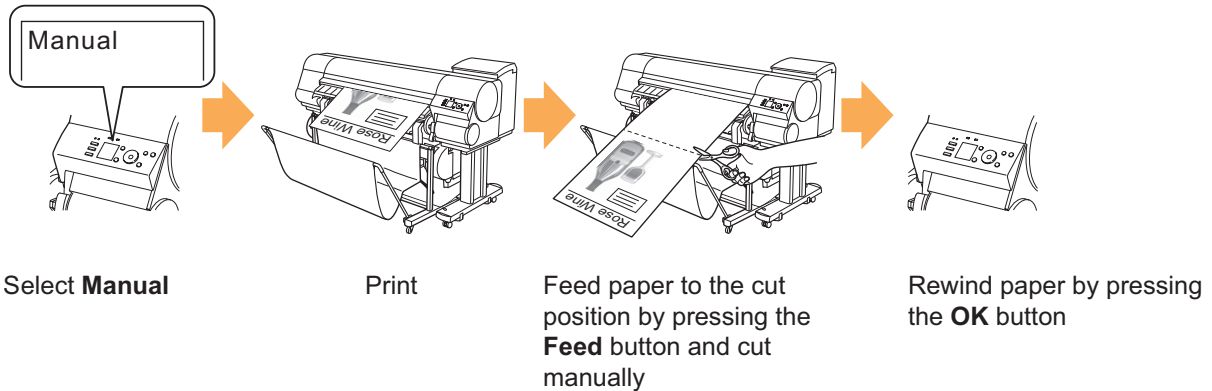

- Once the following step has been performed, the procedure can be started from step 8 the next time.
- Printing the second and subsequent times
- Printing after replacing with the same type of paper

1 On the **Tab Selection screen** of the Control Panel, press ◀ or ▶ to select the Paper tab ().

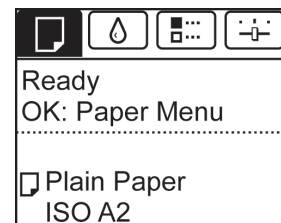

- If the **Tab Selection screen** is not displayed, press the **Menu** button.

2 Press the **OK** button. The **Paper Menu** is displayed.

3 Press ▲ or ▼ to select **Paper Details**, and then press the **OK** button.

4 Press ▲ or ▼ to select the type of paper, and then press the **OK** button.

5 Press ▲ or ▼ to select **Cutting Mode**, and then press the **OK** button.

6 Press ▲ or ▼ to select **Manual**, and then press the **OK** button.

7 When "**Perform the detection of paper leading edge?**" is displayed, select **Perform(recommend)**.

8 Print the job.
The printer stops advancing the paper after printing.

9 Press the **Feed** button.

Roll paper is fed to the specified cut position and then automatically stopped.

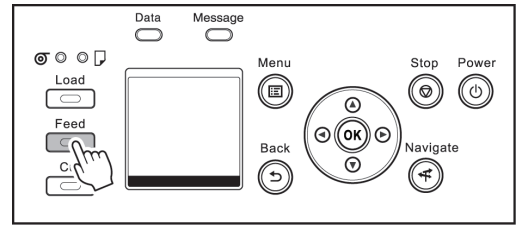

10 Cut the roll paper manually with scissors or the like.

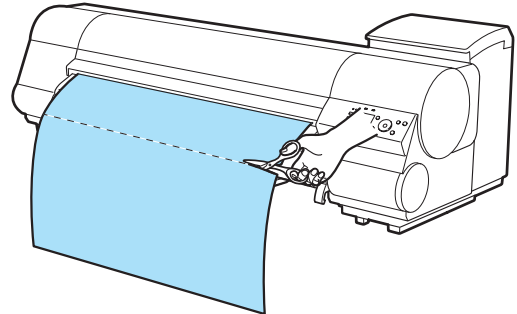

11 Press the **OK** button.

After the roll is rewound, it stops automatically.

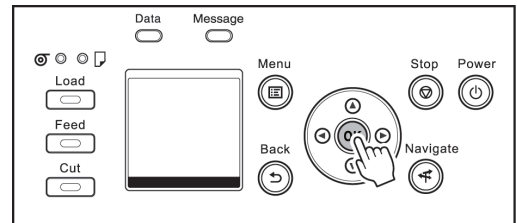

Manual (for paper of which the leading edge rubs the printhead)

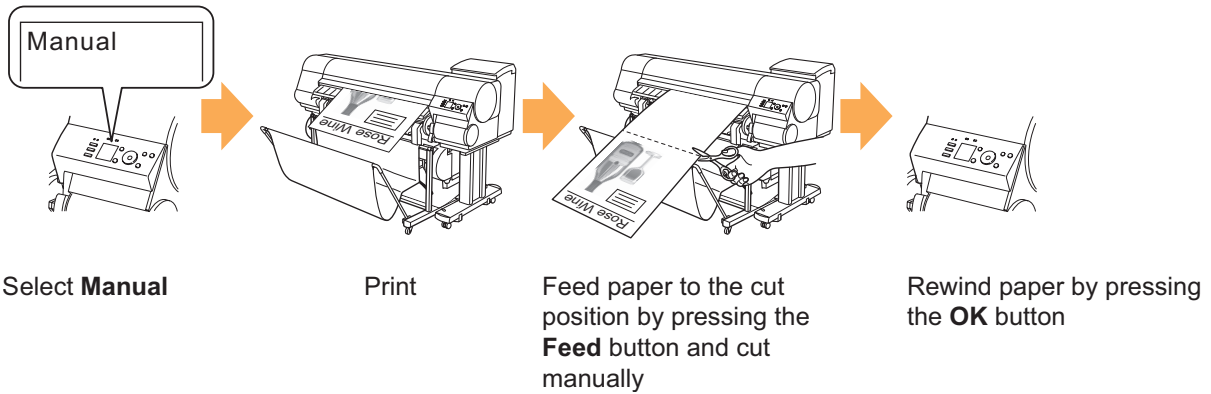

- Once the following step has been performed, the procedure can be started from step 10 the next time.
- Printing the second and subsequent times
- Printing after replacing with the same type of paper

1 On the **Tab Selection screen** of the Control Panel, press ◀ or ▶ to select the Paper tab ().

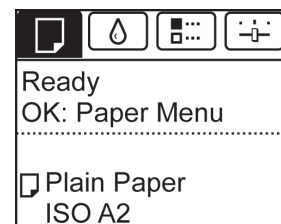

- If the **Tab Selection screen** is not displayed, press the **Menu** button.

- 2 Press the **OK** button. The **Paper Menu** is displayed.
- 3 Press **▲** or **▼** to select **Paper Details**, and then press the **OK** button.
- 4 Press **▲** or **▼** to select the type of paper, and then press the **OK** button.
- 5 Press **▲** or **▼** to select **Cutting Mode**, and then press the **OK** button.
- 6 Press **▲** or **▼** to select **Manual**, and then press the **OK** button.
- 7 When "**Perform the detection of paper leading edge?**" is displayed, select **Do not perform**.

 **Note**

- If you set the detection of paper leading edge to **Do not perform**, a margin of about 10 cm is created at the paper leading edge when printing starts.
- When the detection of paper leading edge is set to **Do not perform**, printing will start at the position at which the roll was set for the first printing after replacing a roll. Thus, the margin of the paper leading edge will enlarge.
(See "Loading Rolls in the Printer.") →P.345

- 8 Press the **Feed** button.

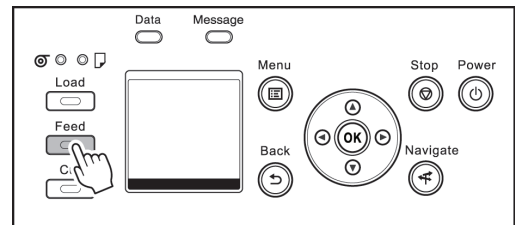

- 9 Press **▲** or **▼** to align the paper leading edge with the (a) position.

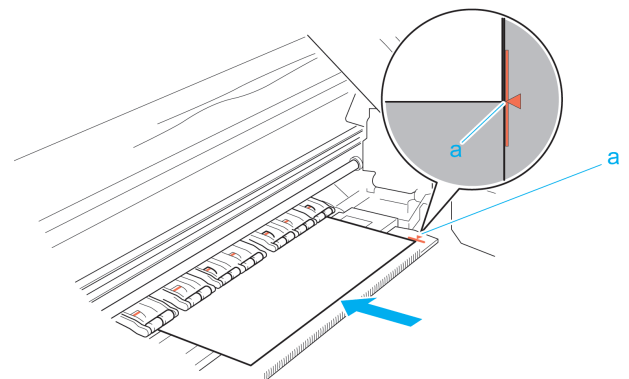

- 10 Print the job.
The printer stops advancing the paper after printing.

 **Note**

- The printer can continue to receive print jobs from computers. If a print job is received and printed here, it can be printed without the margin of about 10 cm being created at the paper leading edge.

- 11 Press the **Feed** button.

Roll paper is fed to the specified cut position and then automatically stopped.

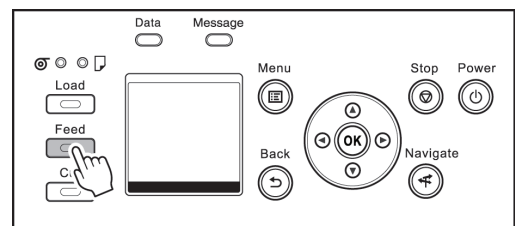

12 Cut the roll paper manually with scissors or the like.

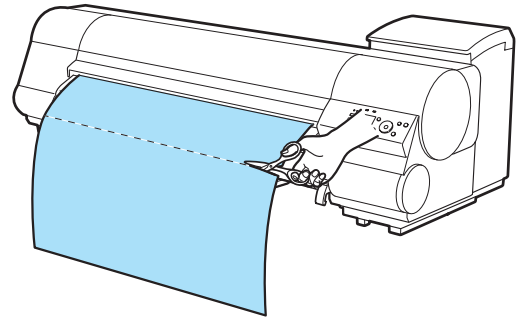

- Cut at the dotted line printed on the paper. If you cut on the printer side of the dotted line, the paper leading edge may rub against the printhead and may deviate from the paper retainer.

13 Press the **OK** button.

After the roll is rewound, it stops automatically.

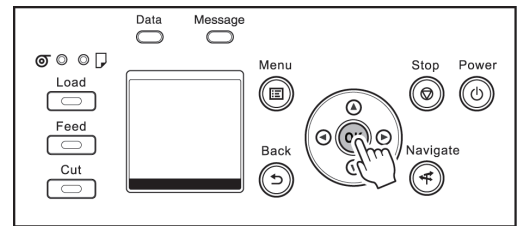

Paper cutting (to have the roll cut at your specified position)

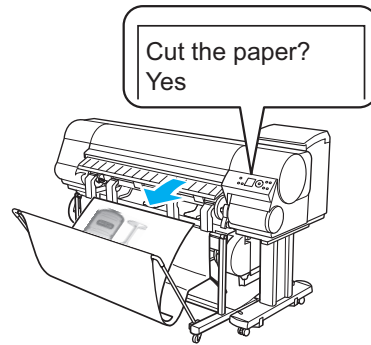
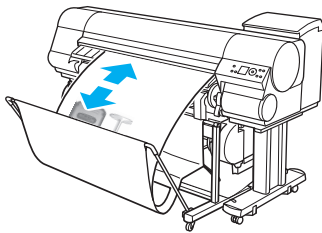

Feed paper the cutting position by pressing ▲ or ▼

Paper Cutting

1 Press the **Feed** button.

2 Press the ▼ button to advance the roll to the position for cutting.

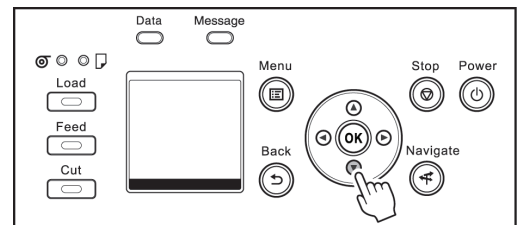

3 Press the **Cut** button.

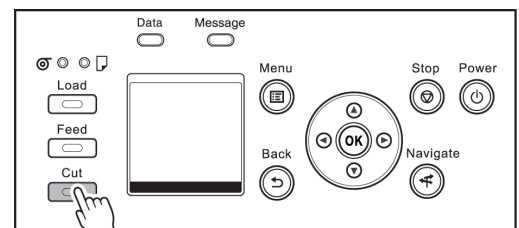

- 4 Press ▲ or ▼ to select **Yes**, and then press the **OK** button.
After the roll paper is cut, it is rewound automatically.

Cutting the Leading Edge of Roll Paper Automatically

If the leading edge of the paper is cut crooked or is not cut straight when roll paper is loaded, it will not print correctly. If this happens, you can cut the leading edge of the paper straight when loading a paper roll by using **Trim Edge First** in the Control Panel menu.

Trim Edge First offers the following options.

- **Automatic**

If the leading edge of the paper is cut crooked and is not cut straight when loading roll paper, cut the leading edge straight and eject the fragment of paper to prevent printing on the platen and soiling the printer.

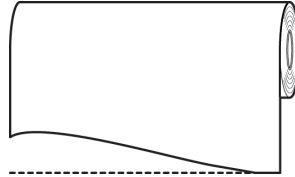

- **On (Preset Len)**

The amount to cut from the leading edge of the paper varies depending on the media type, and is cut to a prescribed length. For more information on the prescribed length, see the leading edge pre-cut length in the **Paper Reference Guide**. (See "Displaying the Paper Reference Guide.") → P.335

- **On(Input Length)**

The amount to cut from the leading edge of paper is specified in the control panel. The amount to cut from the leading edge can be specified in the range of lengths displayed in the control panel. The range of lengths differs between each media type.



- The amount to cut from the leading edge of paper cannot be set shorter than the length displayed in the control panel.

- **Manual**

The amount to cut from the leading edge of the paper can be adjusted by pressing the ▲ and ▼ buttons. After making the adjustment, you can cut the paper by pressing the **Paper Cutting** button and selecting "**Cut paper**".

After the paper has been cut, press "**Finish paper set**".



- If you do not press "**Finish paper set**" after cutting the paper, you will not be able to print again.

- **Off**

The edge is not cut and scraps are not removed.

Follow these steps to change the **Trim Edge First** setting.

- 1 On the **Tab Selection screen** of the Control Panel, press ◀ or ▶ to select the Paper tab ().

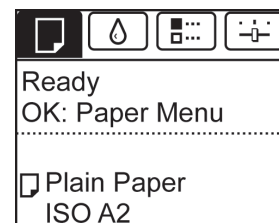

- If the **Tab Selection screen** is not displayed, press the **Menu** button.

- 2** Press the **OK** button.
The **Paper Menu** is displayed.
- 3** Press **▲** or **▼** to select **Paper Details**, and then press the **OK** button.
- 4** Press **▲** or **▼** to select the type of paper, and then press the **OK** button.
- 5** Press **▲** or **▼** to select **Trim Edge First**, and then press the **OK** button.
- 6** Press **▲** or **▼** to select the desired setting option, and then press the **OK** button.
This setting takes effect the next time you load a roll.

Reducing Dust from Cutting Rolls

For media such as Backlit Film that are more likely to generate debris when cut, select **CutDustReduce. > On** in the **Paper Menu** of the Control Panel. This option reduces debris from cutting by printing black lines at the leading and trailing edges of documents. It may help prevent Printhead damage. You can specify for **CutDustReduce.** to be activated for particular types of paper.

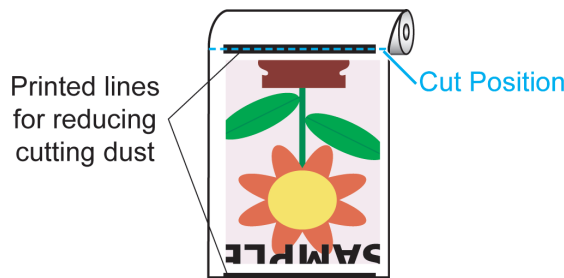

Important

- Do not set **CutDustReduce.** to **On** for paper that wrinkles easily, such as Plain Paper or lightweight paper. This may impair cutting and cause paper jams.
- Borderless printing is not available when **CutDustReduce.** is set to **On**. To use borderless printing, select **CutDustReduce. > Off**.

Set **CutDustReduce.** to **On** as follows.

- 1** On the **Tab Selection screen** of the Control Panel, press **◀** or **▶** to select the Paper tab ().

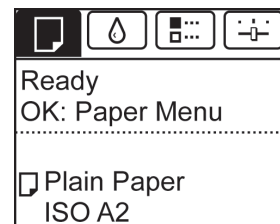

Note

- If the **Tab Selection screen** is not displayed, press the **Menu** button.

- 2** Press the **OK** button.
The **Paper Menu** is displayed.
- 3** Press **▲** or **▼** to select **Paper Details**, and then press the **OK** button.
- 4** Press **▲** or **▼** to select the type of paper loaded in the printer, and then press the **OK** button.
- 5** Press **▲** or **▼** to select **CutDustReduce.**, and then press the **OK** button.
- 6** Press **▲** or **▼** to select **On**, and then press the **OK** button.

Roll Holder Set

Load a roll on the roll holder and then load the holder in the printer. The Roll Holder in the Roll Holder Set RH2-44 is for use with both 2-inch and 3-inch paper cores. Use the correct attachment for the particular paper core. (See "Attaching the Roll Holder to Rolls.") →P.342

- Roll Holder Set RH2-44
 - Roll Holder (for 2- and 3-inch paper cores)

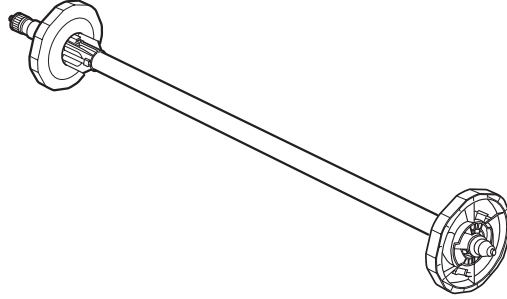

- Attachments

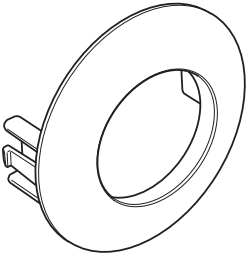
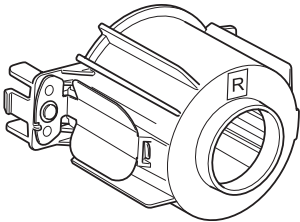
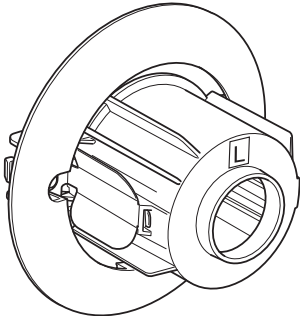
Using the 2-Inch Paper Core Attachment	Using the 3-Inch Paper Core Attachment	
2-Inch Paper Core Attachment	3-Inch Paper Core Attachment #1	3-Inch Paper Core Attachment #2
		

Automatic Roll Switching

With this printer, you can load roll paper in both the upper (roll paper 1) and lower (roll paper 2) rolls, and print by automatically switching between roll paper 1 and roll paper 2 depending on the print job.

Details on how to switch between roll paper 1 and roll paper 2, see "Roll Paper Switching Method." →P.39



Handling sheets

- Loading Sheets in the Printer 369
- Changing the Type of Paper 350
- Printing From a Desired Starting Point 371
- Removing Sheets 373
- ➔ Clearing a Jammed Sheet 622

Loading Sheets in the Printer

Follow these steps to load sheets in the printer.

The Stacker cannot be used for cut sheets. If the Stacker is installed on the printer, first remove the Stacker from the printer. (See "Installing and Removing the Stacker On the Printer.") ➔P.376

-  **Important**
 - Paper that is wrinkled or warped may jam. If necessary, straighten the paper and reload it.
 - Load the paper straight. Loading paper askew will cause an error. (See "Paper loaded askew..") ➔P.660
 - If you are using cut sheets of length 860 mm (33.9 in) or more, the loaded cut sheets may touch the floor, causing soiling and scratching of the paper. If this happens, place a clean cloth or paper on the floor so that the cut sheets do not touch the floor directly.
-  **Note**
 - Before loading sheets, make sure the printer is clean inside the Top Cover and around the Ejection Guide. If these areas are dirty, we recommend cleaning them in advance. (See "Cleaning Inside the Top Cover.") ➔P.599
 - Store unused paper in the original package, away from high temperature, humidity, and direct sunlight.

1 Select sheets as the paper source.

- If a print job was received
 Sheets are automatically selected, and the media type and size specified by the print job are shown on the Display Screen.
 Press ▲ or ▼ to select **Load Paper**, and then press the **OK** button.

• If no print job was received

1. Press the **Load** button.

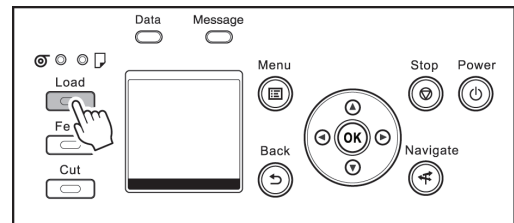

2. Press ▲ or ▼ to select **Cut Sheet**, and then press the **OK** button.

-  **Note**
 - If any paper has been advanced that will not be used, a message is shown requesting you to remove it. Press ▲ or ▼ to select **Yes**, and then press the **OK** button. Remove the paper and go to the next step.

2 Lift the Release Lever and open the Top Cover.

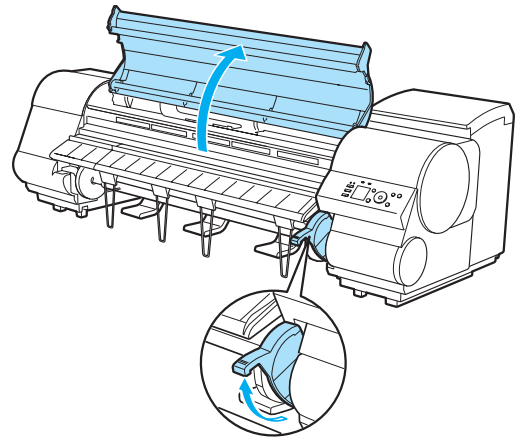

Important

- Do not touch the Linear Scale (a), Carriage Shaft (b), or Ink Tube Stabilizer (c). Touching these parts may damage them.

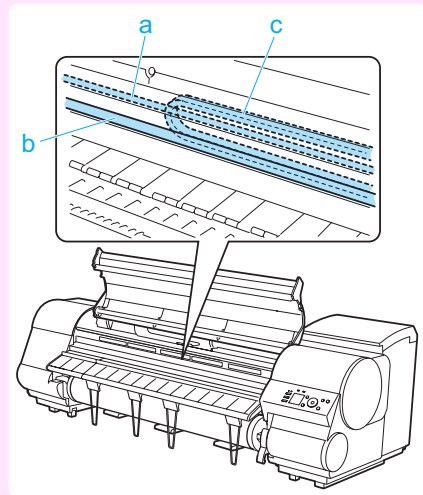

3 With a sheet lengthwise and printing-side up, insert it between the Platen (a) and the Paper Retainer (b). Align the edges of the sheet as follows.

1. Align the sheet with the Paper Alignment Line (c) at right.
2. Align the inserted edge of the sheet with the leading edge of the Paper Alignment Line (d), as shown.

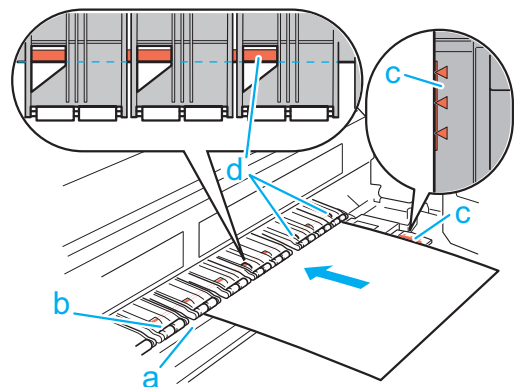

When inserted, sheets are automatically held by suction against the Platen.



Important

- Load a sheet so that it is parallel to the Paper Alignment Line at right (c). Loading paper askew will cause an error.
- Warped paper may rub against the Printhead. Straighten paper if it is warped before loading it.



Note

- You can adjust the strength of suction holding paper against the Platen when the Release Lever is up. If it is difficult to load paper, press the ▲ or ▼ button on the Control Panel to adjust the strength. Set suction stronger by pressing the ▲ button or weaker with the ▼ button. Three settings are available. However, even if you increase the suction, it may not be sufficient to hold some types of paper against the Platen well. In this case, use your hand to load the paper.
- Sheets are held in place by suction through holes on the Platen. Although the suction may produce a noise when paper is loaded in some positions, it does not indicate a problem. If the noise is distracting, try moving the paper over slightly to the left or right (up to 1 mm [0.039 in]) while keeping it parallel to the Paper Alignment Line.
- The suction remains on for about 30 seconds during loading. If you cannot finish loading a sheet during this time, pull the sheet away and reinsert it to start the suction again.

4 Lower the Release Lever and close the Top Cover.

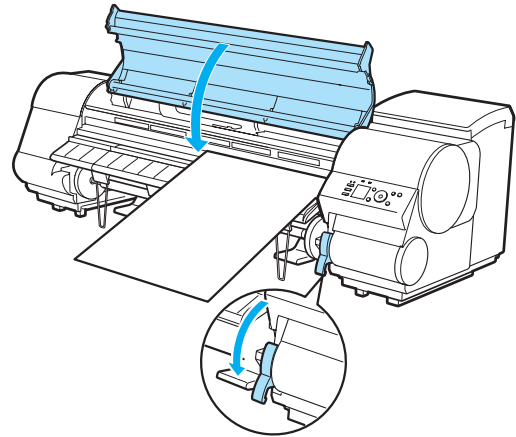

- If a print job was received
Pressing the **OK** button will advance the paper, and then printing will begin.
- If no print job was received
A menu for selection of the type of paper is shown on the Display Screen.
Press ▲ or ▼ to select the type of paper, and then press the **OK** button.
The printer now starts feeding the paper.



Note

- Refer to **Paper Reference Guide** for details on type of paper to select. (See "Displaying the Paper Reference Guide.") →P.335

Printing From a Desired Starting Point

Print on sheets from a desired starting point as follows.

Set **Width Detection** to **Off**

- On the **Tab Selection screen** of the Control Panel, press ◀ or ▶ to select the Paper tab ().



Note

- If the **Tab Selection screen** is not displayed, press the **Menu** button.

- Press the **OK** button.
The **Paper Menu** is displayed.

- 3** Press ▲ or ▼ to select **Paper Details**, and then press the **OK** button.
- 4** Press ▲ or ▼ to select the type of paper, and then press the **OK** button.
- 5** Press ▲ or ▼ to select **Width Detection**, and then press the **OK** button.
- 6** Press ▲ or ▼ to select **Off**, and then press the **OK** button.

Load paper in the desired position to start printing from

Follow these instructions to load paper at the desired starting position for printing when **Width Detection** is **Off**.

- 1** If you did not send a print job in advance, a menu for selection of the type of paper is displayed. Press ▲ or ▼ to select the type of paper, and then press the **OK** button.



If a print job was received before paper was advanced, the media type and size specified by the job are shown on the Display Screen. Go to step 2.

- 2** "**Width Detection OFF. OK to continue?**" is now shown on the Display Screen. Press ▲ or ▼ to select "**Leave OFF**", and then press the **OK** button.

- 3** After a menu for selection of the paper size is displayed, press ▲ or ▼ to select the paper size, and then press the **OK** button.

- 4** Open the Top Cover and check the position where paper is loaded.

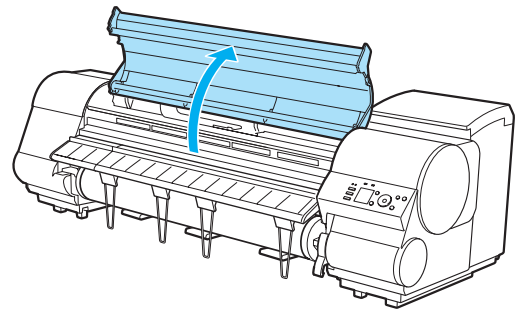

To start printing from the current position, close the Top Cover.
To reposition the paper, lift the Release Lever.

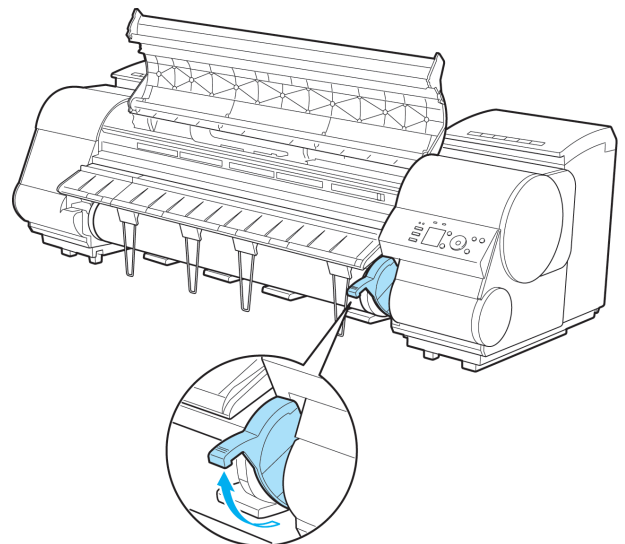

5 Keeping the right edge of the paper aligned with the extended line of the paper alignment line (a) on the right side of the printer and the position from which to start printing aligned with the groove (b) at the far end of the platen, load the paper.

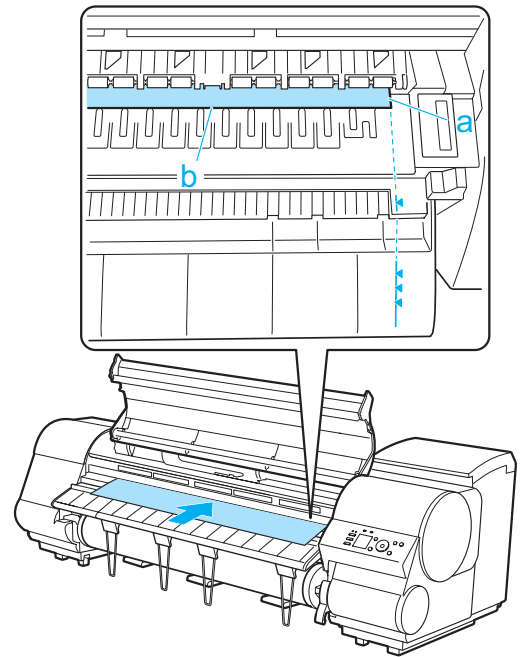

6 Lower the Release Lever and close the Top Cover.

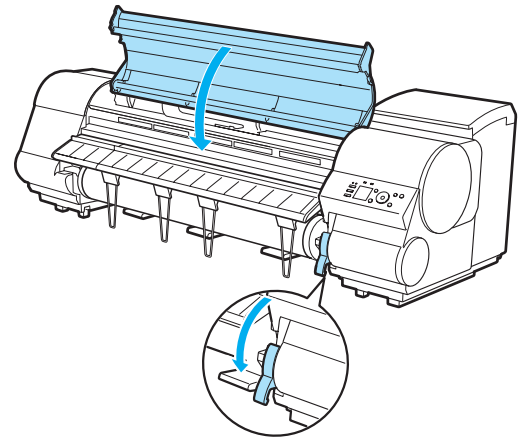

Removing Sheets

Remove sheets from the printer as follows.

1 On the **Tab Selection screen** of the Control Panel, press ◀ or ▶ to select the Paper tab ().

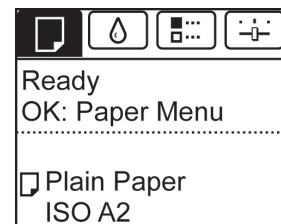

• If the **Tab Selection screen** is not displayed, press the **Menu** button.

Note

2 Press the **OK** button.
The **Paper Menu** is displayed.

3 Press ▲ or ▼ to select **Eject Paper**, and then press the **OK** button.

4 Press ▲ or ▼ to select **Cut Sheet**, and then press the **OK** button.

5 Press ▲ or ▼ to select **Yes**, and then press the **OK** button.
The paper is ejected from the front of the printer.

6 As you hold the sheet, lift the Release Lever and remove the sheet.

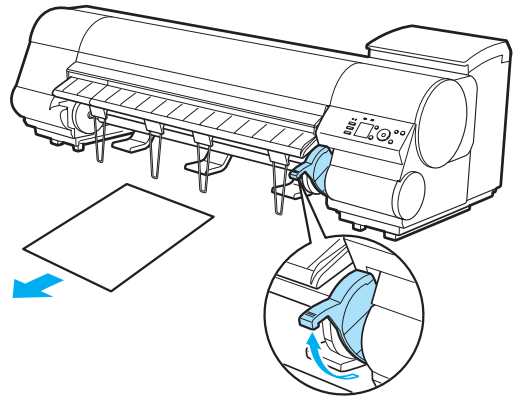

7 Lower the Release Lever.

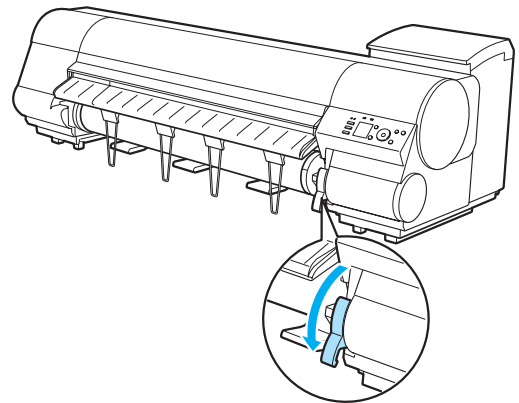

Stacker

- Stacker 375
- Installing and Removing the Stacker On the Printer 376
- Ejecting to the Stacker 380
- Ejecting to the Output Stacker 381

Stacker

The Stacker can be used in two different positions depending on the ejection method.

- When ejecting to the Stacker

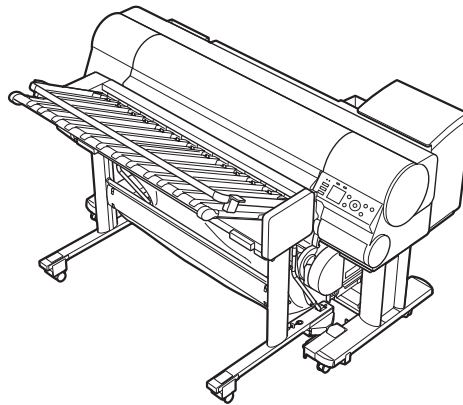

Use with the Stacker installed on the printer.

This can be used when printing on supported roll paper. (See "Ejecting to the Stacker.") →P.380

- When ejecting to the Output Stacker

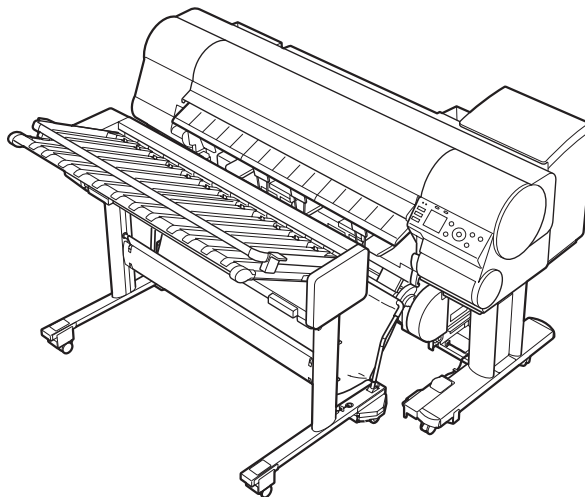

Use with the Stacker removed from the printer.

This can be used when printing on cut sheets and roll paper which is not supported by the stacker. (See "Ejecting to the Output Stacker.") →P.381



Caution

- When performing work between the Stacker and printer, such as when replacing the paper, take care that your feet do not get caught on the cables.
- When moving the Stacker, move it by holding the Stacker outer frame (b) with the canopy (a) closed. Moving it by holding any other location may cause injuries or damage to the stacker.

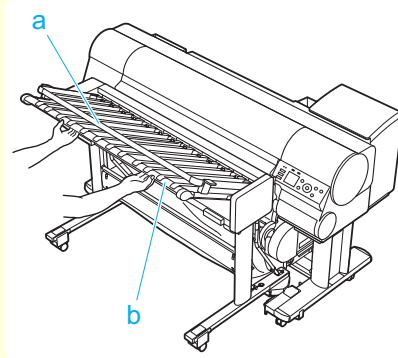

Important

- When loading paper in the printer, first move the Stacker away from the printer.
- When printing on cut sheets, always move the Stacker away from the printer.
- When moving the Stacker, take care to ensure that the cables do not get caught on the casters.
- Before moving the Stacker, clear away all the paper contained in the stacker. If you move the Stacker while it still contains paper, the printed documents may become scratched or misaligned and the next ejection may not be performed properly.
- Do not place anything on top of the Stacker. Applying excessive force can cause damage.
- Turn the printer and Stacker off before removing the Stacker cable.
- When connecting the Stacker cable, turn the printer off, attach the cable, and then turn the printer on again.
- The Stacker Canopy may become difficult to open depending on how it is stored. If this happens, have two people hold the handles on the left and right side of the Canopy and open the left and right sides simultaneously while ensuring that the Canopy does not bend.



Note

- For information on paper that is supported for ejecting to the Stacker, refer to the Paper Reference Guide. (See "Displaying the Paper Reference Guide.") → P.335
The operation may not function correctly for paper not listed here.
- The Stacker can hold 100 sheets of A0 size. (When the AutoCAD LT2004 sample image Cottage Plan and Elevation.dwg was printed.)

Installing and Removing the Stacker On the Printer

Installing the Stacker on the Printer

When ejecting to the Stacker, install the Stacker on the printer using the following procedure before starting printing.



Note

- Before installing the Stacker on the printer, load the roll paper you will use and check that "Ready to print" is displayed on the Display Screen. (See "Loading Rolls in the Printer.") → P.345

1 Turn the printer on.

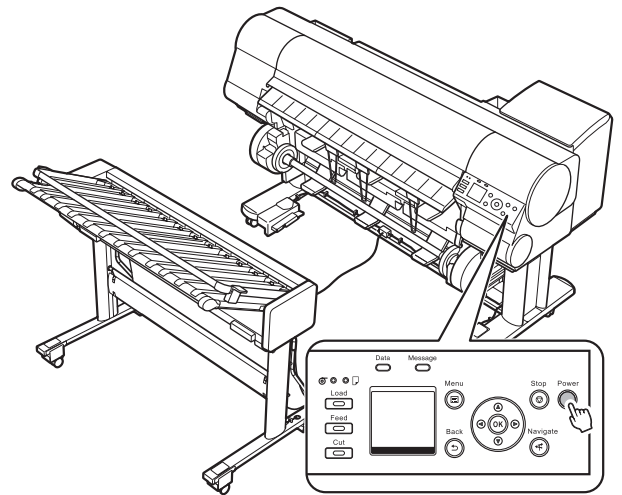

2 Check that the Stacker Canopy (a) and Output Stacker (b) are closed, and then unlock all of the casters on the stacker stand.

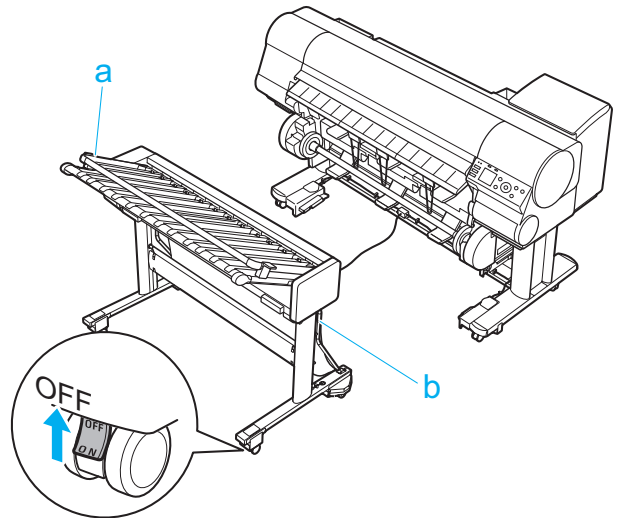

3 Hold the Stacker outer frame (c) and move the Stacker so that the triangle markings (a) on the left and right side of the Stacker stand are aligned with the sides (b) of the front face of the Docking unit left and Docking unit right.

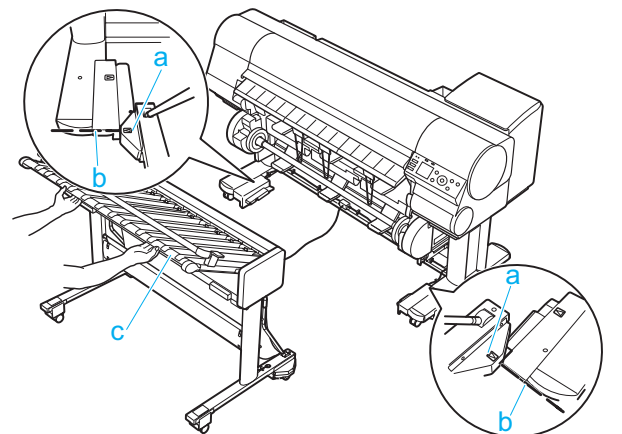

Caution Do not move the Stacker by holding at positions other than the specified ones. Moving it by holding at other positions may cause injuries or damage the stacker.

Important Before moving the Stacker, clear away all of the paper contained in the stacker. If you move the Stacker while it still contains paper, the printed documents may become scratched.

4 Hold the Stacker outer frame (c) and push the Stacker straight in towards the printer so that the triangle markings (a) on the left and right side of the Stacker stand are aligned with the points of the triangle markings (b) on the Docking unit left and Docking unit right.

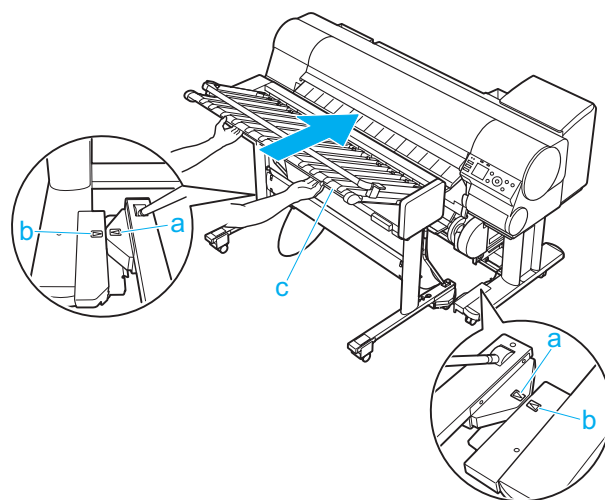

Important • Always push the Stacker in straight. If you do not push it in straight, the printer or stacker may be damaged.

5 Turn the Stacker on and check that both of the lamps on the Stacker are lit. If only one of the lamps on the Stacker is lit, the Stacker might not be installed correctly on the printer. Check that the Stacker is installed at the correct position in step 4.

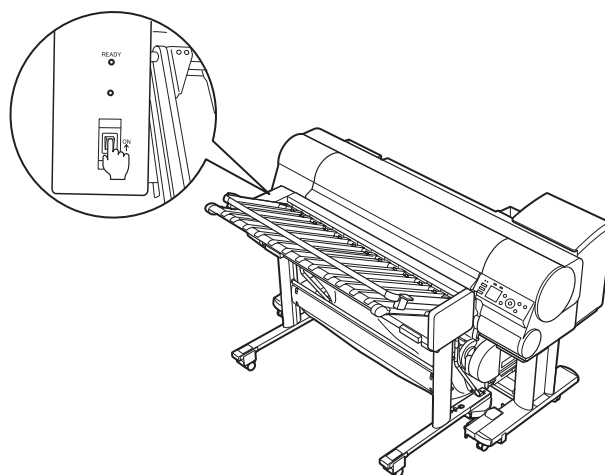

6 Lock the two front casters on the Stacker stand.

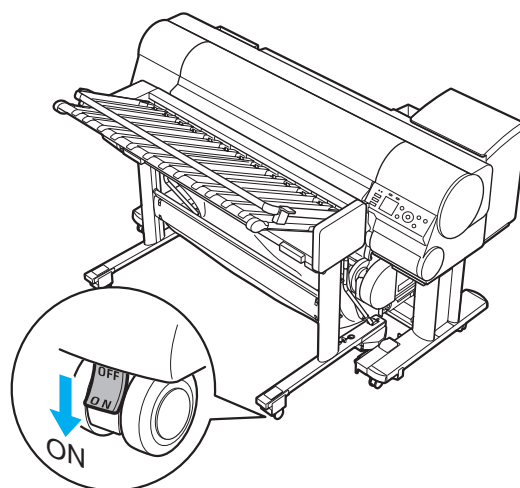

Removing the Stacker From the Printer

If the Stacker is installed on the printer when paper is loaded in the printer or when ejecting to the Output Stacker, remove the Stacker from the printer using the following procedure.

- 1 Turn the Stacker off.

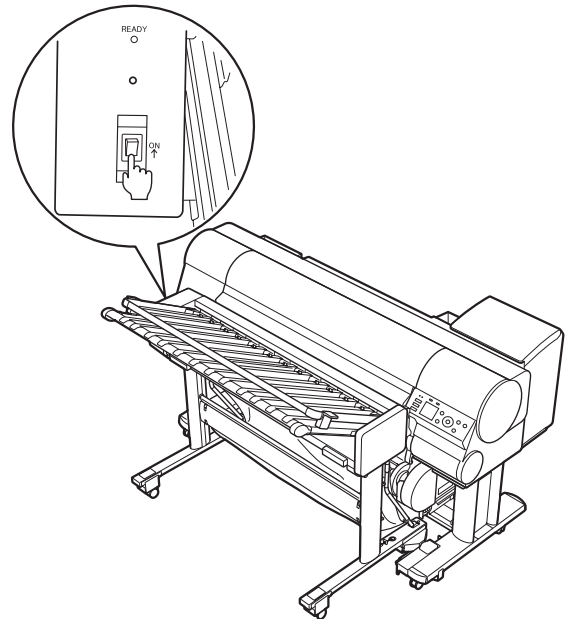

- 2 Check that the Stacker Canopy (a) is closed, and then unlock all of the casters on the Stacker stand.

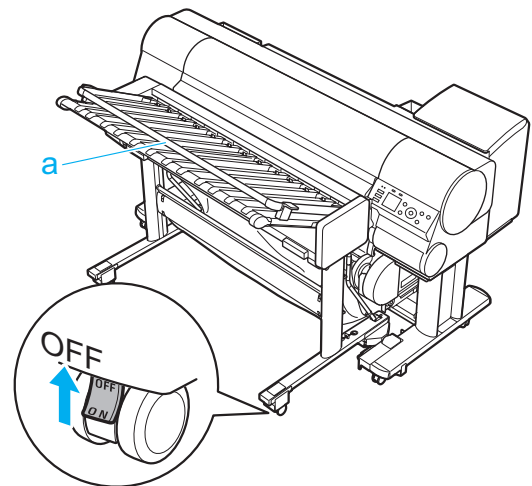

- If the Stacker contains printed documents, open the Canopy and clear away all of the printed documents, then close the Canopy. If you move the Stacker while it still contains paper, the printed documents may become scratched or misaligned and the next ejection may not be performed properly.

- 3 Holding the Stacker outer frame (a), pull the Stacker and remove it away from the printer.

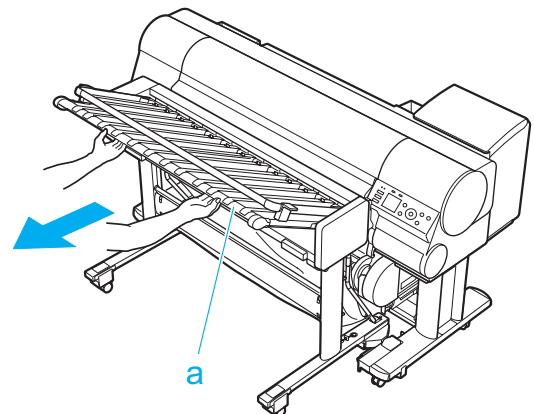



- Do not move the Stacker by holding at positions other than the specified ones. Moving it by holding at other positions may cause injuries or damage the stacker.



- If you move the Stacker too far away from the printer, the Stacker cable may become unplugged from the connector. If the stacker cable becomes disconnected, turn off the printer and then connect the Stacker cable to the connector and turn the printer back on again.

Ejecting to the Stacker



- When ejecting to the Stacker, do not print using the following settings. These can cause paper jams.
 - Borderless printing
 - Trim Edge First is **On(Input Length)**, **On (Preset Len)**, or **Automatic**
 - TrimEdge Reload is **On** or **Automatic**
- Do not use the Stacker for printing that takes a long time, such as banner printing. This can cause paper jams, because the rollers that feed the paper stop rotating after a fixed time after paper is detected in the Stacker.



- For information on paper that is supported for ejecting to the Stacker, refer to the Paper Reference Guide. (See "Displaying the Paper Reference Guide.") →P.335
The operation may not function correctly for paper not listed here.
- The Stacker can hold 100 sheets of A0 size. (When the AutoCAD LT2004 sample image Cottage Plan and Elevation.dwg was printed)

1 Install the Stacker on the printer. (See "Installing and Removing the Stacker On the Printer.") →P.376

2 Start printing on roll paper.



- Do not put your hand, etc. in the paper ejection path during printing. This may cause injuries or damage the stacker.



- Do not open the Canopy during printing.

3 Open the Canopy and remove the printed documents after the printing has finished.

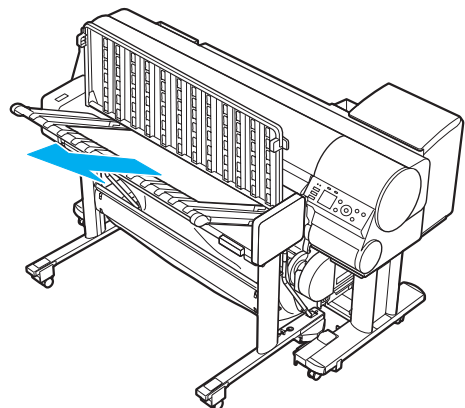

- Do not put your hand into the base part of the Canopy or the paper feed path when you open or close the Canopy. Your hand may get caught, causing injuries or damaging the Stacker.



- The Stacker Canopy may become difficult to open depending on how it is stored. If this happens, have two people hold the handles on the left and right side of the Canopy and open the left and right sides simultaneously while ensuring that the Canopy does not bend.
- When removing printed documents, remove them all at once so that there is no printed document left in the Stacker. Once removed, do not return the printed documents back into the Stacker. If there are any printed documents misaligned from the ejected position, the next ejection may not be performed properly.
- Remove printed documents after opening the Canopy. If you attempt to remove them while closed, the printed documents may become scratched.

Ejecting to the Output Stacker

- 1** Remove the Stacker from the printer. (See "Installing and Removing the Stacker On the Printer.") → P.376
- 2** Go between the Stacker and the printer and open the Output Stacker.

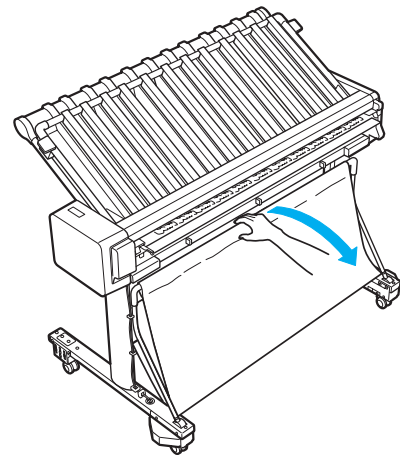

- 3** Grasp the Stacker outer frame (a) and push the Stacker straight until the Ejection Support (b) touches the end of the Output Stacker.

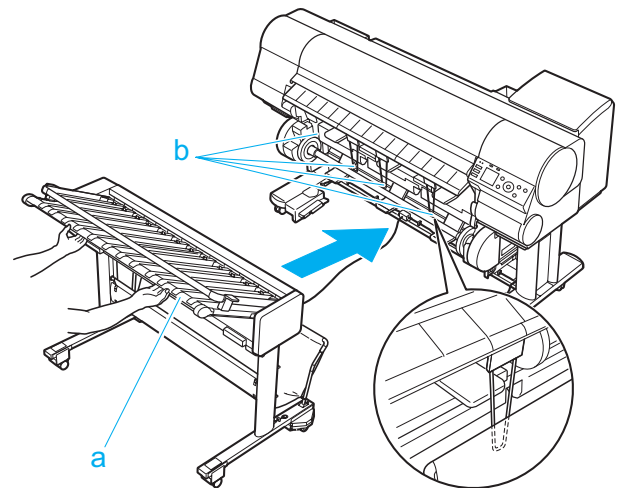

4 Lift up the Ejection Guide (b) until the Ejection Support (a) tip is at a higher position than the Output Stacker tip, and then lower it again. The Ejection Support is moved in front of the Output Stacker tip.

This completes the preparation for ejecting to the output stacker. Start printing.

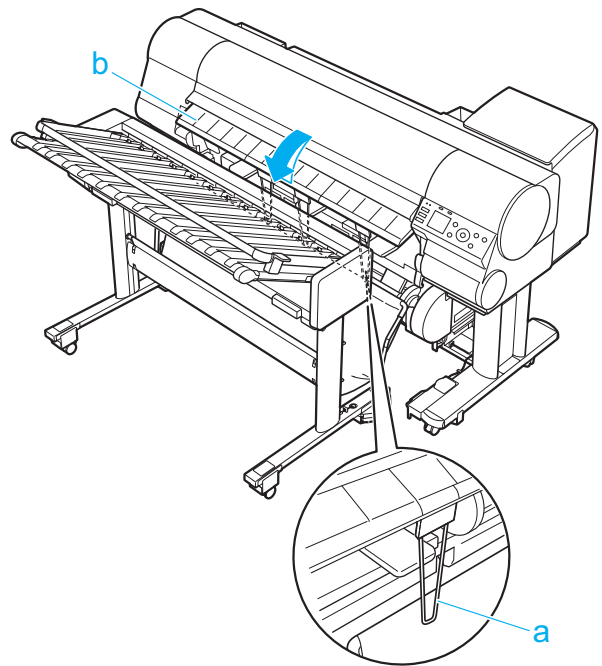

Important

- When lifting up the Ejection Guide, lift it up slowly. If you lift it up too vigorously, the Ejection Guide may strike the Top Cover, damaging the printer.
- Do not leave printed documents in the stacker for a long period of time. This may cause uneven colors of the printed documents, etc.
- Close the Output Stacker when you are not using the Output Stacker. If you install it on the Stacker while the Output Stacker is open, the Output Stacker will touch the printer and may cause damage.
- Depending on the type of paper, the edge may curl or bend during ejection. In this case, straighten out the paper. If the paper is curled or bent, it may damage printed documents.
- Store the Output Stacker when printing long documents such as banners. It is recommended that you spread a clean cloth or paper on the floor and select **Eject** as the method for cutting roll paper to prevent that printing from becoming soiled or scratched. (See "Specifying the Cutting Method for Rolls.") → P.360

Media Configuration Tool (Windows)

The Features of Media Configuration Tool	383
Installation Procedures	383
Updating Media Information After Installation	385
Media Configuration Tool Main Window	389
Editing Media Type Information for Genuine Paper and Feed Confirmed Paper	390
Adding Media Types	391
Changing Media Names	395
Deleting Media Types You Have Added	397
Switching Media Types Display Show/Hide	399
Changing the Display Order of Media Types	401
Applying a Saved Media Information File on Another Computer	403
Checking the update	404

The Features of Media Configuration Tool

In imagePROGRAF, the best printer settings for each paper are collected together in media information files in order to give the highest quality printing results. Settings for Canon genuine paper and Canon feed confirmed paper are provided by Canon in these media information files.



Note

- Canon genuine paper and Canon feed confirmed paper are detailed in the Paper Reference Guide.

Using the Media Configuration Tool allows you to do the following.

- When new paper supported by the printer is added, the media information file can be automatically downloaded from the Canon website and the new media information can be added to the printer control panel and printer driver.
- You can rearrange lists of the types of paper on the printer control panel and in printer driver dialog boxes and rename them, in addition to other functions.



Important

- Normally, when the printer driver is installed from the User Software CD-ROM, the Media Configuration Tool is also installed and the media information is also configured. Use this software if you are not using the User Software CD-ROM, or to add new media information or edit existing media information.
- Administration of paper information using the Media Configuration Tool should be performed by the printer administrator.
- A computer that is connected to the Internet is required in order to download the media information file from the website.

Drivers Applicable with Media Configuration Tool

- imagePROGRAF Printer Driver

Installation Procedures

The procedure for installing the Media Configuration Tool is as follows.



Important

- When you install the printer driver from the User Software CD-ROM, the Media Configuration Tool is also installed and the media information is also configured. The following procedure is therefore not normally needed. Perform the following procedure if you are installing the Media Configuration Tool without using the User Software CD-ROM, such as by downloading the latest version of the Media Configuration Tool from the Canon website.
- You must be logged in as Administrator when installing software in Windows.

1 Start the Media Configuration Tool installer. Click the **Next** button.

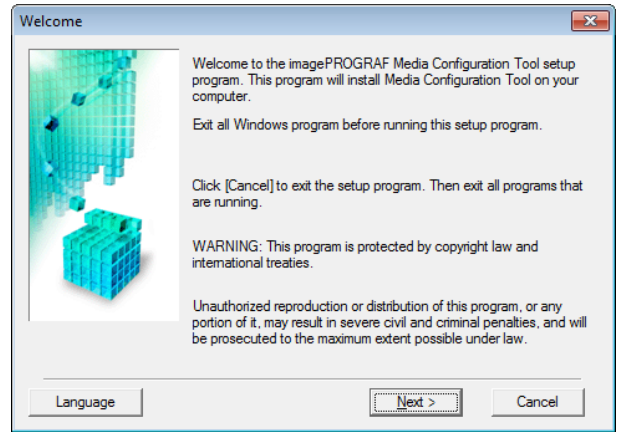

2 The next screen presents selections for the country or area where the printer is used. Select a country or territory then click the **Next** button.

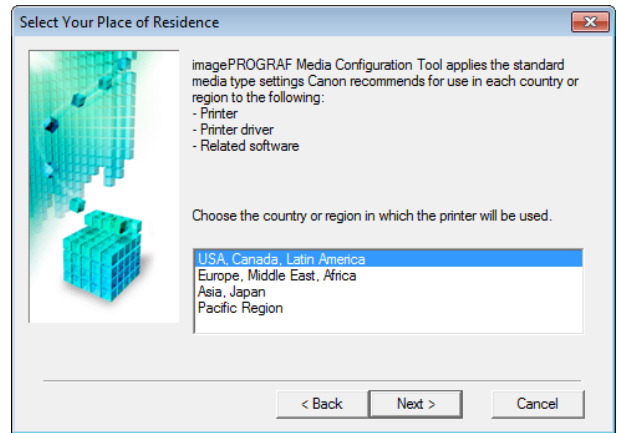

3 The **License Agreement** is displayed. If you accept the agreement, click **Yes**.

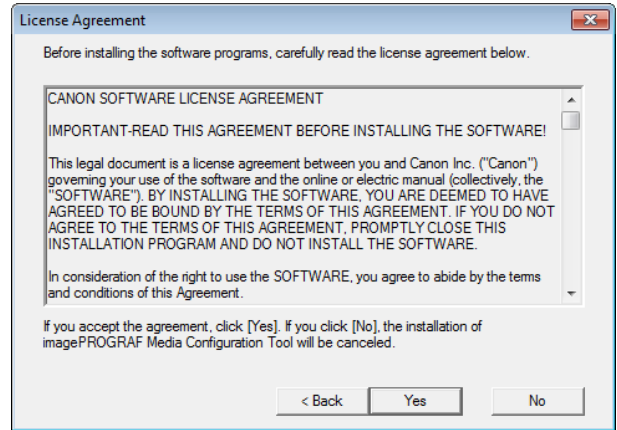

4 The **Change Installation Location** screen appears. Select the destination folder then click the **Next** button.

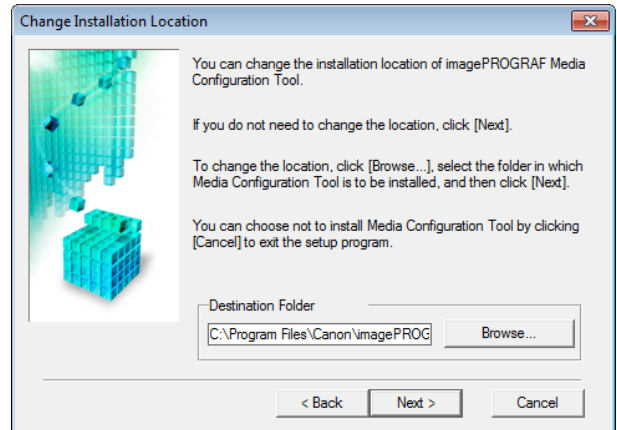

- 5** The **Installation Complete** screen appears. Click the **Finish** button.

This completes the installation of Media Configuration Tool.

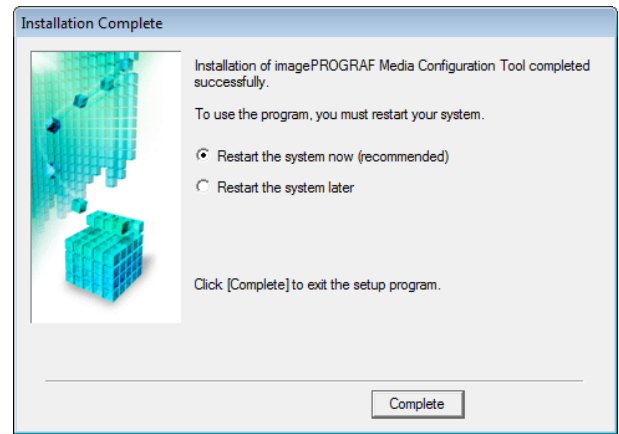

- After the installation is finished, update the media information by referring to **Updating Media Information After Installation** → P.385 .

Updating Media Information After Installation

If you are running the Media Configuration Tool for the first time after installing it, you need to configure the media information in the printer control panel and printer driver.



- You do not need to perform this procedure if you installed the printer driver using the User Software CD-ROM.
- Do not attempt to print or turn the printer off while the program is communicating with the printer.

- 1** From the **start** menu, select **All Programs > imagePROGRAF Media Configuration Tool > imagePROGRAF Media Configuration Tool**.

- 2** The **Select Printer** dialog box is displayed. Select the printer for which to configure the media information, and then click the **Next** button.

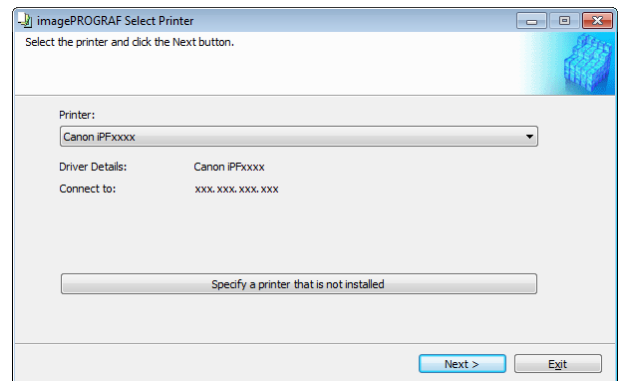

- If you are using the printer without installing the printer driver, click the **Specify a printer that is not installed** button and specify the printer by following the on-screen instructions.
- In the following screens, you cannot change the printer where media type information is to be updated.

- 3** The **Add Media Type** dialog box is displayed. Make sure that **Connect to the Internet to get the latest information** is selected, and then click the **OK** button. The latest media information file is downloaded from the Internet.

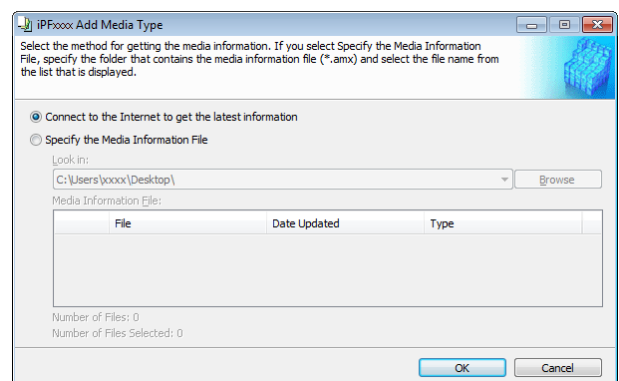



- If the main window is displayed at this time, it means that the media information has already been updated and the rest of the operation is not needed.



- If the message on the right is displayed, the media information file cannot be downloaded automatically from the Internet. Configure the settings by referring to **If the Media Information File Does Not Download Automatically From the Internet** → P.387 .

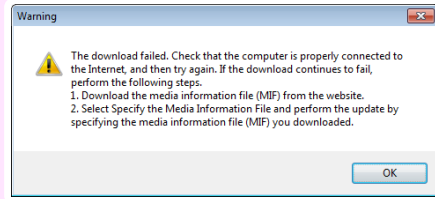

4 The **Media Configuration Tool** main window is displayed. Click the **Add Genuine Paper** button.

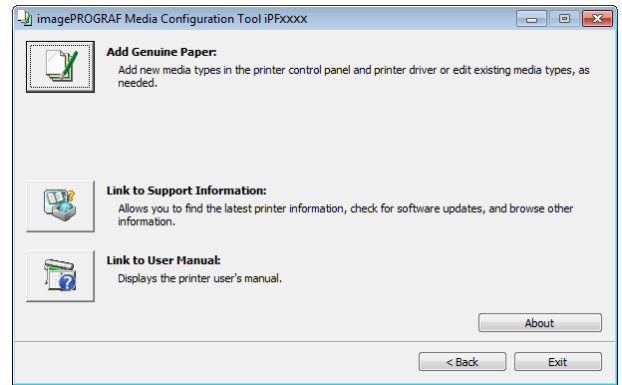

5 In the **Edit Media Types** dialog box, click the **Update** button.

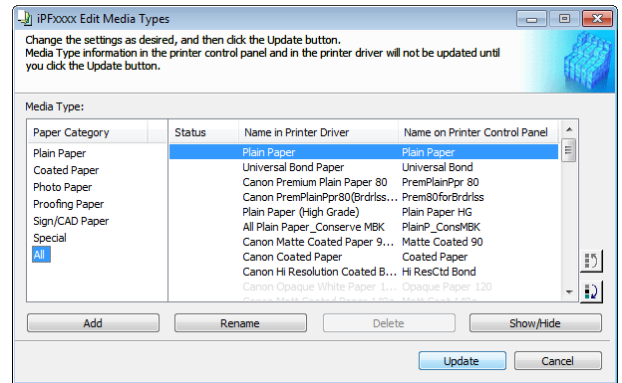

6 The **Confirm Update** dialog box is displayed. Configure **Update Target** and click the **Execute** button. The printer control panel and printer driver media information is updated.

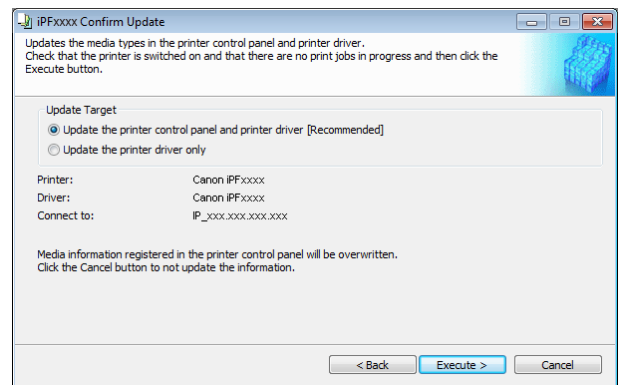

- You should normally select **Update the printer control panel and printer driver**.

- 7** The message on the right is displayed. If you want to save the current media information in a file, click the **Yes** button. If you do not want to save it, click the **No** button.

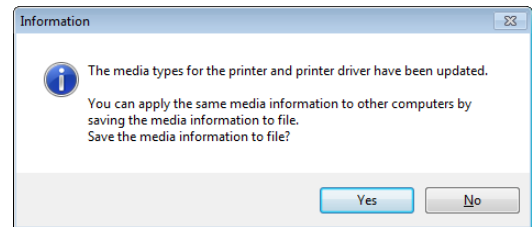

Note

- The media information is saved as a media information file (.amx file).
- For the method for loading a saved media information file in another computer, see "Applying a Saved Media Information File on Another Computer." → P.403

If the Media Information File Does Not Download Automatically From the Internet

If the following message is displayed, configure the settings by using the following procedure.

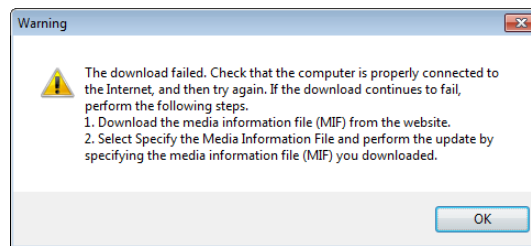

- 1 Open a web browser on a computer that can access the Internet, and access the Canon website.
- 2 Download the media information file (.amx file) corresponding to the printer to update from the Canon website.
- 3 Copy the downloaded media information file (.amx file) to the computer where the Media Configuration Tool is installed.
- 4 Run the Media Configuration Tool, then select **Specify the Media Information File** and click the **Browse** button in the **Add Media Type** dialog box.

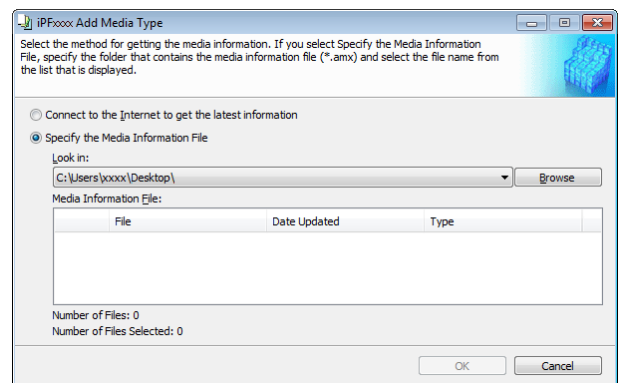

5 Select the folder that contains the media information file (.amx file) you downloaded and click the **OK** button.

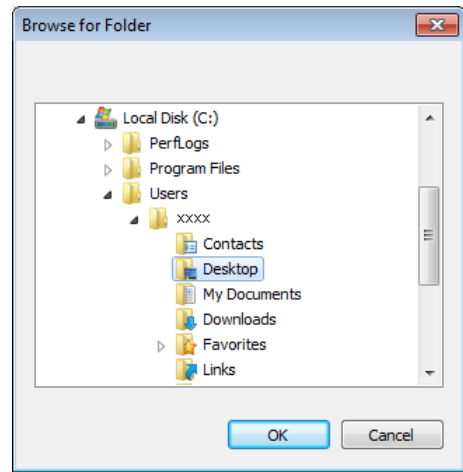

6 The names of the media information files contained in the selected folder are displayed in the **Media Information File** field in the **Add Media Type** dialog box. Select the check box for the media information file name and click the **OK** button.

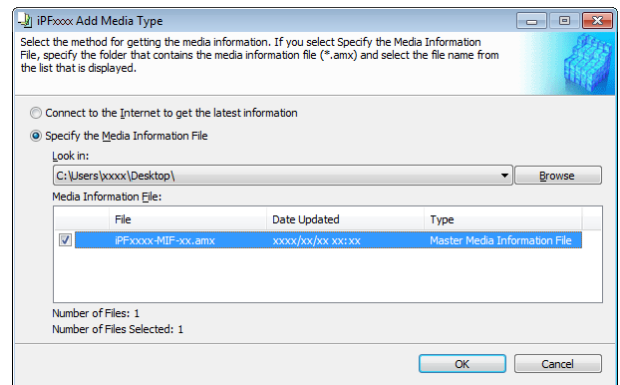

7 The Media Configuration Tool main window is displayed. Click the **Add Genuine Paper** button.

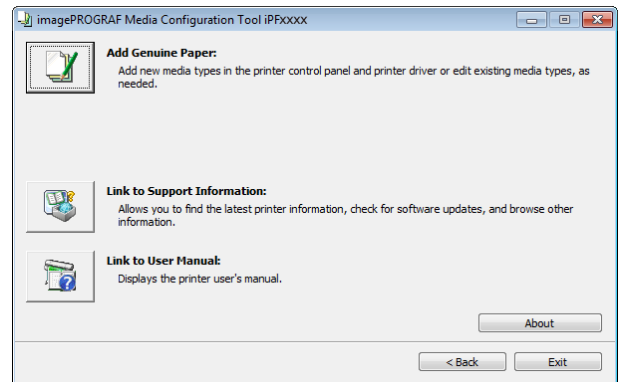

8 In the **Edit Media Types** dialog box, click the **Update** button.

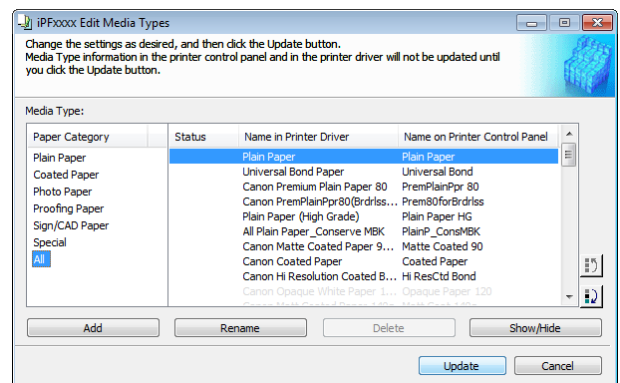

- 9** The **Confirm Update** dialog box is displayed. Configure Update Target and click the **Execute** button. The printer control panel and printer driver media information is updated.

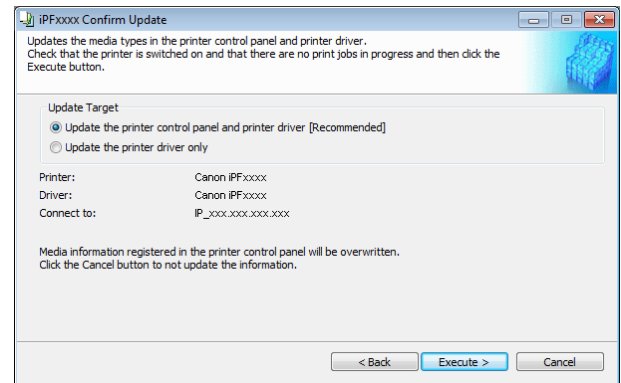

Note

- You should normally select **Update the printer control panel and printer driver**.

- 10** The message on the right is displayed. If you want to save the current media information in a file, click the **Yes** button. If you do not want to save it, click the **No** button.

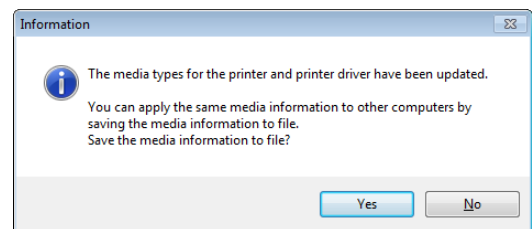

Note

- The media information is saved as a media information file (.amx file).
- For the method for loading a saved media information file in another computer, see "Applying a Saved Media Information File on Another Computer." → P.403

Media Configuration Tool Main Window

The explanation below is on the Media Configuration Tool main window. Use the following procedure to open Media Configuration Tool main window.



Important

- Do not attempt to print or turn the printer off while the program is communicating with the printer.

- 1** From the **start** menu, select **All Programs > imagePROGRAF Media Configuration Tool > imagePROGRAF Media Configuration Tool**.

- 2** The **Select Printer** dialog box is displayed. Select the printer for which to configure the media information, and then click the **Next** button.

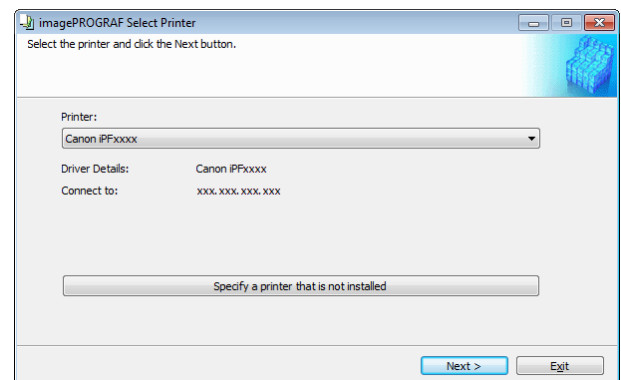

Note

- If you are using the printer without installing the printer driver, click the **Specify a printer that is not installed** button and specify the printer by following the on-screen instructions.
- In the following screens, you cannot change the printer where media type information is to be updated.

The Media Configuration Tool main window is displayed.

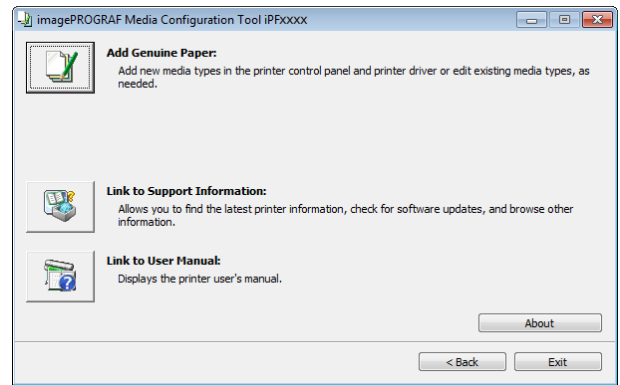

• If the **Add Media Type** dialog box is displayed at this point without the main window appearing, configure the setting by referring to **Updating Media Information After Installation** → P.385 .

• **Add Genuine Paper** button

When this button is clicked, the **Edit Media Types** dialog box is displayed, which allows you to add media information files released by Canon to the printer control panel and printer driver. You can also change names, toggle between displaying and hiding, and delete added media types.

You can also change the display order of the paper types.

Refer to "Editing Media Type Information for Genuine Paper and Feed Confirmed Paper" → P.390 for details on **Add Genuine Paper**.

• **Link to Support Information** button

You can check information such as the latest information for the product and software version upgrade information.

• **Link to User Manual** Button

Displays the printer user's manual

Editing Media Type Information for Genuine Paper and Feed Confirmed Paper

When adding genuine paper and feed confirmed paper to the printer control panel and printer driver and when editing media type information, click the **Add Genuine Paper** button in the Media Configuration Tool main window to open the **Edit Media Types** dialog box.

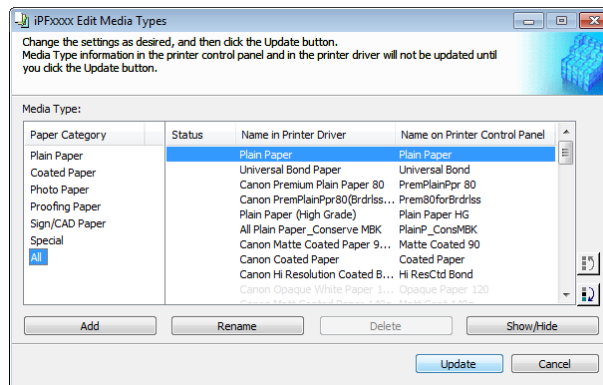

- For more information on the procedure for opening the Media Configuration Tool main window, see "Media Configuration Tool Main Window." → P.389
- Paper that is displayed grayed out does not appear in the printer driver or printer control panel.

• **Add** Button

To add genuine paper or feed confirmed paper to the printer control panel and printer driver, click this button. For details on the procedure for adding media types, see "Adding Media Types." → P.391

• **Rename Button**

To change the name on the printer control panel and the name in the printer driver for genuine paper and feed confirmed paper, select the paper to change and click this button.

For details on the procedure for changing paper display names, see "Changing Media Names." →P.395

• **Delete Button**



To delete added genuine paper and feed confirmed paper from the printer control panel and printer driver, select the paper to delete and click this button.

For details on the procedure for deleting added media types, see "Deleting Media Types You Have Added." →P.397

• **Show/Hide Button**

To change whether or not genuine paper or feed confirmed paper is displayed in the printer control panel and printer driver, select the paper to change and click this button.

For details on the procedure for changing whether or not to display media types, see "Switching Media Types Display Show/Hide." →P.399

• **Change Display Order button** ( or )

To change the display order of a media type in the printer control panel and printer driver, select the paper to change and click this button.

For details on the procedure for changing the display order of media types, see "Changing the Display Order of Media Types." →P.401

 **Important** • When you update the media type information, perform the same update on all of the PCs that are using that printer.

 **Note** • It may not be possible to deleting, showing/hiding, and changing the display order under some conditions.

Adding Media Types

You can register media information files (.amx file) released by Canon in the printer control panel and printer driver.

 **Important** • Do not attempt to print or turn the printer off while the program is communicating with the printer.
• When you apply a media information file, the media type display order and other settings return to their default values. Reconfigure these settings again after applying the media information file.

1 Click the **Add Genuine Paper** button in the Media Configuration Tool main window.

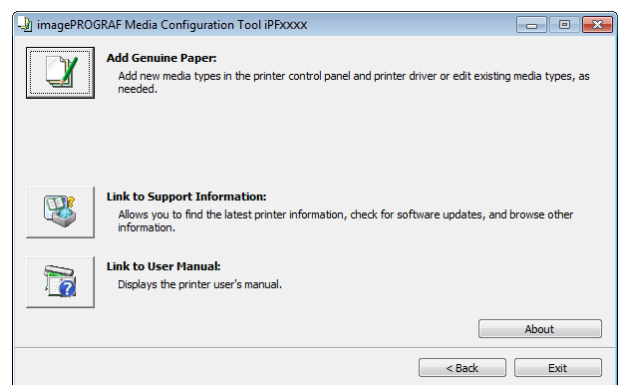

 **Note** • For more information on the procedure for opening the Media Configuration Tool main window, see "Media Configuration Tool Main Window." →P.389
• If the **Add Media Type** dialog box is displayed after you select the printer without the main window appearing, configure the setting by referring to **Updating Media Information After Installation** →P.385 .

When a newer version of media information file than the media information file that is applied to your printer driver is released on the Canon website, the message on the right is displayed. To update the media information, click the **OK** button.

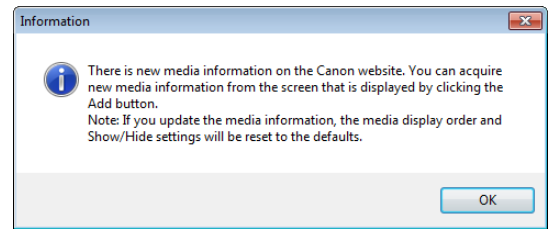

- When you update the media information, the paper display order and **Show/Hide** settings return to their default values.

2 The **Edit Media Types** dialog box is displayed. Click the **Add** button.

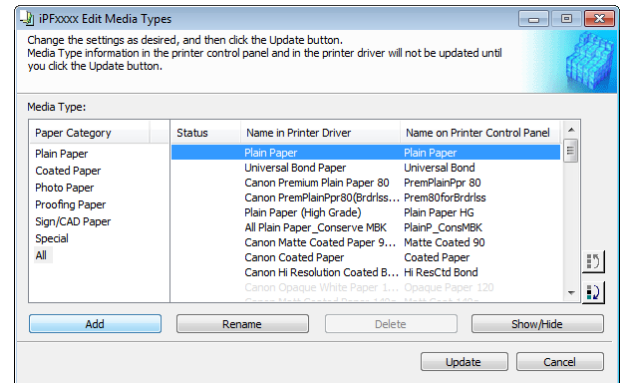

3 Make sure that **Connect to the Internet to get the latest information** is selected, and then click the **OK** button.

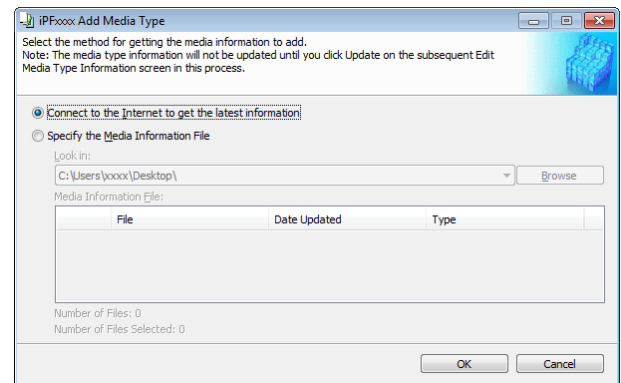

- When you update the media information, the paper display order and **Show/Hide** settings return to their default values.

- If the message on the right is displayed at this time, the latest media information is already applied to your printer driver. There is normally no need to update.

To exit without updating, click the **No** button. To continue with the update, click the **Yes** button.

- If the message on the right is displayed, the media information file cannot be downloaded automatically from the Internet. Configure the settings by referring to **If the Media Information File Does Not Download Automatically From the Internet** → P.393 .

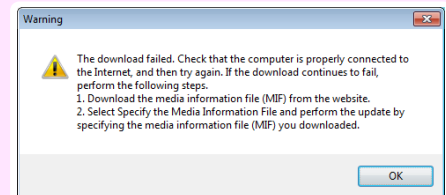
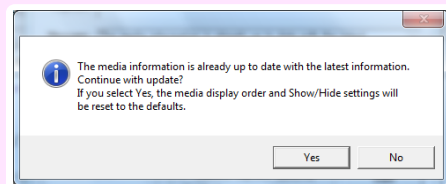

4 Click **OK** when the confirmation message is displayed.

5 In the **Edit Media Types** dialog box, click the **Update** button.

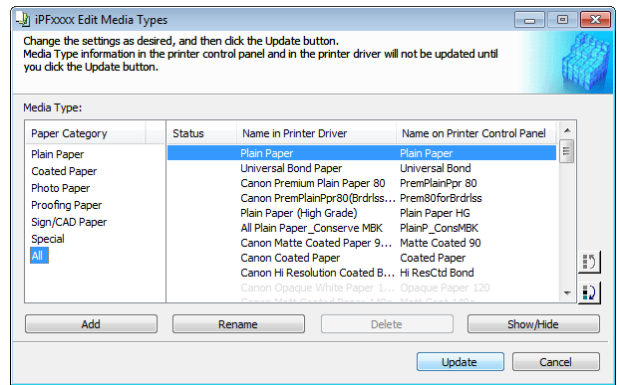

6 The **Confirm Update** dialog box is displayed. Configure **Update Target** and click the **Execute** button. The printer control panel and printer driver media information is updated.

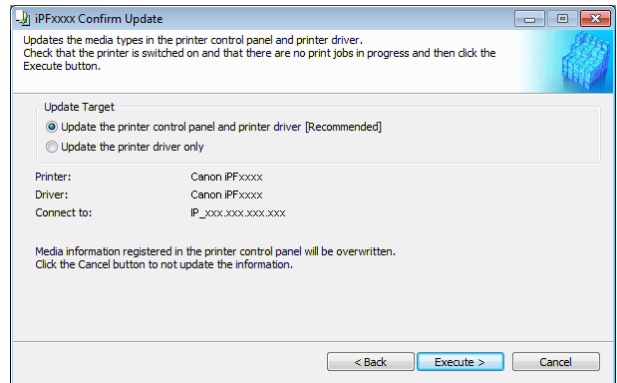

Note • You should normally select **Update the printer control panel and printer driver**.

7 The message on the right is displayed. If you want to save the current media information in a file, click the **Yes** button. If you do not want to save it, click the **No** button.

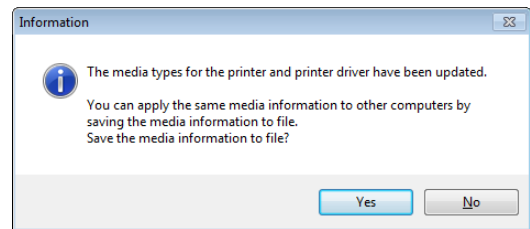

Note • The media information is saved as a media information file (.amx file).
 • For the method for loading a saved media information file in another computer, see "Applying a Saved Media Information File on Another Computer." → P.403

If the Media Information File Does Not Download Automatically From the Internet

If the following message is displayed, configure the settings by using the following procedure.

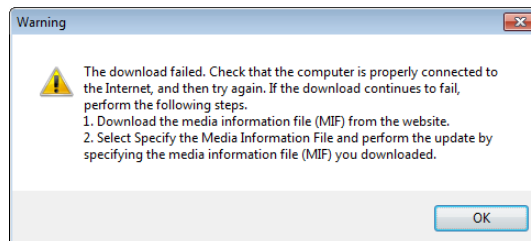

1 Open a web browser on a computer that can access the Internet, and access the Canon website.

2 Download the media information file (.amx file) corresponding to the printer to update from the Canon website.

- 3 Copy the downloaded media information file (.amx file) to the computer where the Media Configuration Tool is installed.
- 4 Run the Media Configuration Tool. Click the **Add Genuine Paper** button in the main window, and then click the **Add** button in the **Edit Media Types** dialog box.
- 5 Select **Specify the Media Information File** in the **Add Media Type** dialog box, and then click the **Browse** button.

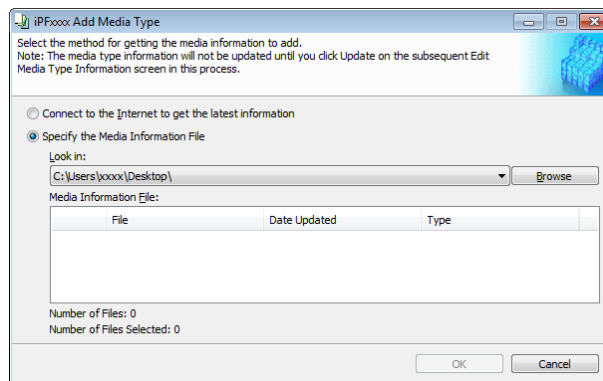

- 6 Select the folder that contains the media information file (.amx file) you downloaded and click the **OK** button.

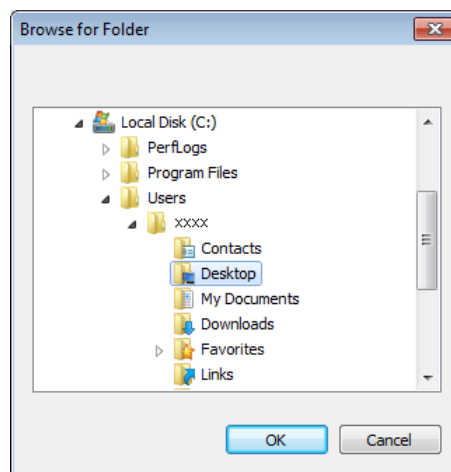

- 7 The names of the media information files contained in the selected folder are displayed in the **Media Information File** field in the **Add Media Type** dialog box. Select the check box for the media information file name and click the **OK** button.

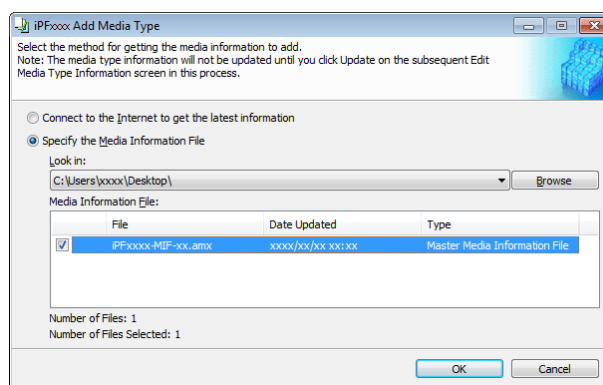

- 8 Click **OK** when the confirmation message is displayed.

9 In the **Edit Media Types** dialog box, click the **Update** button.

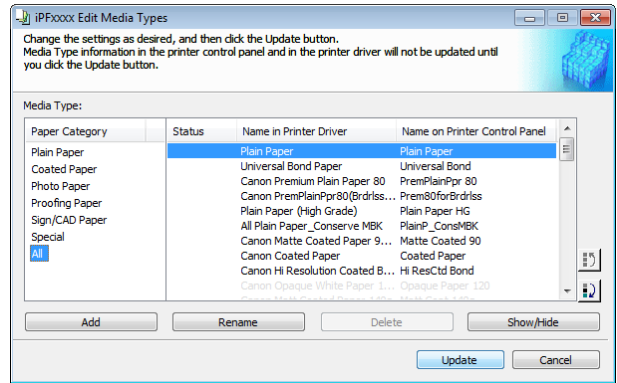

10 The **Confirm Update** dialog box is displayed. Configure **Update Target** and click the **Execute** button. The printer control panel and printer driver media information is updated.

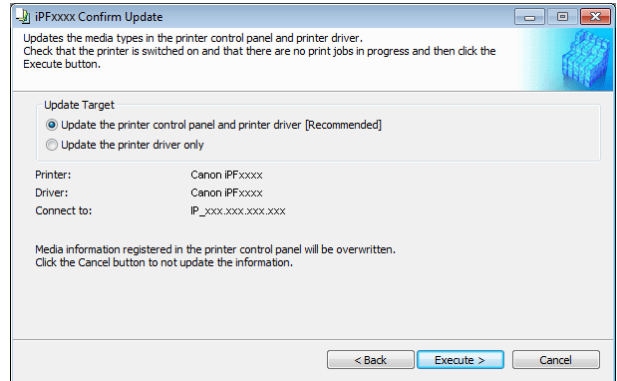

Note • You should normally select **Update the printer control panel and printer driver**.

11 The message on the right is displayed. If you want to save the current media information in a file, click the **Yes** button. If you do not want to save it, click the **No** button.

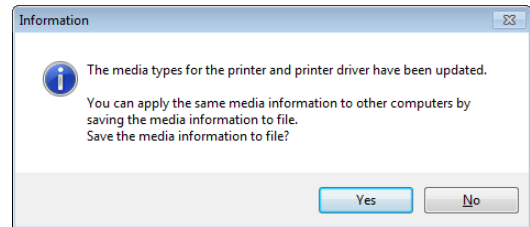

Note • The media information is saved as a media information file (.amx file).
 • For the method for loading a saved media information file in another computer, see "Applying a Saved Media Information File on Another Computer." → P.403

Changing Media Names

Important • Do not attempt to print or turn the printer off while the program is communicating with the printer.

1 Click the **Add Genuine Paper** button in the Media Configuration Tool main window.

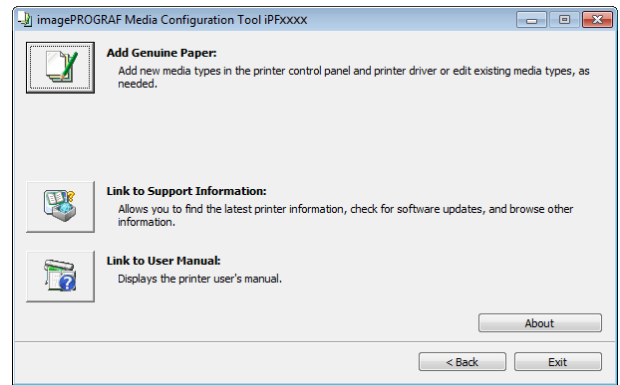

Note • For more information on the procedure for opening the Media Configuration Tool main window, see "Media Configuration Tool Main Window." → P.389

2 The **Edit Media Types** dialog box is displayed.

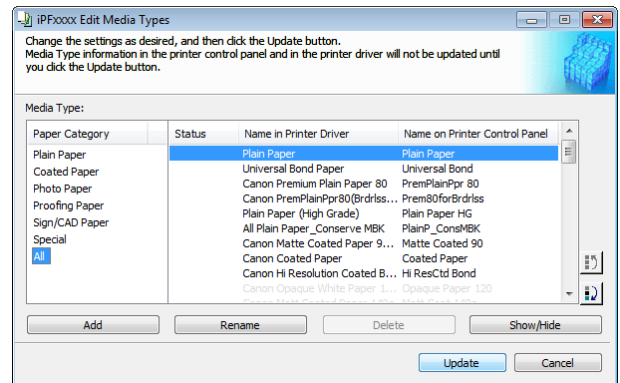

3 In the **Media Type** list, select the name to change. Click the **Rename** button.

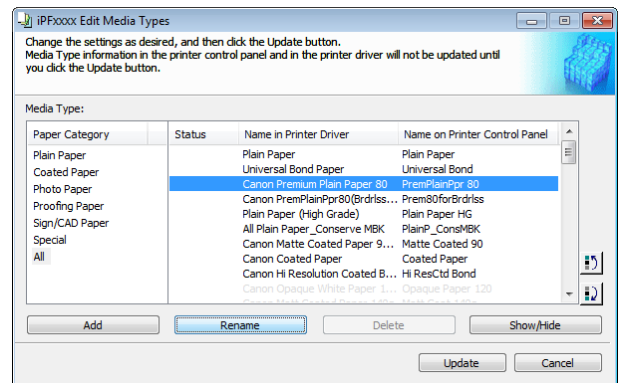

4 The **Rename Media** dialog box is displayed. Edit the names in **Name in Printer Driver** and **Name on Control Panel** and click the **OK** button.

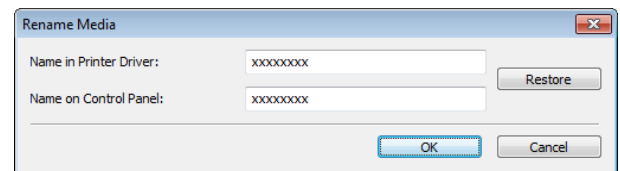

- To restore the original names, click the **Restore** button.
- The characters that can be entered for **Name in Printer Driver** and **Name on Control Panel** are stated below.
alphanumeric, space, "-", ".", "_", "(", ")", "+", "%", ",", "/"
- For **Name in Printer Driver** up to 32 one Byte characters can be entered, and for **Name on Control Panel** up to 16 one Byte characters can be entered.

5 In the **Edit Media Types** dialog box, click the **Update** button.

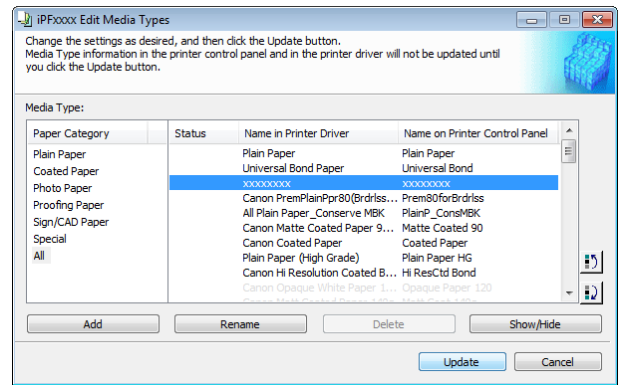

6 The **Confirm Update** dialog box is displayed. Configure **Update Target** and click the **Execute** button. The printer control panel and printer driver media information is updated.

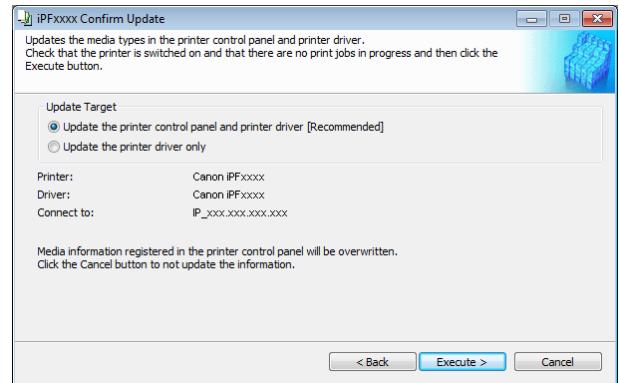

Note • You should normally select **Update the printer control panel and printer driver**.

Important • When setting a data to the printer that differs from the data to be updated, the selected media information file is updated. When you would like to remain the data that is set to the printer, click the **Cancel** button.

7 The message on the right is displayed. If you want to save the current media information in a file, click the **Yes** button. If you do not want to save it, click the **No** button.

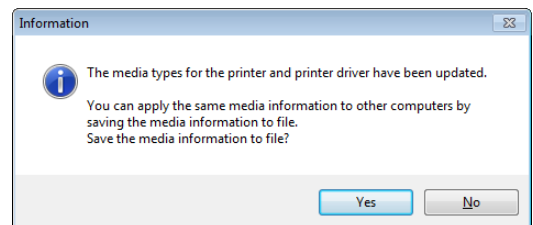

Note • The media information is saved as a media information file (.amx file).
 • For the method for loading a saved media information file in another computer, see "Applying a Saved Media Information File on Another Computer." → P.403

Deleting Media Types You Have Added

Important • Do not attempt to print or turn the printer off while the program is communicating with the printer.

1 Click the **Add Genuine Paper** button in the Media Configuration Tool main window.

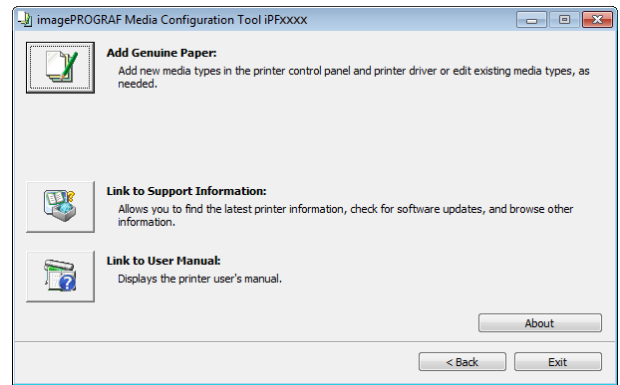

• For more information on the procedure for opening the Media Configuration Tool main window, see "Media Configuration Tool Main Window." → P.389

2 The **Edit Media Types** dialog box is displayed.

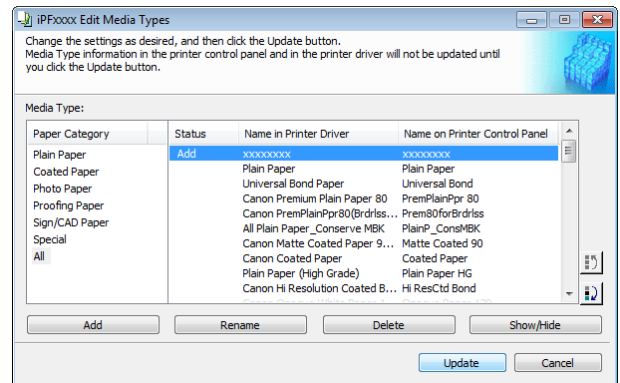

3 In the **Media Type** list, select the name of the media to delete. Click the **Delete** button.

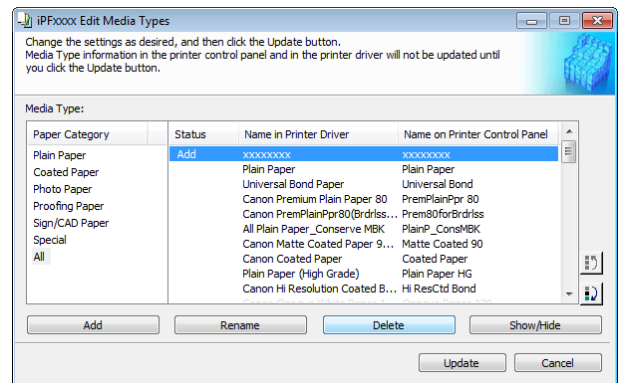

• Only paper for which **Status** in the **Media Type** is **Add** can be deleted.

4 In the **Edit Media Types** dialog box, click the **Update** button.

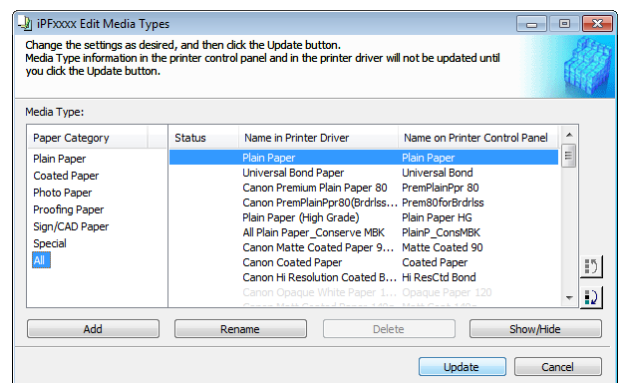

5 The **Confirm Update** dialog box is displayed. Configure Update Target and click the **Execute** button. The printer control panel and printer driver media information is updated.

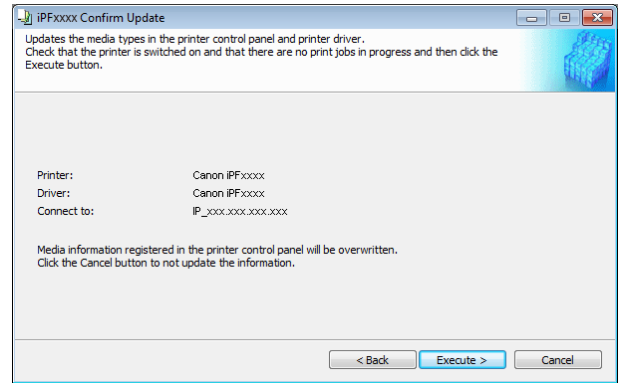

- When setting a data to the printer that differs from the data to be updated, the selected media information file is updated. When you would like to remain the data that is set to the printer, click the **Cancel** button.

6 The message on the right is displayed. If you want to save the current media information in a file, click the **Yes** button. If you do not want to save it, click the **No** button.

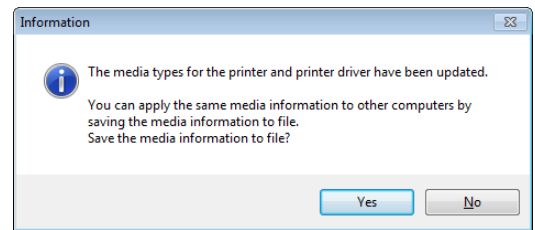

- The media information is saved as a media information file (.amx file).
- For the method for loading a saved media information file in another computer, see "Applying a Saved Media Information File on Another Computer." → P.403

Switching Media Types Display Show/Hide



- Do not attempt to print or turn the printer off while the program is communicating with the printer.

1 Click the **Add Genuine Paper** button in the Media Configuration Tool main window.

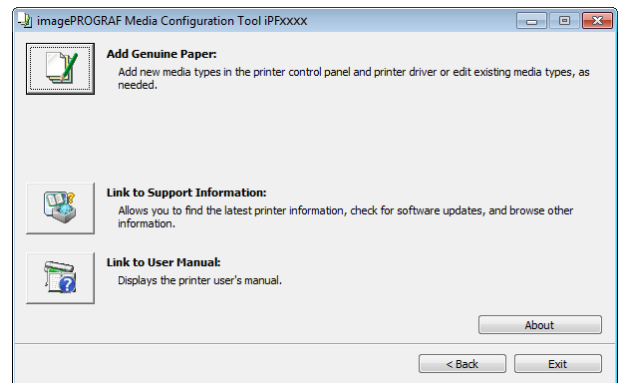

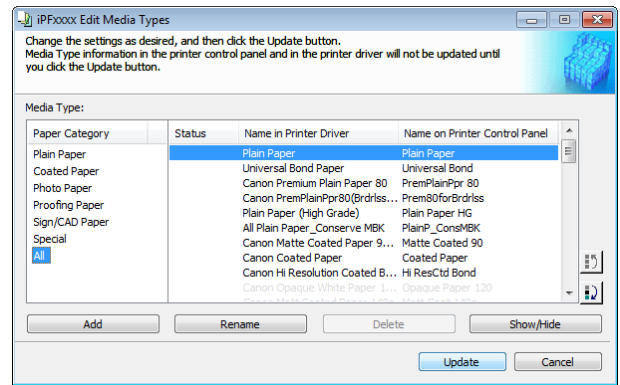

- For more information on the procedure for opening the Media Configuration Tool main window, see "Media Configuration Tool Main Window." → P.389

2 The **Edit Media Types** dialog box is displayed.

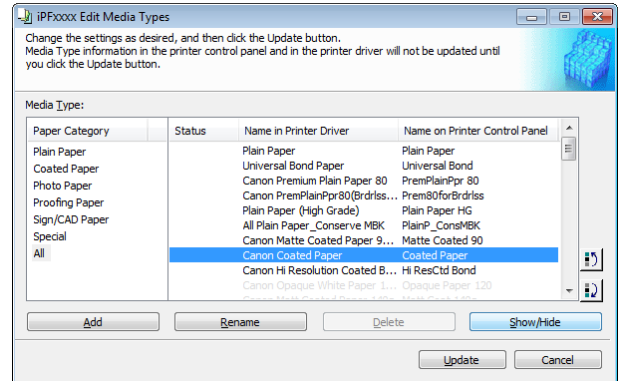

3 In the **Media Type** list, select the name of the media to switch off or on for display. Click the **Show/Hide** button. The selected paper is alternately shown or hidden.



-  **Note** • You can select multiple paper.
- The names of media switched for non-display appear grayed out in the **Media Type** list.
- Each time you click the **Show/Hide** button, the display mode cycles from showing both the printer driver and printer panel, to hiding both the printer driver and printer panel, and then to showing only the printer panel.

4 In the **Edit Media Types** dialog box, click the **Update** button.

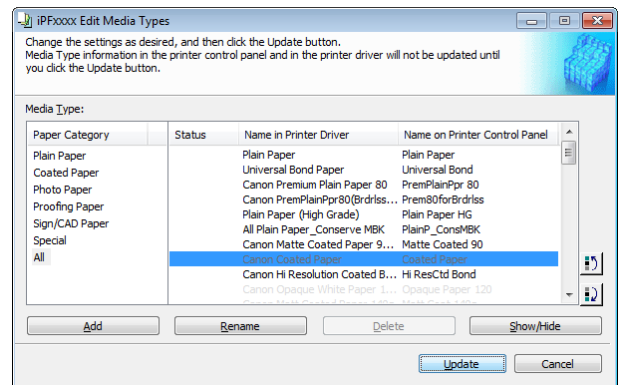

5 The **Confirm Update** dialog box is displayed. Configure Update Target and click the **Execute** button. The printer control panel and printer driver media information is updated.

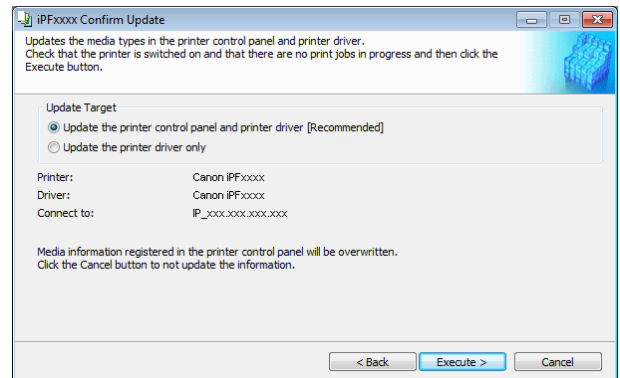



Note

- You should normally select **Update the printer control panel and printer driver**.



Important

- When setting a data to the printer that differs from the data to be updated, the selected media information file is updated. When you would like to remain the data that is set to the printer, click the **Cancel** button.

6

The message on the right is displayed. If you want to save the current media information in a file, click the **Yes** button. If you do not want to save it, click the **No** button.

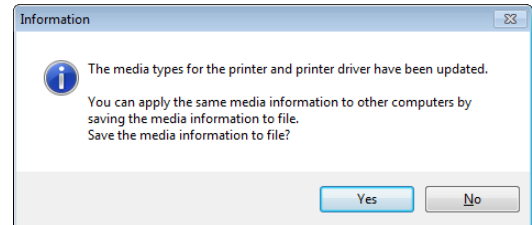

Note

- The media information is saved as a media information file (.amx file).
- For the method for loading a saved media information file in another computer, see "Applying a Saved Media Information File on Another Computer." → P.403

Changing the Display Order of Media Types



Important

- Do not attempt to print or turn the printer off while the program is communicating with the printer.

1

Click the **Add Genuine Paper** button in the Media Configuration Tool main window.

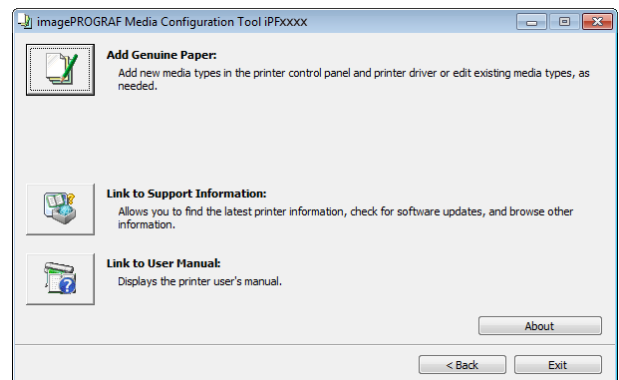



Note

- For more information on the procedure for opening the Media Configuration Tool main window, see "Media Configuration Tool Main Window." → P.389

2

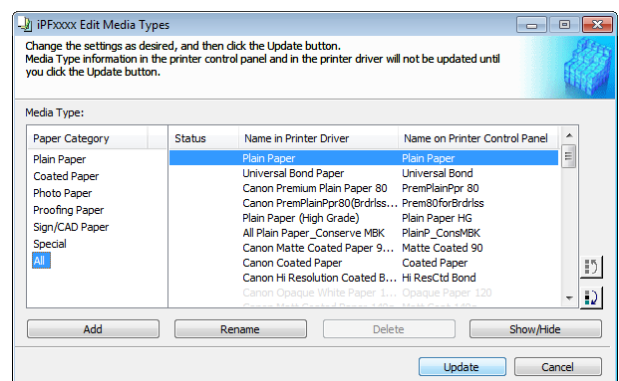
The **Edit Media Types** dialog box is displayed.



3 Select the paper in the **Media Type** list for which to change the display order, and then click the buttons to move the item ( or ).
The selected item moves one line up or down for every button click.

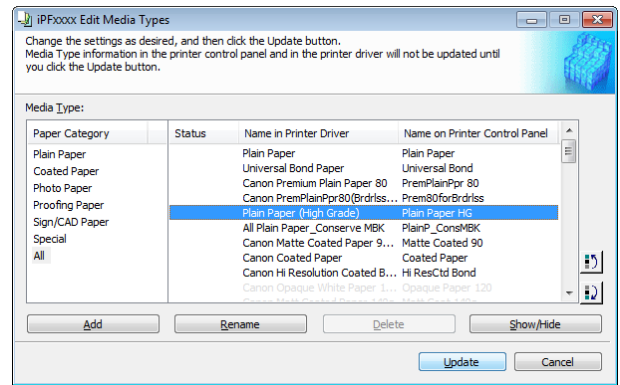

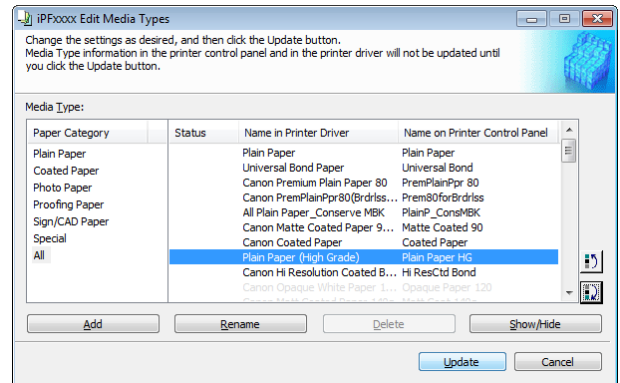

4 In the **Edit Media Types** dialog box, click the **Update** button.

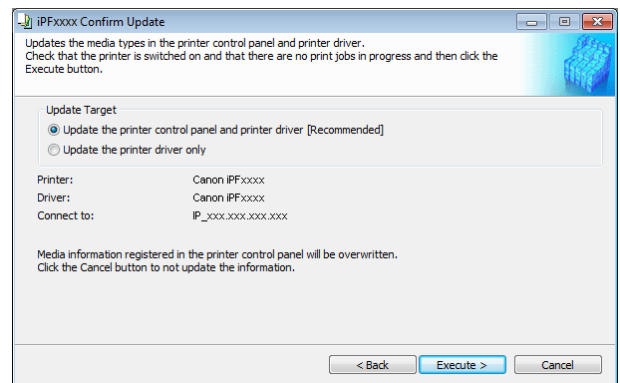

5 The **Confirm Update** dialog box is displayed. Configure **Update Target** and click the **Execute** button.
The printer control panel and printer driver media information is updated.



 **Note** • You should normally select **Update the printer control panel and printer driver**.

 **Important** • When setting a data to the printer that differs from the data to be updated, the selected media information file is updated. When you would like to remain the data that is set to the printer, click the **Cancel** button.

6 The message on the right is displayed. If you want to save the current media information in a file, click the **Yes** button. If you do not want to save it, click the **No** button.

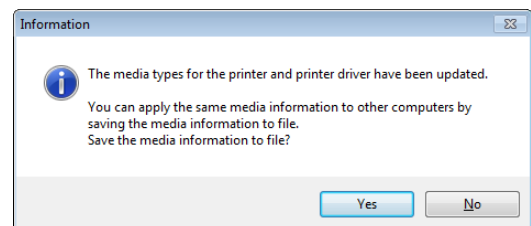

 **Note** • The media information is saved as a media information file (.amx file).
• For the method for loading a saved media information file in another computer, see "Applying a Saved Media Information File on Another Computer." → P.403

Applying a Saved Media Information File on Another Computer

You can import and use the media information file you saved from your computer on other printers and computer by using the following procedure.



Important

- Do not attempt to print or turn the printer off while the program is communicating with the printer.

1 Copy the saved media information file (.amx) onto the other computer.

2 Install and run the Media Configuration Tool on the other computer.

3 Select the printer in the **Select Printer** dialog box, and then click the **Next** button.



Note

- Select the printer model that matches the media information file you are attempting to import.

4 Select **Specify the Media Information File** in the **Add Media Type** dialog box, click the **Browse** button, and then specify the folder that contains the .amx file you copied.

Select the check box for the media information file name and click the **OK** button.

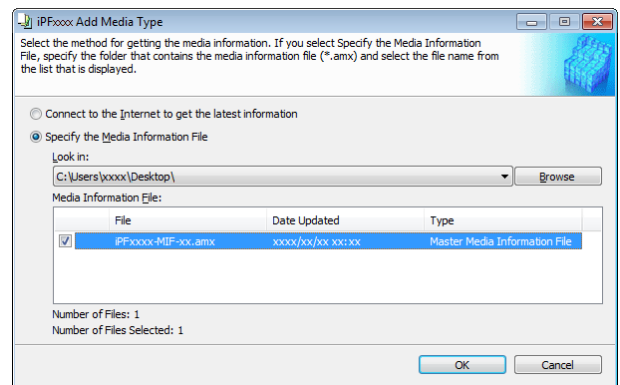

Note

- If the Media Configuration Tool main window is displayed at this time, click the **Add Genuine Paper** button, and then click the **Add** button on the screen that opens.

5 The Media Configuration Tool main window is displayed. Click the **Add Genuine Paper** button.

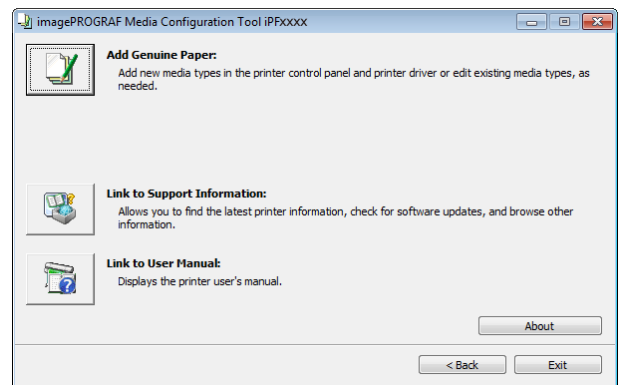

Note

- If the **Edit Media Types** dialog box is displayed without the main window appearing, proceed to the following step.

6 In the **Edit Media Types** dialog box, click the **Update** button.

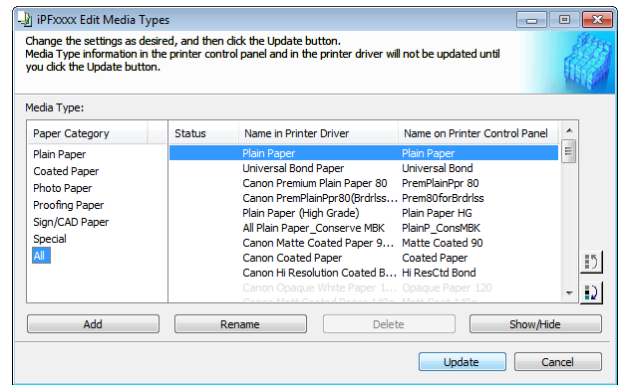

7 Configure Update Target and click the **Execute** button.

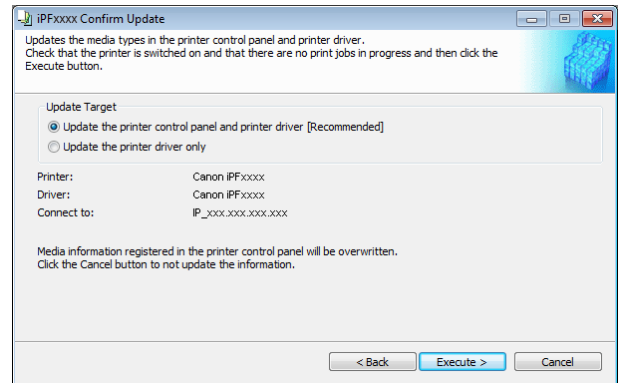

Checking the update

After updating the media information using the Media Configuration Tool, you can check whether the update has been applied to the printer in the control panel of the printer.

- 1** Click the **About** button in the Media Configuration Tool main window to open the **About** dialog box.
- 2** Check the value **xx.xx (xxxx)** of **MIT DB Version**.
- 3** Check the value **xx.xx (xxxx)** of **MIT** in **Set./Adj. Menu > Printer Info > System Info** in the printer control panel.
If the values in Steps 2 and 3 are the same, the update has been applied to the printer.

Media Configuration Tool (Mac OS)

The Features of Media Configuration Tool	405
Procedures for Installing	405
Updating Media Information After Installation	407
Media Configuration Tool Main Window	411
Editing Media Type Information for Genuine Paper and Feed Confirmed Paper	413
Adding Media Types	414
Changing Media Names	418
Deleting Media Types You Have Added	421
Switching Media Types Display Show/Hide	422
Changing the Display Order of Media Types	424
Applying a Saved Media Information File on Another Computer	426
Checking the update	428

The Features of Media Configuration Tool

In imagePROGRAF, the best printer settings for each paper are collected together in media information files in order to give the highest quality printing results. Settings for Canon genuine paper and Canon feed confirmed paper are provided by Canon in these media information files.



Note

- Canon genuine paper and Canon feed confirmed paper are detailed in the Paper Reference Guide.

Using the Media Configuration Tool allows you to do the following.

- When new paper supported by the printer is added, the media information file can be automatically downloaded from the Canon website and the new media information can be added to the printer control panel and printer driver.
- You can rearrange lists of the types of paper on the printer control panel and in printer driver dialog boxes and rename them, in addition to other functions.



Important

- Normally, when the printer driver is installed from the User Software CD-ROM, the Media Configuration Tool is also installed and the media information is also configured. Use this software if you are not using the User Software CD-ROM, or to add new media information or edit existing media information.
- Administration of paper information using the Media Configuration Tool should be performed by the printer administrator.
- A computer that is connected to the Internet is required in order to download the media information file from the website.

Drivers Applicable with Media Configuration Tool

- imagePROGRAF Printer Driver

Procedures for Installing

Start the installer in the new version of Media Configuration Tool, and follow procedures below to install the Media Configuration Tool.



Important

- When you install the printer driver from the User Software CD-ROM, the Media Configuration Tool is also installed and the media information is also configured. The following procedure is therefore not normally needed. Perform the following procedure if you are installing the Media Configuration Tool without using the User Software CD-ROM, such as by downloading the latest version of the Media Configuration Tool from the Canon website.

- 1 Double-click **Canon imagePROGRAF Media Configuration Tool.pkg** to start the Media Configuration Tool installer.

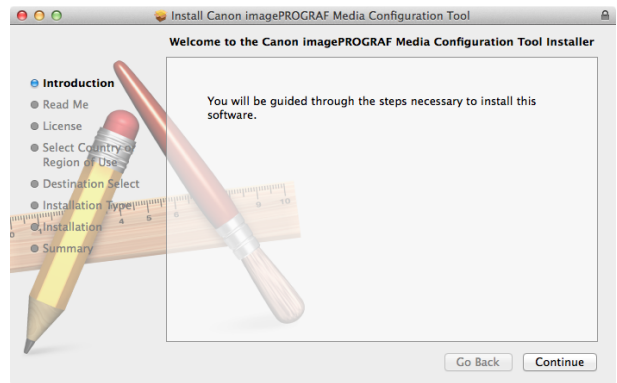

- 2 The **Software License Agreement** is displayed. After you have read Canon Software License Agreement, click the **Continue** button.

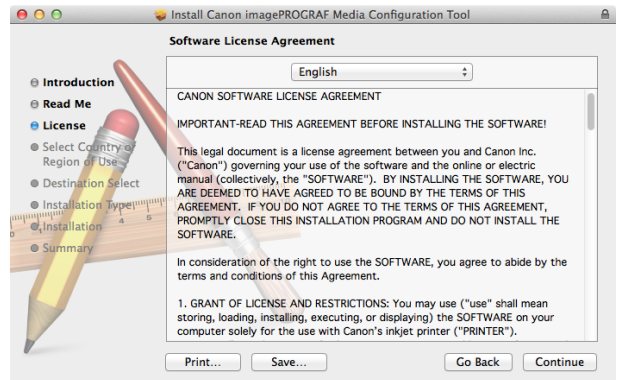

- 3 The next screen presents selections for the country or area where the printer is used. Select a country or territory then click the **Continue** button.

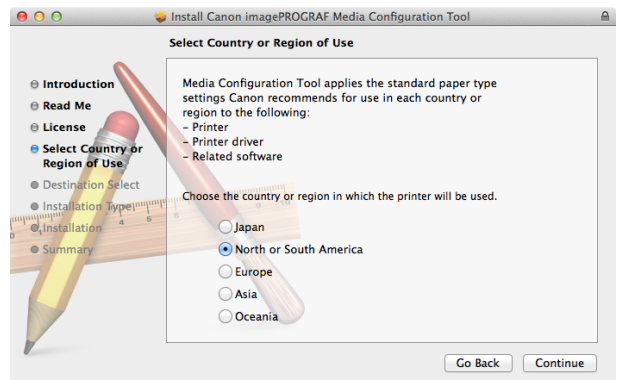

- 4 Click the **Install** button.

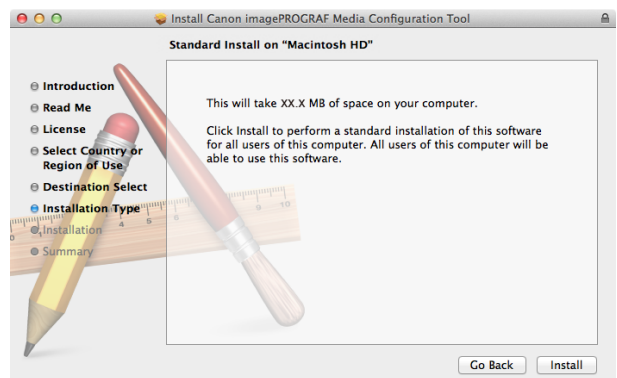

- 5** Enter an administrator name/password and click the **Install Software** button.



- 6** Click the **Close** button.

The installation of Media Configuration Tool is complete.

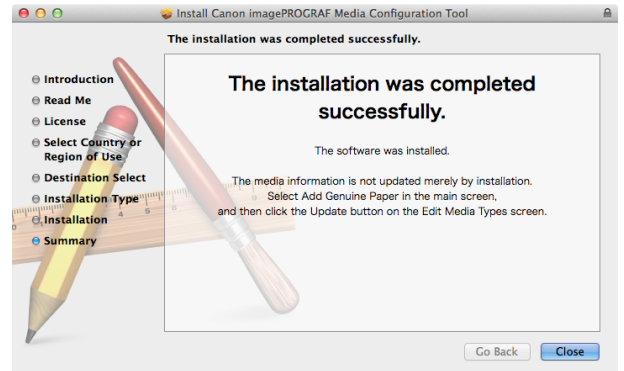

Note

- When the installation is completed properly, the Media Configuration Tool folder is saved in the following folder.
Applications > Canon Utilities > Media Configuration Tool



Important

- After the installation is finished, update the media information by referring to **Updating Media Information After Installation** → P.407 .

Updating Media Information After Installation

If you are running the Media Configuration Tool for the first time after installing it, you need to configure the media information in the printer control panel and printer driver.



Important

- You do not need to perform this procedure if you installed the printer driver using the User Software CD-ROM.
- Do not attempt to print or turn the printer off while the program is communicating with the printer.

- 1** From the **Applications** menu, select **Canon Utilities > imagePROGRAF Media Configuration Tool > CNWIMCT**.

- 2** The **Select Printer** dialog box is displayed. Select the printer for which to configure the media information, and then click the **Next** button.

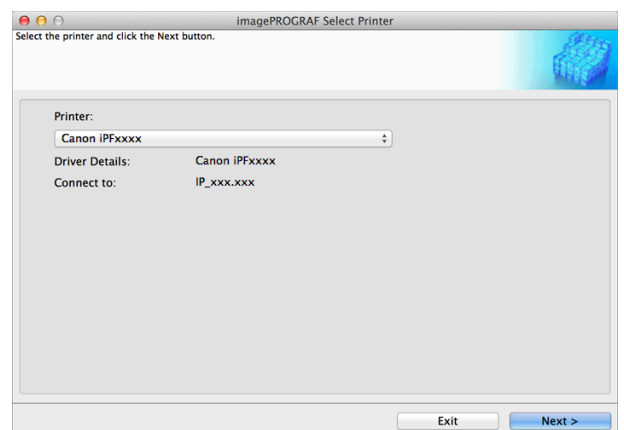

Note

- The printers for which the printer driver is installed are displayed. If the printer you want to configure is not displayed, check whether the printer driver for the target model is correctly installed.
- In the following screens, you cannot change the printer where media type information is to be updated.

3 The **Add Media Type** dialog box is displayed. Make sure that **Connect to the Internet to get the latest information** is selected, and then click the **OK** button. The latest media information file is downloaded from the Internet.

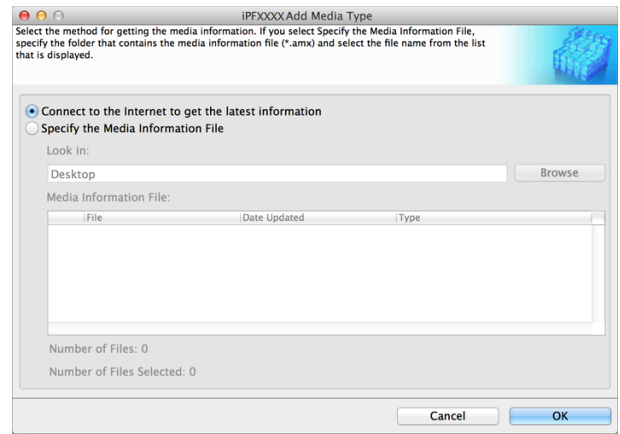

If the main window is displayed at this time, it means that the media information has already been updated and the rest of the operation is not needed.



Important

If the message on the right is displayed, the media information file cannot be downloaded automatically from the Internet. Configure the settings by referring to **If the Media Information File Does Not Download Automatically From the Internet** → P.409 .



4 The **Media Configuration Tool** main window is displayed. Click the **Add Genuine Paper** button.

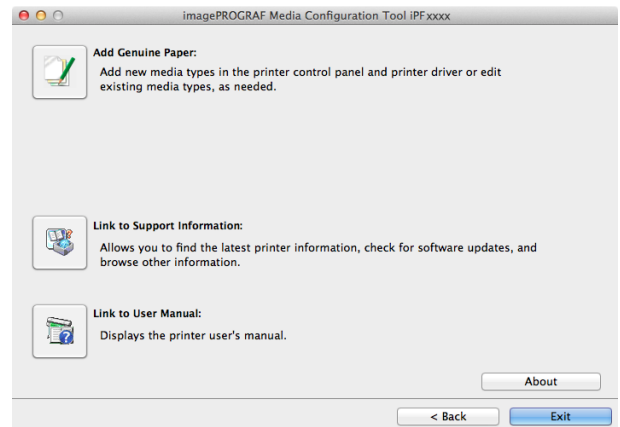

5 In the **Edit Media Types** dialog box, click the **Update** button.

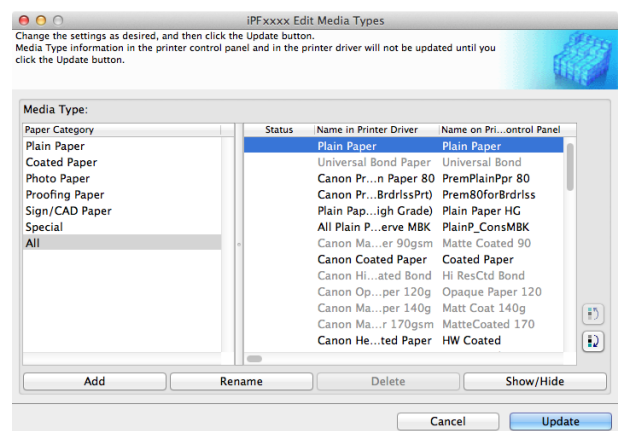

- 6** The **Confirm Update** dialog box is displayed. Configure Update Target and click the **Execute** button. The printer control panel and printer driver media information is updated.

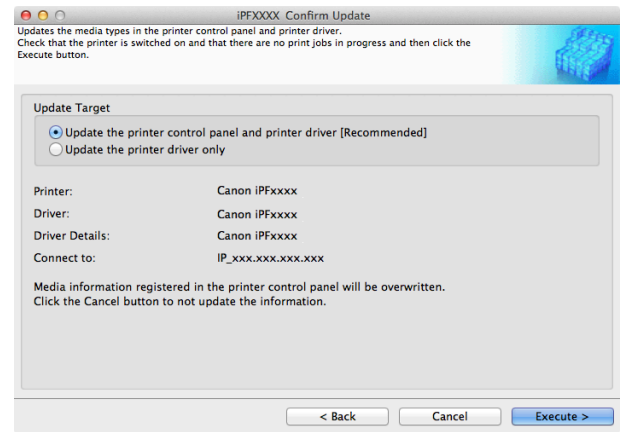

Note

- You should normally select **Update the printer control panel and printer driver**.

- 7** The message on the right is displayed. If you want to save the current media information in a file, click the **Yes** button. If you do not want to save it, click the **No** button.



Note

- The media information is saved as a media information file (.amx file).
- For the method for loading a saved media information file in another computer, see "Applying a Saved Media Information File on Another Computer." → P.426

If the Media Information File Does Not Download Automatically From the Internet

If the following message is displayed, configure the settings by using the following procedure.



- Open a web browser on a computer that can access the Internet, and access the Canon website.
- Download the media information file (.amx file) corresponding to the printer to update from the Canon website.
- Copy the downloaded media information file (.amx file) to the computer where the Media Configuration Tool is installed.

4 Run the Media Configuration Tool, then select **Specify the Media Information File** and click the **Browse** button in the **Add Media Type** dialog box.

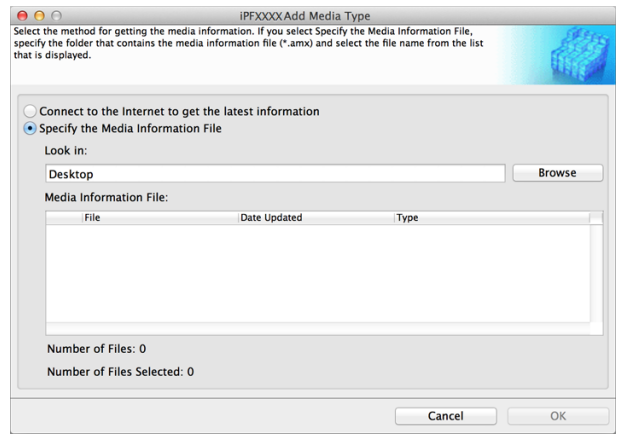

5 Select the folder that contains the media information file (.amx file) you downloaded and click the **Open** button.

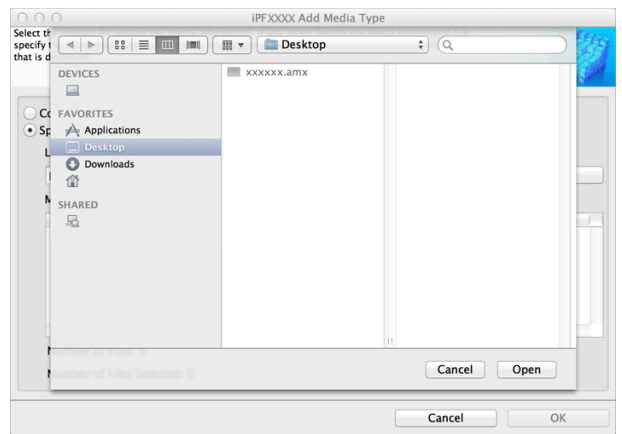

6 The names of the media information files contained in the selected folder are displayed in the **Media Information File** field in the **Add Media Type** dialog box. Select the check box for the media information file name and click the **OK** button.

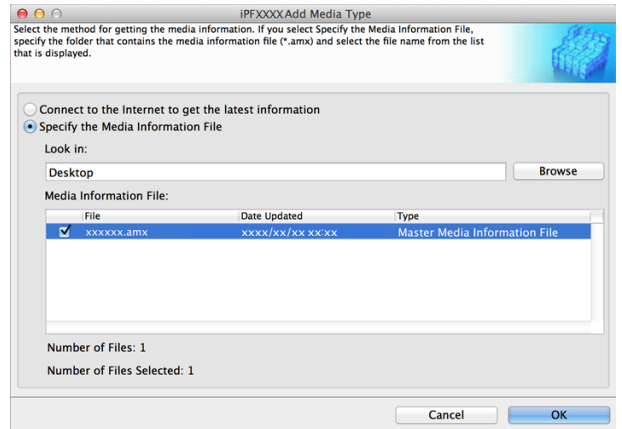

7 The Media Configuration Tool main window is displayed. Click the **Add Genuine Paper** button.

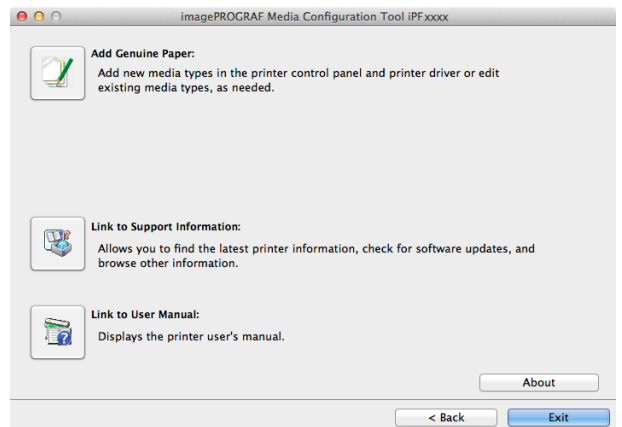

8 In the **Edit Media Types** dialog box, click the **Update** button.

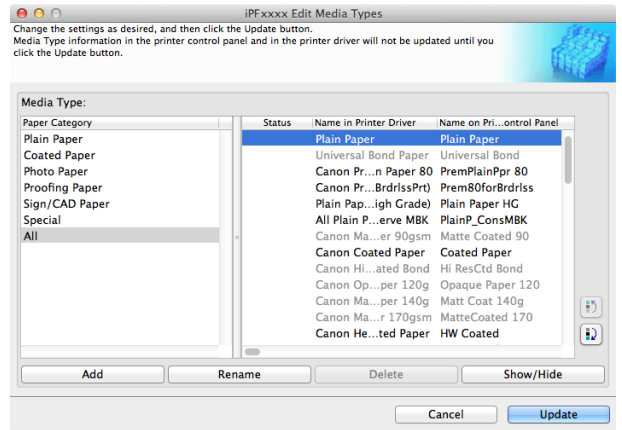

9 The **Confirm Update** dialog box is displayed. Configure Update Target and click the **Execute** button. The printer control panel and printer driver media information is updated.

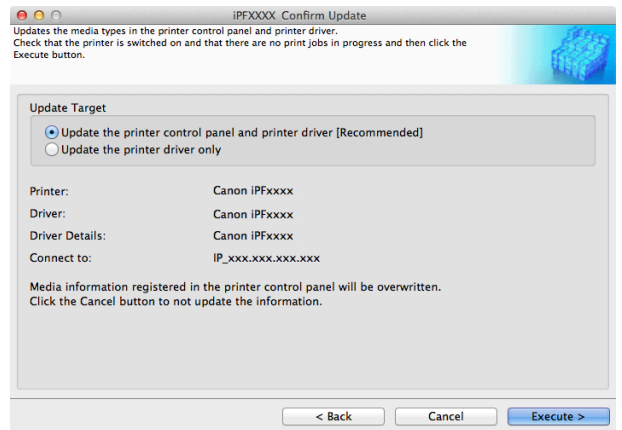

 **Note** • You should normally select **Update the printer control panel and printer driver**.

10 The message on the right is displayed. If you want to save the current media information in a file, click the **Yes** button. If you do not want to save it, click the **No** button.



 **Note** • The media information is saved as a media information file (.amx file).
• For the method for loading a saved media information file in another computer, see "Applying a Saved Media Information File on Another Computer." →P.426

Media Configuration Tool Main Window

The explanation below is on the Media Configuration Tool main window. Use the following procedure to open Media Configuration Tool main window.

 **Important** • Do not attempt to print or turn the printer off while the program is communicating with the printer.

1 From the **Applications** menu, select **Canon Utilities > imagePROGRAF Media Configuration Tool > CNWIMCT**.

- 2** The **Select Printer** dialog box is displayed. Select the printer for which to configure the media information, and then click the **Next** button.

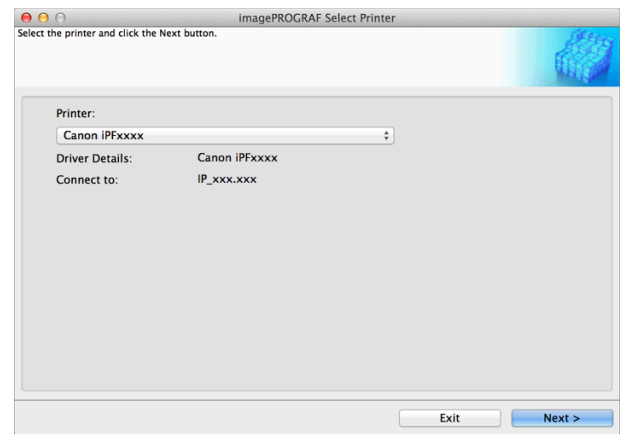

Note

- The printers for which the printer driver is installed are displayed. If the printer you want to configure is not displayed, check whether the printer driver for the target model is correctly installed.
- In the following screens, you cannot change the printer where media type information is to be updated.

The Media Configuration Tool main window is displayed.

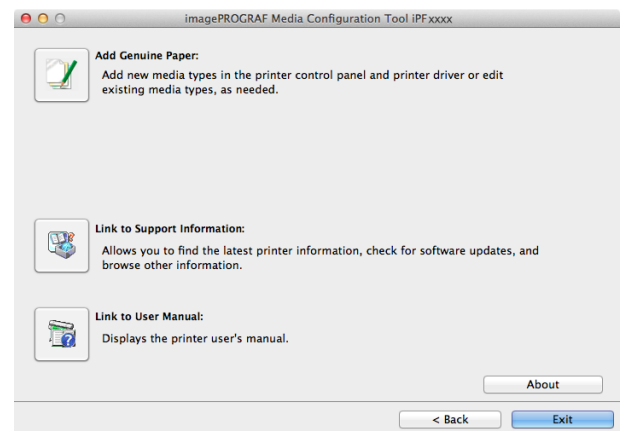

Note

- If the **Add Media Type** dialog box is displayed at this point without the main window appearing, configure the setting by referring to **Updating Media Information After Installation** →P.407 .

- **Add Genuine Paper** button

When this button is clicked, the **Edit Media Types** dialog box is displayed, which allows you to add media information files released by Canon to the printer control panel and printer driver. You can also change names, toggle between displaying and hiding, and delete added media types.

You can also change the display order of the paper types.

Refer to "Editing Media Type Information for Genuine Paper and Feed Confirmed Paper" →P.413 for details on **Add Genuine Paper**.

- **Link to Support Information** button

You can check information such as the latest information for the product and software version upgrade information.

- **Link to User Manual** Button

Displays the printer user's manual

Editing Media Type Information for Genuine Paper and Feed Confirmed Paper

When adding genuine paper and feed confirmed paper to the printer control panel and printer driver and when editing media type information, click the **Add Genuine Paper** button in the Media Configuration Tool main window to open the **Edit Media Types** dialog box.

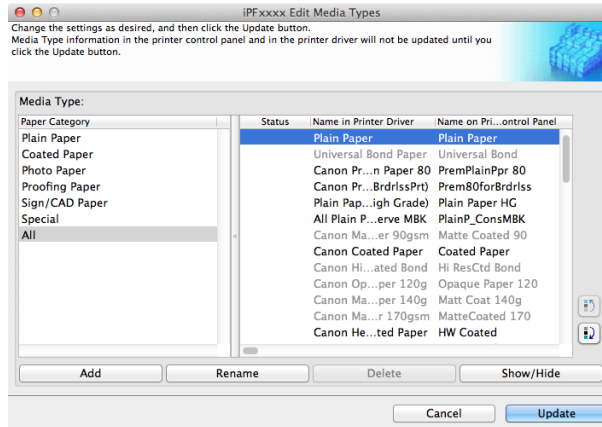

- For more information on the procedure for opening the Media Configuration Tool main window, see "Media Configuration Tool Main Window." →P.411
- Paper that is displayed grayed out does not appear in the printer driver or printer control panel.

• Add Button

To add genuine paper or feed confirmed paper to the printer control panel and printer driver, click this button. For details on the procedure for adding media types, see "Adding Media Types." →P.414

• Rename Button

To change the name on the printer control panel and the name in the printer driver for genuine paper and feed confirmed paper, select the paper to change and click this button. For details on the procedure for changing paper display names, see "Changing Media Names." →P.418

• Delete Button

To delete added genuine paper and feed confirmed paper from the printer control panel and printer driver, select the paper to delete and click this button. For details on the procedure for deleting added media types, see "Deleting Media Types You Have Added." →P.421

• Show/Hide Button

To change whether or not genuine paper or feed confirmed paper is displayed in the printer control panel and printer driver, select the paper to change and click this button. For details on the procedure for changing whether or not to display media types, see "Switching Media Types Display Show/Hide." →P.422

• Change Display Order button (or)

To change the display order of a media type in the printer control panel and printer driver, select the paper to change and click this button. For details on the procedure for changing the display order of media types, see "Changing the Display Order of Media Types." →P.424



- When you update the media type information, perform the same update on all of the PCs that are using that printer.



- It may not be possible to deleting, showing/hiding, and changing the display order under some conditions.

Adding Media Types

You can register media information files (.amx file) released by Canon in the printer control panel and printer driver.



Important

- Do not attempt to print or turn the printer off while the program is communicating with the printer.
- When you apply a media information file, the media type display order and other settings return to their default values. Reconfigure these settings again after applying the media information file.

1 Click the **Add Genuine Paper** button in the Media Configuration Tool main window.

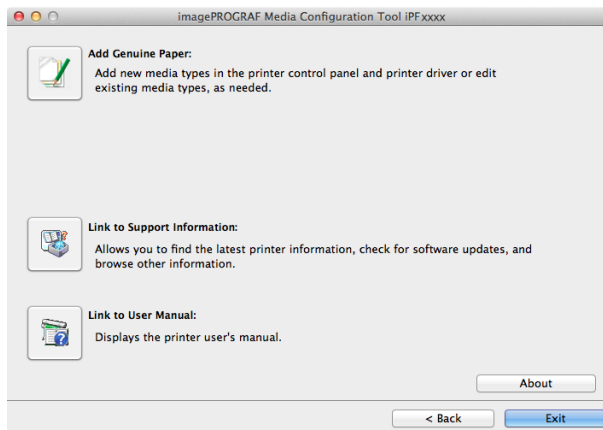

Note

- For more information on the procedure for opening the Media Configuration Tool main window, see "Media Configuration Tool Main Window." →P.411
- If the **Add Media Type** dialog box is displayed after you select the printer without the main window appearing, configure the setting by referring to **Updating Media Information After Installation** →P.407 .

When a newer version of media information file than the media information file that is applied to your printer driver is released on the Canon website, the message on the right is displayed.

To update the media information, click the **OK** button.

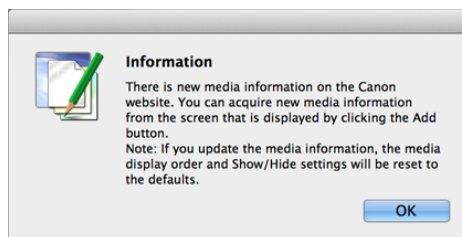

Important

- When you update the media information, the paper display order and **Show/Hide** settings return to their default values.

2 The **Edit Media Types** dialog box is displayed. Click the **Add** button.

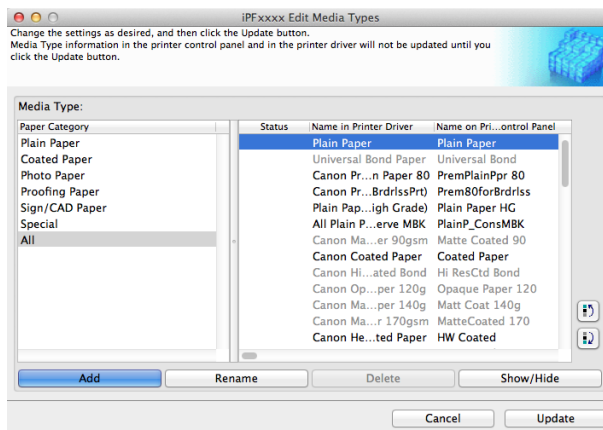

3 Make sure that **Connect to the Internet to get the latest information** is selected, and then click the **OK** button.

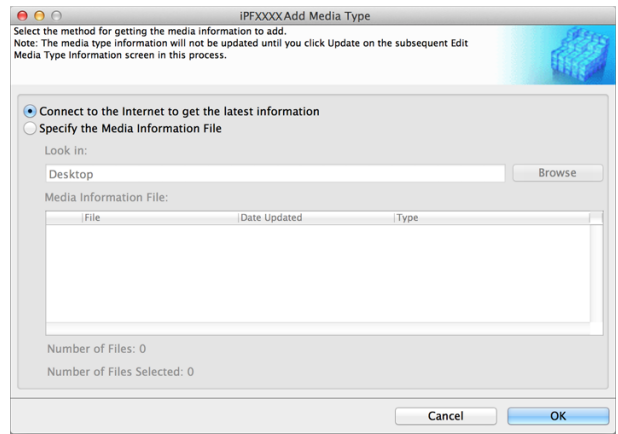

When you update the media information, the paper display order and **Show/Hide** settings return to their default values.

If the message on the right is displayed at this time, the latest media information is already applied to your printer driver. There is normally no need to update.

To exit without updating, click the **No** button. To continue with the update, click the **Yes** button.

If the message on the right is displayed, the media information file cannot be downloaded automatically from the Internet. Configure the settings by referring to If the Media Information File Does Not Download Automatically From the Internet → P.416 .

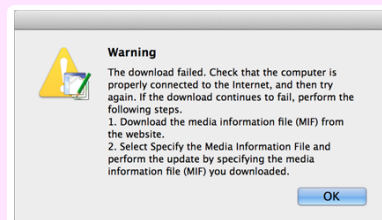
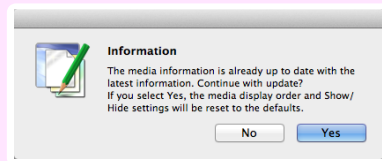

4 Click **OK** when the confirmation message is displayed.

5 In the **Edit Media Types** dialog box, click the **Update** button.

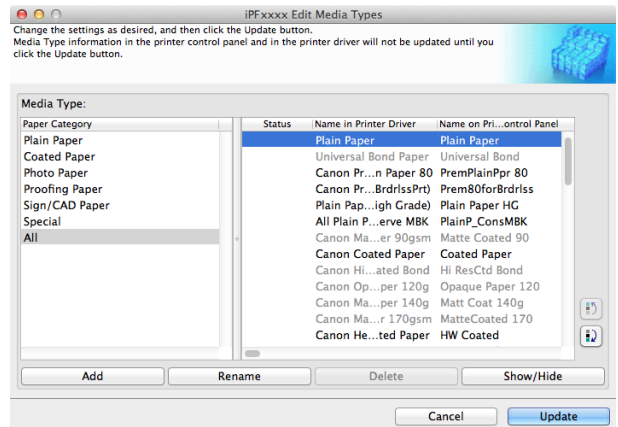

- 6** The **Confirm Update** dialog box is displayed. Configure Update Target and click the **Execute** button. The printer control panel and printer driver media information is updated.

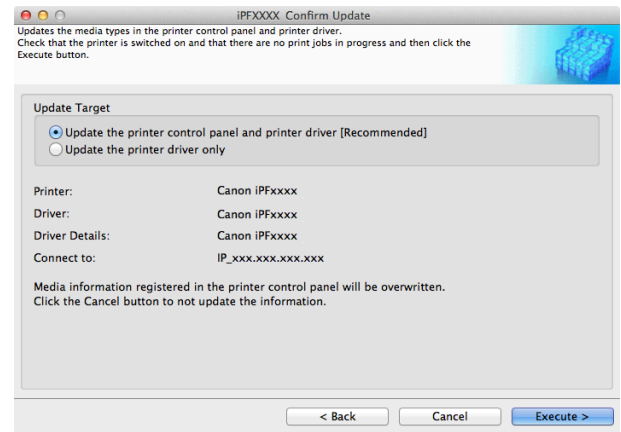

Note

- You should normally select **Update the printer control panel and printer driver**.

- 7** The message on the right is displayed. If you want to save the current media information in a file, click the **Yes** button. If you do not want to save it, click the **No** button.



Note

- The media information is saved as a media information file (.amx file).
- For the method for loading a saved media information file in another computer, see "Applying a Saved Media Information File on Another Computer." → P.426

If the Media Information File Does Not Download Automatically From the Internet

If the following message is displayed, configure the settings by using the following procedure.

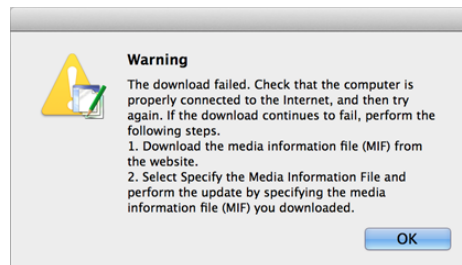

- Open a web browser on a computer that can access the Internet, and access the Canon website.
- Download the media information file (.amx file) corresponding to the printer to update from the Canon website.
- Copy the downloaded media information file (.amx file) to the computer where the Media Configuration Tool is installed.
- Run the Media Configuration Tool. Click the **Add Genuine Paper** button in the main window, and then click the **Add** button in the **Edit Media Types** dialog box.

5 Select **Specify the Media Information File** in the **Add Media Type** dialog box, and then click the **Browse** button.

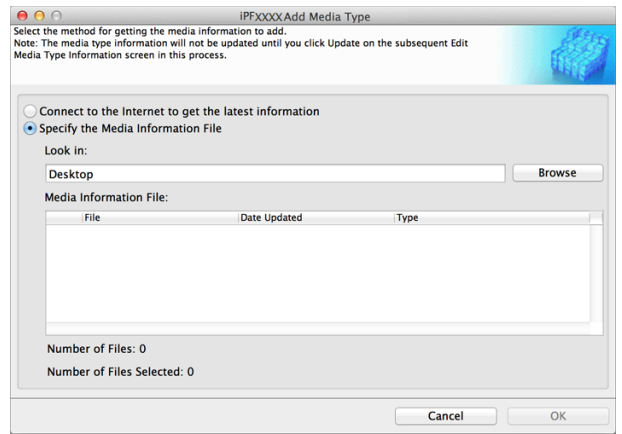

6 Select the folder that contains the media information file (.amx file) you downloaded and click the **Open** button.

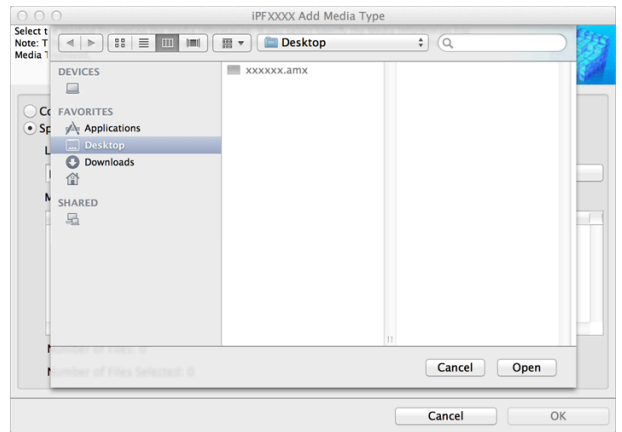

7 The names of the media information files contained in the selected folder are displayed in the **Media Information File** field in the **Add Media Type** dialog box. Select the check box for the media information file name and click the **OK** button.

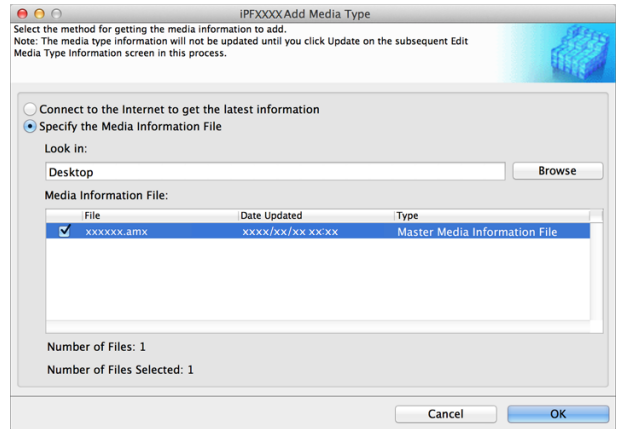

8 Click **OK** when the confirmation message is displayed.

9 In the **Edit Media Types** dialog box, click the **Update** button.

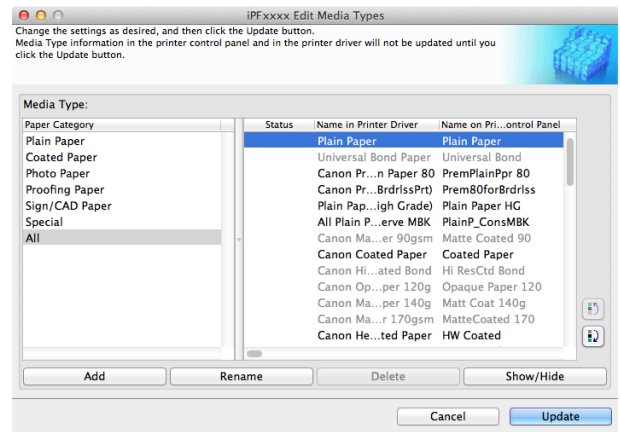

10 The **Confirm Update** dialog box is displayed. Configure Update Target and click the **Execute** button. The printer control panel and printer driver media information is updated.

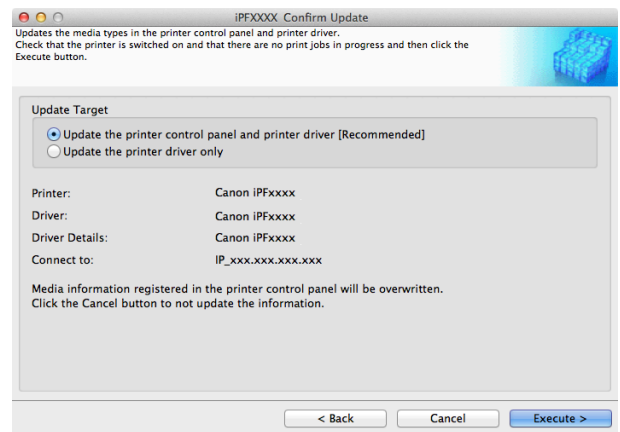

• You should normally select **Update the printer control panel and printer driver**.

Note

11 The message on the right is displayed. If you want to save the current media information in a file, click the **Yes** button. If you do not want to save it, click the **No** button.



• The media information is saved as a media information file (.amx file).

Note • For the method for loading a saved media information file in another computer, see "Applying a Saved Media Information File on Another Computer." →P.426

Changing Media Names

• Do not attempt to print or turn the printer off while the program is communicating with the printer.

Important

1 Click the **Add Genuine Paper** button in the Media Configuration Tool main window.

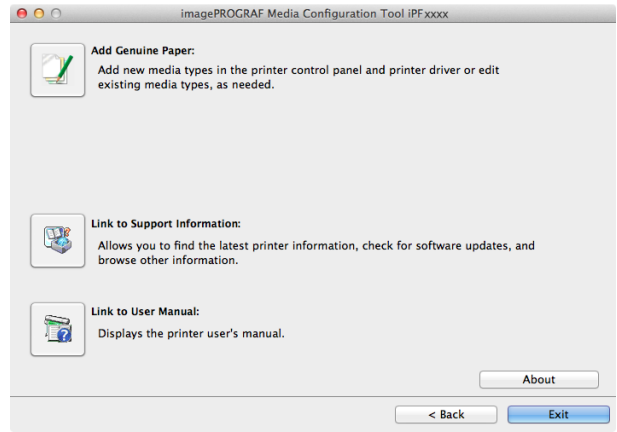

• For more information on the procedure for opening the Media Configuration Tool main window, see "Media Configuration Tool Main Window." →P.411

2 The **Edit Media Types** dialog box is displayed.

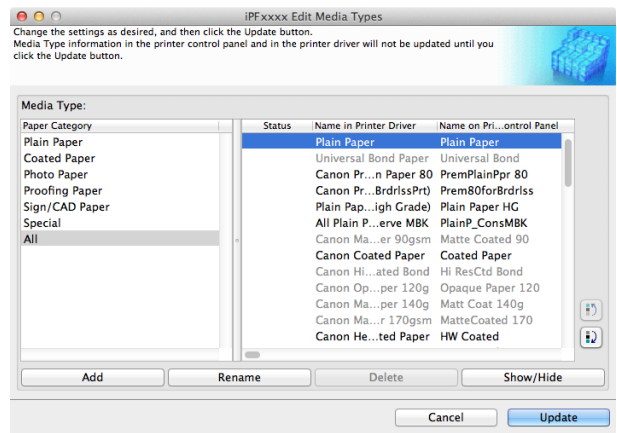

3 In the **Media Type** list, select the name to change. Click the **Rename** button.

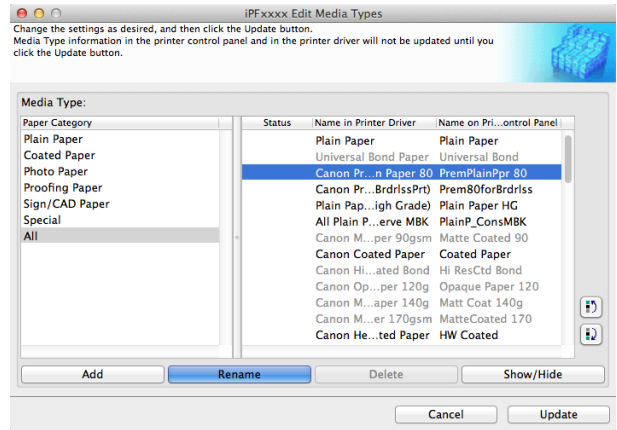

4 The **Rename Media** dialog box is displayed. Edit the names in **Name in Printer Driver** and **Name on Control Panel** and click the **OK** button.

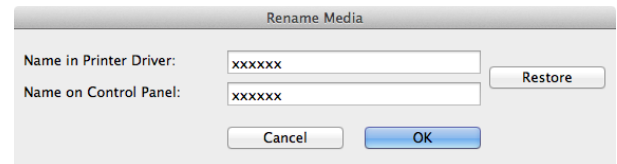



Note

- To restore the original names, click the **Restore** button.
- The characters that can be entered for **Name in Printer Driver** and **Name on Control Panel** are stated below.
alphanumeric, space, "-", ".", "_", "(", ")", "+", "%", ";", "/"
- For **Name in Printer Driver** up to 32 one Byte characters can be entered, and for **Name on Control Panel** up to 16 one Byte characters can be entered.

5

In the **Edit Media Types** dialog box, click the **Update** button.

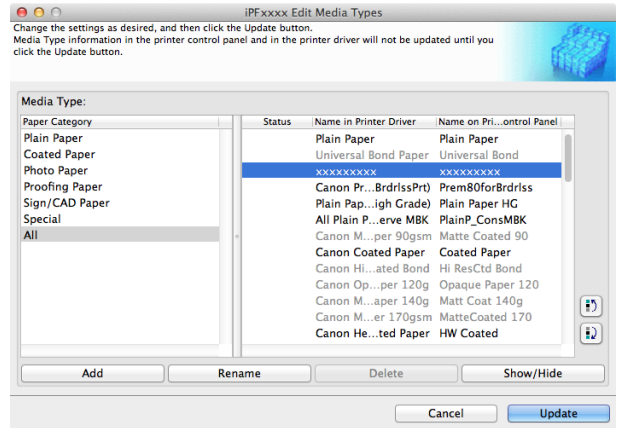

6

The **Confirm Update** dialog box is displayed. Configure **Update Target** and click the **Execute** button. The printer control panel and printer driver media information is updated.

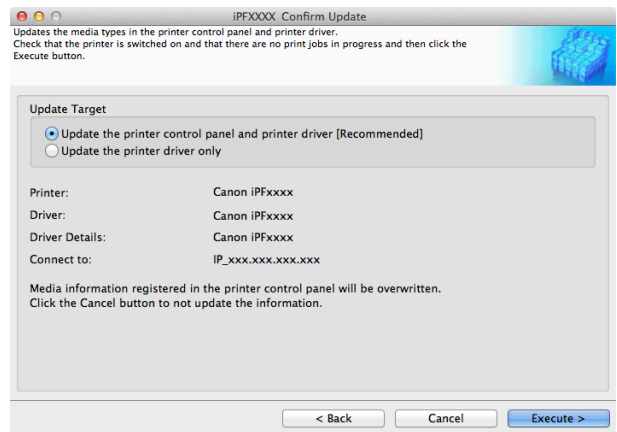

Note

- You should normally select **Update the printer control panel and printer driver**.



Important

- When setting a data to the printer that differs from the data to be updated, the selected media information file is updated. When you would like to remain the data that is set to the printer, click the **Cancel** button.

7

The message on the right is displayed. If you want to save the current media information in a file, click the **Yes** button. If you do not want to save it, click the **No** button.



Note

- The media information is saved as a media information file (.amx file).
- For the method for loading a saved media information file in another computer, see "**Applying a Saved Media Information File on Another Computer.**" → P.426

Deleting Media Types You Have Added



• Do not attempt to print or turn the printer off while the program is communicating with the printer.

1 Click the **Add Genuine Paper** button in the Media Configuration Tool main window.

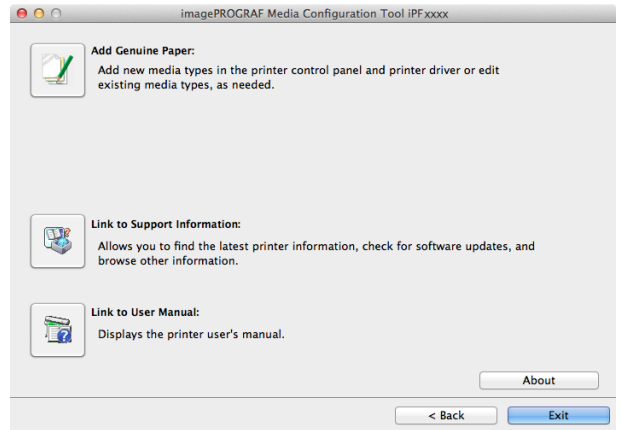

• For more information on the procedure for opening the Media Configuration Tool main window, see "Media Configuration Tool Main Window." →P411

2 The **Edit Media Types** dialog box is displayed.

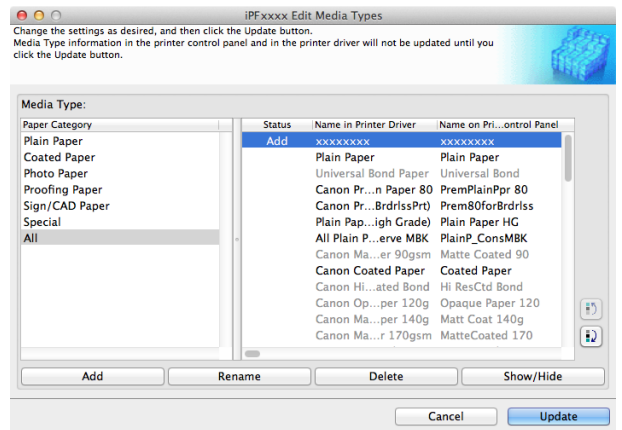

3 In the **Media Type** list, select the name of the media to delete. Click the **Delete** button.

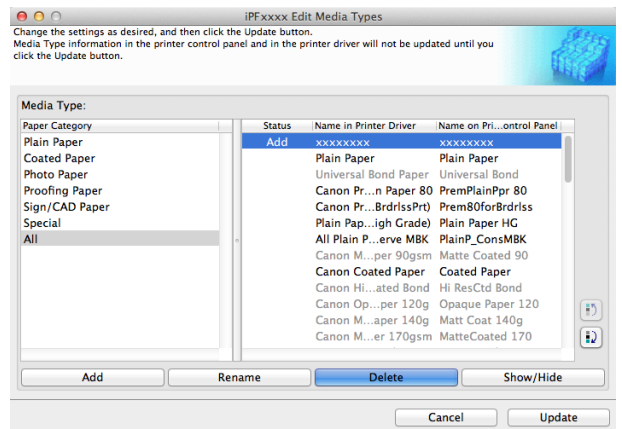

• Only paper for which **Status** in the **Media Type** is **Add** can be deleted.

4 In the **Edit Media Types** dialog box, click the **Update** button.

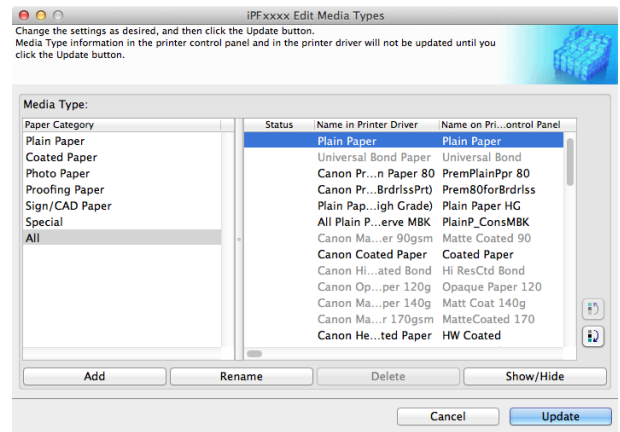

5 The **Confirm Update** dialog box is displayed. Configure Update Target and click the **Execute** button. The printer control panel and printer driver media information is updated.

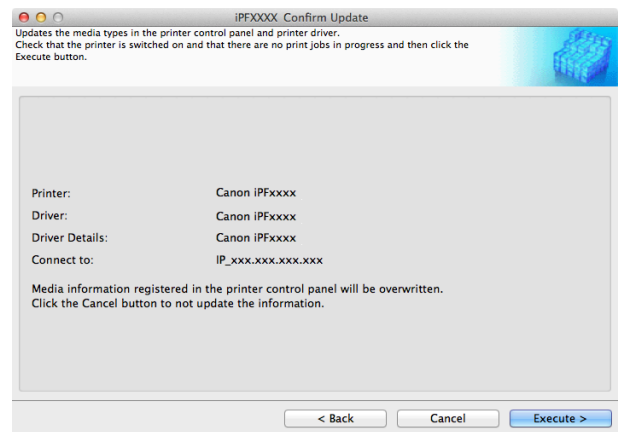

Important

- When setting a data to the printer that differs from the data to be updated, the selected media information file is updated. When you would like to remain the data that is set to the printer, click the **Cancel** button.

6 The message on the right is displayed. If you want to save the current media information in a file, click the **Yes** button. If you do not want to save it, click the **No** button.

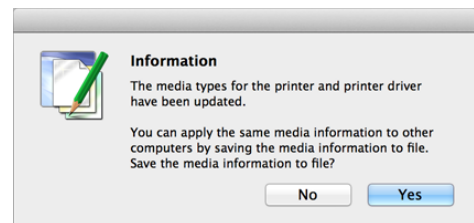

Note

- The media information is saved as a media information file (.amx file).
- For the method for loading a saved media information file in another computer, see "Applying a Saved Media Information File on Another Computer." →P.426

Switching Media Types Display Show/Hide

Important

- Do not attempt to print or turn the printer off while the program is communicating with the printer.

1 Click the **Add Genuine Paper** button in the Media Configuration Tool main window.

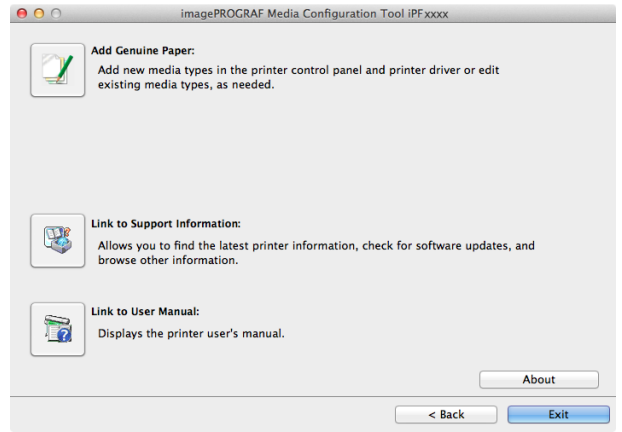

• For more information on the procedure for opening the Media Configuration Tool main window, see "Media Configuration Tool Main Window." →P.411

2 The **Edit Media Types** dialog box is displayed.

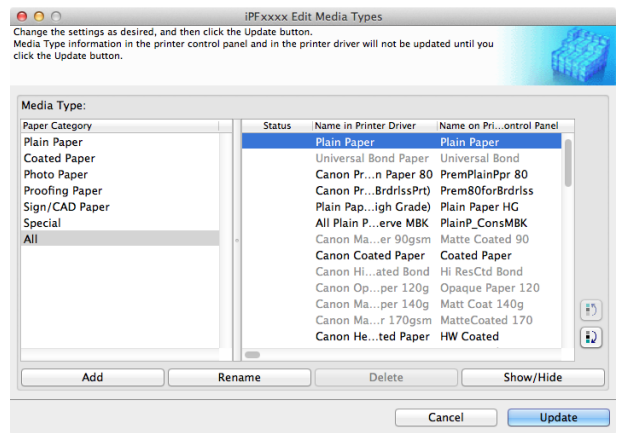

3 In the **Media Type** list, select the name of the media to switch off or on for display. Click the **Show/Hide** button. The selected paper is alternately shown or hidden.

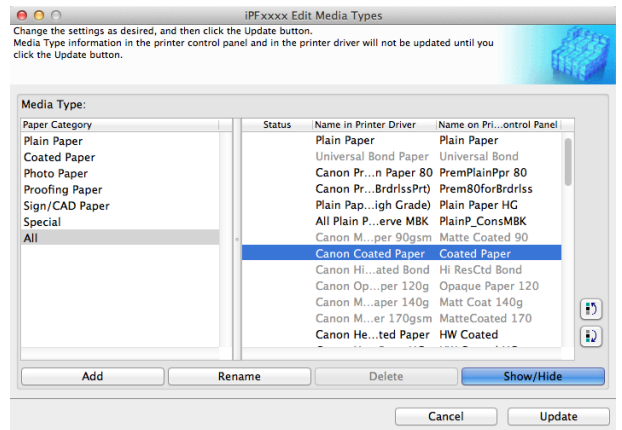

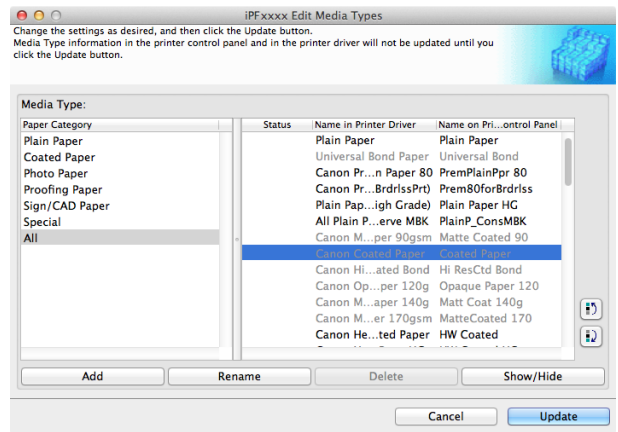

- You can select multiple paper.
- The names of media switched for non-display appear grayed out in the **Media Type** list.
- Each time you click the **Show/Hide** button, the display mode cycles from showing both the printer driver and printer panel, to hiding both the printer driver and printer panel, and then to showing only the printer panel.

4 In the **Edit Media Types** dialog box, click the **Update** button.

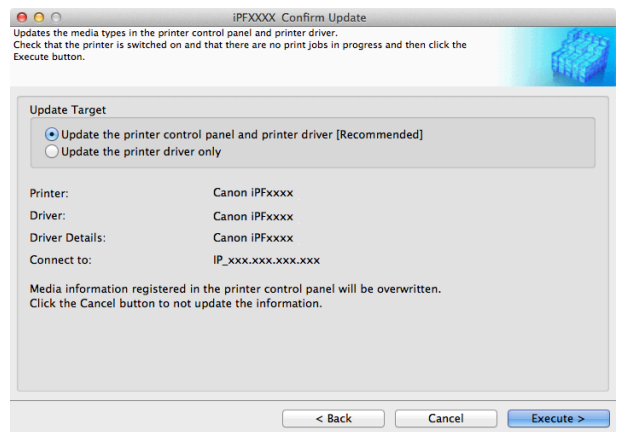

5 The **Confirm Update** dialog box is displayed. Configure **Update Target** and click the **Execute** button. The printer control panel and printer driver media information is updated.



 **Note** • You should normally select **Update the printer control panel and printer driver**.

 **Important** • When setting a data to the printer that differs from the data to be updated, the selected media information file is updated. When you would like to remain the data that is set to the printer, click the **Cancel** button.

6 The message on the right is displayed. If you want to save the current media information in a file, click the **Yes** button. If you do not want to save it, click the **No** button.



 **Note** • The media information is saved as a media information file (.amx file).
 • For the method for loading a saved media information file in another computer, see "Applying a Saved Media Information File on Another Computer." →P.426

Changing the Display Order of Media Types

 **Important** • Do not attempt to print or turn the printer off while the program is communicating with the printer.

1 Click the **Add Genuine Paper** button in the Media Configuration Tool main window.

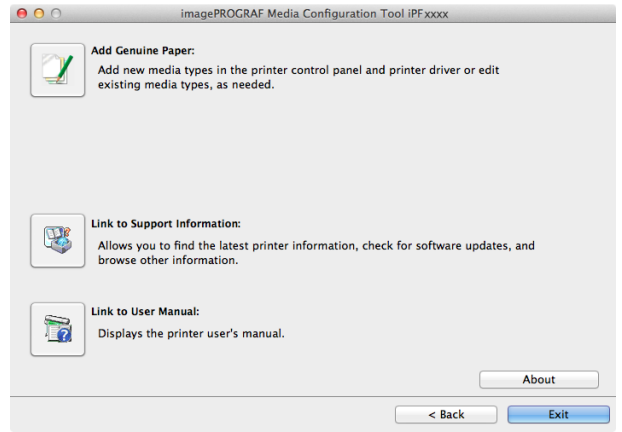

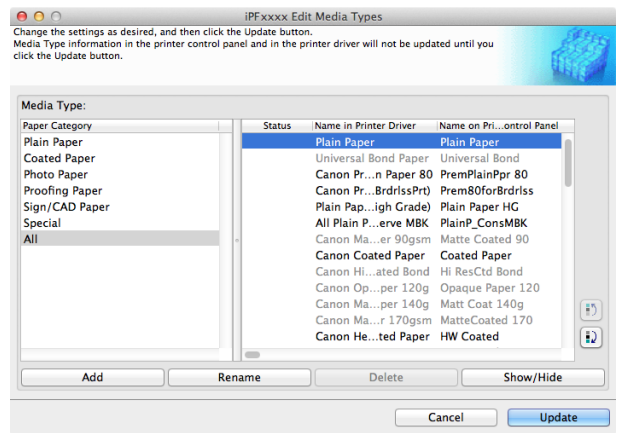

• For more information on the procedure for opening the Media Configuration Tool main window, see "Media Configuration Tool Main Window." →P.411

2 The **Edit Media Types** dialog box is displayed.



3 Select the paper in the **Media Type** list for which to change the display order, and then click the buttons

to move the item ( or ).

The selected item moves one line up or down for every button click.

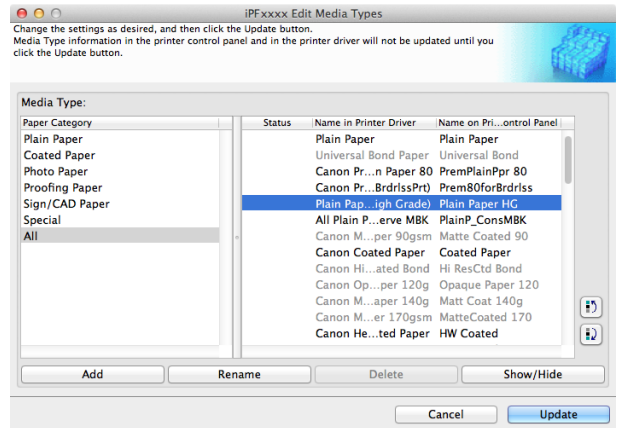

4 In the **Edit Media Types** dialog box, click the **Update** button.

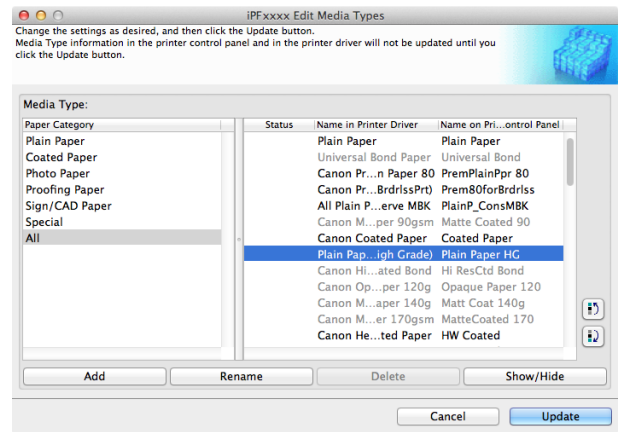

5 The **Confirm Update** dialog box is displayed. Configure **Update Target** and click the **Execute** button. The printer control panel and printer driver media information is updated.

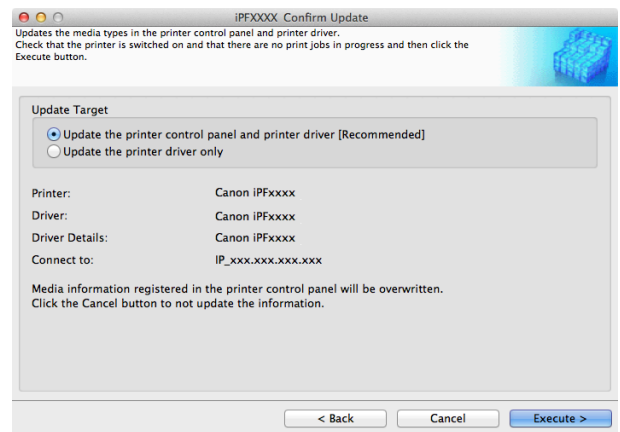

Note • You should normally select **Update the printer control panel and printer driver**.

Important • When setting a data to the printer that differs from the data to be updated, the selected media information file is updated. When you would like to remain the data that is set to the printer, click the **Cancel** button.

6 The message on the right is displayed. If you want to save the current media information in a file, click the **Yes** button. If you do not want to save it, click the **No** button.



Note • The media information is saved as a media information file (.amx file).
 • For the method for loading a saved media information file in another computer, see "Applying a Saved Media Information File on Another Computer." →P.426

Applying a Saved Media Information File on Another Computer

426 You can import and use the media information file you saved from your computer on other printers and computer by using the following procedure.

Important • Do not attempt to print or turn the printer off while the program is communicating with the printer.

1 Copy the saved media information file (.amx) onto the other computer.

2 Install and run the Media Configuration Tool on the other computer.

3 Select the printer in the **Select Printer** dialog box, and then click the **Next** button.



- Select the printer model that matches the media information file you are attempting to import.

4 Select **Specify the Media Information File** in the **Add Media Type** dialog box, click the **Browse** button, and then specify the folder that contains the .amx file you copied. Select the check box for the media information file name and click the **OK** button.

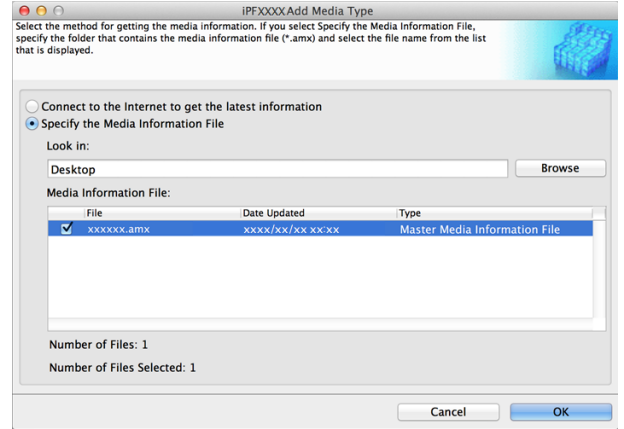

- If the Media Configuration Tool main window is displayed at this time, click the **Add Genuine Paper** button, and then click the **Add** button on the screen that opens.

5 The Media Configuration Tool main window is displayed. Click the **Add Genuine Paper** button.

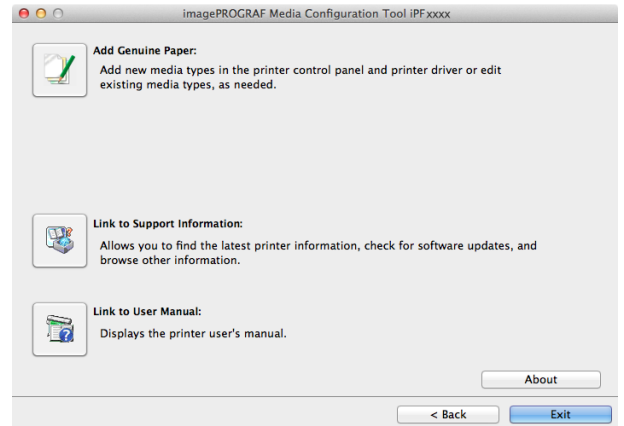

- If the **Edit Media Types** dialog box is displayed without the main window appearing, proceed to the following step.

6 In the **Edit Media Types** dialog box, click the **Update** button.

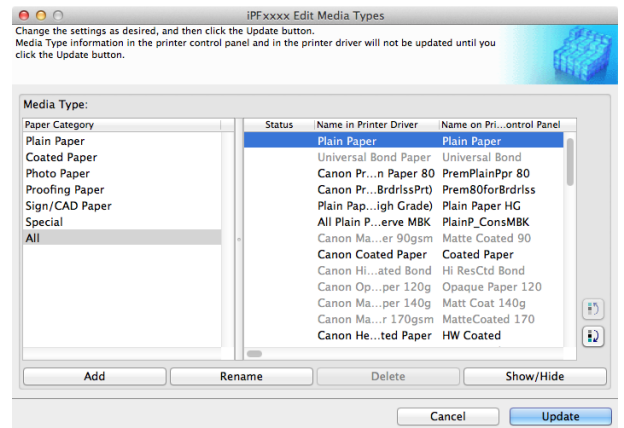

7 Configure Update Target and click the **Execute** button.

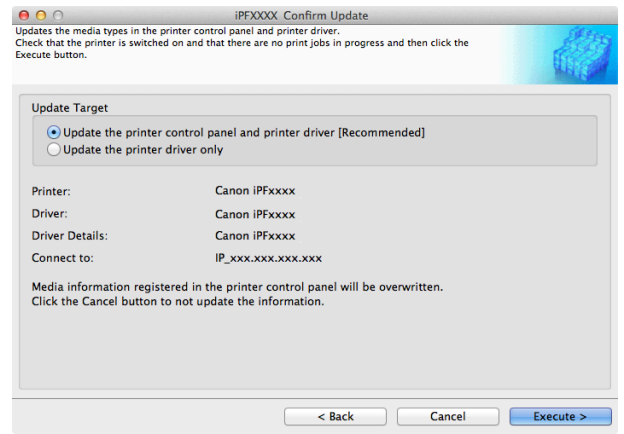

Checking the update

After updating the media information using the Media Configuration Tool, you can check whether the update has been applied to the printer in the control panel of the printer.

- 1** Click the **About** button in the Media Configuration Tool main window to open the **About** dialog box.
- 2** Check the value **xx.xx (xxxx)** of **MIT DB Version**.
- 3** Check the value **xx.xx (xxxx)** of **MIT** in **Set./Adj. Menu > Printer Info > System Info** in the printer control panel.
If the values in Steps 2 and 3 are the same, the update has been applied to the printer.

Basic Printing Workflow	15
Enhanced Printing Options	29
Windows Software	157
Mac OS Software	267
Handling and Use of Paper	331

Control Panel

Operations and Display Screen	430
Printer Menu	439

Printer Parts	467
Network Setting	481
Print Job Management	501
Adjustments for Better Print Quality	555
Maintenance and Consumables	573
Troubleshooting	617
Error Message	651
Specifications	673
Appendix	677

Operations and Display Screen

Control Panel 430

Control Panel Display 432

How to View Instructions With Navigate 436

Checking Instructions During Printer Operations 438

Control Panel

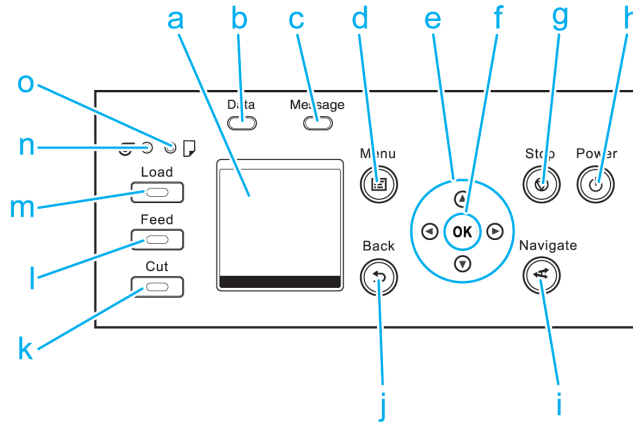

a Display Screen

Shows printer menus, as well as the printer status and messages.

b Data Lamp (green)

• Flashing

During printing, the Data lamp flashes when the printer is receiving or processing print jobs. Otherwise, this lamp flashes when the print job is paused or the printer is updating the firmware.

• Off

There are no active print jobs when the Data lamp is off.

c Message Lamp (orange)

• On

A warning message is displayed.

• Flashing

An error message is displayed.

• Off

The printer is off or is operating normally.

d Menu button

Displays the **Tab Selection screen**. (See "Menu Settings.") →P.449

e Arrow buttons

• ◀ button

Press this button on the **Tab Selection screen** to move to another tab.

In menu items requiring numerical input, press this button to move to another digit.

• ▲ button

Press this button in the menu to move to another item.

In menu items requiring numerical input, press this button to increment the number.

• ▶ button

Press this button on the **Tab Selection screen** to move to another tab.

In menu items requiring numerical input, press this button to move to another digit.

- **▼ button**

Press this button in the menu to move to another item.

In menu items requiring numerical input, press this button to decrement the number.

- f OK button**

Press this button on the **Tab Selection screen** to display the menu of the tab shown.

Pressing this button in menu items of each tab for which **+** is displayed at left will move to the lower level of the menu item, enabling you to execute menu commands or set menu values.

Also press this button if the Display Screen indicates to press the **OK** button.

- g Stop button**

Cancels print jobs in progress and ends the ink drying period.

- h Power button (green)**

Turns the printer on and off. (See "Turning the Printer On and Off.") →P.17

The **Power** button is lit when the printer is on or in Sleep mode.

- i Navigate button**

Enables you to check instructions for loading and removing paper or replacing ink tanks or printheads, as well as other operations. (See "How to View Instructions With Navigate.") →P.436

- j Back button**

Displays the screen before the current screen.

- k Cut button**

Pressing this button when rolls are loaded cuts the paper, if you have specified **Automatic** or **Eject in Cutting Mode** in the Control Panel menu. (See "Specifying the Cutting Method for Rolls.") →P.360

- l Feed button**

Pressing this button when rolls are loaded enables you to reposition the paper. (See "Feeding Roll Paper Manually.") →P.357

- m Load button**

Press this button when loading or replacing paper.

(See "Loading Rolls in the Printer.") →P.345

(See "Loading Sheets in the Printer.") →P.369

- n Roll Media lamp (green)**

Lit when rolls are selected as the paper source.

- o Cut Sheet lamp (green)**

Lit when sheets are selected as the paper source.



Note



- In **Sleep** mode, any button can be pressed except the **Power** button to recover from **Sleep** mode.

Control Panel Display

After the printer starts up, the **Tab Selection screen** is displayed. Each of the four tabs presents status, menus, and error information related to the particular tab.

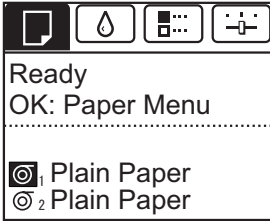
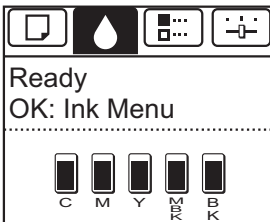

Types of tabs

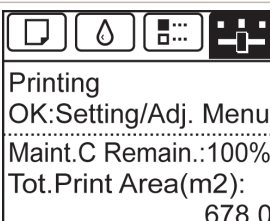
The **Tab Selection screen** presents four tabs. Each tab is represented by an icon in the top row. Press the ◀ or ▶ button to access other tabs.

<p>Paper tab</p> 	<p>A tab indicating status and showing menus related to paper. Pressing the OK button when this tab is highlighted will display the Paper Menu.</p> <ul style="list-style-type: none"> • Top line displayed The paper icon is highlighted. • Middle line displayed Indicates the printer status and shows menu names. • Bottom line displayed Displays information about the paper.
<p>Ink tab</p> 	<p>A tab indicating status and showing menus related to ink. Pressing the OK button when this tab is highlighted will display the Ink Menu.</p> <ul style="list-style-type: none"> • Top line displayed The ink icon is highlighted. • Middle line displayed Indicates the printer status and shows menu names. • Bottom line displayed Here, the remaining ink level is indicated. (See "Checking Ink Tank Levels.") →P.583
<p>Job tab</p> 	<p>A tab indicating status and showing menus related to print jobs. Pressing the OK button when this tab is highlighted will display the Job Menu menu.</p> <ul style="list-style-type: none"> • Top line displayed The job icon is highlighted. • Middle line displayed Indicates the printer status and shows menu names.
<p>Settings/Adj. tab</p> 	<p>A tab indicating status and showing menus related to settings and adjustment. Pressing the OK button when this tab is highlighted will display the Set./Adj. Menu.</p> <ul style="list-style-type: none"> • Top line displayed The settings/adjustment icon is highlighted. • Middle line displayed Indicates the printer status and shows menu names. • Bottom line displayed The remaining Maintenance Cartridge capacity is shown on the first line and Tot.Print Area on the second. The display unit for Tot.Print Area can be specified in the Length Unit menu. (See "Menu Settings.") →P.449

Printer status and modes

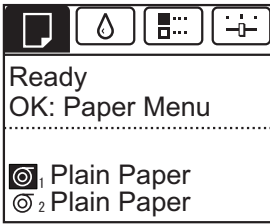
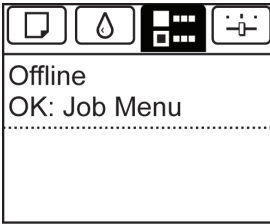
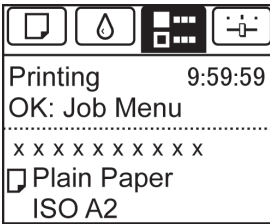
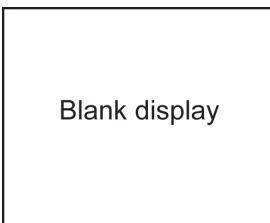
The printer has the following status.

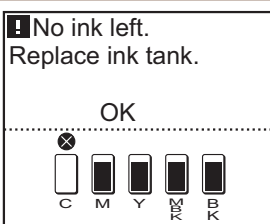
<p>Standby</p> 	<p>The printer is ready to receive jobs sent from the computer. Jobs sent from the computer are printed immediately.</p>
<p>Printing Paused</p> 	<p>Printing is paused on the printer. Any jobs sent from the computer are held without being printed.</p>
<p>Printing</p> 	<p>The printer is printing a print job. When a print job is received from the computer, printing starts after the currently printing print job has printed. The time left until printing is finished is indicated in the upper-right corner in the middle line of the display (values exceeding 10 hours are not shown). The job name and the information about the paper of the currently printing job appear at the bottom line of the display.</p>
<p>Sleep</p> 	<p>The printer is in power-saving mode. The printer automatically enters Sleep mode to conserve power when idle for a specific period (by default, five minutes), that is, if no print jobs are received or buttons are pressed while all covers are closed. You can specify the period before the printer enters Sleep mode in the Sleep Timer menu. (See "Menu Settings.") →P.449 After entering Sleep mode from Standby mode, the printer automatically recovers if print jobs are received, and the jobs are printed.</p>
<p>Off</p> 	<p>The printer is not on. If no operations are performed on the printer for the duration of the time set in Shut Down Timer after entering Sleep mode, the printer automatically turns off. (See "Menu Settings.") →P.449</p>
<p>Error</p> 	<p>The printer requires your attention. Any jobs sent from the computer cannot be processed. The tab related to the error is displayed. For information about the display in the case of multiple errors, see "Display Transitions in Error Status."</p>

Display Transitions in Normal Status

The display transitions while the printer is in the normal status (the status where no errors have occurred) are shown below.

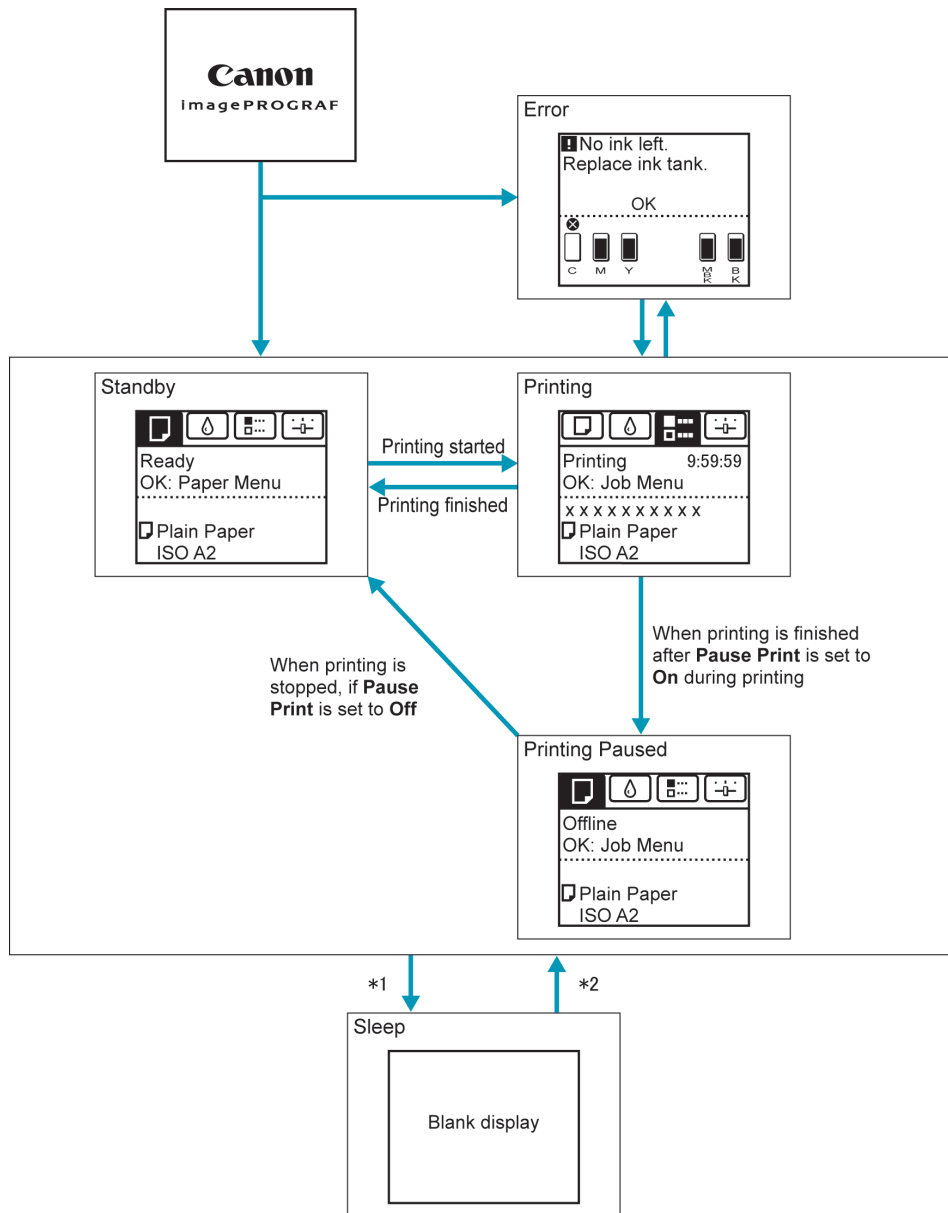

*1: The printer automatically enters **Sleep** mode when idle for a specific period (by default, five minutes), that is, if no print jobs are received or buttons are pressed while all covers are closed. However, it does not enter **Sleep** mode while error messages are displayed or when a roll can be manually advanced by pressing the **Feed** button.

*2: When the printer is in **Sleep** mode, you can press any button except the **Power** button to recover from **Sleep** mode. **Sleep** mode is also terminated if a print job is received or a command is issued from RemoteUI.

Display Transitions in Error Status

The display transitions while an error has occurred on the printer are shown below. If multiple errors have occurred, the tabs for errors that have occurred other than the currently displayed error are displayed flashing. You can move between the tabs by pressing the ◀ and ▶ keys. If multiple errors have occurred in the Job tab and Settings/Adj. tab, the error message switches every four seconds within each tab.

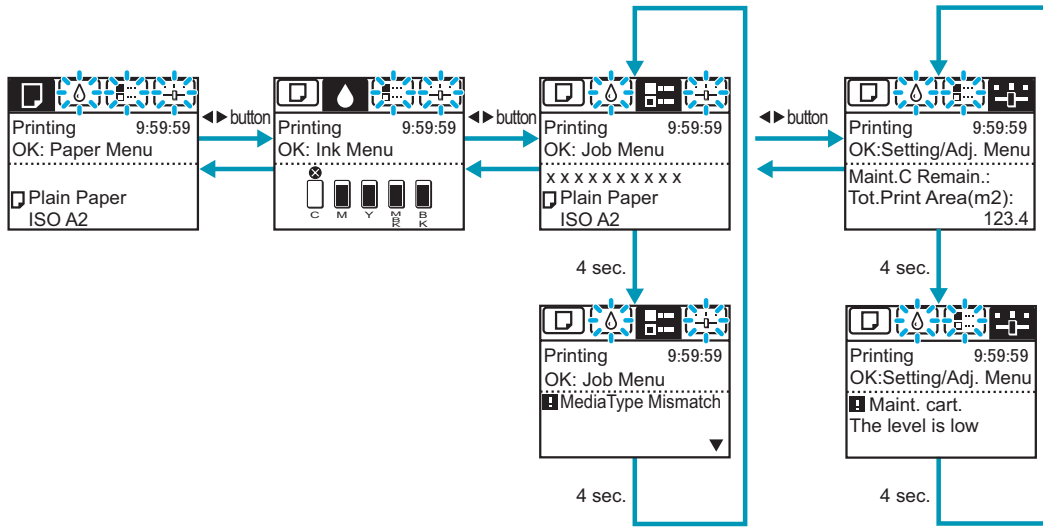

How to View Instructions With Navigate

You can refer to instructions for loading paper, replacing ink tanks, and performing other operations on the printer control panel.



Note

- If the **Control panel access lock** is set, the navigation menu does not appear if you press the **Navigate** button. Contact the printer administrator.

(See "Setting Control panel access lock." → P.465)

- 1** Press the **Navigate** button.
- 2** Press **▲** or **▼** to select the desired navigation menu.
- 3** Press **▲** or **▼** to select **View Op. Guide**, and then press the **OK** button. Instructions are now displayed.

Example: Loading sheets

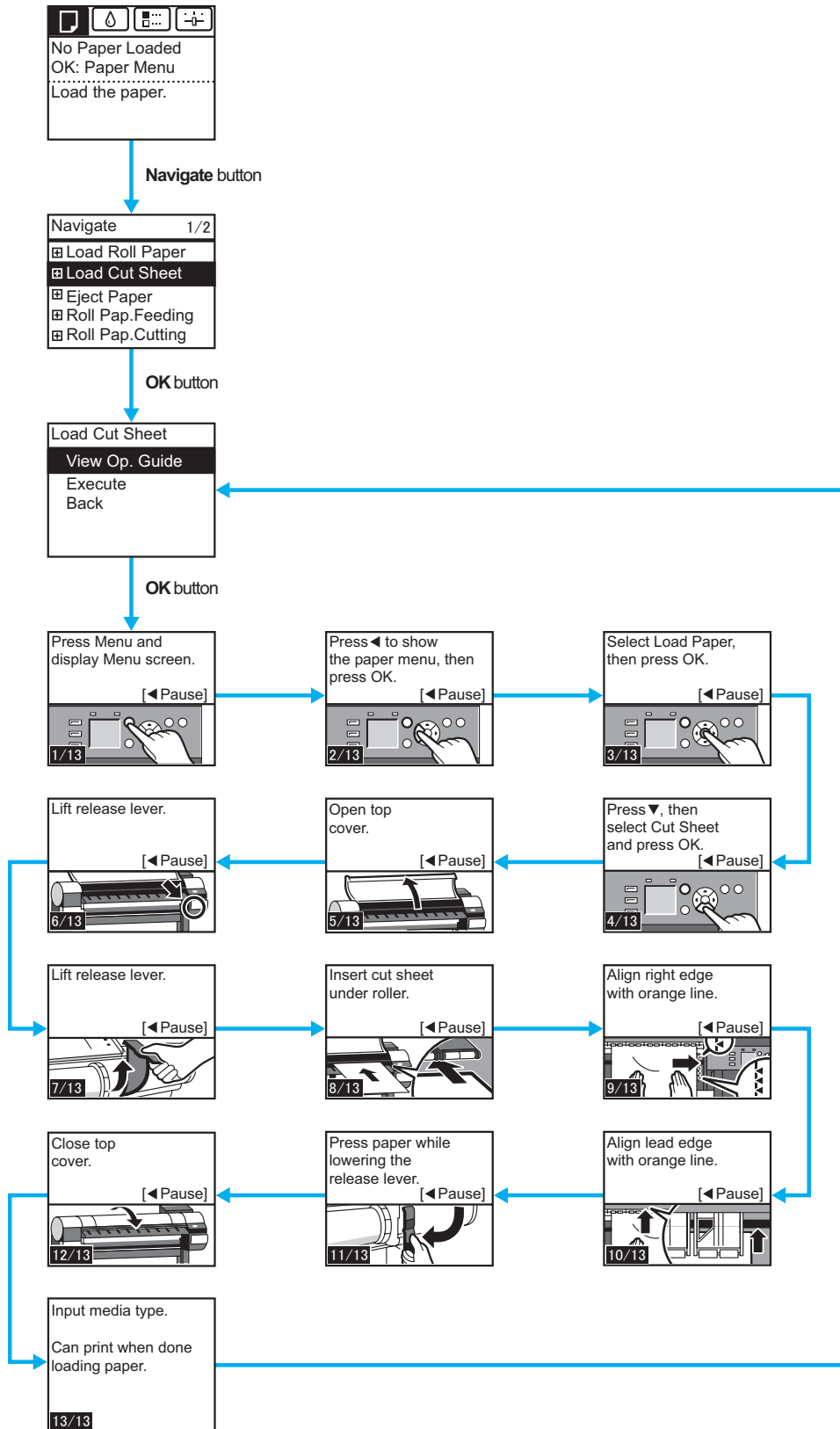

Checking Instructions During Printer Operations

You can refer to instructions on the printer control panel when loading paper, replacing ink tanks, or performing other operations.

How to view instructions

Once you complete an action described in the instructions, the printer detects the action and switches to the next instruction screen.

In the case of actions the printer cannot detect, instruction screens are switched every four seconds, and the sequence of operations is shown repeatedly.

When all actions in the sequence are finished, the instruction screen for the next step is displayed.

Example: Ink tank replacement

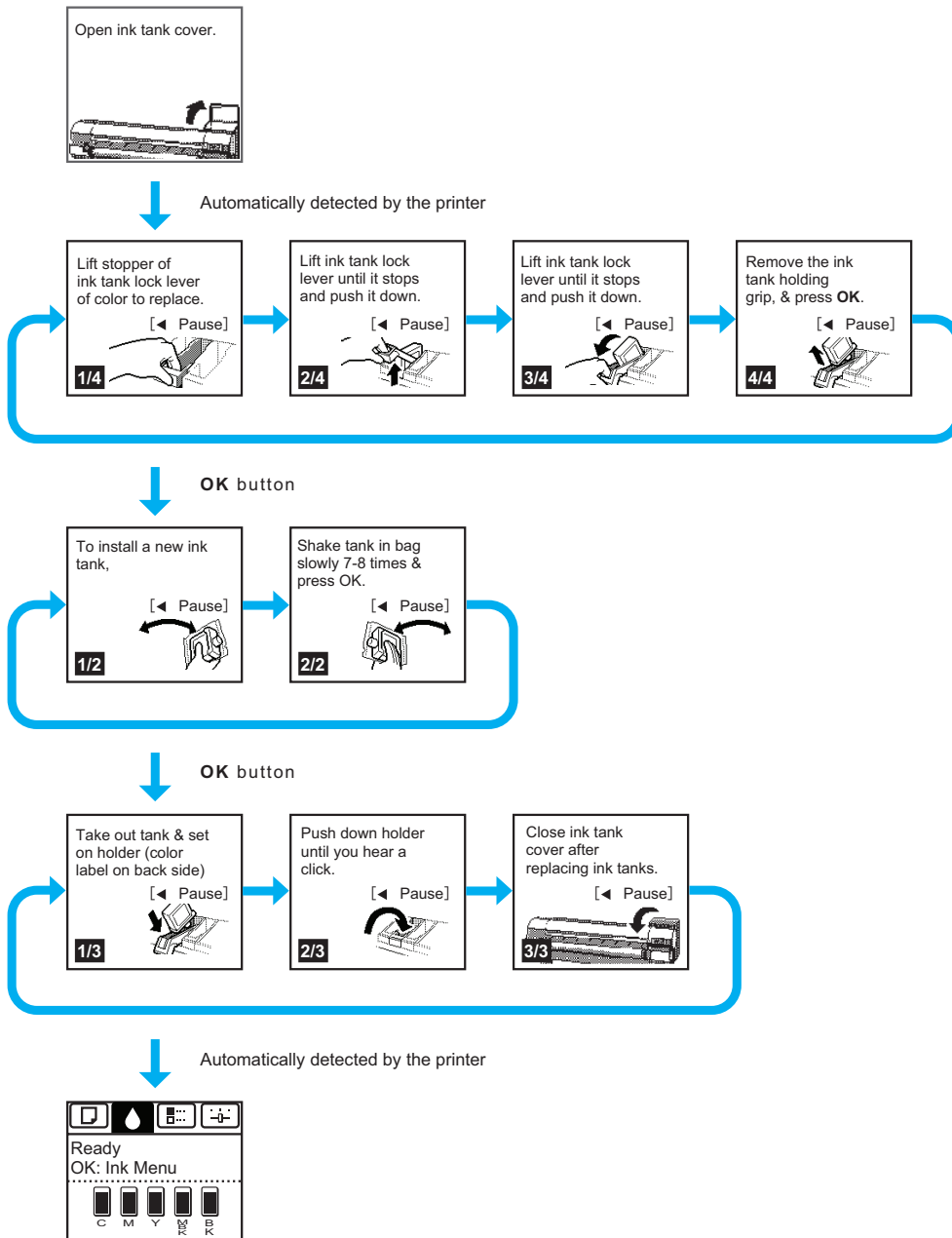

- During a continuous display of instructions, you can press the ◀ button to pause the instructions on the current screen. Press the ◀ or ▶ button to display the previous or next screens. If you do not press the ◀ or ▶ button within 30 seconds, continuous display is resumed. Press the OK button to display the instruction screen for the next step.

Printer Menu

- Printer Menu Operations 439
- Menu Operations 440
- Menu Structure 443
- Menu Settings 449
- Status Print 460
- Printing Interface Setting Reports 463
- Setting Control panel access lock 465

Printer Menu Operations

The printer menu is classified into regular menu items available when no print job is in progress and menu during printing items only available while printing is in progress.

- Regular menu operations →P.439
- Menu operations during printing →P.439

Regular menu operations

To view available menus organized on tabs, select a tab on the **Tab Selection screen** and press the **OK** button.



Note

- If the **Tab Selection screen** is not displayed, pressing **OK** will not display menus. Menus can be selected after you resolve the problem.
- If the **Control panel access lock** is set, pressing **OK** button will not display menus. Contact the printer administrator. (See "Setting Control panel access lock.") →P.465

The following operations are available from the menu.

- **Paper Menu**
Paper menu settings
- **Ink Menu**
Ink menu operations
- **Job Menu**
Menu operations to manage print jobs
- **Set./Adj. Menu**
Menu operations for printer adjustment and maintenance

For a description of specific menu items available, see "**Menu Settings.**" →P.449

For instructions on selecting menu items, see "**Menu Operations.**" →P.440



Note

- By default, menu settings apply to all print jobs. However, for settings that are also available in the printer driver, the values specified in the printer driver take priority.

Menu operations during printing

During printing, only a limited set of menu items are displayed. Menu items that are not displayed during printing should be operated after printing has finished.

To display menus during printing, select a tab on the **Tab Selection screen** on the Control Panel, and then press the **OK** button.



Note

- If the **Tab Selection screen** is not displayed, pressing **OK** will not display menus. Menus can be selected after you resolve the problem.
- If the **Control panel access lock** is set, pressing **OK** button will not display menus. Contact the printer administrator. (See "Setting Control panel access lock.") →P.465

The following operations are available from the menu during printing.

- **Ink Menu**
Ink menu operations
- **Job Menu**
Menu operations to manage print jobs
- **Set./Adj. Menu**
Fine-tuning paper feeding
Display of printer-related information

For a description of specific menu items available, see "Menu Settings." →P.449

For instructions on selecting menu items during printing, see "Menu Operations." →P.440

Menu Operations

To view available menus organized on tabs, select a tab on the **Tab Selection screen** and press the **OK** button. For details, see "Menu Settings." →P.449

- Menus (when the Ink tab is selected and the **OK** button is pressed)

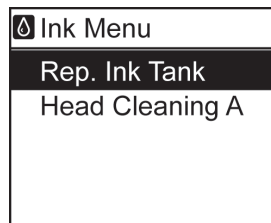

- If the **Tab Selection screen** is not displayed, press the **Menu** button.

Note

Simply press buttons on the Control Panel to access menus on various tabs from the **Tab Selection screen** and set or execute **Menu** items.

The following section describes menu operations.

- Accessing menus →P.440
- Specifying menu items →P.441
- Specifying numerical values →P.442
- Executing menu commands →P.442

Accessing menus

Printer menus are grouped by function.

Menus are displayed with the upper line selected. You can use the buttons on the Control Panel to access each menu.

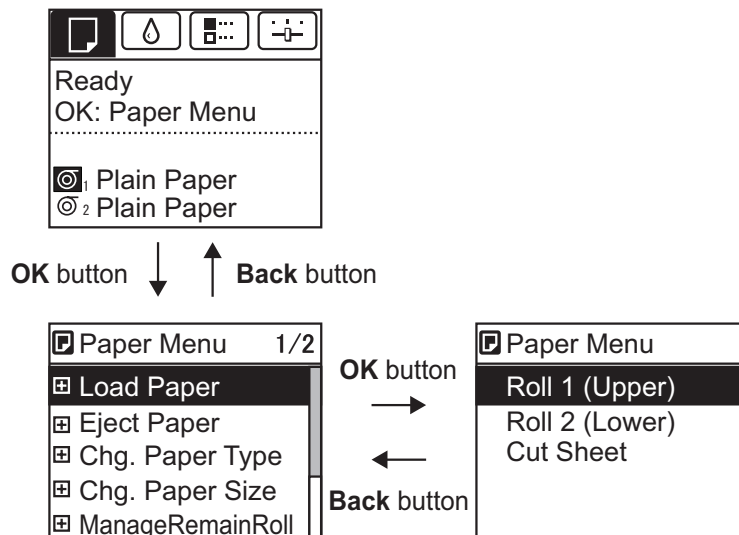

- Press **Back** to access a higher menu in the menu list, and press **OK** to access a lower one. If not all menu items are displayed, hold down **▲** or **▼** to scroll through higher and lower menu items. Items you select are highlighted.

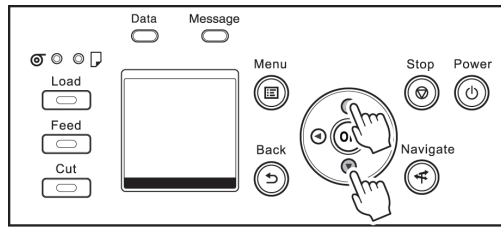

The scroll bar at right indicates the current position in the overall menu.

- Lower menus are available if **+** is displayed at left next to the second and subsequent rows. To access the lower menus, select the menu and press the **OK** button.

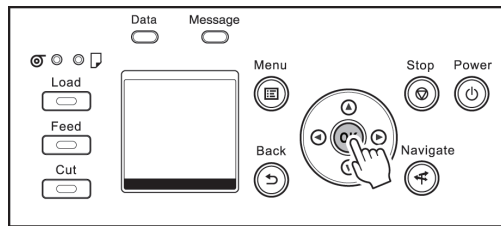

Specifying menu items

Menu items can be set as follows.

- 1 Press **▲** or **▼** to select the desired setting, and then press the **OK** button. After two seconds, the display reverts to the upper level menu.

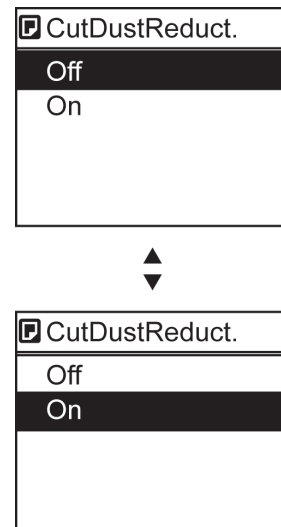

Note

- If a confirmation message is displayed regarding the setting you entered, follow the on-screen instructions.
- If you have changed the **Interface Setup** menu settings, a message confirming whether to register the settings is displayed if you press **Back** button or **Menu** button. Follow the instructions shown on the screen.

Specifying numerical values

Follow these steps to enter numbers. In this example, network settings items are entered.

- 1 Press the ◀ or ▶ button to move to the next field for input.

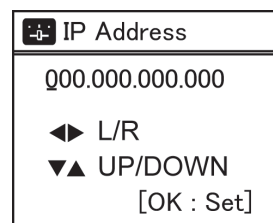

- 2 Press the ▲ or ▼ button to enter the value.



Note

- Hold down ▲ or ▼ to increase or decrease the value continuously.

- 3 Repeat steps 1 and 2 to complete the settings, and then press the **OK** button.



Note

- If a confirmation message is displayed regarding the setting you entered, follow the on-screen instructions.
- If you have changed the **Interface Setup** menu settings, a message confirming whether to register the settings is displayed if you press **Back** button or **Menu** button. Follow the instructions shown on the screen.

Executing menu commands

Menu commands can be executed as follows.

- 1 Press ▲ or ▼ to select the action to execute, and then press the **OK** button. The menu command is now executed.

Menu Structure

The menu structure is shown categorized by tab. The * on the right side of an item indicates the default value. The printer menu is classified into regular menu items available when no print job is in progress and menu during printing items only available while printing is in progress. see "Printer Menu Operations." →P.439

Regular menu	Menu during printing
Paper Menu	Not displayed
Ink Menu	The same Ink Menu as normal is displayed.
Job Menu	The same Job Menu as normal is displayed.
Set./Adj. Menu	A limited Set./Adj. Menu containing the following items is displayed. <ul style="list-style-type: none"> • Adj. Fine Feed(*1) • Printer Info

*1: Only displayed in the menu during printing. Not displayed in the regular menu.

For instructions on menu operations, see "Menu Operations." →P.440

For details on menu items, see "Menu Settings." →P.449

Menus may change according to the optional products in use.

Paper Menu

The Paper Menu is not displayed during printing.

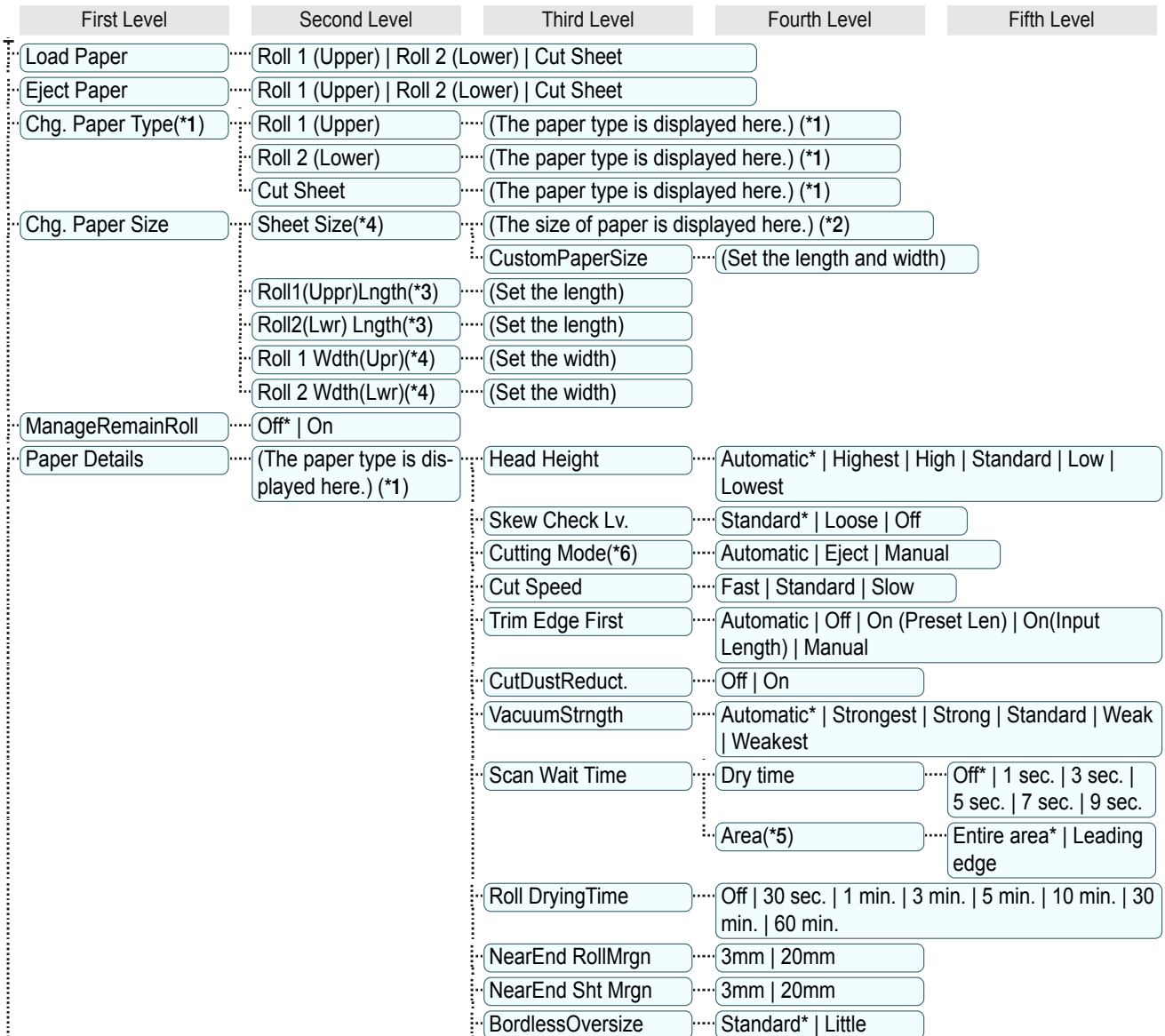

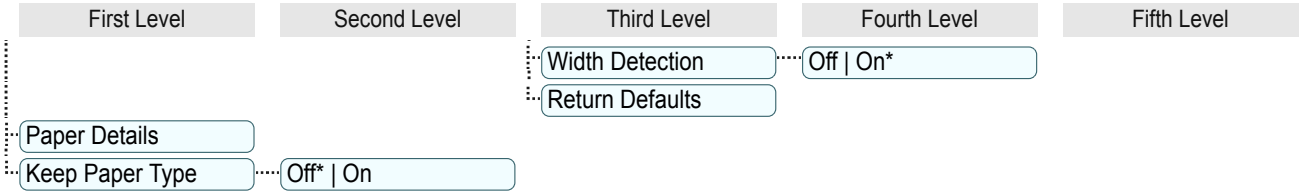

- *1: For information on the types of paper the printer supports, refer to the **Paper Reference Guide**. (See "Displaying the Paper Reference Guide.") →P.335 Types of paper in the printer driver and related software (as well as on the Control Panel) are updated when you install the printer driver from the User Software CD-ROM or if you update paper information with the Media Configuration Tool. (See "Updating paper information.") →P.338
- *2: For information on the sizes of paper the printer supports, see "Paper Sizes." →P.332
- *3: Available only if **Manage Remain Roll** is On.
- *4: Available only if **Width Detection** is Off.
- *5: **Leading edge** is not available as a setting option in the **Paper Detailed Settings** dialog box of the printer driver.
- *6: see "Specifying the Cutting Method for Rolls." →P.360

Ink Menu

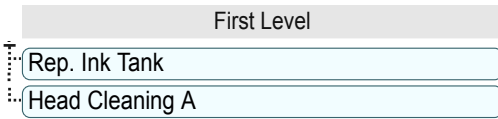

Job Menu

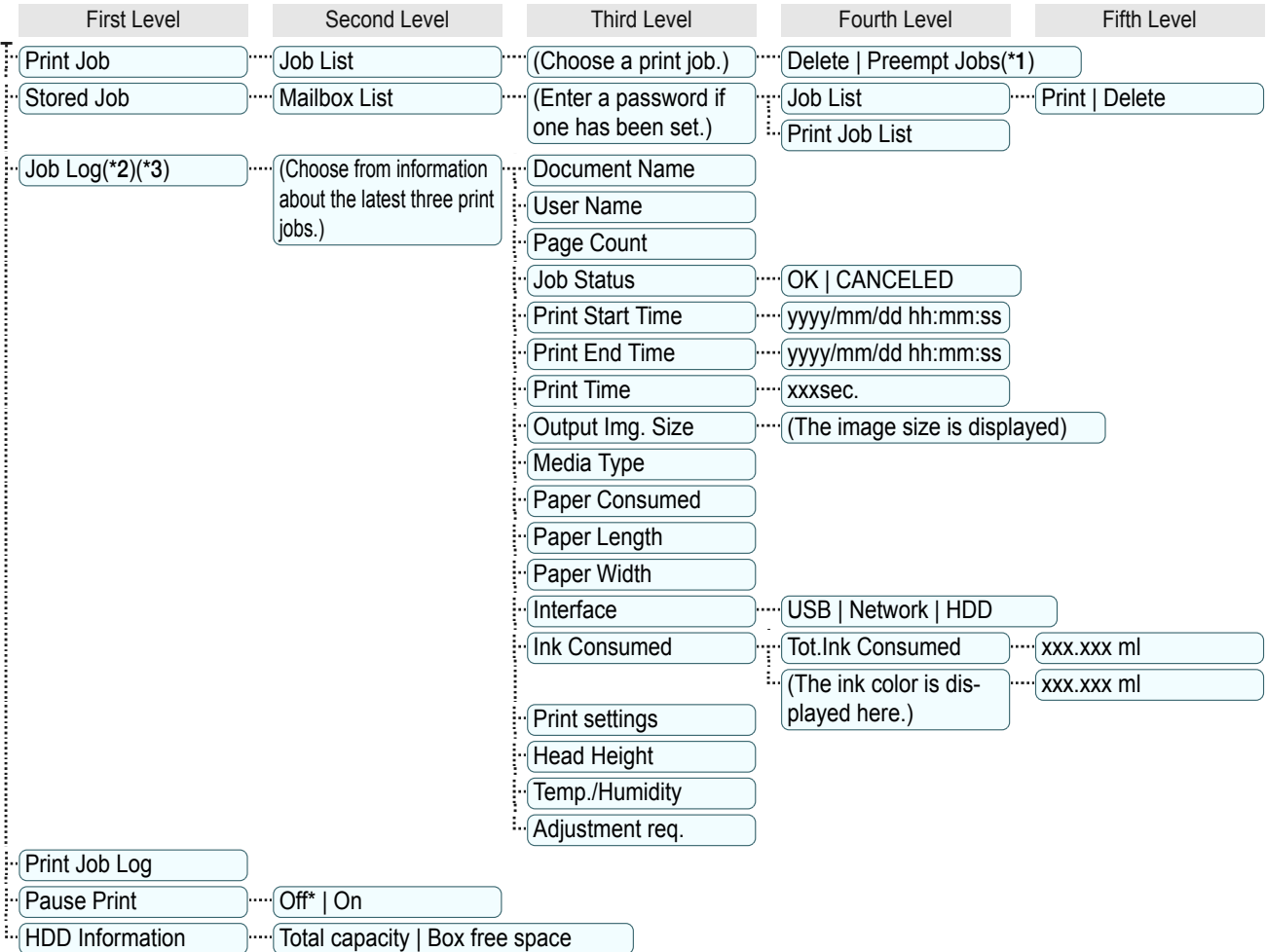

- *1: If a pending job is selected, **Print Anyway** is displayed.
- *2: This is displayed when **Show Job Log** is On in **System Setup**.
- *3: Even if **Show Job Log** is Off in **System Setup**, it is displayed if a password is configured in **Change Password** in the **Admin. Menu** and the password has been authenticated.

Set./Adj. Menu

Limited items are displayed during printing. The displayed items are indicated by annotations.

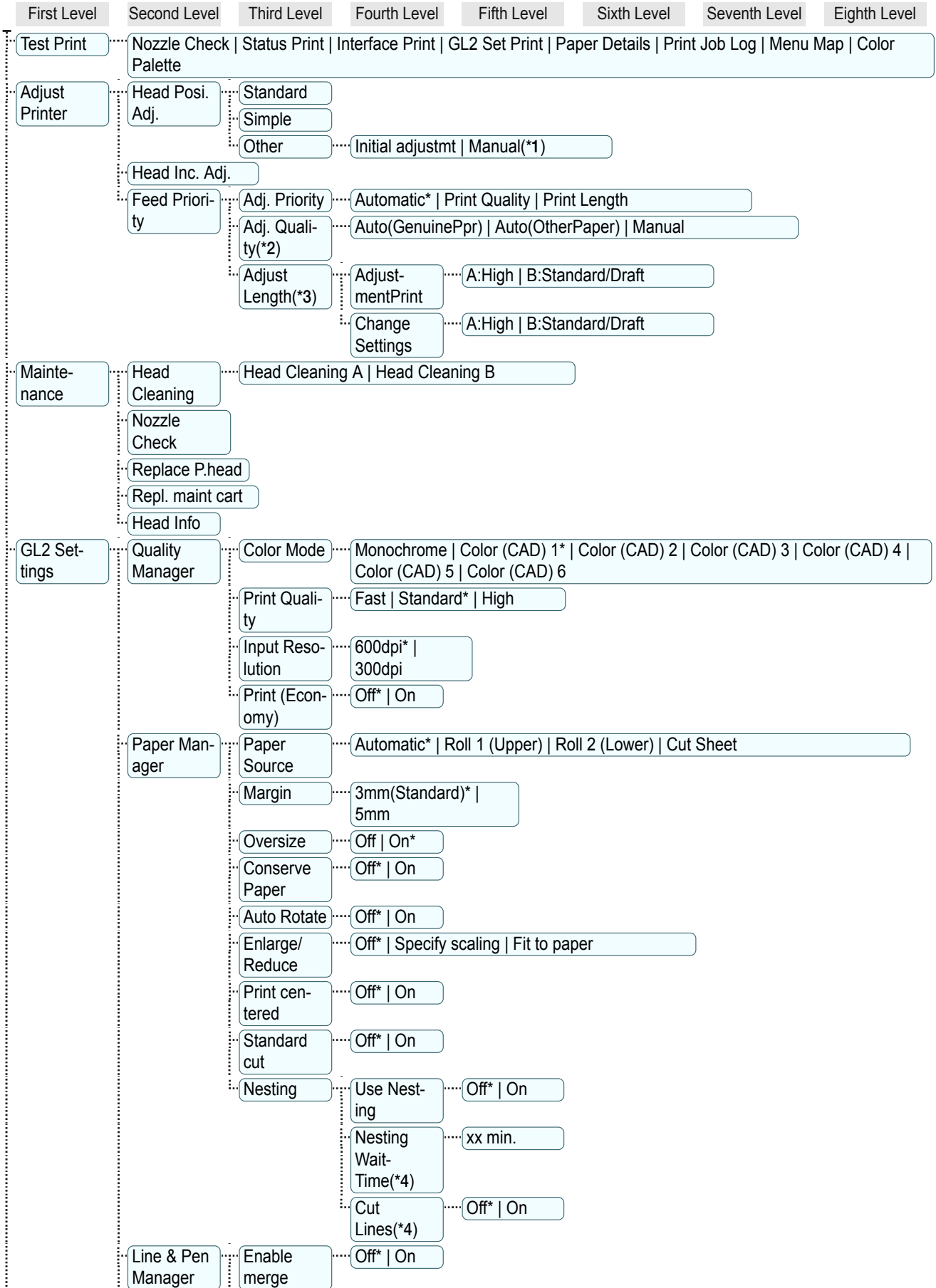

Control Panel

Printer Menu

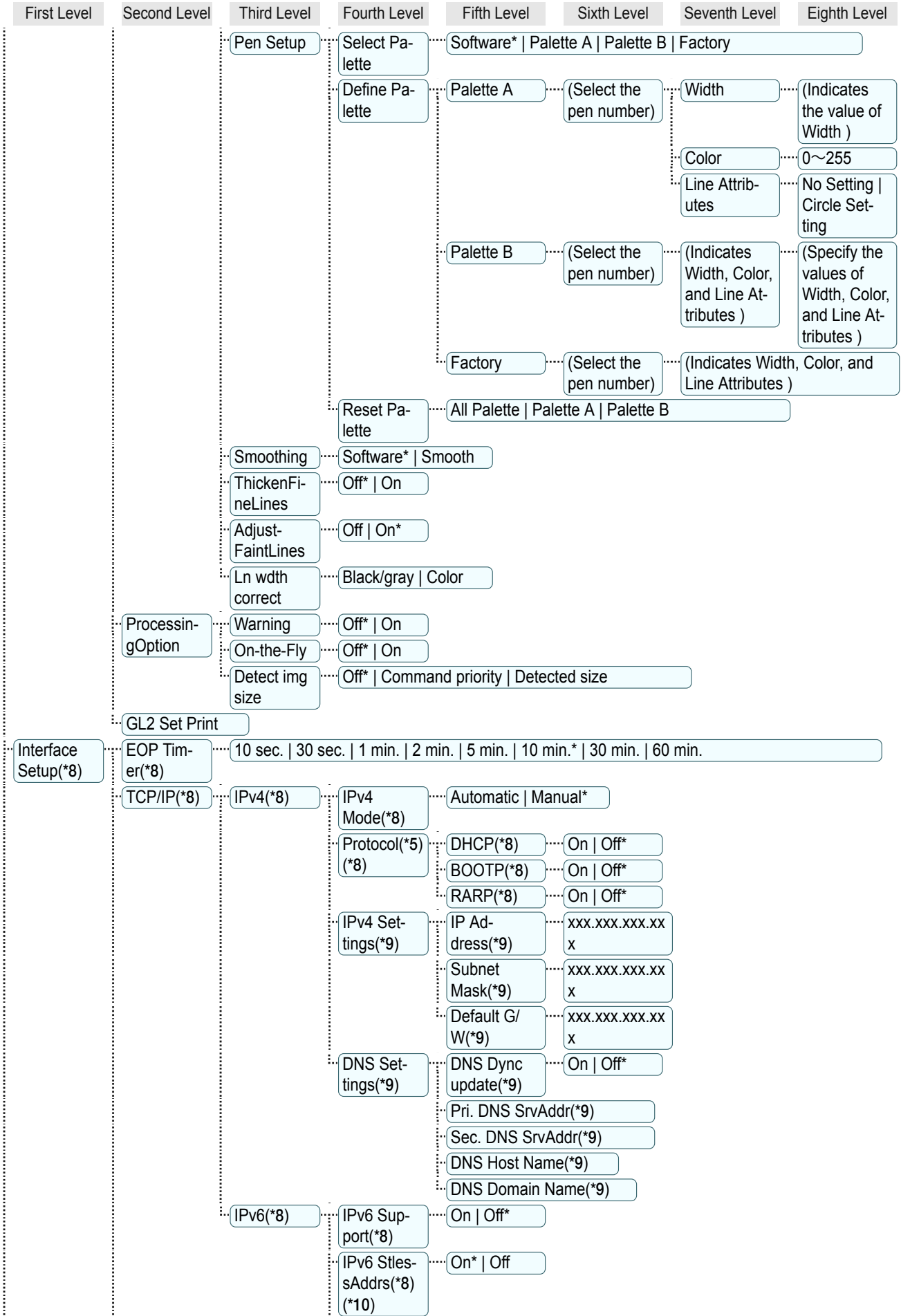

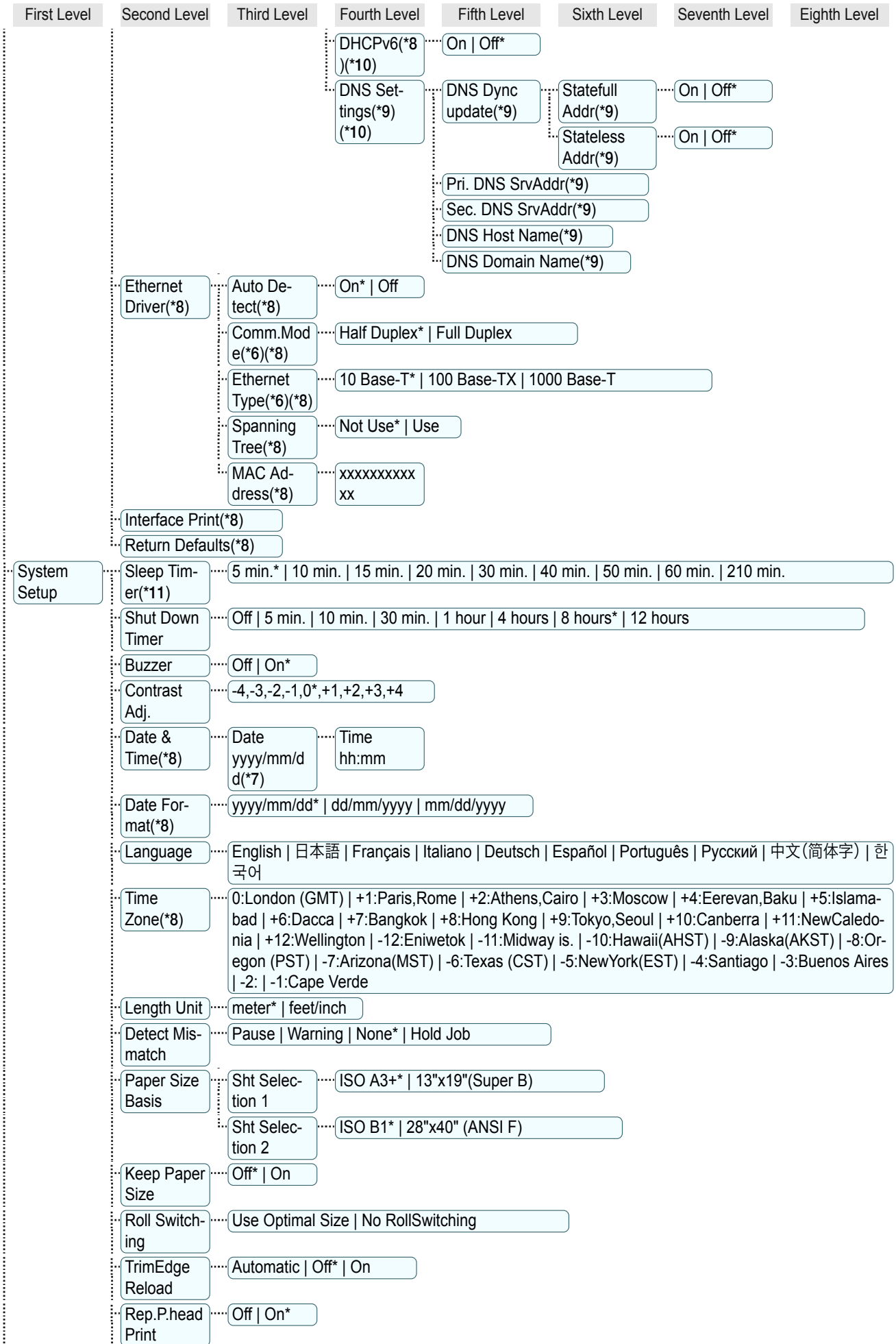

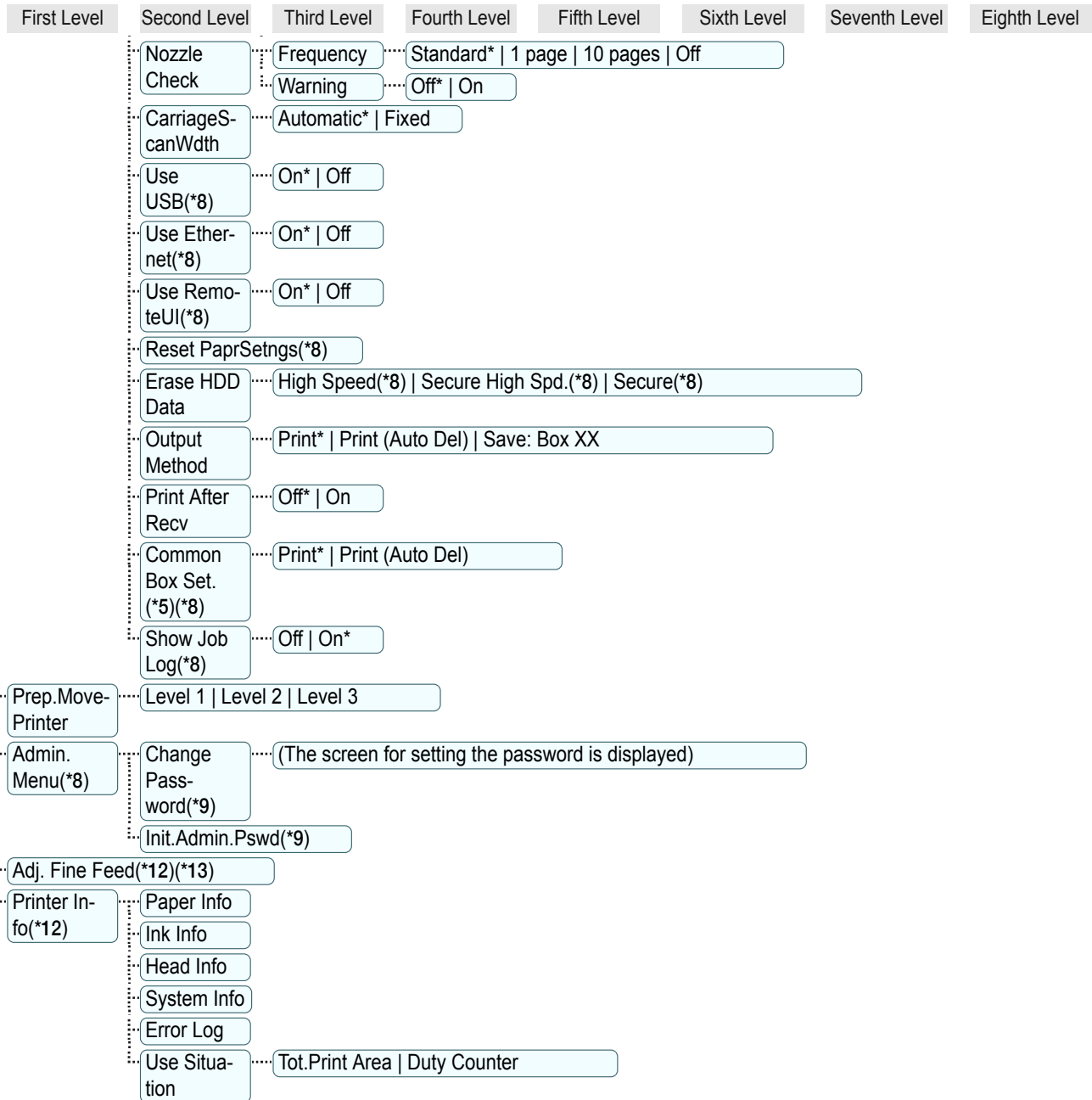

*1: Available after you have used **Standard** or **Initial adjustmt** in **Head Posi. Adj.** once.

*2: Available if **Adj. Priority** is **Automatic** or **Print Quality**.

*3: Available if **Adj. Priority** is **Automatic** or **Print Length**.

*4: Available only if **Use Nesting** is **On**.

*5: Not displayed if **IPv4 Mode** is **Manual**.

*6: Not displayed if **Auto Detect** is **On**.

*7: Follows the setting in **Date Format**.

*8: Restrictions apply if a password is configured using **Change Password** in the **Admin. Menu**.

Viewing and configuration is possible for administrators, and only viewing for other users.

*9: Restrictions apply if a password is configured using **Change Password** in the **Admin. Menu**.

Viewing and configuration is possible for administrators only.

*10: Not displayed if **IPv6 Support** is **Off**.

*11: Default setting for the time to enter the power save mode/Sleep mode is recommended.

*12: Displayed as the menu during printing while printing is in progress.

*13: Not displayed in the regular menu.

Menu Settings

Menu items are as follows.

The printer menu is classified into regular menu items available when no print job is in progress and menu during printing items only available while printing is in progress. see "Printer Menu Operations." →P.439

Regular menu	Menu during printing
Paper Menu	Not displayed
Ink Menu	The same Ink Menu as normal is displayed.
Job Menu	The same Job Menu as normal is displayed.
Set./Adj. Menu	A limited Set./Adj. Menu containing the following items is displayed. <ul style="list-style-type: none"> • Adj. Fine Feed (*1) • Printer Info

*1: Only displayed in the menu during printing. Not displayed in the regular menu.

For instructions on selecting menu items, see "Menu Operations." →P.440

For details on the displayed menu hierarchy, see "Menu Structure." →P.443

Paper Menu

The **Paper Menu** is not displayed during printing.

Setting Item	Description, Instructions	
Load Paper	Select one of Roll 1 (Upper) , Roll 2 (Lower) , or Cut Sheet . Load the paper in the selected Paper Feed Slot.	
Eject Paper	Remove the paper. (See "Removing the Roll from the Printer." →P.352) (See "Removing Sheets." →P.373)	
Chg. Paper Type (*1)	Change the media type. (See "Changing the Type of Paper." →P.350)	
Chg. Paper Size	Change the size of paper loaded. (See "Specifying the Paper Length." →P.352) (See "Paper Sizes." →P.332)	
ManageRemainRoll	Choose On to print a barcode at the end of a roll before you remove it. The printed barcode can be used in managing the amount of roll paper left. Choose Off if you prefer not to print the barcode. (See "Keeping Track of the Amount of Roll Paper Left." →P.358)	
Paper Details (The type of paper is displayed here.)(*1)	Head Height	Adjust the Printhead height. (See "Troubleshooting Paper Abrasion and Blurry Images." →P.562)
	Skew Check Lv.	If you print on Japanese paper (washi) or other handmade paper that has an irregular width, choose Loose for a higher skew detection threshold, or choose Off to disable skew detection. However, if paper is loaded askew when detection is Off , note that paper jams or Platen soiling may occur.
	Cutting Mode	Specify whether or not to cut with the standard round-bladed cutter. If you choose Automatic , the roll will be cut automatically using the Cutter Unit, depending on the printer driver settings. Select Eject to prevent printed documents from falling immediately after printing such as when you wait for the ink to dry, etc. Manual prints lines at the cut position instead of cutting after printing. (See "Specifying the Cutting Method for Rolls." →P.360)
	Cut Speed	Choose the cutting speed. The preset selection represents the optimal cutting speed for the type of paper. We recommend keeping the preset cutting speed. If you use adhesive paper, choosing Slow helps prevent adhesive from sticking to the cutter and keeps the cutter sharp.
	Trim Edge First(*2)	Selects whether or not to automatically cut the leading edge of the roll paper when roll paper is loaded.

Setting Item		Description, Instructions	
Paper Details	(The type of paper is displayed here.)(*1)	Trim Edge First(*2)	(See "Cutting the Leading Edge of Roll Paper Automatically.") →P.366
		CutDustReduct.	If you choose On , a line will be printed at the cut position when paper cutting is selected. This option reduces the amount of debris given off after cutting. It also helps prevent adhesive from sticking to the cutter and keeps the cutter sharp if you use adhesive paper. (See "Reducing Dust from Cutting Rolls.") →P.367
		VacuumStrngth	Specify the level of suction that holds paper against the Platen. (See "Adjusting the Vacuum Strength.") →P.570
		Scan Wait Time	Specify the time to wait for the ink to dry between each scan (after the printhead finishes moving in one direction), in consideration of how quickly the ink dries. Also specify the applicable area for the ink drying time. Select Entire area to apply the ink drying time after each scan until the document is fully printed. Select Leading edge to apply the ink drying time after each scan only in the area 110–160 mm from the leading edge. (The applicable length varies depending on the Print Quality setting.) Note that printing will take longer if you specify the Scan Wait Time setting. In particular, when Leading edge is selected, colors may be uneven in the boundary between the areas with and without a drying time.
		Roll DryingTime	Specify the time to wait for the ink to dry for each sheet.
		NearEnd RollMrgn	Specify the minimum margin at the leading edge of roll paper to ensure better printing quality at the leading edge. Note that if you choose 3mm , it may lower the printing quality at the leading edge and affect feeding accuracy. The printed surface may be scratched, and ink may adhere to the leading edge. It may also cause the Platen to become soiled.
		NearEnd Sht Mrgn	Specify a margin at the leading edge of sheets to ensure better printing quality at the leading edge. Note that if you choose 3mm , it may lower the printing quality at the leading edge and affect feeding accuracy. The printed surface may be scratched, and ink may adhere to the leading edge.
		BordlessOver-size	Select the amount of oversize extension of the original during borderless printing. Normally, we recommend that you set this to Standard . If it is set to Little , although it will reduce soiling on the back surface, white patches may remain on the printed surface.
		Width Detection	Specify this option to print inside boundaries or in other cases when specifying a particular starting position for printing. Paper width and skew are not detected if you select Off . If paper is loaded askew, paper jams or Platen soiling may occur.
	Return Defaults	Choose OK to restore Paper Details to the default values.	
Paper Details		Print the paper settings as specified in Paper Details .	
Keep Paper Type		Select On when printing on a particular type of paper regularly. (See "Changing the Type of Paper.") →P.350	

*1:For information on the types of paper the printer supports, refer to **Paper Reference Guide**.

(See "Displaying the Paper Reference Guide.") →P.335

The types of paper indicated in the printer driver, related software, and the printer Control Panel as well are updated when you install the printer driver from the User Software CD-ROM or if you update the information about the paper by using the Media Configuration Tool.

(See "Updating paper information.") →P.338 }

*2:When using the Stacker, do not set **Trim Edge First** to on. The cut leading edge of the paper may cause a paper jam.

Ink Menu

Setting Item	Description, Instructions
Rep. Ink Tank	Replace the Ink Tank at this point. Follow the instructions displayed to complete the required procedure. (See " Replacing Ink Tanks. ") →P.574
Head Cleaning A	Printhead cleaning options. (See "Cleaning the Printhead.") →P.586 Execute Head Cleaning A if printing is faint, oddly colored, or contains foreign substances.

Job Menu

Setting Item		Description, Instructions			
Print Job	Job List	(Choose a print job)	Delete	Delete the current job or queued jobs. (See " Managing the Job Queue (Deleting or Preempting Other Jobs). ") →P.523	
			Preempt Jobs	Print the job first after the current print job is finished. (See " Managing the Job Queue (Deleting or Preempting Other Jobs). ") →P.523	
Stored Job	Mailbox List	(Enter a password if one has been set.)	Job List	Print	Print the saved job.
				Delete	Delete the saved job.
			Print Job List		Print a list of saved print jobs.
Job Log(*2) (*3)	(Choose from information about the last three print jobs.)	Document Name		Indicates the document name of the selected print job.	
		User Name		Indicates the name of the user who sent the print job.	
		Page Count		Indicates the number of pages in the job.	
		Job Status		Indicates the printing results.	
		Print Start Time		Indicates when the print job was started.	
		Print End Time		Indicates when the print job was finished.	
		Print Time		Indicates the time required to print the job.	
		Output Img. Size		Indicates the image size in the print job.	
		Media Type		Indicates the type of paper in the print job.	
		Paper Consumed		Indicates the total amount of paper consumed.	
		Paper Length		Indicates the length of paper.	
		Paper Width		Indicates the width of paper.	
		Interface		Indicates the interface used for the print job.	
		Ink Consumed		Indicates a rough estimate of how much ink was consumed per job.(*1)	
		Print settings		A counter for maintenance purposes. Indicates job print settings.	
Head Height		A counter for maintenance purposes. Indicates the head height when jobs were printed.			
Temp./Humidity		A counter for maintenance purposes. Indicates the temperature and humidity when jobs were printed.			
Adjustment req.		A counter for maintenance purposes. Indicates adjustment conditions applied to jobs.			
Print Job Log		Print information to match the Job Log display state. This is not printed when the Job Log is configured to not display. The maximum number of history records in models fitted with a hard disk is 32. The maximum number of history records in models not fitted with a hard disk is 10.			
Pause Print		Choose On to stop printing.			

Setting Item	Description, Instructions
HDD Information	Indicates the total hard disk capacity and the mail box free space.

*1: Canon cannot guarantee the accuracy of these estimates. These estimates will also vary depending on the conditions of printer use.

*2: This is displayed when **Show Job Log** is **On** in **System Setup**.

*3: Even if **Show Job Log** is **Off** in **System Setup**, it is displayed if a password is configured in **Change Password** in the **Admin. Menu** and the password has been authenticated.



Set./Adj. Menu

Limited items are displayed during printing. The displayed items are indicated by annotations.

Setting Item	Description, Instructions		
Test Print	Nozzle Check	Print a test pattern to check the nozzles.	
	Status Print	Print information about the setting values and condition of the printer.	
	Interface Print	Print interface settings information.	
	GL2 Set Print	Print the settings as specified in GL2 Settings .	
	Paper Details	Print the paper settings as specified in Paper Details .	
	Print Job Log	Print information to match the Job Log display state. This is not printed when the Job Log is configured to not display. The maximum number of history records in models fitted with a hard disk is 32. The maximum number of history records in models not fitted with a hard disk is 10.	
	Menu Map	Print the menu structure.	
	Color Palette	Print the GL2 color palette.	
Adjust Printer	Head Posi. Adj.	Standard	An adjustment pattern is printed and the print position is automatically adjusted to fix misaligned printing. Select Standard if vertical lines in printed material are warped or colors are out of alignment. Select Standard also if the printing results are not improved by executing Simple . (See "Automatic Adjustment to Straighten Lines and Colors.") → P.556
		Simple	An adjustment pattern is printed and the print position is automatically adjusted to fix misaligned printing. Simple executes a simple adjustment in a short time. Select Simple when frequently adjusting the printhead, such as during daily maintenance. (See "Automatic Adjustment to Straighten Lines and Colors.") → P.556
	Other	Initial adjustmt	Printhead position adjustment is executed during the initial setup. If adjusting the printhead position has not been performed such as due to an error during initial setup or the state of the operating settings when replacing the printhead, select Initial adjustmt . (See "Adjustment When Installing the Printhead.") → P.559
		Manual	Input the setting values from the adjustment pattern printing results and adjust the printing position to fix misaligned printing. Normally, select Standard . However, when printing on special paper, or if printing is not improved after Standard , try Manual . (See "Manual Adjustment to Straighten Lines and Colors.") → P.558
Head Inc. Adj.		Print a test pattern for adjustment of the Printhead orientation. (See "Adjusting Line Misalignment.") → P.560	

Setting Item			Description, Instructions	
Adjust Printer	Feed Priority	Adj. Priority	Automatic	Specify exact paper feeding, if desired. Normally, select Automatic . Choose Print Quality for attractive printing. Choosing Print Quality also makes banding less noticeable. Choose Print Length if you prefer to feed the paper an exact amount.
			Print Quality	
			Print Length	
		Adj. Quality	Auto(GenuinePpr)	Specify this mode with paper identified in the Paper Reference Guide . (See "Displaying the Paper Reference Guide.") →P.335 The printer prints and reads a test pattern for automatic adjustment of the feed amount. (See "Automatic Banding Adjustment.") →P.565
	Auto(OtherPaper)		Specify this mode with paper not in the Paper Reference Guide . (See "Displaying the Paper Reference Guide.") →P.335 The printer prints and reads a test pattern for automatic adjustment of the feed amount. Note that this function takes more time and consumes more ink than Auto(GenuinePpr) . (See "Automatic Banding Adjustment.") →P.565	
	Manual		Use this mode with highly transparent media or other paper for which Auto(GenuinePpr) or Auto(OtherPaper) cannot be used. Print a test pattern for adjustment of the feed amount based on the type of paper. (See "Manual Banding Adjustment.") →P.566	
	Adjust Length	Adjustment-Print	A:High	Print a test pattern for particular types of paper to compensate for paper stretching or shrinkage, after which you enter the amount of adjustment. (See "Adjusting Line Length.") →P.568
			B:Standard/Draft	
		Change Settings	A:High	Displayed when you have selected Feed Priority > Adj. Priority > Print Length . Adjustment relative to the amount of stretching or shrinkage of the current paper. Enter either the adjustment results from AdjustmentPrint or the discrepancy that you measured (as a percentage). For paper that tends to stretch, increase the feed amount by choosing a higher adjustment value. For paper that tends to shrink, decrease the feed amount by choosing a lower adjustment value. (See "Adjusting Line Length.") →P.568
			B:Standard/Draft	
Maintenance	Head Cleaning		Clean the Printhead. (See "Cleaning the Printhead.") →P.586 Choose Head Cleaning A if printing is faint, oddly colored, or contains foreign substances. Choose Head Cleaning B if no ink is printed at all, or if printing is not improved by Head Cleaning A .	
	Nozzle Check		Print a test pattern to check the nozzles.	
	Replace P.head		Execute when replacing the Printhead. Follow the instructions displayed to complete the required procedure. (See "Replacing the Printhead.") →P.587 Not displayed during a warning message that the remaining Maintenance Cartridge capacity is low.	
	Repl. maint cart		Execute when replacing the Maintenance Cartridge. Follow the instructions displayed to complete the required procedure. (See "Replacing the Maintenance Cartridge.") →P.593	
	Head Info		Indicates information about the printhead.	

		Setting Item	Description, Instructions
GL2 Settings	Quality Manag- er	Monochrome	Print in monochrome.
		Color (CAD) 1	Print in standard colors.
		Color (CAD) 2	Print with approximate colors emulating Canon iPF750, iPF755, iPF650, iPF655, iPF760, iPF765.
		Color (CAD) 3	Print emulating the following printers, in colors resembling colors produced by these printers: Canon iPF500, iPF600, iPF700, iPF510, iPF610, iPF710, iPF605, iPF720, iPF810, iPF820, iPF815 and iPF825.
		Color (CAD) 4	Print emulating the HP Designjet 4000/4500, in colors resembling colors produced by these printers.
		Color (CAD) 5	Print emulating the HP Designjet T1100, in colors resembling colors produced by this printer.
		Color (CAD) 6	Print emulating the Oce ColorWave 300, in colors resembling colors produced by this printer.
		Print Quality	Choose the print quality.
		Input Resolution	Choose the printer input resolution, 600dpi or 300dpi .
	Print (Economy)	When On is selected, print using less ink. However, the quality is lower than regular printing. Select On to conserve ink such as the layout confirmation. Note that although Print (Economy) is only available when Fast is selected in Print Quality , it might not be available depending on the paper type.	
	Paper Manag- er	Paper Source	Choose the source of paper for HP-GL/2 printing.
		Margin	Specify the margin around paper. The margin for the trailing edge of sheets is 23 mm (0.9 in). However, if you have specified the leading margin in Paper Details , the larger of the setting values has priority.
		Oversize	Set the position of the margin relative to the image range. Choose Off to set the margin inside the image range. The image may be missing depending on the layout. Choose On to set the margin outside the image range. Although the image will not be missing, you should print on paper larger than the size of the image range plus the margins.
Conserve Paper		Conserves paper when printing.	
Auto Rotate		If the long side of an original is shorter than the roll width, the original is automatically rotated 90 degrees to conserve paper. Similarly, if the long side of an original in landscape orientation is longer than the roll width and the short side is shorter than the roll width, the original is repositioned to fit on the paper. HP RTL print jobs are not rotated. Because HP RTL images are not rotated even if the paper is rotated 90 degrees, images may be cut off or the blank paper may be ejected. In this case, set Auto Rotate to Off .	
Enlarge/Reduce		Enlarge or reduce the image. Choose Specify scaling to print based on the specified scaling value. The specified range is 25 to 400 %. Choose Fit to paper to print by resizing to fit the paper loaded in the printer. If Standard cut is On , the printing is resized to fit the standard paper size.	
Print centered		Print in the center of the paper.	

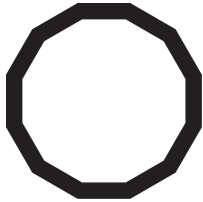
Setting Item		Description, Instructions		
GL2 Settings	Paper Manager	Standard cut	Automatically selects the best standard paper size from the width of the loaded roll paper and the image size and cuts the roll paper.	
		Nesting	Use Nesting	Selecting On will store print jobs until multiple documents can be arranged to fill up the roll width, instead of printing each print job as it is received.
			Nesting WaitTime	Specify a time to wait until printing, as desired.
			Cut Lines	Select On to print cut lines between each document on the roll.
	Line & Pen Manager	Enable merge		Specify whether to merge or print over colors where lines overlap. Choose Off to print the second line over the first. Choose On to merge all overlapping colors.
		Pen Set-up	Select Palette	As pen values, choose Software , Palette A , Palette B , or Factory . Choose Software to print according to software settings. Choose Palette A or Palette B to print using the value specified in Define Palette .
			Define Palette	Specify the Width , Color , and Line Attributes in the palette Pen no. . Choose Factory to confirm the values when Factory is selected in Select Palette . In Line Attributes , choose No Setting or Circle Setting as the processing for the ends and junctions of lines. <ul style="list-style-type: none"> If you choose No Setting  <ul style="list-style-type: none"> If you choose Circle Setting 
			Reset Palette	Restore Define Palette to the default palette settings.
		Smoothing		Choose whether to print arcs as smooth curved lines or as multiple connected line segments. <ul style="list-style-type: none"> If you choose Software <p>Operation is determined by the application. If nothing is specified by the application, the result is as shown in the figure.</p>  <p>Note: By default, this is a 72-sided figure</p>

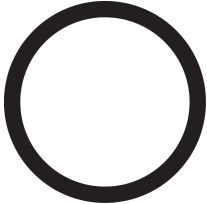
Setting Item		Description, Instructions			
GL2 Settings	Line & Pen Manager	Smoothing <ul style="list-style-type: none"> If you choose Smooth 			
		ThickenFineLines	Select On to print fine lines more distinctly.		
		AdjustFaintLines	If fine lines are printed in colors that do not match the colors of other shapes, selecting Off may help produce the expected results. However, lines in some colors may appear broken.		
		Ln width correct	Corrects by using a correction value that specifies the pen width. You can configure Black/gray and Color for each group. The specified range is -20 to +20.		
	ProcessingOption	Warning	Select On to have any GL2-related warnings displayed.		
		On-the-Fly	Selecting On will start printing jobs sooner if you are printing only HP RTL print jobs and printing would not start until later. However, images may be incomplete in some cases, so be sure to check the printing results.		
		Detect img size	Sets the method of deciding the region to output in order to print efficiently while avoiding missing images. If Off is selected and the data contains image range information, the image range information is followed. If Off is selected and the data does not contain image range information, a size with the maximum roll paper width of the printer for the width and 1.5 times the maximum roll paper width for the length is used. If Command priority is selected and the data contains image range information, the image range information is followed. If Command priority is selected and the data does not contain image range information, the detected minimum image area is used. If Detected size is selected, the detected minimum image area is used.		
	GL2 Set Print		Print GL2 settings information.		
	Interface Setup	EOP Timer		Specify the timeout period before cancellation of print jobs that cannot be received by the printer.	
		TCP/IP	IPv4	IPv4 Mode	Choose whether the printer IP address is configured automatically or a static IP address is entered manually.
Protocol				DHCP	Specify the protocol used to configure the IP address automatically.
				BOOTP	
			RARP		
IPv4 Settings			IP Address	Specify the printer network information when using a static IP address. Enter the IP address assigned to the printer, as well as the network subnet mask and default gateway. The value that was automatically configured is displayed if you have set IPv4 Mode to Automatic .	
			Subnet Mask		
			Default G/W		
DNS Settings			DNS Dync update	Specify whether DNS server registration is updated automatically.	
			Pri. DNS SrvAddr	Specify the DNS server address.	
	Sec. DNS SrvAddr				

		Setting Item			Description, Instructions	
Inter- face Setup	TCP/IP	IPv4	DNS Settings	DNS Host Name	Specify the DNS host name.	
				DNS Domain Name	Specify the DNS domain name.	
		IPv6	IPv6 Support			Specify whether to connect via IPv6.
			IPv6 Stateless			Specify whether a IPv6 stateless address is used.
			DHCPv6			Specify whether DHCPv6 settings are used.
			DNS Settings	DNS Dync update	Statefull Addr	Specify whether DNS server registration is updated auto- matically.
					State- less Addr	
			Pri. DNS SrvAddr			Specify the DNS server address.
			Sec. DNS SrvAddr			
			DNS Host Name			Specify the DNS host name.
	DNS Domain Name			Specify the DNS domain name.		
	Ether- net Driver	Auto Detect			Specify the communication method. To apply your changes, choose Register Setting . Choose On for automatic configuration of the LAN communication protocol. Choose Off to use settings values of Comm.Mode and Ethernet Type .	
		Comm.Mode			Choose the LAN communication method.	
		Ethernet Type			Choose the LAN transfer rate.	
		Spanning Tree			Choose whether spanning-tree packets are supported over the LAN.	
MAC Address			Indicates the MAC address.			
Interface Print					Print interface settings information.	
Return Defaults					Choose OK to restore Interface Setup settings to the default values.	
System Setup	Sleep Timer				Specify the period before the printer enters sleep mode.	
	Shut Down Timer				Sets the time until the printer turns off automatically. If no operations are performed on the printer for the duration of the time set in Shut Down Timer after entering Sleep mode, the printer automatically turns off.	
	Buzzer				Choose On for the buzzer to sound once for warnings and three times for errors.	
	Contrast Adj.				Adjust the Display Screen contrast level.	
	Date & Time	Date			Set the current date.	
		Time			Set the current time. Available only if the Date setting is specified.	
	Date Format				Specify the date format.	
	Language				Specify the language used on the Display Screen.	
	Time Zone				Specify the time zone. Time zone options indicate a main city in this time zone and the difference from Greenwich Mean Time.	
	Length Unit				Choose the display unit for length. Change the unit displayed for the remaining amount of roll paper, Tot.Print Area , and so on.	
Detect Mismatch				Specify printing behavior if the type and size of paper specified in the printer menu does not match the type and size in the printer driver.		

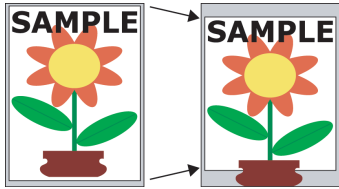
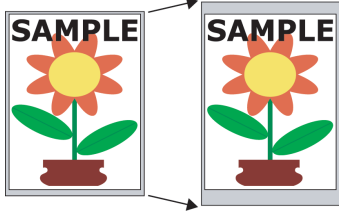
Setting Item		Description, Instructions
System Setup	Detect Mismatch	Choose Pause to have printing paused under these circumstances. Choose Warning to continue printing after notification. Choose None to continue printing without notification. Choose Hold Job to store jobs with mismatched types and sizes of paper on the printer hard disk, in a print queue awaiting processing. (See "Using the Printer Hard Disk.") →P.519
	Paper Size Basis	
	Sht Selection 1	If sheet size detection is activated, choose whether ISO A3+ or 13"x19"(Super B) is applied when a sheet of an intermediate size is detected.
	Sht Selection 2	If sheet size detection is activated, choose whether ISO B1 or 28"x40" (ANSI F) is applied when a sheet of an intermediate size is detected.
Keep Paper Size		<p>Choose On to use the paper size setting as the basis for printing instead of other settings. The margin setting of the printer menu will be used instead of the margin setting of the printer driver if the latter is smaller, which may prevent text or images in the margin from being printed.</p>  <p>Choose Off to give priority to margin settings. The larger value is used if the margin specified in the printer driver does not match the margin in the printer menu.</p> 
Roll Switching		<p>If you have selected Use Optimal Size, printing is performed by selecting the paper size that minimizes waste paper.</p> <p>If you have selected No RollSwitching, printing is performed on the paper fed to the platen.</p>
TrimEdge Reload		<p>Specify whether to trim the leading edge of the currently retracted roll when the roll is advanced. Cut the edge if you are concerned about any marks left on the roll when the roll is left in the retracted position.</p> <p>Specify On to have rolls cut when printing begins after Sleep mode or when the power is restored. Selecting Automatic will trim the edge when the roll has been in the retracted position for two days or more.</p>
Rep.P.head Print		<p>If you have selected On, the adjustment pattern is printed after replacing the Printhead and Printhead adjustment is performed. (See "Automatic Adjustment to Straighten Lines and Colors.") →P.556</p>
Nozzle Check		<p>In Frequency, specify the timing for automatic checks of nozzle clogging. Choose Standard to have the printer adjust the timing for checks based on the frequency of nozzle use. Choose 1 page to check once per page. Choose 10 pages to check once per 10 pages. Choose Off to not execute check.</p>

Setting Item		Description, Instructions	
System Setup	Nozzle Check	If On is selected in Warning , a warning may be displayed on the Control Panel depending on the result of the nozzle check.	
	CarriageScanWdth	Specify the scan width of the carriage during printing. Select Automatic for movement equivalent to the width of paper loaded. Selecting Fixed will reduce any soiling on the back of the paper, although printing may take a little longer.	
	Use USB	When Off is selected, the device can no longer be accessed via USB.	
	Use Ethernet	When Off is selected, the device can no longer be accessed via Ethernet.	
	Use RemoteUI	Choosing Off prohibits access from RemoteUI. Settings can only be configured from the control panel.	
	Reset PaprSetngs	Restores settings that you have changed with Media Configuration Tool to the default values.	
	Erase HDD Data	High Speed	Erases file management data for print job data stored on the printer's hard disk. (See "Erasing Data on the Printer's Hard Disk.") →P.477
		Secure High Spd.	Overwrites the entire hard disk with random data. (See "Erasing Data on the Printer's Hard Disk.") →P.477
		Secure	Overwrites the entire hard disk with 00, FF, and random data (one time each). Verification is performed to check if the data was correctly written. (See "Erasing Data on the Printer's Hard Disk.") →P.477
	Output Method	Print	Select the printing method for jobs received from software other than the printer driver. When using the printer driver, configure settings on the printer. To print as usual, select Print . Selecting Print (Auto Del) will print the job and then delete the data from the printer's hard disk. Selecting Save: Box 01 will only save the print job in the box, without printing it.
Print (Auto Del)			
Save: Box XX			
Print After Recv	A setting for jobs received from software other than the printer driver. When using the printer driver, configure settings on the printer. Select On to print the job after it has been saved.		
Common Box Set.	Select Print (Auto Del) to print without saving jobs in the box shared among multiple users.		
Show Job Log	Selecting Off prevents display of the log in Job Menu > Job Log . Additionally, the log is not printed if you choose Job Menu > Print Job Log . Note that because job logs are not collected, the Status Monitor accounting functions will not work correctly.		
Prep.MovePrinter		When transferring the printer to another location, choose the level of transfer and follow the instructions on the screen. (See "Preparing to Transfer the Printer.") →P.606 Not displayed during a warning message that the remaining Maintenance Cartridge capacity is low.	
Admin. Menu	Change Password	The password that can be entered is a number from 0 to 9999999. The restriction states and main items are shown below. For more specific information on restricted items, see "Menu Structure." →P.443 • Viewing and configuration by administrators only Change Password Init.Admin.Pswd	

Setting Item		Description, Instructions
Admin. Menu	Change Password	Etc. <ul style="list-style-type: none"> Viewing and configuration by administrators, and only viewing by other users Date & Time Time Zone Use RemoteUI Etc.
	Init.Admin.Pswd	Choose OK to restore the Admin. Menu password to the default values.
Adj. Fine Feed (*2) (*3)		Displayed when you have selected Feed Priority > Adj. Priority > Automatic or Print Quality . Fine-tune the feed amount manually.
Printer Info (*2)	Paper Info	Select one of Roll 1 (Upper) , Roll 2 (Lower) , or Cut Sheet . Displays information about the paper in the selected Paper Feed Slot.
	Ink Info	Indicates ink levels and maintenance cartridge capacity.
	Head Info	Indicates information about the printhead.
	System Info	Indicates the firmware version, serial number, and interface information.
	Error Log	Indicates the most recent error messages (up to five).
	Use Situation	A counter for maintenance purposes. Displays printer usage related information.

- *1: A rough estimate of how much ink was consumed per job is displayed. Actual ink consumption may be different. The average margin of error for estimates calculated according to Canon measurement conditions for ink costs is ±15%. Canon does not guarantee the accuracy of these estimates. Estimates may vary depending on conditions of use. Calculation of these estimates does not include ink consumed when cleaning printheads by forceful ejection of ink.
- *2: Displayed as the menu during printing while printing is in progress.
- *3: Not displayed in the regular menu.
- *4: If you have selected **Color (CAD) 2**, **Color (CAD) 3**, **Color (CAD) 4**, **Color (CAD) 5**, or **Color (CAD) 6**, it is not possible to match the colors and image quality produced by the specified printer exactly.

Status Print

You can print a **Status Print** report indicating the current status of the printer. With **Status Print**, information is printed regarding the printer firmware version, various settings, and the status of consumables.

Printing Status Print reports

- 1** Load paper.
When using sheets, load paper of A4/Letter size. You will need at least four sheets.
- 2** On the **Tab Selection screen** of the Control Panel, press ◀ or ▶ to select Settings/Adj. tab ().

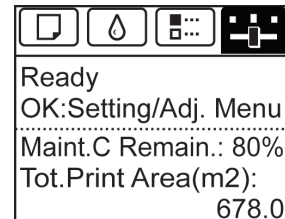

 **Note** • If the **Tab Selection screen** is not displayed, press the **Menu** button.

- 3** Press the **OK** button.
The **Set./Adj. Menu** is displayed.
- 4** Press **▲** or **▼** to select **Test Print**, and then press the **OK** button.
- 5** Press **▲** or **▼** to select **Status Print**, and then press the **OK** button.

Checking the information in **Status Print** reports

The following information is included in **Status Print** reports.

Canon imagePROGRAF iPFxxxx Status Print	Printer model
Firm	Firmware version
Boot	Boot ROM version
MIT(DBF)	MIT database format version
MIT(DB)	MIT database version
S/N	Printer serial number
Date	Indicates when the status print report was printed.

Paper Menu	Information on the loaded paper.												
<table border="1"> <tr> <td>Paper Type</td> <td></td> </tr> <tr> <td></td> <td>Roll1(Uppr)Media</td> </tr> <tr> <td></td> <td>Roll2(Lwr) Media</td> </tr> <tr> <td></td> <td>Cut Sheet</td> </tr> <tr> <td>ManageRemainRoll</td> <td></td> </tr> <tr> <td>Keep Paper Type</td> <td></td> </tr> </table>	Paper Type			Roll1(Uppr)Media		Roll2(Lwr) Media		Cut Sheet	ManageRemainRoll		Keep Paper Type		
Paper Type													
	Roll1(Uppr)Media												
	Roll2(Lwr) Media												
	Cut Sheet												
ManageRemainRoll													
Keep Paper Type													

Job Menu	Job-related information.						
<table border="1"> <tr> <td>Job Log</td> <td>A counter for maintenance purposes. Various information about previous jobs.</td> </tr> <tr> <td>HDD Information</td> <td rowspan="3">Indicates the total hard disk capacity and the mail box free space.</td> </tr> <tr> <td>Total capacity</td> </tr> <tr> <td>Box free space</td> </tr> </table>	Job Log	A counter for maintenance purposes. Various information about previous jobs.	HDD Information	Indicates the total hard disk capacity and the mail box free space.	Total capacity	Box free space	
Job Log	A counter for maintenance purposes. Various information about previous jobs.						
HDD Information	Indicates the total hard disk capacity and the mail box free space.						
Total capacity							
Box free space							

Set./Adj. Menu	Settings and adjustment information.																										
<table border="1"> <tr> <td>System Setup</td> <td>Printer system settings, as well as settings regarding warnings and errors.</td> </tr> <tr> <td></td> <td>Sleep Timer</td> </tr> <tr> <td></td> <td>Shut Down Timer</td> </tr> <tr> <td></td> <td>Buzzer</td> </tr> <tr> <td></td> <td>Contrast Adj.</td> </tr> <tr> <td></td> <td>Date Format</td> </tr> <tr> <td></td> <td>Language</td> </tr> <tr> <td></td> <td>Time Zone</td> </tr> <tr> <td></td> <td>Length Unit</td> </tr> <tr> <td></td> <td>Detect Mismatch</td> </tr> <tr> <td>Paper Size Basis</td> <td>Paper-related settings.</td> </tr> <tr> <td></td> <td>Sht Selection 1</td> </tr> <tr> <td></td> <td>Sht Selection 2</td> </tr> </table>	System Setup	Printer system settings, as well as settings regarding warnings and errors.		Sleep Timer		Shut Down Timer		Buzzer		Contrast Adj.		Date Format		Language		Time Zone		Length Unit		Detect Mismatch	Paper Size Basis	Paper-related settings.		Sht Selection 1		Sht Selection 2	
System Setup	Printer system settings, as well as settings regarding warnings and errors.																										
	Sleep Timer																										
	Shut Down Timer																										
	Buzzer																										
	Contrast Adj.																										
	Date Format																										
	Language																										
	Time Zone																										
	Length Unit																										
	Detect Mismatch																										
Paper Size Basis	Paper-related settings.																										
	Sht Selection 1																										
	Sht Selection 2																										

	Keep Paper Size		Paper-related settings.
	Roll Switching		
	TrimEdge Reload		
	Rep.P.head Print		Settings after a test pattern was printed following head replacement.
	Nozzle Check		Nozzle-check settings.
		Frequency	
		Warning	
	CarriageScanWdth		Carriage scan width setting.
	Use USB		Use USB settings values.
	Use Ethernet		Use Ethernet settings values.
	Use RemoteUI		Settings used by RemoteUI.
	Output Method		Print job settings.
	Print After Recv		
	Common Box Set.		
	Show Job Log		
Adjust Printer		Adjustment settings.	
Head Posi. Adj.		A counter for maintenance purposes. Head position adjustment values for previous jobs.	
	Adjust Log		
Printer Info		Ink information, RAM usage, and a record of errors.	
Ink Info		Ink-related information.	
	MC	Maintenance Cartridge capacity (%)	
	(The ink color is displayed here.)	Ink levels. The remaining ink is displayed in a five-level scale.	
System Info		Indicates the total amount of RAM.	
	RAM		
Error Log		The past five error codes.	

HEAD LOT NUMBER/ DATE OF INSTALLATION		The printhead lot number and date and time when the Printhead was installed.
	HEAD INFxx	
PARTS STATUS		Utilization status of replacement parts that require servicing.
	COUNTER	
COUNTER		Utilization status of the cutter, media, and other items (indicating how much they have been used).
	CUTTER	
	MEDIA	
	LIFE TTL	
	LIFE ROLL	
	LIFE ROLL2	
	LIFE CUTSHEET	
MEDIA 1-7,OTHER		
	NAME	
	TTL	

	ROLL	Utilization status of the cutter, media, and other items (indicating how much they have been used).
	ROLL2	
	CUTSHEET	
AFTER INSTALLATION		
DUTY		Counters for maintenance purposes. Needed when service is requested.
	UNIT:m2	
	UNIT:sq.f	
	UNIT:A4 Sheet	
	UNIT:Letter Sheet	

Printing Interface Setting Reports

You can print an **Interface Print** report indicating the current interface settings values of the printer.

Printing **Interface Print** reports

- 1** Load the paper.
If using sheets, load paper A4/Letter-sized, you will need at least three sheets.
- 2** On the **Tab Selection screen** of the Control Panel, press ◀ or ▶ to select the Settings/Adj. tab ().

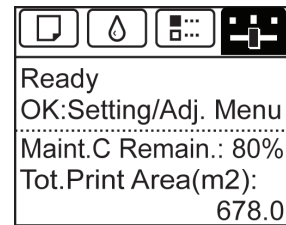

 **Note** • If the **Tab Selection screen** is not displayed, press the **Menu** button.

- 3** Press the **OK** button.
The **Set./Adj. Menu** is displayed.
- 4** Press ▲ or ▼ to select **Test Print**, and then press the **OK** button.
- 5** Press ▲ or ▼ to select **Interface Print**, and then press the **OK** button.

Confirming **Interface Print** information

The following information is included in the **Interface Print** report.

Canon imagePROGRAF iPFxxxx Interface Print	Printer model
Firm	Firmware Version
Boot	Boot ROM Version
MIT(DBF)	MIT Database Format Version
MIT(DB)	MIT Database Version
S/N	Printer serial number
Date	The date when the interface setup print report was printed.
EOP Timer	Specify the timeout period before cancellation of print jobs that cannot be received by the printer.

Control Panel
Printer Menu

TCP/IPv4	Frame Type	IPv4 settings values.
	Use DHCP	
	Use BOOTP	
	Use RARP	
	Enable DNS Dynamic Update	
	Use Zeroconf Function	
	IP Address	
	Subnet Mask	
	Gateway Address	
	LPD Printing	
	IPP Printing	
	IPP Printer URI	
	RAW Printing	
	Raw Mode Bi-direction	
	FTP Printing	
	WSD Printing	
	Use Discovery	
	Scope	
	Primary DNS Server Address	
	Secondary DNS Server Address	
	DNS Host Name	
DNS Domain Name		
MulticastDNS ServiceName		
SNMPv1		
SNMPv3		

TCP/IPv6	Use IPv6	IPv6 settings values.	
	Use DHCPv6		Stateful Address
			Prefix Length
			Primary DNS Server Address
			Secondary DNS Server Address
	Use a stateless address		Stateless Address 1
			Prefix Length 1
			Stateless Address 2
			Prefix Length 2
			Stateless Address 3
			Prefix Length 3
			Stateless Address 4
			Prefix Length 4
			Stateless Address 5
			Prefix Length 5
			Stateless Address 6
			Prefix Length 6
	Use a link-local Address		Link-Local Address
			Prefix Length
	Use a manual address		IP Address

TCP/IPv6	Use a manual address	Prefix Length	IPv6 settings values.
		Default Router Address	
		Prefix Length	
		Primary DNS Server Address	
		Secondary DNS Server Address	
	Use the same host name and domain name as IPv4	DNS Host Name	
		DNS Domain Name	
	Perform dynamic updating of stateful addresses		
	Dynamically update the stateless address		
	Dynamically update the manual address		
Frame Type			
Use Zeroconf Function			
MulticastDNS ServiceName			

TCP/IPv6	LPD Printing	IPv6 settings values.
	IPP Printing	
	IPP Printer URI	
	RAW Printing	
	Raw Mode Bi-direction	
Network Interface	Physical Interface	Network interface settings values.
	Transmission Rate	
	MAC Address	
	Auto Detect	
	Communication	
	Ethernet Type	
	Spanning Tree	
	Use the Jumbo Frame Function	

Setting Control panel access lock

This section describes the procedure for setting and releasing the control panel access lock.



- The setting can only be changed in administrator mode.

1

Start RemoteUI and log on to it.
Start the web browser and enter the following URL in the **Location** (or **Address**) box to display the RemoteUI page.

http://printer IP address or name/

Input example: http://xxx.xxx.xxx.xxx/

2

Select **Administrator Mode** and click **Logon**.



- If a password has been set on the printer, enter the password.

3

Click **Device Selection** on the left side to display the **Extended Functions** page.

4

Click **Edit** at the top right to display the **Change Extended Functions** page.

5 In the **Control panel access lock** setting, select the **On** check box to set the access lock and select the **Off** check box to release the access lock.

6 Click **OK**.

7 When the change settings confirmation message is displayed, click **OK**.



- Initializing the network settings will also restore the default value of the printer's IP address. As a result, the RemoteUI page cannot be displayed in the web browser after this procedure. Because of this, if you initialize the network settings while the **Control panel access lock** is set, the **Control panel access lock** can no longer be set to **Off**. If this happens, configure the IP address again using the **imagePROGRAF Device Setup Utility**. (See "Configuring the IP Address Using imagePROGRAF Device Setup Utility." → P.497)

Basic Printing Workflow	15
Enhanced Printing Options	29
Windows Software	157
Mac OS Software	267
Handling and Use of Paper	331
Control Panel	429

Printer Parts

Printer parts	468
Hard Disk	475
Optional accessories	479

Network Setting	481
Print Job Management	501
Adjustments for Better Print Quality	555
Maintenance and Consumables	573
Troubleshooting	617
Error Message	651
Specifications	673
Appendix	677

Printer parts

Front	468
Printer Front	469
Stacker	470
Back	471
Top Cover (Inside)	472
Carriage	473
Ink Tank Cover (Inside)	474
Control Panel	430

Front

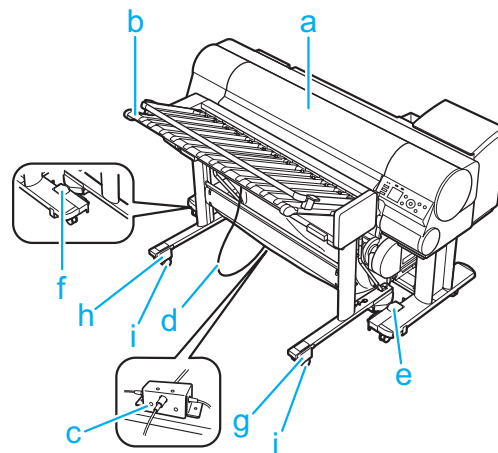

a Printer

This is the main printer unit. It performs printing according to the various settings.

(See "Printer Front.") →P.469

b Stacker

This is the stacker unit. It stacks and holds the printed documents ejected from the Printer.

(See "Stacker.") →P.470

c Relay box

This relays the cable connections from the Printer, Stacker, Alignment unit left, and Alignment unit right.

d Stacker cable

This cable connects the Stacker and Printer.

e Docking unit right

Install the Stacker on the Printer using the markings in this area as a guide.

f Docking unit left

Install the Stacker on the Printer using the markings in this area as a guide.

g Alignment unit right

Adjust this part to set the vertical position of the Stacker relative to the Printer.

h Alignment unit left

Adjust this part to set the vertical position of the Stacker relative to the Printer.

i Locking Caster

Lock to immobilize the caster.

Be sure to unlock all of the casters before you move it. If you move it while the casters are locked, the floor may become scratched.

Printer Front

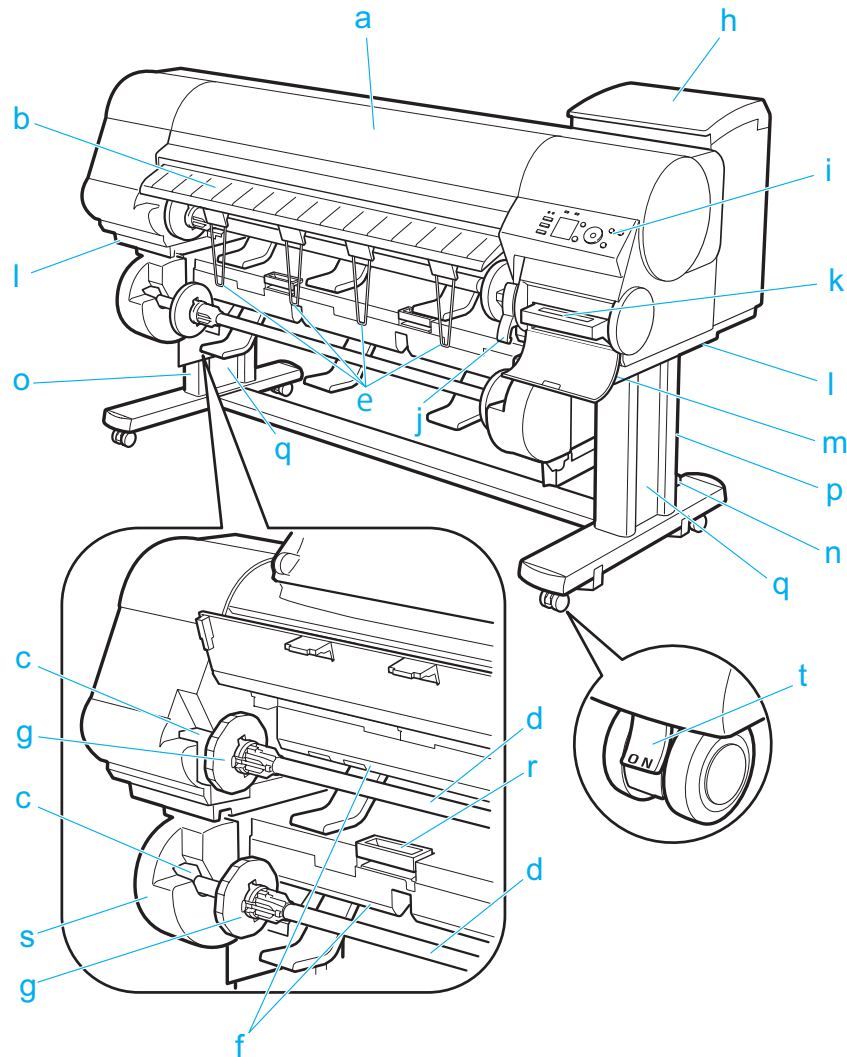

a Top Cover

Open this cover to install the Printhead, load paper, and remove any jammed paper from inside the printer as needed. (See "Top Cover (Inside).") →P.472

b Ejection Guide

Guides printed documents as they are ejected. Open this guide when loading a roll.

c Roll Holder Slot

Slide the Roll Holder into this slot.

d Roll Holder

Load the roll on this holder.

e Ejection Support

Prevents printed documents from winding around the Roll Holder or being drawn into the Paper Feed Slot.

f Paper Feed Slot

When loading a roll, insert the edge of the roll paper here. You can load rolls in two positions, on the printer side in the Roll 1 (Upper) position and on the roll unit side in the Roll 2 (Lower) position.

g Holder Stopper

Secure rolls on the Roll Holder with this part.

h Ink Tank Cover

Open this cover to replace an Ink Tank. (See "Ink Tank Cover (Inside).") →P.474

i Control Panel

Use this panel to operate the printer and check the printer status. (See "Control Panel.") →P.430

j Release Lever

Releases the Paper Retainer. Lift this lever toward the front of the printer when loading paper.

k Maintenance Cartridge

Ink used for maintenance purposes such as head cleaning is absorbed. (Replace the cartridge when it is full.)

l Carrying Handles

When carrying the printer, have six people hold it by these handles under both sides.

m Maintenance Cartridge Cover

Open this cover to replace the Maintenance Cartridge.

n Stand

A stand that holds the printer. Equipped with casters to facilitate moving it.

o Stand L

The left leg of the Stand.

p Stand R

The right leg of the Stand.

q Leg Covers

Covers for Stand L and Stand R.

r Roll Unit Lever

Hold this lever to pull out the Roll Unit.

s Roll Unit

A unit for loading two rolls.

t Stopper

Locks the Stand casters.

Always release the Stopper before moving the printer. Moving the printer while the Stopper is locked may scratch the casters or the floor.

Stacker

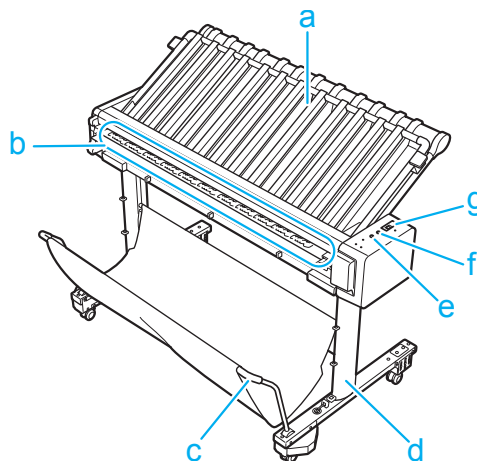
**a Canopy**

Holds and prevents the stacked paper in the Stacker from rising. To remove the paper, open it upward.

b Paper Feed Slot

The Paper Feed Slot for the Stacker.

This part feeds the printed documents ejected from the Printer into the Stacker.

c Output Stacker

A cloth tray that catches ejected documents.

The Output Stacker can be opened and closed using the rod in front.

d Stacker stand

A stand that holds the Stacker. It is equipped with casters to facilitate movement.

e Lamp 1 (Blue)

Lit when the Stacker is ready.

When not lit up, printed documents cannot be accepted from the Printer.

f Lamp 2 (Green)

Lit when the Stacker Power switch is on.

g Power switch

Turns the Stacker on and off.

Back

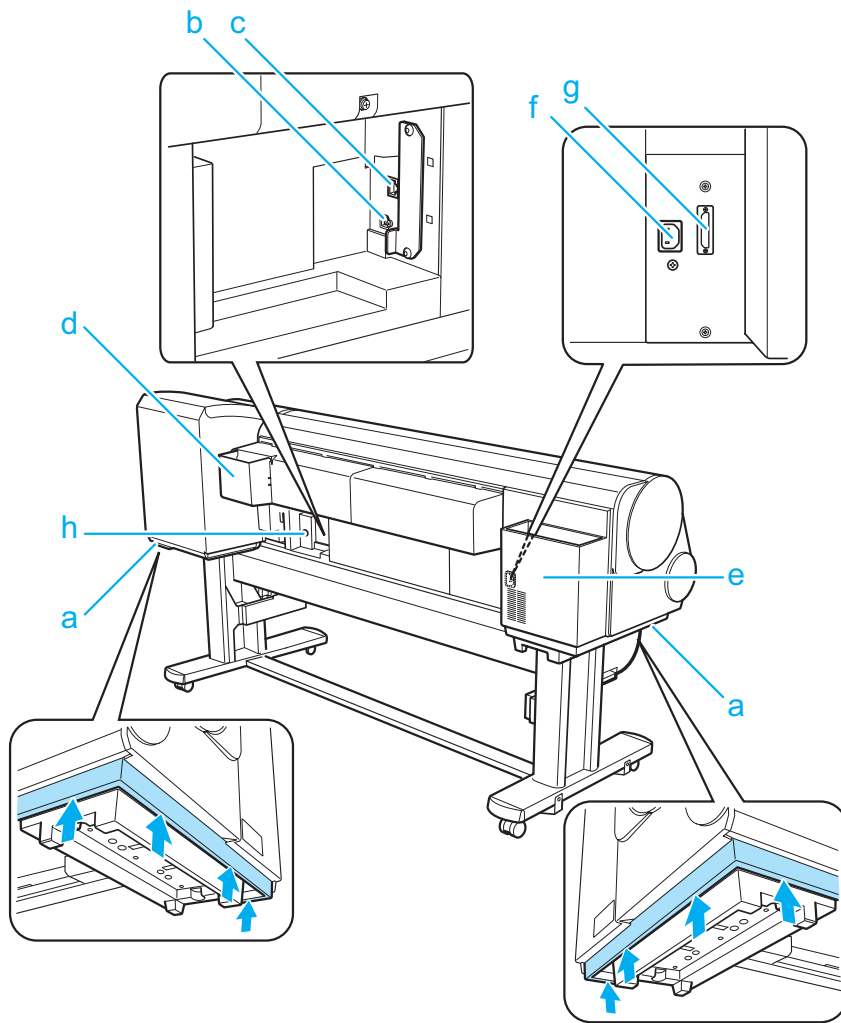

a Carrying Handles

When carrying the printer, have six people hold it by these handles under both sides.

b USB Port

Connect a USB cable to this port. The printer is compatible with Hi-Speed USB connections.

c Ethernet Port

Connect an Ethernet cable to this port. The lamp is lit if the Ethernet cable is connected correctly and communication is possible between the computer and printer.

d Manual Pocket

Store printer manuals in this pocket.

- e Accessory Pocket**
Store assembly tools, Roll Holder attachments, and other items in this pocket.
- f Power Supply Connector**
Connect the power cord to this connector.
- g Roll Unit Power Supply Inlet**
Connect the connection cord for the Roll Unit.
- h Connector**
Connect the connection cord for the Stacker.

Top Cover (Inside)

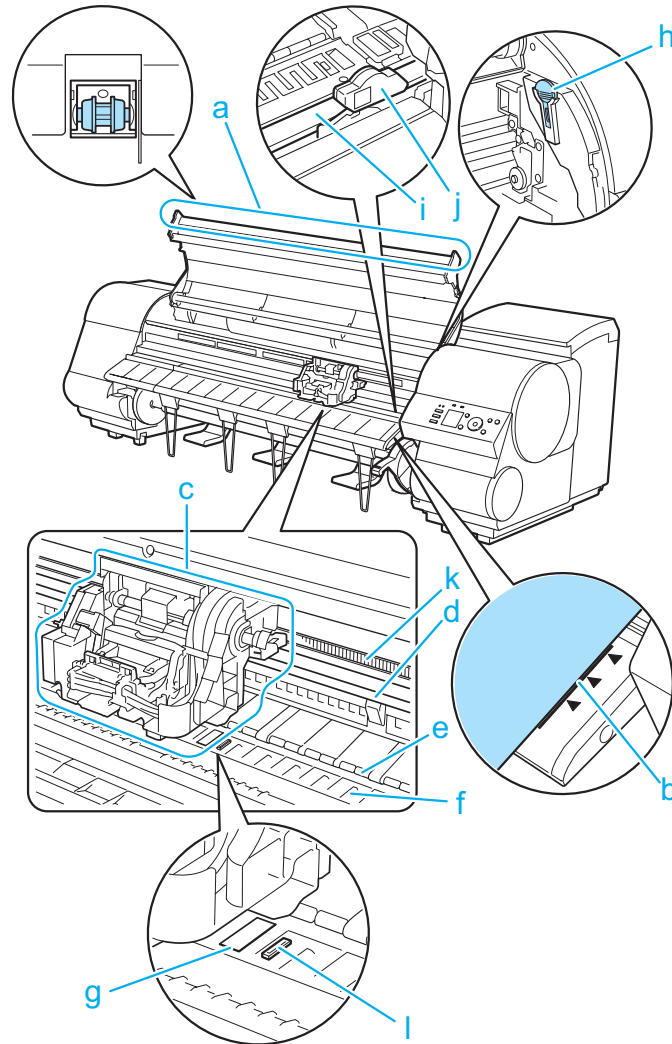

- a Top Cover Roller**
Prevents paper from rising when ejected.
- b Paper Alignment Line**
Align paper with this line when loading it.
- c Carriage**
Moves the Printhead. The carriage serves a key role in printing. (See "Carriage.") →P.473
- d Carriage Shaft**
The Carriage slides along this shaft.
- e Paper Retainer**
Important in supplying the paper. This retainer holds paper as it is fed.

f Platen

The Printhead moves across the platen to print. Vacuum holes on the platen hold paper in place.

g Borderless Printing Ink Grooves

For catching ink outside the edges of paper during borderless printing.

h Cleaning Brush

When cleaning inside the printer under the Top Cover, use this brush to sweep away paper dust on the Platen. Also use the brush to move the blue Switch on the Platen.

i Cutter Rail

The Cutter Unit passes over this rail to cut paper.

j Cutter Unit

A round-bladed cutter for automatic paper cutting.

k Linear Scale

The linear scale serves a key role in detecting the Carriage position. Be careful not to touch this part when cleaning inside the Top Cover or clearing paper jams.

l Switch

Set the switch to the side opposite ● if the edges of printed images are blurred. Set the switch to the ● side before borderless printing. (See "Setting the Blue Switch on the Platen." →P.638)

Carriage

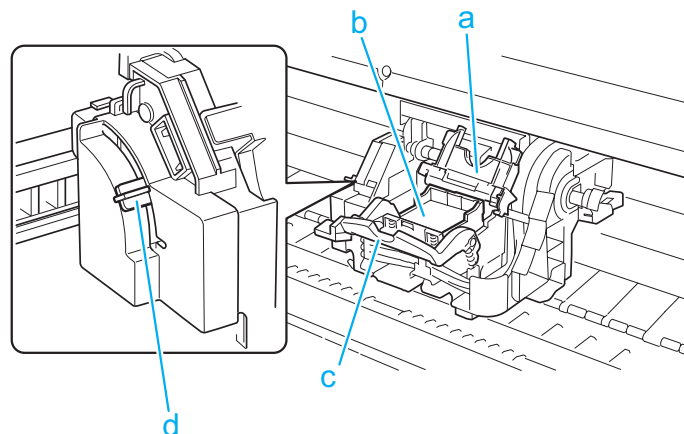
**a Printhead Fixer Cover**

Holds the Printhead in place.

b Printhead

The printhead is equipped with ink nozzles. The carriage serves a key role in printing.

c Printhead Fixer Lever

Locks the Printhead Fixer Cover.

d Angle Adjustment Lever

Use this lever to fine-tune the printer to correct misalignment of printed lines.

Ink Tank Cover (Inside)

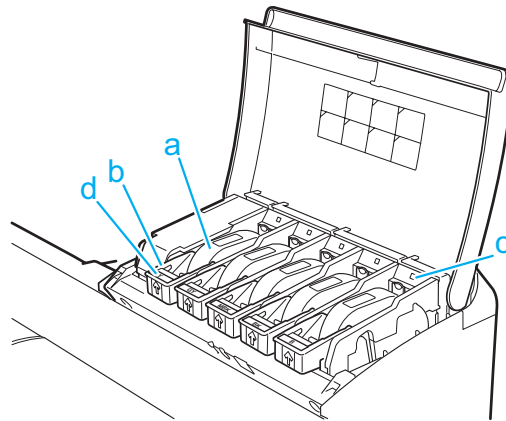

Note: The figure shows the printer as loaded with 700 ml (23.7 fl oz) Ink Tank.

a Ink Tanks

Cartridges of ink in various colors.

b Ink Tank Lock Lever

A lever that locks the Ink Tank in place and protects it. Lift and lower the lever when replacing an Ink Tank. To open it, lift the stopper of the lever until it stops, and then push it down toward the front. To close it, push it down until it clicks into place.

c Ink Lamp (Red)

Indicates the state of the Ink Tank as follows when the Ink Tank Cover is opened.

- On

The Ink Tank is installed correctly.

- Off

No Ink Tank is installed, or the ink level detection function is disabled.

- Flashing Slowly

Not much ink is left.

- Flashing Rapidly

Ink tank is empty.

d Ink Color Label

Load an Ink Tank that matches the color and name on this label.

Hard Disk

Printer Hard Disk Operations 475

Checking the Free Hard Disk Space 476

Erasing Data on the Printer's Hard Disk 477

Printer Hard Disk Operations

Printer hard disk operations are available from the following programs and interfaces.

- Printer driver
- Free Layout
- Color imageRUNNER Enlargement Copy
- Preview
- imagePROGRAF Status Monitor
- imagePROGRAF Printmonitor
- RemoteUI
- Control Panel

The hard disk operations available through each interface are as follows.

Operation		<ul style="list-style-type: none"> • Printer driver • Free Layout • Color imageRUNNER Enlargement Copy • Preview 	<ul style="list-style-type: none"> • imagePROGRAF Status Monitor • imagePROGRAF Printmonitor 	RemoteUI	Control Panel
Saving print jobs	Save in mail box	Yes	No	No	No
	Do Not Save Print Jobs in the Common Box	No	No	No	Yes
	Save print jobs sent from sources other than the printer driver	No	No	No	Yes
Operations with saved jobs	Print saved jobs	No	Yes	Yes	Yes
	Delete saved jobs	No	Yes	Yes	Yes
Job queue management	Display job queue	No	Yes	Yes	Yes
	Delete	No	Yes	Yes	Yes
	Preempt Jobs	No	Yes	Yes	Yes
	Operations with held jobs	No	Yes	Yes	Yes
Mail box management	Move saved jobs	No	Yes	Yes	No
	Modify saved jobs	No	Yes	Yes	No
	Modify mail boxes	No	Yes	Yes	No
	Print a list of saved jobs	No	No	No	Yes
	Display a list of saved jobs	No	Yes	Yes	Yes
Other operations	Display free hard disk space	No	Yes	Yes	Yes
	Initialize hard disk	No	No	No	Yes
	Display the time of printing	No	Yes	Yes	Yes
Display error messages		No	Yes	Yes	Yes

Checking the Free Hard Disk Space

Check the space available on the printer's hard disk as follows.
This operation is available from the Control Panel, in RemoteUI, imagePROGRAF Status Monitor, and imagePROGRAF Printmonitor.

Using the Control Panel

- 1 On the **Tab Selection screen** of the Control Panel, press ◀ or ▶ to select the Job tab ().



 **Note** • If the **Tab Selection screen** is not displayed, press the **Menu** button.

- 2 Press the **OK** button.
The **Job Menu** is displayed.
- 3 Press ▲ or ▼ to select **HDD Information**, and then press the **OK** button.

Using RemoteUI

To view the box list, select **Stored Job** in Job Management. On the **Stored Job** page, the free hard disk space is shown in the upper-right corner when boxes are listed.

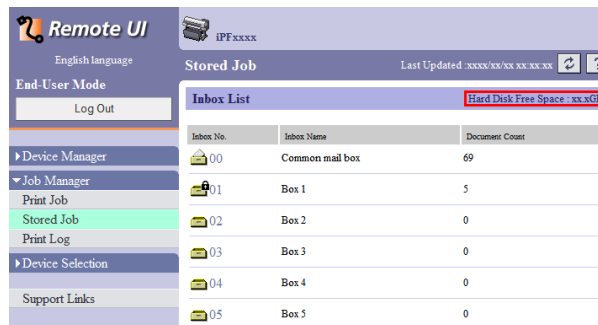

For details, refer to the RemoteUI help file.

Using imagePROGRAF Status Monitor

The **Hard Disk** sheet shows the free hard disk space.

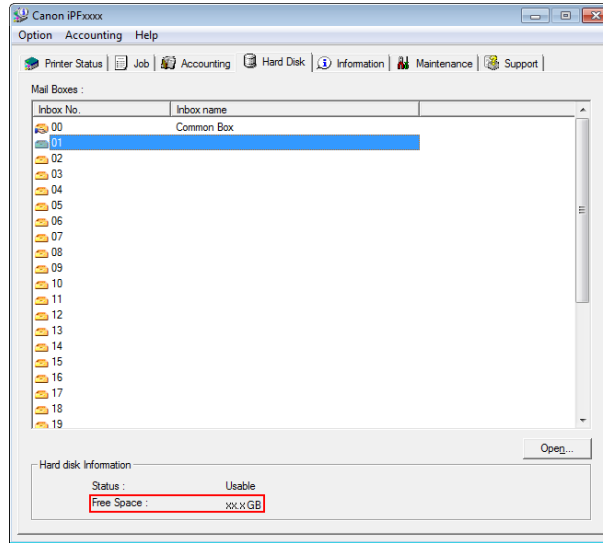

For details, refer to the imagePROGRAF Status Monitor help file.

Using imagePROGRAF Printmonitor

The **Hard Disk** pane shows the free hard disk space.

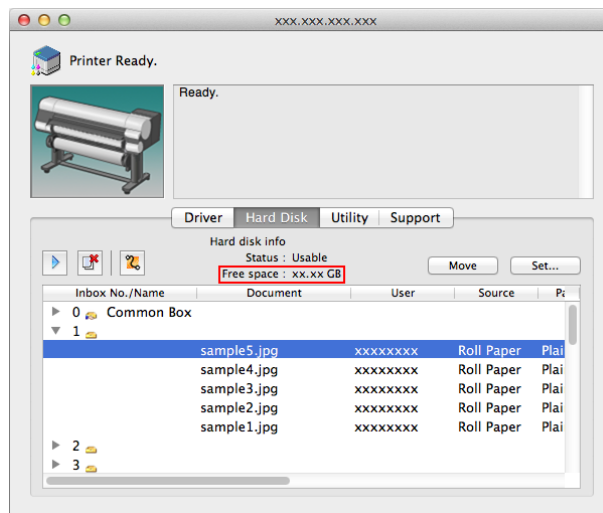

For details, refer to the imagePROGRAF Printmonitor help file.

Erasing Data on the Printer's Hard Disk

When erasing all data on the hard disk, choose from the following three options. This operation is only available from the Control Panel.

Erasure Method	Details
High Speed	Erases file management data for print job data stored on the printer's hard disk. Choose this method for relatively fast erasure. Because only the file management data is erased, the print job data itself is not erased. Note that it may be possible to read this data using commercial data recovery software.
Secure High Spd.	Overwrites the entire hard disk with random data. No verification is performed to check if the data was correctly written. Choose this method to erase highly confidential data. Note that it may be possible to read the overwritten data using specialized data recovery tools.
Secure	Overwrites the entire hard disk with 00, FF, and random data (one time each). Verification is performed to check if the data was correctly written. Choose this method to erase especially confidential data. It is virtually impossible to recover the overwritten data. Conforms to the DoD5220.22-M standard of the U.S. Department of Defense.



- For a more secure method of preventing data recovery, we recommend physically or magnetically destroying the hard disk. In this case, the hard disk can no longer be used.
- **Erase HDD Data** is not available if there is a job queue. Additionally, print jobs are not processed during execution of **Erase HDD Data**.

1 On the **Tab Selection screen** of the Control Panel, press ◀ or ▶ to select the Settings/Adj. tab ().

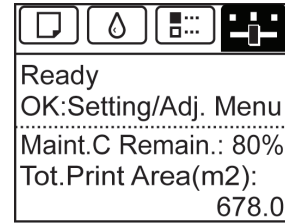

- If the **Tab Selection screen** is not displayed, press the **Menu** button.

2 Press the **OK** button.
The **Set./Adj. Menu** is displayed.

3 Press ▲ or ▼ to select **System Setup**, and then press the **OK** button.

4 Press ▲ or ▼ to select **Erase HDD Data**, and then press the **OK** button.

5 Press ▲ or ▼ to select **High Speed**, **Secure High Spd.**, or **Secure**, and then press the **OK** button to display the confirmation screen.



- If a password has been set on the printer, the **Admin.Pswd** screen is displayed. In this case, enter the password and press the **OK** button to go to the next step.
- As for the time required for deletion, confirm it on the Control Panel. However, when **High Speed** is selected, this finishes in several seconds.

6 Press ▲ or ▼ to select **Yes**, and then press the **OK** button to start erasure.
After the printer hard disk is erased, the printer automatically restarts.

Optional accessories

Roll Holder Set	368
-----------------------	-----

Memo

Basic Printing Workflow	15
Enhanced Printing Options	29
Windows Software	157
Mac OS Software	267
Handling and Use of Paper	331
Control Panel	429
Printer Parts	467

Network Setting

Network Environment	482
Using RemoteUI	484
Initial Settings	486
Mac OS Settings	493
Other Settings	494
Device Setup Utility (Windows)	497

Print Job Management	501
Adjustments for Better Print Quality	555
Maintenance and Consumables	573
Troubleshooting	617
Error Message	651
Specifications	673
Appendix	677

Network Environment

Network Environment

System requirements

The system requirements, which vary depending on your network, are as follows.

- Printing over a TCP/IP network (when using IPv4)

- Compatible operating systems

- Windows XP
- Windows Server 2003
- Windows Server 2003 x64
- Windows Server 2003 R2
- Windows Server 2003 R2 x64
- Windows Vista
- Windows Vista x64
- Windows Server 2008
- Windows Server 2008 x64
- Windows 7
- Windows 7 x64
- Windows Server 2008 R2 x64
- Windows 8
- Windows 8 x64
- Windows Server 2012 x64
- Windows 8.1
- Windows 8.1 x64
- Windows Server 2012 R2 x64
- OS X v10.6.8 or later

- Printing over a TCP/IP network (when using IPv6)

- Compatible operating systems

- Windows Vista
- Windows Vista x64
- Windows Server 2008
- Windows Server 2008 x64
- Windows 7
- Windows 7 x64
- Windows Server 2008 R2 x64
- Windows 8
- Windows 8 x64
- Windows Server 2012 x64
- Windows 8.1
- Windows 8.1 x64
- Windows Server 2012 R2 x64
- OS X v10.6.8 or later



Note

- When using IPv6, you must specify IPv6 on the Control Panel or in RemoteUI. For instructions, "Configuring TCP/IPv6 Network Settings" [→P.488](#) or see "Configuring the Printer's TCP/IP Network Settings With RemoteUI." [→P.490](#)

Network Environment

After confirming what type of network environment you will connect the printer to, set up the printer and computers as needed. For the specifications of the network interface, see "Specifications." [→P.674](#)

- Example of a Windows network

In Windows networks, print over TCP/IP.

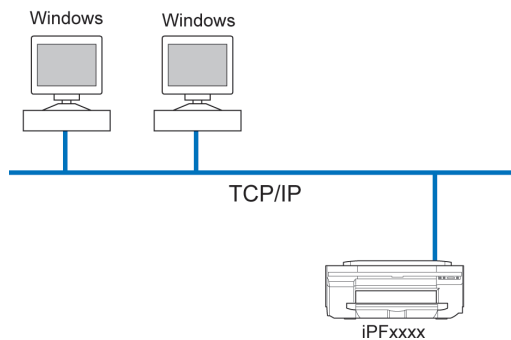

Note

- NetBIOS is not supported.

- Example of a Mac OS network

In Mac OS networks, print over TCP/IP using the Bonjour function.

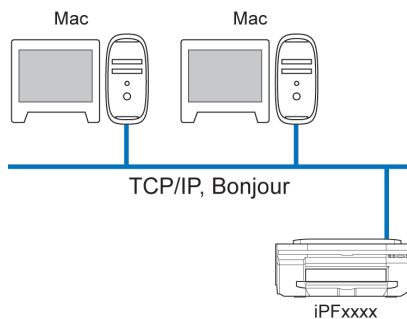

Using RemoteUI

Using RemoteUI

RemoteUI is software with which you can access the printer via the network from your Web browser to confirm the printer status, operate jobs, and configure the settings. Since the software (Web server) for using RemoteUI is built in the printer, preparing software other than a Web browser is unnecessary. You can use RemoteUI if an image-PROGRAF printer on a network is connected to your computer. If you start your Web browser and specify the IP address of the printer, the RemoteUI screen is displayed, and you can use RemoteUI.



- To use RemoteUI, an IP address must be set on the printer in advance. For the method of setting an IP address, see "Configuring the IP Address on the Printer." →P.486

What You Can Do With RemoteUI

With RemoteUI, you can access the printer via a network, configure network settings, and display the current status of the printer, various types of information, the processing status of jobs, etc.

Starting RemoteUI

Start RemoteUI by the following operations.

- Start your Web browser.
- Enter the following URL in **Address** or **Location**.
http://printer IP address or name/
Example: http://xxx.xxx.xxx.xxx/
- The RemoteUI screen is displayed.

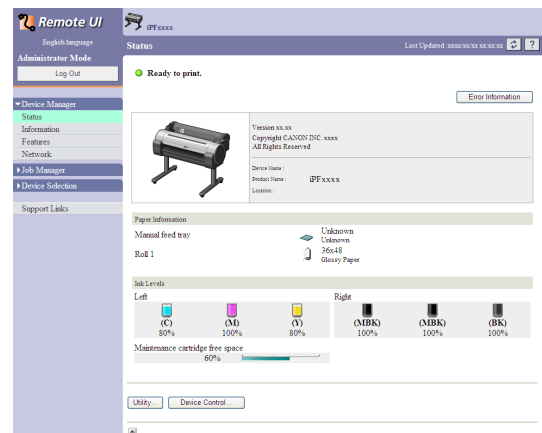

- The screen slightly differs depending on the model of printer.

Configuring the Network With RemoteUI

For details on configuring printer settings for networks, refer to the following topics.

- Configuring the Printer's TCP/IP Network Settings With RemoteUI →P.490
- Specifying Printer-Related Information →P.494

**Important**

- For the Web browser, use Netscape Navigator 6.0 or later, Internet Explorer 5.01 or later, or Firefox 1.5 or later. For Mac OS X, Safari 1.32 or later or 2.03 or later also is supported.
- This cannot be used connected via a proxy server. In environments where a proxy server is used, add the printer's IP address to **Exceptions** (addresses accessed without a proxy server) in the web browser proxy server settings. (Settings may vary depending on the network environment.)
- Enable JavaScript and cookies in the web browser.
- If you access RemoteUI with the printer name instead of its IP address, make sure the DNS settings are correctly configured.
- Depending on the network environment, you may not be able to start RemoteUI.
- Confirm whether **System Setup > Use RemoteUI** is set to **On** on the Control Panel of the printer.

**Note**

- RemoteUI also offers many other features. You can display the ink levels, check error messages and other status information, and cancel print jobs.
- By factory default, the English screen is displayed. To change the display language, select the desired language under **Language** before logging on in administrator mode.
- If you login in Administrator Mode, you can configure to use the Jumbo Frame function in the **Network** page. However, this function might not be able to be used depending on the network environment.

Initial Settings

- Configuring the IP Address on the Printer 486
 - Configuring the IP Address Using imagePROGRAF Device Setup Utility 497
 - Configuring the IP Address Using the Printer Control Panel 486
 - Configuring the IP Address Using ARP and PING Commands 487
- Configuring TCP/IPv6 Network Settings 488
- Configuring the Printer Driver Destination (Windows) 489
- Configuring the Printer Driver Destination (Mac OS) 489
- Configuring the Printer's TCP/IP Network Settings With RemoteUI 490

Configuring the IP Address on the Printer

You must configure the printer's IP address before using the printer in a TCP/IP network.

The printer's IP address is configured automatically when you install the printer driver following the instructions in the Setup Guide.

Configure the IP address by using **imagePROGRAF Device Setup Utility**, the printer Control Panel, or ARP or PING commands, if the IP address is changed, or if you change the printer connection mode to a network connection. For details on configuring the IP address, refer to the following topics.

- **Configuring the IP Address Using imagePROGRAF Device Setup Utility** →P.497 (Windows)
- **Configuring the IP Address Using the Printer Control Panel** →P.486
- **Configuring the IP Address Using ARP and PING Commands** →P.487



Important

- If you use a DHCP server for automatic assignment of the printer's IP address, printing may no longer be possible after the printer is turned off and on. This is because an IP address different from before has been assigned. Thus, when using DHCP server functions, consult your network administrator and configure the settings in one of the following ways.
 - Configure the setting for dynamic DNS updating
In the printer menu, either set **DNS Dync update** to **On**, or activate the setting **Enable DNS Dynamic Update** in RemoteUI.
(See "Menu Settings.") →P.449
(See "Configuring the Printer's TCP/IP Network Settings With RemoteUI.") →P.490
 - Configure the setting for assignment of the same IP address each time the printer starts up



Note

- We recommend configuring the printer's IP address even if you will use the printer in networks other than TCP/IP networks. Configuring the printer's IP address enables you to use RemoteUI to configure the network settings and manage the printer with a web browser.
For details on RemoteUI, see "Using RemoteUI." →P.484

Configuring the IP Address Using the Printer Control Panel

This topic describes how to configure the printer's IP address on the Control Panel.

- 1** On the **Tab Selection screen** of the Control Panel, press ◀ or ▶ to select the Settings/Adj. tab ().

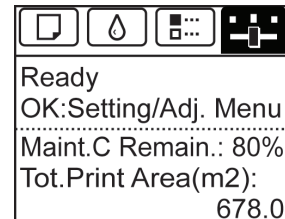

Note

- If the **Tab Selection screen** is not displayed, press the **Menu** button.

2 Press the **OK** button.
The **Set./Adj. Menu** is displayed.

3 Press **▲** or **▼** to select **Interface Setup**, and then press the **OK** button.

4 Press **▲** or **▼** to select **TCP/IP**, and then press the **OK** button.

5 Press **▲** or **▼** to select **IPv4**, and then press the **OK** button.

6 Press **▲** or **▼** to select **IPv4 Settings**, and then press the **OK** button.

7 Press **▲** or **▼** to select **IP Address**, and then press the **OK** button.

8 After you press **◀** or **▶** to select the input field, numerical input is possible.

9 Press the **▲** or **▼** button to enter the value.

- Note** • Pressing the **▲** button increases the number by 1. The maximum value is 9, after which 0 is displayed.
- Note** • Pressing the **▼** button decreases the number by 1. The minimum value is 0, after which 9 is displayed.
- Hold down **▲** or **▼** to increase or decrease the value continuously.
- Make sure the IP address you enter for the printer is not the same as any computer IP address in your network.

10 Repeat steps 8 and 9 to complete the settings, and then press the **OK** button.

11 Press the **Menu** button.
If you have changed the settings, a confirmation message is displayed. Press **▲** or **▼** to select **Yes**, and then press the **OK** button.

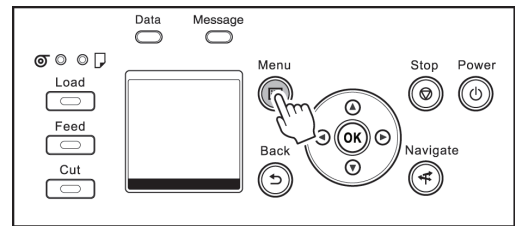

- Important** • Be sure to complete step 11. This will activate the values you have entered.
- Important** • If an error message is displayed, check the settings and correct any invalid values.

- Note** • You can also specify the subnet mask and default gateway on the Control Panel.

Configuring the IP Address Using ARP and PING Commands

This topic describes how to configure the IP address using ARP and PING commands. To use the ARP and PING commands, you will need to know the printer's MAC address. You can confirm the MAC address on the Control Panel.

1 Check the printer's MAC address.
You can confirm the MAC address on the Control Panel as follows:

1. On the **Tab Selection screen** of the Control Panel, press **◀** or **▶** to select the **Settings/Adj. tab** ().

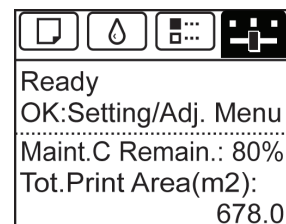

2. Press the **OK** button.
The **Set./Adj. Menu** is displayed.
3. Press **▲** or **▼** to select **Interface Setup**, and then press the **OK** button.
4. Press **▲** or **▼** to select **Ethernet Driver**, and then press the **OK** button.
5. Press **▲** or **▼** to select **MAC Address**, and then press the **OK** button.



Note

- If the **Tab Selection screen** is not displayed, press the **Menu** button.
- You can investigate the MAC address by printing an interface setting report. (See "Printing Interface Setting Reports.") →P.463

2 In Windows, open a command prompt, or in Mac OS, start Terminal.

3 Execute the following command to add entries to the ARP table for managing IP addresses and corresponding MAC addresses.

arp -s [IP address] [the printer's MAC address you have verified]
Example: arp -s xxx.xxx.xxx.xxx 00-1E-8F-xx-xx-xx



Note

- In Mac OS when using Terminal, enter the arp command in the format arp -s xxx.xxx.xxx.xxx 00:1E:8F:xx:xx:xx. For details, refer to the help file for the command line.

4 Execute the following command to send the IP address to the printer and configure it.
ping [IP address as specified in the ARP command] -l 479
Example: ping xxx.xxx.xxx.xxx -l 479



Note

- In -l, the l is the letter l.
- In Mac OS when using Terminal, enter the ping command in the format ping -s 479 xxx.xxx.xxx.xxx. For details, refer to the help file for the command line.



Note

- The subnet mask and default gateway are set to 0.0.0.0. Use RemoteUI to change the subnet mask and default gateway to match your network settings. For details on RemoteUI, see "Using RemoteUI." →P.484

Configuring TCP/IPv6 Network Settings

When printing in a TCP/IPv6 network, you must configure the TCP/IPv6 settings on the Control Panel. Follow the steps below to configure the TCP/IPv6 network settings.

1 On the **Tab Selection screen** of the Control Panel, press **◀** or **▶** to select the Settings/Adj. tab ().

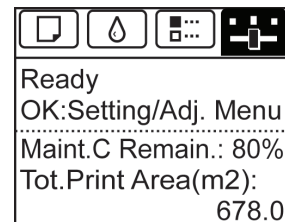

Note

- If the **Tab Selection screen** is not displayed, press the **Menu** button.

2 Press the **OK** button.
The **Set./Adj. Menu** is displayed.

3 Press **▲** or **▼** to select **Interface Setup**, and then press the **OK** button.

4 Press **▲** or **▼** to select **TCP/IP**, and then press the **OK** button.

- 5 Press ▲ or ▼ to select **IPv6**, and then press the **OK** button.
- 6 Press ▲ or ▼ to select **IPv6 Support**, and then press the **OK** button.
- 7 Press ▲ or ▼ to select **On**, and then press the **OK** button.



Important

- Once you set **IPv6 Support** to **On**, the **IPv6 StlessAddrs** setting takes effect.



Note

- You can also configure **IPv6 StlessAddrs** and **DHCPv6** from the printer Control Panel.

Configuring the Printer Driver Destination (Windows)

This topic describes how to specify the printer driver destination if the printer's IP address is changed, or if you will use the printer over a network connection instead of via USB connection.

The procedure described below is the configuration based on the LPR or Raw protocol using the standard TCP/IP port in Windows (**Standard TCP/IP Port**).



Important

- If you will use the printer in a TCP/IP network, make sure the printer's IP address is configured correctly.

- [Configuring the IP Address on the Printer](#) → P.486



Note

- This section describes the procedure in Windows 7.

- 1 Open the **Devices and Printers** window.
- 2 Right-click the icon of this printer and choose **Printer Properties** to open the printer properties window.
- 3 Click the **Port** tab to display the **Port** sheet.
- 4 Click **Add Port** to display the **Printer Ports** dialog box.
- 5 In the **Available Port** list, select **Standard TCP/IP Port**.
- 6 Click **New Port**.
After the wizard starts, a window is displayed for the **Welcome to the Add Standard TCP/IP Printer Port Wizard**.
- 7 Click **Next**.
- 8 In **Printer Name or IP Address**, enter the printer's IP address. If the DNS is configured, you can also enter the DNS Domain Name.
- 9 Follow the instructions on the screen to add a printer port.
- 10 Click **Close** to close the **Printer Ports** dialog box.
- 11 Make sure the printer port you added is displayed under **Ports**, and that the port is selected.
- 12 Click **Close** to close the printer properties window.

Configuring the Printer Driver Destination (Mac OS)

Specify the printer driver destination as follows if the printer's IP address is changed, or if you will use the printer over a network connection instead of via USB connection.

- If you switch to printing in a TCP/IP network, or if the printer's IP address is changed, see "Configuring the Destination in TCP/IP Networks ." →P.493
- If you switch to printing in a Bonjour network, see "Configuring the Destination for Bonjour Network ." →P.493

Configuring the Printer's TCP/IP Network Settings With RemoteUI

Follow the steps below to configure the TCP/IP network settings.

When using an IPv4 IP address

1 Start the web browser and enter the following URL in the **Location** (or **Address**) box to display the RemoteUI page.
 http://**printer IP address or name**/
 Example: http://xxx.xxx.xxx.xxx/

2 Select **Administrator Mode** and click **Logon**.

 **Note** • If a password has been set on the printer, enter the password.

3 Click **Network** in the **Device Manager** menu at left to display the **Network** page.

4 Click **Edit** in the upper-right corner of the **TCP/IPv4** group to display the **Edit TCP/IP Protocol Settings** page.

5 Refer to the TCP/IP Settings Items table to complete the settings.

TCP/IP Settings Items

Item	Details	Default Setting
Use DHCP	Activate this setting to use DHCP for configuring the IP address.	Off
Use BOOTP	Activate this setting to use BOOTP for configuring the IP address.	Off
Use RARP	Activate this setting to use RARP for configuring the IP address.	Off
Enable DNS Dynamic Update	Activate this setting to perform DNS server registration automatically.	Off
Use Zeroconf Function	Activate this setting to use Bonjour.	On
IP Address	Specify the printer's IP address.	0.0.0.0
Subnet Mask	Specify the printer's subnet mask.	0.0.0.0
Gateway Address	Specify the printer's default gateway.	0.0.0.0
LPD Printing	Activate this setting to use LDP Printing.	On
IPP Printing	Activate this setting to use IPP Printing.	On
IPP Printer URI	Specify the URI of the printer used for IPP printing using up to 252 characters.	printer
RAW Printing	Activate this setting to use Raw Printing.	On
RAW Mode Bi-direction	Activate this setting to use Raw mode bidirectional communication.	Off
FTP Printing	Activate this setting to use FTP Printing.	On
Use Discovery	Activate this setting to use SLP Discovery function.	On
Scope	Enter the SLP search range.	default
SMTP Server Address	Specify the SMTP server's IP address. You can also specify the SMTP server domain name, if desired.	0.0.0.0
Primary DNS Server Address	Specify the IP address of the primary DNS server.	0.0.0.0
Secondary DNS Server Address	Specify the IP address of the secondary DNS server.	0.0.0.0

Item	Details	Default Setting
DNS Host Name	Specify the printer host name, up to 63 characters (1–63 characters). Use single-byte letters, numbers, and - (hyphens). Do not use numbers or - for the first character or - for the last character.	NB-18GBipxxxxxx
DNS Domain Name	Specify the printer domain name, up to 63 characters. Use single-byte letters, numbers, - (hyphens), and . (periods). Do not use numbers, -, or . for the first character, or - or . for the last character.	blank
Multicast DNS Service Name	Specify the printer's Multicast DNS service name. (1–63 characters) This name will be displayed when Bonjour functions are used.	Canon iPFxxxx (xxxxxx)

6 Click **OK** to display the **Network** page.



- If you specify to configure the IP address using DHCP, BOOTP, or RARP, there must be a server that supports such protocol running in the network.
- If you specify to configure the IP address using DHCP, BOOTP, or RARP, the IP address obtained by this method is used first. If you cannot obtain the IP address, the address specified in **IP Address** is used.
- It takes up to two minutes to determine whether DHCP, BOOTP, or RARP are available. We recommend clearing check boxes of options you will not use.
- If you are using a DNS server, select **Enable DNS Dynamic Update** and enter the IP Address for DNS servers and DNS domain name in **Primary DNS Server Address**, **Secondary DNS Server Address** and **DNS Domain Name**, respectively.

When using an IPv6 IP address

1 Start the web browser and enter the following URL in the **Location** (or **Address**) box to display the RemoteUI page.
 http://**printer IP address or name**/
 Example: http://xxx.xxx.xxx.xxx/

2 Select **Administrator Mode** and click **Logon**.



- If a password has been set on the printer, enter the password.

3 Click **Network** in the **Device Manager** menu at left to display the **Network** page.

4 Click **Edit** in the upper-right corner of the **TCP/IPv6** group to display the **Edit TCP/IPv6 Protocol Settings** page.

5 Refer to the TCP/IPv6 Settings Items table to complete the settings.

TCP/IPv6 Settings Items

Item	Details	Default Setting
Use IPv6	Activate to enable IPv6.	Off
Use DHCPv6	Activate when using a DHCPv6 server to acquire the IP address.	Off
Use a stateless address	Activate when using an IPv6-compatible router to acquire the IP address.	On
Use a manual address	Activate when configuring the IP address manually.	Off
IP Address	IP Address	Enter the printer's IP address.
	Prefix Length	Enter the IP address prefix length.
	Default Router Address	Enter the default router address.
	Prefix Length	Enter the prefix length of the default router address.
Primary DNS Server Address	Specify the IP address of the primary DNS server.	::

Item	Details	Default Setting
Secondary DNS Server Address	Specify the IP address of the secondary DNS server.	::
Use the same host name and domain name as IPv4	Activate when using the same DNS host and domain names as for IPv4.	Off
DNS Host Name	Specify the printer host name, up to 63 characters (1–63 characters). Use single-byte letters, numbers, and - (hyphens). Do not use numbers or - for the first character or - for the last character.	NB-18GBip6xxxxxx
DNS Domain Name	Specify the printer domain name, up to 63 characters. Use single-byte letters, numbers, - (hyphens), and . (periods). Do not use numbers, -, or . for the first character, or - or . for the last character.	blank
Perform dynamic updating of stateful addresses	Activate this setting to automatically register the stateful address with the DNS server.	Off
Dynamically update the stateless address	Activate this setting to automatically register the stateless address with the DNS server.	Off
Dynamically update the manual address	Activate this setting to automatically register the manual address with the DNS server.	Off

6 Click **OK** to display the **Network** page.



- If you are using a DNS server, select **Enable DNS Dynamic Update** and enter the IP Address for DNS servers and DNS domain name in **Primary DNS Server Address**, **Secondary DNS Server Address** and **DNS Domain Name**, respectively.

Mac OS Settings

Configuring the Destination in TCP/IP Networks	493
Configuring the Destination for Bonjour Network	493

Configuring the Destination in TCP/IP Networks

If you use the printer in a TCP/IP network, register the printer in **Print & Scan** (This is identified as **Printers & Scanners** or **Print & Fax** in other versions of Mac OS.) in the Mac OS **System Preferences**.



Note

- For details on how to register a printer using a TCP/IP network, see the OS User Manual.



Important

- If you use the printer in a TCP/IP network, make sure the printer's IP address is configured correctly. (See "Configuring the IP Address Using the Printer Control Panel.") →P.486

Configuring the Destination for Bonjour Network

If you use the printer in a network that uses the Bonjour function, register the printer in **Print & Scan** (This is identified as **Printers & Scanners** or **Print & Fax** in other versions of Mac OS.) in the Mac OS **System Preferences**.



Note

- For details on how to register a printer using Bonjour, see the OS User Manual.



Important

- Bonjour and IP Print (Auto) do not support printing to a printer on other network groups that require a router for connection. Make sure the computer and printer are on the same network. For information about network settings, ask your network administrator.
- By default, Bonjour is activated on the printer. You can activate or deactivate the Bonjour function or change the printer name by using RemoteUI. For instructions on changing it, see "Using RemoteUI." →P.484

Other Settings

Specifying Printer-Related Information 494
 Configuring the Communication Mode Manually 495
 Email Notification When Printing is Finished or Errors Occur 496
 Initializing the Network Settings 496

Specifying Printer-Related Information

Follow the steps below to specify device information and security settings.

1 Start the web browser and enter the following URL in the **Location** (or **Address**) box to display the RemoteUI page.

http://printer IP address or name/
 Example: http://xxx.xxx.xxx.xxx/

2 Select **Administrator Mode** and click **Logon**.



• If a password has been set on the printer, enter the password.

Note

3 Click **Information** in the **Device Manager** menu at left to display the **Information** page.

4 To display the relevant settings page, click **Edit** in the upper-right corner of **Device Information** or **Security**, depending on what information you want to specify.
 To change the administrator password, click the **Change Password** button in the **Security** group.

5 Refer to the table of settings for device information and security as you complete these settings.
 Security setting items are displayed when you click the **Change Password** button in the **Security** group.

Device Information Settings

Item	Details	Default Setting
Device Name	Enter a device name. (0–32 characters)	blank
Location	Enter the location where the device is installed. (0–32 characters)	blank
Administrator	Enter the administrator's name. (0–32 characters)	blank
Phone	Enter the administrator's contact information. (0–32 characters)	blank
Comments(E-mail)	Enter any comments regarding the administrator. (0–32 characters)	blank

Security Settings

Item	Details	Default Setting
New Password	Enter the new password. (0-9999999)	blank
Confirm	Enter the new password again to confirm it. (0-9999999)	blank

*1: On the **Security** settings screen, besides entering a password, you can specify other security-related information, such as IP address-based SNMP or TCP usage restrictions, MAC address-based access restrictions, or IPP and FTP authentication settings.

6 Click **OK** to activate the settings.

Configuring the Communication Mode Manually

This topic gives instructions for configuring the communication mode manually.

- 1 On the **Tab Selection screen** of the Control Panel, press ◀ or ▶ to select the **Settings/Adj. tab** ().

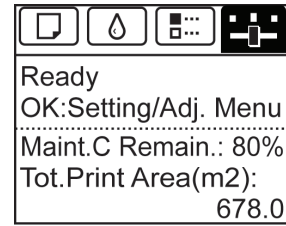

 **Note** • If the **Tab Selection screen** is not displayed, press the **Menu** button.

- 2 Press the **OK** button.
The **Set./Adj. Menu** is displayed.
- 3 Press ▲ or ▼ to select **Interface Setup**, and then press the **OK** button.
- 4 Press ▲ or ▼ to select **Ethernet Driver**, and then press the **OK** button.
- 5 Press ▲ or ▼ to select **Auto Detect**, and then press the **OK** button.
- 6 Press ▲ or ▼ to select **Off**, and then press the **OK** button.
The display reverts to the **Ethernet Driver** menu.
- 7 Press ▲ or ▼ to select **Comm.Mode**, and then press the **OK** button.
- 8 Press ▲ or ▼ to select the communication mode, and then press the **OK** button.
The display reverts to the **Ethernet Driver** menu.
- 9 Press ▲ or ▼ to select **Ethernet Type**, and then press the **OK** button.
- 10 Press ▲ or ▼ to select the Ethernet type, and then press the **OK** button.
The display reverts to the **Ethernet Driver** menu.
- 11 Press ▲ or ▼ to select **Spanning Tree**, and then press the **OK** button.
- 12 Press ▲ or ▼ to enable or disable spanning tree support, and then press the **OK** button.
The display reverts to the **Ethernet Driver** menu.
- 13 Press the **Menu** button.
If you have changed the settings, a confirmation message is displayed. Press ▲ or ▼ to select **Yes**, and then press the **OK** button.
The new settings will take effect after the printer restarts.

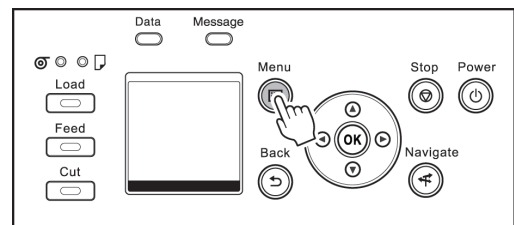

Email Notification When Printing is Finished or Errors Occur

The printer can notify you of the printer status by email. Even when you are away from the printer, you can know when printing is finished or if errors occur. Receive notification via email on your mobile phone or at your computer.

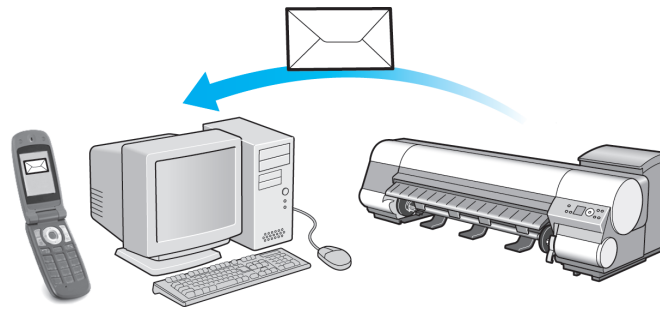

Use the **imagePROGRAF Status Monitor** (Windows) function to set up email recipients and message timing. Besides being informed of finished print jobs or errors, you can also complete settings for email notification when service is needed or it's time to replace consumables. For detailed instructions, see "Specifying Printer-Related Information." → P.494



Note

- For details on email notification using **imagePROGRAF Status Monitor** (in Windows), refer to the **imagePROGRAF Status Monitor** help.
- Mail server authentication is only supported with **imagePROGRAF Status Monitor**.

Initializing the Network Settings

Use RemoteUI to restore the network settings to the default values as follows.



Important

- Initializing the network settings will also restore the default value of the printer's IP address. As a result, the RemoteUI page cannot be displayed in the web browser after this procedure.
- For instructions on reconfiguring the IP address, see "Configuring the IP Address on the Printer." → P.486
- For details on RemoteUI, see "Using RemoteUI." → P.484

1 Start the web browser and enter the following URL in the **Location** (or **Address**) box to display the RemoteUI page.

http://printer IP address or name/

Example: http://xxx.xxx.xxx.xxx/

2 Select **Administrator Mode** and click **Logon**.



Note

- If a password has been set on the printer, enter the password.

3 Click **Network** in the **Device Manager** menu at left to display the **Network** page.

4 Click **Reset to Default settings** in the lower-right corner of the **Network Interface** group.

5 After confirming the message, click **OK** to restore the network settings to the default values.



Note

- You can also use **imagePROGRAF Device Setup Utility** or the Control Panel to restore the default network settings.

Device Setup Utility (Windows)

imagePROGRAF Device Setup Utility	497
Installing imagePROGRAF Device Setup Utility	497
Configuring the IP Address Using imagePROGRAF Device Setup Utility	497

imagePROGRAF Device Setup Utility

imagePROGRAF Device Setup Utility is a utility to establish communication between the printer and your computer by completing relevant settings. After the printer is installed, for example, you can use **imagePROGRAF Device Setup Utility** to complete the network settings initially.

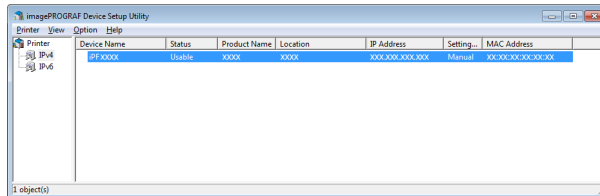

- Starting **imagePROGRAF Device Setup Utility** will show a list of printers found on the network. In this list, select the printer (specifically, the printer's MAC address) that you want to set up, and then configure the basic settings from your computer, such as the printer's IP address and the network frame type.
- You can see which printers are online in the network by checking the printer list. Communication between your computer and these printers is possible.



- We recommend that your network or printer administrator complete the setup work using **imagePROGRAF Device Setup Utility**.
- For details, refer to the **imagePROGRAF Device Setup Utility** help.

Installing imagePROGRAF Device Setup Utility

Install **imagePROGRAF Device Setup Utility** from the User Software CD-ROM provided with the printer as follows:

- 1 Insert the User Software CD-ROM in the CD-ROM drive.
- 2 On the **Setup Menu** window, click **Install Individual Software**.
- 3 Click **Install** in **imagePROGRAF Device Setup Utility**.
- 4 Follow the instructions on the screen to proceed with the installation.

Configuring the IP Address Using imagePROGRAF Device Setup Utility

On a computer running Windows, you can use **imagePROGRAF Device Setup Utility** provided with the printer to configure the printer's IP address. This topic describes how to configure the IP address using **imagePROGRAF Device Setup Utility**.



- To configure network settings, you must be logged in with administrative rights such as **Administrator** account. We recommend that your network administrator configure the network settings.



- For instructions on installing **imagePROGRAF Device Setup Utility**, see "Installing imagePROGRAF Device Setup Utility." →P.497

When specifying an IPv4 IP address

1 Start **imagePROGRAF Device Setup Utility** from the **start** menu.

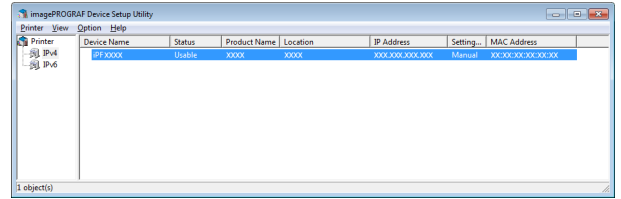

2 In the **Device Name** list displayed, select the printer to configure.

3 Choose **Protocol Settings** from the **Printer** menu.

4 Select the **IPv4** tab.

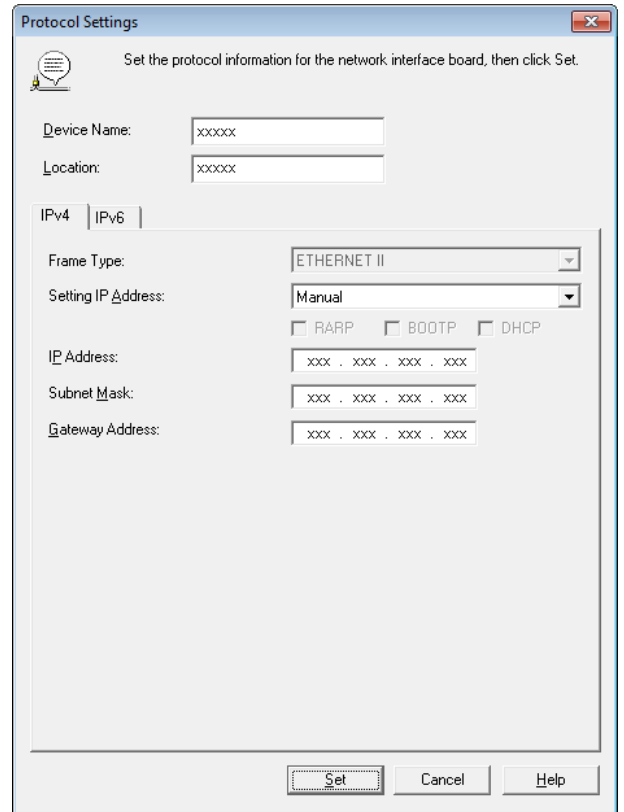

5 In the **Setting IP Address** list, choose **Manual**.

6 Enter the IP address assigned to the printer and click the **Set** button.

7 Click **OK** after the **Confirmation** message is displayed.

8 Exit **imagePROGRAF Device Setup Utility**.



- To configure the IP address automatically, choose **Auto** in the **Setting IP Address** list and select **DHCP**, **BOOTP**, or **RARP**.
- You can also specify the subnet mask and default gateway.

When specifying an IPv6 IP address

1 Start imagePROGRAF Device Setup Utility from the **start** menu.

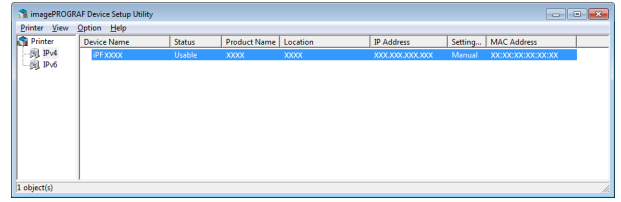

2 In the **Device Name** list displayed, select the printer to configure.

3 Choose **Protocol Settings** from the **Printer** menu.

4 Select the **IPv6** tab.

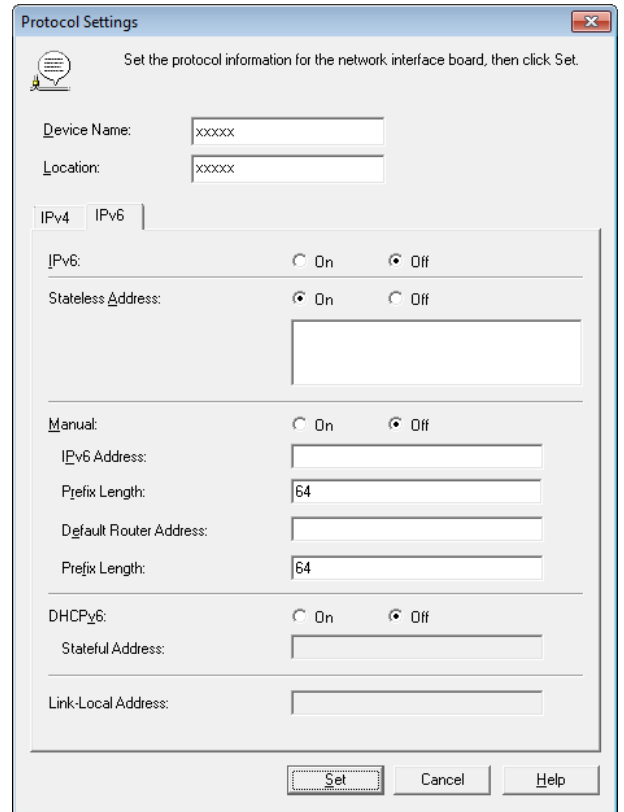

5 In **IPv6**, select **On**.

6 When there is an IPv6-compatible router in the network environment, select **On** in **Stateless Address**. Additionally, when there is an DHCPv6-compatible server in the network environment, select **On** in **DHCPv6**.

 **Note** • When there is no IPv6-compatible router or DHCPv6-compatible server, select **On** in **Manual** and enter the **IPv6 Address** and **Prefix Length**.

7 Click **Set**.

8 Click **OK** after the **Confirmation** message is displayed.

9 Exit imagePROGRAF Device Setup Utility.

Memo

Basic Printing Workflow	15
Enhanced Printing Options	29
Windows Software	157
Mac OS Software	267
Handling and Use of Paper	331
Control Panel	429
Printer Parts	467
Network Setting	481

Print Job Management

Status Monitor (Windows)	502
Printmonitor (Mac OS)	505
Accounting (Windows)	507
Basic Print Job Operations	519
Advanced Print Job Operations	538

Adjustments for Better Print Quality	555
Maintenance and Consumables	573
Troubleshooting	617
Error Message	651
Specifications	673
Appendix	677

Status Monitor (Windows)

The Features of imagePROGRAF Status Monitor 502
 Job Management Using imagePROGRAF Status Monitor 503

The Features of imagePROGRAF Status Monitor

imagePROGRAF Status Monitor is a utility for checking the printer status and managing print jobs. Two screens are available in imagePROGRAF Status Monitor : **Printer List** shows a list of printers, and **Status Monitor** shows details for each printer.

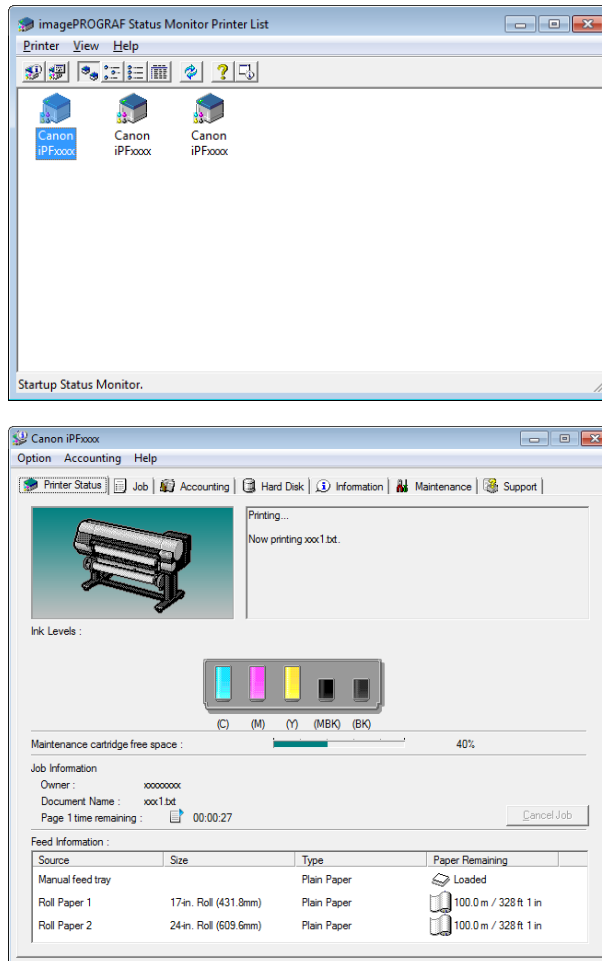

- You can view a list of the printers for which printer drivers have been installed on your computer, printers connected to your computer, and printers found on the network.
- If a printer error occurs, you can investigate the corrective action immediately.
- Printer status can be checked in real time on a computer monitor.
- Displays the ink level of every color in the printer. An icon and warning message will notify you when ink levels are low.
- The type of paper loaded in each media source is identified. You can also check to see if paper has run out.
- This way, the utility enables you to check printer information and take care of printer maintenance for optimal printing results.
- You can also set up automatic email notification of any printer problems or errors to email addresses you designate in advance.
- You can check the status of the hard disk and the documents saved on the hard disk.
- You can use the Accounting Manager to collect the print job logs for the printers and check information such as the printing costs.

For details of the Accounting Manager, see "Accounting Manager." →P.507



- For details, refer to the imagePROGRAF Status Monitor help.

Note

Job Management Using imagePROGRAF Status Monitor

You can use the **Job** sheet in imagePROGRAF Status Monitor for operations such as pausing and canceling print jobs.

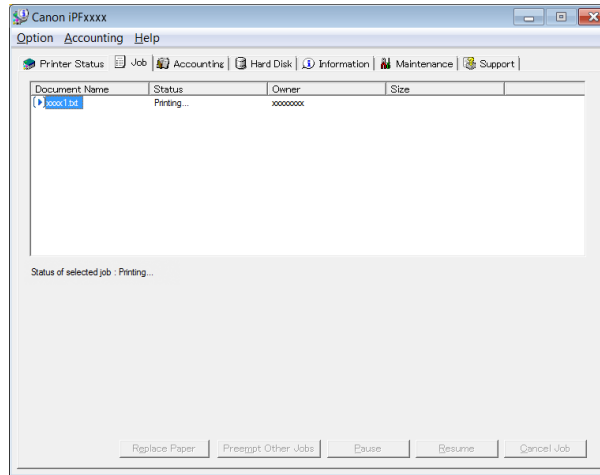

Important

- Unless otherwise noted, the job operation buttons only affect your own print jobs. The print jobs of other users cannot be controlled.

• Preempting Other Jobs

If you select a print job and click the **Preempt Other Jobs**, the selected job is printed ahead of other jobs including the jobs of other users.



Note

- You cannot print ahead of the currently printing job.

• Pausing/Resuming Print Jobs

Selecting a print job and clicking the **Pause** button pauses printing of the selected job.

To resume printing of a paused print job, select the print job and click the **Resume** button.



Note

- Once all the print data for a print job has been sent to the printer, the job can no longer be paused/resumed.

• Canceling Print Jobs

Selecting a print job and clicking the **Cancel Job** button cancels printing of the selected job.



Note

- You cannot cancel other users' print jobs.

• Printing Held Jobs

Printing of the job with a **Status of Holding** is paused because the paper specified by the driver does not match the paper currently loaded in the printer.

Use the procedure below to print the held job.

- 1 Select the held job and click the **Replace Paper** button.

2 Replace the paper in the printer with the correct paper.



Note

- To continue printing without changing the paper in the printer, select the held job and click **Continue to print** button.
- The printing behavior when the paper specified by the driver does not match the paper currently loaded in the printer can be changed by using **Detect Mismatch** in the operation panel menu. Refer to "Menu Settings" → P.449 for details.

Printmonitor (Mac OS)

The Features of imagePROGRAF Printmonitor 505
 Job Management Using imagePROGRAF Printmonitor 506

The Features of imagePROGRAF Printmonitor

imagePROGRAF Printmonitor is a utility for checking the printer status and managing print jobs.

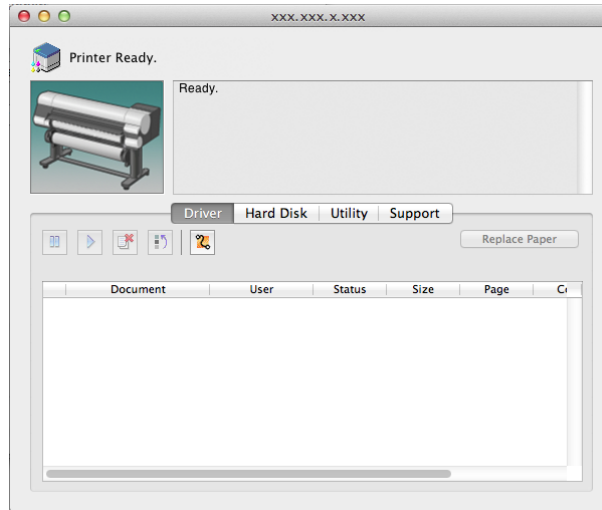

- Printer status can be checked in real time on a computer monitor.
- You can check the status of print jobs, cancel jobs, and manage them as needed.
- If a printer error occurs, you can investigate the corrective action immediately.
- You can also set up automatic email notification of any printer problems or errors to email addresses you designate in advance.
- You can check the status of the hard disk and the documents saved on the hard disk.



Note

- If the status of the desired printer is not shown in imagePROGRAF Printmonitor, select the printer again as follows.
 1. Make sure the printer is on and connected to the network or to a local port.
 2. In the **Printer** menu, select the name of the desired printer. After the printer is detected, the printer status is shown.
 3. If information about the printer is not shown in step 2, choose **Search Printer** in the **Printer** menu. Printer names listed in the **Printer** menu are updated with the printers that are now detected.
 4. In the **Printer** menu, select the name of the desired printer. After the printer is detected, the printer status is shown.

Job Management Using imagePROGRAF Printmonitor

You can use the **Driver** Panel in imagePROGRAF Printmonitor for operations such as pausing and canceling print jobs.

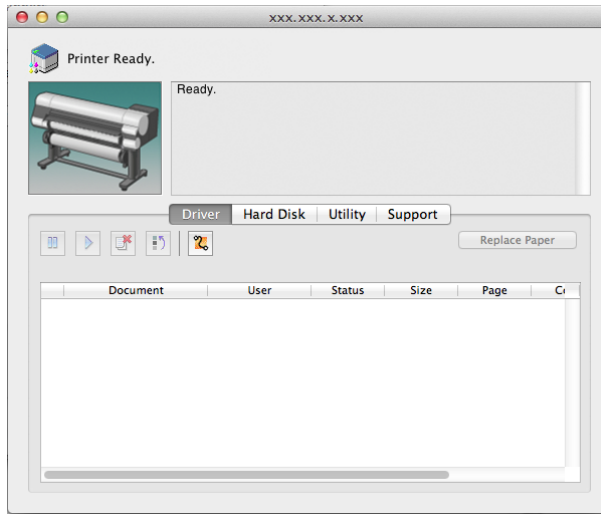

• Pausing/Resuming Print Jobs

Selecting a print job and clicking the  button pauses printing of the selected job.

To resume printing of a paused print job, select the print job and click the  button.



Note

- Once all the print data for a print job has been sent to the printer, the job can no longer be paused/resumed.

• Canceling Print Jobs

Selecting a print job and clicking the  button cancels printing of the selected job.



Note

- You cannot cancel other users' print jobs.

• Preempting Other Jobs

If you select a print job and click the  button, the selected job is printed ahead of the job that currently precedes it in the print queue.

• Printing Held Jobs

Printing of the job with a **Status** of **Holding** is paused because the paper specified by the driver does not match the paper currently loaded in the printer.

Use the procedure below to print the held job.

1 Select the held job and click the **Replace Paper** button.

2 Replace the paper in the printer with the correct paper.



Note

- To continue printing without changing the paper in the printer, select the held job and click **Continue to print** button.

Accounting (Windows)

- Accounting Manager 507
- Launching the Accounting Manager 507
- Accounting Manager Main Window 508
 - Job List Area 510
- Accounting Manager Basic Procedures 511
- Configuring Unit Costs in Accounting Manager 511
 - Setting the Unit Cost for Ink 512
 - Setting the Unit Cost for Paper 513
 - Setting the Unit Cost for Items Other Than Ink and Paper 514
- Configuring Units and Display Settings in Accounting Manager 515
- Automatically Acquiring Print Job Logs at Regular Intervals 515
- Canceling Regular Print Job Log Acquisition 516
- Switching Between Displaying Jobs on Printer and Regularly Acquired Jobs 516
- Exporting Print Job Data as a CSV File 516
- Displaying Job Properties or Period Properties 517
- Showing, Saving and Loading Selected Unit Cost Data 518
- Showing the Total Amount of Ink and Paper Consumed 518

Accounting Manager

The Accounting Manager stores the printer's print job logs so that you can use the information for checking printing costs, etc.

The benefits of using the Accounting Manager are outlined below.

- **Print Job Log Collection**
This allows you to check which documents were printed from each printer, who printed them and when.
- **Calculation of the Total Pages Used and the Total Cost**
This allows you to use the collected print job logs to calculate totals for items such as the number of pages printed, the amount of paper used and the printing costs incurred.
- **Regular Data Acquisition for Print Jobs**
Job logs can be automatically collected periodically.
- **Exporting Print Job Data**
This allows you to export collected print job data as a CSV file.



Important

- The Accounting Manager in Status Monitor displays approximate estimates of the amount of paper consumed and the ink consumed per job. Canon cannot guarantee the accuracy of these estimates. These estimates will also vary depending on the conditions of printer use.
- Print job log collection is not performed when **Set./Adj. Menu -> System Setup -> Show Job Log** of the control panel is **Off**. However,
 - even if **Show Job Log** is set to **Off**, regularly acquired jobs that already have been retrieved at that time are displayed.
 - When **Show Job Log** has been set to **On** again, all jobs within the printer at that time are displayed.

Launching the Accounting Manager

The procedure for launching the Accounting Manager is shown below.

- 1** Open the imagePROGRAF Status Monitor window.

- 2 Select **Accounting** in the **Accounting** menu.
Or, open the **Accounting** sheet and click the **Accounting** button.

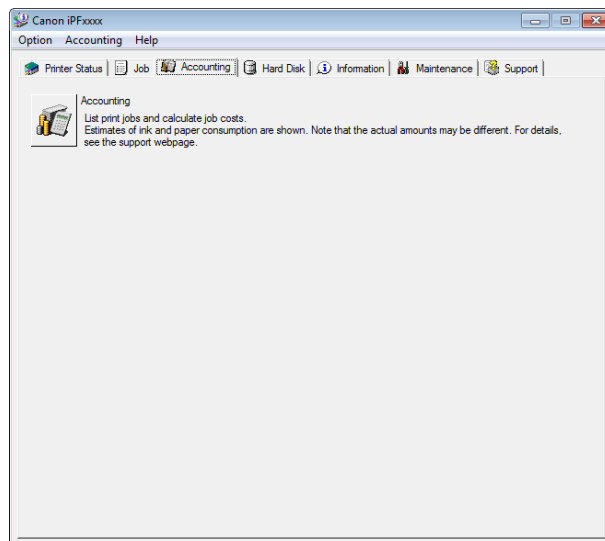

Note

- If Show Job Log is set to off and an administrator password is configured in the printer, the administrator password needs to be entered on startup. If the password is correct, you are logged on as administrator and Accounting starts. Furthermore, when you exit from Accounting, you can choose to log off as administrator.
- If you log off as administrator, you need to enter the password again the next time it starts.
- The administrator password can be set or cleared using Chg.Admin.Pswd/Init.Admin.Pswd in the Admin. Menu in the Set./Adj. Menu in the printer. The administrator menu can only be displayed and configured by the administrator.

Accounting Manager Main Window

The Accounting Manager main window consists of a title bar, menu bar, toolbars, listed job selection area, job list area, totals area and status bar.

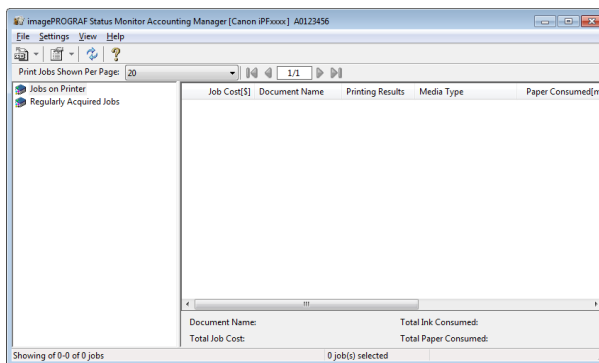

Title Bar

This displays the printer model, its serial number and the port number it is using.

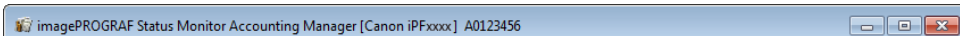

Menu Bar

Allows you to select the menu options required for operation.



Toolbars

Provide tool buttons and pull-down menus for the main operations.

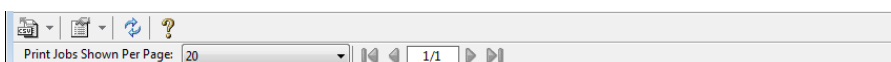



- You can opt to either show or hide the toolbars in the **View** menu.

- Listed Job Selection Area**

You can use this area to select which job log is displayed.

If you are using regular data acquisition, this area allows you to view the collective job logs for each specified period.

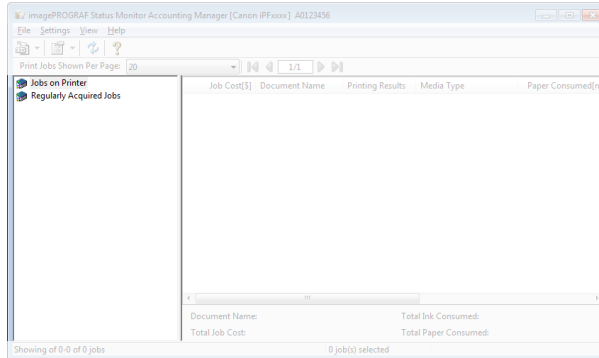

For more information on how to select the job logs displayed, see "Switching Between Displaying Jobs on Printer and Regularly Acquired Jobs." →P.516

- Job List Area**

This area lists the details of acquired jobs.

Displays a list of the jobs in the printers or periodically acquired jobs. (See "Job List Area.") →P.510

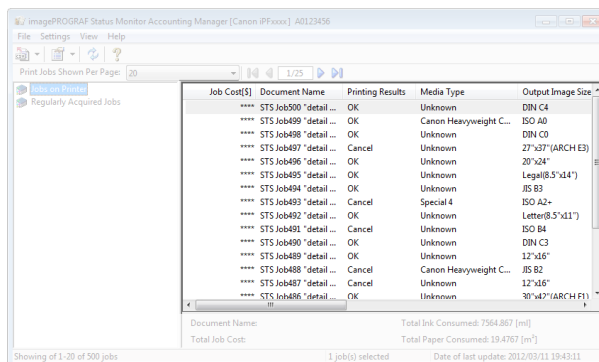

- You can change the items that are displayed and the display order using the **Advanced Display Settings** dialog box. The **Advanced Display Settings** dialog box can be displayed by selecting **Advanced Display Settings** from the **Show** menu.

- Totals Area**

Displays the total costs for the selected job and the amounts of paper and ink consumed.

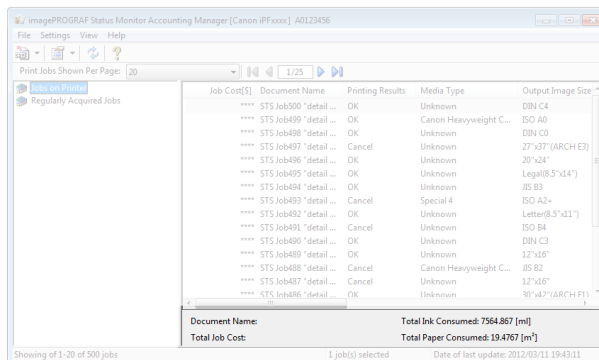

- If you are viewing regularly acquired print jobs, selecting a period on the left side of the window displays the total costs for that period and the amounts of paper and ink consumed.

• **Status Bar**

Displays messages and other information.

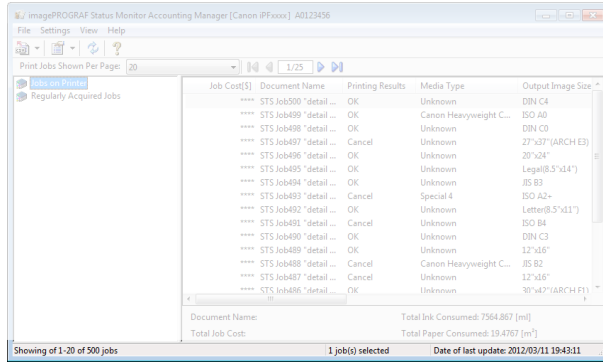

Job List Area

The job items and details that can be displayed in the job list area are as follows.

• **No.**

The job serial number.

• **Job Cost**

The cost of printing.



• If the ink and paper unit costs are not set, **** is displayed.

• **Document Name**

This is the name of the printed document.

• **Printing Results**

OK is displayed when the print process was executed, and **Cancel** is displayed if the print process was not executed.

• **Media Type**

This is the type of paper used in printing.

• **Output Image Size**

The size of the image used for printing.



• If the job has multiple pages, the size of the last page is displayed.

• **Paper Consumed**

The area of paper used for printing.



• The **Paper Consumed** may differ from the product of **Paper Width** and **Paper Length**.

• **Paper Width**

The width of paper used for printing.



• If the job has multiple pages, the width of the last page is displayed.

• **Paper Length**

The length of paper used for printing.

• **Ink Consumed**

The amount of ink used for printing.

- **Owner**

The sender of the job.

- **Print Job Start Time/Print Time**

The time when printing started and the time taken to print.

- **Number of Pages**

The number of pages printed.

- **Roll Paper Width**

The width of roll paper used for printing.

- **Paper Cost**

The cost of paper used for printing.



Note

- If the paper unit cost is not set, **** is displayed.

- **Total Ink Cost**

The total value of the cost of ink used for printing.



Note

- If the ink unit cost is not set, **** is displayed.

- **Total of Other Costs**

The total value of costs other than paper and ink.

- **Ink Cost Details**

The cost of each ink color.

- **Ink Consumption Details**

The amount of each color of ink used.

Accounting Manager Basic Procedures

The first time you use the Accounting Manager, use the following procedures to configure the settings.

1

Configure unit costs, including the costs of ink and paper.

For details of the unit cost settings, see "Configuring Unit Costs in Accounting Manager." →P.511

2

Set options such as the units displayed.

For details of the unit settings, see "Configuring Units and Display Settings in Accounting Manager." →P.515

3

If you are using Regular Data Acquisition, configure the Regular Data Acquisition settings.

For details of the Regular Data Acquisition settings, see "Automatically Acquiring Print Job Logs at Regular Intervals." →P.515

4

Specify the jobs to be listed.

For details of how to select the job logs displayed, see "Switching Between Displaying Jobs on Printer and Regularly Acquired Jobs." →P.516

This displays the required print job logs and lists the details.

Configuring Unit Costs in Accounting Manager

Select **Unit Costs** in the **Settings** menu to open the **Unit Costs** dialog box. Configure the unit cost settings in this dialog box.



Note

- When you select a job and then open the **Unit Costs** dialog box, items with unit costs that have not yet been configured for that job are shown highlighted.

- **Setting the Unit Cost for Ink** →P.512
- **Setting the Unit Cost for Paper** →P.513
- **Setting the Unit Cost for Items Other Than Ink and Paper** →P.514

Setting the Unit Cost for Ink

Open the **Ink** sheet. Set the unit cost for ink in this sheet.

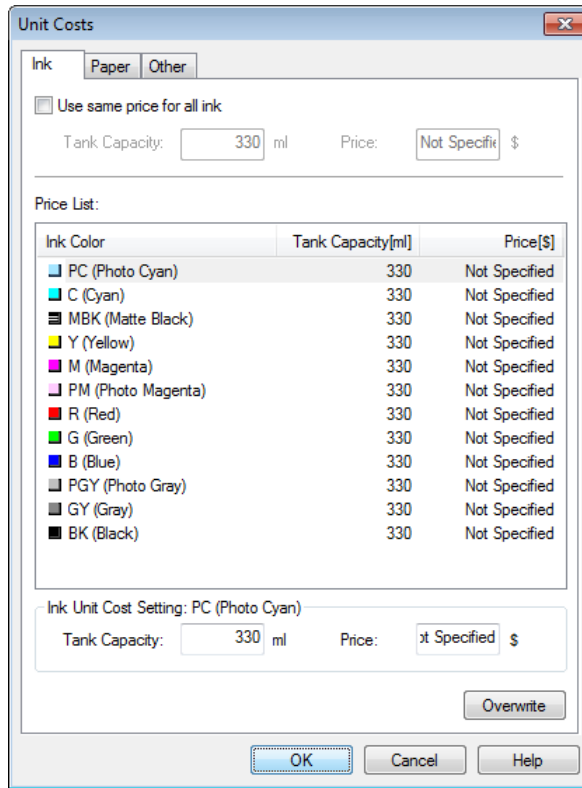

To set the same unit cost for all the inks

- 1 Select the **Use same price for all ink** checkbox.
- 2 Enter the **Tank Capacity** and corresponding **Price**.
- 3 Click the **OK** button.

 • Your settings are not applied until you click the **OK** button.

Important

To set different unit costs for each ink color

- 1 Select the ink color to be costed.
- 2 Enter the **Tank Capacity** and corresponding **Price**.
- 3 Click the **Overwrite** button.
- 4 Repeat steps 1 to 3 for all the inks.
- 5 Click the **OK** button.

 • Your settings are not applied until you click the **OK** button.

Important

Setting the Unit Cost for Paper

Opens the **Paper** sheet. This sheet is used to configure the unit cost of paper.

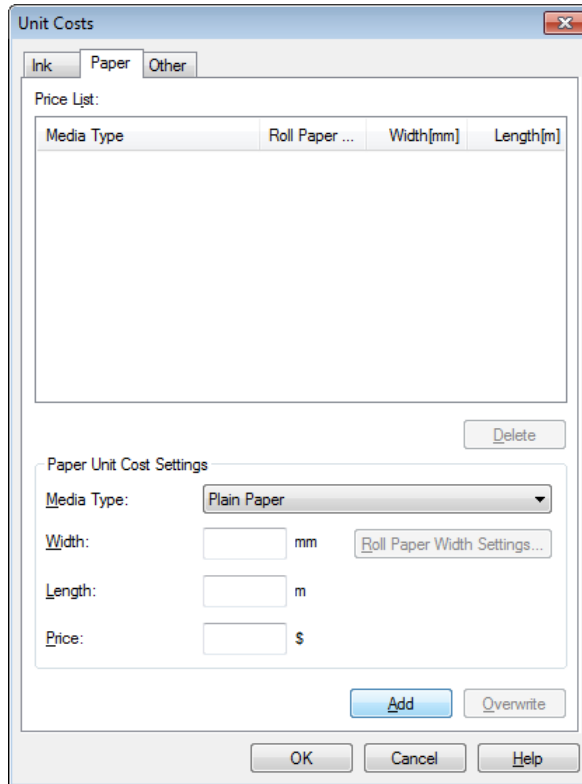

Setting Standard Prices

- 1 Select the media type in **Media Type**.
- 2 Enter the **Width** and **Length** of the paper, as well as the **Price** for the area of the configured width x height.
- 3 Click the **Add** button. To change the unit cost of a media type that has already been configured, click the **Overwrite** button.
- 4 Click the **OK** button.

 • The settings are not applied until you click the **OK** button.

Important

Specifying Price by Roll Paper

- 1 Select the media type in **Media Type**.
- 2 Click the **Roll Paper Width Settings** button to display the **Roll Paper Width Settings** dialog box.

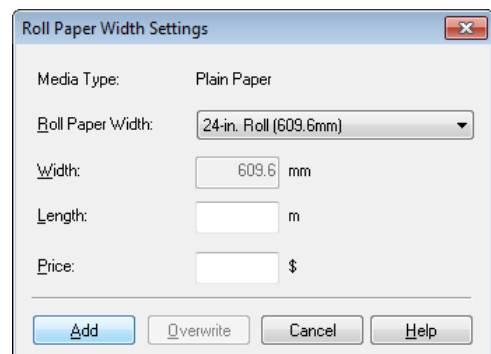

- 3** Enter the **Roll Paper Width** and **Length** of the paper, as well as the **Price** for the configured length.
- 4** Click the **Add** button to return to the **Paper** sheet.
- 5** To change the unit cost of a media type that has already been configured, click the **Overwrite** button.
- 6** Click the **OK** button.

-  **Important**
- If you do not set the standard prices, you cannot set the price for each roll paper.
 - If the **Roll Paper Width** is set to the same value as the **Width** of the paper configured in the standard prices, the cost is calculated using the price configured in the **Roll Paper Width Settings** dialog box.
 - The settings are not applied until you click the **OK** button.

Setting the Unit Cost for Items Other Than Ink and Paper

Open the **Other** sheet. Use this sheet to set any price for items other than inks and paper.

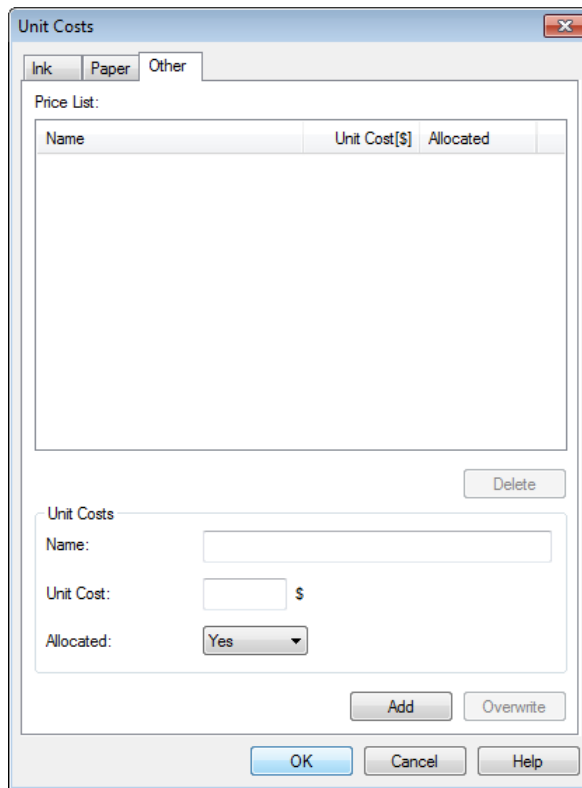

- 1** Enter any name in the **Name** field.
- 2** Enter a value in **Unit Cost**.
- 3** Use **Allocated** to specify whether the costs are allocated as being incurred by the print job.
- 4** Click the **Add** button. To change the unit cost for a media type you have already set, click the **Overwrite** button.
- 5** Click the **OK** button.

-  **Important**
- Your settings are not applied until you click the **OK** button.



- You can set unit costs for up to 5 items.

Note

Configuring Units and Display Settings in Accounting Manager

Select **Units and Display** in the **Settings** menu to open the **Units and Display** dialog box. Use this dialog box to configure the display settings.

• Date Display Format

Use this option to select the display format for dates. "YYYY" indicates the year, "MM" the month and "DD" the day.

• Currency Unit

Enter the currency unit. Enter a text string up to 3 characters long.

• 1000 Separator

Use this option to select the symbol used as a separator in numbers. The symbol is inserted every 3 digits.

• Decimal Symbol

Use this option to select the symbol used as a decimal point.

• Ink Consumed

Use this option to select the unit used for ink consumption.

• Paper Width

Use this to select the unit used for paper width.

• Paper Length

Use this to select the unit used for paper length.

• Area Display Format

Use this to select the unit used for paper area.

Automatically Acquiring Print Job Logs at Regular Intervals

This feature collects print job logs from the printer at regular intervals and saves the logs on your computer.

- 1 Select **Regular Data Acquisition** in the **Settings** menu.
- 2 Select **Acquire print job logs regularly**.
- 3 Click the **OK** button to close the dialog box.



Important

- Print job log collection is not performed when **Set./Adj. Menu -> System Setup -> Show Job Log** of the control panel is **Off**. However, even if **Show Job Log** is set to **Off**, regularly acquired jobs that already have been retrieved at that time are displayed.



- Immediately after you configure Regular Data Acquisition, no print jobs are displayed. Wait a few moments and then select **Refresh** in the **View** menu to display the print jobs.
- A maximum of 10,000 records are saved in a print job log. If this number is exceeded, jobs are deleted from the log starting from the oldest record. To save old data, it is recommended that you export the data as a CSV file. For details of how to export print job logs as CSV files, see "Exporting Print Job Data as a CSV File." →P.516

Canceling Regular Print Job Log Acquisition

You can use this procedure to cancel the regular acquisition of print job logs from printers.

- 1 Select **Regular Data Acquisition** in the **Settings** menu.
- 2 Uncheck the **Acquire print job logs regularly** option.
- 3 Click the **OK** button to close the dialog box.

Switching Between Displaying Jobs on Printer and Regularly Acquired Jobs

The print job logs displayed by the Status Monitor Accounting Manager contain two types of job: Jobs on Printer and Regularly Acquired Jobs.

You can select whether to display Jobs on Printer or Regularly Acquired Jobs in the Listed Job Selection Area on the left side of the window.

• Jobs on Printer

This shows a list of the print jobs currently held on printers.

You can change the number of jobs displayed per page using the **Print Jobs Shown Per Page** setting in the **View** menu or the toolbar.

You can skip to a particular page using the **Go to** option in the **View** menu or the toolbar.



Note

- For printers with built-in hard disks, you can view up to 500 print jobs per printer.
- For printers without built-in hard disks, you can view up to 32 print jobs per printer. However, only 10 jobs can be displayed if the printer is switched off.

• Regularly Acquired Jobs

This shows a list of regularly acquired print jobs.

To view all the jobs in a set period, specify the period using **Calculate Total for Period** and then **Starting Date** (or **Starting Day of Week** or **Starting Month**) in the **View** menu or the toolbar.

For example, to view monthly job logs starting on the 1st of each month, set **Calculate Total for Period** to **Monthly** and set **Starting Date** to **1**.



Note

- Up to 10,000 regularly acquired jobs are displayed for each printer.

Exporting Print Job Data as a CSV File

You can export the collected print job data in the form of a CSV file by selecting **Export Job Cost Data** in the **File** menu.



Note

- You can also select **Export Job Cost Data** using the icon in the toolbar.

• Selected Jobs

Exports the data for the selected print jobs in the job list as a CSV file.



Note

- You can select multiple jobs by holding down the Shift key or Ctrl key as you click the job names.

- **Listed Jobs**

Exports the data for the print jobs currently displayed in the list as a CSV file.

Displaying Job Properties or Period Properties

You can display the **Job properties** dialog box or **Period Properties** dialog box to check detailed cost information and other items.

The **Job properties** dialog box displays detailed information about the selected job.

The **Period Properties** dialog box displays detailed information within the **Regularly Acquired Jobs** period.

- **Displaying the Job properties Dialog Box**

Select a job from the job list, and then select **Show Job Properties** from **Job properties** in the **File** menu. You can also select multiple jobs at once.



Note

- You can also display the dialog box by selecting a job, right-clicking it, and then selecting **Show Job Properties**, or by using the icon in the toolbar.

- **Displaying the Period Properties Dialog Box**

Select a period from the **Regularly Acquired Jobs** list, and then select **Show Period Properties** from **Job properties** in the **File** menu. You can also select multiple periods at once.



Note

- You can also display the dialog box by selecting and right-clicking a period and then selecting **Show Period Properties**, or by using the icon in the toolbar.

- **Components of the Job properties Dialog Box/Period Properties Dialog Box**

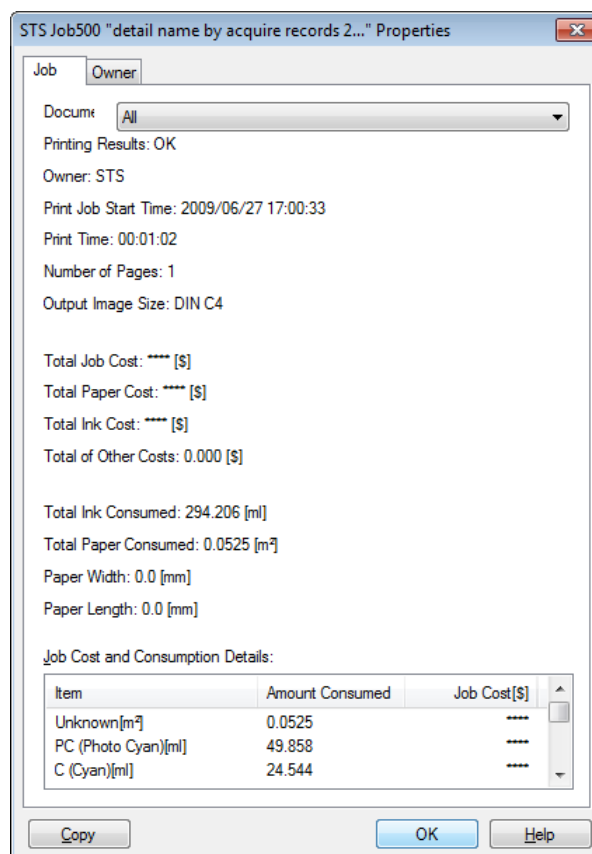

- **Job tab**

Displays detailed information about the selected job. You can display detailed information about each job by selecting the corresponding **Document Name**.

- **Owner tab**

You can display detailed information about each owner by selecting the corresponding **Owner**.

- **Copy button**

Click this button to copy the displayed text information to the clipboard.

Showing, Saving and Loading Selected Unit Cost Data

• Show Unit Cost Data

Select **Show Unit Cost Data** in the **File** menu to open the **Unit Cost Data** dialog box. This lists the unit costs for items such as the selected ink and paper.

You can copy text-based information in this dialog box to the clipboard by clicking the **Copy** button.

• Save Unit Cost Data

Select a destination folder using **Save Unit Cost Data** in the **File** menu. The unit cost data for items such as the selected ink and paper is saved as a file.

• Load Unit Cost Data

Selecting **Load Unit Cost Data** in the **File** menu loads saved unit cost data.

Showing the Total Amount of Ink and Paper Consumed

Select **Show Ink and Paper Consumed** in the **File** menu to open the **Show Ink and Paper Consumed** dialog box.

This lists the total amounts of ink and paper consumed by the printer so far.

You can copy text-based information in this dialog box to the clipboard by clicking the **Copy** button.



Note

- Up to 7 types of media are listed in order of the amount consumed. The total consumption for other media types is shown as **Other**.

Basic Print Job Operations

- Using the Printer Hard Disk 519
- Saving Print Jobs on the Printer Hard Disk 520
- Managing the Job Queue (Deleting or Preempting Other Jobs) 523
- Managing Pending Jobs (Printing or Deleting Jobs on Hold) 525
- Printing Saved Jobs 527
- Deleting Saved Jobs 531
- Moving Saved Jobs 534

Using the Printer Hard Disk

The printer can save print jobs on the built-in hard disk. Using print jobs stored on the printer enables you to print the jobs again as needed without using a computer.

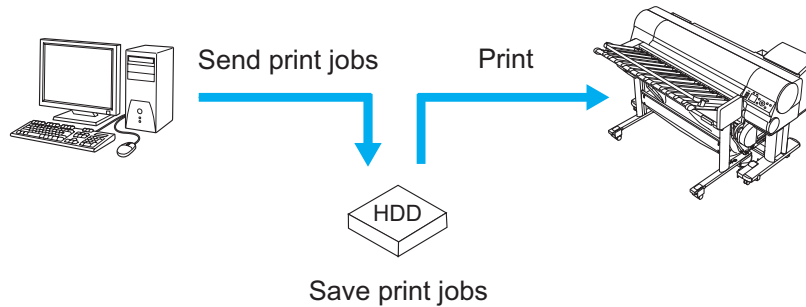

Saving print jobs offers the following benefits.

- **Save the time spent using a computer**
When you send a print job to the printer, you can save it on the printer after printing or simply save it on the printer without printing it yet. Saved print jobs can be printed in the required quantity later without the need to use a computer again.
- **Simplify reprinting, if any errors occur**
If errors occur in the middle of printing (as when paper runs out), you can resume printing after clearing the error without resending the print job from a computer.
- **Streamline printing work**
Without using a computer, you can select print jobs and print in the desired quantity. You can also select multiple print jobs to print during the same period. This enables unattended operation at night, for example.

Output Method

To save print jobs on the printer's hard disk, configure the printer driver. In Windows, this is set using the **Output Method** dialog box. In Mac OS, this is set using the **Additional Settings** pane.

- **Print**
Save print jobs on the printer's hard disk after printing.
- **Save in mail box**
Save print jobs on the printer's hard disk.
- **Print after reception is complete**
This option is available in combination with **Print**. You can prevent degradation of print quality that occurs when receiving a print job is interrupted and printing is aborted in the middle.

Storage destination

The storage area on the printer's hard disk is divided into a temporary storage area and a permanent storage area. The temporary storage area stores print jobs in the job queue or shared mailbox. The permanent storage area stores jobs in personal boxes.

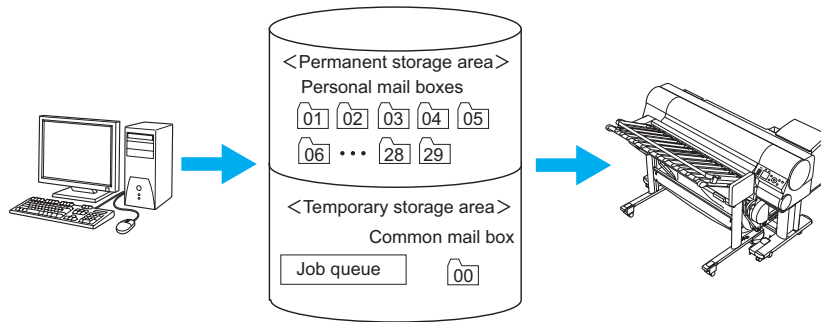

• Job queue

The job queue refers to print jobs that are being processed by the printer (saved, received, prepared for processing, printed, deleted, or held). Up to 64 jobs can be stored in the temporary storage area.

When the job queue is full, additional jobs sent from a computer are treated as "standby" jobs, to be processed when possible.

However, if all queued jobs are simply being held, the oldest job is deleted and the print job sent from the computer is processed.

• Shared mailbox

Jobs for which you have specified **Print in Output Method** (in Windows) or **Send job to** (in Mac OS) are saved in the shared mailbox and classified as saved jobs.

There is one shared mailbox, numbered **00**. A password cannot be set for the shared mailbox.

Up to 100 print jobs can be saved here, but they will be deleted one after another starting with the oldest job in the following situations.

- If there are more than 100 jobs queued and saved in the shared mailbox combined
- If no more temporary storage space is available when jobs for which you have selected **Print in Output Method** (in Windows) or **Send job to** (in Mac OS) are received
- If there is not enough space in the temporary or permanent storage area when jobs for which you have selected **Save in mail box** in **Output Method** (in Windows) or **Send job to** (in Mac OS) are received

• Personal boxes

Jobs are classified as saved jobs and saved in personal boxes in the following situations.

- When a saved job stored in the shared mailbox is moved to a personal box
- When you have selected **Save in mail box** as the option in **Output Method** (in Windows) or **Send job to** (in Mac OS)

There are 29 personal boxes, numbered **01 to 29**. You can specify a name and password for each personal box.

Up to 100 print jobs can be saved in all personal boxes combined.

Saving Print Jobs on the Printer Hard Disk

To save print jobs on the printer's hard disk, configure the printer driver.

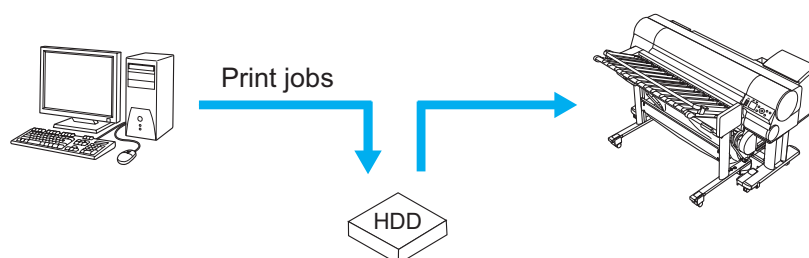



• Printing from the following software also enables you to save print jobs on the printer's hard disk.

Windows

- Free Layout →P.199
- Color imageRUNNER Enlargement Copy →P.221
- Preview →P.189

Mac OS

- Free Layout →P.307
- Preview →P.189

Configuring the Printer Driver in Windows

1 Access the **Page Setup** sheet.

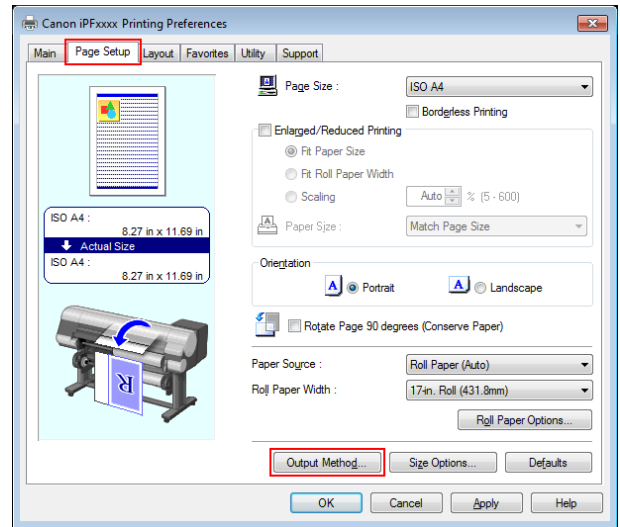

2 Click **Output Method** to display the **Output Method** dialog box.

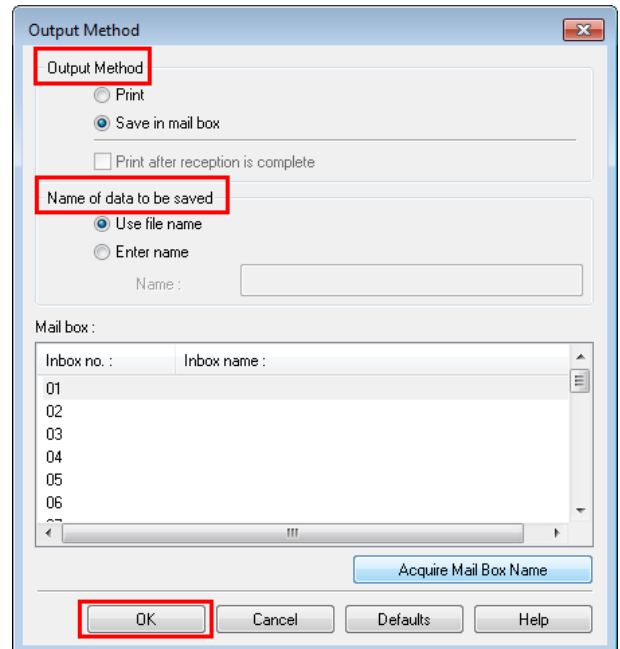

3 Make your selection in **Output Method**.

- **Print**
Save print jobs on the printer's hard disk after printing.
- **Save in mail box**
Save print jobs on the printer's hard disk.

If you choose **Save in mail box**, also specify the destination personal box in the **Mail box** list.

• **Print after reception is complete**

This option is available in combination with **Print**. You can prevent degradation of print quality that occurs when receiving a print job is interrupted and printing is aborted in the middle.



• Click **Acquire Mail Box Name** to display personal box names in the **Mail box** list, as acquired from the printer.

4 In **Name of data to be saved**, specify how to name saved print jobs.

- To use the file name, choose **Use file name**.
- Otherwise choose **Enter name** and enter a name in **Name**.

5 Click **OK** to close the **Output Method** dialog box.

Configuring the printer driver in Mac OS

1 Access the **Additional Settings** pane.

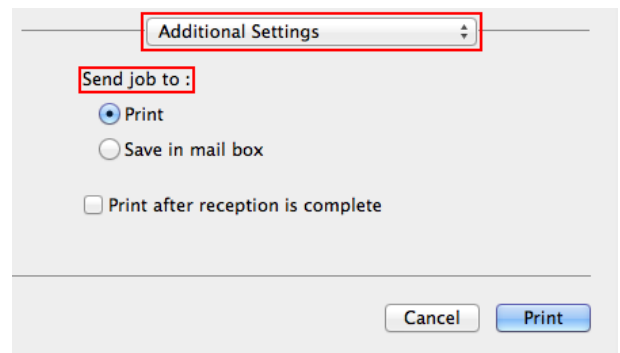

2 Make your selection in **Send job to**.

• **Print**

Save print jobs on the printer's hard disk after printing.

• **Save in mail box**

Save print jobs on the printer's hard disk.

The **Destination** dialog box is displayed if you select **Save in mail box**. Here, specify the name and personal box number for saved print jobs.

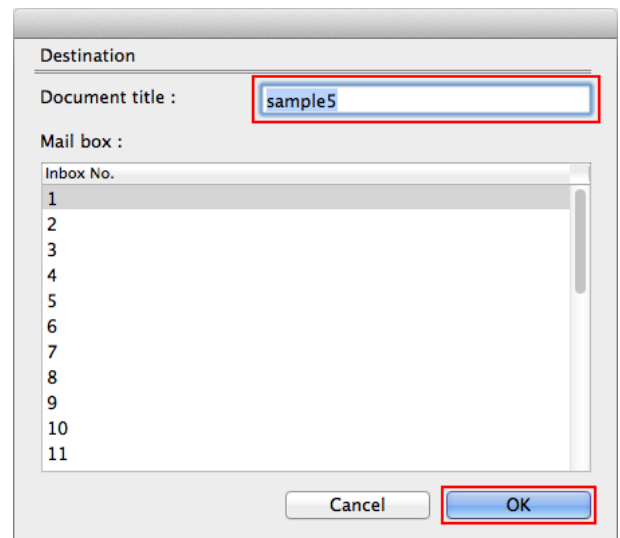

1. In **Document title**, enter a name to identify saved print jobs.



• If printed from Free Layout or Preview, the **Document title** is saved under the name image-PROGRAF.

2. Select the personal box number in the **Mail box** list.

3. Click **OK** to close the **Destination** dialog box.

• **Print after reception is complete**

This option is available in combination with **Print**. You can prevent degradation of print quality that occurs when receiving a print job is interrupted and printing is aborted in the middle.

Managing the Job Queue (Deleting or Preempting Other Jobs)

Print jobs being processed by the printer are collectively called the job queue. You can delete or preempt jobs in the job queue as needed.

These operations are available from the Control Panel, in RemoteUI, imagePROGRAF Status Monitor, and imagePROGRAF Printmonitor.

• **Delete**

Note that only jobs that are not currently being deleted can be deleted from the job queue.

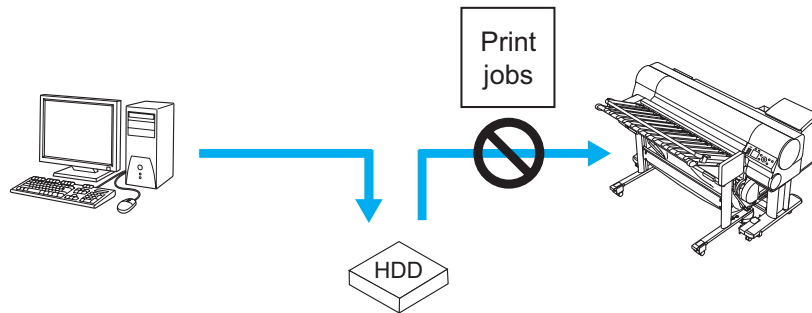

• **Preempting other jobs**

You can preempt other jobs by printing jobs that are currently being received or prepared for processing first.

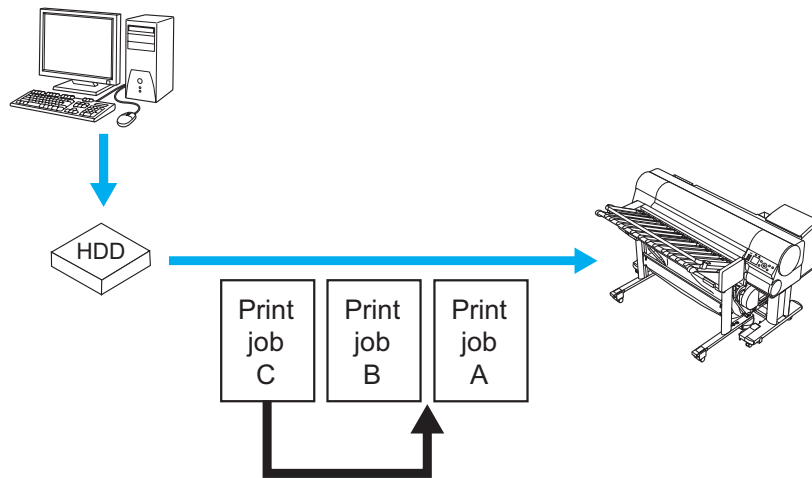

• For information on managing jobs being held, see "Managing Pending Jobs (Printing or Deleting Jobs on Hold)." →P.525

Using the Control Panel

1 On the **Tab Selection screen** of the Control Panel, press ◀ or ▶ to select the Job tab ().

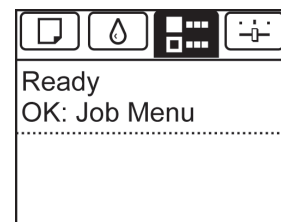

• If the **Tab Selection screen** is not displayed, press the **Menu** button.

2 Press the **OK** button.
The **Job Menu** is displayed.

3 Manage the job queue as needed.

• Deleting jobs

1. Press ▲ or ▼ to select **Print Job**, and then press the **OK** button.
2. Press ▲ or ▼ to select the print job to delete, and then press the **OK** button.
3. Press ▲ or ▼ to select **Delete**, and then press the **OK** button.

• Preempting other jobs

1. Press ▲ or ▼ to select **Print Job**, and then press the **OK** button.
2. Press ▲ or ▼ to select the job to print first, and then press the **OK** button.
3. Press ▲ or ▼ to select **Preempt Jobs**, and then press the **OK** button.

Using RemoteUI

Manage jobs as needed on the **Print Job** page. For details, refer to the RemoteUI help file.

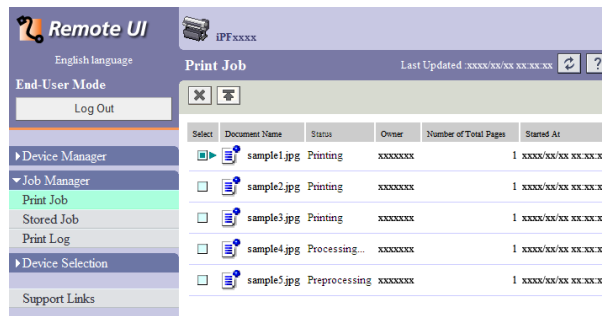

Using imagePROGRAF Status Monitor (Windows)

Manage jobs as needed on the **Job** sheet. For details, refer to the imagePROGRAF Status Monitor help file.

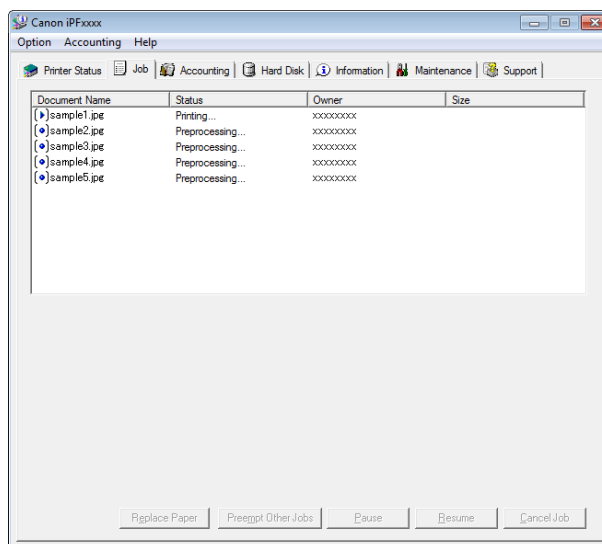

Using imagePROGRAF Printmonitor (Mac OS)

Manage jobs as needed on the **Driver** sheet. For details, refer to the imagePROGRAF Printmonitor help file.

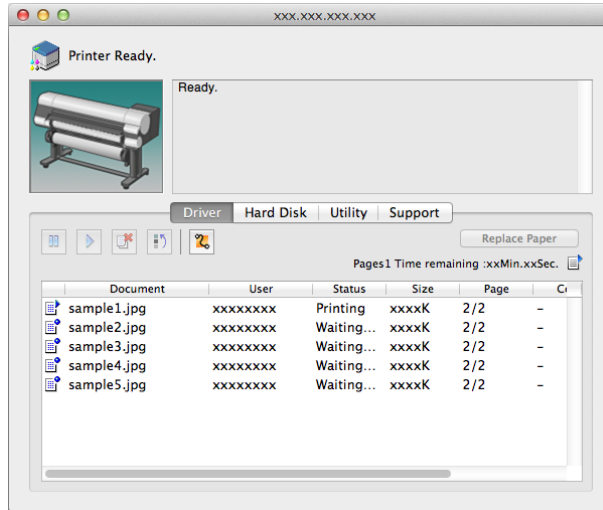

Managing Pending Jobs (Printing or Deleting Jobs on Hold)

If the type or size of paper loaded does not match the settings in the print job received when you have set **Detect Mismatch to Hold Job** in the Control Panel menu, the print job is held on the printer as a pending job in the job queue.

Manage held jobs such as these as follows.

These operations are available from the Control Panel or in RemoteUI, imagePROGRAF Status Monitor, and imagePROGRAF Printmonitor.



Note

- As long as you do not manage held jobs from the Control Panel, imagePROGRAF Status Monitor, or imagePROGRAF Printmonitor, they will remain in the job queue. In this case, the printer processes the next job in the queue without pausing.
- To print held jobs, replace the loaded paper with the paper specified in the print job.
(See "Loading Rolls in the Printer." → P.345)
(See "Loading Sheets in the Printer." → P.369)

Using the Control Panel

1 On the **Tab Selection screen** of the Control Panel, press ◀ or ▶ to select the Job tab ().

"**There are held jobs.**" is displayed if jobs are being held.

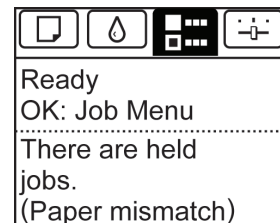

Note

- If the **Tab Selection screen** is not displayed, press the **Menu** button.

2 Press the **OK** button.
The **Job Menu** menu is displayed.

3 Press ▲ or ▼ to select **Print Job**, and then press the **OK** button.

- 4 Press ▲ or ▼ to select the print job to manage, and then press the **OK** button.
Held jobs are labeled with an icon.



- 5 Press ▲ or ▼ to select **Print Anyway** or **Delete**, and then press the **OK** button.
 - If you choose **Print Anyway**
Press ▲ or ▼ to select **Yes** or **No**, and then press the **OK** button.
 - If you choose **Delete**
Press ▲ or ▼ to select **Yes** or **No**, and then press the **OK** button.

Using RemoteUI

Manage jobs as needed on the **Print Job** page. For details, refer to the RemoteUI help file.

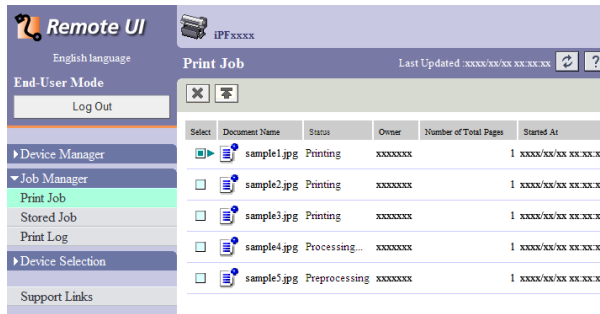

Using imagePROGRAF Status Monitor

Manage jobs as needed on the **Job** sheet. For details, see "Job Management Using imagePROGRAF Status Monitor." → P.503

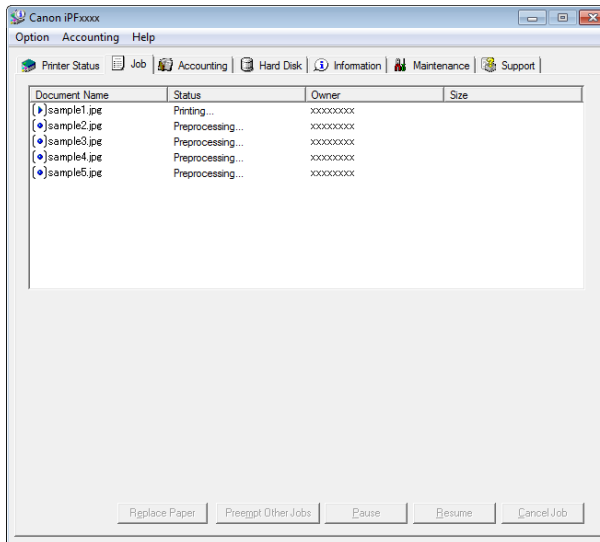

Using imagePROGRAF Printmonitor

Manage jobs as needed on the **Driver** sheet. For details, see "Job Management Using imagePROGRAF Printmonitor." → P.506

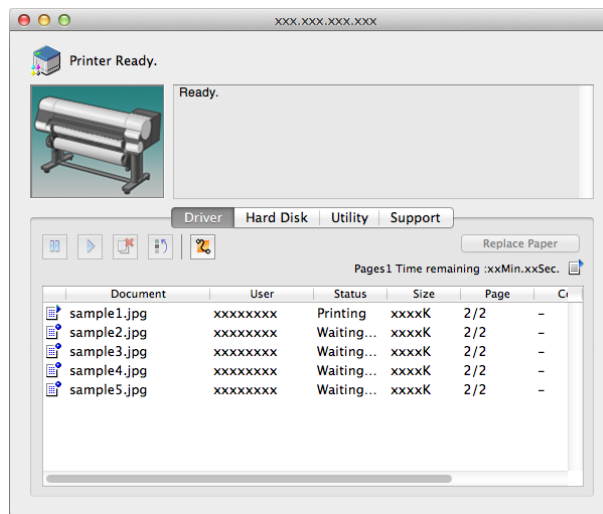

Printing Saved Jobs

Print saved print jobs stored on the printer's hard disk as follows.

These operations are available from the Control Panel or in RemoteUI, imagePROGRAF Status Monitor, and imagePROGRAF Printmonitor.

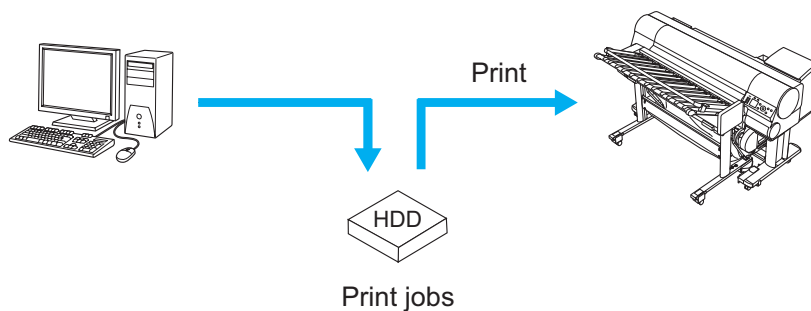

Using the Control Panel

- 1 On the **Tab Selection** screen of the Control Panel, press ◀ or ▶ to select the Job tab ().

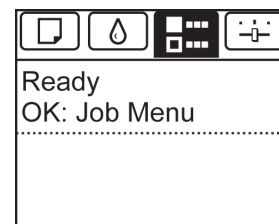

- If the **Tab Selection** screen is not displayed, press the **Menu** button.

Note

- 2 Press the **OK** button.
The **Job Menu** menu is displayed.
- 3 Press ▲ or ▼ to select **Stored Job**, and then press the **OK** button.
- 4 Press ▲ or ▼ to select the box number (in the range 00–29), and then press the **OK** button.



- Enter a password if one has been set, and then press the **OK** button.

Note

5 Press ▲ or ▼ to select **Job List**, and then press the **OK** button.

6 Press ▲ or ▼ to select the saved job, and then press the **OK** button.

7 Press ▲ or ▼ to select **Print**, and then press the **OK** button.

8 Specify the number of copies and press the **OK** button.

Using RemoteUI

1 On the **Stored Job** page, choose the box.

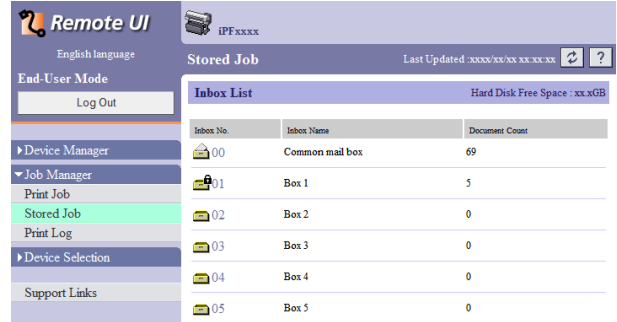

 • Enter a password if one has been set.

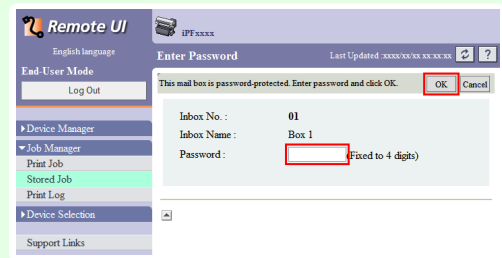

2 Select the print job and click **Resume**.

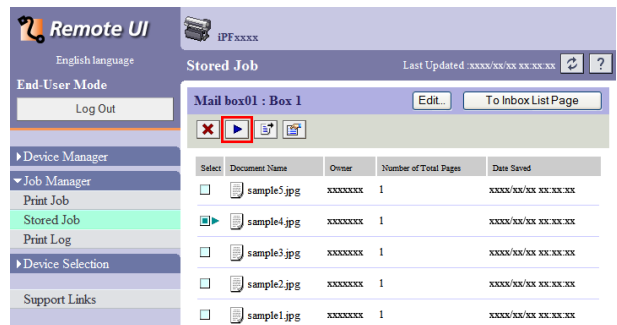

3 On the **Print Saved Document** page, enter the quantity to print in **Copies** and click **OK**.

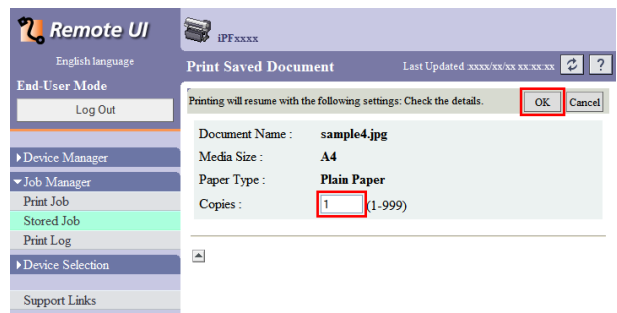

For details, refer to the RemoteUI help.

Using imagePROGRAF Status Monitor

1 On the **Hard Disk** sheet, select a box and click **Open**.

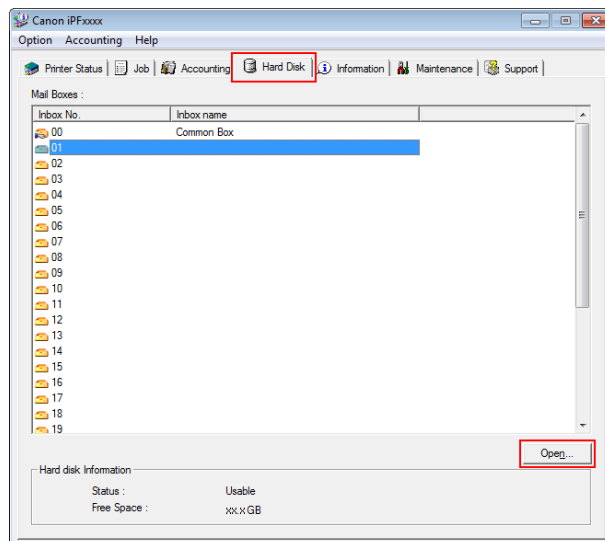

Note

- Enter a password if one has been set.

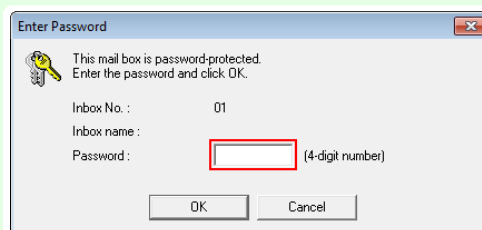

2 In the **Documents** dialog box, select the print job and click **Print**.

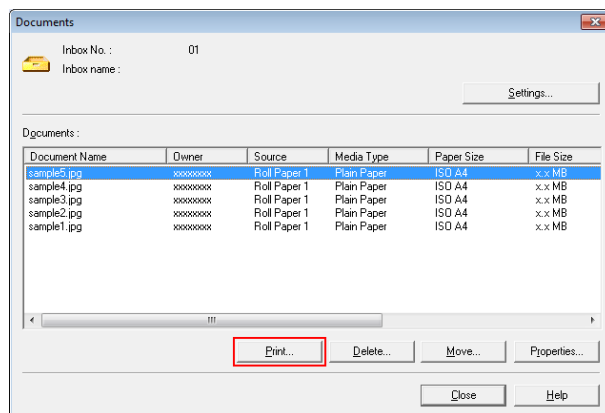

3 In the **Print** dialog box, enter the quantity to print in **Copies** and click **OK**.

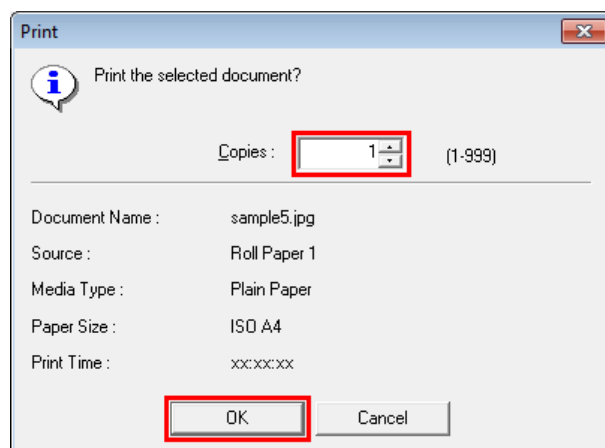



- The printing time initially indicates how long it took to finish printing one copy during the previous print job. If you change the value in **Copies**, the printing time indicates the time it took to print one copy during the previous print job multiplied by the number of copies.

For details, refer to the imagePROGRAF Status Monitor help file.

Using imagePROGRAF Printmonitor

1 On the **Hard Disk** pane, click ► by **Inbox No./Name**.

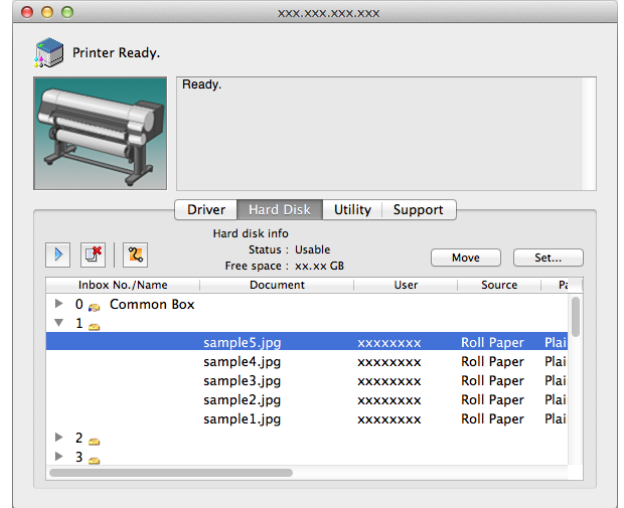

- Enter a password if one has been set. The password is a four-digit number.



2 Select the saved job and click **Resume Printing**.

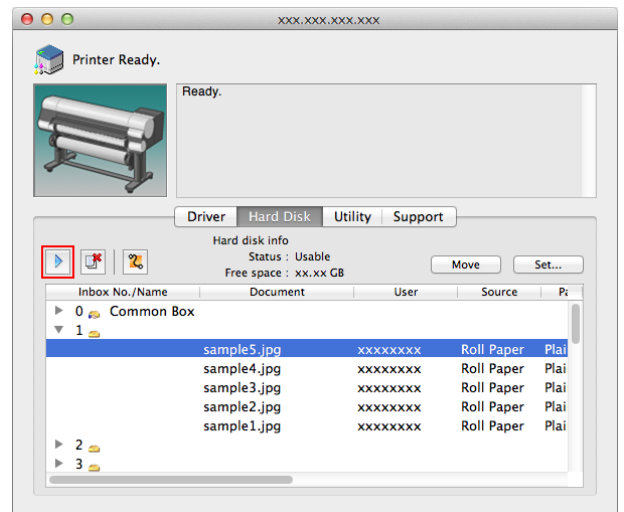

3 In the **Resume Printing** dialog box, enter the quantity to print and click **OK**.

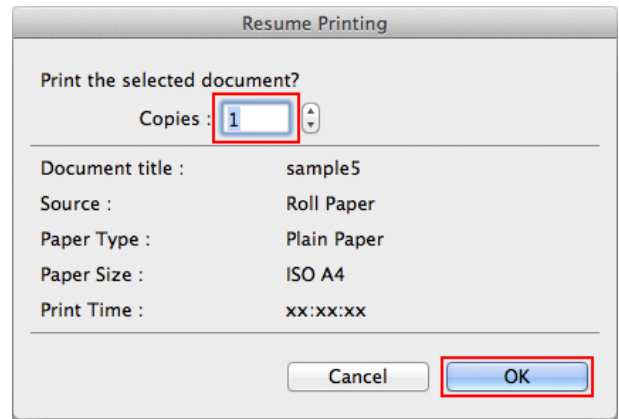

For details, refer to the imagePROGRAF Printmonitor help file.

Deleting Saved Jobs

Delete saved print jobs stored on the printer's hard disk as follows. This operation is available from the Control Panel, in RemoteUI, imagePROGRAF Status Monitor, and imagePROGRAF Printmonitor.

Using the Control Panel

1 On the **Tab Selection screen** of the Control Panel, press ◀ or ▶ to select the Job tab ().



 • If the **Tab Selection screen** is not displayed, press the **Menu** button.

Note

2 Press the **OK** button. The **Job Menu** is displayed.

3 Press ▲ or ▼ to select **Stored Job**, and then press the **OK** button.

4 Press ▲ or ▼ to select the box number (in the range 00–29), and then press the **OK** button.

 • Enter a password if one has been set, and then press the **OK** button.

Note

5 Press ▲ or ▼ to select **Job List**, and then press the **OK** button.

6 Press ▲ or ▼ to select the saved job, and then press the **OK** button.

7 Press ▲ or ▼ to select **Delete**, and then press the **OK** button.

8 Press ▲ or ▼ to select **Yes**, and then press the **OK** button.

Using RemoteUI

1 On the **Stored Job** page, choose the mail box.

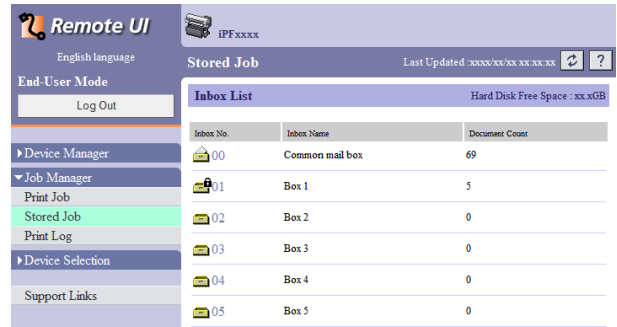

- Enter a password if one has been set.



2 Select the print job and click **Delete**.

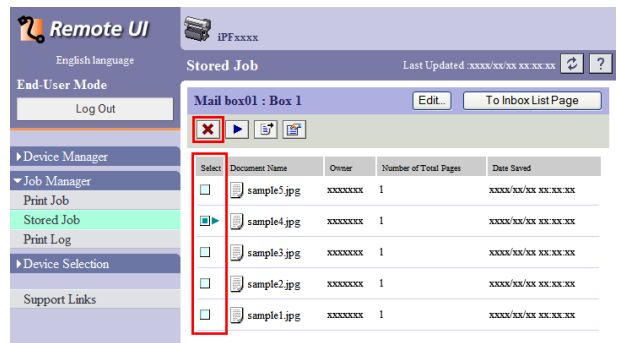

For details, refer to the RemoteUI help file.

Using imagePROGRAF Status Monitor

1 On the **Hard Disk** sheet, select a box and click **Open**.

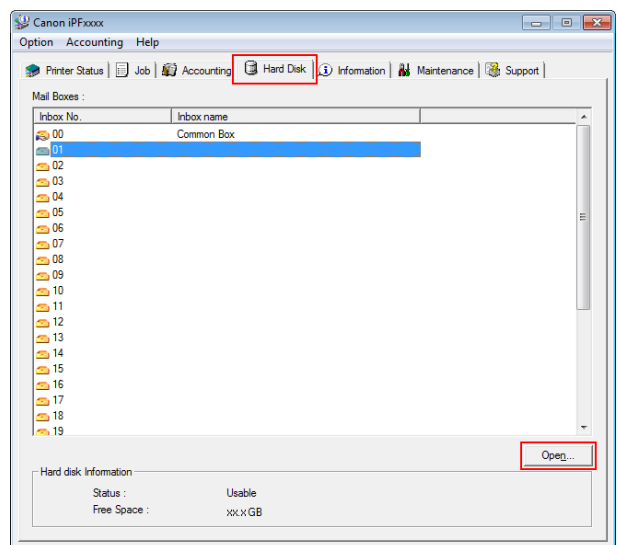



- Enter a password if one has been set.

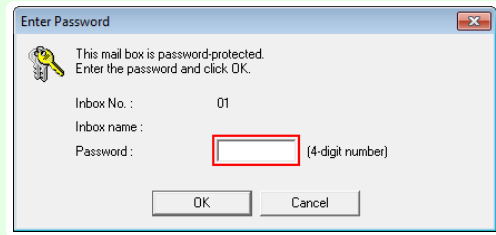

2

In the **Documents** dialog box, select the print job and click **Delete**.

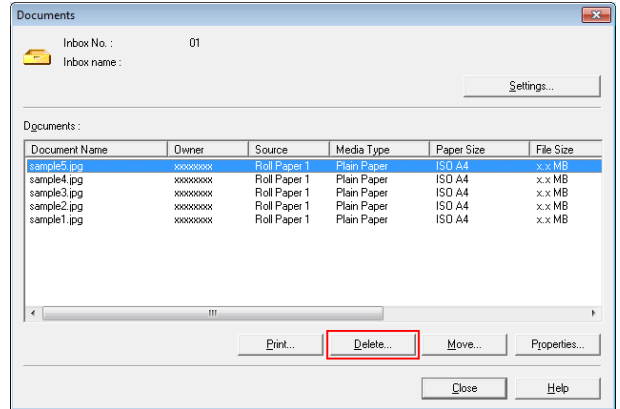

For details, refer to the imagePROGRAF Status Monitor help file.

Using imagePROGRAF Printmonitor

1

In the **Hard Disk** pane, click ► next to **Inbox No./Name**.

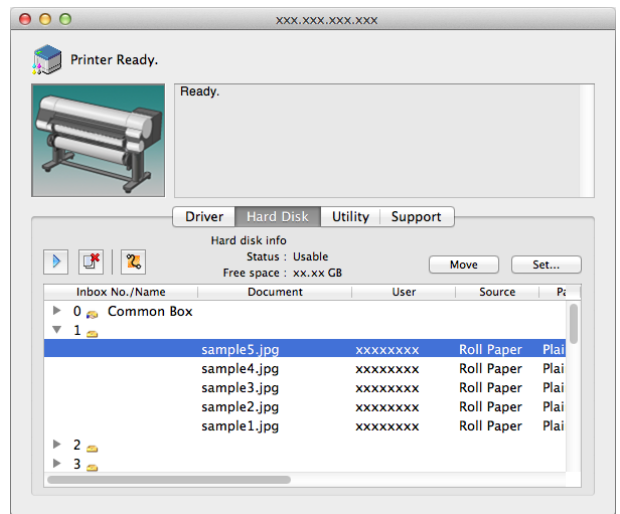

- Enter a password if one has been set.
The password is a four-digit number.



2 Select the print job and click the **Delete** button.

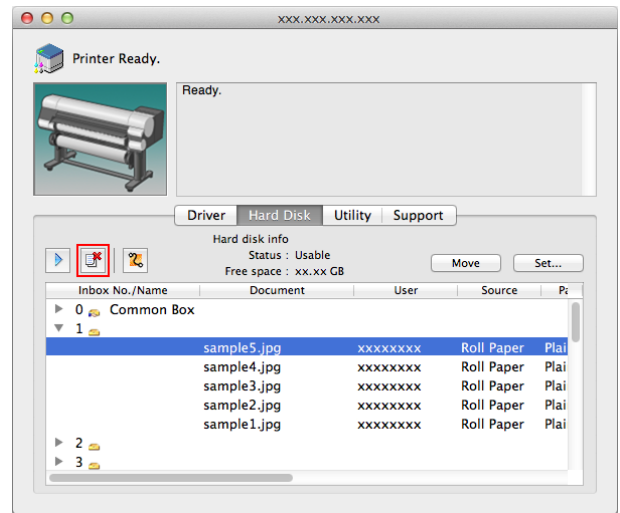

For details, refer to the imagePROGRAF Printmonitor help file.

Moving Saved Jobs

Print jobs stored on the printer's hard disk (saved jobs) can be moved from the current box to another box as follows.

However, jobs saved in personal boxes cannot be moved to the shared mailbox.

This operation is available in RemoteUI, imagePROGRAF Status Monitor, and imagePROGRAF Printmonitor.

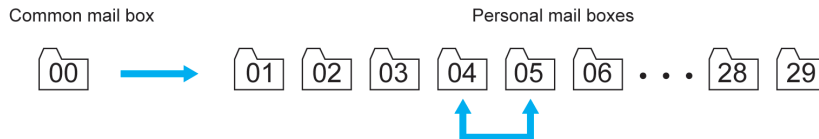

- Jobs stored in the shared mailbox may be automatically deleted under some conditions. To prevent jobs from being deleted, move them from the shared mailbox to personal boxes. (See "Using the Printer Hard Disk.") →P.519

Using RemoteUI

1 On the **Stored Job** page, choose the box.

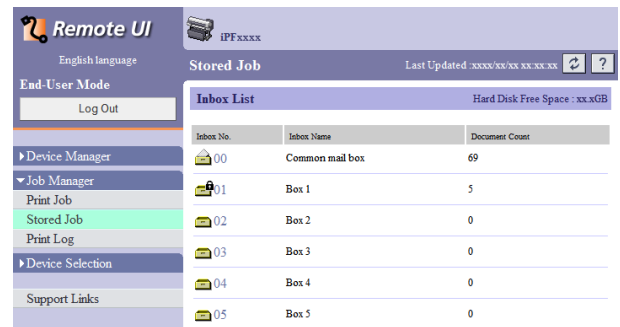

- Enter a password if one has been set.

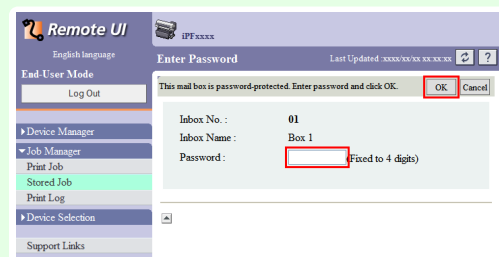

2 Select the print job and click **Move Document**.

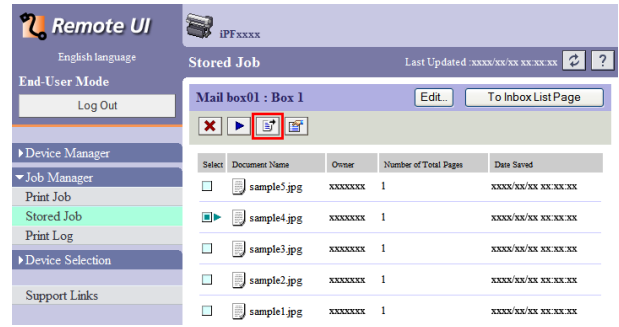

3 On the **Move Document** page, select the name or number of the destination personal box in the **Destination mail box** list and click **OK**.

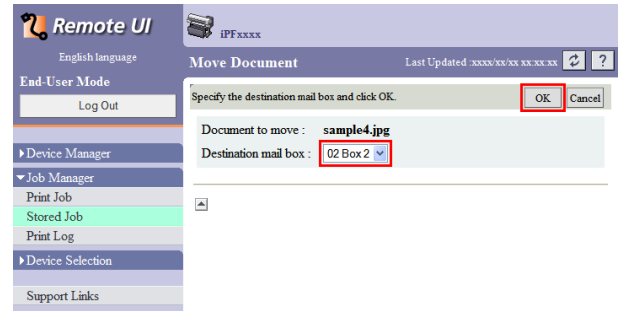

For details, refer to the RemoteUI help file.

Using imagePROGRAF Status Monitor (Windows)

1 On the **Hard Disk** sheet, select a box and click **Open**.

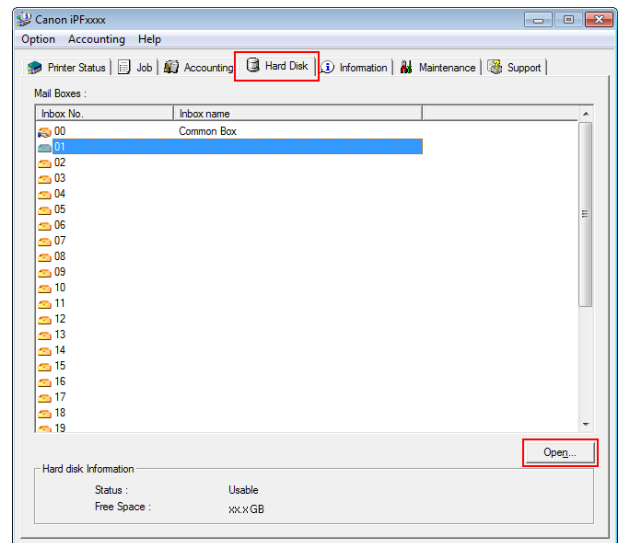

Note

- Enter a password if one has been set.

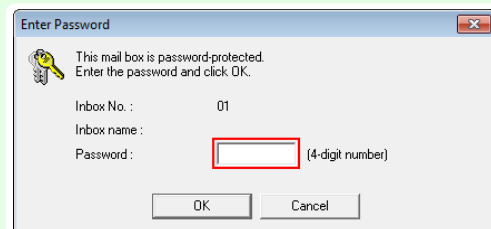

2 In the **Documents** dialog box, select the print job and click **Move**.

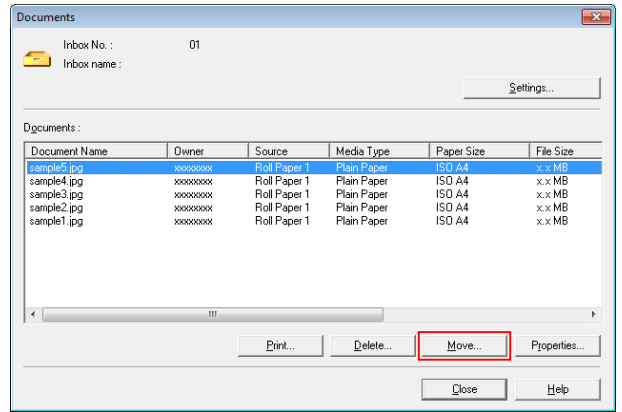

3 In the **Move** dialog box, select the destination personal box and click **OK**.

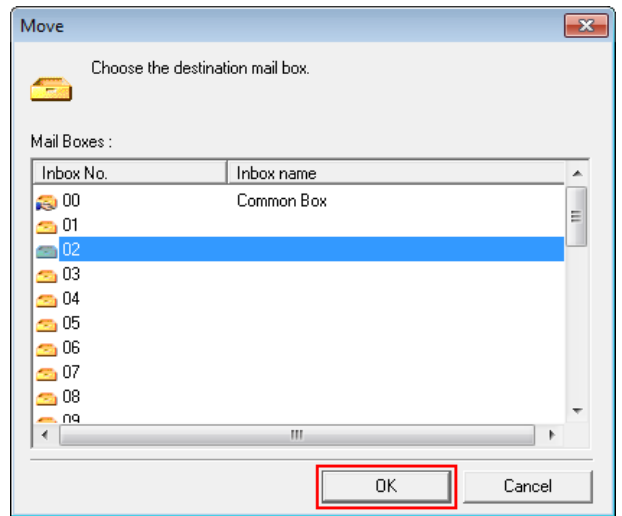

For details, refer to the imagePROGRAF Status Monitor help file.

Using imagePROGRAF Printmonitor (Mac OS)

1 In the **Hard Disk** pane, click ► next to **Inbox No./Name**.

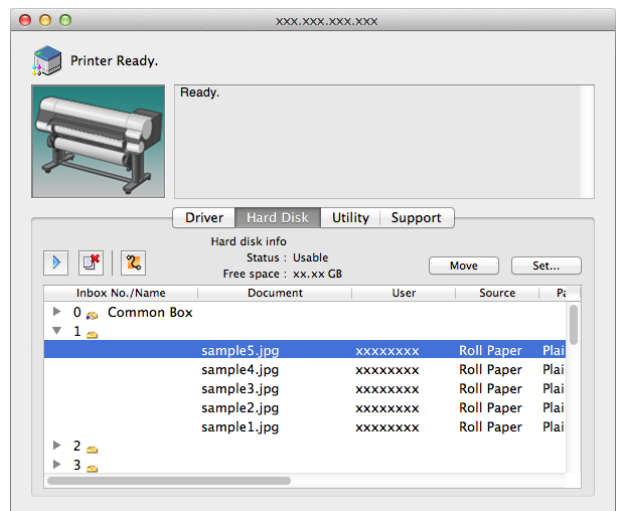

Print Job Management
Basic Print Job Operations



- Enter a password if one has been set. The password is a four-digit number.



2

Select the print job and click **Move**.

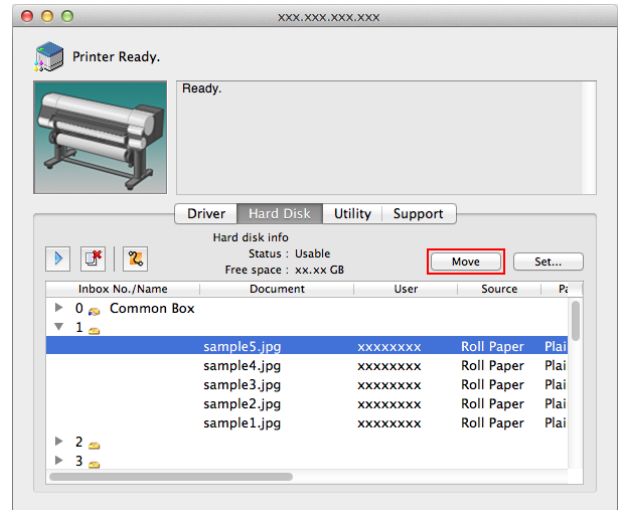

3

In the **Move Document** dialog box, select the destination personal box and click **OK**.

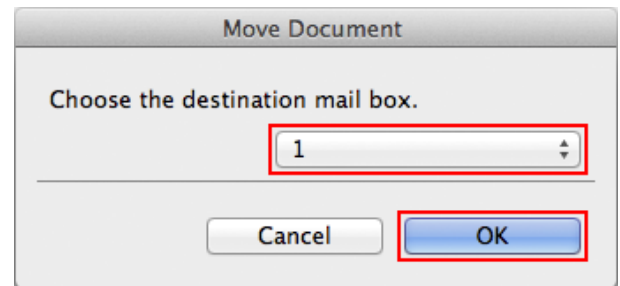

For details, refer to the imagePROGRAF Printmonitor help file.

Advanced Print Job Operations

Saving Print Jobs Sent from Sources Other than the Printer Driver 538

Printing Without Saving Jobs in the Common Box 539

Setting Passwords for Personal Boxes 540

Naming Personal Boxes 543

Displaying a List of Saved Jobs 545

Printing a List of Saved Jobs 548

Displaying Details of Saved Jobs 549

Renaming Saved Jobs 551

➔ Printer Hard Disk Operations 475

➔ Checking the Free Hard Disk Space 476

Saving Print Jobs Sent from Sources Other than the Printer Driver

To save print jobs sent from software or systems other than the printer driver or applications provided with the printer, complete the **Output Method** and **Print After Recv** settings in the Control Panel menu.

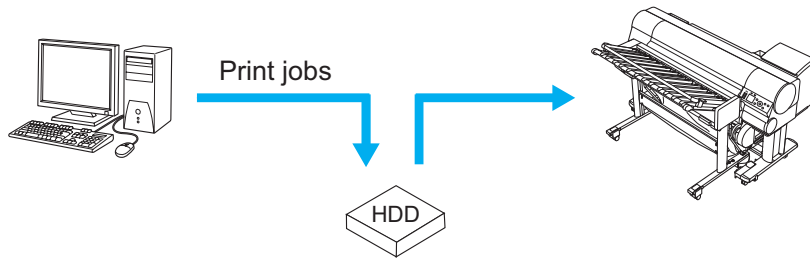

• Contact the software or system developer for information about support for this printer function.

Specifying Output Method

In **Output Method**, specify how to manage jobs, regarding printing and saving them.

- **Print**
Save print jobs automatically at the same time they are printed. (This is the default format.)
- **Print (Auto Del)**
Save print jobs temporarily at the same time they are printed and delete them after printing.
- **Save: Box 01** (Here, the number represents a box number)
Save print jobs on the printer.

1 On the **Tab Selection screen** of the Control Panel, press ◀ or ▶ to select the Settings/Adj. tab ().

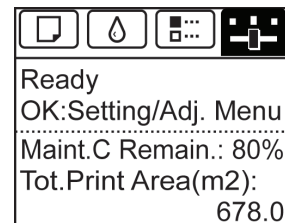

• If the **Tab Selection screen** is not displayed, press the **Menu** button.

2 Press the **OK** button.
The **Set./Adj. Menu** is displayed.

3 Press ▲ or ▼ to select **System Setup**, and then press the **OK** button.

4 Press ▲ or ▼ to select **Output Method**, and then press the **OK** button.



- If a password has been set on the printer, the **Logon** screen is displayed. To change the settings, select **Administrator** and press the **OK** button. When the **Admin.Pswd** screen is displayed, enter the password and press the **OK** button to proceed to the next step. If you select **User** and press the **OK** button, you can check settings values but cannot change them.

5 Press ▲ or ▼ to select **Print**, **Print (Auto Del)**, or **Save: Box 01**. Follow these steps only when you select **Save: Box 01**.

6 Press ▲ or ▼ to select the box, and then press the **OK** button.

Specify **Print After Recv**

To save print jobs on the hard disk before printing, specify **Print After Recv**. Printing will start when **Print After Recv** is set to **On**, even if you have selected **Save: Box 01** in **Output Method**.

1 On the **Tab Selection screen** of the Control Panel, press ◀ or ▶ to select the **Settings/Adj. tab** ().

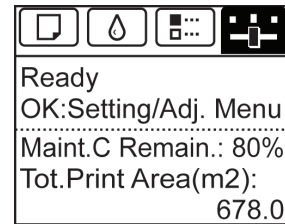

- If the **Tab Selection screen** is not displayed, press the **Menu** button.

2 Press the **OK** button. The **Set./Adj. Menu** is displayed.

3 Press ▲ or ▼ to select **System Setup**, and then press the **OK** button.

4 Press ▲ or ▼ to select **Print After Recv**, and then press the **OK** button.

5 Press ▲ or ▼ to select **On** or **Off**, and then press the **OK** button.

Printing Without Saving Jobs in the Common Box

Jobs sent from a computer for which you have selected **Print** in **Output Method** (in Windows) or **Send job to** (in Mac OS) in the printer driver are saved in the shared mailbox. (See "Using the Printer Hard Disk." → P.519) When **Common Box Set.** is **Print (Auto Del)** in the Control Panel menu, print jobs for which you have selected **Print** in the **Output Method** dialog box of the printer driver are deleted from the shared mailbox after printing. Use this function when printing highly confidential documents.

1 On the **Tab Selection screen** of the Control Panel, press ◀ or ▶ to select the **Settings/Adj. tab** ().

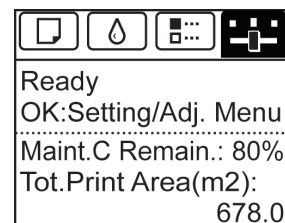

- If the **Tab Selection screen** is not displayed, press the **Menu** button.

2 Press the **OK** button. The **Set./Adj. Menu** is displayed.

3 Press ▲ or ▼ to select **System Setup**, and then press the **OK** button.

4 Press ▲ or ▼ to select **Common Box Set.**, and then press the **OK** button.



- If a password has been set on the printer, the **Logon** screen is displayed. To change the setting, select **Administrator** and press the **OK** button. When the **Admin.Pswd** screen is displayed, enter the password and press the **OK** button to proceed to the next step.
- If you select **User** and press the **OK** button, you can check settings values but cannot change them.

5 Press ▲ or ▼ to select **Print (Auto Del)**, and then press the **OK** button.

Setting Passwords for Personal Boxes

For greater security, you can specify a password for personal boxes. After you set a password, it will be required to modify the personal box settings, as well as to display, print, delete, move, and modify jobs saved in the personal box.

This operation is available in RemoteUI, imagePROGRAF Status Monitor, and imagePROGRAF Printmonitor.

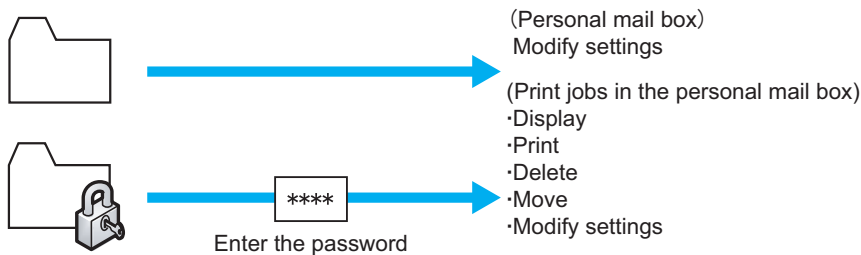

- By default, no passwords are set for personal boxes.
- A password cannot be set for the shared mailbox.
- Enter a four-digit number as the password, in the range 0001–9999.
- Even if you have set passwords, they are not required to access personal boxes in Administrator Mode in RemoteUI.

Using RemoteUI

1 On the **Stored Job** page, choose the personal box.

2 Click **Edit**.

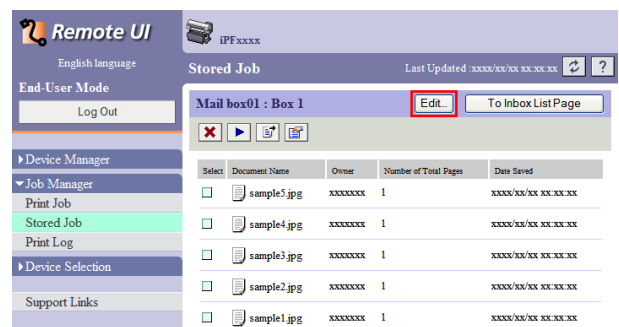

3 In the **Set/Register User's Inbox** dialog box, specify the password and click **OK**.

- **Set Password**
Select the check box.
- **Password**
Enter the password. (This field is limited to four digits in the range 0001–9999.)
- **Confirmation Number**
Re-enter the password to confirm it.

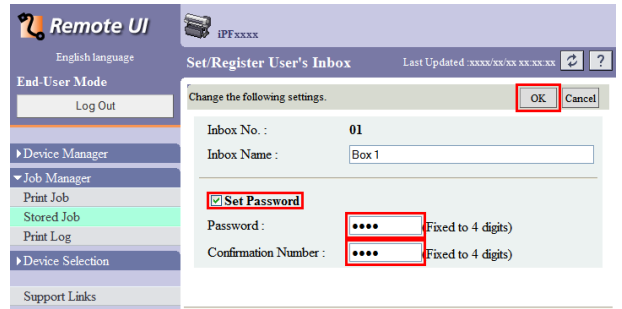

For details, refer to the RemoteUI help.

Using imagePROGRAF Status Monitor (Windows)

- 1 On the **Hard Disk** sheet, select the personal box and click **Open**.

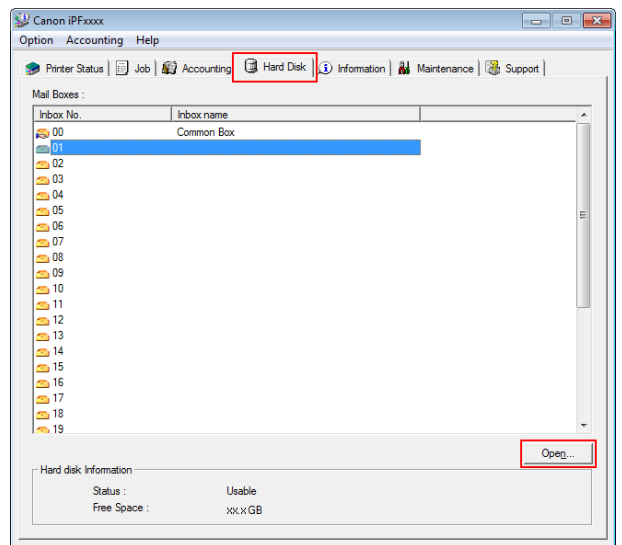

- 2 In the **Documents** dialog box, click **Settings**.

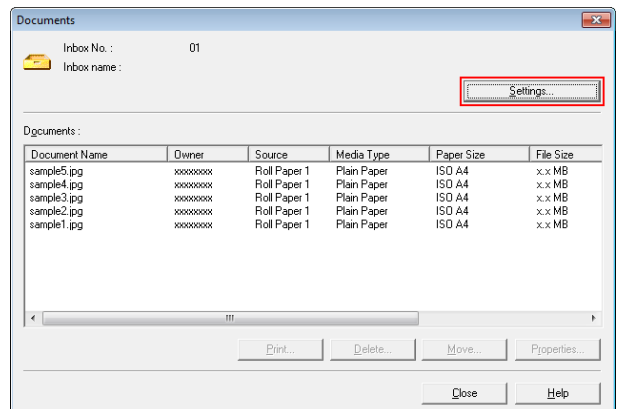

- 3 In the **Settings** dialog box, specify the password and click **OK**.

- **Set password**
Select the check box.
- **Password**
Enter the password. (This field is limited to four digits in the range 0001–9999.)
- **Re-enter to confirm**
Re-enter the password to confirm it.

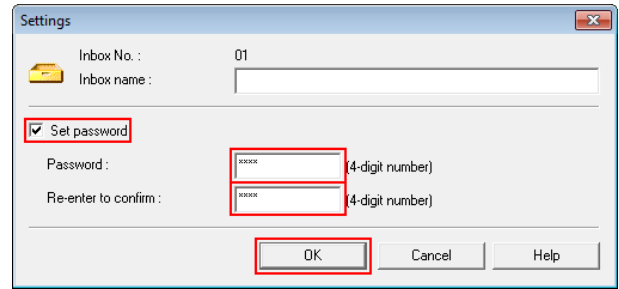

For details, refer to the imagePROGRAF Status Monitor help file.

Using imagePROGRAF Printmonitor (Mac OS)

- 1 On the **Hard Disk** pane, click ► by **Inbox No./Name**. Select a saved job in the list and click **Set**.

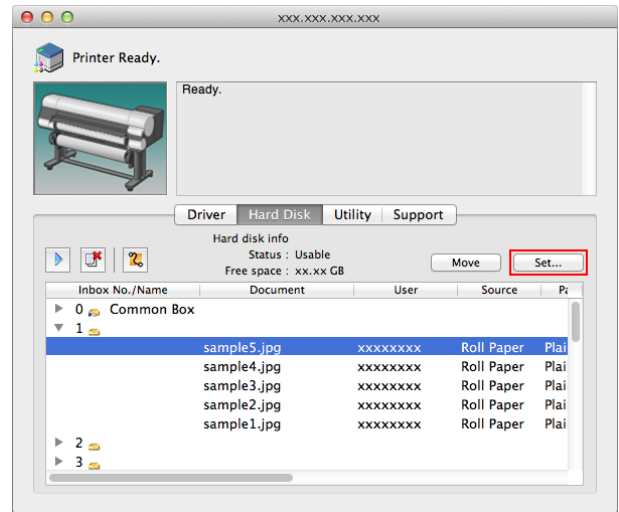

- 2 In the **Settings** dialog box, specify the password and click **OK**.

- **Set password**
Select the check box.
- **Password**
Enter the password. (This field is limited to four digits in the range 0001–9999.)
- **Verify**
Re-enter the password to confirm it.

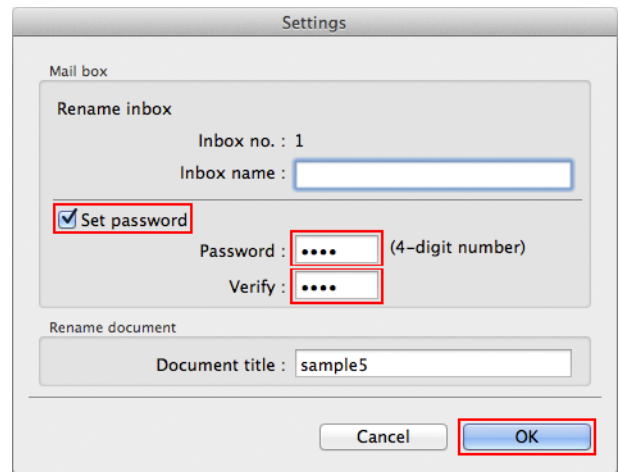

For details, refer to the imagePROGRAF Printmonitor help file.

Print Job Management
Advanced Print Job Operations

Naming Personal Boxes

For easier identification, you can assign names to personal boxes. This operation is available in RemoteUI, imagePROGRAF Status Monitor, and imagePROGRAF Printmonitor.

Using RemoteUI

1 On the **Stored Job** page, choose the personal box.

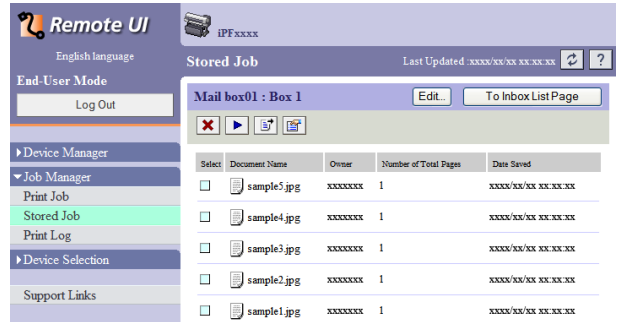

- Enter a password if one has been set for the personal box.

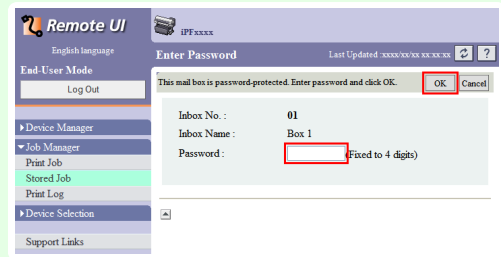

2 Click **Edit**.

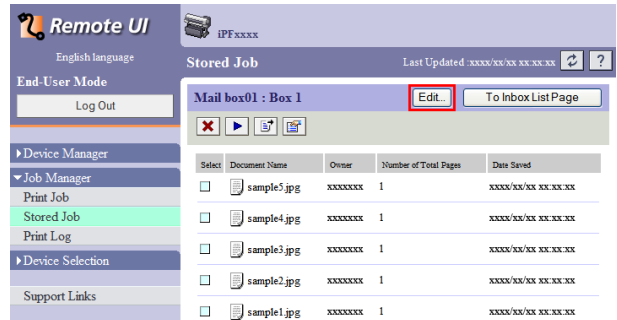

3 In the **Set/Register User's Inbox** dialog box, enter the name in **Inbox Name** and click **OK**.

For details, refer to the RemoteUI help file.

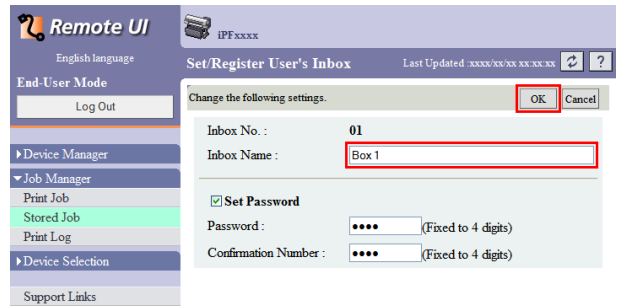

Using imagePROGRAF Status Monitor (Windows)

1 On the **Hard Disk** sheet, select the personal box and click **Open**.

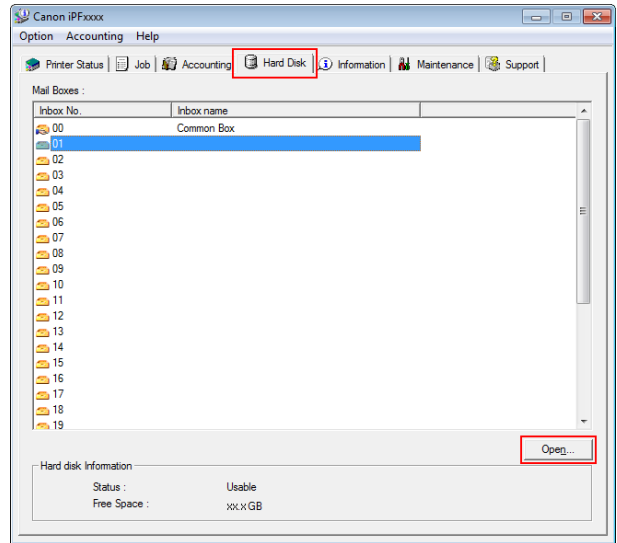

Note

- Enter a password if one has been set for the personal box.

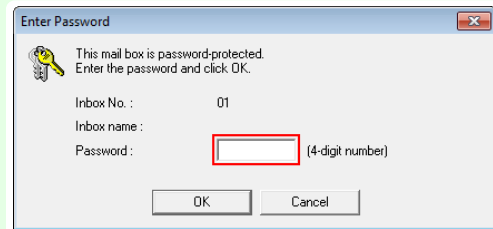

2 In the **Documents** dialog box, click **Settings**.

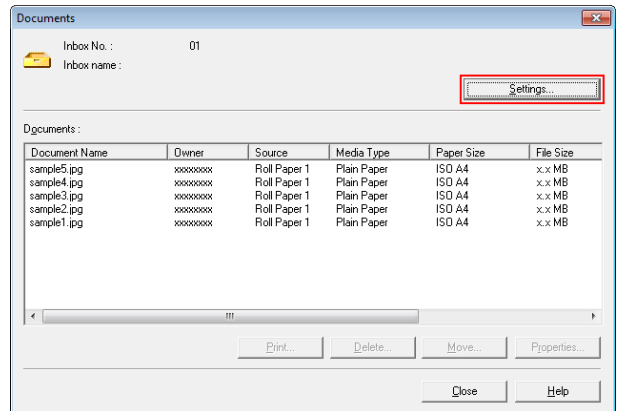

3 In the **Settings** dialog box, enter the name and click **OK**.

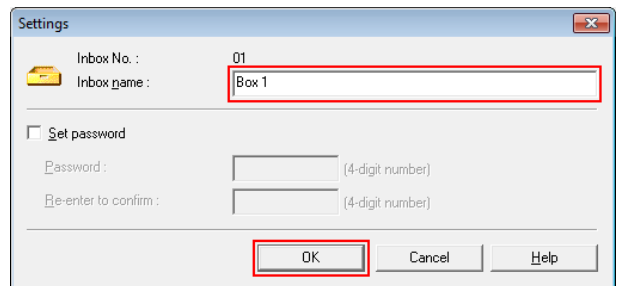

Print Job Management
Advanced Print Job Operations

For details, refer to the imagePROGRAF Status Monitor help file.

Using imagePROGRAF Printmonitor (Mac OS)

1 In the **Hard Disk** pane, click ► next to **Inbox No./Name**. Select a saved job in the list and click **Set**.

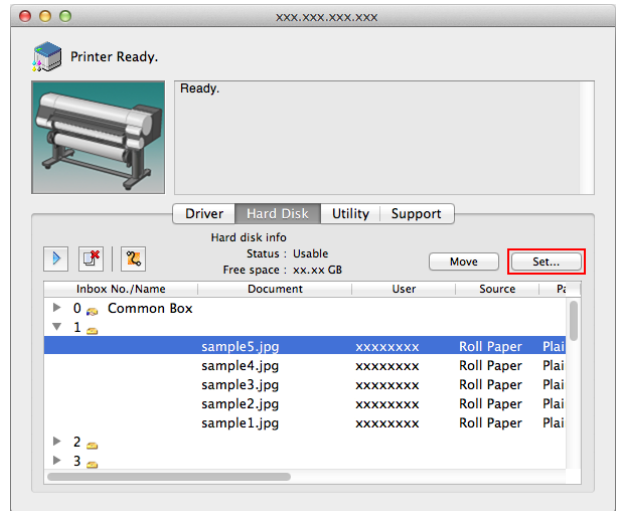

• Enter a password if one has been set. The password is a four-digit number.



2 In the **Settings** dialog box, enter the name and click **OK**.

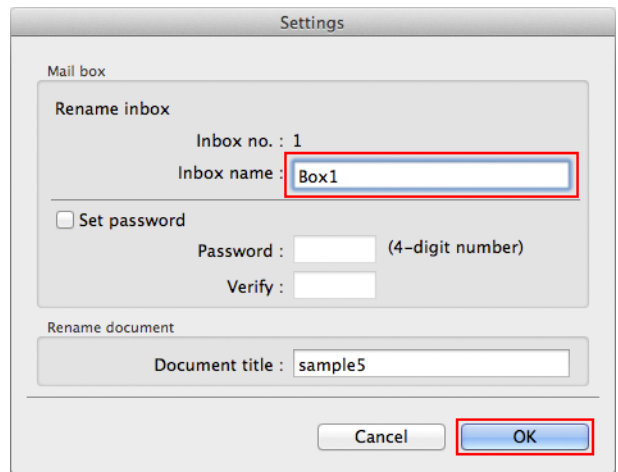

For details, refer to the imagePROGRAF Printmonitor help file.

Displaying a List of Saved Jobs

Print jobs stored on the printer's hard disk (saved jobs) can be listed by box as follows. These operations are available from the Control Panel or in RemoteUI, imagePROGRAF Status Monitor, and imagePROGRAF Printmonitor.

Using the Control Panel

1 On the **Tab Selection screen** of the Control Panel, press ◀ or ▶ to select the Job tab ().



 • If the **Tab Selection screen** is not displayed, press the **Menu** button.
Note

2 Press the **OK** button.
The **Job Menu** is displayed.

3 Press ▲ or ▼ to select **Stored Job**, and then press the **OK** button.

4 Press ▲ or ▼ to select the box number (in the range 00–29), and then press the **OK** button.

 • Enter a password if one has been set, and then press the **OK** button.
Note

5 Press ▲ or ▼ to select **Job List**, and then press the **OK** button.

Using RemoteUI

On the **Stored Job** page, choose the box.

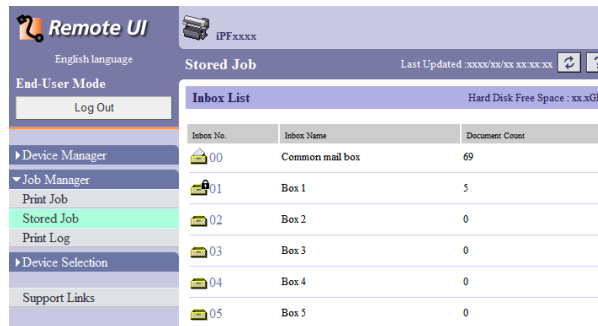

 • Enter a password if one has been set.
Note

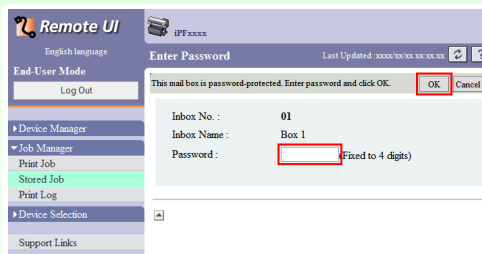

Jobs saved in the box are listed.

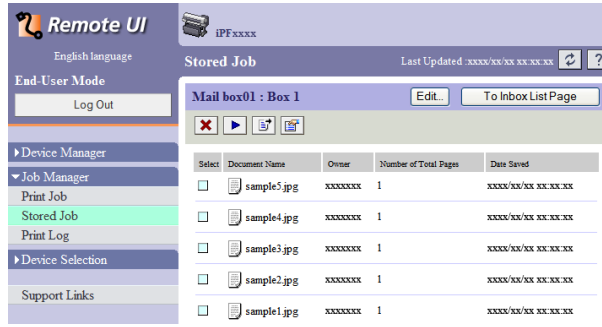

For details, refer to the RemoteUI help.

Using imagePROGRAF Status Monitor (Windows)

On the **Hard Disk** sheet, select a box and click **Open**.

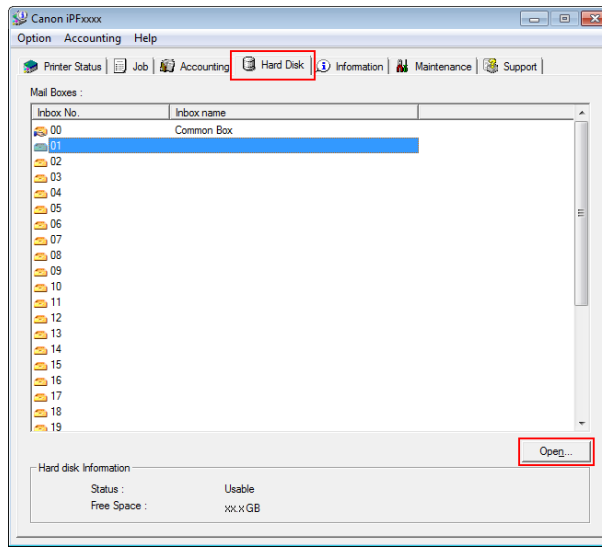

- Enter a password if one has been set.

Note

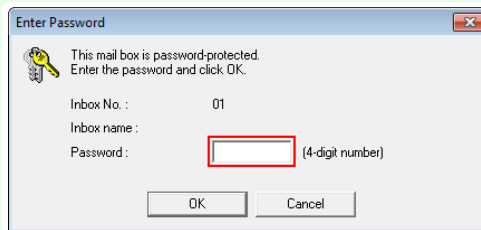

Jobs saved in that box are displayed in the **Documents** dialog box.

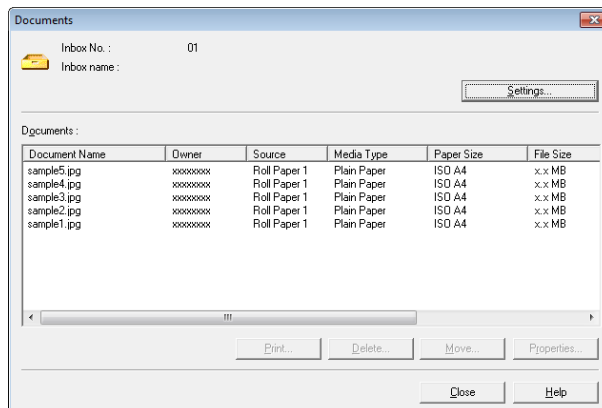

For details, refer to the imagePROGRAF Status Monitor help file.

Using imagePROGRAF Printmonitor (Mac OS)

On the **Hard Disk** pane, click ► by **Inbox No./Name**.

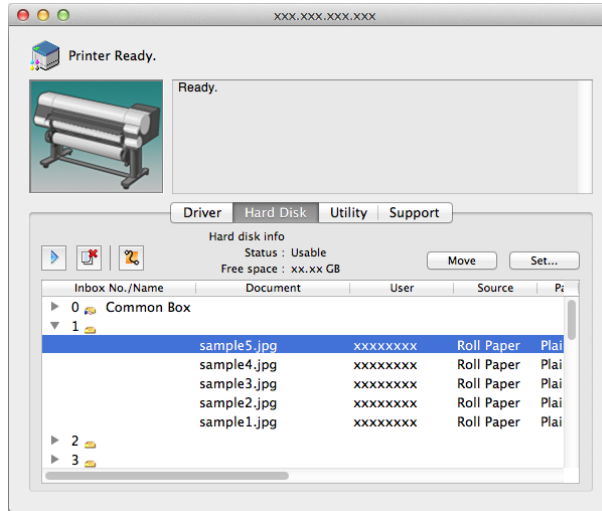

- Enter a password if one has been set. The password is a four-digit number.



For details, refer to the imagePROGRAF Printmonitor help file.

Printing a List of Saved Jobs

The list of print jobs stored on the printer's hard disk (saved jobs) can be printed by box as follows.

- 1 On the **Tab Selection** screen of the Control Panel, press ◀ or ▶ to select the Job tab ().

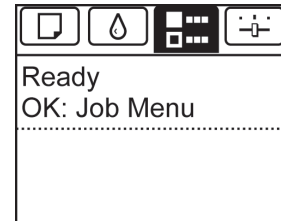

- If the **Tab Selection** screen is not displayed, press the **Menu** button.

- 2 Press the **OK** button. The **Job Menu** is displayed.
- 3 Press ▲ or ▼ to select **Stored Job**, and then press the **OK** button.

4 Press ▲ or ▼ to select the box number (in the range 00–29), and then press the **OK** button.



• Enter a password if one has been set, and then press the **OK** button.

5 Press ▲ or ▼ to select **Print Job List**, and then press the **OK** button.

Displaying Details of Saved Jobs

Details of print jobs stored on the printer's hard disk (saved jobs) can be displayed as follows. This operation is available in RemoteUI, imagePROGRAF Status Monitor, and imagePROGRAF Printmonitor.

Using RemoteUI

1 On the **Stored Job** page, choose the box.

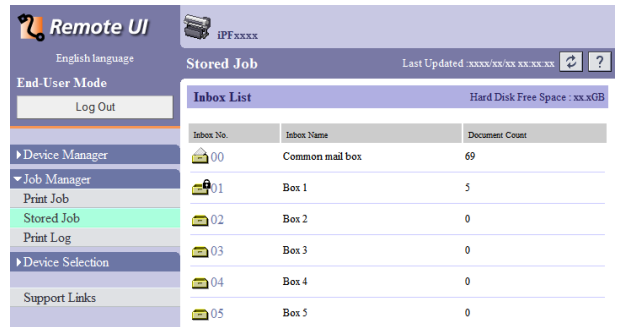

• Enter a password if one has been set.

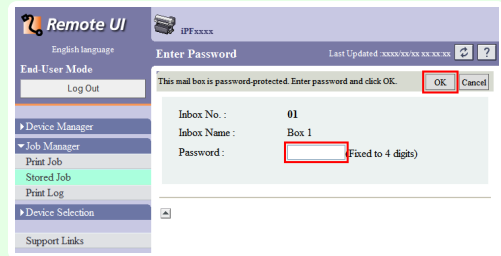

2 Select the print job and click **Details**.

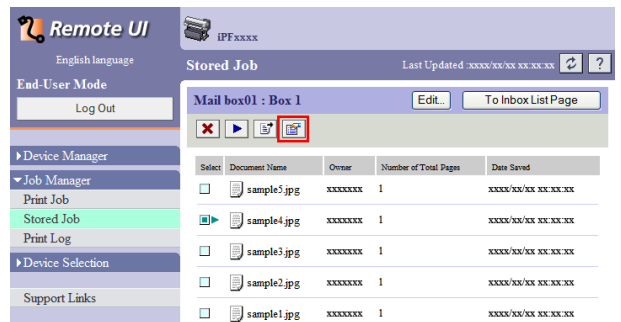

The **Details of the saved document** page is displayed.

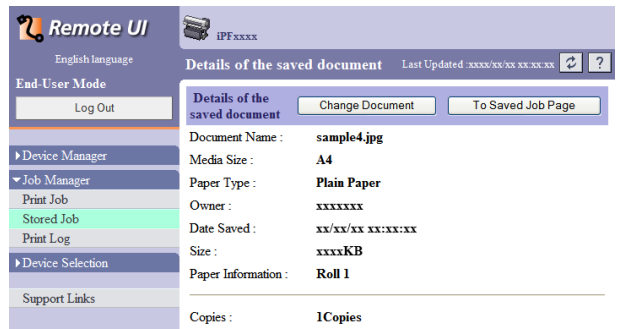

For details, refer to the RemoteUI help file.

Using imagePROGRAF Status Monitor (Windows)

- 1 On the **Hard Disk** sheet, select a box and click **Open**.

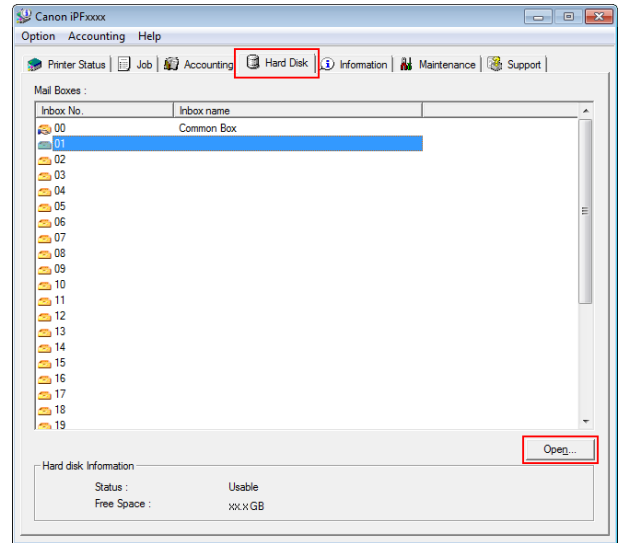

Note

- Enter a password if one has been set.

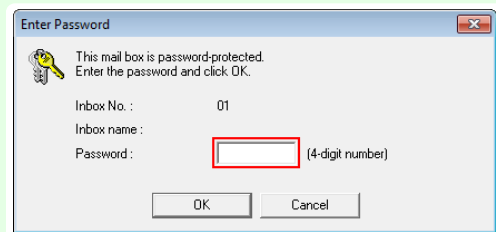

- 2 In the **Documents** dialog box, select the print job and click **Properties**.

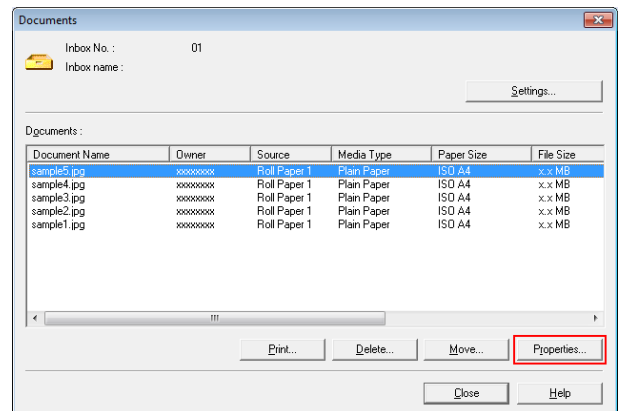

The **Properties** dialog box is displayed.

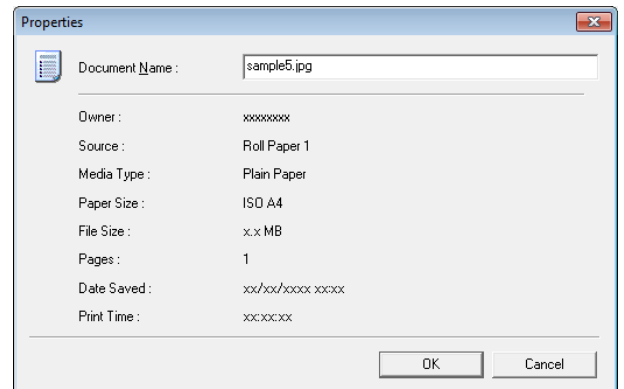

For details, refer to the imagePROGRAF Status Monitor help file.

Using imagePROGRAF Printmonitor (Mac OS)

- 1 In the **Hard Disk** pane, click ► next to **Inbox No./Name**.

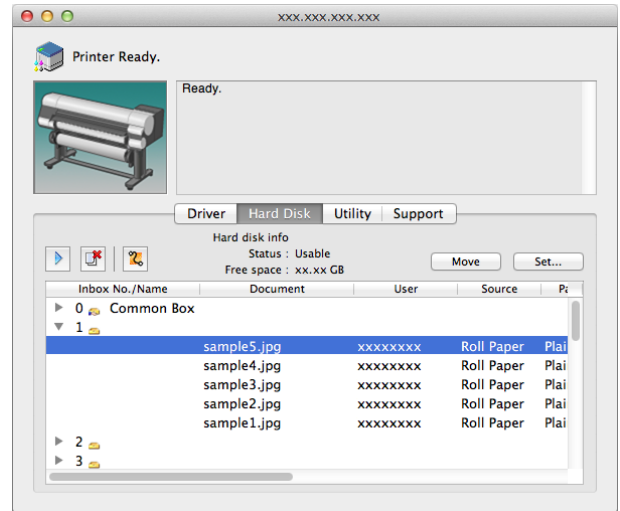

- Enter a password if one has been set. The password is a four-digit number.
- Note



For details, refer to the imagePROGRAF Printmonitor help file.

Renaming Saved Jobs

Print jobs stored on the printer's hard disk (saved jobs) can be renamed as follows. This operation is available in RemoteUI, imagePROGRAF Status Monitor, and imagePROGRAF Printmonitor.

Using RemoteUI

- 1 On the **Stored Job** page, choose the box.

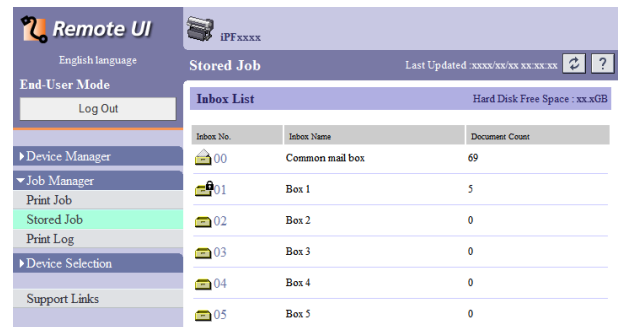

- Enter a password if one has been set.
- Note

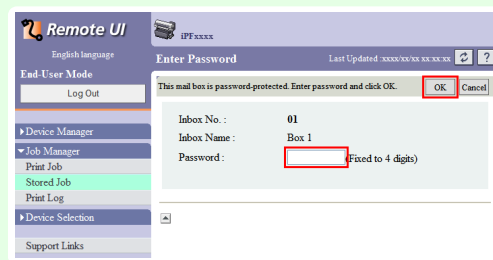

2 Select the print job and click **Details**.

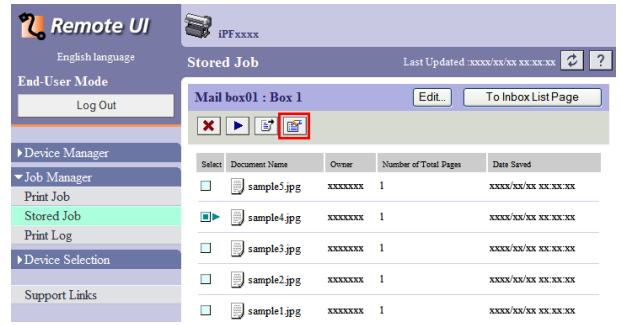

3 On the **Details of the saved document** page, click **Change Document**.

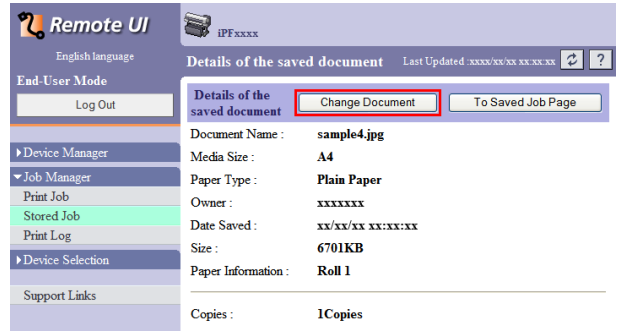

4 In the **Rename Saved Document** dialog box, enter the name and click **OK**.

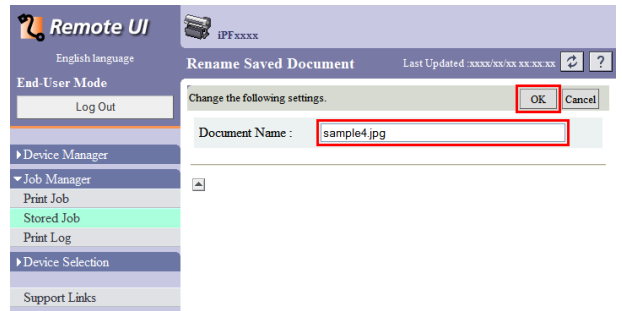

For details, refer to the RemoteUI help file.

Using imagePROGRAF Status Monitor (Windows)

1 On the **Hard Disk** sheet, select a box and click **Open**.

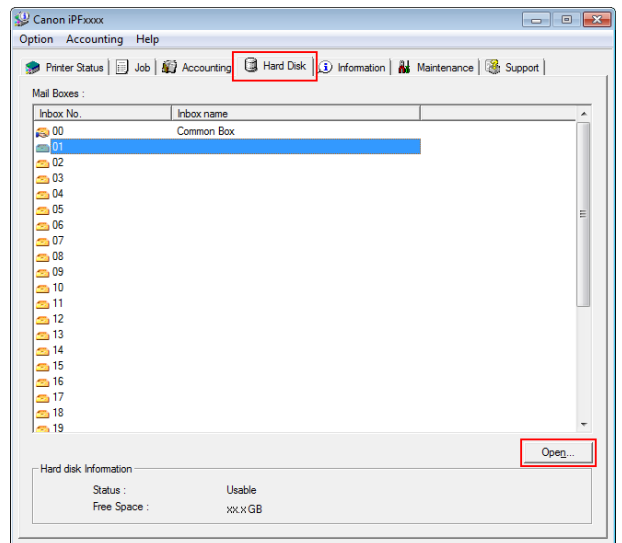



- Enter a password if one has been set.

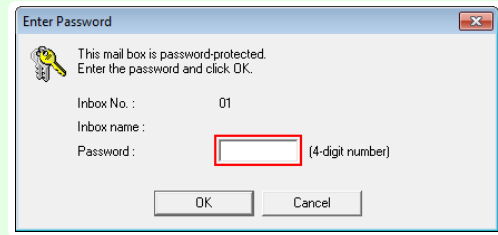

2

In the **Documents** dialog box, select the print job and click **Properties**.

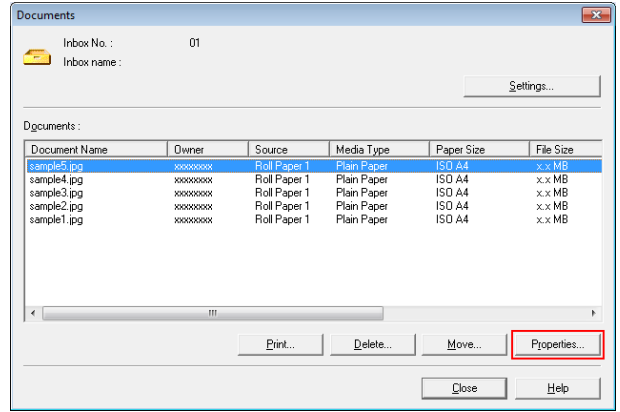

3

In the **Properties** dialog box, enter the new name and click **OK**.

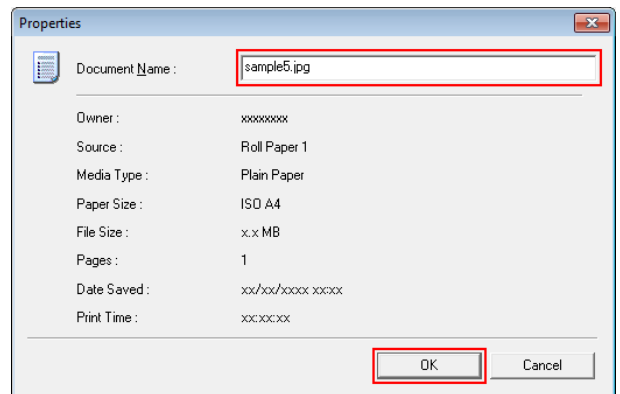

For details, refer to the imagePROGRAF Status Monitor help file.

Using imagePROGRAF Printmonitor (Mac OS)

1

In the **Hard Disk** pane, click ► next to **Inbox No./Name**.

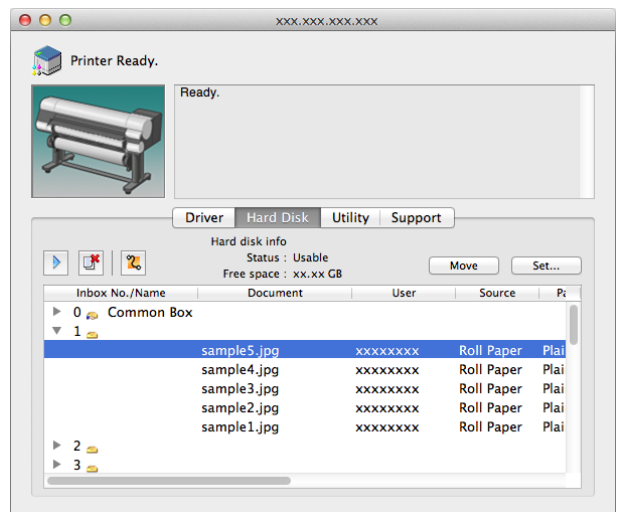



- Enter a password if one has been set. The password is a four-digit number.



2

Select the print job and click **Set**.

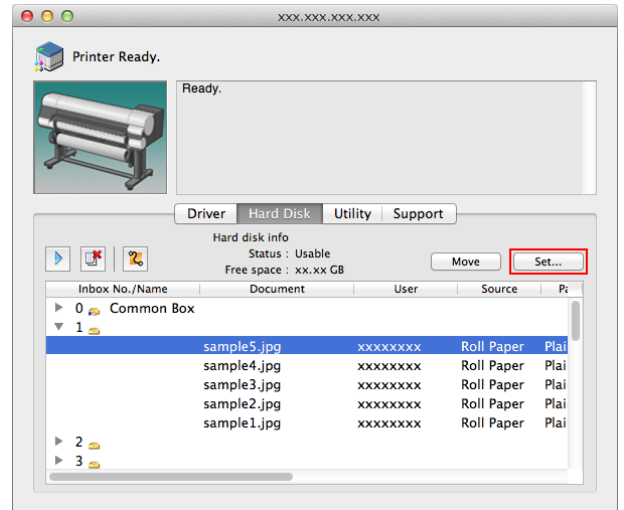

3

In the **Settings** dialog box, enter the new name and click **OK**.

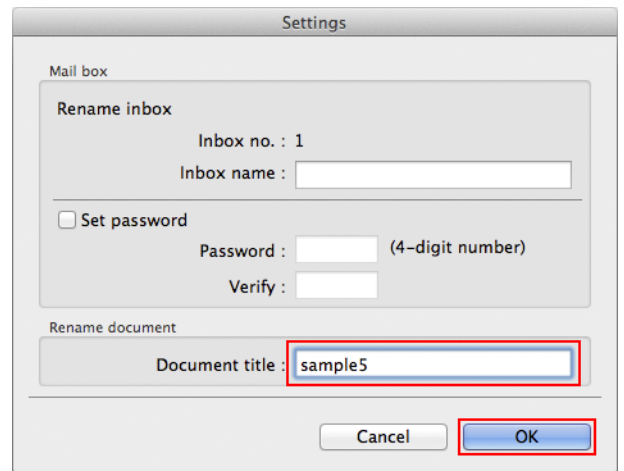

For details, refer to the imagePROGRAF Printmonitor help file.

Basic Printing Workflow	15
Enhanced Printing Options	29
Windows Software	157
Mac OS Software	267
Handling and Use of Paper	331
Control Panel	429
Printer Parts	467
Network Setting	481
Print Job Management	501

Adjustments for Better Print Quality

Adjusting the Printhead	556
Adjusting the feed amount	564

Maintenance and Consumables	573
Troubleshooting	617
Error Message	651
Specifications	673
Appendix	677

Adjusting the Printhead

Adjusting the Printhead	556
Automatic Adjustment to Straighten Lines and Colors	556
Manual Adjustment to Straighten Lines and Colors	558
Adjustment When Installing the Printhead	559
Adjusting Line Misalignment	560
Troubleshooting Paper Abrasion and Blurry Images	562

Adjusting the Printhead

If printed documents are affected by the following problems, try adjusting the printhead.

- Printing is faint or affected by banding in different colors

Execute **Nozzle Check** in the Control Panel menu to check for printhead nozzle clogging.

For instructions, see "Checking for Nozzle Clogging." →P.585

- Printed vertical lines are warped or colors are out of alignment

Execute **Head Posi. Adj.** in the Control Panel menu to adjust the printhead position.

- Normally, execute **Standard**.

(See "Automatic Adjustment to Straighten Lines and Colors.") →P.556

- When printing on special paper, or if printing is not improved after **Standard**, try **Manual**.

(See "Manual Adjustment to Straighten Lines and Colors.") →P.558



Note

- In the next case, execute **Initial adjustmt.**

(See "Adjustment When Installing the Printhead.") →P.559

- If adjusting the printhead position has not been performed such as due to an error during initial setup
- If **Rep.P.head Print** in the Control Panel menu is set to **Off** and adjusting the printhead position has not been performed when replacing the printhead

- Paper rubs against the printhead, or image edges are blurred

Selecting **Head Height** in the Control Panel menu and changing the printhead height may improve the situation.

(See "Troubleshooting Paper Abrasion and Blurry Images.") →P.562

Automatic Adjustment to Straighten Lines and Colors

If vertical lines in printed documents are warped or colors are out of alignment, execute **Head Posi. Adj.**. The printer will print and read a test pattern, and the Printhead position will be adjusted automatically.

There are two modes for automatic Printhead adjustment: **Standard** and **Simple**.

- **Standard**

Execute if vertical lines in printed material are warped or colors are out of alignment.

Furthermore, if **Simple** does not improve printing, try **Standard**.

- **Simple**

Executes simple adjustment in a short time.

Execute this when frequently adjusting the printhead, such as during daily inspection.



Important  • This function is not available with Tracing Paper, Translucent Matte Film, or Clear Film.

- If adjustment is not possible as expected using special media, try another type of paper, or try **Manual** adjustment. (See "Manual Adjustment to Straighten Lines and Colors.") →P.558
- If you are using cut sheets, remove the Stacker from the printer. Also when you execute **Simple**, remove the Stacker from the printer. (See "Installing and Removing the Stacker On the Printer.") →P.376

Note  • Because the results of adjustment vary depending on the type of paper used for adjustment, use the same type of paper as you will use for printing.

- If **Standard** does not improve printing, try adjusting the printhead manually. (See "Manual Adjustment to Straighten Lines and Colors.") →P.558
- If the printhead position was not adjusted during initial setup or when the printhead was replaced, execute **Initial adjustmt.** (See "Adjustment When Installing the Printhead.") →P.559

Items to Prepare

When Using Rolls	An unused roll at least 254.0 mm (10.00 in) wide
When Using Sheets	Standard : Two sheets of unused paper, A4/Letter size (or one sheet when using A3 or larger) Simple : One sheet of unused paper, A4/Letter size

Perform adjustment as follows.

- 1** Load paper.
 - **Attaching the Roll Holder to Rolls** →P.342
 - **Loading Rolls in the Printer** →P.345
 - **Loading Sheets in the Printer** →P.369

Important  • Always make sure the loaded paper matches the type of paper specified on the printer. Adjustment cannot be completed correctly unless the loaded paper matches the settings.

- 2** On the **Tab Selection screen** of the Control Panel, press ◀ or ▶ to select the Settings/Adj. tab ().

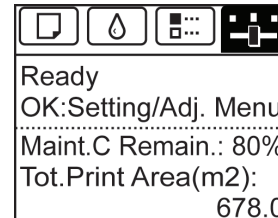

Note  • If the **Tab Selection screen** is not displayed, press the **Menu** button.

- 3** Press the **OK** button. The **Set./Adj. Menu** is displayed.
- 4** Press ▲ or ▼ to select **Adjust Printer**, and then press the **OK** button.
- 5** Press ▲ or ▼ to select **Head Posi. Adj.**, and then press the **OK** button.
- 6** Press ▲ or ▼ to select **Standard** or **Simple**, and then press the **OK** button. A test pattern is printed for adjustment. Adjustment is now finished if you have printed on a roll.
- 7** If you are printing on cut sheets, a confirmation message is displayed on the Display Screen asking you whether to continue printing. Press the **OK** button and follow the instructions on the Display Screen.

Manual Adjustment to Straighten Lines and Colors

If printed vertical lines are warped or colors are out of alignment, execute **Head Posi. Adj.** to adjust the Printhead alignment.

Normally, execute **Standard**.

(See "Automatic Adjustment to Straighten Lines and Colors.") →P.556

However, when printing on special paper, or if printing is not improved after **Standard**, try **Manual**.

Manual adjustment requires you to examine the printed test pattern and enter an adjustment value.



Important

- Before performing the adjustment, remove the Stacker from the printer. Adjustment cannot be performed correctly while the Stacker is attached to the printer.
(See "Installing and Removing the Stacker On the Printer.") →P.376



Note

- We recommend using the type of paper you use most often for adjustment.
- If the printhead position was not adjusted during initial setup or when the printhead was replaced, execute **Initial adjustmt.**
(See "Adjustment When Installing the Printhead.") →P.559

Items to Prepare

When Using Rolls	An unused roll at least 254.0 mm (10.00 in) wide
When Using Sheets	Two sheets of unused paper of at least A4/Letter size (or one sheet when using A2 or larger)

Perform adjustment as follows.

1 Load paper.

- **Attaching the Roll Holder to Rolls** →P.342
- **Loading Rolls in the Printer** →P.345
- **Loading Sheets in the Printer** →P.369



Important

- Always make sure the loaded paper matches the type of paper specified on the printer. Adjustment cannot be completed correctly unless the loaded paper matches the settings.

2 On the **Tab Selection screen** of the Control Panel, press ◀ or ▶ to select the Settings/Adj. tab ().

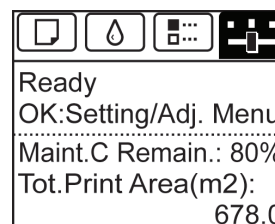

Note

- If the **Tab Selection screen** is not displayed, press the **Menu** button.

3 Press the **OK** button. The **Set./Adj. Menu** is displayed.

4 Press ▲ or ▼ to select **Adjust Printer**, and then press the **OK** button.

5 Press ▲ or ▼ to select **Head Posi. Adj.**, and then press the **OK** button.

6 Press ▲ or ▼ to select **Other**, and then press the **OK** button.

- 7** Press ▲ or ▼ to select **Manual**, and then press the **OK** button.
A test pattern is printed for adjustment.



Note

- **Manual** may be unavailable in some cases, even if it is displayed in the menu. If so, execute **Standard** once. (See "Automatic Adjustment to Straighten Lines and Colors.") →P.556

- 8** Press ▲ or ▼ to select **D**, and then press the **OK** button.

- 9** Press ▲ or ▼ to select **D-1**, and then press the **OK** button.

- 10** Examine adjustment test pattern **D-1** and determine the number with straight lines.

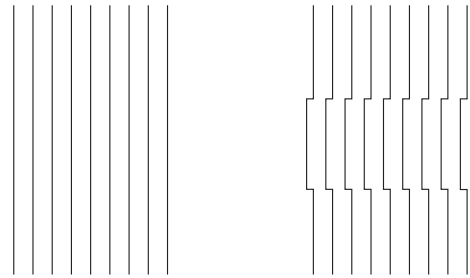

Note

- If two patterns seem equally good and you cannot decide which one is better, choose an intermediate value. For example, choose 11 if you cannot decide whether pattern 10 or 12 is better.

- 11** Press ▲ or ▼ to select the pattern number you have decided, and then press the **OK** button.

- 12** Repeat steps 9–11 to specify the adjustment value for **D-2** to **D-23**.
Note that **D-6**, **D-12**, **D-18**, and **D-24** cannot be configured.

- 13** Press the **Back** button.

- 14** Press ▲ or ▼ to select **Register Setting**, and then press the **OK** button.

- 15** Press ▲ or ▼ to select **Yes**, and then press the **OK** button.
The adjustment value is now registered, and adjustment is complete.

Adjustment When Installing the Printhead

Printhead position adjustment is executed when the printhead is first installed.
This adjustment should be executed in the following situations.

- If adjusting the printhead position has not been performed such as due to an error during initial setup
- If **Rep.P.head Print** in the Control Panel menu is set to **Off** and adjusting the printhead position has not been performed when replacing the printhead



Important

- If you are using cut sheets, remove the Stacker from the printer. (See "Installing and Removing the Stacker On the Printer.") →P.376



Note

- We recommend that the same paper as the paper included with the printer is used for this adjustment.

Items to Prepare

When Using Rolls	An unused roll at least 254.0 mm (10.00 in) wide
When Using Sheets	Three sheets of unused paper of at least A4/Letter size (or one sheet when using A3 or larger)

Perform adjustment as follows.

1 Load paper.

- **Attaching the Roll Holder to Rolls** →P.342
- **Loading Rolls in the Printer** →P.345
- **Loading Sheets in the Printer** →P.369



- Always make sure the loaded paper matches the type of paper specified on the printer. Adjustment cannot be completed correctly unless the loaded paper matches the settings.

2 On the **Tab Selection screen** of the Control Panel, press ◀ or ▶ to select the Settings/Adj. tab ().



- If the **Tab Selection screen** is not displayed, press the **Menu** button.

3 Press the **OK** button. The **Set./Adj. Menu** is displayed.

4 Press ▲ or ▼ to select **Adjust Printer**, and then press the **OK** button.

5 Press ▲ or ▼ to select **Head Posi. Adj.**, and then press the **OK** button.

6 Press ▲ or ▼ to select **Other**, and then press the **OK** button.

7 Press ▲ or ▼ to select **Initial adjustmt**, and then press the **OK** button. A test pattern is printed for adjustment. Adjustment is now finished if you have printed on a roll.

8 If you are printing on sheets, a confirmation message is displayed requesting you to continue printing. Press the **OK** button and follow the instructions.

Adjusting Line Misalignment

If printed lines are misaligned, execute **Head Inc. Adj.** to adjust the angle of inclination of the Printhead. Executing **Head Inc. Adj.** requires you to examine a printed test pattern and enter an adjustment value.

Paper to Prepare

Rolls	An unused roll at least 254.0 mm (10.00 in) wide
Sheets	One sheet of unused paper of at least A4/Letter size

Perform adjustment as follows.

1 Remove the Stacker from the printer. (See "Installing and Removing the Stacker On the Printer.") →P.376

2 Load the paper.

- **Attaching the Roll Holder to Rolls** →P.342
- **Loading Rolls in the Printer** →P.345

• Loading Sheets in the Printer →P.369



- When loading paper, specify the type of paper correctly. Using paper that you have not specified on the printer may cause feeding problems and affect the printing quality.
- We recommend loading a type of paper that you use often.

3

On the **Tab Selection screen** of the Control Panel, press ◀ or ▶ to select the **Settings/Adj. tab** ().

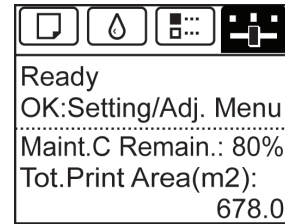

- If the **Tab Selection screen** is not displayed, press the **Menu** button.

4

Press the **OK** button.
The **Set./Adj. Menu** is displayed.

5

Press ▲ or ▼ to select **Adjust Printer**, and then press the **OK** button.

6

Press ▲ or ▼ to select **Head Inc. Adj.**, and then press the **OK** button.
After the Carriage is moved, a message is displayed requesting you to open the Top Cover.

7

Open the Top Cover.

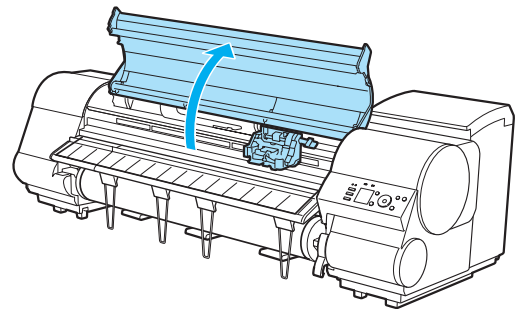

8

Align the **Angle Adjustment Lever** with the red square and close the Top Cover.

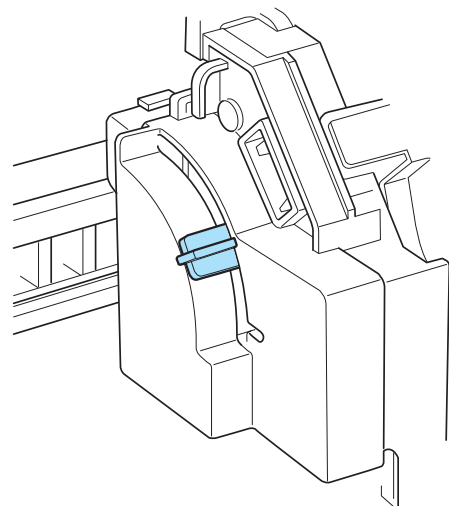

A test pattern is printed for adjustment.



- Do not touch the Linear Scale (a), Carriage Shaft (b), or Ink Tube Stabilizer (c). Touching these parts may damage them.

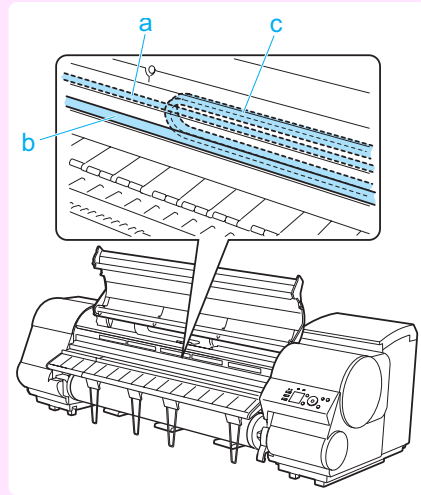

9 Examine the test pattern for adjustment. Determine the straightest set of lines.



10 Open the Top Cover and move the Angle Adjustment Lever to match the number (or the square) of the straightest set of lines.

If no single set of lines is perfectly straight, move the Angle Adjustment Lever to a position between the numbers (or between the number and the square) of the two sets of lines that are least misaligned.

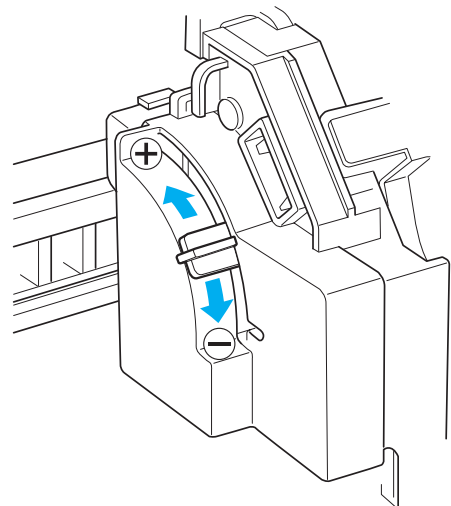

11 Close the Top Cover. The Printhead is now straight, and adjustment is complete.

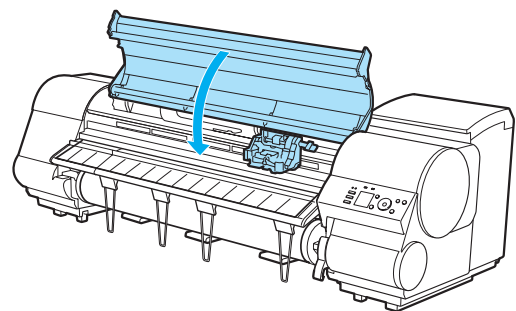

12 Install the Stacker on the printer. (See "Installing and Removing the Stacker On the Printer." →P.376)

Troubleshooting Paper Abrasion and Blurry Images

The Printhead height setting affects printing quality.

Specifying a low Printhead height makes images clearer and enhances printing quality but may cause paper to rub against the Printhead.

On the other hand, specifying a high Printhead height will prevent paper from rubbing against the Printhead but may reduce the printing quality.



Important

- Paper rubbing against or becoming caught on the Printhead may jam or result in printed documents that are soiled.



Note

- Raise or lower the printhead, depending on the nature of the problem.
(See "Paper rubs against the Printhead.") → P.634
(See "The edges of the paper are dirty.") → P.634
(See "Image edges are blurred or white banding occurs.") → P.637

- 1 On the **Tab Selection screen** of the Control Panel, press ◀ or ▶ to select the Paper tab ().



Note

- If the **Tab Selection screen** is not displayed, press the **Menu** button.

- 2 Press the **OK** button.
The **Paper Menu** is displayed.

- 3 Press ▲ or ▼ to select **Paper Details**, and then press the **OK** button.

- 4 Press ▲ or ▼ to select the type of paper, and then press the **OK** button.



Note

- When **Head Height** is set to **Automatic**, the setting value selected for the previous print job is displayed (to the right of **Automatic**) once you select the type of paper currently supplied.
Note that this is not displayed if any of the following is executed.
 - Turning off the power
 - Replacing paper
 - Entering sleep mode

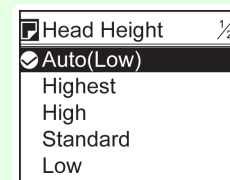

- 5 Press ▲ or ▼ to select **Head Height**, and then press the **OK** button.

- 6 Press ▲ or ▼ to select the desired setting value, and then press the **OK** button.



Note

- Using **Automatic** will ensure that the printer adjusts the Printhead height to the optimal level before printing, accounting for the ambient temperature and humidity. When a setting other than **Automatic** is used, that value will always be applied.
 - Depending on the type of paper, some setting values may not be available.

Adjusting the feed amount

Adjusting the Feed Amount	564
Selecting a Feed Amount Adjustment Method	564
Automatic Banding Adjustment	565
Manual Banding Adjustment	566
Fine-Tuning the Paper Feed Amount	568
Adjusting Line Length	568
Adjusting the Vacuum Strength	570

Adjusting the Feed Amount

If printed documents are affected by the following problems, try adjusting the feed amount.

- Banding in different colors
- Line length is not accurate in the direction paper is fed

To adjust the feed amount, do the following, in this order.

- 1 Depending on the issue, adjust **Adj. Priority** to suit the particular type of paper.
(See "Selecting a Feed Amount Adjustment Method.") →P.564
- 2 Execute **Adj. Quality** or **Adjust Length**, depending on the selection in **Adj. Priority**.
(See "Automatic Banding Adjustment.") →P.565
(See "Manual Banding Adjustment.") →P.566
(See "Adjusting Line Length.") →P.568
- 3 After executing **Adj. Quality**, execute **Adj. Fine Feed** for further adjustment as needed.
(See "Fine-Tuning the Paper Feed Amount.") →P.568

Selecting a Feed Amount Adjustment Method

Methods of adjusting the amount paper is fed are set in **Adj. Priority**.

Adjust **Adj. Priority** to suit your particular printing application.

- **Print Quality**: Adjusts the feed amount to reduce banding across the sheet in printed documents.
Adj. Quality settings are applied. When **Adj. Fine Feed** is executed, the **Adj. Fine Feed** settings are applied in addition to the **Adj. Quality** settings.
- **Print Length**: Adjusts the feed amount for better accuracy of lines in printed documents.
The settings of **A:High** or **B:Standard/Draft** in **Adjust Length** are applied.
- **Automatic**: **Print Quality** or **Print Length** is selected, depending on **Print Priority** as selected in the printer driver at the time of printing.
Image or **Office Document**: **Print Quality** is selected.
Line Drawing/Text: **Print Length** is selected.



Note

- Either **A:High** or **B:Standard/Draft** in the **Adjust Length** menu is applied, depending on printer driver settings at the time of printing.
- If you have selected **Easy Settings** in the printer driver, follow these steps to confirm the **Print Priority** setting.
 - Windows: Click **View Settings** on the **Main** tab to display the **View Settings** dialog box.
 - Mac OS: Click **View set.** on the **Main** pane to display the **View set.** dialog box.

Follow these steps to configure the settings.

- 1 Load the paper.
 - **Attaching the Roll Holder to Rolls** →P.342
 - **Loading Rolls in the Printer** →P.345
 - **Loading Sheets in the Printer** →P.369

2 On the **Tab Selection screen** of the Control Panel, press ◀ or ▶ to select the **Settings/Adj. tab** ().

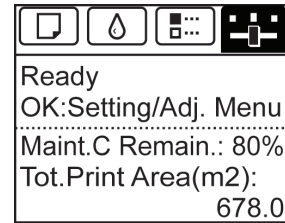

• If the **Tab Selection screen** is not displayed, press the **Menu** button.

3 Press the **OK** button.
The **Set./Adj. Menu** is displayed.

4 Press ▲ or ▼ to select **Adjust Printer**, and then press the **OK** button.

5 Press ▲ or ▼ to select **Feed Priority**, and then press the **OK** button.

6 Press ▲ or ▼ to select **Adj. Priority**, and then press the **OK** button.

7 Press ▲ or ▼ to select **Automatic**, **Print Quality**, or **Print Length**, and then press the **OK** button.

Automatic Banding Adjustment

If printed images are affected by banding in different colors across the sheet, execute **Adj. Quality** for automatic adjustment of the paper feed amount.

There are two modes of automatic adjustment to correct banding: **Auto(GenuinePpr)** and **Auto(OtherPaper)**. In either mode, the printer prints and reads a test pattern for automatic adjustment of the feed amount.

• **Auto(GenuinePpr)**

Use this mode with paper identified in the **Paper Reference Guide**.
(See "Types of Paper.") → P.332

• **Auto(OtherPaper)**

Use this mode with paper not in the **Paper Reference Guide**, or if **Auto(GenuinePpr)** does not eliminate banding.
(See "Types of Paper.") → P.332



Important

- Adjustment is not possible with **Auto(GenuinePpr)** and **Auto(OtherPaper)** when using highly transparent media. In this case, use **Manual** adjustment.
(See "Manual Banding Adjustment.") → P.566
- If you are using cut sheets, remove the Stacker from the printer.
(See "Installing and Removing the Stacker On the Printer.") → P.376



Note

- We recommend executing the adjustment if you have changed the paper type or paper size.
- Always check the **Adj. Priority** values before using **Auto(GenuinePpr)** or **Auto(OtherPaper)**.
(See "Selecting a Feed Amount Adjustment Method.") → P.564
- If additional fine-tuning is necessary after **Auto(GenuinePpr)** and **Auto(OtherPaper)**, execute **Adj. Fine Feed**.
(See "Fine-Tuning the Paper Feed Amount.") → P.568
- Use **Adjust Length** to ensure that lines in CAD drawings are printed at exactly the right length.
(See "Adjusting Line Length.") → P.568
- This may take some time, depending on the type of paper.

Items to Prepare

When Using Rolls	An unused roll at least 254.0 mm (10.00 in) wide
When Using Sheets	Auto(GenuinePpr) : One sheet of unused paper, A4/Letter size Auto(OtherPaper) : Two sheets of unused paper of at least A4/Letter size (or one sheet when using A2 or larger)

Perform adjustment as follows.

1 Load the paper.

- **Attaching the Roll Holder to Rolls** →P.342
- **Loading Rolls in the Printer** →P.345
- **Loading Sheets in the Printer** →P.369



- Always make sure the loaded paper matches the type of paper specified in the settings. Adjustment cannot be completed correctly unless the loaded paper matches the settings.

2 On the **Tab Selection screen** of the Control Panel, press ◀ or ▶ to select the **Settings/Adj. tab** ().

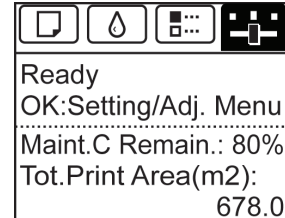

- If the **Tab Selection screen** is not displayed, press the **Menu** button.

3 Press the **OK** button.
The **Set./Adj. Menu** is displayed.

4 Press ▲ or ▼ to select **Adjust Printer**, and then press the **OK** button.

5 Press ▲ or ▼ to select **Feed Priority**, and then press the **OK** button.

6 Press ▲ or ▼ to select **Adj. Quality**, and then press the **OK** button.

7 Press ▲ or ▼ to select **Auto(GenuinePpr)** or **Auto(OtherPaper)**, and then press the **OK** button.
A test pattern is printed for adjustment.
Adjustment is now finished if you have printed on a roll or a sheet of A2 size or larger.

8 If you are printing on sheets smaller than A2 size for **Auto(OtherPaper)**, a confirmation message is shown on the Display Screen requesting you to continue printing.
Press the **OK** button and follow the instructions on the Display Screen.

Manual Banding Adjustment

If printed images are affected by banding in different colors, execute **Adj. Quality** for adjustment of the paper feed amount.

Use **Manual** adjustment with highly transparent media or other paper for which **Auto(GenuinePpr)** or **Auto(OtherPaper)** cannot be used.

(See "Automatic Banding Adjustment.") →P.565

Manual adjustment requires you to enter an adjustment value after a test pattern is printed.



- If you are using cut sheets, remove the Stacker from the printer.
(See "Installing and Removing the Stacker On the Printer.") →P.376



- We recommend executing the adjustment if you have changed the paper type or paper size.
- Always check the **Adj. Priority** values before using **Manual** adjustment.
(See "Selecting a Feed Amount Adjustment Method.") →P.564
- If additional fine-tuning is necessary after **Manual** adjustment, use **Adj. Fine Feed**
(See "Fine-Tuning the Paper Feed Amount.") →P.568
- Use **Adjust Length** to ensure that lines in CAD drawings are printed at exactly the right length.
(See "Adjusting Line Length.") →P.568

Paper to Prepare

When Using Rolls	An unused roll at least 254.0 mm (10.00 in) wide
When Using Sheets	Two sheets of unused paper of at least A4/Letter size

Perform adjustment as follows.

1 Load the paper.

- **Attaching the Roll Holder to Rolls** → P.342
- **Loading Rolls in the Printer** → P.345
- **Loading Sheets in the Printer** → P.369

 **Important** • Always make sure the loaded paper matches the type of paper specified. Adjustment cannot be completed correctly unless the loaded paper matches the settings.

2 On the **Tab Selection screen** of the Control Panel, press ◀ or ▶ to select the Settings/Adj. tab ().

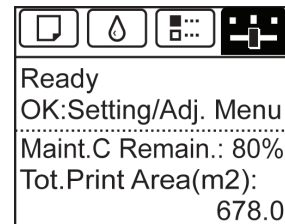

 **Note** • If the **Tab Selection screen** is not displayed, press the **Menu** button.

3 Press the **OK** button. The **Set./Adj. Menu** is displayed.

4 Press ▲ or ▼ to select **Adjust Printer**, and then press the **OK** button.

5 Press ▲ or ▼ to select **Feed Priority**, and then press the **OK** button.

6 Press ▲ or ▼ to select **Adj. Quality**, and then press the **OK** button.

7 Press ▲ or ▼ to select **Manual**, and then press the **OK** button. Test pattern A is printed for manual adjustment.

 **Note** • When printing on sheets, follow the instructions on the Display Screen and remove the sheet.

8 Examine test pattern A for adjustment. Determine the pattern in which banding is least noticeable.

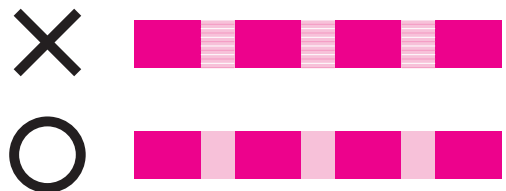

 **Note** • If banding seems least noticeable in two patterns but you cannot decide which one is better, choose an intermediate value. For example, choose 11 if you cannot decide whether pattern 10 or 12 is better.

9 Press ▲ or ▼ to select the pattern number you have decided, and then press the **OK** button. Test pattern B is printed for adjustment.



- If you printed test pattern A on a sheet, follow the instructions on the Display Screen and use another sheet of the same type of paper. Additionally, after test pattern B is printed, follow the instructions on the Display Screen and remove the sheet.

10 Examine test pattern B for adjustment. Determine the pattern in which banding is least noticeable.

11 Press ▲ or ▼ to select the pattern number you have decided, and then press the **OK** button. The adjustment value is now registered, and adjustment is complete.

Fine-Tuning the Paper Feed Amount

If the contrast is uneven or banding in different colors appears at 50 mm (2.0 in) intervals in printed documents, try executing **Adj. Fine Feed** during printing to fine-tune the feed amount.



- The **Adj. Fine Feed** menu is only displayed during printing. Additionally, it is displayed when you have selected **Automatic** or **Print Quality** in **Adj. Priority** in **Feed Priority**. (See "Menu Settings.") →P.449
- Always execute **Adj. Quality** before **Adj. Fine Feed**. Once you execute **Adj. Quality**, the **Adj. Fine Feed** value will revert to 0. (See "Automatic Banding Adjustment.") →P.565 (See "Manual Banding Adjustment.") →P.566

Perform adjustment as follows.

1 On the **Tab Selection screen** of the Control Panel, press ◀ or ▶ to select the Settings/Adj. tab ().

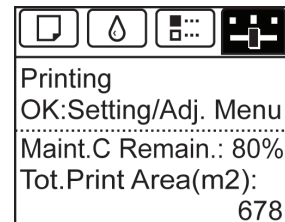

- If the **Tab Selection screen** is not displayed, press the **Menu** button.

2 Press the **OK** button. The **Set./Adj. Menu** is displayed.

3 Press ▲ or ▼ to select **Adj. Fine Feed**, and then press the **OK** button.

4 Press ▲ or ▼ to select a setting value in the range -5 to 5, and then press the **OK** button. At this time, if banding in dark colors appears, select a setting value in the range 1 to 5, and if banding in light colors appears, select a setting value in the range -1 to -5.

Adjusting Line Length

To ensure that lines in CAD drawings are printed at exactly the right length, use **Adjust Length** to adjust the amount that paper is advanced.

There are two options in **Adjust Length** : **AdjustmentPrint** and **Change Settings**.

- **AdjustmentPrint**
After a test pattern is printed, you will measure the discrepancy based on the results of printing.
- **Change Settings**
No test pattern is printed. Instead, you will measure a document already printed to determine the discrepancy.

Additionally, two modes are available in both **AdjustmentPrint** and **Change Settings** : **A:High** or **B:Standard/Draft**. Choose the mode that suits your particular printing application.

A:High

This setting is applied when **Highest** or **High** is selected in **Print Quality** in the printer driver.

B:Standard/Draft

This setting is applied when **Standard** or **Fast** is selected in **Print Quality** in the printer driver.



- Perform this adjustment with the Stacker installed on the printer. However, if you are using cut sheets, remove the Stacker from the printer. (See "Installing and Removing the Stacker On the Printer.") →P.376



- We recommend executing the adjustment if you have changed the paper type or paper size.
- Always check the **Adj. Priority** values before using **Adjust Length**. (See "Selecting a Feed Amount Adjustment Method.") →P.564

Paper to Prepare

When Using Rolls	<ul style="list-style-type: none"> • An unused roll at least 254.0 mm (10.00 in) wide • High-precision ruler
When Using Sheets	<ul style="list-style-type: none"> • One sheet of unused paper of at least A4/Letter size • High-precision ruler

Perform adjustment as follows.

1 Load the paper.

- **Attaching the Roll Holder to Rolls** →P.342
- **Loading Rolls in the Printer** →P.345
- **Loading Sheets in the Printer** →P.369



- Always make sure the loaded paper matches the type of paper specified. Adjustment cannot be completed correctly unless the loaded paper matches the settings.

2 On the **Tab Selection screen** of the Control Panel, press ◀ or ▶ to select the **Settings/Adj.** tab ().

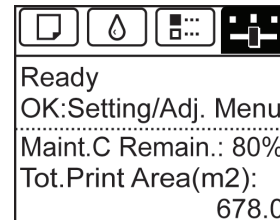

- If the **Tab Selection screen** is not displayed, press the **Menu** button.

3 Press the **OK** button. The **Set./Adj. Menu** is displayed.

4 Press ▲ or ▼ to select **Adjust Printer**, and then press the **OK** button.

5 Press ▲ or ▼ to select **Feed Priority**, and then press the **OK** button.

6 Press ▲ or ▼ to select **Adjust Length**, and then press the **OK** button.

7 Press ▲ or ▼ to select **AdjustmentPrint** or **Change Settings**, and then press the **OK** button.

When you select **AdjustmentPrint**, a test pattern is printed for you to measure the scale and calculate the discrepancy. The scale bar prints **Millimeter** in 50 mm increments and **Inch** in 1-inch increments.

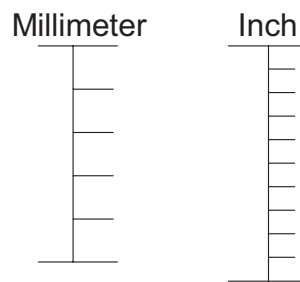



-  • A test pattern is printed in black when you choose **A:High** or in magenta if you choose **B:Standard/Draft**.
- Note** • To cancel printing the test pattern for adjustment, hold down the **Stop** button. When "**Stop printing?**" is displayed, press ▲ or ▼ to select **Yes**, and then press the **OK** button.

8 Press ▲ or ▼ to enter the amount of discrepancy, and then press the **OK** button. If the scale is shorter than the actual size, use a positive setting value. If it is longer, use a negative value. The feed amount can be adjusted in 0.02% increments.

Adjusting the Vacuum Strength

When printing on heavyweight paper or paper that curls or wrinkles easily, if the Printhead rubs against paper, adjusting the level of suction against paper on the Platen may improve results.

-  **Important** • Paper rubbing against or becoming caught on the Printhead may jam or result in printed documents that are soiled.

1 On the **Tab Selection screen** of the Control Panel, press ◀ or ▶ to select the Paper tab ().



-  **Note** • If the **Tab Selection screen** is not displayed, press the **Menu** button.

2 Press the **OK** button. The **Paper Menu** is displayed.

3 Press ▲ or ▼ to select **Paper Details**, and then press the **OK** button.

4 Press ▲ or ▼ to select the type of paper, and then press the **OK** button.

-  **Note** • When **VacuumStrngth** is set to **Automatic**, the setting value selected for the previous print job is displayed (to the right of **Automatic**) once you select the type of paper currently supplied. Note that this is not displayed if any of the following is executed.
 - Turning off the power
 - Replacing paper
 - Entering sleep mode

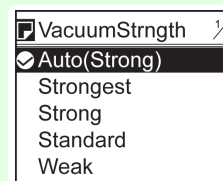

5 Press ▲ or ▼ to select **VacuumStrngth**, and then press the **OK** button.

6 Press ▲ or ▼ to select the desired setting value, and then press the **OK** button.

Memo

Basic Printing Workflow	15
Enhanced Printing Options	29
Windows Software	157
Mac OS Software	267
Handling and Use of Paper	331
Control Panel	429
Printer Parts	467
Network Setting	481
Print Job Management	501
Adjustments for Better Print Quality	555

Maintenance and Consumables

Ink Tanks	574
Printheads	585
Maintenance Cartridge	593
Cleaning the Printer	599
Other Maintenance	606

Troubleshooting	617
Error Message	651
Specifications	673
Appendix	677

Ink Tanks

Ink Tanks 574
 Replacing Ink Tanks 574
 Checking Ink Tank Levels 583
 When to Replace Ink Tanks 583

Ink Tanks

When purchasing, check the Model number.

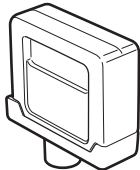
Shape	Colors	Model number	Ink Type	Capacity
	Matte black	PFI-307 MBK	Pigment ink	330 ml (11.2 fl oz)
	Black	PFI-307 BK	Dye ink	
	Cyan	PFI-307 C		
	Magenta	PFI-307 M		
	Yellow	PFI-307 Y		

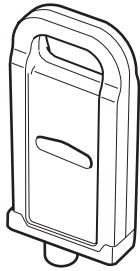
Shape	Colors	Model number	Ink Type	Capacity
	Matte black	PFI-707 MBK	Pigment ink	700 ml (23.7 fl oz)
	Black	PFI-707 BK	Dye ink	
	Cyan	PFI-707 C		
	Magenta	PFI-707 M		
	Yellow	PFI-707 Y		



• For instructions on Ink Tank replacement, see "Replacing Ink Tanks." →P.574

Note

Replacing Ink Tanks

Compatible ink tanks

For information on the compatible ink tanks for this printer, see "Ink Tanks." →P.574

Replacement ink tanks in 330 ml (11.2 fl oz) and 700 ml (23.7 fl oz) capacities are supported.



• Depending on the color, you can also use an ink tank with a different capacity.

Note

Precautions when handling ink tanks

Take the following precautions when handling ink tanks.



Caution

- For safety, keep ink tanks out of the reach of children.
- If ink is accidentally ingested, contact a physician immediately.



- There may be ink around the ink supply section of ink tanks you removed. Handle ink tanks carefully during replacement. The ink may stain clothing.
- Do not install used ink tanks in another model of printer. This will prevent correct ink level detection, which may damage the printer or cause other problems.
- We recommend using up an Ink Tank in the course of printing within six months after breaking the seal. Printing quality may be affected if you use older ink tanks.
- Do not leave the printer without ink tanks installed for extended periods (a month or more). Residual ink may become clogged inside the printer and affect printing quality.

How to replace an Ink Tank

1. Confirm the message →P.575
2. Access the menu for Ink Tank replacement →P.576 (Otherwise, open the Ink Tank Cover.)
3. Remove the Ink Tank.
 - Remove the Ink Tank (330 ml) →P.576
 - Remove the Ink Tank (700 ml) →P.577
4. Load the new Ink Tank.
 - Load the Ink Tank (330 ml) →P.578
 - Load the Ink Tank (700 ml) →P.580

Confirm the message

When the ink level becomes low, a message is displayed on the Display Screen. According to the message, replace the ink tank or prepare a new ink tank. (See "When to Replace Ink Tanks.") →P.583

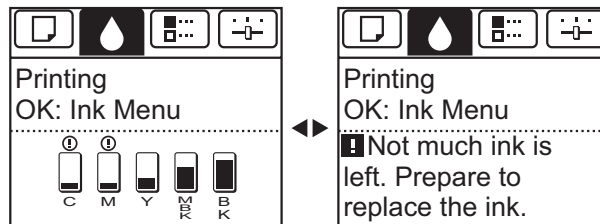

If a message requests you to replace an Ink Tank, press the **OK** button. In this case, you can skip the step **Access the menu for ink tank replacement**. Follow the instructions in **Remove the ink tanks**.

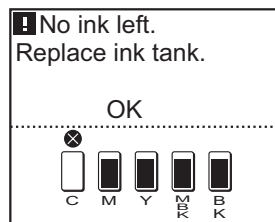

- Do not remove an Ink Tank during initialization immediately after turning on the printer, or during printhead cleaning. Ink may leak out.



- Ink Tank replacement is possible even during printing, when print jobs are being canceled, or when paper is being advanced.

Access the menu for Ink Tank replacement

- 1 On the **Tab Selection screen** of the Control Panel, press ◀ or ▶ to select the Ink tab ().

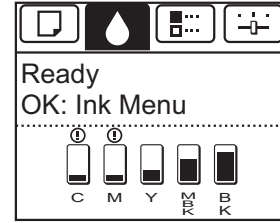

 **Note** • If the **Tab Selection screen** is not displayed, press the **Menu** button.

- 2 Press the **OK** button.
The **Ink Menu** is displayed.
- 3 Press ▲ or ▼ to select **Rep. Ink Tank**, and then press the **OK** button.
Instructions are displayed on the Display Screen.

Remove the Ink Tank (330 ml)

- 1 Open the Ink Tank Cover of the tank for replacement and check the Ink Lamp.
The Ink Lamp flashes quickly if there is no ink left.

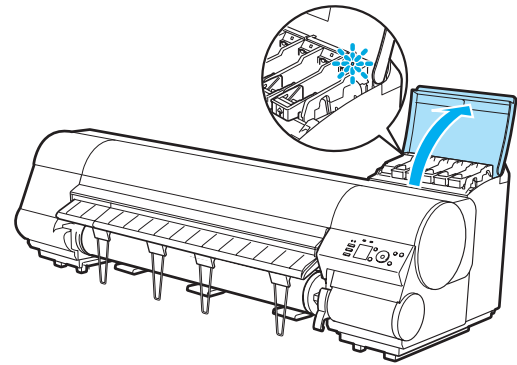

 **Important** • Avoid hitting the printer when replacing an Ink Tank. Handle the printer gently when replacing tanks. Jolting the printer during printing may deteriorate print quality.

- 2 Lift the stopper (a) of the Ink Tank Lock Lever for the color to replace. Lift the Ink Tank Lock Lever until it stops, and then push it down to the front.

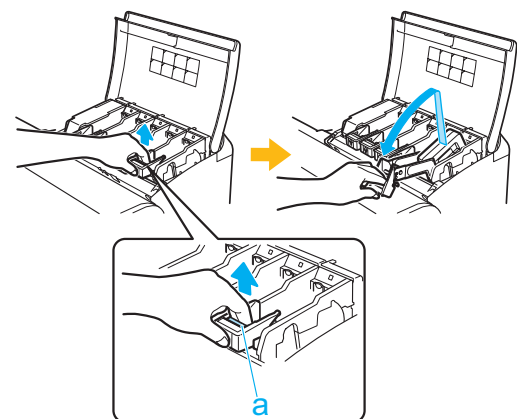

 **Note** • Push the Ink Tank Lock Lever down until it locks.
• Make sure the Ink Tank Lock Lever does not return to the original position.

3 Hold the Ink Tank by the grips (a) and remove it. Press the **OK** button.

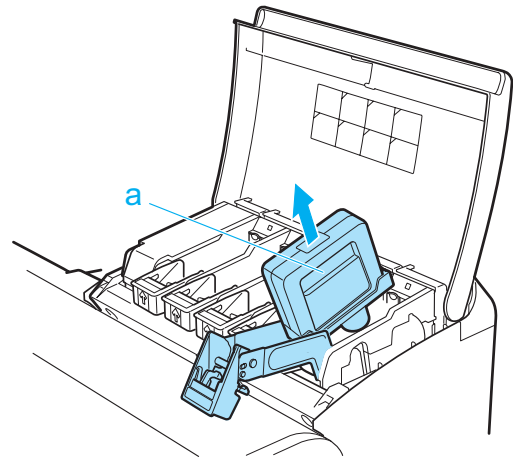

• If there is still ink in the Ink Tank you removed, store it with the ink holes (a) facing up. Otherwise, ink may leak and cause stains. Put the removed Ink Tank in a plastic bag and seal it.

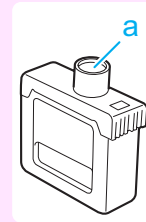

• Dispose of used ink tanks according to local regulations.

Remove the Ink Tank (700 ml)

1 Open the Ink Tank Cover of the tank for replacement and check the Ink Lamp. The Ink Lamp flashes quickly if there is no ink left.

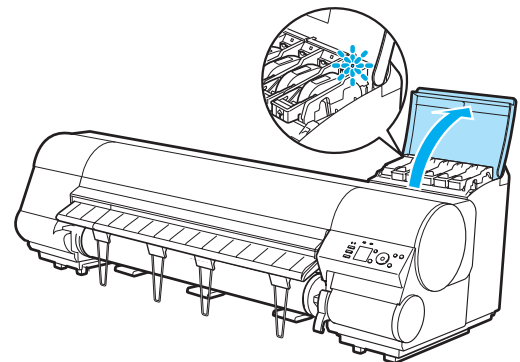

• Avoid hitting the printer when replacing an Ink Tank. Handle the printer gently when replacing tanks. Jolting the printer during printing may deteriorate print quality.

2 Lift the stopper (a) of the Ink Tank Lock Lever for the color to replace. Lift the Ink Tank Lock Lever until it stops, and then push it down to the front.

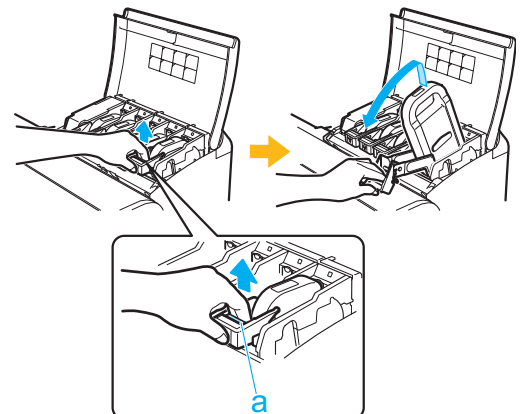



- Push the Ink Tank Lock Lever down until it locks.
- Make sure the Ink Tank Lock Lever does not return to the original position.

3

Hold the Ink Tank by the handle (a) and remove it. Press the **OK** button.

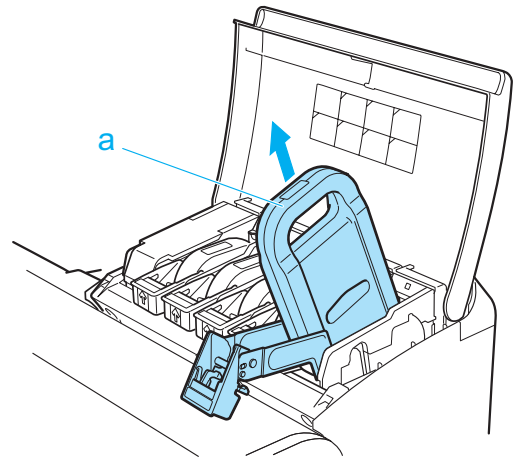

Important

- If there is still ink in the Ink Tank you removed, store it in the box with the ink holes (a) facing up. Otherwise, ink may leak and cause stains.

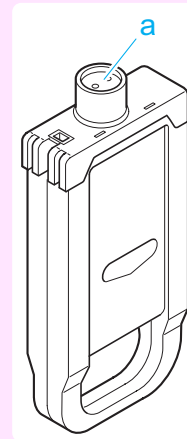

Note

- Dispose of used ink tanks according to local regulations.

Load the Ink Tank (330 ml)

1

Before opening the pouch, tilt the Ink Tank to the left and right gently seven or eight times.

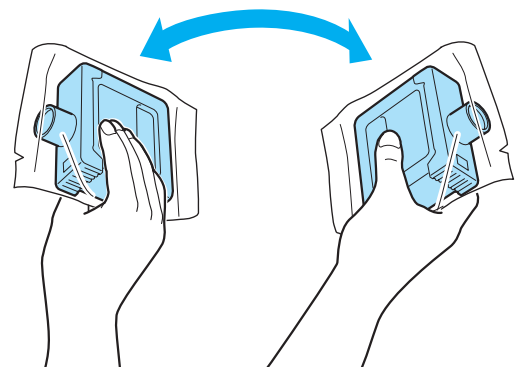

Important

- Do not remove and agitate ink tanks that have already been installed in the printer. Ink may leak out.
- If you do not agitate the Ink Tank, the ink may settle, which may affect printing quality.



Note

- If the Ink Tank is cold, allow it to adjust to room temperature before attaching it to the printer.

2 Open the pouch and remove the Ink Tank.

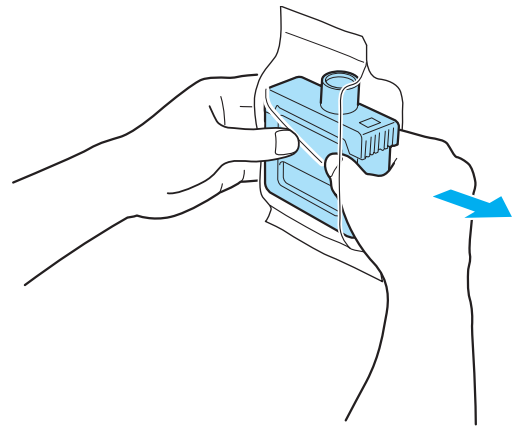

Important • Never touch the ink holes or electrical contacts. This may cause stains, damage the Ink Tank, and affect printing quality.

3 Press the **OK** button and insert the Ink Tank into the holder facing as shown, with the ink holes down.

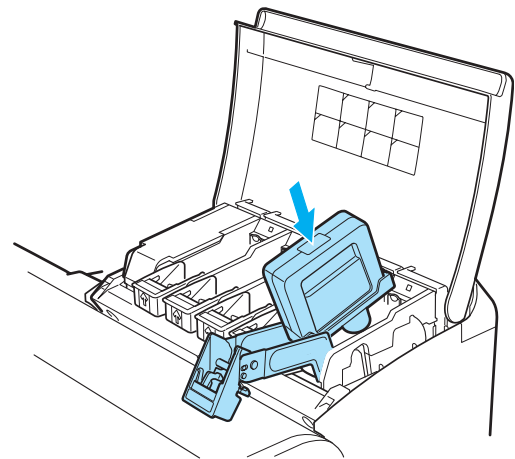

Important • Ink tanks cannot be loaded in the holder if the color or orientation is incorrect. If the Ink Tank does not fit in the holder, do not force it into the holder. Make sure the color of the Ink Tank Lock Lever matches the color of the Ink Tank, and check the orientation of the Ink Tank before reloading it.

4 Lift the Ink Tank Lock Lever until it stops, and then push it down until it clicks into place.

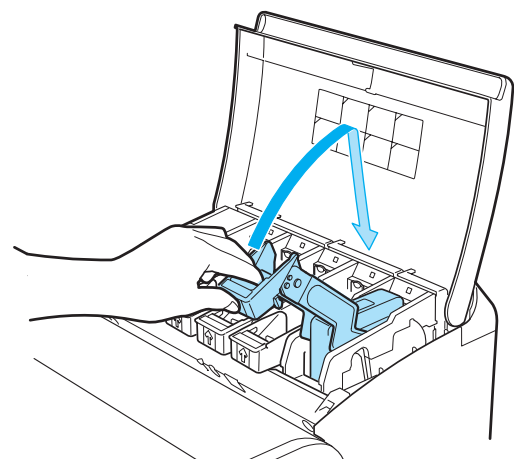

5 Make sure the Ink Lamp is lit in red.

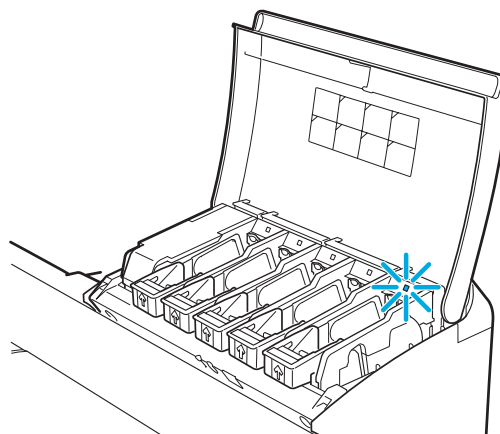

• If the Ink Lamp is not lit in red, reload the tank.

Note

6 Close the Ink Tank Cover.

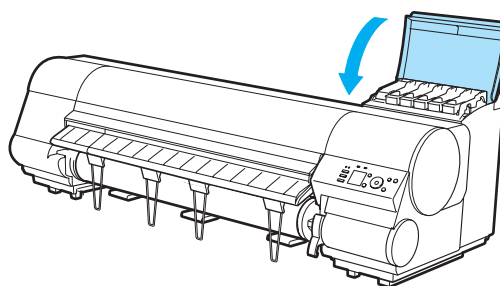

Important

- After Ink Tank replacement, always close the Ink Tank Cover. If the Ink Tank Cover cannot close, some Ink Tank Lock Lever may not be closed completely. Make sure all ink tank lock levers are fully closed.
- To close the Ink Tank Cover when no Ink Tank is installed (as when moving the printer), push the release lever (a) as shown while returning the Ink Tank Lock Lever to the original position.

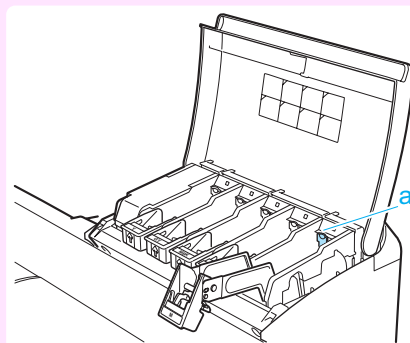

Load the Ink Tank (700 ml)

1 Before opening the pouch, hold the new Ink Tank with both hands and tilt it to the left and right as shown, shaking gently it seven or eight times.

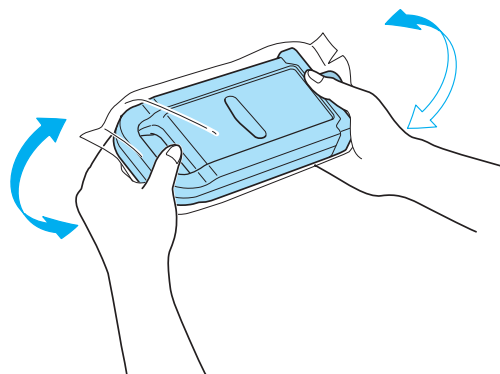



- 700 ml ink tanks are heavy, so use your whole arm to agitate it instead of just your wrist. If you agitate it using just your wrist, you may injure your wrist.



- Do not remove and agitate ink tanks that have already been installed in the printer. Ink may leak out.
- If you do not agitate the Ink Tank, the ink may settle, which may affect printing quality.



- If the Ink Tank is cold, allow it to adjust to room temperature before attaching it to the printer.

2 Open the pouch and remove the Ink Tank.

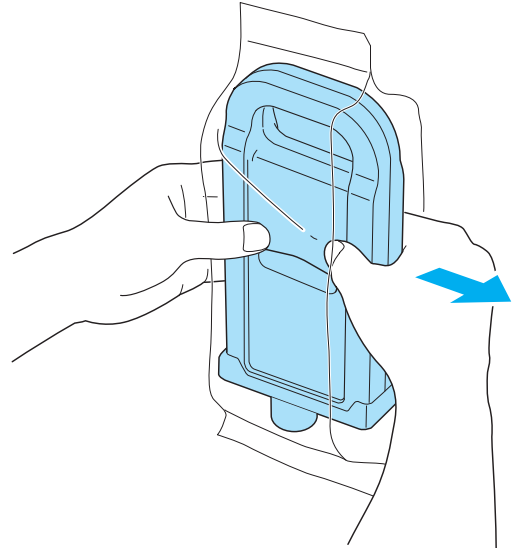

- Never touch the ink holes or electrical contacts. This may cause stains, damage the Ink Tank, and affect printing quality.

3 Press the **OK** button and insert the Ink Tank into the holder facing as shown, with the ink holes down.

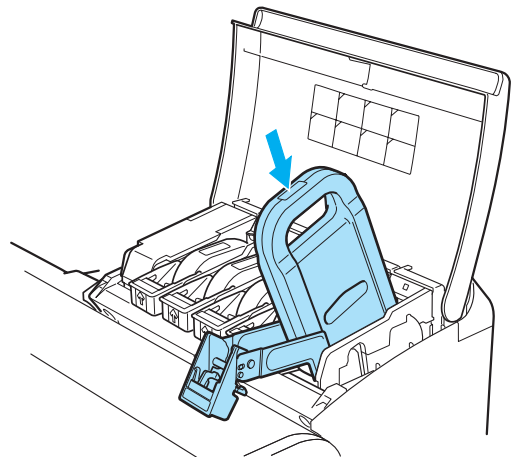

- Ink tanks cannot be loaded in the holder if the color or orientation is incorrect. If the Ink Tank does not fit in the holder, do not force it into the holder. Make sure the color of the Ink Tank Lock Lever matches the color of the Ink Tank, and check the orientation of the Ink Tank before reloading it.

- 4 Lift the Ink Tank Lock Lever until it stops, and then push it down until it clicks into place.

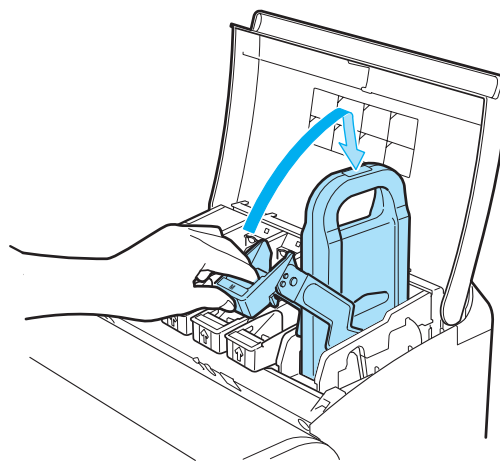

- 5 Make sure the Ink Lamp is lit in red.

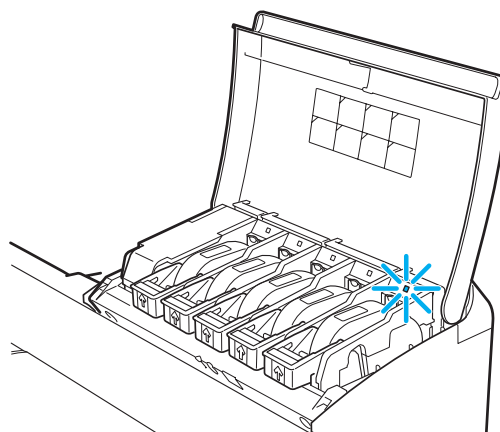

Note

- If the Ink Lamp is not lit in red, reload the tank.

- 6 Close the Ink Tank Cover.

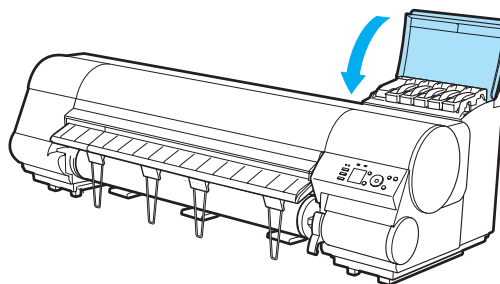

Important

- After Ink Tank replacement, always close the Ink Tank Cover. If the Ink Tank Cover cannot close, some Ink Tank Lock Lever may not be closed completely. Make sure all ink tank lock levers are fully closed.
- To close the Ink Tank Cover when no Ink Tank is installed (as when moving the printer), push the release lever (a) as shown while returning the Ink Tank Lock Lever to the original position.

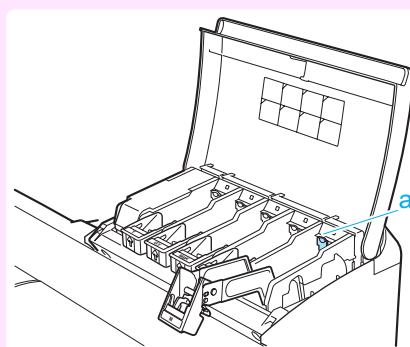

Checking Ink Tank Levels

On the Display Screen, you can check how much ink is left in the ink tanks.

To check remaining Ink Tank levels, access the **Tab Selection screen** on the Control Panel and press ◀ or ▶ to select the Ink tab (☾).

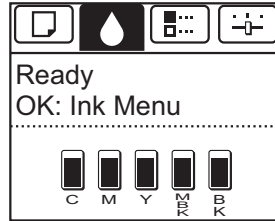

Note

- If the **Tab Selection screen** is not displayed, press the **Menu** button.
- If an error has occurred and the **Tab Selection screen** cannot be displayed, display **Ink Info** as follows.
 1. Press the **OK** button to display **Printer Info**.
 2. Press the ▲ or ▼ button to select **Ink Info**.
 3. Press the **OK** button.

The remaining ink levels shown on the Display Screen correspond to the inks identified by the Color Label on the bottom of the Display Screen.

These symbols may be displayed above the ink level: ! if ink is low, × if no ink is left, and ? if you have deactivated ink level detection.

The remaining ink level is indicated as shown below.

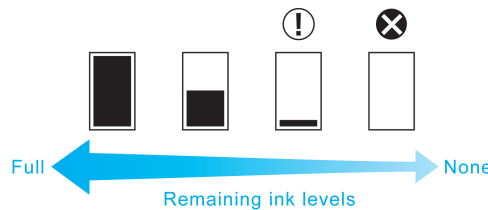

If the Display Screen indicates to replace the Ink Tank, replace the Ink Tank. If a message is displayed indicating to check the remaining ink levels, or after tasks that consume a lot of ink such as large-format printing or head cleaning, check the remaining levels and replace Ink Tank as needed. (See "Replacing Ink Tanks.") →P.574

When to Replace Ink Tanks

Replace or prepare to replace ink tanks in the following situations.

If a message for checking the ink is shown on the Display Screen

When there is little ink left, the **Message Lamp** is lit and "**Not much ink is left.**" is shown on the Display Screen. You can continue to print, but prepare to replace the Ink Tank. (See "Checking Ink Tank Levels.") →P.583

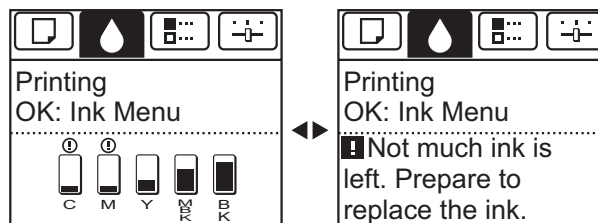

Before print jobs and maintenance that consume a lot of ink

If little ink is left, there may not be enough for large-format printing, head cleaning, and maintenance, which require a lot of ink. In this case, replace or prepare to replace the Ink Tank before maintenance.

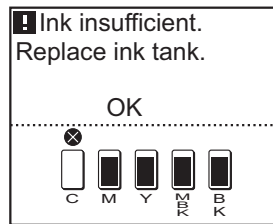

If a message for ink replacement is shown on the Display Screen

When ink runs out, the **Message Lamp** flashes, a message regarding Ink Tank replacement is shown on the Display Screen, and printing is disabled. Replace the Ink Tank at this point.

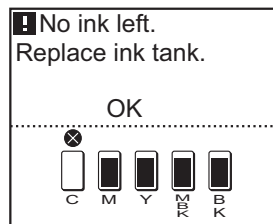

Printheads

- Printhead 585
- Checking for Nozzle Clogging 585
- Cleaning the Printhead 586
- Replacing the Printhead 587

Printhead

When purchasing, check the Model number.

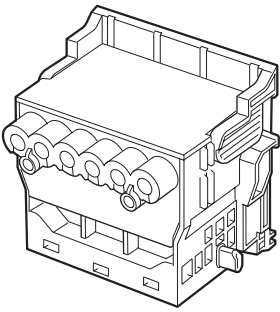
Shape	Model number
	PF-04



• For instructions on replacing the Printhead, see "Replacing the Printhead." →P.587

Checking for Nozzle Clogging

If printing is faint or affected by banding in different colors, make sure the Printhead nozzles are clear by printing a test pattern to check the nozzles.



• By default, nozzles are checked at fixed intervals. Configure the settings on the Control Panel menu in **Nozzle Check**. (See "Menu Settings.") →P.449

Paper to Prepare

When Using Rolls	An unused roll at least 254.0 mm (10.00 in) wide
When Using Sheets	One sheet of unused paper of at least A4/Letter size

1 Load paper.

- Attaching the Roll Holder to Rolls →P.342
- Loading Rolls in the Printer →P.345
- Loading Sheets in the Printer →P.369

2 On the **Tab Selection screen** of the Control Panel, press ◀ or ▶ to select the Settings/Adj. tab ().

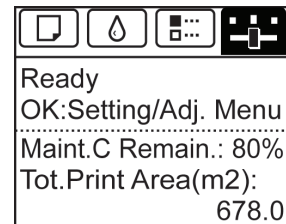

• If the **Tab Selection screen** is not displayed, press the **Menu** button.

- 3** Press the **OK** button.
The **Set./Adj. Menu** is displayed.
- 4** Press **▲** or **▼** to select **Test Print**, and then press the **OK** button.
- 5** Press **▲** or **▼** to select **Nozzle Check**, and then press the **OK** button.
The printer now prints a test pattern for checking the nozzles.
- 6** Check the printing results.

If the horizontal lines are not faint or incomplete, the nozzles are clear.

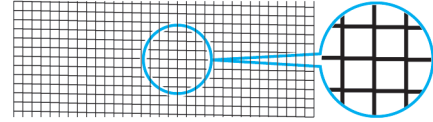

If some sections of the horizontal lines are faint or incomplete, the nozzles for those colors are clogged.

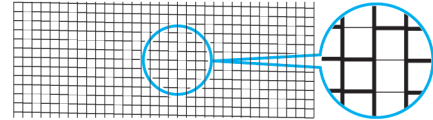

If horizontal lines are faint or incomplete, follow the steps below and check again for nozzle clogging.

- 1.** Clean the Printhead. (See "Cleaning the Printhead.") →P.586
- 2.** Print a test pattern to check the nozzles.



Note • If you repeat these steps several times but the horizontal lines are still faint or incomplete, the Printhead may have reached the end of its useful life. Contact your Canon dealer for assistance.

Cleaning the Printhead

If printing is faint, cleaning the Printhead may improve results.

Choose one of two Printhead cleaning modes (**Head Cleaning A** or **Head Cleaning B**), depending on the problem to resolve.

- **Head Cleaning A**

Use this mode if printing is faint or contains foreign substances. This method of cleaning consumes the least amount of ink.

It takes about three minutes to complete.

- **Head Cleaning B**

Use this mode if no ink is ejected at all, or if **Head Cleaning A** does not solve the problem.

It takes about three and a half minutes to complete.



Important

- Do not remove the Maintenance Cartridge or ink tanks during either **Head Cleaning A** or **Head Cleaning B**. Ink may leak or an error may occur.
- If printing does not improve even if you execute **Head Cleaning B**, try repeating **Head Cleaning B** once or twice. If this still does not improve printing, the Printhead may have reached the end of its useful life. Contact your Canon dealer for assistance.



Note

- By default, nozzles are checked at fixed intervals. Configure the settings on the Control Panel menu in **Nozzle Check**. (See "Menu Settings.") →P.449

Perform cleaning as follows.

- 1** On the **Tab Selection screen** of the Control Panel, press **◀** or **▶** to select the **Settings/Adj. tab** ().





Note

- If the **Tab Selection screen** is not displayed, press the **Menu** button.

2

Press the **OK** button.
The **Set./Adj. Menu** is displayed.

3

Press **▲** or **▼** to select **Maintenance**, and then press the **OK** button.

4

Press **▲** or **▼** to select **Head Cleaning**, and then press the **OK** button.

5

Press **▲** or **▼** to select **Head Cleaning A** or **Head Cleaning B**, and then press the **OK** button.
Head cleaning is now executed.

6

Print a test pattern to check the nozzles, and determine whether cleaning has cleared the nozzles. (See "Checking for Nozzle Clogging.") [→P.585](#)

Replacing the Printhead

When to replace the Printhead

Replace the Printhead in the following situations.

- If the printing quality does not improve even after one or two cycles of **Head Cleaning B** from the printer menu
- If the Display Screen indicates "**Open top cover and replace the printhead.**"
- If your Canon dealer has advised you to replace the Printhead

Compatible printheads

For information on compatible printheads, see "**Printhead.**" [→P.585](#)

Precautions when handling the Printhead

Take the following precautions when handling the Printhead.



Caution

- For safety, keep the Printhead out of the reach of children.
- If ink is accidentally ingested, contact a physician immediately.
- Do not touch the Printhead immediately after printing. The Printhead becomes extremely hot, and there is a risk of burns.



Important

- There may be ink around the nozzles of the Printhead you remove. Handle the Printhead carefully during replacement. The ink may stain clothing.
- Do not open the Printhead pouch until immediately before installation. After removing the Printhead from the pouch, install it right away. If the Printhead is left after the pouch is opened, the nozzles may dry out, which may affect printing quality.

Access the menu for Printhead replacement



Caution

- When replacing the Printhead immediately after printing, wait a few minutes before replacing it. The metal parts of the Printhead become hot during printing, and there is a risk of burns from touching these parts.



Important

- Your hands may become dirty during Printhead replacement. Use the gloves provided with the new Printhead for replacement.



Note

- Prepare a new Ink Tank when ink levels are low.
- When the remaining capacity of Maintenance cartridge is low, prepare a new Maintenance cartridge.

- 1 On the **Tab Selection screen** of the Control Panel, press ◀ or ▶ to select the Settings/Adj. tab ().

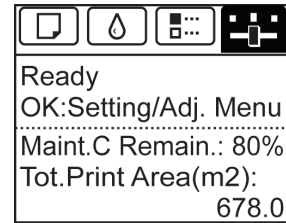

• If the **Tab Selection screen** is not displayed, press the **Menu** button.

Note

- 2 Press the **OK** button.
The **Set./Adj. Menu** is displayed.
- 3 Press ▲ or ▼ to select **Maintenance**, and then press the **OK** button.
- 4 Press ▲ or ▼ to select **Replace P.head**, and then press the **OK** button.
Ink begins being drawn in. When it finishes, instructions are displayed on the Display Screen.
It takes about two minutes to complete.

Replace the Printhead

- 1 Remove the Stacker from the printer.
(See "Installing and Removing the Stacker On the Printer.") →P.376

- 2 Open the Top Cover.
Instructions are now shown on the Display Screen regarding Printhead replacement.

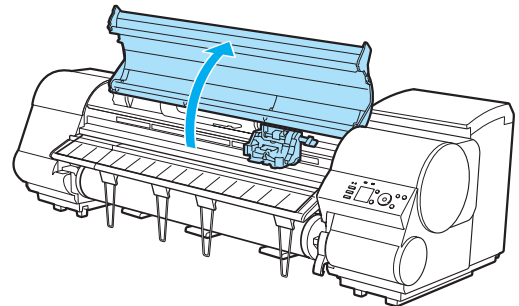

- 3 If the Printhead Fixer Cover or Printhead Fixer Lever is dirty, use a damp cloth that you have wrung out completely to wipe it clean.

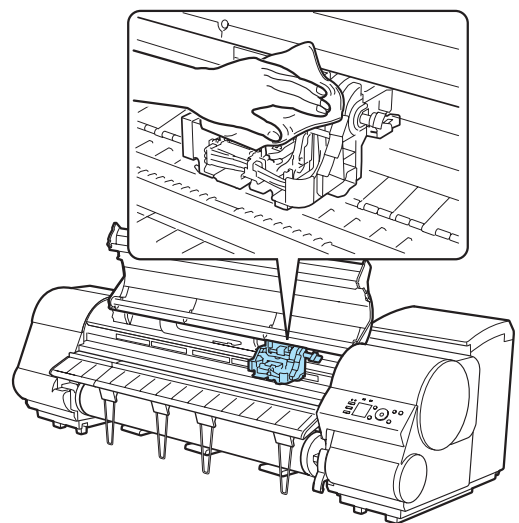



Important

- Do not touch the Linear Scale (a), Carriage Shaft (b), or Ink Tube Stabilizer (c). Touching these parts may damage them.

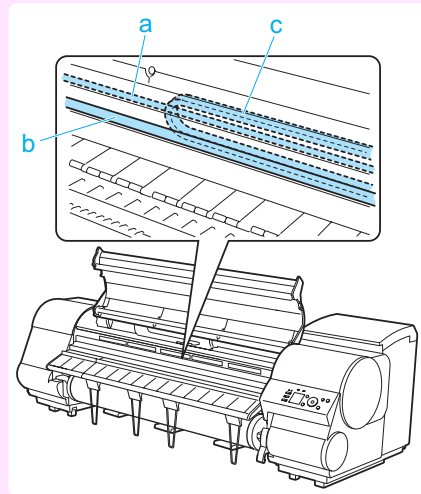

4

If the ventilation duct (a) is dirty, use a damp cloth that you have wrung out completely to wipe it clean. Move the Carriage out of the way manually if the Carriage is concealing the ventilation duct, and then clean the duct.

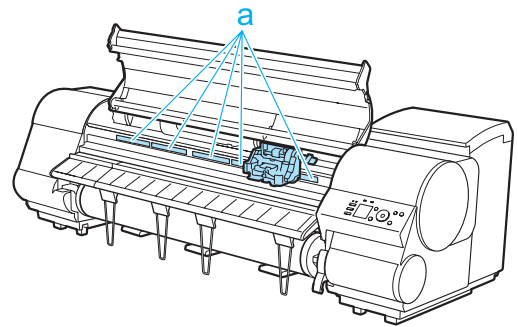

5

Pull the Printhead Fixer Lever forward all the way to open it completely.

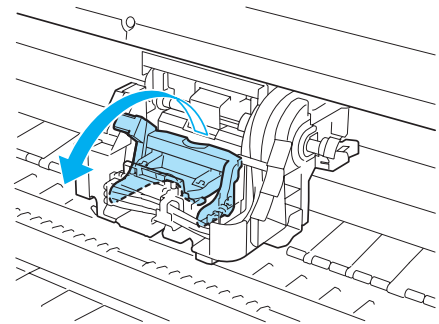

6

Pull up the Printhead Fixer Cover to open it completely.

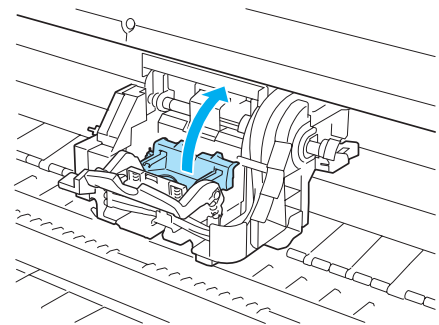

7 Remove the Printhead and press the **OK** button.

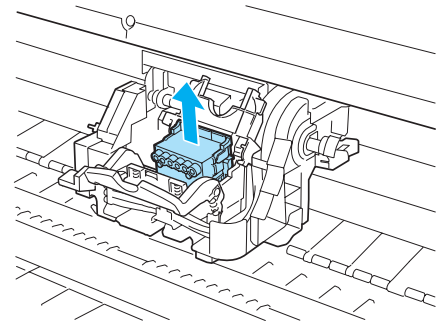

• Never touch the metal contacts of the Carriage. Furthermore, do not allow any dirt or debris to become adhered to the metal contacts of the Carriage. These may damage the printer.



• Dispose of the used Printhead in accordance with local regulations.

8 Holding the new Printhead by the grips (a), remove it from the pouch.

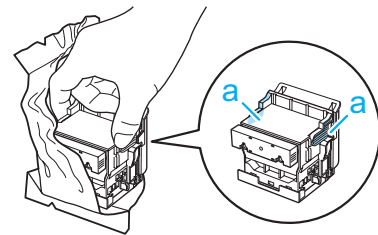

• When handling the Printhead, always hold it by the grips (a). Never touch the nozzles (b) or metal contacts (c). This may damage the Printhead and affect printing quality.
• Never touch the ink supply section (d). This may cause printing problems.

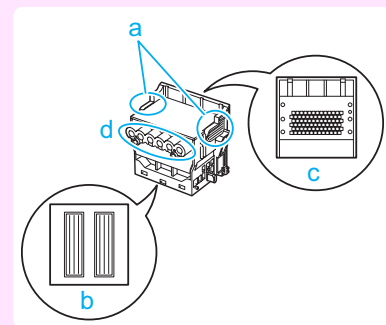

9 While firmly holding the Printhead you have removed, use your other hand to remove the orange Protective Part (a). Squeeze the grips (c) of Protective Part (b) and pull it down to remove it.

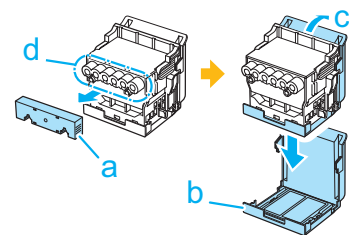



- The inside surface of the Protective Part (a) and Protective Part (b) is coated with ink to protect the nozzles. Be careful not to touch these surfaces when removing the caps.
- The Printhead contains ink to protect the nozzles. We recommend removing Protective Part (b) as you hold it over the Printhead package or safely out of the way to avoid spilling ink and staining your clothes or the surrounding area. If ink accidentally spills, wipe off the ink with a dry cloth.
- If you need to put a Printhead somewhere temporarily before installation, do not keep the nozzles and metal contacts facing down. If the nozzles or metal contacts are damaged, it may affect the printing quality.
- Do not reattach the removed Protective Part. Dispose of these materials in accordance with local regulations.

10 With the nozzles facing down and the metal contacts toward the back, insert the Printhead into the Carriage. Carefully push the printhead firmly into the Carriage, ensuring that the nozzles and metal contacts do not touch the carriage.

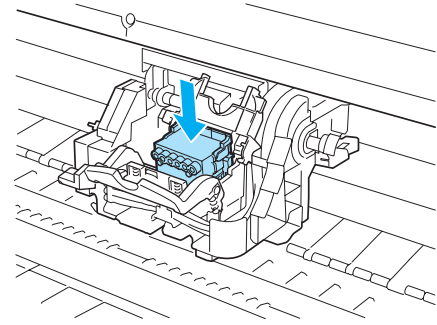

11 Pull the Printhead Fixer Cover down toward the front to lock the Printhead in place.

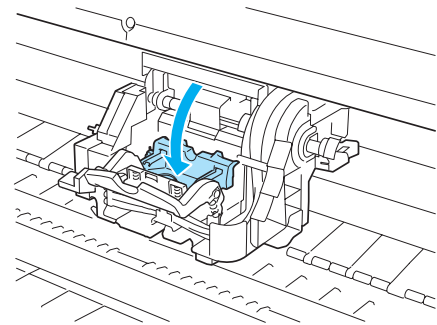

12 Push the Printhead Fixer Lever toward the back of the printer until it clicks.

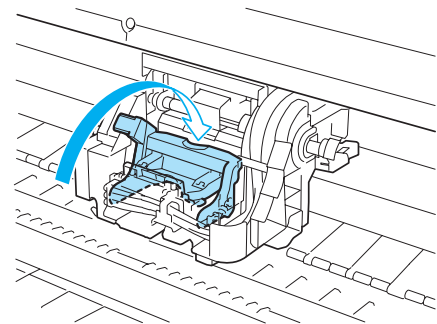

13 Close the Top Cover. Ink now fills the system. It takes about six minutes to complete.

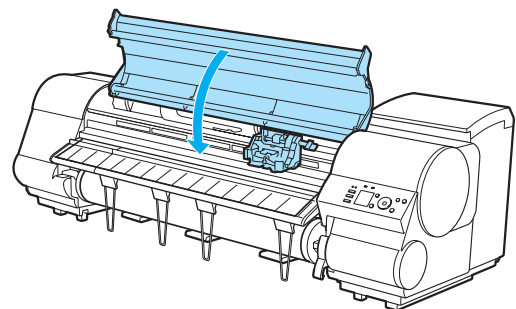

**Important**

- While ink is being filled, definitely do not remove the Ink Tank or Maintenance Cartridge. Ink may leak out.

**Note**

- The procedure is now finished if you have set **Rep.P.head Print** to **Off** in the Control Panel menu. In this case, execute **Initial adjustmt in Head Posi. Adj.** in the Control Panel menu. (See "Adjustment When Installing the Printhead.") →P.559

14

Feed paper by following the instructions on the Display Screen.
After the paper has advanced, **Initial adjustmt in Head Posi. Adj.** is executed automatically.

15

Install the Stacker on the printer.
(See "Installing and Removing the Stacker On the Printer.") →P.376

Maintenance Cartridge

Maintenance Cartridge 593
 Replacing the Maintenance Cartridge 593
 Checking the Remaining Maintenance Cartridge Capacity 597
 When to Replace the Maintenance Cartridge 598

Maintenance Cartridge

When purchasing, check the Model number.

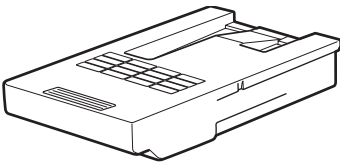
Shape	Model number
	MC-10



Note

- For instructions on replacing the Maintenance Cartridge, see "Replacing the Maintenance Cartridge." →P.593
- The MC-09 can also be used. However, the Shaft Cleaner included with the MC-09 cannot be used with this printer.

Replacing the Maintenance Cartridge

Compatible maintenance cartridges

For information on compatible maintenance cartridges, see "Maintenance Cartridge." →P.593

Precautions when handling the Maintenance Cartridge

Take the following precautions when handling the Maintenance Cartridge.



Caution

- For safety, keep the Maintenance Cartridge out of the reach of children.
- If ink is accidentally ingested, contact a physician immediately.



Important

- Do not remove the Maintenance Cartridge except to replace it. Ink may leak out.
- Do not remove an Maintenance Cartridge during initialization immediately after turning on the printer, during Printhead cleaning, while ink is being drawn out, or during initialization immediately after replacing the Maintenance Cartridge. The Maintenance Cartridge may become damaged or ink may leak out.
- To prevent ink from leaking from a used Maintenance Cartridge, avoid dropping the cartridge or storing it at an angle. Otherwise, ink may leak and cause stains.
- Ink adheres to the top of the Maintenance Cartridge after it has been used. Handle the Maintenance Cartridge carefully during replacement. The ink may stain clothing.

Confirm the message

When the Maintenance Cartridge is almost empty, a message is shown on the Display Screen. According to the message, replace the Maintenance Cartridge or prepare a new Maintenance Cartridge. (See "When to Replace the Maintenance Cartridge.") →P.598

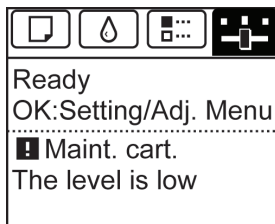

If a message is displayed requesting Maintenance Cartridge replacement, you can skip the step **Access the menu for Maintenance Cartridge replacement**. Follow the instructions in **Replace the Maintenance Cartridge**.

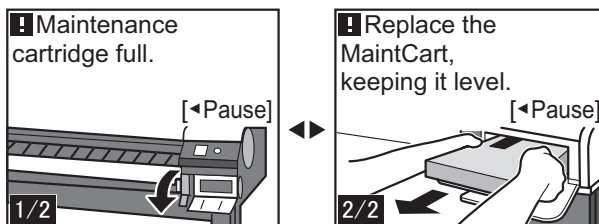

Access the menu for Maintenance Cartridge replacement

- 1 On the **Tab Selection screen** of the Control Panel, press ◀ or ▶ to select the Settings/Adj. tab (⌘).

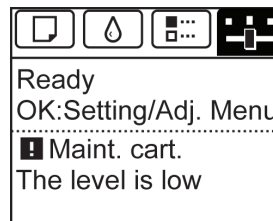

• If the **Tab Selection screen** is not displayed, press the **Menu** button.

Note

- 2 Press the **OK** button. The **Set./Adj. Menu** is displayed.
- 3 Press ▲ or ▼ to select **Maintenance**, and then press the **OK** button.
- 4 Press ▲ or ▼ to select **Repl. maint cart**, and then press the **OK** button. Instructions are displayed on the Display Screen.

Replace the Maintenance Cartridge

- 1 Open the box, remove the plastic bag and packaging material, and take out the Maintenance Cartridge.

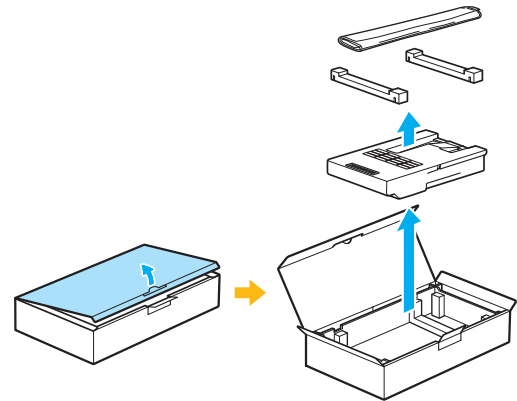

Important

- Never touch the metal contacts (a). This may damage the Maintenance Cartridge.

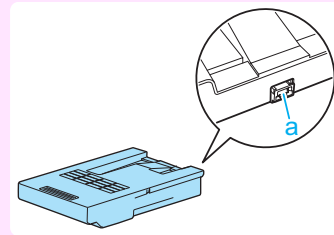

- 2 At this point, open the Maintenance Cartridge Cover.

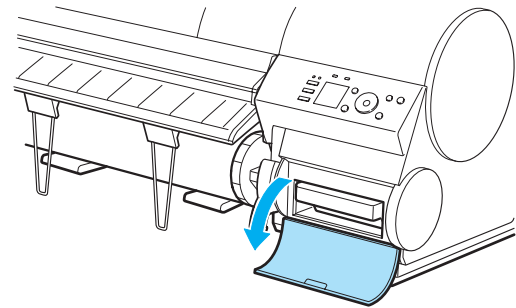

- 3 Hold the used Maintenance Cartridge by the grip (a) with one hand and put your other hand under the Maintenance Cartridge to hold it firmly on the bottom, keeping it level as you pull it out.

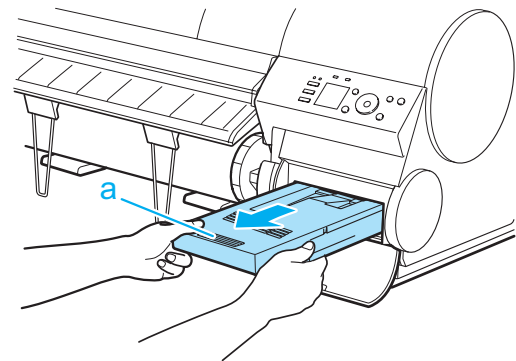

Important

- Used maintenance cartridges are heavy. Always grasp the cartridge firmly and keep the cartridge level during removal and storage. If you drop a used Maintenance Cartridge or store it at an angle, ink may leak and cause stains.
- The remaining Maintenance Cartridge capacity is recorded on each printer. Do not install a used Maintenance Cartridge in another printer.

4 Keep the used Maintenance Cartridge level as you put it in the plastic bag. Expel excess air from the plastic bag and seal the zipper.

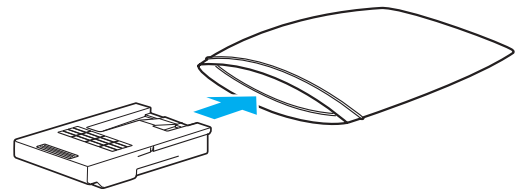

5 Confirm the Maintenance Cartridge is right-side up, put it in the box with the packaging material attached, and store it so that it stays level.

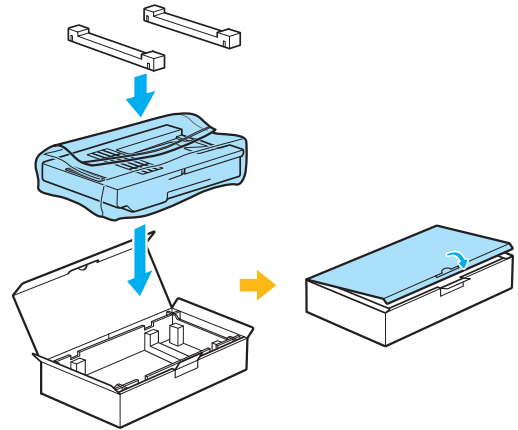

• Always put the used Maintenance Cartridge back in the box and store the box on a flat surface. Also, seal the zipper thoroughly. Otherwise, ink may leak and cause stains.



• Put the used Maintenance Cartridge in the plastic bag of the new cartridge, and dispose of it in accordance with local regulations.

6 Wipe away any soiling on the Maintenance Cartridge Cover.

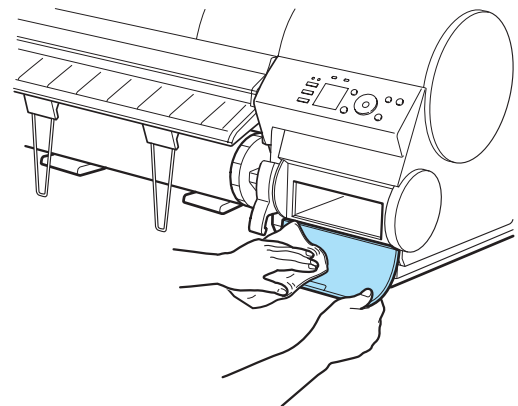

• Support the Maintenance Cartridge Cover from underneath as you wipe it.

7 Keeping the new Maintenance Cartridge level, insert it all the way in. The printer now initializes the Maintenance Cartridge.

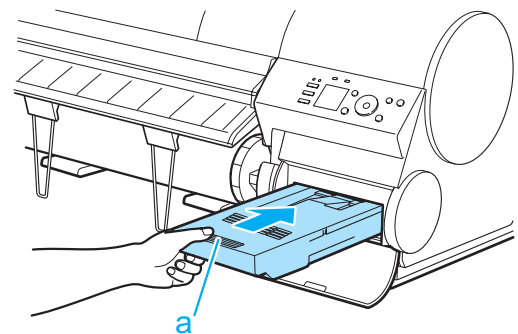

• Do not remove the Maintenance Cartridge during initialization immediately after replacing the Maintenance Cartridge. The Maintenance Cartridge may become damaged.

8 Close the Maintenance Cartridge Cover.

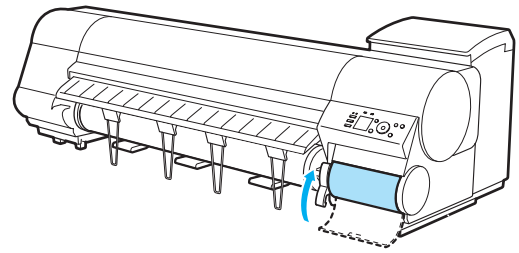

Note • If you did not perform the operation in **Access the menu for Maintenance Cartridge replacement**, this is the end of the procedure and you do not need to press the **OK** key in the next step.

9 Press the **OK** button.

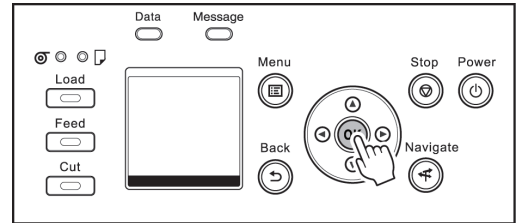

Checking the Remaining Maintenance Cartridge Capacity

The Maintenance Cartridge absorbs excess ink from borderless printing, printhead cleaning, and other processes. You can confirm the remaining capacity of the Maintenance Cartridge by checking the Maintenance Cartridge capacity shown on the Display Screen.

To check remaining Maintenance Cartridge capacity, access the **Tab Selection screen** on the Control Panel and press ◀ or ▶ to select the Settings/Adj. tab (⌘).

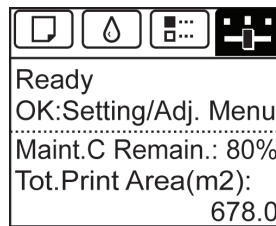

Note • If the **Tab Selection screen** is not displayed, press the **Menu** button.

If the Display Screen indicates to replace the Maintenance Cartridge, replace the Maintenance Cartridge. If a message is displayed indicating to check the remaining capacity of the Maintenance Cartridge, or before tasks that deplete much of the capacity such as head cleaning or preparations to move the printer, check the remaining Maintenance Cartridge capacity and prepare a new Maintenance Cartridge as needed. (See "Replacing the Maintenance Cartridge.") →P.593

When to Replace the Maintenance Cartridge

Replace or prepare to replace the Maintenance Cartridge in the following situations.

If a message for checking the Maintenance Cartridge is shown on the Display Screen

When the Maintenance Cartridge is almost full, the **Message Lamp** is lit and "The level is low" is shown on the Display Screen. You can continue to print, but check the remaining Maintenance Cartridge capacity and prepare to replace the Maintenance Cartridge with a new one. (See "Checking the Remaining Maintenance Cartridge Capacity.") →P.597

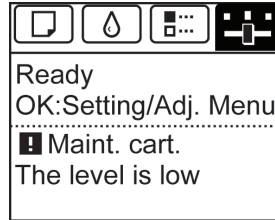

When much of the Maintenance Cartridge capacity is depleted

Printhead cleaning, Printhead replacement, and preparations to transfer the printer deplete much of the Maintenance Cartridge capacity. (In particular, preparing to move the printer depletes a lot of the capacity.) Check the remaining Maintenance Cartridge capacity before this maintenance and replace the Maintenance Cartridge if necessary.

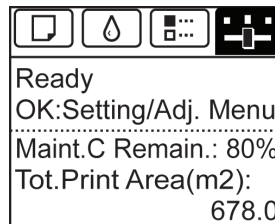

If a message for the Maintenance Cartridge replacement is shown on the Display Screen

When the Maintenance Cartridge is full, the **Message Lamp** flashes and a message to replace the Maintenance Cartridge is shown on the Display Screen. Printing is disabled, and you cannot replace the Printhead or transfer the printer. Replace the Maintenance Cartridge with a new one.

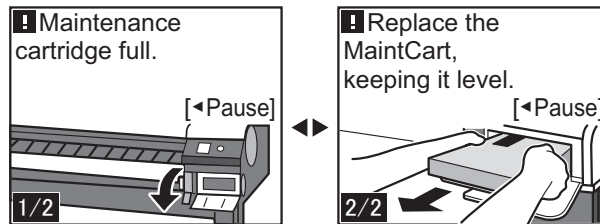

Cleaning the Printer

Cleaning the Printer Exterior	599
Cleaning Inside the Top Cover	599
Cleaning the Stacker	601
Cleaning the Printhead	586

Cleaning the Printer Exterior

Clean the printer regularly to maintain better printing quality and help prevent problems. To ensure a comfortable working environment, clean the printer exterior about once a month.

1 Turn the printer off. (See "Turning the Printer On and Off.") →P.17

2 Unplug the power cord from the outlet.



• Always turn off the printer and unplug the power cord before cleaning or maintenance. Accidentally leaving the printer on poses a risk of injury if you touch moving parts inside the printer.

3 Using a damp cloth that you have wrung out completely, wipe away any dirt or paper dust from the Paper Feed Slot (a), power cord plug, and so on. Dry these parts with a dry cloth.

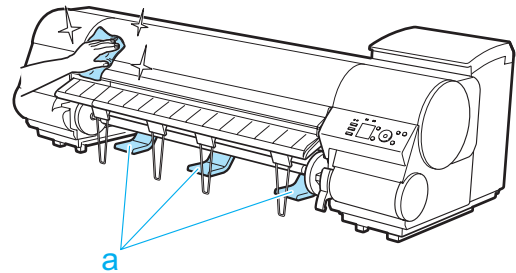

• Never use flammable solvents such as alcohol, benzene, or thinner. If these substances come into contact with electrical components inside the printer, there is a risk of fire or electrical shock.



• If the Ejection Guide is dirty, it may soil the edge of the paper when the paper is cut. We recommend cleaning the Ejection Guide even if it does not appear dirty, because it may actually be covered with paper dust. (See "Cleaning Inside the Top Cover.") →P.599

4 Plug the power cord into the outlet.

Cleaning Inside the Top Cover

Clean inside the Top Cover about once a month to maintain better printing quality and help prevent problems. Also clean inside the Top Cover in the following situations to ensure optimal operation.

- If the printed surface or the underside of paper is dirty after printing
- After you have used up a roll
- After borderless printing
- After printing on small paper
- After printing on paper that generates a lot of cutting debris
- If you have replaced the roll
- After printing on paper that generates a lot of paper dust
- If the message **"Blue platen switch is dirty."** is displayed



• If the Platen inside the Top Cover becomes dirty, it may soil the underside of paper. We recommend cleaning the Platen after borderless printing or printing on small paper.
• If the Ejection Guide is dirty, it may soil the edge of the paper when the paper is cut. We recommend cleaning the Ejection Guide even if it does not appear dirty, because it may actually be covered with paper dust.

1 Remove the Stacker from the printer.
 (See "Installing and Removing the Stacker On the Printer." → P.376)

2 Open the Top Cover.

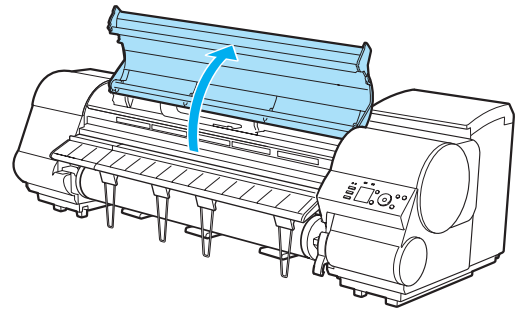

3 If paper dust has accumulated in the Vacuum holes (a) on the Platen or in the Borderless Printing Ink Grooves (b), use the Cleaning Brush (c) provided with the printer to wipe it away.

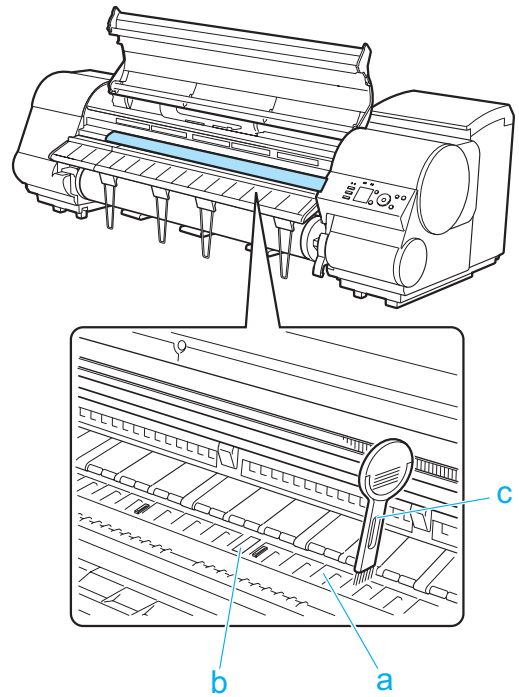

Important

- Do not touch the Linear Scale (a), Carriage Shaft (b), or Ink Tube Stabilizer (c). Touching these parts may damage them. Avoid cleaning where the Carriage is retracted, in position (d) or (e).

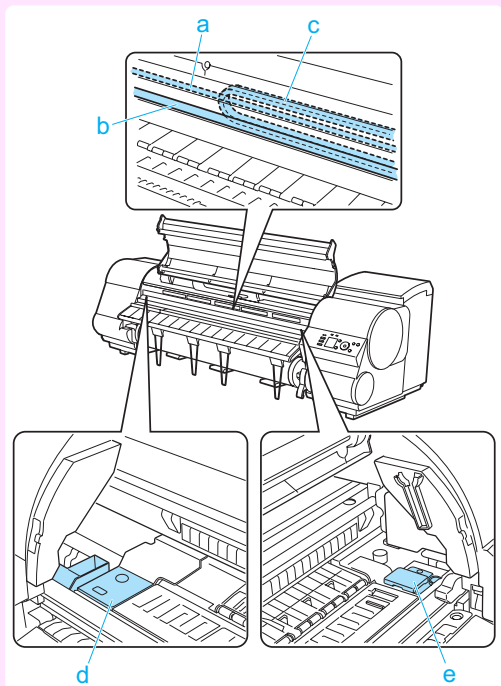



- If the Cleaning Brush is dirty, rinse it in water.

4

Using a damp cloth that you have wrung out completely, wipe away dirt or paper dust (debris from cutting) inside the Top Cover. Wipe away any ink residue and paper dust (debris from cutting) on the Top Cover Roller (a), all over the Platen (b), the Paper Retainer (c), the Borderless Printing Ink Grooves (d), the Ejection Guide (e), the blue Switch (f), the section around the right-side Borderless Printing Ink Grooves (g), and so on.

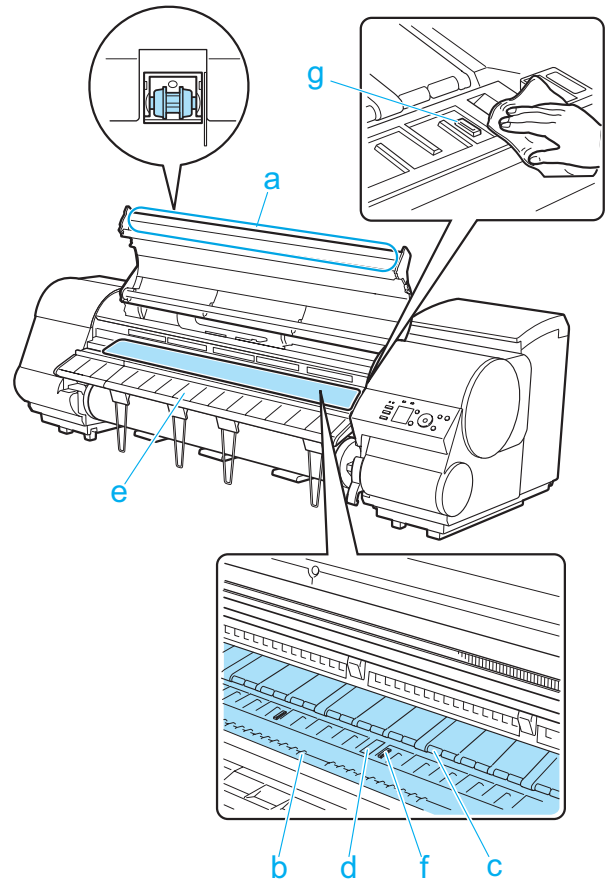

- Never use flammable solvents such as alcohol, benzene, or thinner. If these substances come into contact with electrical components inside the printer, there is a risk of fire or electrical shock.



- Do not use a dry cloth to wipe inside the Top Cover. This may create a static charge, which may attract dust and affect the printing quality.
- Do not touch the clear sheet on the side of the Top Cover Roller. This may damage the roller.

5

Close the Top Cover.

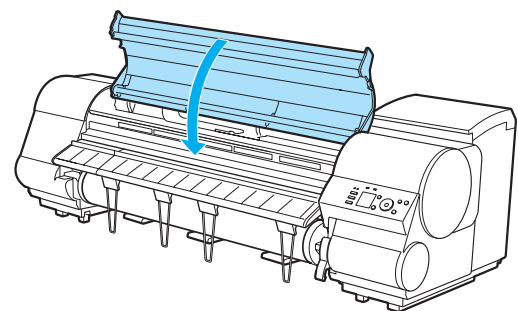

6

Install the Stacker on the printer. (See "Installing and Removing the Stacker On the Printer." → P.376)

Cleaning the Stacker

If the front or back surfaces of the paper are soiled, clean the Stacker.

Items to Prepare

- | | |
|------------|--|
| Roll paper | An unused roll at least 254.0 mm (10.00 in) wide |
|------------|--|



• Approximately 1 m (1.09 yd) of roll paper is used by this operation.

Note

1 Turn the printer and Stacker off.

2 Open the Canopy.

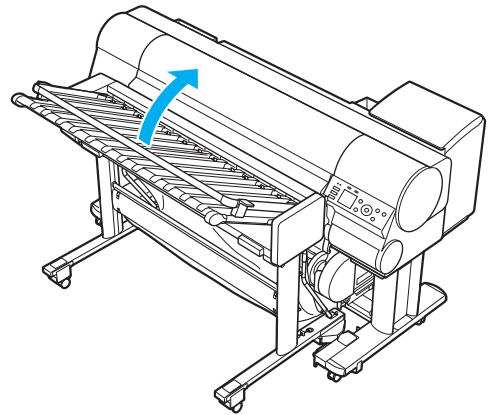

3 Using a damp cloth that you have wrung out completely, wipe away ink and paper dust from the Paper Retainer (a), roller (b), and rubber roller (c) which become soiled easily. At this time, also wipe away soiling from the entire tray (d).

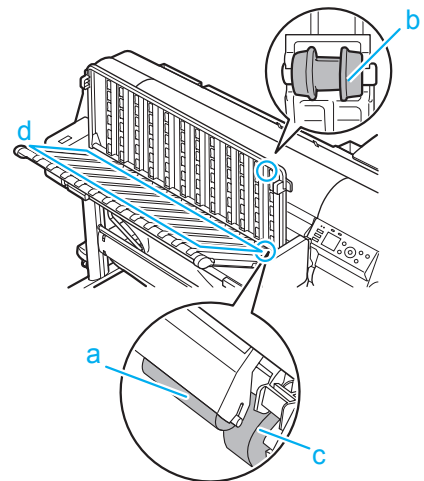

4 Close the Canopy.

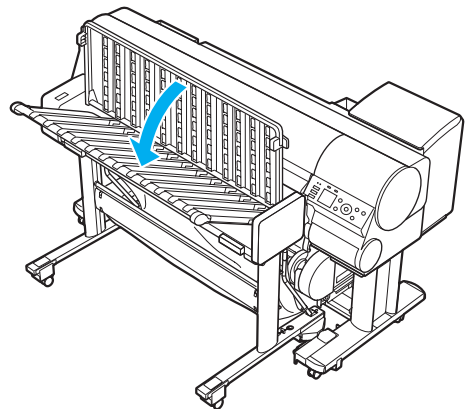

5 Turn the printer on.

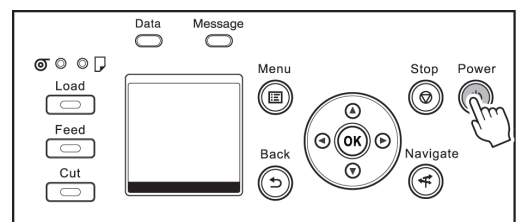

6 If roll paper is not loaded in the printer, load roll paper in the printer.
 (See "Attaching the Roll Holder to Rolls.") →P.342
 (See "Loading Rolls in the Printer.") →P.345

7 If the Stacker is removed from the printer, install the Stacker on the printer.
 (See "Installing and Removing the Stacker On the Printer.") →P.376

8 Turn the Stacker on.

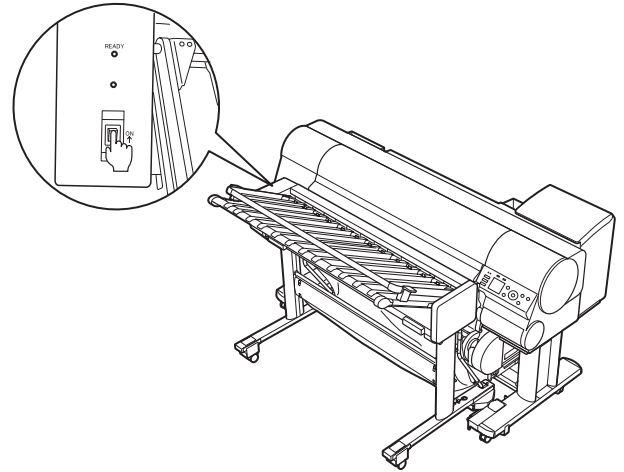

9 Press the **Feed** button.

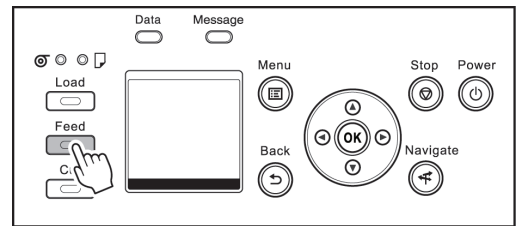

• A message is displayed on the Display Screen. If you are unable to execute paper advance, feed the paper using the following procedure.

1. Press the **Back** button to display the **Tab Selection** screen.
2. Press the **Load** button.
3. When a message is displayed, press **▲** or **▼** to select **Reload Roll Paper**, and then press the **OK** button.

10 Press the **▼** button to advance the roll paper until approximately 20 cm (7.87 in) is ejected into the tray.

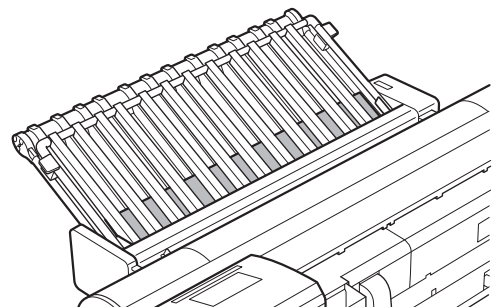

11 Press the **Cut** button to cut the roll paper.

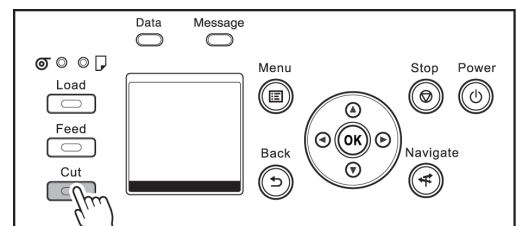



- Do not remove the cut roll paper. It is used for cleaning the roll paper feed components (a).

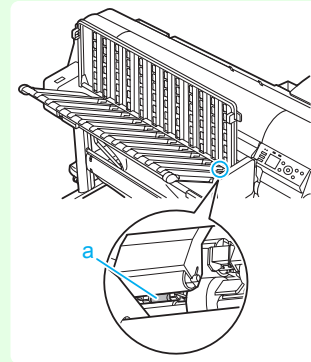

12 Press the **Feed** button.

13 Press the ▼ button to advance the roll paper until approximately 20 cm (7.87 in) is ejected into the tray.

14 Press the ▲ button and rewind the roll paper until **"End of paper feed."** is displayed on the Display Screen.



- The entire roll paper feed components (a) are cleaned by moving the roll paper backwards and forwards.

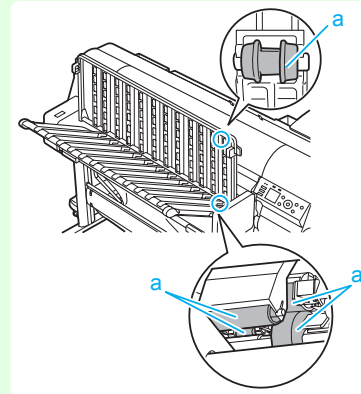

15 Repeat steps 13 and 14.

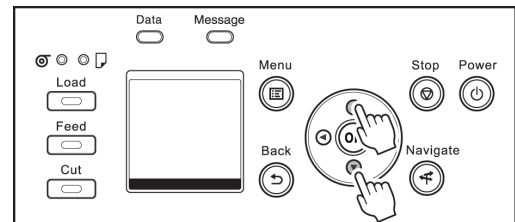

16 Eject the leading edge of the roll paper until it reaches the end of the tray.

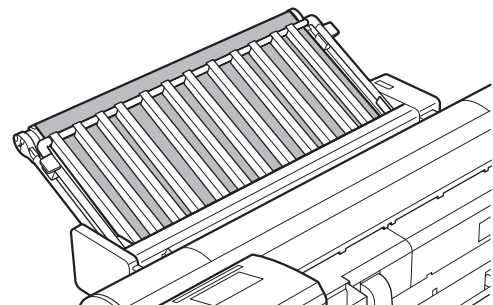

17 Press the **Cut** button to cut the roll paper.

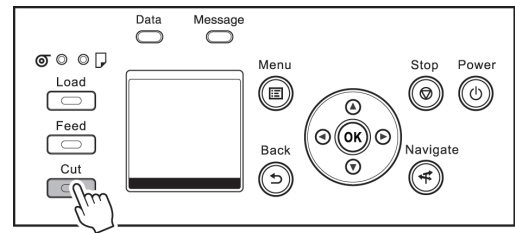

18 Open the Canopy and remove the two sheets of cut roll paper.

Other Maintenance

Preparing to Transfer the Printer 606
 Reinstalling the Printer 611
 Updating the Firmware 615

Preparing to Transfer the Printer

To protect the internal parts in transit, always follow these steps before transferring the printer to a new location. Refer to the Setup Guide for details on packing the printer and installing it after transfer.



- Be sure to contact your Canon dealer before transferring the printer to a new location. Ink may leak and damage the printer if you do not prepare the printer correctly and it is tipped or stood on end in transit.

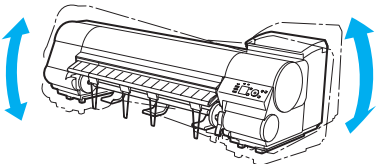
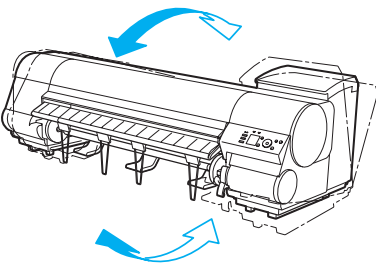

- Depending on the state of the printer, part replacement may be necessary when preparing to transfer the printer (that is, when you execute the printer menu item to prepare for transfer).
- Ink must be drawn into the Maintenance Cartridge before Level 2 or Level 3 printer transfer, as described in the following table. Prepare the Maintenance Cartridge in advance.
- Always follow the instructions of the service representative when transferring the printer under Level 3 conditions.

Level	Transport and Storage In Low Temperature Environments	Permitted Angle of Inclination	Amount of Ink to Dispose of	Required Maintenance Cartridges(*1)	Usage Examples
1	No	Lengthwise: 0–30°  Rotation: 0–10° 		0(*2)	Moving Within a Room and Storage In Room Temperature Environments
2	Yes	All directions: 0–30°	Approx. 700 ml (20.3 fl oz)	1 or 2	Transport By Vehicle
3	Yes	Lengthwise: 0–90° Rotation: 0–30°	Approx. 700 ml (20.3 fl oz)	1 or 2	Move by temporarily standing vertically

*1: This is the number of new Maintenance Cartridges required when you execute the **Prep.MovePrinter** menu. The number varies depending on the amount remaining in the Maintenance Cartridge being used.

*2: If a message instructing you to replace the Maintenance Cartridge is displayed on the Display Screen, the Maintenance Cartridge needs to be replaced.

Remove paper

1 Disassemble and repackage the Stacker by following the installation procedure in reverse.



- When storing the Stacker cable, place it in the cable package (or in a box measuring at least 30 cm (11.81 in) per side) without folding.

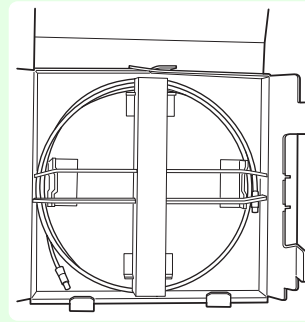

2 Remove the paper.

- Rolls (See "Removing the Roll from the Printer.") →P.352
- Sheets (See "Removing Sheets.") →P.373

Access the **Prep.MovePrinter** menu

1 If a message instructing you to replace the Maintenance Cartridge is displayed on the Display Screen, replace the Maintenance Cartridge.
(See "Replacing the Maintenance Cartridge.") →P.593

2 On the **Tab Selection screen** of the Control Panel, press ◀ or ▶ to select the Settings/Adj. tab ().

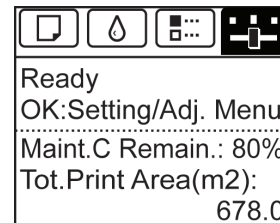

- If the **Tab Selection screen** is not displayed, press the **Menu** button.

3 Press the **OK** button.
The **Set./Adj. Menu** is displayed.

4 Press ▲ or ▼ to select **Prep.MovePrinter**, and then press the **OK** button.

5 Press ▲ or ▼ to select the level of transfer, and then press the **OK** button.
Displays the confirmation screen.

6 Press ▲ or ▼ to select **Execute**, and then press the **OK** button.
The printer is now prepared for transfer.

- **Level 1**
Once preparations are finished, a message on the Display Screen requests you to turn off the printer. Turn off and pack the printer. There is no need to remove the ink tanks.
(See "Pack the printer.") →P.610
- **Level 2 and Level 3**
When the preparation is finished, instructions are displayed on the Display Screen. Remove the ink tanks before packing the printer.
(See "Removing Ink Tanks.") →P.608



- If consumables must be replaced, the message "**Consumables must be replaced. Call for service.**" is shown on the Display Screen and preparation is not possible. If this message is displayed, press the **OK** button and contact your Canon dealer for assistance.

Removing Ink Tanks

- 1 Open the Ink Tank Cover.

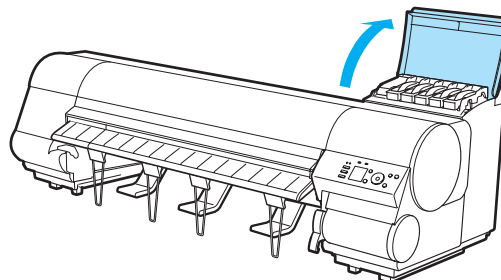

- 2 Lift the stopper (a) of the Ink Tank Lock Lever (a). Lift the Ink Tank Lock Lever until it stops, and then push it down to the front.

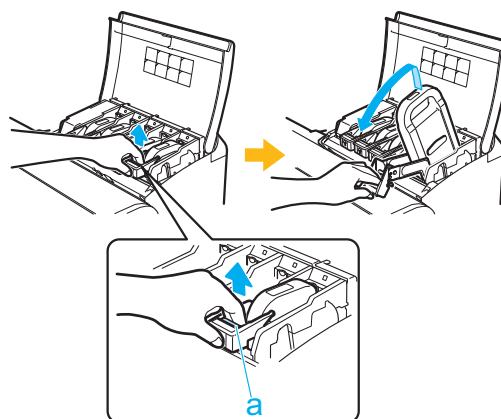

- 3 Hold the Ink Tank by the handle (a) and remove it.

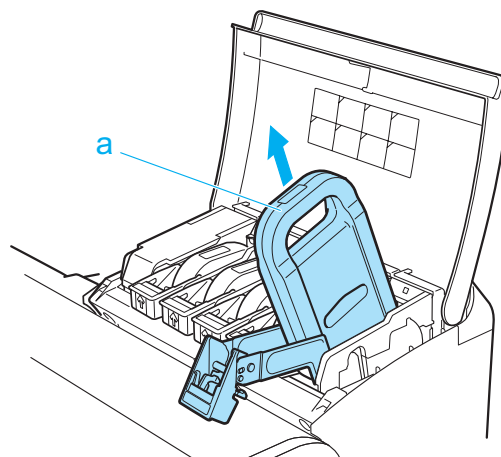



- Store the Ink Tank you removed in the box with the ink holes (a) facing up. Otherwise, ink may leak and cause stains.

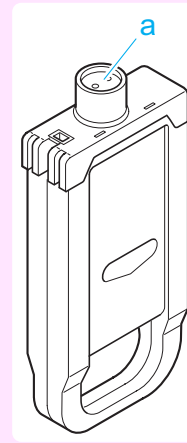

4 Repeat steps 2 and 3 to remove all ink tanks.

5 Push down the release lever (a) as shown as you gently return all ink tank lock levers to the original position.

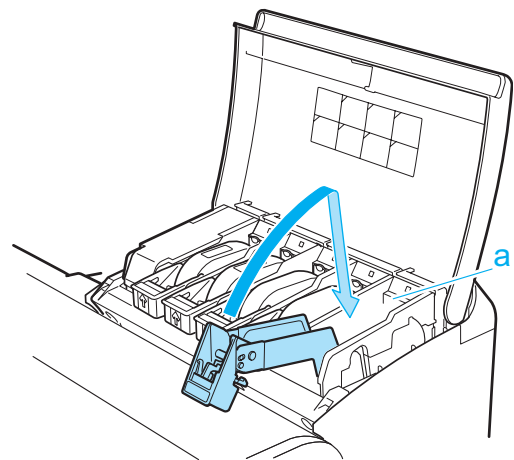

6 Close the Ink Tank Cover. At this point, ink is drawn out from inside the tubes.

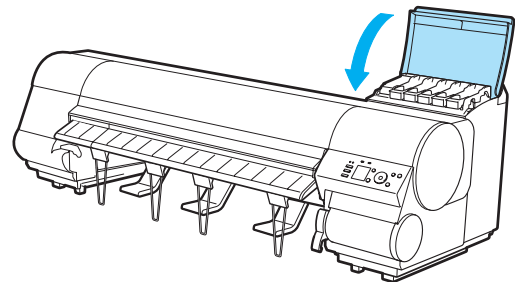

- Do not remove the Maintenance Cartridge except when the message for replacing it is displayed. If you remove the Maintenance Cartridge while ink is being drawn out, the ink may leak out.

7 When the process is finished, "**Preparations for moving the printer finished. Turn the power off**" is displayed.

When this happens, replace the Maintenance Cartridge currently being used with a new Maintenance Cartridge.

8 Press the **Power** button and turn off the printer.

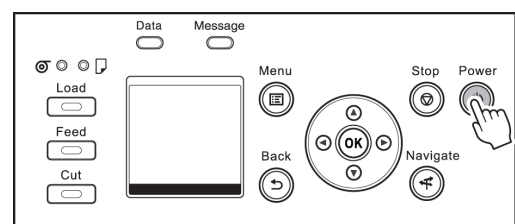

Pack the printer

1 Disconnect the printer power cord and interface cable, as well as the Roll Unit power cord.



- Turn off the printer before you unplug it. It may damage the printer if you unplug it before it is off and transfer it in that state. If you accidentally unplug the printer, plug it in again, reinstall the ink tanks, and follow this procedure again.

2 Open the Top Cover and lift the Ejection Guide.

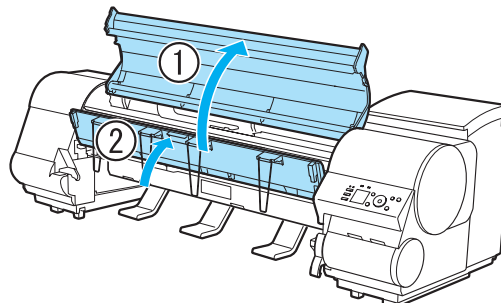

3 Remove the four ejection supports and lower the Ejection Guide.

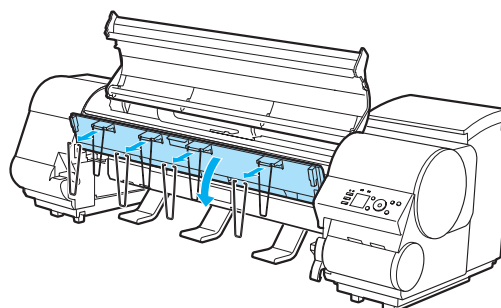

4 Grasp the Belt, insert it between the Belt Stopper, and affix the Belt Stopper with a hex screw at the position indicated.

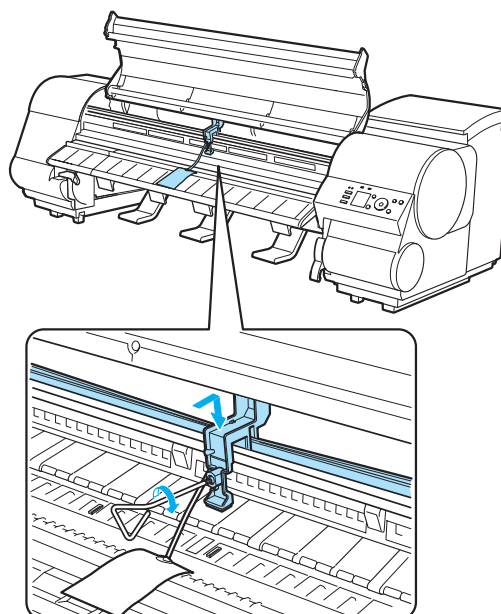



- Here, the Belt Stopper is the one that was removed and stored after initial installation. Neglecting to attach the Belt Stopper may damage the printer.
- Do not touch the Linear Scale (a), Carriage Shaft (b), or Ink Tube Stabilizer (c). Touching these parts may damage them.

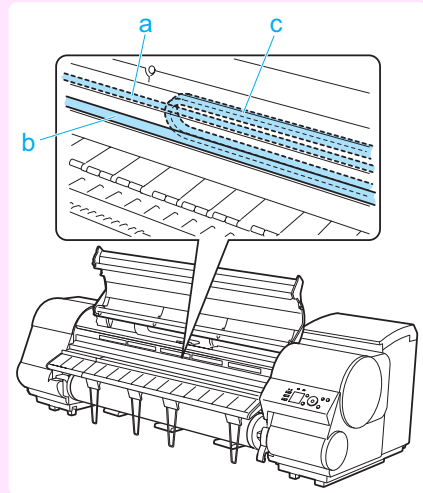

5 Close the Top Cover.

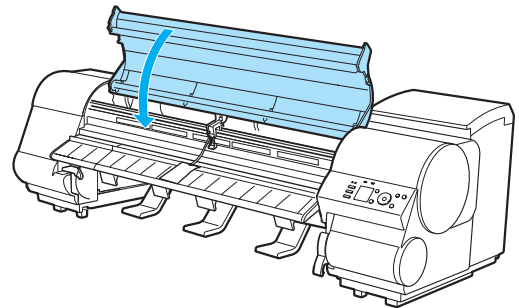

6 Tape down printer covers to secure them, in the reverse order of tape removal during installation.

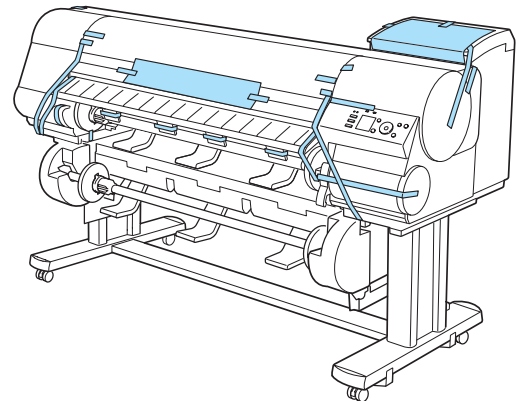

7 Remove and package the Stand by reversing the installation procedure, when it was attached to the printer.

8 Disassemble and repackage the Stand by following the installation procedure in reverse.

9 Repack the Roll Holder, Holder Stopper, and printer in shipping materials, and then package them in a shipping box.

Reinstalling the Printer

The basic workflow for reinstalling the printer is as follows. For detailed instructions, see the Setup Guide.

Assemble the stand

1 Referring to the Printer Stand Setup Guide, assemble the Stand.



- The Stand must be assembled by at least two people on a flat surface. Attempting assembly by yourself poses a risk of injury or bending the Stand.
- When assembling the Stand, lock the casters. In addition, always unlock the casters before moving the assembled Stand. Attempting to move the stand when the casters are locked poses a risk of injury or damage to the location site.

2 Attach the Roll Unit to the Stand.

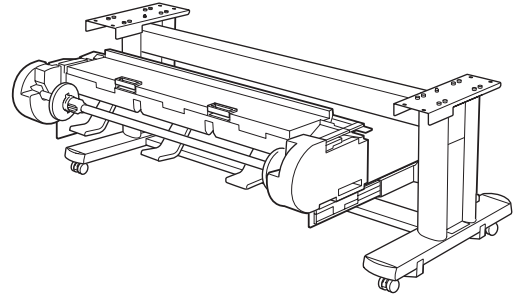

Install the printer

1 Mount the printer on the assembled Stand and tighten the screws firmly.

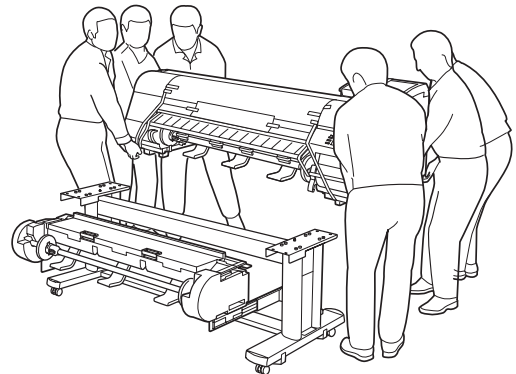

- Moving the printer requires at least six people, holding it on both sides. Be careful to avoid back strain and other injuries.
- When moving the printer, firmly grasp the Carrying Handles (a) under each side. The printer may be unsteady if you hold it at other positions, which poses a risk of injury from dropping the printer.

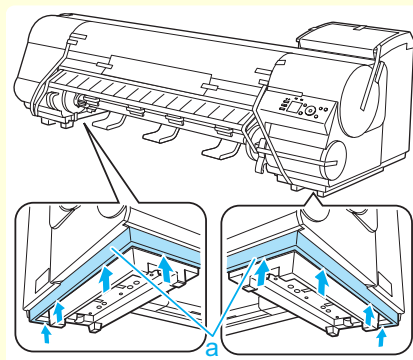

- 2 Remove tape and packaging material attached to the printer. Also open the Top Cover and remove stoppers and spacers inside the printer.

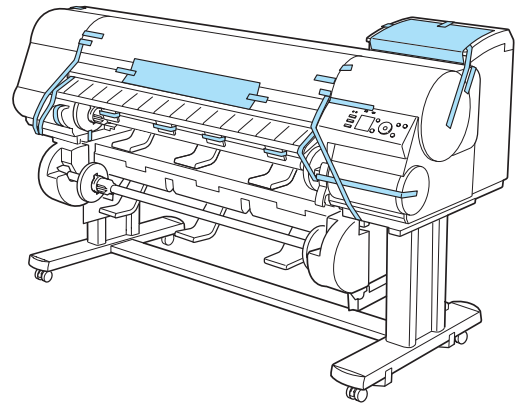

- 3 Lift the Ejection Guide and attach the four Ejection Supports to the back of the Ejection Guide.

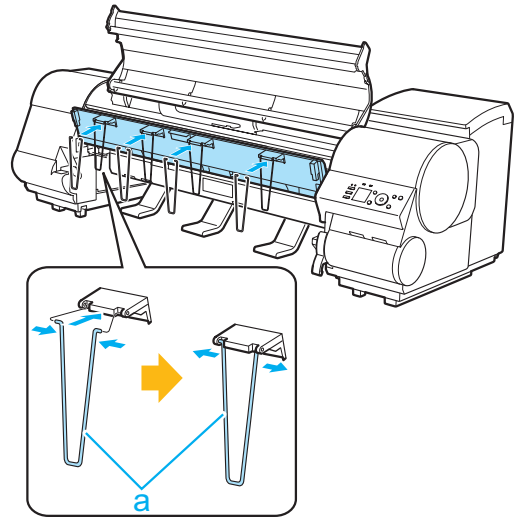

- 4 Connect the power cord to the Power Supply Connector on the back of the printer.

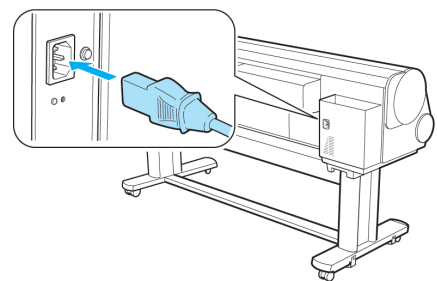

- 5 Plug the power cord into the outlet.

- 6 Press the power button to turn the printer on. When the message "Has printer been reinstalled? (Do not load ink tanks yet.)" is displayed, select Yes and press the OK button.

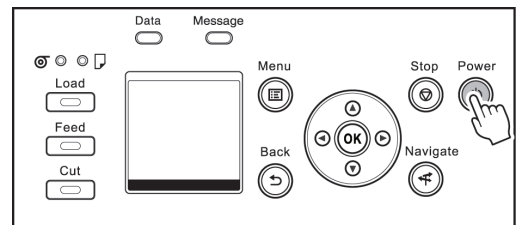

7 Open the Ink Tank Cover and install the ink tanks.

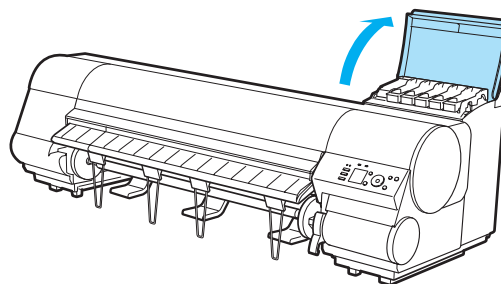

8 Attach the Roll Holder to the Roll Media.
(See "Attaching the Roll Holder to Rolls.") →P.342

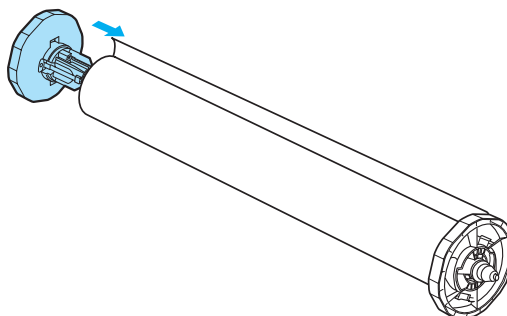

9 Load the Roll Media in the printer.
(See "Loading Rolls in the Printer.") →P.345

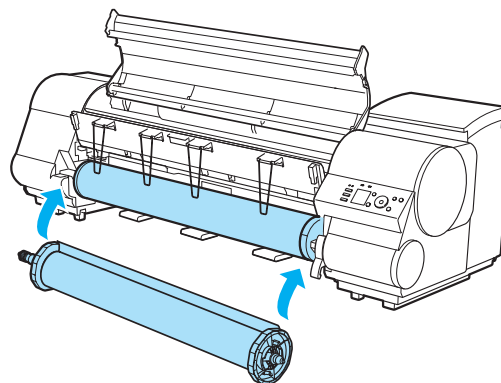

10 Install the software.
Note that the driver installation procedure varies depending on the type of connection.

11 Install the Stacker on the printer by referring to the Stacker Setup Guide.

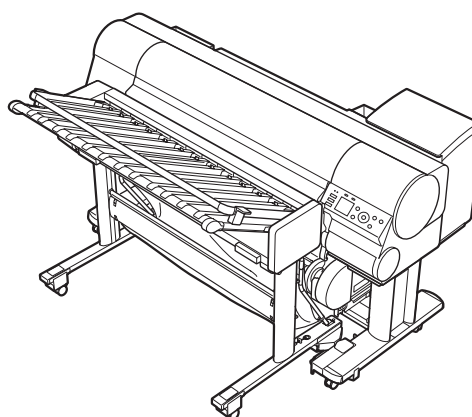

Updating the Firmware

Update the printer firmware to take advantage of new and improved printer functions.

Confirming the firmware version

- 1 On the **Tab Selection screen** of the Control Panel, press ◀ or ▶ to select the Settings/Adj. tab ().

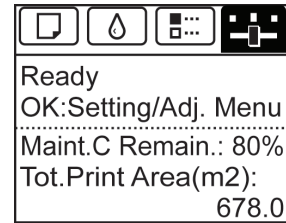

Note

- If the **Tab Selection screen** is not displayed, press the **Menu** button.

- 2 Press the **OK** button.
The **Set./Adj. Menu** is displayed.
- 3 Press ▲ or ▼ to select **Printer Info**, and then press the **OK** button.
- 4 Press ▲ or ▼ to select **System Info**, and then press the **OK** button.
The firmware version is displayed.

Updating the Firmware

To obtain the latest firmware, visit the Canon website. If the firmware available online is newer than the installed firmware, update the printer firmware. For details on downloading and updating the firmware, visit the Canon website.

Memo

Basic Printing Workflow	15
Enhanced Printing Options	29
Windows Software	157
Mac OS Software	267
Handling and Use of Paper	331
Control Panel	429
Printer Parts	467
Network Setting	481
Print Job Management	501
Adjustments for Better Print Quality	555
Maintenance and Consumables	573

Troubleshooting

Frequently Asked Questions	618
Problems Regarding Paper	619
Printing does not start	630
The printer stops during a print job	632
Problems with the printing quality	633
Cannot print over a network	642
Installation problems	643
HP-GL/2 problems	644
Other problems	646

Error Message	651
Specifications	673
Appendix	677

Frequently Asked Questions

Frequently Asked Questions

This section presents frequently asked questions and answers. To view more detailed explanations, click the hyperlinks in the answer column.

Question	Answer
I want to easily create vertical or horizontal banners.	You can print originals that are in landscape (or portrait) orientation automatically enlarged to fit the roll width. This is an easy way to create vertical or horizontal banners. (See "Printing Vertical or Horizontal Banners (Large-Format Printing).") →P.101
Does this printer support sub-ink tank system?	This printer supports sub-ink tank system. Even if an ink tank becomes empty during printing, since a certain amount of ink always is stored in a sub-ink tank, you can replace the ink tank while printing. (See "Replacing Ink Tanks.") →P.574
I want to know how to configure roll cutting.	You can select the cutting method by the setting of the printer driver and the setting of the printer. To cut rolls automatically after printing, set Cutting Mode of the printer to Automatic and Automatic Cutting of the printer driver to Yes . When using paper for which ink adhesion takes time or the print surface is easily scratched, we recommend that you set the Cutting Mode setting of the printer to Eject . (See "Specifying the Cutting Method for Rolls.") →P.360 (See "Cutting Roll Paper After Printing.") →P.152
I want to configure so that the roll is cut automatically after waiting for the ink to dry.	In the printer driver, you can set the time for waiting until the ink dries. Also, you can set likewise on the printer. (See "Specifying the Ink Drying Time for Rolls.") →P.358 (See "Menu Structure.") →P.443
How do I print without borders?	When printing on rolls, you can perform borderless printing by configuring the printer driver. (when printing on cut sheets, you cannot perform borderless printing) (See "Borderless Printing on Paper of Equivalent Size.") →P.92 (See "Borderless Printing by Resizing Originals to Fit the Roll Width.") →P.95 (See "Borderless Printing at Actual Size.") →P.87
I want to know the paper types that can be used in this printer.	Concerning the paper that can be used in this printer, refer to the Canon website or the Paper Reference Guide . (See "Displaying the Paper Reference Guide.") →P.335
The paper type that I want to print is not displayed on the Display Screen.	In order to use newly released paper, you need to register the media information in the printer and printer driver. Use the Media Configuration Tool to register the new media information. (See "Adding Media Types (Windows).") →P.391 (See "Adding Media Types (Mac OS).") →P.414
Can I perform duplex printing?	This printer cannot perform duplex printing. If you use the Folded Duplex function in the Free Layout of Windows software, you can print two pages one-sided, fold them at the center and suspend them to substitute for duplex printing. (See "Prints using Folded Duplex (Windows).") →P.220
I want to perform enlargement printing.	With the printer driver, you can specify the ratio matching the document with the paper size and width and perform enlargement printing or reduction printing. (See "Resizing Originals to Match the Paper Size.") →P.72 (See "Resizing Originals to Fit the Roll Width.") →P.74 (See "Resizing Originals by Entering a Scaling Value.") →P.78

Problems Regarding Paper

- Clearing Jammed Roll Paper 619
- Clearing a Jammed Sheet 622
- If There is a Paper Jam while Using the Stacker 624
- Troubleshooting When Paper Jams are not Found 625
- Roll paper cannot be inserted into the Paper Feed Slot 628
- Cannot load sheets 628
- Paper is not cut neatly 628
- Paper is not cut 628
- The Stacker continues to rotate 629
- The size of clear film cannot be detected 629

Clearing Jammed Roll Paper

If roll paper jams, follow the steps below to remove jams.



Note

- If you do not find any scraps or jams, see "Troubleshooting When Paper Jams are not Found." →P.625
- If the paper becomes jammed while ejecting to the stacker, see "If There is a Paper Jam while Using the Stacker." →P.624

1

Turn the printer off. (See "Turning the Printer On and Off.") →P.17

2

Open the Top Cover.

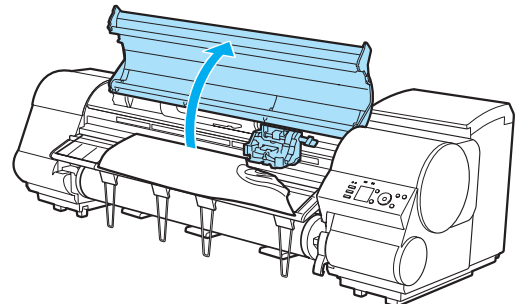

Note

- If the leading edge of the roll jams in the carriage such as when the paper curls strongly, you may be able to avoid paper jamming by setting the roll cutting method to Manual and setting the detection of paper leading edge to **Do not perform**. (See "Specifying the Cutting Method for Rolls.") →P.360

3

If the Carriage is out, move the Carriage out of the way, away from the paper.

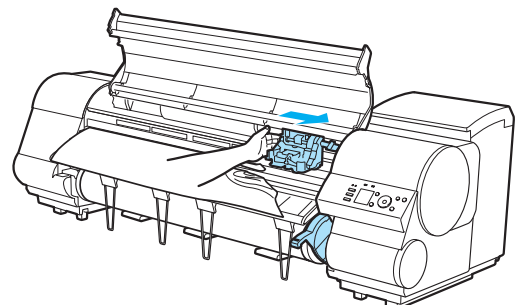



- Do not touch the Linear Scale (a), Carriage Shaft (b), or Ink Tube Stabilizer (c). Touching these parts may damage them.

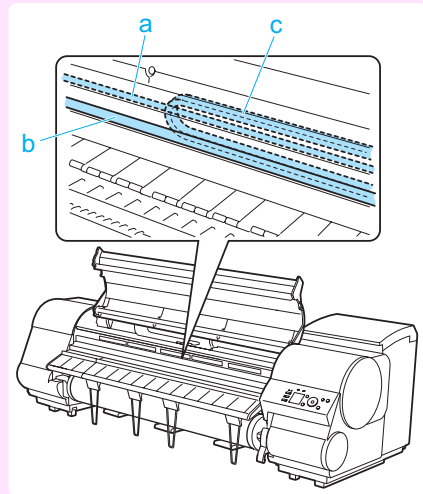

- 4** If the Cutter is out, move the Cutter to the right side, away from the paper.

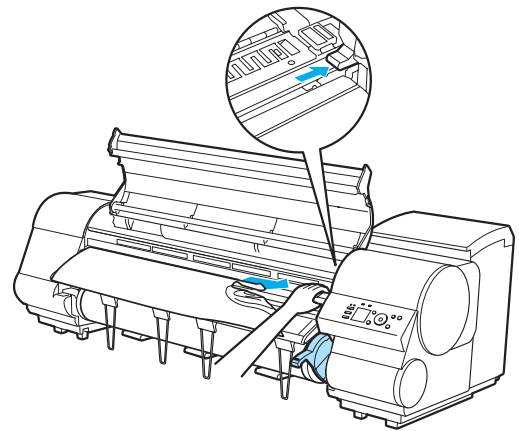

- If the Cutter is on the left side, be sure to move it to the right. If the Cutter is on the left side when you turn the printer on, the printer may rip the paper.

- 5** Lift the Release Lever.

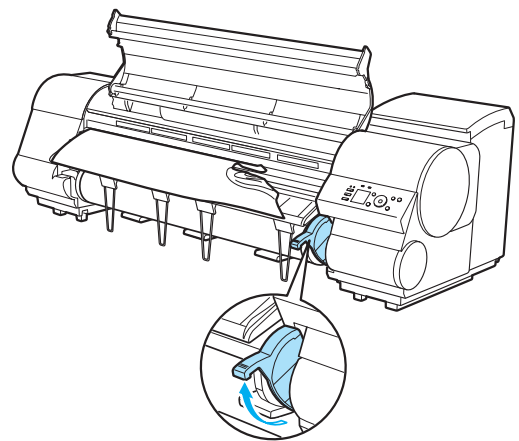

- 6 Holding the paper on both sides, pull the jammed portion out toward the front. Use a scissors or cutting tool to cut away the printed or wrinkled portion.

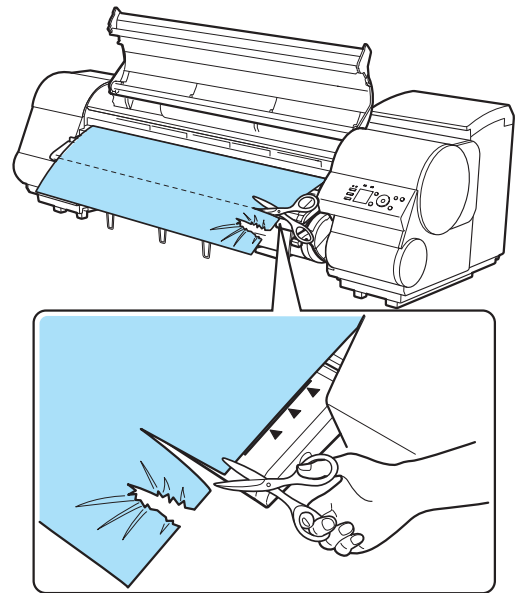

- When cutting paper, be careful to avoid injury and damaging the printer.

- 7 If the Carriage is on the left, move the Carriage to the right until it stops.

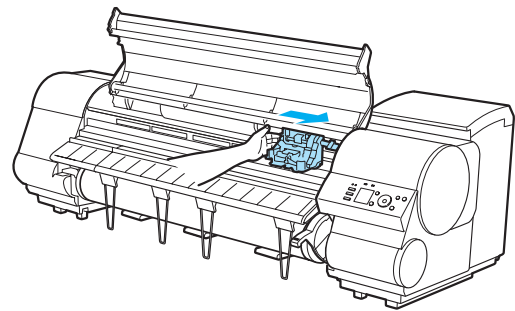

- Always move the Carriage to the right side. If the Carriage is on the left, a Carriage error may occur when you turn on the printer.

- 8 Hold the edge of the roll paper in the middle as you gently pull it evenly to the position of the Ejection Guide (a). Align the right side of the roll paper with the Paper Alignment Line (b), keeping this side parallel to the line, and then lower the Release Lever.

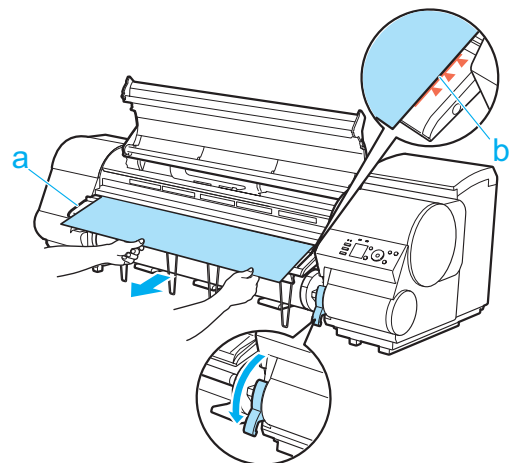

- Do not force the roll paper into alignment with the Paper Alignment Line (b). This may prevent the paper from being advanced straight.
- If you pull out too much of the roll, an excessive amount will be cut away.

9 Close the Top Cover.

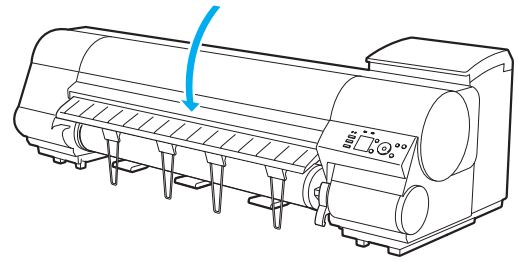

10 Turn the printer on. (See "Turning the Printer On and Off.") →P.17
The roll is now advanced. After it is finished being advanced, you can resume printing.



- You can ensure that the edge is cut neatly by selecting **Paper Cutting** in the printer menu. (See "Specifying the Cutting Method for Rolls.") →P.360

Clearing a Jammed Sheet

If a sheet jams, follow the steps below to remove it.

1 Turn the printer off. (See "Turning the Printer On and Off.") →P.17

2 Open the Top Cover.

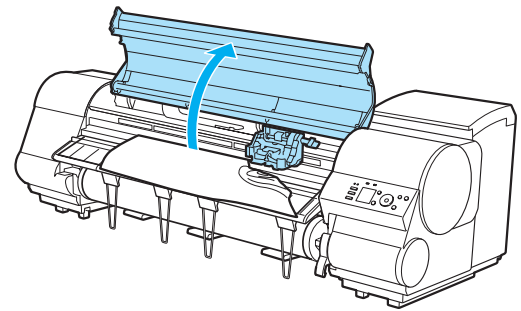

3 If the Carriage is out, move the Carriage out of the way, away from the paper.

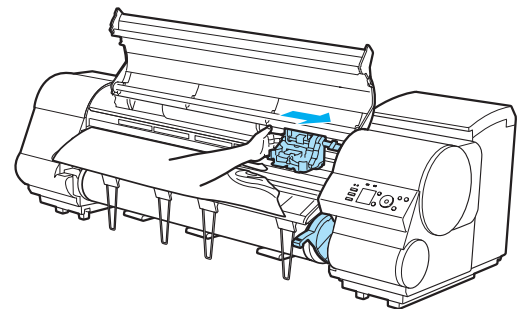

- Do not touch the Linear Scale (a), Carriage Shaft (b), or Ink Tube Stabilizer (c). Touching these parts may damage them.

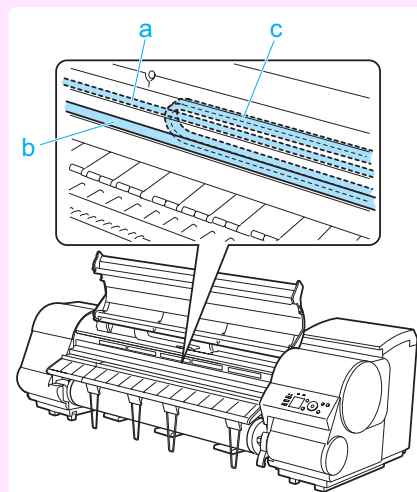

4 Lift the Release Lever.

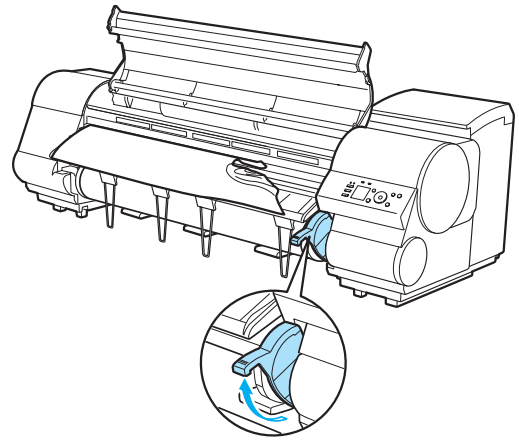

5 Hold the paper and pull it out, toward the front.

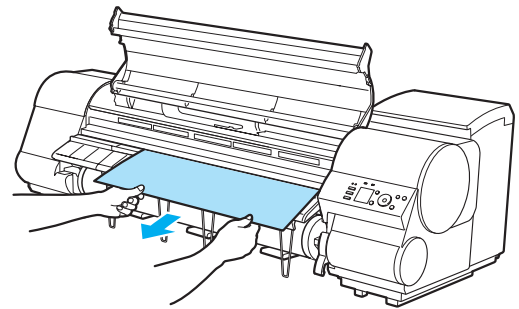

• If you do not find any scraps or jams, see "Troubleshooting When Paper Jams are not Found." →P.625

Note

6 If the Carriage is on the left, move the Carriage to the right until it stops.

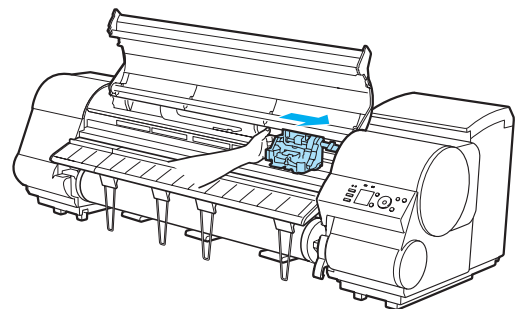

Important

• Always move the Carriage to the right side. If the Carriage is on the left, a Carriage error may occur when you turn on the printer.

7 Lower the Release Lever and close the Top Cover.

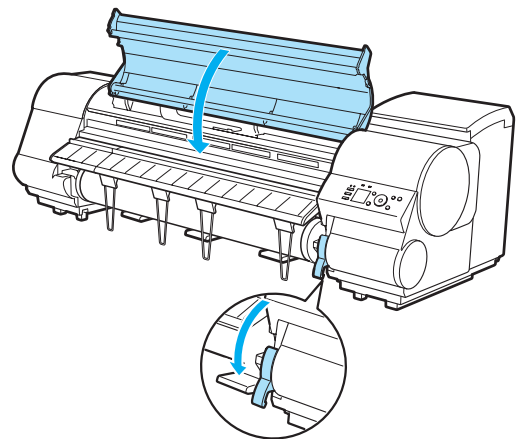

8 Turn the printer on. (See "Turning the Printer On and Off.") →P.17

If There is a Paper Jam while Using the Stacker

If there is a paper jam while ejecting paper to the stacker, clear the paper jam using the following procedure.

- 1** If any paper has already been ejected, open the canopy, clear the ejected paper, and close the canopy again.
- 2** Turn the stacker off.

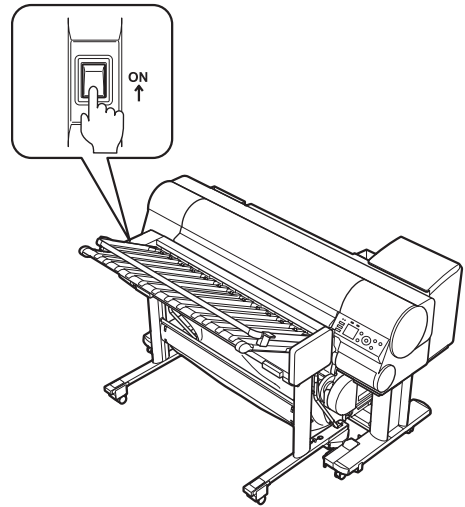

- 3** Check that the Stacker Canopy (a) is closed, and then unlock all of the casters on the Stacker stand.

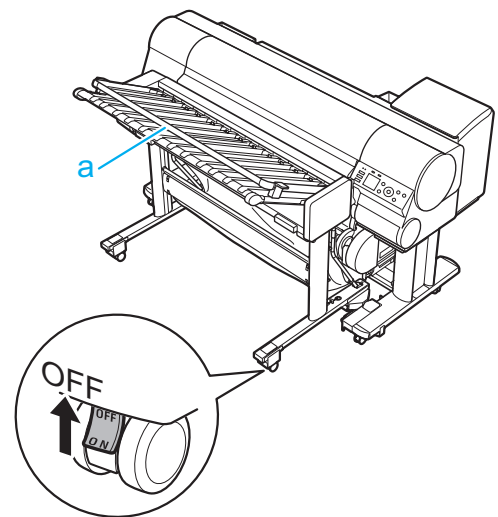

- 4** Turn the printer off. (See "Turning the Printer On and Off.") →P.17

- 5** Holding the stacker outer frame (a), pull the stacker and remove it away from the printer.

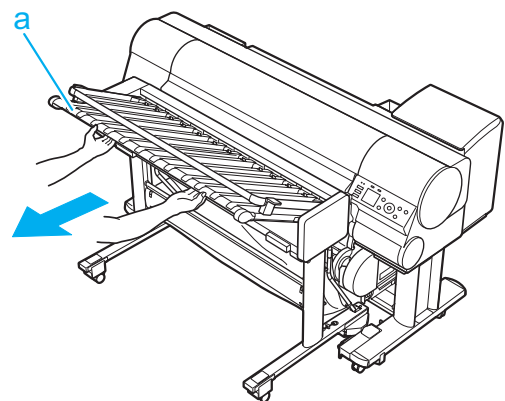

- 6** Use scissors or a cutting tool to cut the roll paper between the stacker and the printer.

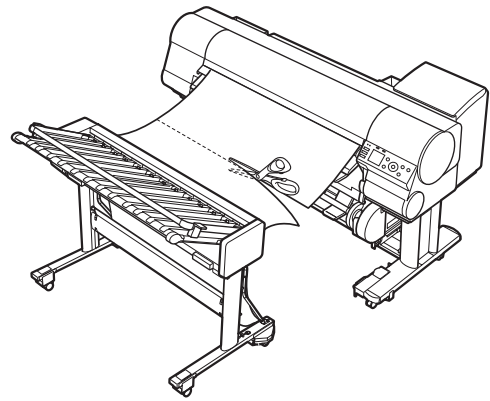

- 7** Open the Top Cover of the printer and the canopy of the stacker, and check the position where paper is jammed.

- If paper is jammed inside the Top Cover

- 1.** Pull the paper that remains in the stacker out from the printer side and close the canopy.

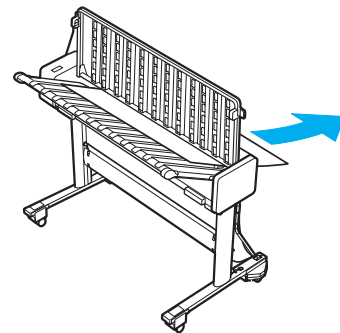

- 2.** Clear the roll paper jam by referring to step 3 and later in **Clearing Jammed Roll Paper** →P.619 .

- If the paper is jammed in the stacker

- 1.** Pull paper that is jammed in the stacker out from the opposite side to the printer and close the canopy.

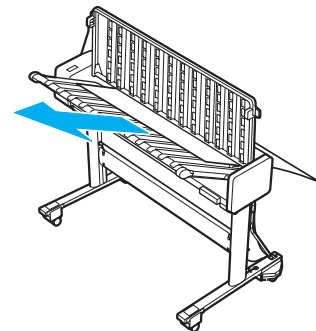

- 2.** Make it ready to print on roll paper by referring to step 7 and later in **Clearing Jammed Roll Paper** →P.619 .

Troubleshooting When Paper Jams are not Found

If you cannot find a paper jam, search for the paper as follows.

If the Stacker is installed on the printer, first remove the Stacker from the printer. (See "Installing and Removing the Stacker On the Printer.") →P.376

- 1** Turn the printer off. (See "Turning the Printer On and Off.") →P.17

2 Holding the Roll Unit Lever (a), pull out the Roll Unit.

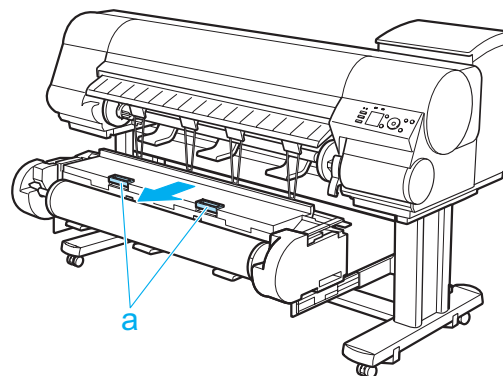

3 Open the Top Cover and lift the Ejection Guide.

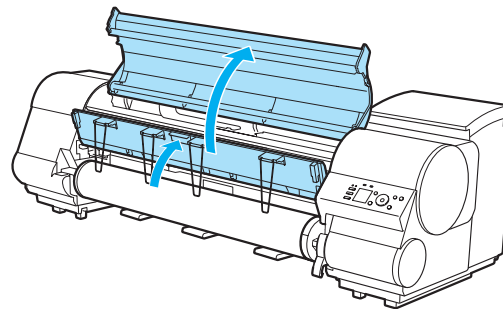

4 Check for paper in the lower part of the printer. Remove any jammed paper here by pushing it to the floor with your fingers.

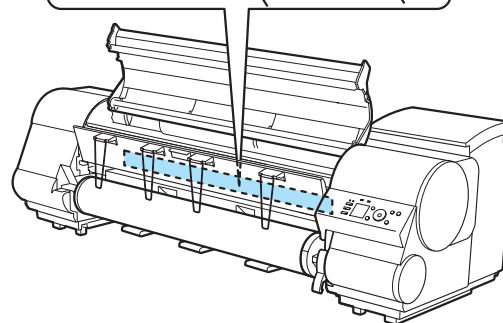
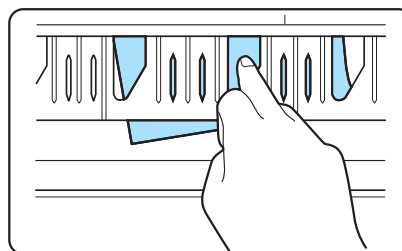

5 Lift the Release Lever.

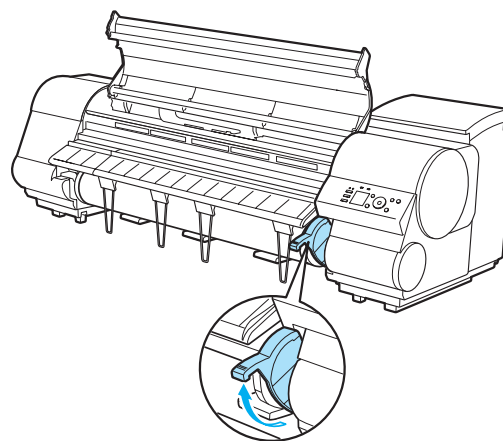

- 6** Open the Top Cover, and if there is a paper jam at the position shown, push it inside with your fingers.

The paper will drop to the floor or to the lower part of the printer.

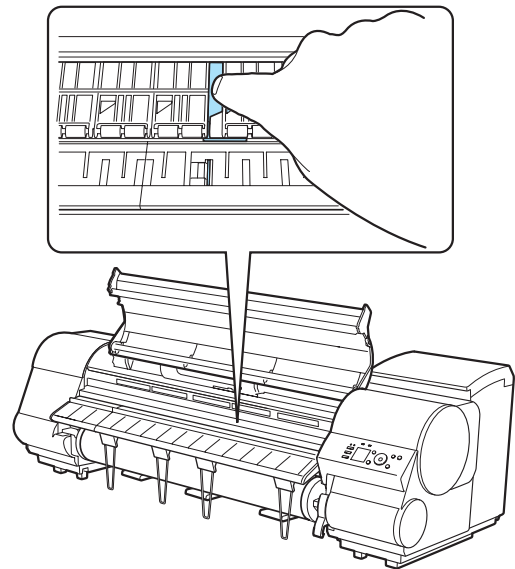

Note

- If paper remains in the lower part of the printer, push it to the floor with your fingers.
- If the paper does not drop to the floor or to the lower part of the printer, fold an A4 sheet three times, insert it through the gap of the Platen (a) and the Paper Retainer (b), and push the jammed paper out.

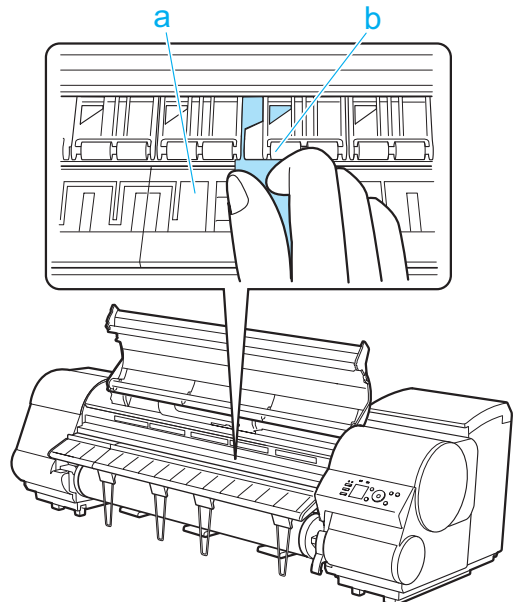

- 7** Lower the Release Lever and close the Top Cover.

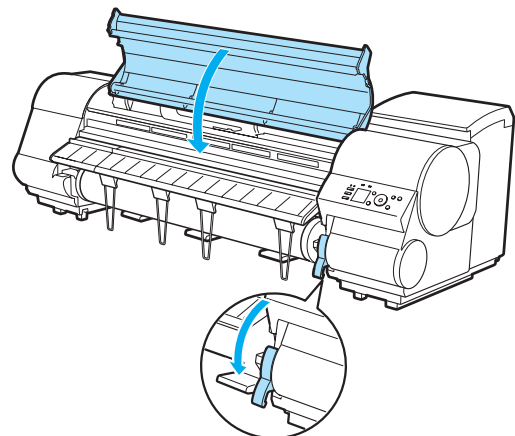

8 In a crouching position, push the Roll Unit in.

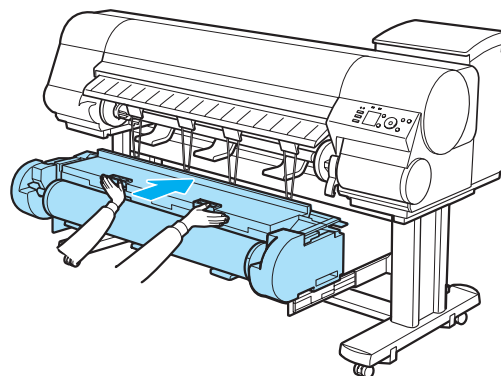

9 Turn the printer on. (See "Turning the Printer On and Off.") →P.17

Roll paper cannot be inserted into the Paper Feed Slot

Cause	Corrective Action
The roll paper is warped.	Straighten out curls and reload the roll.
Paper is jammed by the paper feed slot.	Remove the jammed paper. (See "Clearing Jammed Roll Paper.") →P.619 (See "Clearing a Jammed Sheet.") →P.622
The paper source selection is incorrect.	Press the Load button and select the paper source.
If paper cannot be advanced from Roll 2 (Lower), the Roll Unit Cable is disconnected.	Connect the Roll Unit Cable firmly to the Roll Unit Power Supply Inlet and the inlet on the roll unit.

Cannot load sheets

Cause	Corrective Action
The paper source selection is incorrect.	Press the Load button and select the paper source.

Paper is not cut neatly

Cause	Corrective Action
The paper is bent or curled at the cut position.	Straighten out any curling by the edges of the paper.
Paper rises by the ends of the cut position before it is cut.	Reload the paper correctly.
You are using paper that cannot be cut with the Cutter Unit.	Specify Manual in Cutting Mode in the Control Panel menu and use scissors or a cutting tool to cut the roll after printing. (See "Specifying the Cutting Method for Rolls.") →P.360
Cut Speed is not configured correctly in the Control Panel menu.	Change the Cut Speed setting in the Control Panel menu. (See "Menu Structure.") →P.443
During cutting, printed documents fall out at an angle.	In the Control Panel menu, set Cutting Mode to Eject . Hold documents after printing, as they are cut. (See "Specifying the Cutting Method for Rolls.") →P.360

Paper is not cut

Cause	Corrective Action
In the printer driver, No or Print Cut Guideline is specified in Automatic Cutting .	Specify Yes in Automatic Cutting in the printer driver. (See "Page Setup Sheet (Windows).") →P.177 (See "Paper Detailed Settings Dialog Box (Mac OS).") →P.276
In the Control Panel menu, Cutting Mode is set to Eject or Manual .	If the Cutting Mode is Eject , press the Cut button to cut the paper. If the Cutting Mode is Manual , cut rolls with scissors or the like. (See "Specifying the Cutting Method for Rolls.") →P.360

The Stacker continues to rotate

Cause	Corrective Action
The paper is not fed into the Stacker from the printer because of a paper jam, etc.	Turn the Stacker power switch off.

The size of clear film cannot be detected

Cause	Corrective Action
The Platen is soiled with ink or other substances.	Open the Top Cover and clean the entire Platen. (See "Cleaning Inside the Top Cover." →P.599)

Printing does not start

The Data lamp on the Control Panel does not light up	630
The printer does not respond even if print jobs are sent	630
Ink Filling.. is displayed	631
The display screen indicates Agitating	631

The Data lamp on the Control Panel does not light up

Cause	Corrective Action
The printer is not on.	Make sure the power cord is securely plugged in, all the way. Press the Power button to turn on the printer.
The target printer was not selected when printing.	<ul style="list-style-type: none"> In Windows, select the printer by clicking Select Printer or Printer in the printing dialog box and try printing again. In Mac OS, open the dialog box of the printer driver, select the printer from the list of Printer, and try printing again.
The print job is paused.	<ul style="list-style-type: none"> In Windows, restart the print job as follows. <ol style="list-style-type: none"> Click the printer icon in the Devices and Printers window. Click See what's printing to open a window. Click Pause Printing in the Printer menu to clear the check box. <p>Note, depending on the version, restart the print job as follows.</p> <ol style="list-style-type: none"> Right-click the printer icon in the Printers and Faxes (or Printers) window. Click Resume Printing in the menu. In Mac OS, restart the print job as follows. <ol style="list-style-type: none"> Click Print & Scan. (This is identified as Printers & Scanners or Print & Fax in other versions of Mac OS.) Choose the printer. Click Open Print Queue to open a window. Click Resume Printer (or Resume).

The printer does not respond even if print jobs are sent

Cause	Corrective Action
In the Control Panel menu, Pause Print is On .	Set Pause Print to Off . (See "Pausing Printing.") →P.27
In the Control Panel menu, Use USB or Use Ethernet is set to Off .	Set Use USB or Use Ethernet to On . (See "Menu Settings.") →P.449
You have selected Save in mail box in Output Method on the printer.	Print the job saved on the printer's hard disk. (See "Printing Saved Jobs.") →P.527
Print jobs are pending.	Manage the jobs on hold and print as needed. (See "Managing Pending Jobs (Printing or Deleting Jobs on Hold).") →P.525
The Stacker is not ready.	If " Stacker not ready. " or " Cutting Mode not Automatic. " is displayed on the Control Panel Display Screen, clear the error. (See "Stacker not ready..") →P.662 (See "Cutting Mode not Automatic..") →P.662
The Stacker position is incorrect.	To print using the Stacker, install the Stacker on the printer correctly. To print without using the Stacker, remove the Stacker from the printer. (See "Installing and Removing the Stacker On the Printer.") →P.376

Ink Filling.. is displayed

Cause	Corrective Action
The printer was forced off during operation.	Wait until the system has been filled with ink.

The display screen indicates Agitating

Cause	Corrective Action
Ink agitation is in progress.	Please wait until ink agitation is finished. The time for agitation varies depending on how long the printer has been off.

The printer stops during a print job

An error message is shown on the Display Screen	632
The printer ejects blank, unprinted paper	632
The printer stops when printing a HP-GL/2 job (the carriage stops moving)	645

An error message is shown on the Display Screen

Cause	Corrective Action
The last portion of roll paper was used during a print job, and paper could not be advanced because the trailing edge is taped to the roll.	Remove the used roll and insert a new roll. (See "Removing the Roll from the Printer.") → P.352 (See "Removing the Roll Holder from Rolls.") → P.356 (See "Loading and Printing on Rolls.") → P.18

The printer ejects blank, unprinted paper

Cause	Corrective Action
The leading edge of the roll paper was cut to straighten it.	The leading edge of rolls may be cut to straighten it if Trim Edge First is set to a value other than Off in the Control Panel menu. (See "Cutting the Leading Edge of Roll Paper Automatically.") → P.366
The Printhead nozzles are clogged.	Print a test pattern to check the nozzles and make sure the Printhead is in good condition for printing. (See "Checking for Nozzle Clogging.") → P.585
A print job was received from an incompatible printer driver.	Use the correct imagePROGRAF printer driver for the printer and try printing again.
The printer has received print data that includes HP RTL commands when Auto Rotate is On in the Control Panel menu.	In the Control Panel, set Auto Rotate to Off and print again. (See "Menu Settings.") → P.449
The printer is damaged.	Contact your Canon dealer for assistance.

Problems with the printing quality

Printing is faint	633
Paper rubs against the Printhead	634
The edges of the paper are dirty	634
The surface of the paper is dirty	635
The back side of the paper is dirty	635
Printed colors are inaccurate	635
Banding in different colors occurs	636
Colors in printed images are uneven	637
Image edges are blurred or white banding occurs	637
Setting the Blue Switch on the Platen	638
The contrast becomes uneven during printing	640
The length of printed images is inaccurate in the feeding direction	640
Images are printed crooked	641
Documents are printed in monochrome	641
Line thickness is not uniform	641
Lines are misaligned	641

Printing is faint

Cause	Corrective Action
You may be printing on the wrong side of the paper.	Print on the printing surface.
The Printhead nozzles are clogged.	<p>Print a test pattern to check the nozzles and see if they are clogged. (See "Checking for Nozzle Clogging.") →P.585</p> <p>To check for nozzles after printing, set Frequency in Nozzle Check in the Control Panel menu to a setting other than Off. Furthermore, to have a warning displayed depending on the result of the nozzle check, set Warning in Nozzle Check in the Control Panel menu to On. Note that when Warning is set to On, printing may stop depending on the content of the warning. (See "Menu Settings.") →P.449</p>
Because the printer was left without ink tanks installed for some time, ink has become clogged in the ink supply system.	After the ink tanks have been installed for 24 hours, run Head Cleaning B from the Control Panel. (See "Cleaning the Printhead.") →P.586
Paper is jammed inside the Top Cover.	<p>Follow the steps below to remove the jammed piece of paper inside the Top Cover.</p> <ol style="list-style-type: none"> 1. Open the Top Cover and make sure the Carriage is not over the Platen. 2. Remove any scraps of paper inside the Top Cover. (See "Clearing Jammed Roll Paper.") →P.619 (See "Clearing a Jammed Sheet.") →P.622 3. Close the Top Cover.
The ink was not dry when paper was cut.	Specify a longer drying period in the Control Panel menu, in Paper Details > Roll DryingTime . (See "Menu Settings.") →P.449
Printing may be faint if Print Quality in Advanced Settings in the printer driver is set to Standard or Fast .	In Advanced Settings of the printer driver, choose Highest or High in Print Quality . Printing in Fast or Standard mode is faster and consumes less ink than in Highest or High modes, but the printing quality is lower. (See "Giving Priority to Particular Graphic Elements and Colors for Printing.") →P.66
You are printing on paper that tends to generate dust when cut.	In the Control Panel menu, set CutDustReduct. in Paper Details to On . (See "Reducing Dust from Cutting Rolls.") →P.367

Paper rubs against the Printhead

Cause	Corrective Action
The type of paper specified in the printer driver does not match the type loaded in the printer.	Load paper of the same type as you have specified in the printer driver. (See "Loading Rolls in the Printer.") →P.345 (See "Loading Sheets in the Printer.") →P.369
	Make sure the same type of paper is specified in the printer driver as you have loaded in the printer. 1. Press the Stop button and stop printing. 2. Change the type of paper in the printer driver and try printing again.
Paper has been loaded incorrectly, causing it to wrinkle.	Reload the paper. (See "Loading Rolls in the Printer.") →P.345 (See "Loading Sheets in the Printer.") →P.369
The Printhead is set too low in the Control Panel menu.	In the Control Panel menu, set Head Height to Automatic . (See "Troubleshooting Paper Abrasion and Blurry Images.") →P.562
You are printing on heavyweight paper or paper that curls or wrinkles easily after absorbing ink.	For paper-based media such as Heavyweight Coated Paper, set the VacuumStrngth to Strong or Strongest in the Control Panel menu. If the paper still rubs against the printhead, set the Head Height in the Control Panel menu to a higher value than the current setting. (See "Adjusting the Vacuum Strength.") →P.570 (See "Troubleshooting Paper Abrasion and Blurry Images.") →P.562
	For film-based media such as Tracing Paper, set the VacuumStrngth to Standard , Strong or Strongest in the Control Panel menu. If the paper still rubs against the printhead, set the Head Height in the Control Panel menu to a higher value than the current setting. (See "Adjusting the Vacuum Strength.") →P.570 (See "Troubleshooting Paper Abrasion and Blurry Images.") →P.562
	When printing on paper 0.1 mm (0.004 in) thick or less, choose a VacuumStrngth setting of Weakest in the Control Panel menu. If rubbing still occurs, in the Control Panel menu, use a higher Head Height setting. (See "Adjusting the Vacuum Strength.") →P.570 (See "Troubleshooting Paper Abrasion and Blurry Images.") →P.562
When you have loaded paper, the paper you have loaded does not match the type selected on the Control Panel.	Be sure to select the correct type of paper in the Control Panel menu when loading paper. (See "Loading Rolls in the Printer.") →P.345 (See "Loading Sheets in the Printer.") →P.369

The edges of the paper are dirty

Cause	Corrective Action
The Platen has become dirty after borderless printing or printing on small paper.	Open the Top Cover and clean the Platen. (See "Cleaning Inside the Top Cover.") →P.599
The type of paper as specified on the printer does not match the type specified in the printer driver.	Make sure the same type of paper is specified on the printer as in the printer driver. (See "Changing the Type of Paper.") →P.350
	Make sure the same paper type is specified in the printer driver as on the printer. 1. Press the Stop button and stop printing. 2. Change the type of paper in the printer driver and try printing again.
The paper is wrinkled or warped.	Straighten out the wrinkles or curls and reload the paper. Do not use paper that has been printed on previously. (See "Loading Rolls in the Printer.") →P.345 (See "Loading Sheets in the Printer.") →P.369
A cut line is printed because CutDustReduct. is On in the Control Panel menu to reduce cutting dust.	If this function is not needed, set CutDustReduct. to Off in the Control Panel menu. (See "Menu Settings.") →P.449
The Printhead is set too low in the Control Panel menu.	In the Control Panel menu, set Head Height to Automatic . (See "Troubleshooting Paper Abrasion and Blurry Images.") →P.562

Cause	Corrective Action
You are printing on heavyweight paper or paper that curls or wrinkles easily after absorbing ink.	For paper-based media such as Heavyweight Coated Paper, set the VacuumStrngth to Strong or Strongest in the Control Panel menu. If the paper still rubs against the print-head, set the Head Height in the Control Panel menu to a higher value than the current setting. (See "Adjusting the Vacuum Strength.") →P.570 (See "Troubleshooting Paper Abrasion and Blurry Images.") →P.562
	For film-based media such as Tracing Paper, set the VacuumStrngth to Standard , Strong or Strongest in the Control Panel menu. If the paper still rubs against the print-head, set the Head Height in the Control Panel menu to a higher value than the current setting. (See "Adjusting the Vacuum Strength.") →P.570 (See "Troubleshooting Paper Abrasion and Blurry Images.") →P.562
The Ejection Guide is soiled.	Clean the Ejection Guide. (See "Cleaning the Printer Exterior.") →P.599

The surface of the paper is dirty

Cause	Corrective Action
The Paper Retainer is soiled.	Clean the Paper Retainer. (See "Cleaning Inside the Top Cover.") →P.599
You are using a paper that does not dry easily.	In the Control Panel menu, set Roll DryingTime to at least 1 min . (See "Menu Settings.") →P.449
	When paper that does not dry easily is used for printing, it may curl during printing and touch the Output Tray. In this case, in the Control Panel menu, complete the settings for Dry time and Area in Scan Wait Time . However, note that printing will now take longer. (See "Menu Settings.") →P.449
The Stacker is dirty.	Clean the Stacker. (See "Cleaning the Stacker.") →P.601

The back side of the paper is dirty

Cause	Corrective Action
The Platen has become dirty after borderless printing or printing on small paper.	Open the Top Cover and clean the Platen. (See "Cleaning Inside the Top Cover.") →P.599
	In the Control Panel menu, set CarriageScanWdth to Fixed . (See "Menu Settings.") →P.449
The Platen has become soiled because you have set Width Detection to Off in the Control Panel menu.	Set Width Detection to On in the Control Panel menu, and then open the Top Cover and clean the Platen. (See "Cleaning Inside the Top Cover.") →P.599
	Open the Top Cover and clean the Platen. After this, manually advance the roll onto the Platen before printing. (See "Cleaning Inside the Top Cover.") →P.599 (See "Feeding Roll Paper Manually.") →P.357
The Platen suction is too strong.	In the Control Panel menu, reduce the level of VacuumStrngth . (See "Adjusting the Vacuum Strength.") →P.570
The Stacker is dirty.	Clean the Stacker. (See "Cleaning the Stacker.") →P.601

Printed colors are inaccurate

Cause	Corrective Action
Color adjustment has not been activated in the Advanced Settings of the printer driver.	In the Advanced Settings of the printer driver, access Color Settings in Color Mode to adjust colors. (See "Main Sheet (Windows).") →P.166 (See "Main Pane (Mac OS).") →P.272

Cause	Corrective Action
Colors have not been adjusted on the computer or monitor.	Refer to the computer and monitor documentation to adjust the colors. Adjust the settings of the color management software, referring to the software documentation as needed.
The Printhead nozzles are clogged.	Print a test pattern to check the nozzles and see if they are clogged. (See "Checking for Nozzle Clogging.") →P.585
Application Color Matching Priority is set to Off in the Windows printer driver.	Click Special Settings in the Layout sheet of the printer driver, and set Application Color Matching Priority to On in the dialog box that is displayed. (See "Layout Sheet (Windows).") →P.182
Color may change slightly even on the same model of printer if you use a different version of the firmware or printer driver, or when you print under different settings or in a different printing environment.	Follow these steps to prepare the printing environment. 1. Use the same version of firmware or printer driver. 2. Specify the same value for all settings items.

Banding in different colors occurs

Cause	Corrective Action
The paper feed amount is out of adjustment.	Adjust the feed amount. (See "Adjusting the Feed Amount.") →P.564
If Head Posi. Adj. is executed with the Stacker installed on the printer, adjustment is not performed correctly.	Remove the Stacker from the printer and execute Head Posi. Adj. . (See "Installing and Removing the Stacker On the Printer.") →P.376 (See "Automatic Adjustment to Straighten Lines and Colors.") →P.556
If Adj. Quality is executed with the Stacker installed on the printer, adjustment is not performed correctly.	Execute Adj. Quality after feeding paper to the Stacker tray using the following procedure. 1. Press the Feed button. 2. Press the ▼ button to advance until the leading edge of the paper is ejected into the tray. (See "Installing and Removing the Stacker On the Printer.") →P.376 (See "Automatic Banding Adjustment.") →P.565 (See "Manual Banding Adjustment.") →P.566
Printing does not proceed smoothly because print jobs are interrupted during transmission.	Exit other applications and cancel other print jobs.
In the Control Panel menu, Adj. Priority is set to Print Length .	Setting Adj. Priority to Print Quality in the Control Panel menu and adjusting the feed amount may improve results. (See "Adjusting the Feed Amount.") →P.564
The Printhead is out of alignment.	Adjust the Printhead alignment. (See "Automatic Adjustment to Straighten Lines and Colors.") →P.556
The Printhead nozzles are clogged.	Print a test pattern to check the nozzles and see if they are clogged. (See "Checking for Nozzle Clogging.") →P.585
Streaks may occur if you set the Print Quality too low.	Choose a higher level of Print Quality in the Advanced Settings of the printer driver and try printing again. Printing in Fast or Standard mode is faster and consumes less ink than in Highest or High modes, but the printing quality is lower. (See "Giving Priority to Particular Graphic Elements and Colors for Printing.") →P.66
The type of paper specified in the printer driver does not match the type loaded in the printer.	Load paper of the same type as you have specified in the printer driver. (See "Loading Rolls in the Printer.") →P.345 (See "Loading Sheets in the Printer.") →P.369 Make sure the same type of paper is specified in the printer driver as you have loaded in the printer. 1. Press the Stop button and stop printing. 2. Change the type of paper in the printer driver and try printing again.

Colors in printed images are uneven

Cause	Corrective Action
Line Drawing/Text is selected when printing images in many solid colors.	In Print Priority in the Advanced Settings of the printer driver, choose Image .
You are printing on paper that curls easily.	Printed colors may appear uneven on the leading edge of paper that is susceptible to curling. Select a stronger level in VacuumStrength in the Control Panel menu to increase suction against the paper, or specify a leading margin of 20 mm (0.79 in) or more. (See "Adjusting the Vacuum Strength.") →P.570
Printed colors may be uneven if you set the Print Quality too low.	Choose a higher level of Print Quality in the Advanced Settings of the printer driver. Printing in Fast or Standard mode is faster and consumes less ink than in Highest or High modes, but the printing quality is lower. (See "Giving Priority to Particular Graphic Elements and Colors for Printing.") →P.66
Color may be uneven between dark and light image areas.	Select Unidirectional Printing in the Advanced Settings of the printer driver.
When borderless printing is used, the edge of the paper is cut during printing. Thus, ink density may be slightly uneven at the leading edges.	Specify No in Automatic Cutting in the printer driver before printing. In this case, the paper can be printed without borders on the left and right sides only. Cut the printed document ejected from the printer, and then use scissors or a cutting tool to cut away the edges on the top and bottom.
	Choose a higher level of Print Quality in the Advanced Settings of the printer driver. (See "Giving Priority to Particular Graphic Elements and Colors for Printing.") →P.66
The Printhead is out of alignment.	Adjust the Printhead alignment. (See "Automatic Adjustment to Straighten Lines and Colors.") →P.556
Allowing printed documents to dry on top of each other may cause uneven colors.	To avoid uneven colors, we recommend drying each sheet separately.
Density may be uneven if you use Glossy Paper or Coated Paper.	In Advanced Settings of the printer driver, choose Highest or High in Print Quality .
The type of paper specified in the printer driver does not match the type loaded in the printer.	Load paper of the same type as you have specified in the printer driver. (See "Loading Rolls in the Printer.") →P.345 (See "Loading Sheets in the Printer.") →P.369
	Make sure the same type of paper is specified in the printer driver as you have loaded in the printer. 1. Press the Stop button and stop printing. 2. Change the type of paper in the printer driver and try printing again.
Scan Wait Time > Area in the Control Panel menu is set to Leading edge .	When Scan Wait Time > Area is set to Leading edge , colors may be uneven 110–160 mm from the leading edge. (The position varies depending on the Print Quality setting.) In this case, select Scan Wait Time > Area > Entire area . However, note that printing will now take longer. (See "Menu Settings.") →P.449

Image edges are blurred or white banding occurs

Cause	Corrective Action
The Platen suction is too strong.	In the Control Panel menu, reduce the level of VacuumStrength . (See "Adjusting the Vacuum Strength.") →P.570
	Close the blue Switch on the platen so that it matches the paper size. (See "Setting the Blue Switch on the Platen.") →P.638
Incorrect Printhead alignment value.	In the Control Panel menu, set Head Height to a lower height. (See "Troubleshooting Paper Abrasion and Blurry Images.") →P.562
The type of paper specified in the printer driver does not match the type loaded in the printer.	Load paper of the same type as you have specified in the printer driver. (See "Loading Rolls in the Printer.") →P.345 (See "Loading Sheets in the Printer.") →P.369
	Make sure the same type of paper is specified in the printer driver as you have loaded in the printer. 1. Press the Stop button and stop printing.

Cause	Corrective Action
The type of paper specified in the printer driver does not match the type loaded in the printer.	2. Change the type of paper in the printer driver and try printing again.

Setting the Blue Switch on the Platen

If printed documents exhibit the following symptoms, adjust the setting of the blue Switch on the Platen.

- Image edges are blurred
- Image edges are affected by white banding



Important

- Always set all of the blue Switches on the Platen to the ● side for borderless printing. If the Switch are not set correctly, the print quality may deteriorate.

1 Remove the Stacker from the printer.
 (See "Installing and Removing the Stacker On the Printer.") →P.376

2 Remove any loaded paper that will not be used.

- Rolls (See "Removing the Roll from the Printer.") →P.352
- Sheet (See "Removing Sheets.") →P.373

3 Open the Top Cover.

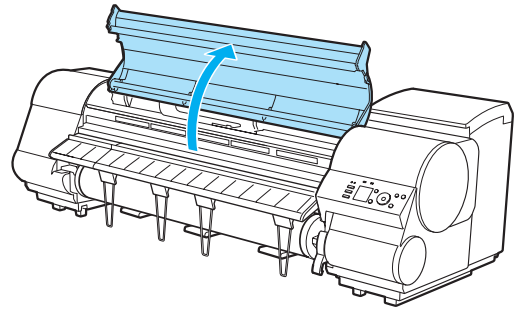

4 Remove the Cleaning Brush (a).

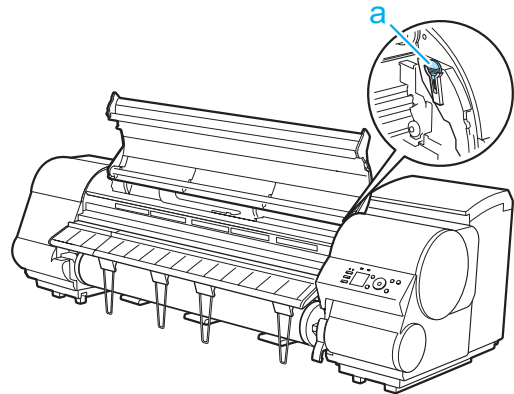

- 5 Using the back of the Cleaning Brush, move the first Switch to the side opposite ●.

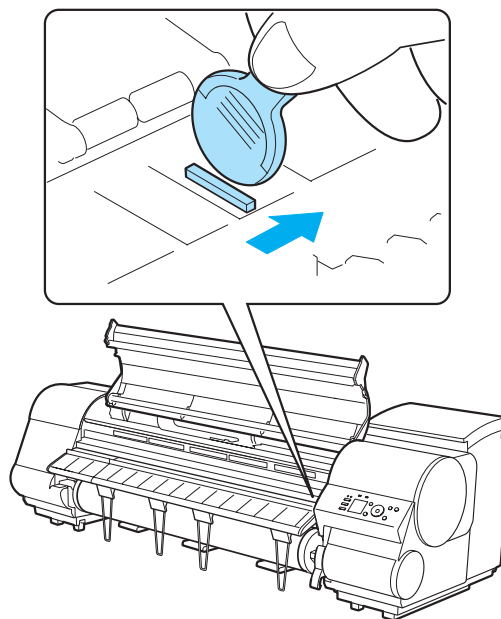

- 6 Refer to the following table to confirm the number on the Platen (a) that corresponds to the size of paper for printing.

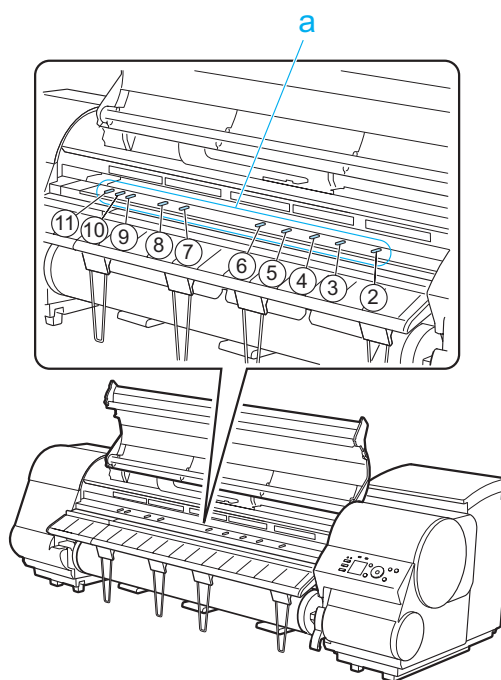

Number	Dimensions
2	254.0 mm (10.00 in)
3	355.6 mm (14.00 in)
4	431.8 mm (17.00 in)
5	515.0 mm (JIS B2 or B3)
6	594.0 mm (ISO A1 or A2) or 609.6 mm (24.00 in)
7	841.0 mm (ISO A0 or A1)
8	914.4 mm (36.00 in)
9	1030.0 mm (JIS B0 or B1)
10	1066.8 mm (42.00 in)
11	1117.6 mm (44.00 in)

7 Using the back of the Cleaning Brush, move the Switch to the side opposite ●, corresponding to the size of the paper for printing.

In this case, note that you will move the switch in the opposite direction from the direction in step 4.



- The Switch only moves number 1 and the number that matches the paper size. Set all of the switches where the number does not match the paper size in switches number 2 and higher to the ● side.

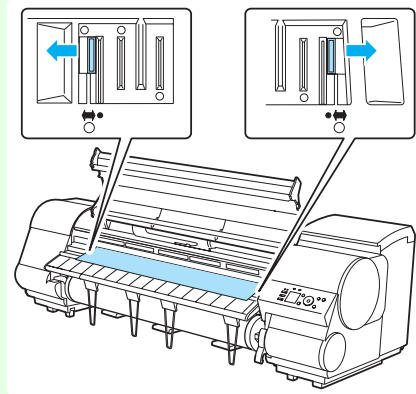

8 Close the Top Cover.

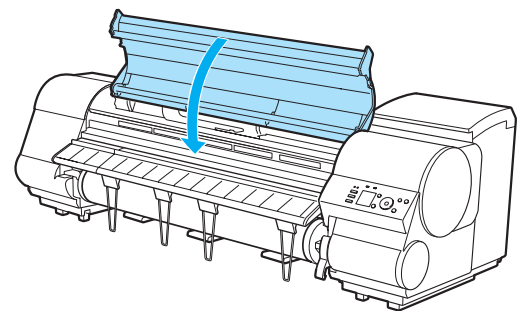

9 Install the Stacker on the printer.

(See "Installing and Removing the Stacker On the Printer." →P.376)

The contrast becomes uneven during printing

Cause	Corrective Action
The paper feed amount is out of adjustment.	Adjust the feed amount. (See "Adjusting the Feed Amount." →P.564)
The type of paper specified in the printer driver does not match the type loaded in the printer.	Load paper of the same type as you have specified in the printer driver. (See "Loading Rolls in the Printer." →P.345) (See "Loading Sheets in the Printer." →P.369) Make sure the same type of paper is specified in the printer driver as you have loaded in the printer. 1. Press the Stop button and stop printing. 2. Change the type of paper in the printer driver and try printing again.

The length of printed images is inaccurate in the feeding direction

Cause	Corrective Action
In the Control Panel menu, Adj. Priority is set to Print Quality .	Set Adj. Priority to Print Length in the Control Panel menu, and then execute Adjust Length . (See "Adjusting the Feed Amount." →P.564)
If Adjust Length is executed with the Stacker installed on the printer, adjustment is not performed correctly.	Remove the Stacker from the printer and execute Adjust Length . (See "Installing and Removing the Stacker On the Printer." →P.376) (See "Adjusting Line Length." →P.568)
The type of paper specified in the printer driver does not match the type loaded in the printer.	Load paper of the same type as you have specified in the printer driver. (See "Loading Rolls in the Printer." →P.345) (See "Loading Sheets in the Printer." →P.369)

Cause	Corrective Action
The type of paper specified in the printer driver does not match the type loaded in the printer.	<p>Make sure the same type of paper is specified in the printer driver as you have loaded in the printer.</p> <ol style="list-style-type: none"> 1. Press the Stop button and stop printing. 2. Change the type of paper in the printer driver and try printing again.

Images are printed crooked

Cause	Corrective Action
In the Control Panel menu, Skew Check Lv. is set to Loose or Off .	In the Control Panel menu, set Skew Check Lv. to Standard .
In the Control Panel menu, Width Detection is set to Off .	Set Width Detection to On in the Control Panel menu.

Documents are printed in monochrome

Cause	Corrective Action
In the Advanced Settings of the printer driver, Monochrome , Monochrome (BK ink) , or Monochrome Bitmap is specified in Color Mode .	In the Advanced Settings of the printer driver, specify Color in Color Mode and try printing again.
The Printhead nozzles are clogged.	Print a test pattern to check the color ink nozzles and see if they are clogged. (See "Checking for Nozzle Clogging.") →P.585

Line thickness is not uniform

Cause	Corrective Action
In the Special Settings dialog box of the Windows printer driver, Fast Graphic Process is set to On .	<p>Access the printer driver Properties dialog box from Print in the File menu of the source application, and follow these steps to print.</p> <ol style="list-style-type: none"> 1. Clear the option Open Preview When Print Job Starts on the Main sheet. 2. Clear the option Page Layout on the Layout sheet. 3. Click the Special Settings button in the Layout sheet, open the Special Settings dialog box, and set Fast Graphic Process to Off.
The type of paper specified in the printer driver does not match the type loaded in the printer.	<p>Load paper of the same type as you have specified in the printer driver. (See "Loading Rolls in the Printer.") →P.345 (See "Loading Sheets in the Printer.") →P.369</p> <p>Make sure the same type of paper is specified in the printer driver as you have loaded in the printer.</p> <ol style="list-style-type: none"> 1. Press the Stop button and stop printing. 2. Change the type of paper in the printer driver and try printing again.
The blue Switch on the platen is set incorrectly.	Move the Switch numbered corresponding to the size of paper for printing opposite to the ● position. (See "Setting the Blue Switch on the Platen.") →P.638

Lines are misaligned

Cause	Corrective Action
The Printhead alignment is not adjusted.	<p>Adjust the Printhead alignment. (See "Automatic Adjustment to Straighten Lines and Colors.") →P.556 (See "Manual Adjustment to Straighten Lines and Colors.") →P.558 (See "Adjusting Line Misalignment.") →P.560</p>
The type of paper specified in the printer driver does not match the type loaded in the printer.	<p>Load paper of the same type as you have specified in the printer driver. (See "Loading Rolls in the Printer.") →P.345 (See "Loading Sheets in the Printer.") →P.369</p> <p>Make sure the same type of paper is specified in the printer driver as you have loaded in the printer.</p> <ol style="list-style-type: none"> 1. Press the Stop button and stop printing. 2. Change the type of paper in the printer driver and try printing again.

Cannot print over a network

Cannot connect the printer to the network 642

Cannot print over a TCP/IP network 642

Cannot print over a Bonjour network 642

Cannot connect the printer to the network

Cause	Corrective Action
The Ethernet cable is not connected correctly to the printer's Ethernet port.	<ol style="list-style-type: none"> 1. Make sure the printer is connected to the network with the correct Ethernet cable, and then turn the printer on. For instructions on connecting the cable, refer to the Setup Guide. 2. Make sure the Link indicator is lit. <p>The top indicator is lit in green and the bottom indicator is lit in orange when the printer is connected via 1000Base-T.</p> <p>The top indicator is lit in green when the printer is connected via 100Base-TX.</p> <p>The bottom indicator is lit in orange when the printer is connected via 10Base-T.</p> <p>If the Link indicator is not lit, check the following points.</p> <ul style="list-style-type: none"> • Make sure the connection point is on. • Make sure the end of the Ethernet cable is connected correctly. Insert the Ethernet cable until it clicks and locks in place. • Make sure there is no problem with the Ethernet cable. If there is any problem, replace the Ethernet cable. • Check the communication mode with the connection point. Although the printer normally detects the communication mode and transmission rate of the communication point automatically (in auto negotiation mode), sometimes the communication point settings cannot be detected. In this case, configure the connection method manually, specifying the communication mode in use. (See "Configuring the Communication Mode Manually.") →P.495

Cannot print over a TCP/IP network

Cause	Corrective Action
The printer's IP address is not configured correctly.	Make sure the printer's IP address is configured correctly. (See "Configuring the IP Address Using imagePROGRAF Device Setup Utility.") →P.497 (See "Configuring the IP Address Using the Printer Control Panel.") →P.486
The printer's TCP/IP network settings are not configured correctly.	Make sure the printer's TCP/IP network settings are configured correctly. (See "Configuring the Printer's TCP/IP Network Settings With RemoteUI.") →P.490
The computer you are trying to print from is not configured correctly.	Make sure the computer's TCP/IP network settings are configured correctly. (See "Configuring the Printer Driver Destination (Windows).") →P.489 (See "Configuring the Destination in TCP/IP Networks (Mac OS).") →P.493

Cannot print over a Bonjour network

Cause	Corrective Action
The computer you are trying to print from is not configured correctly.	Make sure the computer is configured correctly. (See "Configuring the Destination for Bonjour Network (Mac OS).") →P.493
The computer and printer are not on the same network.	Due to the nature of Bonjour, you cannot print if the printer is on another network behind a router. Make sure the computer and printer are on the same network. For information about network settings, ask your network administrator.

Troubleshooting

Cannot print over a network

Installation problems

Removing Installed Printer Drivers

Follow these steps to remove installed printer drivers and utilities.

Removing printer drivers (Windows)

Remove the printer driver as follows.



Note

- The following procedure is for Windows 7. The method of removing printer drivers varies depending on the version of Windows.

- From the Windows **start** menu, select **All Programs > Canon Printer Uninstaller > imagePROGRAF Printer Driver Uninstaller** to display the **Delete Printer** window.
- Select the printer in the list and click **Delete**.
- Click **Yes** after the **Warning** message is displayed.
- Make sure that the printer has been removed from the list, and then click **Exit**.

Removing imagePROGRAF Status Monitor (Windows)

Remove imagePROGRAF Status Monitor as follows.



Note

- The following procedure is for Windows 7. The method of removing printer drivers varies depending on the version of Windows.

- Select **Control Panel** from the **start** menu.
- Select **Uninstall a program**.

Note

- If the **User Account Control** dialog box is displayed, click **Yes**.
- Select **imagePROGRAF Status Monitor**, and then click the **Uninstall** button.

Removing imagePROGRAF Device Setup Utility (Windows)

Remove imagePROGRAF Device Setup Utility as follows.



Note

- The following procedure is for Windows 7. The method of removing printer drivers varies depending on the version of Windows.

- Select **Control Panel** from the **start** menu.
- Select **Uninstall a program**.

Note

- If the **User Account Control** dialog box is displayed, click **Yes**.
- Select **imagePROGRAF Device Setup Utility**, and then click the **Uninstall** button.

HP-GL/2 problems

With HP-GL/2, printing is misaligned	644
Lines or images are missing in printed HP-GL/2 jobs	644
Lines are printed too thick or thin in HP-GL/2 print jobs	644
HP-GL/2 jobs are printed in monochrome (or color)	644
Printed colors of lines are inaccurate during HP-GL/2 printing	645
HP-GL/2 jobs are printed 6 mm larger than specified	645
HP-GL/2 jobs are printed at maximum size, even if a standard size is specified	645
HP-GL/2 printing takes a long time	645
The printer stops when printing a HP-GL/2 job (the carriage stops moving)	645

With HP-GL/2, printing is misaligned

Cause	Corrective Action
The plotter origin is incorrect.	Check the printing commands. Set Detect img size to Command priority or Detected size in the Control Panel menu. (See "Menu Settings.") →P.449
The Margin setting in the Control Panel menu is incorrect.	Adjust the Margin setting values in the Control Panel menu. (See "Menu Settings.") →P.449

Lines or images are missing in printed HP-GL/2 jobs.

Cause	Corrective Action
The memory is full.	Check the size of the data in the print job.
An HP-GL/2 command not supported by this printer was received.	Check the print job and settings.
The printer has received print data that includes HP RTL commands when Auto Rotate is On in the Control Panel menu.	In the Control Panel, set Auto Rotate to Off and print again. (See "Menu Settings.") →P.449
The plotter origin is incorrect.	Set Detect img size to Command priority or Detected size in the Control Panel menu. (See "Menu Settings.") →P.449
Oversize in the Control Panel menu is set to Off .	Set Oversize to On in the Control Panel menu. (See "Menu Settings.") →P.449

Lines are printed too thick or thin in HP-GL/2 print jobs

Cause	Corrective Action
The Width setting in the Control Panel menu is incorrect.	Change the Width setting configured in Pen no. of the Palette A or Palette B selected in the Control Panel menu. (See "Menu Settings.") →P.449
ThickenFineLines in the Control Panel menu is set to Off .	If fine lines are printed faintly, setting ThickenFineLines to On will print the lines more distinctly. (See "Menu Settings.") →P.449
The Ln wdth correct setting in the Control Panel menu is incorrect.	Change the Ln wdth correct setting in the Control Panel menu. (See "Menu Settings.") →P.449

HP-GL/2 jobs are printed in monochrome (or color)

Cause	Corrective Action
The Color Mode setting in the Control Panel menu is incorrect.	Check the Color Mode setting in the Control Panel menu. (See "Menu Settings.") →P.449 However, for optimal Printhead performance, the printer consumes trace amounts of color ink even when Monochrome is selected as Color Mode .

Printed colors of lines are inaccurate during HP-GL/2 printing

Cause	Corrective Action
AdjustFaintLines is On in the Control Panel menu.	Setting AdjustFaintLines to Off in the Control Panel menu may help produce the expected results. However, lines in some colors may appear broken.

HP-GL/2 jobs are printed 6 mm larger than specified

Cause	Corrective Action
The page size of the HP-GL/2 print job, as created in the source application, is incorrect.	In the Control Panel menu, set Oversize to Off . (See "Menu Settings.") →P.449

HP-GL/2 jobs are printed at maximum size, even if a standard size is specified

Cause	Corrective Action
The page size of the HP-GL/2 print job, as created in the source application, is incorrect.	Set Detect img size to Command priority or Detected size in the Control Panel menu. (See "Menu Settings.") →P.449
	Set Conserve Paper to On in the Control Panel menu. (See "Menu Settings.") →P.449

HP-GL/2 printing takes a long time

Cause	Corrective Action
Large print jobs with a lot of data take longer to print.	Please wait a while until printing is finished.
A job was printed when Input Resolution in the Control Panel menu was set to 600dpi .	In the Control Panel menu, set Input Resolution to 300dpi and print again. (See "Menu Settings.") →P.449

The printer stops when printing a HP-GL/2 job (the carriage stops moving)

Cause	Corrective Action
The printer is analyzing the print job.	Please wait a while until printing is finished.
A job was printed when Input Resolution in the Control Panel menu was set to 600dpi .	In the Control Panel menu, set Input Resolution to 300dpi and print again. (See "Menu Settings.") →P.449

Other problems

The printer does not go on	646
Cannot operate from the Control Panel	646
The printer takes time to start up	646
If the Printer Makes a Strange Sound	647
Messages advising to check the maintenance cartridge are not cleared	647
The printer consumes a lot of ink	647
Ink Level Detection	647

The printer does not go on

Cause	Corrective Action
The printer is unplugged.	Plug the power cord into the outlet, and then turn on the printer.
The specified voltage is not supplied.	Check the voltage of the outlet and breaker. (See "Specifications.") →P.674

Cannot operate from the Control Panel

Cause	Corrective Action
The control panel access lock is set.	Release the control panel access lock. (See "Setting Control panel access lock.") →P.465

The printer takes time to start up

Cause	Corrective Action
The printer may have shut down incorrectly last time. This may happen after power outages or if the printer is unplugged before it is turned off. In this case, the next time power is restored, the printer's hard disk is checked, and startup may take some time.	Please wait a while, because it may take several minutes to finish checking the hard disk. If an error message is displayed after the hard disk check, follow the instructions indicated to resolve the problem.

If the Printer Makes a Strange Sound

Cause	Corrective Action
The printer makes a sound during operation.	<p>The following sounds do not indicate a problem with the printer.</p> <ul style="list-style-type: none"> • There is a sound of suction from the Platen To prevent paper from rising, paper is held against the Platen by suction from Vacuum holes under it. • There is a sound when a different size of paper is used and when the Carriage goes from side to side When paper of a different size is used, a valve is automatically activated to switch the area for paper suction, which may make a sound. This mechanism prevents suction from Vacuum holes where there is no paper. In addition, ink is ejected in sync with the movement of the Carriage back and forth to ensure optimal ink flow. At this time, the valve automatically switches the area for paper suction, which may make a sound. • Roll paper makes a fluttering sound during printing There may be a fluttering sound when large paper is advanced. • If you suddenly hear the tone for cleaning operations At regular intervals, for printer maintenance, cleaning operations will begin automatically, even if the printer is in Sleep mode. • If you suddenly hear the tone for ink agitation At regular intervals, to ensure optimal printing quality, the ink is agitated automatically, even if the printer is in Sleep mode. The ink is also agitated automatically under the following conditions. Note that other operations are not possible while "Agitating" is displayed on the control panel. <ul style="list-style-type: none"> • After the printer is turned on <p>In other cases, contact your Canon dealer.</p>

Messages advising to check the maintenance cartridge are not cleared

Cause	Corrective Action
The printer has not detected the new Maintenance Cartridge that was used to replace the old one.	Remove the new Maintenance Cartridge you have just installed and insert it again firmly. (See " Replacing the Maintenance Cartridge. ") →P.593

The printer consumes a lot of ink

Cause	Corrective Action
Many full-page color images are printed.	In print jobs such as photos, images are filled with color. This consumes a lot of ink. This does not indicate a problem with the printer.
Head Cleaning B in the Control Panel menu is executed frequently.	Head Cleaning B in the Control Panel menu consumes a lot of ink. This does not indicate a problem with the printer. Unless the printer has been moved or stored for a long period or you are troubleshooting Printhead problems, we recommend not performing Head Cleaning B , to the extent possible.
You have just finished initial installation, when more ink is consumed to fill the system.	After initial installation or at the first-time use after transfer, ink flows into the system between the Ink Tank and Printhead. Although the amount of remaining ink may drop as a result, it does not indicate a problem.
The Printhead nozzles are clogged.	Check for nozzle clogging. (See " Checking for Nozzle Clogging. ") →P.585

Ink Level Detection

Ink level detection will be deactivated if you load ink tanks once emptied.

Ink level detection

Ink tanks specified for this printer feature an ink level detection function to prevent the ink from running out during printing, which prevents printer damage. (See "**Ink Tanks.**") →P.574

This function will not work correctly if you use refill ink tanks. As a result, printing stops. Thus, before using refill ink tanks, you must cancel the ink level detection.

Printing with the ink level detection canceled may lead to printer damage and printing problems. Canon Inc. is not liable for any damage that may occur as a result of refilling ink.



- After ink level detection has been released, this function cannot be reactivated for currently loaded Ink Tank. To use ink level detection again, replace the Ink Tank with new ones specified for use with the printer.
- Repeatedly removing and inserting an Ink Tank may damage the connection between the Ink Tank and the printer, which may cause ink leakage from the Ink Tank and damage the printer.

Releasing ink level detection

1 On the Display Screen, a message indicates that the ink level cannot be detected. After checking the message, press the ► button.

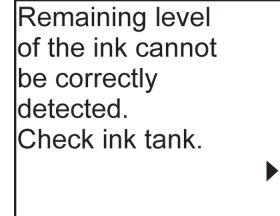

2 Press ▲ or ▼ to select **Information**, and then press the **OK** button.

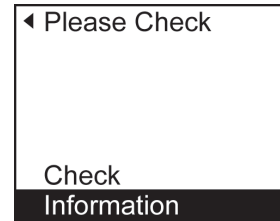

3 A confirmation message is shown on the Display Screen about releasing ink level detection. After checking the message, press the ► button.

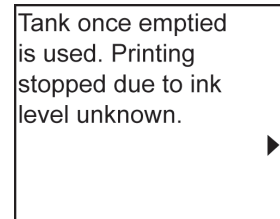

4 After checking the message, press the ► button.

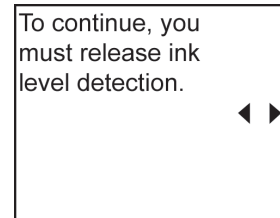

5 Press ▲ or ▼ to select **Yes**, and then press the **OK** button.

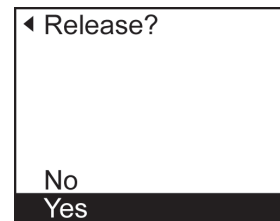

6 Check the message and press the ► button.

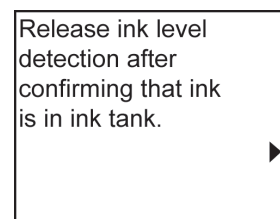

7 Check the message and press the ► button.

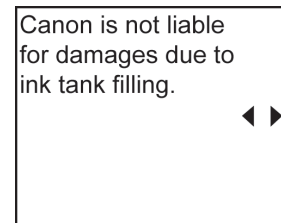

8 Press ▲ or ▼ to select **Yes**, and then press the **OK** button.



9 A confirmation message about updating ink information is shown on the Display Screen. After checking the message, press the ► button.

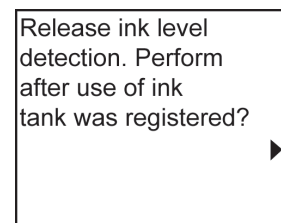

10 Press ▲ or ▼ to select **Yes**, and then press the **OK** button.

Ink level detection is now released.

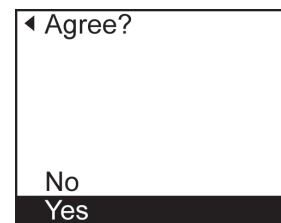

Memo

Basic Printing Workflow	15
Enhanced Printing Options	29
Windows Software	157
Mac OS Software	267
Handling and Use of Paper	331
Control Panel	429
Printer Parts	467
Network Setting	481
Print Job Management	501
Adjustments for Better Print Quality	555
Maintenance and Consumables	573
Troubleshooting	617

Error Message

Error Messages	652
Messages regarding paper	654
Messages regarding ink	663
Messages regarding printing or adjustment	665
Messages regarding printheads	666
Messages regarding the maintenance cartridge	668
Messages regarding the hard disk	669
Messages regarding HP-GL/2	670
Other Messages	671

Specifications	673
Appendix	677

Error Messages

Before borderless printing, move the blue platen switch.	665
Blue platen switch is dirty.	665
Borderless printing not possible.	661
Borderless printing not possible. Paper stretched or shrank.	665
Cannot adjust printhead.	666
Cannot print as selected. Another roll is in use.	657
Cannot print as specified.	665
Cannot recognize print head.	666
Check printed document.	665
Close Ink Tank Cover	663
Cutting Mode not Automatic.	662
End of paper feed.	661
ERROR Exxx-xxxx (x represents a letter or number)	671
Execute printhead cleaning.	667
File read error.	669
GARO Wxxxx (x represents a number)	671
GL2: W0502 The parameter is out of range.	670
GL2: W0504 This command is not supported.	670
GL2: Wxxxx The memory is full. (xxxx is 0501, 0903, or 0904)	670
Hard disk error.	669
Hardware error. xxxxxxxx-xxxx (x represents a letter or number)	671
Ink insufficient.	663
Ink tank is empty.	663
Insert the maintenance cartridge.	668
Insufficient paper for job	656
Mail box full. Delete unwanted data	669
Mail box full. Now printing without saving data.	669
Mail box nearly full.	669
Maint. cart. The level is low	668
Maintenance cartridge full.	668
Maintenance cartridge problem.	668
Maximum jobs stored.	669
MediaType Mismatch	654
Move the blue platen switch No.xx to the right. (xx represents a number)	665
Multi-sensor error	672
No ink left.	663
No ink tank loaded.	664
No Maintenance Cartridge capacity.	668
No Roll Unit.	658
Not much ink is left.	664
Paper cutting failed.	660
Paper jam.	659
Paper loaded askew.	660
Paper position not suitable for borderless printing.	662
Paper size not detected.	656
PapTypeMismatch	654
PapWidth Mismatch	655
Parts replacement time has passed.	672
Prepare for parts replacement.	672
Printhead error	666
Regular printing is selected, but a roll is loaded.	659

Rel lever is in wrong position.	661
Remaining level of the ink cannot be correctly detected. Check ink tank.	663
Roll feed unit error.	662
Roll printing is selected, but sheets are loaded.	657
Roll printing is selected.	657
Roll x is empty. (x is 1 (Upper) or 2 (Lower))	658
Roll x is selected. (x is 1 (Upper) or 2 (Lower))	657
Roll x jam (x is 1 (Upper) or 2 (Lower))	660
Sheet printing is selected.	659
Sheet removed.	659
Stacker not ready.	662
The following ink tanks cannot be recognized.	664
The mail box is full.	669
The paper is too small.	655
The paper is too small.	655
The roll feed unit is loose.	662
This paper cannot be used as size is not supported.	657
This type of paper is not compatible with HP-GL/2.	670
Top cover is open.	671
Unknown file.	672
Wrong ink tank.	664
Wrong maintenance cartridge.	668
Wrong printhead.	666

Messages regarding paper

MediaType Mismatch	654
PaprTypeMismatch	654
The paper is too small.	655
The paper is too small.	655
PaprWidth Mismatch	655
Paper size not detected.	656
Insufficient paper for job	656
This paper cannot be used as size is not supported.	657
Cannot print as selected. Another roll is in use.	657
Roll printing is selected.	657
Roll printing is selected, but sheets are loaded.	657
Roll x is selected. (x is 1 (Upper) or 2 (Lower))	657
Roll x is empty. (x is 1 (Upper) or 2 (Lower))	658
No Roll Unit.	658
Sheet removed.	659
Sheet printing is selected.	659
Regular printing is selected, but a roll is loaded.	659
Paper jam.	659
Roll x jam (x is 1 (Upper) or 2 (Lower))	660
Paper loaded askew.	660
Paper cutting failed.	660
End of paper feed.	661
Rel lever is in wrong position.	661
Borderless printng not possible.	661
Paper position not suitable for borderless printing.	662
Roll feed unit error.	662
The roll feed unit is loose.	662
Stacker not ready.	662
Cutting Mode not Automatic.	662

Error Message

Messages regarding paper

MediaType Mismatch

Cause	Corrective Action
You tried to print a test pattern for printer adjustment on several sheets, but sheets of different types of paper were used.	<p>When printing a test pattern for adjustment, use sheets of the same type of paper, in the required quantity. Replace the paper as follows and perform adjustment again.</p> <ol style="list-style-type: none"> 1. Lift the Release Lever and stop printing. 2. Replace the paper. (See "Loading and Printing on Sheets.") →P.21 3. Execute adjustment again from the control panel menu.
When Detect Mismatch in the Control Panel menu is set to Warning , the type of paper loaded does not match the type specified in the printer driver.	You can continue to print, but note that this error may cause paper jams or problems in the printing results.

PaprTypeMismatch

Cause	Corrective Action
When Detect Mismatch in the Control Panel menu is set to Pause , the type of paper loaded does not match the type specified in the printer driver.	<p>Follow these steps to ensure the paper type matches on the printer and in the printer driver.</p> <ol style="list-style-type: none"> 1. Press ▲ or ▼ to select Stop Printing, and then press the OK button.

Cause	Corrective Action
When Detect Mismatch in the Control Panel menu is set to Pause , the type of paper loaded does not match the type specified in the printer driver.	<ol style="list-style-type: none"> Change the paper type setting in the printer driver to the type loaded in the printer and try printing again.
	<p>Follow these steps to ensure the paper type matches on the printer and in the printer driver.</p> <ol style="list-style-type: none"> Press ▲ or ▼ to select Change Paper, and then press the OK button. Replace the loaded paper with paper of the type and size you have specified in the printer driver. (See "Loading and Printing on Rolls.") →P.18 (See "Loading and Printing on Sheets.") →P.21
	<p>Press ▲ or ▼ to select Print, and then press the OK button to resume printing. However, note that this error may cause paper jams and affect the printing quality.</p>

The paper is too small.

Cause	Corrective Action
When Detect Mismatch in the Control Panel menu is set to Pause or Hold Job , paper smaller than the size specified in the printer driver is loaded.	<p>Press ▲ or ▼ to select Print, and then press the OK button to resume printing. However, note that this error may cause paper jams and affect the printing quality.</p>
	<p>Adjust the paper size setting in the printer driver to match the size loaded in the printer as follows.</p> <ol style="list-style-type: none"> Press ▲ or ▼ to select Stop Printing, and then press the OK button. Change the paper size setting in the printer driver to the size loaded in the printer and try printing again.
	<p>Replace the loaded paper with paper of a size that matches the size setting in the printer driver as follows.</p> <ol style="list-style-type: none"> Press ▲ or ▼ to select Change Paper, and then press the OK button to stop printing. Replace the loaded paper to match the settings in the printer driver and try printing again. (See "Loading and Printing on Rolls.") →P.18 (See "Loading and Printing on Sheets.") →P.21
When Detect Mismatch in the Control Panel menu is set to Warning , paper smaller than the size specified in the printer driver is loaded.	You can continue to print, but note that this error may cause problems in the printing results.

The paper is too small.

"Replace paper with A4/LTR (vertical) or larger"

Cause	Corrective Action
The loaded paper is too small. (When you have attempted to print a test print sheet or other printer status information.)	<p>Replace the paper with paper of A4/Letter (vertical) size or larger as follows.</p> <ol style="list-style-type: none"> Press ▲ or ▼ to select Change Paper, press the OK button, and remove the paper. (See "Removing Sheets.") →P.373 Switch to paper A4/Letter (vertical) or larger. (See "Loading and Printing on Sheets.") →P.21 The printer will resume printing.
	Press ▲ or ▼ to select Stop Printing , and then press the OK button.

PaprWidth Mismatch

Cause	Corrective Action
When Detect Mismatch in the Control Panel menu is set to Pause or Hold Job , the width of the loaded roll does not match the width specified in Fit Roll Paper Width in the printer driver.	<p>Press ▲ or ▼ to select Print, and then press the OK button to resume printing. However, note that this error may cause paper jams and affect the printing quality.</p>

Cause	Corrective Action
<p>When Detect Mismatch in the Control Panel menu is set to Pause or Hold Job, the width of the loaded roll does not match the width specified in Fit Roll Paper Width in the printer driver.</p>	<p>Press ▲ or ▼ to select Stop Printing, and then press the OK button.</p> <p>Follow these steps to replace the roll to match the width specified in the printer driver.</p> <ol style="list-style-type: none"> 1. Press ▲ or ▼ to select Change Paper, and then press the OK button. (See "Removing the Roll from the Printer.") →P.352 (See "Removing the Roll Holder from Rolls.") →P.356 2. Replace with paper of the width configured in the printer driver. (See "Attaching the Roll Holder to Rolls.") →P.342 (See "Loading Rolls in the Printer.") →P.345 The printer now starts printing the print job. <p>Make sure the roll width selected in the dialog box displayed when you select Fit Roll Paper Width in the printer driver matches the width of the roll loaded in the printer, and then try printing again.</p>

Paper size not detected.

Cause	Corrective Action
<p>Paper has been loaded askew, or warped paper has been loaded.</p>	<p>Lift up the Release Lever and reload the paper. (See "Loading Rolls in the Printer.") →P.345 (See "Loading Sheets in the Printer.") →P.369</p> <p>If "Not finished printing. Finish printing remaining jobs?" is displayed on the Display Screen, press the OK button. Printing will resume, starting from the page on which the error occurred.</p> <p>If this error recurs after you reload the roll, remove the Roll Holder from the printer, push the roll firmly in until it touches the Roll Holder flange, and reload the Roll Holder in the printer. (See "Attaching the Roll Holder to Rolls.") →P.342</p>
<p>Because the Platen is soiled with ink or other substances, the size of the clear film cannot be detected.</p>	<p>Open the Top Cover and clean the entire Platen. (See "Cleaning Inside the Top Cover.") →P.599</p>

Insufficient paper for job

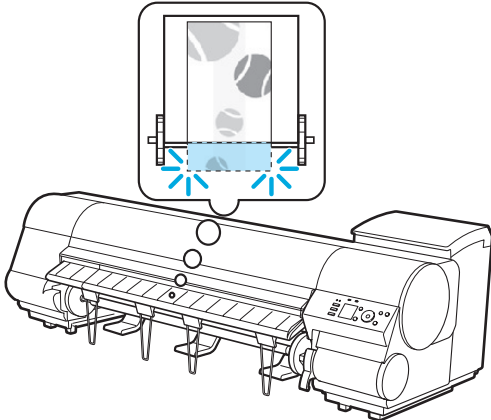
Cause	Corrective Action
<p>The printer has received a print job longer than the amount of roll paper left when ManageRemainRoll in the Control Panel menu is On.</p> 	<p>Press ▲ or ▼ to select Print, and then press the OK button to resume printing. However, the roll paper may run out during the print job and you may not be able to print all of the document.</p> <p>Press ▲ or ▼ to select Change Paper, and then press the OK button to stop printing. (See "Removing the Roll from the Printer.") →P.352 (See "Loading Rolls in the Printer.") →P.345</p> <p>Press ▲ or ▼ and select Stop Printing or press the Stop button to stop printing.</p>

This paper cannot be used as size is not supported.

Cause	Corrective Action
Paper that is too large for the printer has been loaded.	Lift the Release Lever and load paper of the correct size. (See "Paper Sizes.") →P.332
Paper that is too small for the printer has been loaded.	Lift the Release Lever and load paper of the correct size. (See "Paper Sizes.") →P.332
Paper has been loaded that is too small to print the test pattern for printhead adjustment or nozzle checking.	Lift the Release Lever and load unused paper A4/Letter (vertical) or larger. More than one sheet may be required depending on the adjustment.

Cannot print as selected. Another roll is in use.

Cause	Corrective Action
A printed document remains in the Output Tray without being cut and a print job was received that specifies the other roll.	Press the OK button to stop printing. Cut the printed document. (See "Specifying the Cutting Method for Rolls.") →P.360 Load the other roll and resend the print job. (See "Loading and Printing on Rolls.") →P.18

Roll printing is selected.

Cause	Corrective Action
You have attempted to print on a roll, but no roll is loaded.	Press ▲ or ▼ to select " Load Roll Paper ", and then press the OK button. Load the roll, and then print. (See "Attaching the Roll Holder to Rolls.") →P.342 (See "Loading Rolls in the Printer.") →P.345
	Press ▲ or ▼ and select Stop Printing or press the Stop button to stop printing.

Roll printing is selected, but sheets are loaded.

Cause	Corrective Action
A print job for rolls was received when a sheet is loaded.	Follow these steps to load and print on a roll. 1. Press ▲ or ▼ to select Eject Cut Sheet , press the OK button, and remove the sheet. (See "Removing Sheets.") →P.373 2. Load a new roll. (See "Loading Rolls in the Printer.") →P.345 The printer now starts printing the print job.
	Press ▲ or ▼ to select Stop Printing , and then press the OK button.

Roll x is selected. (x is 1 (Upper) or 2 (Lower))

Cause	Corrective Action
The indicated roll is specified for a print job sent from a computer, but that roll is not loaded.	Press ▲ or ▼ to select " Load Roll Paper ", and then press the OK button. Load the roll, and then print. (See "Attaching the Roll Holder to Rolls.") →P.342 (See "Loading Rolls in the Printer.") →P.345
	Press ▲ or ▼ and select Stop Printing or press the Stop button to stop printing.

Roll x is empty. (x is 1 (Upper) or 2 (Lower))

Cause	Corrective Action
The tailing edge of the paper was detected because cut sheets were loaded in the roll paper Paper Feed Slot.	<p>Follow these steps to install the roll paper.</p> <ol style="list-style-type: none"> 1. Press the OK button and remove the paper. 2. Load the new roll. (See "Attaching the Roll Holder to Rolls.") → P.342 (See "Loading Rolls in the Printer.") → P.345 3. If no barcode was printed on the roll, specify the type of paper. (See "Changing the Type of Paper.") → P.350 4. If no barcode was printed on the roll, specify the paper length. (See "Specifying the Paper Length.") → P.352 5. If "Not finished printing. Finish printing remaining jobs?" is shown on the Display Screen, press the OK button. Printing will resume, starting from the page on which the error occurred.

"Lift the release lever and replace the roll."

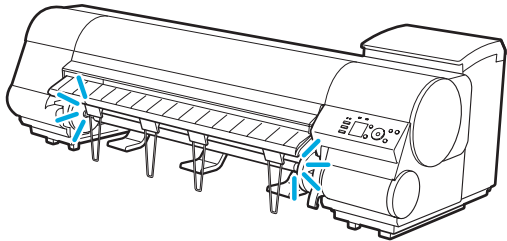
Cause	Corrective Action
<p>The roll is empty.</p> 	<p>Follow these steps to replace the used roll with a new roll of the same type and size.</p> <ol style="list-style-type: none"> 1. Lift the Release Lever and remove the roll. (See "Removing the Roll from the Printer.") → P.352 (See "Removing the Roll Holder from Rolls.") → P.356 2. Load the new roll. (See "Attaching the Roll Holder to Rolls.") → P.342 (See "Loading Rolls in the Printer.") → P.345 3. If no barcode was printed on the roll, specify the type of paper. (See "Changing the Type of Paper.") → P.350 4. If no barcode was printed on the roll, specify the paper length. (See "Specifying the Paper Length.") → P.352 5. If "Not finished printing. Finish printing remaining jobs?" is shown on the Display Screen, press the OK button. Printing will resume, starting from the page on which the error occurred.
There is remaining roll paper, but because it could not be advanced, it could not be detected.	<p>The unused portion of the roll is heavy, and this is placing a burden on the printer. It may be helpful to change the printing mode, which will change the paper feed timing. Choose a higher level of Print Quality in the Advanced Settings of the printer driver. (See "Giving Priority to Particular Graphic Elements and Colors for Printing.") → P.66</p>

No Roll Unit.

Cause	Corrective Action
The printer has received a print job that specifies Roll 2 (Lower), but the Roll Unit is not installed.	<p>Press the Stop button and stop printing.</p> <ol style="list-style-type: none"> 1. Turn the printer off and install the Roll Unit. Connect the Roll Unit Cable firmly and completely. 2. Turn the printer on and resend the print job.

Sheet removed.

Cause	Corrective Action
A sheet has come out of the printer during printing.	<ol style="list-style-type: none"> 1. Lift the Release Lever and remove the paper. 2. If "Not finished printing. Finish printing remaining jobs?" is shown on the Display Screen, press the OK button. Printing will resume, starting from the page on which the error occurred.

Sheet printing is selected.

Cause	Corrective Action
You have attempted to print on a sheet, but no sheet is loaded.	<p>Press ▲ or ▼ to select Load Paper, and then press the OK button. Load a sheet, and then print. (See "Loading and Printing on Sheets.") →P.21</p> <p>Press ▲ or ▼ and select Stop Printing or press the Stop button to stop printing.</p>

Regular printing is selected, but a roll is loaded.

Cause	Corrective Action
A print job for printing on sheets was sent when a roll is loaded.	<ol style="list-style-type: none"> 1. Press ▲ or ▼ to select Remove Roll Paper, and then press the OK button to stop printing. 2. After removing the roll, load and print on a sheet of the type and size of paper you have specified in the printer driver. (See "Removing the Roll from the Printer.") →P.352 (See "Loading and Printing on Sheets.") →P.21 <p>Press ▲ or ▼ to select Stop Printing, and then press the OK button to stop printing.</p>

Paper jam.

"Lift the release lever."

Cause	Corrective Action
A paper jam occurred in the printer during printing.	<ol style="list-style-type: none"> 1. Lift the Release Lever and remove the jammed paper. (See "Clearing Jammed Roll Paper.") →P.619 (See "Clearing a Jammed Sheet.") →P.622 2. If "Not finished printing. Finish printing remaining jobs?" is shown on the Display Screen, press the OK button. Printing will resume, starting from the page on which the error occurred.

"Manually rewind the roll all the way and press OK."

Cause	Corrective Action
A paper jam occurred when advancing the paper.	<ol style="list-style-type: none"> 1. Rewind paper on the Roll Holder manually, all the way, and then press the OK button. 2. If "Not finished printing. Finish printing remaining jobs?" is shown on the Display Screen, press the OK button. Printing will resume, starting from the page on which the error occurred.

"Lift the release lever and remove the paper."

Cause	Corrective Action
A paper jam occurred in the printer during printing.	<p>Lift the Release Lever and remove the jammed paper. (See "Clearing Jammed Roll Paper.") →P.619 (See "Clearing a Jammed Sheet.") →P.622</p>

Roll x jam (x is 1 (Upper) or 2 (Lower))

"Lift the release lever."

Cause	Corrective Action
A paper jam occurred in the printer during printing.	<ol style="list-style-type: none"> Lift the Release Lever and remove the jammed paper. (See "Clearing Jammed Roll Paper.") → P.619 (See "Clearing a Jammed Sheet.") → P.622 If "Not finished printing. Finish printing remaining jobs?" is shown on the Display Screen, press the OK button. Printing will resume, starting from the page on which the error occurred.

"Manually rewind the roll all the way and press OK."

Cause	Corrective Action
A paper jam occurred when advancing the paper.	<ol style="list-style-type: none"> Rewind paper on the Roll Holder manually, all the way, and then press the OK button. If "Not finished printing. Finish printing remaining jobs?" is shown on the Display Screen, press the OK button. Printing will resume, starting from the page on which the error occurred.

Paper loaded askew.

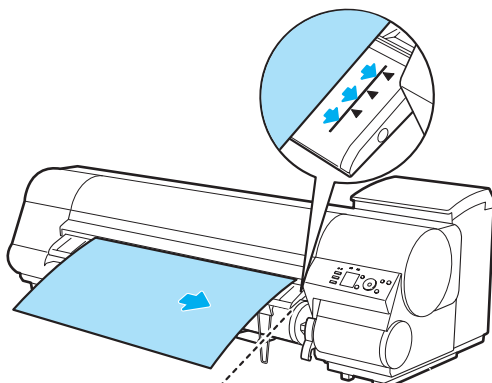
Cause	Corrective Action
<p>Paper loaded crooked was detected when the paper was advanced.</p> 	<p>Lift up the Release Lever and reload the paper. (See "Loading Rolls in the Printer.") → P.345 (See "Loading Sheets in the Printer.") → P.369</p> <p>If this error recurs after you reload the roll, remove the Roll Holder from the printer, push the roll firmly in until it touches the Roll Holder flange, and reload the Roll Holder in the printer. (See "Attaching the Roll Holder to Rolls.") → P.342</p>



Important

- To disable this message (if it is displayed repeatedly despite reloading paper, for example), choose **Off** or **Loose** in the **Skew Check Lv.** setting of the printer menu. However, this may cause jams and printing problems because paper may be askew when printed. Also, the Platen may become soiled, which may soil the back of the next document when it is printed.

Paper cutting failed.

Cause	Corrective Action
There are sheets left on the Ejection Guide.	<ol style="list-style-type: none"> Lift the Release Lever and remove the paper. If "Not finished printing. Finish printing remaining jobs?" is shown on the Display Screen, press the OK button. Printing will resume, starting from the page on which the error occurred.
There is a foreign object by the Output Tray, obstructing the Cutter Unit.	<ol style="list-style-type: none"> Lift the Top Cover and remove the foreign object. If "Not finished printing. Finish printing remaining jobs?" is shown on the Display Screen, press the OK button. Printing will resume, starting from the page on which the error occurred.
You are not using the printer under the recommended environmental conditions for the paper.	Use the printer only where the recommended environmental conditions for the paper are met. Note that various environmental conditions are recommended for various types of paper. For details on the recommended environmental conditions for paper, see the Paper Reference Guide . (See "Displaying the Paper Reference Guide.") → P.335

Cause	Corrective Action
You are using paper that is not compatible with automatic cutting.	Specify Manual as the cutting method and cut the roll manually. (See "Specifying the Cutting Method for Rolls.") →P.360 For information about paper that is compatible with automatic cutting, see the Paper Reference Guide . (See "Displaying the Paper Reference Guide.") →P.335
The Cutter Unit stops in the middle of cutting.	If the Carriage is out, move the Carriage out of the way, away from the paper. If the Cutter is out, move the Cutter to the right side (away from the paper) and remove the jammed paper. (See "Clearing Jammed Roll Paper.") →P.619 If the paper cannot be cut using the Cutter Unit, specify Manual as the roll cutting method and cut the roll manually. (See "Specifying the Cutting Method for Rolls.") →P.360
In other cases, the Cutter Unit may be damaged.	Contact your Canon dealer for assistance.

End of paper feed.

Cause	Corrective Action
Although an attempt was made to advance the paper manually, it reached the limit position that can be advanced.	Canceling manual advancing. (See "Feeding Roll Paper Manually.") →P.357

Rel lever is in wrong position.

Cause	Corrective Action
The Release Lever is up.	Lower the Release Lever. If the error occurs again, turn off the printer and wait a while before restoring power.

Borderless printing not possible.

Cause	Corrective Action
The print job received specifies a type or width of paper that is not compatible with borderless printing.	Follow these steps to change the settings of the print job to enable borderless printing. 1. Press ▲ or ▼ to select Stop Printing , and then press the OK button. 2. Make sure the correct printer driver for the printer is selected and try printing again. For information on types of paper compatible with borderless printing, refer to the Paper Reference Guide . (See "Displaying the Paper Reference Guide.") →P.335 Press ▲ or ▼ to select Print With Border , and then press the OK button to continue printing. The document will be printed with a border.
The loaded paper is a size not compatible with borderless printing.	Press ▲ or ▼ to select Stop Printing , and then press the OK button. Replace the paper with paper compatible for borderless printing as follows. 1. Press ▲ or ▼ to select Change Paper , and then press the OK button. (See "Removing the Roll from the Printer.") →P.352 (See "Removing the Roll Holder from Rolls.") →P.356 2. Replace the paper with paper compatible for borderless printing. (See "Attaching the Roll Holder to Rolls.") →P.342 (See "Loading Rolls in the Printer.") →P.345 The printer now starts printing the print job. For information on types of paper compatible with borderless printing, refer to the Paper Reference Guide . (See "Displaying the Paper Reference Guide.") →P.335 Press ▲ or ▼ to select Print With Border , and then press the OK button to continue printing. The document will be printed with a border.
Because paper expands or contracts depending on the environment of use, it may become narrower or wider than the supported width for borderless printing.	Use each type of paper only where the recommended environmental conditions are met. For details on environmental conditions for various paper, see the Paper Reference Guide . (See "Displaying the Paper Reference Guide.") →P.335

Paper position not suitable for borderless printing.

Cause	Corrective Action
Because paper expands or contracts depending on the environment of use, it may become narrower or wider than the supported width for borderless printing.	Press ▲ or ▼ to select Stop Printing , and then press the OK button. Use each type of paper only where the recommended environmental conditions are met. For details on environmental conditions for various paper, see the Paper Reference Guide . (See "Displaying the Paper Reference Guide.") →P.335
The paper is loaded askew.	Press ▲ or ▼ to select Change Paper and straighten the paper so that the edges are between the ink grooves for borderless printing. Insert the roll firmly until it touches the flange of the Roll Holder. (See "Attaching the Roll Holder to Rolls.") →P.342
	Press ▲ or ▼ to select Print With Border , and then press the OK button to continue printing. The document will be printed with a border.
	Press ▲ or ▼ to select Stop Printing , and then press the OK button.

Roll feed unit error.

Cause	Corrective Action
There is a problem with the Roll Unit.	Turn off the printer and wait at least three seconds before restoring the power. If the message is displayed again, contact your Canon dealer for assistance.

The roll feed unit is loose.

Cause	Corrective Action
The Roll Unit is detached from the printer.	Push the Roll Unit firmly all the way in.

Stacker not ready.

Cause	Corrective Action
The Stacker is not ready.	When printing using the Stacker, check the following. <ul style="list-style-type: none"> • The Stacker Power is on. • The Stacker is installed in the right position on the Printer. Once the preparation is finished, start printing by pressing ▲ or ▼ to select " Print ".
	When printing without using the Stacker, prepare the following. <ul style="list-style-type: none"> • Remove the Stacker from the Printer. Move the Stacker sufficiently far away from the Printer. Once the preparation is finished, start printing by pressing ▲ or ▼ to select " Print ".
	Stop printing by pressing ▲ or ▼ to select " Stop Printing ".

Cutting Mode not Automatic.

Cause	Corrective Action
The Stacker is ready to be used, however, the Printer Cutting Mode is not set to Automatic Cut . Or Automatic Cutting is not set to Yes in the Printer Driver.(*1)	After removing the Stacker, start printing by pressing ▲ or ▼ to select " Print again ". Stop printing by pressing ▲ or ▼ to select CANCELED . Set Cutting Mode to Automatic Cut in the Control Panel menu and then print again. Alternatively, set Automatic Cutting to Yes in the Printer Driver and then print again.(*2)

*1:This is for Windows.For Mac OS, it is not set to **Printer Default**.

*2:This is for Windows.For Mac OS, set to **Printer Default** and then print again.

Messages regarding ink

Ink insufficient.	663
No ink left.	663
Remaining level of the ink cannot be correctly detected. Check ink tank.	663
Close Ink Tank Cover	663
Ink tank is empty.	663
Not much ink is left.	664
No ink tank loaded.	664
The following ink tanks cannot be recognized.	664
Wrong ink tank.	664

Ink insufficient.

Cause	Corrective Action
The ink level is low, so you cannot print, clean the Printhead, or do other operations that require ink. There is not enough ink of the color with ✕ displayed above the remaining ink indicator.	Press the OK button, open the Ink Tank Cover, and replace the Ink Tank for the color that does not have enough ink. (See "Replacing Ink Tanks.") →P.574

No ink left.

Cause	Corrective Action
There is no ink left. There are no ink colors with ✕ displayed above the remaining ink indicator.	Press the OK button, open the Ink Tank Cover, and replace the Ink Tank for the color that is out of ink. (See "Replacing Ink Tanks.") →P.574

Remaining level of the ink cannot be correctly detected. Check ink tank.

Cause	Corrective Action
Ink level detection cannot work correctly if you use refill ink tanks.	The refill ink tank can no longer be used. See the section Ink level detection and take the appropriate action. (See "Ink Level Detection.") →P.647

Close Ink Tank Cover

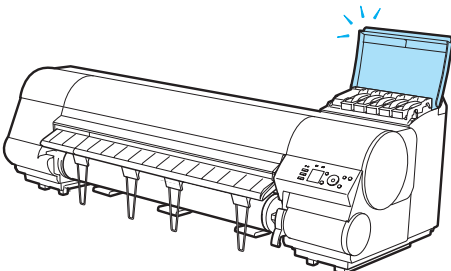
Cause	Corrective Action
The Ink Tank Cover is open. 	Close the Ink Tank Cover.

Ink tank is empty.

Cause	Corrective Action
There is no ink left in an ink tank. There are no ink colors with ✕ displayed above the remaining ink indicator in the Ink tab top screen. (See "Checking Ink Tank Levels.") →P.583	Open the Ink Tank Cover, and replace the Ink Tank for the color that is out of ink. (See "Replacing Ink Tanks.") →P.574

Not much ink is left.

Cause	Corrective Action
Not much ink is left.	Prepare a new Ink Tank. We recommend replacing the Ink Tank with a new Ink Tank at this point if you plan to print large-format or high-quantity jobs.

No ink tank loaded.

Cause	Corrective Action
There is no Ink Tank of the indicated color in the printer.	Load or reload the Ink Tank. (See "Replacing Ink Tanks.") →P.574
There is a problem with the Ink Tank.	Replace it with a new Ink Tank. (See "Replacing Ink Tanks.") →P.574

The following ink tanks cannot be recognized.

Cause	Corrective Action
An Ink Tank that is incompatible with the printer is loaded.	Load an Ink Tank that is compatible with the printer. (See "Replacing Ink Tanks.") →P.574

Wrong ink tank.

Cause	Corrective Action
The Ink Tank in the printer is incompatible.	Load an Ink Tank specified for use with the printer. (See "Replacing Ink Tanks.") →P.574

Messages regarding printing or adjustment

Cannot print as specified.	665
Cannot adjust printhead.	666
Borderless printing not possible. Paper stretched or shrank.	665
Before borderless printing, move the blue platen switch.	665
Borderless printing not possible.	661
Blue platen switch is dirty.	665
Move the blue platen switch No.xx to the right. (xx represents a number)	665
Check printed document.	665

Cannot print as specified.

"Lift the release lever and replace paper with A4/LTR (vertical) or larger."

Cause	Corrective Action
The loaded paper is too small.	Switch to paper A4/Letter (vertical) or larger.

"Lift the release lever and replace roll with 10 in. wide or larger roll."

Cause	Corrective Action
The loaded paper is too small.	Load a roll 10 inches wide or larger.

Borderless printing not possible. Paper stretched or shrank.

Cause	Corrective Action
The loaded roll has expanded or contracted due to environmental conditions, making it wider or narrower than the supported width for borderless printing.	<p>Press the OK button to stop printing.</p> <p>Use each type of paper only where the recommended environmental conditions are met. For details on environmental conditions for various paper, see the Paper Reference Guide. (See "Displaying the Paper Reference Guide.") →P.335</p>

Before borderless printing, move the blue platen switch.

Cause	Corrective Action
The blue Switch on the platen was set to the side opposite ● when a borderless print job was received.	Before borderless printing, set the blue Switch on the platen to the ● side. (See "Setting the Blue Switch on the Platen.") →P.638

Blue platen switch is dirty.

Cause	Corrective Action
The blue Switch on the platen is dirty.	Open the Top Cover and clean the blue Switch on the platen. (See "Cleaning Inside the Top Cover.") →P.599

Move the blue platen switch No.xx to the right. (xx represents a number)

Cause	Corrective Action
The printer has detected that the blue Switch on the platen needed in maintenance during printing is set away from the ● mark.	Set blue platen Switch of the indicated number toward the ● side. (See "Setting the Blue Switch on the Platen.") →P.638

Check printed document.

Cause	Corrective Action
The Printhead nozzles are becoming clogged.	If printing is faint, clean the Printhead. (See "Cleaning the Printhead.") →P.586

Messages regarding printheads

Cannot adjust printhead.	666
Wrong printhead.	666
Printhead error	666
Cannot recognize print head.	666
Execute printhead cleaning.	667

Cannot adjust printhead.

Cause	Corrective Action
The Printhead nozzles are clogged.	Execute Head Posi. Adj. again, as follows. <ol style="list-style-type: none"> 1. Press the OK button to clear the error. 2. Print a test pattern to check the nozzles. (See "Checking for Nozzle Clogging.") →P.585 3. Clean the Printhead if the nozzles are clogged. (See "Cleaning the Printhead.") →P.586 4. Execute Head Posi. Adj. again. (See "Automatic Adjustment to Straighten Lines and Colors.") →P.556
The Printhead cannot be aligned; highly transparent film is loaded.	Press the OK button to clear the error. We recommend using a type of paper that you often use, other than film, for Printhead adjustment. (See "Automatic Adjustment to Straighten Lines and Colors.") →P.556
The Printhead is installed crooked.	Straighten the Printhead as follows, and then execute Head Posi. Adj. again. <ol style="list-style-type: none"> 1. Press the OK button to clear the error. 2. Use Head Inc. Adj. to adjust the angle of inclination of the Printhead. (See "Adjusting Line Misalignment.") →P.560 3. Execute Head Posi. Adj. again. (See "Automatic Adjustment to Straighten Lines and Colors.") →P.556

Wrong printhead.

Cause	Corrective Action
An incompatible Printhead has been installed.	Open the Top Cover and replace the Printhead with a new one. (See "Replacing the Printhead.") →P.587

Printhead error

Cause	Corrective Action
There is a problem with the Printhead.	Open the Top Cover and replace the Printhead with a new one. (See "Replacing the Printhead.") →P.587

Cannot recognize print head.

Cause	Corrective Action
No Printhead is installed.	Follow these steps to install the Printhead. <ol style="list-style-type: none"> 1. Open the Top Cover. 2. Install the Printhead. (See "Replacing the Printhead.") →P.587
The Printhead cannot be recognized because it is not installed correctly.	Follow these steps to reinstall the Printhead. <ol style="list-style-type: none"> 1. Open the Top Cover. 2. Reinstall the Printhead. (See "Replacing the Printhead.") →P.587

Execute printhead cleaning.

Cause	Corrective Action
<p>The Printhead nozzles are clogged.</p>	<p>Follow these steps to clean the Printhead.</p> <ol style="list-style-type: none"> 1. Stop printing by pressing ▲ or ▼ to select Stop Printing. 2. Clean the Printhead. (See "Cleaning the Printhead.") →P.586 <p>If the message is still displayed when printing, replace the Printhead. (See "Replacing the Printhead.") →P.587</p> <p>Press ▲ or ▼ to select Print, and then press the OK button to resume printing. However, note that this error may affect the printing quality.</p>

Messages regarding the maintenance cartridge

Insert the maintenance cartridge.	668
Wrong maintenance cartridge.	668
Maint. cart. The level is low	668
No Maintenance Cartridge capacity.	668
Maintenance cartridge full.	668
Maintenance cartridge problem.	668

Insert the maintenance cartridge.

Cause	Corrective Action
The Maintenance Cartridge is not installed.	Install the Maintenance Cartridge. (See "Replacing the Maintenance Cartridge.") →P.593

Wrong maintenance cartridge.

Cause	Corrective Action
A Maintenance Cartridge for a different model of printer is installed.	Replace it with the Maintenance Cartridge for your particular model. (See "Maintenance Cartridge.") →P.593

Maint. cart. The level is low

Cause	Corrective Action
The Maintenance Cartridge is almost full.	You can continue to print, but prepare a new Maintenance Cartridge to use when the message for replacement is displayed.

No Maintenance Cartridge capacity.

Cause	Corrective Action
The Maintenance Cartridge cannot absorb enough ink for Printhead cleaning or other operation.	After confirming that the printer has stopped operating, replace the Maintenance Cartridge. (See "Replacing the Maintenance Cartridge.") →P.593

Maintenance cartridge full.

Cause	Corrective Action
The Maintenance Cartridge is full.	After confirming that the printer has stopped operating, replace the Maintenance Cartridge. (See "Replacing the Maintenance Cartridge.") →P.593

Maintenance cartridge problem.

Cause	Corrective Action
An incompatible or used Maintenance Cartridge has been installed.	Install an unused Maintenance Cartridge specified for use with the printer. (See "Replacing the Maintenance Cartridge.") →P.593

Messages regarding the hard disk

Hard disk error.	669
File read error.	669
The mail box is full.	669
Mail box full. Now printing without saving data.	669
Mail box nearly full.	669
Maximum jobs stored.	669
Mail box full. Delete unwanted data	669

Hard disk error.

Cause	Corrective Action
The format of the printer's hard disk is invalid.	Press the OK button to start reformatting the hard disk. When formatting is finished, data on the printer hard disk is erased and the printer automatically restarts.

File read error.

Cause	Corrective Action
Files on the printer's hard disk have become corrupted.	Restart the printer. Only the corrupted files will be deleted, and the printer will restart.

The mail box is full.

Cause	Corrective Action
There is no more space on the printer's hard disk.	Press the Stop button and stop printing.
	Delete print jobs from the queue. (See "Managing the Job Queue (Deleting or Preempting Other Jobs).") → P.523
	Delete unneeded jobs stored in personal boxes. (See "Deleting Saved Jobs.") → P.531

Mail box full. Now printing without saving data.

Cause	Corrective Action
No more space is available on the printer's hard disk, so jobs are now printed without saving them. (Print jobs can no longer be saved on the hard disk.)	After printing, this message is cleared.

Mail box nearly full.

Cause	Corrective Action
The free hard disk space left for Personal Boxes in the printer's hard disk does not have more than 1 GB, combined.	Delete unneeded jobs stored in Personal Boxes. (See "Deleting Saved Jobs.") → P.531

Maximum jobs stored.

Cause	Corrective Action
100 jobs are stored in the personal box.	Delete unneeded jobs stored in personal boxes. (See "Deleting Saved Jobs.") → P.531

Mail box full. Delete unwanted data

Cause	Corrective Action
100 jobs are stored in the Personal Box.	Press the Stop button and stop printing.
	Delete print jobs from the queue. (See "Managing the Job Queue (Deleting or Preempting Other Jobs).") → P.523
	Delete unneeded jobs stored in personal boxes. (See "Deleting Saved Jobs.") → P.531

Messages regarding HP-GL/2

This type of paper is not compatible with HP-GL/2.	670
GL2: Wxxxx The memory is full. (xxxx is 0501, 0903, or 0904)	670
GL2: W0502 The parameter is out of range.	670
GL2: W0504 This command is not supported.	670

This type of paper is not compatible with HP-GL/2.

Cause	Corrective Action
The printer has received a HP-GL/2 print job that cannot be printed on the paper that has been advanced.	<p>Follow these steps to replace the type of paper in the printer.</p> <ol style="list-style-type: none"> 1. Press ▲ or ▼ to select Change Paper, and then press the OK button. 2. Replace the paper with a type compatible with HP-GL/2. For details on paper compatible with HP-GL/2, refer to the Paper Reference Guide. (See "Displaying the Paper Reference Guide.") → P.335 <p>Press ▲ or ▼ to select Stop Printing, and then press the OK button.</p> <p>Press ▲ or ▼ to select Print, and then press the OK button to resume printing. However, note that this error may cause paper jams and affect the printing quality.</p>

GL2: Wxxxx The memory is full. (xxxx is 0501, 0903, or 0904)

Cause	Corrective Action
The printer memory is full.	<p>Because the entire print job could not be received, the printer may not be able to print the entire original. Check the printing results.</p> <p>In the Control Panel menu, setting On-the-Fly to On may enable printing. However, check the printing results because the image may be incomplete in some cases.</p>

GL2: W0502 The parameter is out of range.

Cause	Corrective Action
A parameter specified in a HP-GL/2 command is out of the supported range.	<p>Check the print job.</p> <p>If you have specified ProcessingOption > Warning > On in the Control Panel menu, set it to Off instead.</p>

GL2: W0504 This command is not supported.

Cause	Corrective Action
The printer has received an unsupported HP-GL/2 command.	<p>Check the print job.</p> <p>If you have specified ProcessingOption > Warning > On in the Control Panel menu, set it to Off instead.</p>

Other Messages

GARO Wxxxx (x represents a number) 671
 ERROR Exxx-xxxx (x represents a letter or number) 671
 Hardware error. xxxxxxxx-xxxx (x represents a letter or number) 671

Top cover is open. 671

Prepare for parts replacement. 672
 Parts replacement time has passed. 672

Unknown file. 672
 Multi-sensor error 672

No Roll Unit. 658

GARO Wxxxx (x represents a number)

Cause	Corrective Action
There is a problem with the print job.	Try printing again, using the correct printer driver.
	It is also possible to continue printing in this state. However, you may not be able to obtain the desired printing results.

ERROR Exxx-xxxx (x represents a letter or number)

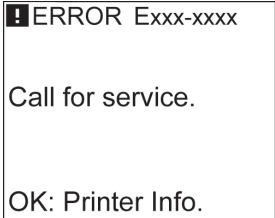
Cause	Corrective Action
An error requiring service may have occurred. 	Write down the error code and message, turn off the printer, and contact your Canon dealer for assistance.

Hardware error. xxxxxxxx-xxxx (x represents a letter or number)

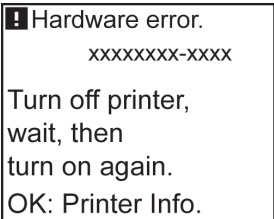
Cause	Corrective Action
The last portion of roll paper was used during a print job. The paper was not advanced because the trailing edge is taped to the roll.	Turn off the printer and remove the roll from the printer before restoring power.
Fastening tape or the Belt Stopper has not been removed inside the Top Cover.	Turn off the printer, open the Top Cover and remove the tape or the Belt Stopper before restoring power.
An error requiring service may have occurred. 	Turn off the printer and wait at least three seconds before restoring the power. If the message is displayed again, write down the error code and message, turn off the printer, and contact your Canon dealer for assistance.

Top cover is open.

Cause	Corrective Action
The printer has detected that the Top Cover is open.	Open the Top Cover fully, remove any foreign objects, and close the Top Cover again.
	If the error occurs again, close the Top Cover, turn off the printer, and wait a while before restoring power.

Prepare for parts replacement.

Cause	Corrective Action
It is almost time to replace consumables for which service is required.	You can continue to use the printer for some time until " Parts replacement time has passed. " will be displayed. Contact your Canon dealer for assistance.

Parts replacement time has passed.

Cause	Corrective Action
It is past the recommended time to replace consumables for which service is required.	Contact your Canon dealer for assistance.

Unknown file.

Cause	Corrective Action
Data sent to keep the printer up to date (such as paper information) is in the wrong format.	Check the data. Turn off the printer and wait a while before restoring power, and then resend the data.
You have uploaded firmware for a different model.	Check the firmware version. Turn off the printer and wait a while before restoring power, and then resend the firmware. If the message is displayed again, contact your Canon dealer for assistance.

Multi-sensor error

Cause	Corrective Action
Direct sunlight or strong lighting may be shining on the printer and causing the sensor to malfunction.	Take steps to ensure the printer is not used when exposed to direct sunlight or strong lighting.
The performance of a sensor inside the printer may be impaired.	Turn off the printer and wait at least three seconds before restoring the power. If the message is displayed again, contact your Canon dealer for assistance.

Basic Printing Workflow	15
Enhanced Printing Options	29
Windows Software	157
Mac OS Software	267
Handling and Use of Paper	331
Control Panel	429
Printer Parts	467
Network Setting	481
Print Job Management	501
Adjustments for Better Print Quality	555
Maintenance and Consumables	573
Troubleshooting	617
Error Message	651

Specifications

Printer Specifications	674
------------------------------	-----

Appendix	677
----------	-----

Printer Specifications

Specifications 674
 Print Area 675

Specifications

 • The following values may vary depending on the operating environment.
Important

Printer

Power supply	100–240 V AC (50/60 Hz)		
Power consumption	During operation	200 W max.	
	Sleep mode	5 W max.	
	Off	0.5 W max. (*1)	
Operating noise (*2)	Sound pressure level	During operation	Approx. 60 dB (A)
		Standby	35 dB (A) max.
	Audio power level (during operation)		Approx. 7.5 bels
Operating environment	Temperature	15–30°C (59–86°F)	
	Humidity	10–80%, non-condensing	
	Humidity (When the Stacker is used)	30–60% (non-condensing)	
Dimensions (W × D × H)	Printer, Stand, and Stacker (When the Stacker is attached to the printer) (*4)	1,893×1,320×1,144 mm (74.52×51.96×45.03 in)	
Weight	Printer, Stand, and Stacker (Includes the Roll Holder. Does not include the Print-head or Ink Tank.)	Approx. 213 kg (469.6 lb)	
Space for installation (W × D × H)(*3)	Printer, Stand, and Stacker(*4) (*5)	2,293×3,017×1,518 mm (90.27×118.77×59.76 in)	
Environmental Standards	International Energy Star Program, Eco Mark (Japan), Law on Promoting Green Purchasing/GPN (Japan), RoHS, EPEAT (Silver) technical compliance		

- *1: The printer uses a trace amount of power even when turned off. To stop all power consumption, turn off the printer and unplug the power cord.
- *2: Calculation based on ISO 7779. Operating conditions: On the **Main** sheet of the printer driver, **Media Type** > Plain Paper, **Advanced Settings** > **Print Priority** > **Line Drawing/Text**, and **Print Quality** > **Standard**.
- *3: These are the recommended dimensions taking the workspace into account. It is recommended that you ensure these dimensions so that you can work in the surrounding areas when using the Printer.
- *4: When using the Stacker, push it until it stops at the designated position of the Printer Stand. The dimension until it is removed from the Printer Stand when removing the Stacker is approximately 258 mm (10.15 in). (See "Installing and Removing the Stacker On the Printer.") [→P.376](#)
- *5: For detailed dimensions, see the Setup Guide.

Specifications
Printer Specifications

Printing performance

Print method	Bubblejet
Maximum resolution	2400 dpi horizontally (*1) × 1200 dpi vertically
Printhead	PF-04
Number of nozzles	MBK: 5120; Others: 2560 each color

*1: Prints with a minimum 1/2400 inch dot pitch between ink droplets.

Memory and hard disk

Memory	32 GB (640 MB physical memory)	
Hard disk capacity	320 GB	
	Personal mail boxes (Permanent storage area)	180 GB
Print job storage capacity	Common Box	100 jobs
	Personal Boxes	100 jobs

Interface

USB	Format	Internal port
	Mode	Full-speed (12 Mbps), high-speed (480 Mbps), bulk transfer
	Connector	Series B (4-pin)
Ethernet	Format	Internal port
	Specification	IEEE 802.3 10Base-T, IEEE 802.3u 100Base-TX/Auto-Negotiation, IEEE 802.3ab 1000Base-T/Auto-Negotiation, IEEE 802.3x Full Duplex IEEE 802.3az EEE
	Protocols	SNMP (supports Canon-MIB), HTTP, TCP/IP (IPv4/IPv6)

Ink

For information on the ink the printer supports, see "Ink Tanks." [→P.574](#)

Paper

For information on the types of paper the printer supports, refer to the **Paper Reference Guide**. (See "Displaying the Paper Reference Guide.") [→P.335](#)

Paper width	For information on the paper widths the printer supports, see "Paper Sizes." →P.332	
Minimum paper length	Rolls	203 mm (8.0 in)
	Sheets	
	When the Stacker is used	210 mm (8.3 in)
Maximum printable length (*1)	Rolls	18 m (19.7 yd)
	Sheets	1,600 mm (63.0 in)
Thickness	Rolls	0.07–0.8 mm (0.0028–0.031 in)
	Sheets	0.07–0.8 mm (0.0028–0.031 in)
Roll maximum outer diameter	150 mm (6 in) or shorter	
Supported paper core inner diameter	2 inches / 3 inches	
Print area	For details, see "Print Area." →P.675	

*1:Varies depending on the operating system or application.

Optional

Roll Holder Set	Roll Holder Set RH2-44
-----------------	------------------------

Print Area

A margin required by the printer is added with respect to the size of paper loaded in the printer. Except in borderless printing, the actual printing area corresponds to the paper size minus the space for this margin.



- **Printable Area:** The area that can be printed.
- There is no margin (that is, a margin of 0 mm) during borderless printing on rolls.
- **Recommended Print Area:** We recommend printing within this area.
- To print so that your original matches the print area exactly, use an oversized paper size that includes the required margin. (See "Printing on Oversize Paper." →P.83)

	Margins of Printable Area			Margins of Recommended Print Area		
	Top Edge	Bottom Edge	Sides	Top Edge	Bottom Edge	Sides
Sheets	3 mm (0.12 in)	23 mm (0.91 in)	3 mm (0.12 in)	20 mm (0.79 in)	23 mm (0.91 in)	5 mm (0.20 in)
Rolls	0/3 mm (0/0.12 in)	0/3 mm (0/0.12 in)	0/3 mm (0/0.12 in)	20 mm (0.79 in)	5 mm (0.20 in)	5 mm (0.20 in)

Sheets



• Printable Area

a margin of 3 mm (0.12 in) on top, 23 mm (0.91 in) on bottom, and 3 mm (0.12 in) on left and right sides is required.

• Recommended Print Area

A margin of 20 mm (0.79 in) on top, 23 mm (0.91 in) on bottom, and 5 mm (0.20 in) on left and right sides is required.

Rolls

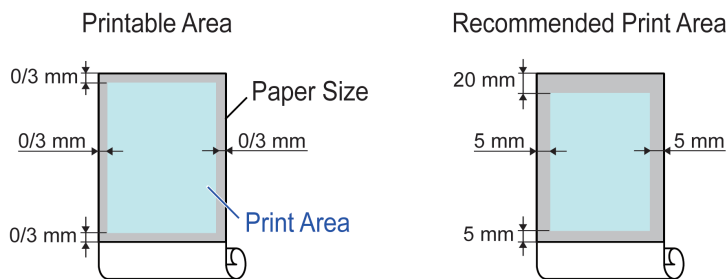

• Printable Area

A margin of 3 mm (0.12 in) on all sides is required. During borderless printing, the margin on all sides is 0 mm. For information on paper compatible with borderless printing, see the **Paper Reference Guide**. (See "Types of Paper." →P.332)

• Recommended Print Area

A margin of 20 mm (0.79 in) on top, 5 mm (0.20 in) on bottom, and 5 mm (0.20 in) on left and right sides is required.

Basic Printing Workflow	15
Enhanced Printing Options	29
Windows Software	157
Mac OS Software	267
Handling and Use of Paper	331
Control Panel	429
Printer Parts	467
Network Setting	481
Print Job Management	501
Adjustments for Better Print Quality	555
Maintenance and Consumables	573
Troubleshooting	617
Error Message	651
Specifications	673

Appendix

▲ Safety Precautions	678
Manuals for this printer	682
Disposal of the product	684

Safety Precautions

Safety Precautions	678
Legal Notices	680

Safety Precautions

Follow the warnings and precautions below to use the printer safely. Do not perform any operations or procedures other than as described in this manual. Doing so may result in unexpected accidents and can cause a fire or electrical shocks.

Printer location

 **Warning** • Do not set up the printer in any location exposed to alcohol, thinner, or other volatile liquids. If these substances come into contact with electrical components inside the printer, there is a risk of fire or electrical shock.

 **Caution** • Never install the printer on an unstable or vibrating surface. If it falls over, this could cause personal injury.

• Never set up the printer in a location that is exposed to high humidity or large amounts of dust, or exposed to direct sunlight, high temperature, or open flame. This could cause a fire or electrical shock. Use the printer location in an environment where temperature and humidity are within the ranges of 15 °C to 30 °C (59 °F to 86 °F) and 10 to 80% RH (with no condensation).

• Never place the printer on a heavy wool or shag carpet. The fibers may enter the printer and cause a fire.

• Keep the area around the power outlet clear of items so that you can disconnect the power cable immediately if the printer starts operating abnormally. In the event of a printer malfunction, remove the power cable from the outlet as soon as possible to prevent fire and electrical shocks.

• Do not install the printer near sources of strong electromagnetic fields, whether equipment that generates such fields or places where such fields occur. This could damage the printer or cause malfunction.

Power Supply

 **Warning** • Never handle the power cable with wet hands. Doing so may cause electrical shock.

• Insert the power cable securely and completely into the power source. If the power cable is not inserted completely, this could cause a fire or electrical shock.

• Do not use any power cable other than the one provided. This could cause a fire or electrical shock. Never use the power cable with any other electrical device.

• Never cut the power cable or attempt to modify it, and never stretch it or bend it forcefully. Never place a heavy object on the power cable. Damaged sections of the power cable could cause a short circuit and may cause a fire or electrical shock.

• Never connect the power cable to a power strip or any power source shared by other electrical devices. This could cause a fire or electrical shock.

• Never knot the power cable or wrap it around itself. This could cause a fire or electrical shock.

• Periodically disconnect the power cable and use a dry cloth to wipe away dust that has collected on the plug and the area around the power outlet. Leaving the power cable plugged in and not cleaned for a long period, especially in an area subject to dust, oil, and humidity, could cause the insulation material to deteriorate and lead to a fire.

 **Caution** • Always grip the plug to remove the power cable from the power outlet. Pulling on the power cable could damage the cable and lead to a fire or electrical shock.

• Never use an extension cord. This could cause a fire or electrical shock.

• Never use any power source other than 100–120 / 220–240 V AC. This could cause a fire or electrical shock. The printer operating conditions are described below. Use the printer under the following conditions.
 Power supply voltage: 100–120 / 220–240 V AC
 Power supply frequency: 50/60 Hz

In an Emergency



Warning

- If the printer emits smoke or strange odors, continuing to use the printer may cause a fire or electrical shock. Switch the printer off immediately and remove the power plug from the power outlet. Contact your Canon dealer or support center.

Cleaning the Printer



Warning

- For cleaning, use a cloth dampened in water. Never use flammable solvents such as alcohol, benzene, or thinner. If these substances come into contact with electrical components inside the printer, there is a risk of fire or electrical shock.



Caution

- Always disconnect the power cable from the outlet before cleaning the printer. If the printer is switched on accidentally, moving parts inside the printer may cause personal injuries.

Pacemakers



Warning

- This printer generates a low-level magnetic field. Anyone wearing a pacemaker who experiences discomfort while working around the printer should leave the area. Consult a physician before continuing to work around the printer.

Moving the Printer



Caution

- Moving the printer requires at least six people, holding it on both sides. Be careful to avoid back strain and other injuries.
- When moving the printer, firmly grasp the Carrying Handles under each side. The printer may be unsteady if you hold it at other positions, which poses a risk of injury from dropping the printer.

Printhead, Ink Tanks, and Maintenance Cartridge



Caution

- Always store consumables in a safe location out of the reach of small children. If a child licks or ingests ink accidentally, seek medical assistance immediately.
- If ink accidentally gets in your eyes, immediately rinse with water.
If ink gets on your skin, immediately clean it off with soap and water.
If irritation persists in your eyes or on your skin, contact a physician immediately.
- Avoid dropping or shaking printheads, ink tanks, and maintenance cartridges. Spilled ink can stain clothing and the work area.
- Never touch the electrical contacts of the Printhead after printing. The contacts become extremely hot and can cause minor burns.

Other



- Never disassemble the printer or attempt repairs. There are high voltage parts inside the printer that can cause a fire or electrical shock.
- Never use flammable sprays around the printer. The gas of flammable sprays can cause a fire or electrical shock, if it contacts high voltage points inside the printer.
- Never touch the cutting edge of Cutter Unit (a). This could cause personal injury.

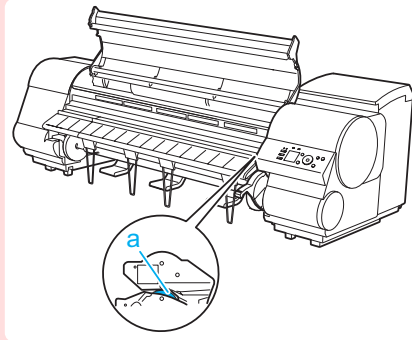

- Never insert your hand into the printer while it is printing. Moving parts inside the printer can cause injuries.
- Never place anything on the printer such as small metal objects (paper clips, staples), liquids, any type of liquid container that contains flammable liquids (alcohol, benzene, etc.). If such objects fall into the printer, this could cause a fire or electrical shock.
- To prevent a fire hazard or dangerous electric shock, if a foreign object falls into or a liquid spills into the printer, press the Power button immediately to switch the printer off, unplug the printer power cable from the outlet, and then contact your Canon dealer or support center. If you continue to use the printer, this could cause a fire or electrical shock.



- Connect the interface cable correctly. To avoid damage, before connection make sure that the shape of the cable connector matches the connection point on the printer.
- During printing, turn on the ventilation system in the room.
- We recommend ensuring ample space for installation.

Legal Notices

FCC Regulations (U.S.A)

Canon Large Format Printer	iPF850
----------------------------	--------

This device complies with Part 15 of the FCC Rules. Operation is subject to the following two conditions: (1) This device may not cause harmful interference, and (2) this device must accept any interference received, including interference that may cause undesired operation.

Note: This equipment has been tested and found to comply with the limits for class B digital device, pursuant to Part 15 of the FCC Rules. These limits are designed to provide reasonable protection against harmful interference in a residential installation.

This equipment generates, uses and can radiate radio frequency energy and, if not installed and used in accordance with the instructions, may cause harmful interference to radio communications. However, there is no guarantee that interference will not occur in a particular installation. If this equipment does cause harmful interference to radio or television reception, which can be determined by turning the equipment off and on, the user is encouraged to try to correct the interference by one or more of the following measures:

- Reorient or relocate the receiving antenna.
- Increase the separation between the equipment and receiver.
- Connect the equipment into an outlet on a circuit different from that to which the receiver is connected.
- Consult the dealer or an experienced radio/TV technician for help.

Use of shielded cable is required to comply with Class B limits in Subpart B of Part 15 of FCC Rules.

Do not make any changes or modifications to the equipment unless otherwise specified in the manual. If such changes or modifications should be made, you could be required to stop operation of the equipment.
Canon U.S.A. Inc.
One Canon Park Melville, NY 11747 , U.S.A.
Tel No. 1-800-652-2666

For CA, USA Only

Included battery contains Perchlorate Material - special handling may apply.
See <http://www.dtsc.ca.gov/hazardouswaste/perchlorate/> for detail.

Trademarks

- Canon, the Canon logo, and imagePROGRAF are trademarks or registered trademarks of CANON INC.
- Microsoft is a registered trademark of Microsoft Corporation.
- Windows is a trademark or registered trademark of Microsoft Corporation in the U.S. and/or other countries.
- Windows Vista is a trademark or registered trademark of Microsoft Corporation in the U.S. and/or other countries.
- Excel, Internet Explorer and PowerPoint are registered trademarks or trademarks of Microsoft Corporation in the U.S. and/or other countries.
- Mac, Mac OS, Bonjour, Safari and OS X are trademarks of Apple Inc., registered in the U.S. and other countries.
- Adobe RGB, a trademark of Adobe Systems Incorporated, is color space proposed by Adobe Systems Incorporated.

Copyright

- Unauthorized reproduction of this user manual in whole or part is prohibited.

Legal Notice

- It is illegal to reproduce currency, bills, negotiable securities and other documents prohibited by law. Reproduction of such items may be subject to criminal prosecution.
- It is illegal to reproduce legal certificates, licenses, travel tickets, and certain public and private documents prohibited from reproduction by law. Reproduction of such items may be subject to criminal prosecution.
- Please note that intellectual property protected by copyright may not be reproduced without the express permission of the copyright holder except for personal or household use under limited circumstances.

Manuals for this printer

Manuals for this printer	682
About This User Manual	682

Manuals for this printer

This printer has the following manuals.

Name	Contents	Medium
Setup Guide	Instructions for unpacking and setting up the printer, and for installing the software and electronic manuals.	Printed Manuals
Quick Guide	Contains information such as a guide to exchanging paper, Ink Tank, and Printhead, and cautions for using the product safely.	
Basic Guide	Descriptions of basic printer operations.	Electronic manuals
User's Guide	Detailed instructions for using the printer.	
Paper Reference Guide	This guide describes about the types and specifications of the available media on the printer.	

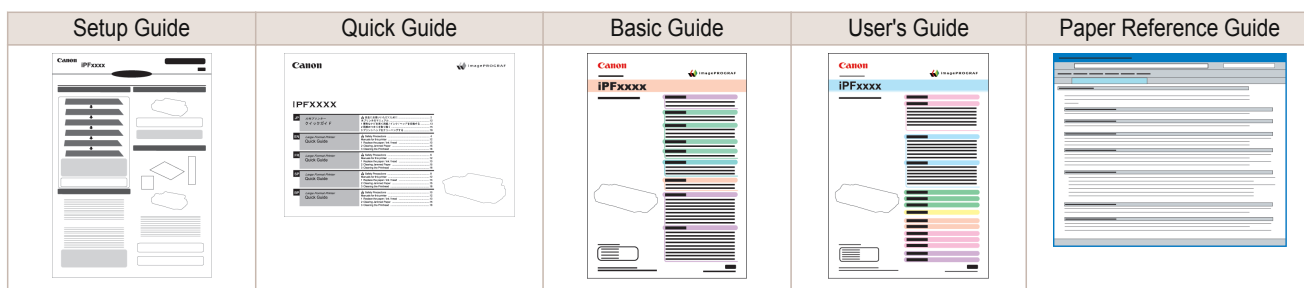

About This User Manual

• Symbols

The following symbols are used in this user manual to indicate safety information and explanations on restrictions or precautions in use.

	Warning	Indicates warning items for which operating error poses a risk of death or serious injury. To ensure safe use, always follow these warnings.
	Caution	Indicates caution items for which operating error poses a risk of injury. To ensure safe use, always follow these cautions.
	Important	Indicates important information and restrictions that definitely are to be followed during operation. Be sure to read this information to prevent troubles, malfunctions, or damage to equipment or property by operating errors.
	Note	Indicates helpful reference information and supplemental information on particular topics.

• Button names and user interface elements

Key and button names on the control panel and user interface elements in software (such as menus and buttons) are indicated as follows in this user manual.

Control panel buttons	Example: Press the OK button.
Control panel messages	Example: Head Cleaning is displayed.
Software interface items (menus and buttons)	Example: Click OK .
Keyboard keys	Example: Press the Tab key.

- **Cross-reference**

Other pages or manuals that provide related information are indicated as follows in this user manual.

Cross-reference in the same user manual	Example: see "Menu Structure." → P.443 Click the link to jump to the corresponding page.
Cross-reference in related manuals	Example: Refer to the Paper Reference Guide.
Other cross-reference	Example: See the printer driver help.

- **Figures and software screens**

- Figures in this user manual may be different from the actual appearance of the printer in some cases.
- Screens depicted in this user manual for the printer driver or other software may be different from the actual screens because of subsequent updates.

- **May we request**

- The information in this user manual is subject to change without notice.
- We strive to ensure accuracy of information in this user manual, but if you notice errors or omissions, contact support center.

Disposal of the product

WEEE Directive

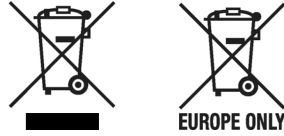

Only for European Union and EEA (Norway, Iceland and Liechtenstein)

These symbols indicate that this product is not to be disposed of with your household waste, according to the WEEE Directive (2012/19/EU), the Battery Directive (2006/66/EC) and/or national legislation implementing those Directives.

If a chemical symbol is printed beneath the symbol shown above, in accordance with the Battery Directive, this indicates that a heavy metal (Hg = Mercury, Cd = Cadmium, Pb = Lead) is present in this battery or accumulator at a concentration above an applicable threshold specified in the Battery Directive.

This product should be handed over to a designated collection point, e.g., on an authorized one-for-one basis when you buy a new similar product or to an authorized collection site for recycling waste electrical and electronic equipment (EEE) and batteries and accumulators. Improper handling of this type of waste could have a possible impact on the environment and human health due to potentially hazardous substances that are generally associated with EEE. Your cooperation in the correct disposal of this product will contribute to the effective usage of natural resources.

For more information about the recycling of this product, please contact your local city office, waste authority, approved scheme or your household waste disposal service or visit [→ www.canon-europe.com/weee](http://www.canon-europe.com/weee) , or

[→ www.canon-europe.com/battery](http://www.canon-europe.com/battery) .

Nur für Europäische Union und EWR (Norwegen, Island und Liechtenstein)

Diese Symbole weisen darauf hin, dass dieses Produkt gemäß WEEE-Richtlinie (2012/19/EU; Richtlinie über Elektro- und Elektronik-Altgeräte), Batterien-Richtlinie (2006/66/EG) und nationalen Gesetzen zur Umsetzung dieser Richtlinien nicht über den Hausmüll entsorgt werden darf.

Falls sich unter dem oben abgebildeten Symbol ein chemisches Symbol befindet, bedeutet dies gemäß der Batterien-Richtlinie, dass in dieser Batterie oder diesem Akkumulator ein Schwermetall (Hg = Quecksilber, Cd = Cadmium, Pb = Blei) in einer Konzentration vorhanden ist, die über einem in der Batterien-Richtlinie angegebenen Grenzwert liegt.

Dieses Produkt muss bei einer dafür vorgesehenen Sammelstelle abgegeben werden. Dies kann z. B. durch Rückgabe beim Kauf eines neuen ähnlichen Produkts oder durch Abgabe bei einer autorisierten Sammelstelle für die Wiederaufbereitung von Elektro- und Elektronik-Altgeräten sowie Batterien und Akkumulatoren geschehen. Der unsachgemäße Umgang mit Altgeräten kann aufgrund potenziell gefährlicher Stoffe, die generell mit Elektro- und Elektronik-Altgeräten in Verbindung stehen, negative Auswirkungen auf die Umwelt und die menschliche Gesundheit haben.

Durch Ihre Mitarbeit bei der umweltgerechten Entsorgung dieses Produkts tragen Sie zu einer effektiven Nutzung natürlicher Ressourcen bei.

Um weitere Informationen über die Wiederverwertung dieses Produkts zu erhalten, wenden Sie sich an Ihre Stadtverwaltung, den öffentlich-rechtlichen Entsorgungsträger, eine autorisierte Stelle für die Entsorgung von Elektro- und Elektronik-Altgeräten oder Ihr örtliches Entsorgungsunternehmen oder besuchen Sie

[→ www.canon-europe.com/weee](http://www.canon-europe.com/weee) , oder [→ www.canon-europe.com/battery](http://www.canon-europe.com/battery) .

Union Européenne, Norvège, Islande et Liechtenstein uniquement.

Ces symboles indiquent que ce produit ne doit pas être mis au rebut avec les ordures ménagères, comme le spécifie la Directive européenne DEEE (2012/19/UE), la Directive européenne relative à l'élimination des piles et des accumulateurs usagés (2006/66/CE) et les lois en vigueur dans votre pays appliquant ces directives.

Si un symbole de toxicité chimique est imprimé sous le symbole illustré ci-dessus conformément à la Directive relative aux piles et aux accumulateurs, il indique la présence d'un métal lourd (Hg = mercure, Cd = cadmium, Pb = plomb) dans la pile ou l'accumulateur à une concentration supérieure au seuil applicable spécifié par la Directive.

Ce produit doit être confié au distributeur à chaque fois que vous achetez un produit neuf similaire, ou à un point de collecte mis en place par les collectivités locales pour le recyclage des Déchets des Équipements Électriques et Électroniques (DEEE). Le traitement inapproprié de ce type de déchet risque d'avoir des répercussions sur l'environnement et la santé humaine, du fait de la présence de substances potentiellement dangereuses généralement associées aux équipements électriques et électroniques.

Votre entière coopération dans le cadre de la mise au rebut correcte de ce produit favorisera une meilleure utilisation des ressources naturelles.

Pour plus d'informations sur le recyclage de ce produit, contactez vos services municipaux, votre éco-organisme ou les autorités locales compétentes, ou consultez le site www.canon-europe.com/weee, ou

www.canon-europe.com/battery.

Uitsluitend bestemd voor de Europese Unie en EER (Noorwegen, IJsland en Liechtenstein)

Met deze symbolen wordt aangegeven dat dit product in overeenstemming met de AEEA-richtlijn (2012/19/EU), de richtlijn 2006/66/EG betreffende batterijen en accu's en/of de plaatselijk geldende wetgeving waarin deze richtlijnen zijn geïmplementeerd, niet bij het normale huisvuil mag worden weggegooid.

Indien onder het hierboven getoonde symbool een chemisch symbool gedrukt staat, geeft dit in overeenstemming met de richtlijn betreffende batterijen en accu's aan dat deze batterij of accu een zwaar metaal bevat (Hg = kwik, Cd = cadmium, Pb = lood) waarvan de concentratie de toepasselijke drempelwaarde in overeenstemming met de genoemde richtlijn overschrijdt.

Dit product dient te worden ingeleverd bij een hiervoor aangewezen inzamelpunt, bijv. door dit in te leveren bij een hiertoe erkend verkooppunt bij aankoop van een gelijksoortig product, of bij een officiële inzameldienst voor de recycling van elektrische en elektronische apparatuur (EEA) en batterijen en accu's. Door de potentieel gevaarlijke stoffen die gewoonlijk gepaard gaan met EEA, kan onjuiste verwerking van dit type afval mogelijk nadelige gevolgen hebben voor het milieu en de menselijke gezondheid. Uw medewerking bij het op juiste wijze weggoeien van dit product draagt bij tot effectief gebruik van natuurlijke hulpbronnen.

Voor verdere informatie over recycling van dit product kunt u contact opnemen met uw plaatselijke gemeente, afvaldienst, officiële dienst voor klein chemisch afval of afvalstortplaats, of kunt u terecht op

www.canon-europe.com/weee, of www.canon-europe.com/battery.

Sólo para la Unión Europea y el Área Económica Europea (Noruega, Islandia y Liechtenstein)

Estos iconos indican que este producto no debe desecharse con los residuos domésticos de acuerdo con la Directiva sobre RAEE (2012/19/UE) y la Directiva sobre Pilas y Acumuladores (2006/66/CE) y/o la legislación nacional. Si aparece un símbolo químico bajo este icono, de acuerdo con la Directiva sobre Pilas y Acumuladores, significa que la pila o el acumulador contiene metales pesados (Hg = Mercurio, Cd = Cadmio, Pb = Plomo) en una concentración superior al límite especificado en dicha directiva.

Este producto deberá entregarse en un punto de recogida designado, por ejemplo, entregándolo en el lugar de venta al adquirir un producto nuevo similar o en un centro autorizado para la recogida de residuos de aparatos eléctricos y electrónicos (RAEE), baterías y acumuladores. La gestión incorrecta de este tipo de residuos puede afectar al medio ambiente y a la salud humana debido a las sustancias potencialmente nocivas que suelen contener estos aparatos.

Su cooperación en la correcta eliminación de este producto contribuirá al correcto aprovechamiento de los recursos naturales.

Los usuarios tienen derecho a devolver pilas, acumuladores o baterías usados sin coste alguno. El precio de venta de pilas, acumuladores y baterías incluye el coste de la gestión medioambiental de su desecho, y no es necesario mostrar la cuantía de dicho coste en la información y la factura suministradas a los usuarios finales.

Si desea más información sobre el reciclado de este producto, póngase en contacto con su municipio, el servicio o el organismo encargado de la gestión de residuos domésticos o visite www.canon-europe.com/weee, o

www.canon-europe.com/battery.

Solo per Unione Europea e SEE (Norvegia, Islanda e Liechtenstein)

Questi simboli indicano che il prodotto non può essere smaltito con i rifiuti domestici, ai sensi della Direttiva RAEE (2012/19/UE), della Direttiva sulle Batterie (2006/66/CE) e/o delle leggi nazionali che attuano tali Direttive.

Se sotto il simbolo indicato sopra è riportato un simbolo chimico, in osservanza della Direttiva sulle batterie, tale simbolo indica la presenza di un metallo pesante (Hg = Mercurio, Cd = Cadmio, Pb = Piombo) nella batteria o nell'accumulatore con un livello di concentrazione superiore a una soglia applicabile specificata nella Direttiva sulle batterie.

Il prodotto deve essere conferito a un punto di raccolta designato, ad esempio il rivenditore in caso di acquisto di un nuovo prodotto simile oppure un centro di raccolta autorizzato per il riciclaggio di rifiuti di apparecchiature elettriche ed elettroniche (RAEE) nonché di batterie e accumulatori. Un trattamento improprio di questo tipo di rifiuti può avere conseguenze negative sull'ambiente e sulla salute umana a causa delle sostanze potenzialmente nocive solitamente contenute in tali rifiuti.

La collaborazione dell'utente per il corretto smaltimento di questo prodotto contribuirà a un utilizzo efficace delle risorse naturali ed eviterà di incorrere in sanzioni amministrative ai sensi dell'art. 255 e successivi del Decreto Legislativo n. 152/06.

Per ulteriori informazioni sul riciclaggio di questo prodotto, contattare le autorità locali, l'ente responsabile della raccolta dei rifiuti, un rivenditore autorizzato o il servizio di raccolta dei rifiuti domestici, oppure visitare il sito

→ www.canon-europe.com/weee , o → www.canon-europe.com/battery .

Apenas para a União Europeia e AEE (Noruega, Islândia e Liechtenstein)

Estes símbolos indicam que este produto não deve ser eliminado juntamente com o seu lixo doméstico, segundo a Diretiva REEE de 2012/19/UE, a Diretiva de Baterias (2006/66/CE) e/ou a sua legislação nacional que transponha estas Diretivas.

Se houver um símbolo químico impresso como mostrado abaixo, de acordo com a Diretiva de Baterias, isto indica que um metal pesado (Hg = Mercúrio, Cd = Cádmio, Pb = Chumbo) está presente nesta pilha ou acumulador, numa concentração acima de um limite aplicável especificado na Diretiva.

Este produto deve ser entregue num ponto de recolha designado, por exemplo num local autorizado de troca quando compra um equipamento novo idêntico, ou num local de recolha autorizado para reciclar equipamento elétrico e eletrónico (EEE) em fim de vida, bem como pilhas e baterias. O tratamento inadequado deste tipo de resíduos pode ter um impacto negativo no ambiente e na saúde humana, devido a substâncias potencialmente perigosas que estão associadas com equipamentos do tipo EEE.

A sua cooperação no tratamento correto deste produto irá contribuir para a utilização mais eficaz dos recursos naturais.

Para obter mais informações acerca de como reciclar este produto, por favor contacte as suas autoridades locais responsáveis pela matéria, serviço de recolha aprovado para pilhas e baterias ou serviço de recolha de resíduos sólidos domésticos da sua municipalidade, ou visite

→ www.canon-europe.com/weee , ou

→ www.canon-europe.com/battery .

Gælder kun i Europæiske Union og EØS (Norge, Island og Liechtenstein)

Disse symboler betyder, at produktet ikke må bortskaffes sammen med dagrenovation i henhold til WEEE-direktivet (2012/19/EU), batteridirektivet (2006/66/EF) og/eller den lokale lovgivning, som disse direktiver er gennemført i. Hvis der i overensstemmelse med batteridirektivet er trykt et kemisk symbol under det symbol, der er vist ovenfor, betyder det, at batteriet eller akkumulatoren indeholder tungmetaller (Hg = kviksølv, Cd = cadmium, Pb = bly) i en koncentration, som ligger over de grænseværdier, der er beskrevet i batteridirektivet.

Produktet skal afleveres på et godkendt indsamlingssted, f.eks. i overensstemmelse med en godkendt én-til-én-procedure, når du indkøber et nyt tilsvarende produkt, eller på et godkendt indsamlingssted for elektronikaffald samt for batterier og akkumulatører. Forkert håndtering af denne type affald kan medføre negative konsekvenser for miljøet og menneskers helbred på grund af de potentielt sundhedsskadelige stoffer, der generelt kan forefindes i elektrisk og elektronisk udstyr.

Når du foretager korrekt bortskaffelse af produktet, bidrager du til effektiv brug af naturressourcerne. Kontakt din kommune, den lokale affaldsmyndighed, det lokale affaldsanlæg, eller besøg

→ www.canon-europe.com/weee , eller

→ www.canon-europe.com/battery for at få flere oplysninger om genbrug af dette produkt.

Μόνο για την Ευρωπαϊκή Ένωση και τον ΕΟΧ (Νορβηγία, Ισλανδία και Λιχτενστάιν)

Αυτά τα σύμβολα υποδεικνύουν ότι αυτό το προϊόν δεν πρέπει να απορρίπτεται μαζί με τα οικιακά απορρίμματα, σύμφωνα με την Οδηγία για τα Απόβλητα Ηλεκτρικού και Ηλεκτρονικού Εξοπλισμού (ΑΗΗΕ) (2012/19/ΕΕ), την Οδηγία για τις Ηλεκτρικές Στήλες (2006/66/ΕΚ) ή/και την εθνική νομοθεσία που εφαρμόζει τις Οδηγίες εκείνες. Εάν κάποιο χημικό σύμβολο είναι τυπωμένο κάτω από το σύμβολο που φαίνεται παραπάνω, σύμφωνα με την Οδηγία για τις Ηλεκτρικές Στήλες, υποδηλώνει ότι κάποιο βαρύ μέταλλο (Hg = Υδράργυρος, Cd = Κάδμιο, Pb = Μόλυβδος) υπάρχει στην μπαταρία ή τον συσσωρευτή σε συγκέντρωση μεγαλύτερη από το ισχύον επίπεδο που καθορίζεται στην Οδηγία για τις Ηλεκτρικές Στήλες.

Αυτό το προϊόν πρέπει να παραδίδεται σε καθορισμένο σημείο συλλογής, π.χ. σε μια εξουσιοδοτημένη βάση ανταλλαγής όταν αγοράζετε ένα νέο παρόμοιο προϊόν ή σε μια εξουσιοδοτημένη θέση συλλογής για την ανακύκλωση των αποβλήτων ηλεκτρικού και ηλεκτρονικού εξοπλισμού (ΗΗΕ) και των ηλεκτρικών στηλών και συσσωρευτών. Ο ακατάλληλος χειρισμός αυτού του τύπου αποβλήτων μπορεί να έχει αρνητικό αντίκτυπο στο περιβάλλον και την υγεία του ανθρώπου, λόγω δυνητικά επικίνδυνων ουσιών που γενικά συνδέονται με τον ΗΗΕ.

Η συνεργασία σας για τη σωστή απόρριψη αυτού του προϊόντος θα συμβάλει στην αποτελεσματική χρήση των φυσικών πόρων.

Για περισσότερες πληροφορίες σχετικά με ανακύκλωση αυτού του προϊόντος, επικοινωνήστε με το τοπικό γραφείο της πόλης σας, την υπηρεσία απορριμμάτων, το εγκεκριμένο σχήμα ή την υπηρεσία απόρριψης οικιακών αποβλήτων ή επισκεφθείτε τη διεύθυνση → www.canon-europe.com/weee ή → www.canon-europe.com/battery.

Gjelder kun den europeiske union og EØS (Norge, Island og Liechtenstein)

Disse symbolene indikerer at dette produktet ikke skal kastes sammen med husholdningsavfall, i henhold til WEEE-direktivet (2012/19/EU), batteridirektivet (2006/66/EF) og/eller nasjonal lov som har implementert disse direktivene.

Hvis et kjemisk symbol vises under symbolet vist ovenfor, i samsvar med batteridirektivet, indikerer dette at et tungmetall (Hg = kvikksølv, Cd = kadmium, Pb = bly) finnes i batteriet eller akkumulatoren i en konsentrasjon over en gjeldende øvre grense som er spesifisert i batteridirektivet.

Produktet må leveres til et dertil egnet innsamlingspunkt, det vil si på en autorisert en-til-en-basis når en kjøper et nytt lignende produkt, eller til et autorisert innsamlingssted for resirkulering av avfall fra elektrisk og elektronisk utstyr (EE-utstyr) og batterier og akkumulatorene. Feil håndtering av denne typen avfall kan være miljø- og helseskadelig på grunn av potensielt skadelige stoffer som ofte brukes i EE-utstyr.

Din innsats for korrekt avhending av produktet vil bidra til effektiv bruk av naturressurser.

Du kan få mer informasjon om resirkulering av dette produktet ved å kontakte lokale myndigheter, avfallsadministrasjonen, et godkjent program eller husholdningens renovasjonsselskap, eller gå til

→ www.canon-europe.com/weee, eller → www.canon-europe.com/battery.

Vain Euroopan unionin sekä ETA:n (Norja, Islanti ja Liechtenstein) alueelle.

Nämä tunnuksot osoittavat, että sähkö- ja elektroniikkalaiteromua koskeva direktiivi (SER-direktiivi, 2012/19/EU), paristoista ja akuista annettu direktiivi (2006/66/EY) sekä kansallinen lainsäädäntö kieltävät tuotteen hävittämisen talousjätteen mukana.

Josillä olevan symbolin alapuolelle on paristodirektiivin mukaisesti painettu kemiallisen aineen tunnus, kyseinen paristo tai akku sisältää raskasmetalleja (Hg = elohopea, Cd = kadmium, Pb = lyijy) enemmän kuin paristodirektiivin salliman määrän.

Tuote on vietävä asianmukaiseen keräyspisteeseen, esimerkiksi kodinkoneliikkeeseen uutta vastaavaa tuotetta ostettaessa tai viralliseen sähkö- ja elektroniikkalaiteromun tai paristojen ja akkujen keräyspisteeseen. Sähkö- ja elektroniikkalaiteromun virheellinen käsittely voi vahingoittaa ympäristöä ja ihmisten terveyttä, koska laitteet saattavat sisältää ympäristölle ja terveydelle haitallisia aineita. Tuotteen asianmukainen hävittäminen säästää myös luonnonvaroja.

Jos haluat lisätietoja tämän tuotteen kierrätyksestä, ota yhteys kunnan jätehuoltoviranomaisiin tai käyttämäsi jätehuolto-yhtiöön tai käy osoitteessa → www.canon-europe.com/weee, tai → www.canon-europe.com/battery.

Endast för Europeiska unionen och EES (Norge, Island och Liechtenstein)

De här symbolerna visar att produkten inte får sorteras och slängas som hushållsavfall enligt WEEE-direktivet (2012/19/EU), batteridirektivet (2006/66/EG) och/eller nationell lagstiftning som implementerar dessa direktiv.

Om en kemisk symbol förekommer under ovanstående symbol innebär detta enligt Batteridirektivet att en tungmetall (Hg = Kvikksilver, Cd = Kadmium, Pb = Bly) förekommer i batteriet eller ackumulatormed en koncentration som överstiger tillämplig gräns som anges i Batteridirektivet.

Produkten ska lämnas in på en avsedd insamlingsplats, t.ex. på en återvinningsstation auktoriserad att hantera elektrisk och elektronisk utrustning (EE-utrustning) samt batterier och ackumulatorene eller hos handlare som är auktoriserade att byta in varor då nya, motsvarande köps (en mot en). Olämplig hantering av avfall av den här typen kan ha negativ inverkan på miljön och människors hälsa på grund av de potentiellt farliga ämnen som kan återfinnas i elektrisk och elektronisk utrustning.

Din medverkan till en korrekt avfallshantering av produkten bidrar till effektiv användning av naturresurserna.

Om du vill ha mer information om var du kan lämna in den här produkten, kontakta ditt lokala kommunkontor, berörd myndighet eller företag för avfallshantering eller se → www.canon-europe.com/weee, eller

→ www.canon-europe.com/battery.

Pouze Evropská unie a EHP (Norsko, Island a Lichtenštejnsko)

Tento symbol znamená, že podle směrnice OEEZ (2012/19/EU), směrnice o bateriích (2006/66/ES) a/nebo podle vnitrostátních právních předpisů k těmto směrnici nemá být tento výrobek likvidován s odpadem z domácností.

Je-li v souladu s požadavky směrnice o bateriích vytištěna pod výše uvedeným symbolem chemická značka, udává, že tato baterie nebo akumulátor obsahuje těžké kovy (Hg = rtuť, Cd = kadmium, Pb = olovo) v koncentraci vyšší, než je příslušná hodnota předepsaná směrnicí.

Tento výrobek má být vrácen do určeného sběrného místa, např. v rámci autorizovaného systému odběru jednoho výrobku za jeden nově prodaný podobný výrobek, nebo do autorizovaného sběrného místa pro recyklaci odpadních elektrických a elektronických zařízení (OEEZ), baterií a akumulátorů. Nevhodné nakládání s tímto druhem odpadu by mohlo mít negativní dopad na životní prostředí a lidské zdraví, protože elektrická a elektronická zařízení zpravidla obsahují potenciálně nebezpečné látky. Vaše spolupráce na správné likvidaci tohoto výrobku napomůže efektivnímu využívání přírodních zdrojů.

Chcete-li získat podrobné informace týkající se recyklace tohoto výrobku, obraťte se prosím na místní úřad, orgán pro nakládání s odpady, schválený systém nakládání s odpady či společnost zajišťující likvidaci domovního odpadu, nebo navštivte webové stránky → www.canon-europe.com/weee nebo → www.canon-europe.com/battery .

Csak az Európai Unió és az EGT (Norvégia, Izland és Liechtenstein) országaiban

Ezek a szimbólumok azt jelzik, hogy a termék hulladékkezelése a háztartási hulladéktól különválasztva, az elektromos és elektronikus berendezések hulladékairól (WEEE) szóló (2012/19/EU) irányelvnek és az elemekről és akkumulátorokról, valamint a hulladék elemekről és akkumulátorokról szóló (2006/66/EK) irányelvnek megfelelően és/vagy ezen irányelveknek megfelelő helyi előírások szerint történik.

Amennyiben a fent feltüntetett szimbólum alatt egy vegyjel is szerepel, az elemekről és akkumulátorokról szóló irányelvben foglaltak értelmében ez azt jelzi, hogy az elem vagy az akkumulátor az irányelvben meghatározott határértéknél nagyobb mennyiségben tartalmaz nehézfémeket (Hg = higany, Cd = kadmium, Pb = ólom).

E terméket az arra kijelölt gyűjtőhelyre kell juttatni – pl. hasonló termék vásárlásakor a régi becserelésére vonatkozó hivatalos program keretében, vagy az elektromos és elektronikus berendezések (EEE) hulladékainak gyűjtésére, valamint a hulladék elemek és hulladék akkumulátorok gyűjtésére kijelölt hivatalos gyűjtőhelyre. Az ilyen jellegű hulladékok nem előírászerű kezelése az elektromos és elektronikus berendezésekhez (EEE) általánosan kapcsolható potenciálisan veszélyes anyagok révén hatással lehet a környezetre és az egészségre.

E termék megfelelő leselejtezésével Ön is hozzájárul a természeti források hatékony használatához.

A termék újrahasznosítását illetően informálódjon a helyi polgármesteri hivatalnál, a helyi közterület-fenntartó vállalatnál, a hivatalos hulladéklerakó telephelyen vagy a háztartási hulladék begyűjtését végző szolgáltatónál, illetve látogasson el a → www.canon-europe.com/weee , vagy → www.canon-europe.com/battery internetes oldalra.

Tylko dla krajów Unii Europejskiej oraz EOG (Norwegia, Islandia i Liechtenstein)

Te symbole oznaczają, że produktu nie należy wyrzucać razem z odpadami gospodarstwa domowego, zgodnie z dyrektywą WEEE w sprawie zużytego sprzętu elektrycznego i elektronicznego (2012/19/UE) lub dyrektywą w sprawie baterii (2006/66/WE) bądź przepisami krajowymi wdrażającymi te dyrektywy.

Jeśli pod powyższym symbolem znajduje się symbol chemiczny, zgodnie z dyrektywą w sprawie baterii oznacza to, że bateria lub akumulator zawiera metal ciężki (Hg = rtęć, Cd = kadm, Pb = ołów) w stężeniu przekraczającym odpowiedni poziom określony w dyrektywie w sprawie baterii.

Użytkownicy baterii i akumulatorów mają obowiązek korzystać z dostępnego programu zwrotu, recyklingu i utylizacji baterii oraz akumulatorów.

Niewłaściwe postępowanie z tego typu odpadami może mieć wpływ na środowisko i zdrowie ludzi ze względu na substancje potencjalnie niebezpieczne, związane ze zużytym sprzętem elektrycznym i elektronicznym.

Państwa współpraca w zakresie właściwej utylizacji tego produktu przyczyni się do efektywnego wykorzystania zasobów naturalnych.

W celu uzyskania informacji o sposobie recyklingu tego produktu prosimy o kontakt z właściwym urzędem miejskim lub zakładem gospodarki komunalnej bądź zapraszamy na stronę → www.canon-europe.com/weee , lub → www.canon-europe.com/battery .

Platí len pre štáty Európskej únie a EHP (Nórsko, Island a Lichtenštajnsko)

Tieto symboly označujú, že podľa Smernice o odpade z elektrických a elektronických zariadení (OEEZ) 2012/19/EÚ, Smernice o batériách (2006/66/ES) a podľa platnej legislatívy Slovenskej republiky sa tento produkt nesmie likvidovať spolu s komunálnym odpadom.

Ak je chemická značka vytlačená pod vyššie uvedeným symbolom, znamená to, že táto batéria alebo akumulátor obsahuje ťažký kov (Hg = ortuť, Cd = kadmium, Pb = olovo) v koncentrácii vyššej, ako je príslušná povolená hodnota stanovená v Smernici o batériách.

Produkt je potrebné odovzdať do určenej zberne, napr. prostredníctvom výmeny za kúpu nového podobného produktu, alebo na autorizované zberné miesto, ktoré spracúva odpad z elektrických a elektronických zariadení (EEZ), batérií a akumulátorov. Nesprávna manipulácia s takýmto typom odpadu môže mať negatívny vplyv na životné prostredie a ľudské zdravie, pretože elektrické a elektronické zariadenia obsahujú potenciálne nebezpečné látky.

Spolupracou na správnej likvidácii tohto produktu prispejete k účinnému využívaniu prírodných zdrojov. Ďalšie informácie o recyklácii tohto produktu získate od miestneho úradu, úradu životného prostredia, zo schváleného plánu OEEZ alebo od spoločnosti, ktorá zaisťuje likvidáciu komunálneho odpadu. Viac informácií nájdete aj na webovej stránke: → www.canon-europe.com/weee , alebo → www.canon-europe.com/battery .

Üksnes Euroopa Liit ja EMP (Norra, Island ja Liechtenstein)

Antud sümbolid viitavad sellele, et vastavalt elektri- ja elektroonikaseadmete jäätmeid käsitlevale direktiivile (2012/19/EL), patareisid ja akusid ning patarei- ja akujäätmeid käsitlevale direktiivile (2006/66/EÜ) ja/või nimetatud direktiive rakendavatele riiklikele õigusaktidele ei või seda toodet koos olmejäätmetega ära visata. Kui keemiline sümbol on trükitud eespool toodud sümboli alla, siis tähendab see, et antud patareis või akus leiduva raskemetalli (Hg = elavhõbe, Cd = kaadmium, Pb = plii) kontsentratsioonitase on kõrgem kui patareisid ja akusid ning patarei- ja akujäätmeid käsitlevas direktiivis sätestatud piirmäär. Antud tootest tekkinud jäätmed tuleb anda vastavasse kogumispunkti, nt müügipunkti, mis on volitatud üks ühe vastu vahetama, kui ostate uue sarnase toote, või vastavasse elektri- ja elektroonikaseadmete jäätmete ning patareide ja akude ümbertöötlemiseks mõeldud kogumispunkti. Antud liiki jäätmete vale käitlemine võib kahjustada keskkonda ja inimeste tervist elektri- ja elektroonikajäätmetes tavaliselt leiduvate potentsiaalselt ohtlike ainete tõttu. Antud tootest tekkinud jäätmete nõuetekohase kõrvaldamisega aitate kasutada loodusvarasid efektiivselt. Täiendava teabe saamiseks elektri- ja elektroonikaseadmetest tekkinud jäätmete ning patarei- ja akujäätmete taastamise ja ümbertöötlemise kohta võtke ühendust kohaliku omavalitsusega, asjakohase valitsusasutusega, asjakohase tootjavastutusorganisatsiooniga või olmejäätmete käitlejaga. Lisateavet leitate ka Interneti-leheküljelt → www.canon-europe.com/weee või → www.canon-europe.com/battery .

Tikai Eiropas Savienībai un EEZ (Norvēģijai, Islandei un Lihtenšteinai)

Šie simboli norāda, ka atbilstoši ES Direktīvai (2012/19/ES) par elektrisko un elektronisko iekārtu atkritumiem (EEIA), Direktīvai (2006/66/EK) par baterijām un akumulatoriem, un akumulatoru atkritumiem, ar ko atceļ Direktīvu 91/157/EEK, un vietējiem tiesību aktiem šo izstrādājumu nedrīkst izmest kopā ar sadzīves atkritumiem. Ja zem iepriekš norādītā simbola ir uzdrukāts ķīmiskais simbols, saskaņā ar direktīvu par baterijām un akumulatoriem tas nozīmē, ka šīs baterijas vai akumulatori satur smagos metālus (Hg = dzīvsudrabs, Cd = kadmījs, Pb = svins) un to koncentrācijas līmenis pārsniedz direktīvā par baterijām un akumulatoriem minēto piemērojamo sliekšni. Šis izstrādājums ir jānodod piemērotā savākšanas vietā, piemēram, apstiprinātā veikalā, kur iegādājaties līdzīgu jaunu produktu un atstājat veco, vai apstiprinātā vietā izlietotu elektrisko un elektronisko iekārtu un bateriju un akumulatoru pārstrādei. Nepareiza šāda veida atkritumu apsaimniekošana var apdraudēt vidi un cilvēka veselību tādu iespējami bīstamu vielu dēļ, kas parasti ir elektriskajās un elektroniskajās iekārtās. Jūsu atbalsts pareizā šāda veida atkritumu apsaimniekošanā sekmēs efektīvu dabas resursu izmantošanu. Lai saņemtu pilnīgāku informāciju par šāda veida izstrādājumu nodošanu otrreizējai pārstrādei, sazinieties ar vietējo pašvaldību, atkritumu savākšanas atbildīgo dienestu, pilnvaroto organizāciju vai iestādi, kas veic sadzīves atkritumu apsaimniekošanu, vai apmeklējiet tīmekļa vietni → www.canon-europe.com/weee , vai → www.canon-europe.com/battery .

Tik Europos Sąjungai ir EEE (Norvegijai, Islandijai ir Lichtenšteinui)

Šie simboli reiškia, kad šio gaminių negalima išmesti į buitines atliekas, kaip reikalaujama WEEE Direktyvoje (2012/19/ES) ir Baterijų direktyvoje (2006/66/EB) ir (ar) jūsų šalies nacionaliniuose įstatymuose, kuriais šios Direktyvos yra įgyvendinamos. Jeigu cheminio ženklo simbolis yra nurodytas žemiau šio ženklo, tai reiškia, kad vadovaujantis Baterijų direktyvą, baterijų ar akumuliatorių sudėtyje yra sunkiųjų metalų (Hg = gyvsidabris, Cd = kadmio, Pb = švino), kurių koncentracija viršija Baterijų direktyvoje nurodytas leistinas ribas. Šį gaminį reikia pristatyti į specialųjį surinkimo punktą, pavyzdžiui, mainais, kai jūs perkate naują panašų gaminį, arba į specialiąją surinkimo vietą, kurioje perdirbamos elektrinės ir elektroninės įrangos atliekos bei naudotos baterijos ir akumuliatoriai. Dėl netinkamo šio tipo atliekų tvarkymo gali nukentėti aplinka ir iškilti grėsmė žmogaus sveikatai dėl galimai kenksmingų medžiagų, iš esmės susijusių su elektrine ir elektronine įranga. Bendradarbiaudami ir teisingai utilizuodami šiuos gaminius, jūs padėsite efektyviai naudoti gamtinius išteklius. Daugiau informacijos apie gaminių perdirbimą jums gali suteikti vietinis biuras, atliekų tvarkymo bendrovė, sertifikuoti organai ar buitinių atliekų surinkimo įmonės. Taip pat siūloma apsilankyti interneto svetainėje → www.canon-europe.com/weee , arba → www.canon-europe.com/battery .

Samo za Evropsko unijo in EGP (Norveška, Islandija in Lihtenštajn)

Ti simboli pomenijo, da tega izdelka skladno z Direktivo OEEO (2012/19/EU), Direktivo 2006/66/ES in/ali nacionalno zakonodajo, ki uvaja ti direktivi, ne smete odlagati z nesortiranimi gospodinjskimi odpadki.

Če je pod zgoraj prikazanim simbolom natisnjen kemijski simbol, to v skladu z Direktivo pomeni, da je v tej bateriji ali akumulatorju prisotna težka kovina (Hg = živo srebro, Cd = kadmij, Pb = svinec), in sicer v koncentraciji, ki je nad relevantno mejno vrednostjo, določeno v Direktivi.

Ta izdelek je potrebno odnesti na izbrano zbirno mesto, t. j. pooblaščen trgovino, kjer ob nakupu novega (podobnega) izdelka vrnete starega, ali na pooblaščen zbirno mesto za ponovno uporabo odpadne električne in elektronske opreme (EEO) ter baterij in akumulatorjev. Neustrezno ravnanje s to vrsto odpadkov lahko negativno vpliva na okolje in človeško zdravje zaradi potencialno nevarnih snovi, ki so pogosto povezane z EEO.

Vaše sodelovanje pri pravilnem odlaganju tega izdelka predstavlja pomemben prispevek k smotrni izrabi naravnih virov.

Za več informacij o ponovni uporabi tega izdelka se obrnite na lokalni mestni urad, pristojno službo za odpadke, predstavnika pooblaščenega programa za obdelavo odpadkov ali na lokalno komunalo. Lahko pa tudi obiščete našo spletno stran → www.canon-europe.com/weee, ali → www.canon-europe.com/battery.

Само за Европейския съюз и ЕИП (Норвегия, Исландия и Лихтенщайн)

Тези символи показват, че този продукт не трябва да се изхвърля заедно с битовите отпадъци съгласно Директивата за ИУЕЕО (2012/19/ЕС), Директивата за батерии (2006/66/ЕО) и/или Вашето национално законодателство, прилагащо тези Директиви.

Ако под показания горе символ е отпечатан символ за химически елемент, съгласно разпоредбите на Директивата за батерии, този втори символ означава наличието на тежък метал (Hg = живак, Cd = кадмий, Pb = олово) в батерията или акумулатора в концентрация над указаната граница за съответния елемент в Директивата.

Този продукт трябва да бъде предаден в предназначен за целта пункт за събиране, например на база размяна, когато купувате нов подобен продукт, или в одобрен събирателен пункт за рециклиране на излязло от употреба електрическо и електронно оборудване (ИУЕЕО), батерии и акумулатори. Неправилното третиране на този тип отпадъци може да доведе до евентуални отрицателни последици за околната среда и човешкото здраве поради потенциално опасните вещества, които обикновено са свързани с ЕЕО.

В същото време Вашето съдействие за правилното изхвърляне на този продукт ще допринесе за ефективното използване на природните ресурси.

За повече информация относно това къде можете да предадете за рециклиране на този продукт, моля свържете се с Вашите местни власти, с органа, отговорен за отпадъците, с одобрената система за ИУЕЕО или с Вашата местна служба за битови отпадъци, или посетете → www.canon-europe.com/weee, или → www.canon-europe.com/battery.

Doar pentru Uniunea Europeană și EEA (Norvegia, Islanda și Liechtenstein)

Aceste simboluri indică faptul că acest produs nu trebuie aruncat împreună cu deșeurile menajere, în conformitate cu Directiva DEEE (2012/19/UE), Directiva referitoare la baterii (2006/66/CE) și/sau legile dvs. naționale ce implementează aceste Directive.

Dacă un simbol chimic este imprimat sub simbolul de mai sus, în conformitate cu Directiva referitoare la baterii, acest simbol indică prezența în baterie sau acumulator a unui metal greu (Hg = Mercur, Cd = Cadmiu, Pb = Plumb) într-o concentrație mai mare decât pragul admis specificat în Directiva referitoare la baterii.

Acest produs trebuie înmânat punctului de colectare adecvat, ex: printr-un schimb autorizat unu la unu atunci când cumpărați un produs nou similar sau la un loc de colectare autorizat pentru reciclarea reziduurilor de echipament electric și electronic (EEE) și baterii și acumulatori. Administrarea neadecvată a acestui tip de deșeuri, ar putea avea un impact asupra mediului și asupra sănătății umane datorită substanțelor cu potențial de risc care sunt în general asociate cu EEE.

Cooperarea dvs. în direcția reciclării corecte a acestui produs va contribui la o utilizare eficientă a resurselor naturale.

Pentru mai multe informații despre reciclarea acestui produs, vă rugăm să contactați biroul dvs. local, autoritățile responsabile cu deșeurile, schema aprobată sau serviciul dvs. responsabil cu deșeurile menajere sau vizitați-ne la → www.canon-europe.com/weee, sau → www.canon-europe.com/battery.

Samo za Europsku uniju i EEA (Norveška, Island i Lihtenštajn)

Oznaka pokazuje da se ovaj proizvod ne smije odlagati s komunalnim i ostalim vrstama otpada, u skladu s direktivom WEEE (2012/19/EC), Direktivom o baterijama (2006/66/EC) i Pravilnikom o gospodarenju otpadnim baterijama i akumulatorima te Pravilnikom o gospodarenju otpadnim električnim i elektroničkim uređajima i opremom.

Ako je ispod prethodno prikazane oznake otisnut kemijski simbol, u skladu s Direktivom o baterijama, to znači da se u ovoj bateriji ili akumulatoru nalazi teški metal (Hg = živa, Cd = kadmij, Pb = olovo) i da je njegova koncentracija iznad razine propisane u Direktivi o baterijama.

Ovaj bi proizvod trebalo predati ovlaštenom skupljaču EE otpada ili prodavatelju koji je dužan preuzeti otpadni proizvod po sistemu jedan za jedan, ukoliko isti odgovara vrsti te je obavljao primarne funkcije kao i isporučena EE oprema. Otpadne baterije i akumulatori predaju se ovlaštenom skupljaču otpadnih baterija ili akumulatora ili prodavatelju bez naknade i obveze kupnje za krajnjeg korisnika. Neodgovarajuće rukovanje ovom vrstom otpada može utjecati na okoliš i ljudsko zdravlje zbog potencijalno opasnih supstanci koje se najčešće nalaze na takvim mjestima.

Vaša suradnja u pravilnom zbrinjavanju ovog proizvoda pridonijet će djelotvornom iskorištavanju prirodnih resursa. Dodatne informacije o recikliranju ovog proizvoda zatražite od svog lokalnog gradskog ureda, službe za zbrinjavanje otpada, odobrenog programa ili komunalne službe za uklanjanje otpada ili pak na stranicama

→ www.canon-europe.com/weee ili → www.canon-europe.com/battery .

Només per a la Unió Europea i a l'Espai Econòmic Europeu (Noruega, Islàndia i Liechtenstein)

Aquests símbols indiquen que aquest producte no s'ha de llençar amb les escombraries de la llar, d'acord amb la RAEE (2012/19/UE), la Directiva relativa a piles i acumuladors (2006/66/CE) i la legislació nacional que implementi aquestes directives.

Si al costat d'aquest símbol hi apareix imprès un símbol químic, segons especifica la Directiva relativa a piles i acumuladors, significa que la bateria o l'acumulador conté un metall pesant (Hg = mercuri, Cd = cadmi, Pb = plom) en una concentració superior al límit aplicable especificat en la Directiva.

Aquest producte s'hauria de lliurar en un dels punts de recollida designats, com per exemple, intercanviant un per un en comprar un producte similar o lliurant-lo en un lloc de recollida autoritzat per al reciclatge de residus d'aparells elèctrics i electrònics (RAEE) i piles i acumuladors. La manipulació inadequada d'aquest tipus de residus podria tenir un impacte negatiu en l'entorn i en la salut humana, a causa de les substàncies potencialment perilloses que normalment estan associades a l'RAEE.

La vostra cooperació a l'hora de rebutjar correctament aquest producte contribuirà a la utilització efectiva dels recursos naturals.

Els usuaris tenen dret a retornar les bateries o els acumuladors usats sense cap càrrec. El preu de venda de les bateries i els acumuladors inclou el cost de la gestió ambiental dels residus i no es necessari mostrar l'import d'aquest cost en aquest fullet o en la factura que es lliuri a l'usuari final.

Per a més informació sobre el reciclatge d'aquest producte, contacteu amb l'oficina municipal, les autoritats encarregades dels residus, el pla de residus homologat o el servei de recollida d'escombraries domèstiques de la vostra localitat o visiteu → www.canon-europe.com/weee , o → www.canon-europe.com/battery .

Korisnici u Srbiji

Ovaj simbol označava da ovaj proizvod ne sme da se odlaže sa ostalim kućnim otpadom, u skladu sa WEEE Direktivom (2012/19/EU), Direktivom o baterijama (2006/66/EC) i nacionalnim zakonima.

Ukoliko je ispod gore navedenog simbola odštampan hemijski simbol, u skladu sa Direktivom o baterijama, ovaj simbol označava da su u ovoj bateriji ili akumulatoru prisutni teški metali (Hg – živa, Cd – kadmijum, Pb - olovo) u koncentracijama koje premašuju prihvatljivi prag naveden u Direktivi o baterijama.

Ovaj proizvod treba predati određenom centru za prikupljanje, npr. po principu „jedan-za-jedan“ kada kupujete sličan novi proizvod, ili ovlašćenom centru za prikupljanje za reciklažu istrošene električne i elektronske opreme (EEE), baterija i akumulatora. Nepravilno rukovanje ovom vrstom otpada može imati negativne posledice po životnu sredinu i ljudsko zdravlje usled potencijalno opasnih materijala koji se uglavnom vezuju za EEE.

Vaša saradnja na ispravnom odlaganju ovog proizvoda će doprineti efikasnom korišćenju prirodnih resursa.

Više informacija o tome kako možete da reciklirate ovaj proizvod potražite od lokalnih gradskih vlasti, komunalne službe, odobrenog plana reciklaže ili servisa za odlaganje kućnog otpada, ili posetite stranicu

→ www.canon-europe.com/weee , ili → www.canon-europe.com/battery .

Memo

Index

A

Accounting 507, 508, 511, 515
Additional Settings Pane 284
Adjusting the Color in the Printer Driver 60
Adjusting the Vacuum Strength 570

B

Bonjour Network 493

C

CAD 52, 56, 57, 58
Checking Ink Tank Levels 583
Cleaning 586, 599, 601
Clearing a Jammed Sheet 622
Color Adjustment 172, 176, 296, 314
Color imageRUNNER Enlargement Copy 221, 222
Configuring the IP Address 486, 487, 497
Cutting Mode 662

D

Deleting Saved Jobs 531
Device Settings Sheet 188
Device Setup Utility 497
Drying Time 358

F

Favorites Sheet 185
Free Layout 199, 201, 307, 308

G

GARO Wxxxx (x represents a number) 671

H

Hardware error 671

I

Interface 463

L

Large-Format Printing 101
Layout Sheet 182
Loading and Printing on Sheets 21

M

Main Pane 272
Main Sheet 166
Maintenance Cartridge 593, 597, 598, 668
Menu Operations 439, 440
Menu Structure 443

N

Navigate 436

Nozzle 585

O

Orientation 148, 149, 150, 246, 256
Output Method 180
Oversize 83

P

Page Setup Pane 283
Page Setup Sheet 177
Paper Feed Slot 628
Personal Box 540, 543
PosterArtist 50
Power 247, 249, 250, 252, 254, 255, 256
Preparing to Transfer the Printer 606
Print Job Log 515, 516
Printer Driver Settings 158, 268
Printer Hard Disk Operations 475
Printhead 556, 559, 585, 586, 587, 634, 666
Printing Posters in Sections 126
Printing Saved Jobs 527
Printing Vertical or Horizontal Banners 101, 102, 105
Printing at Actual Size 87, 88, 90
Printing on Rolls 18

R

Removing the Roll 352, 356
Replacing Ink Tanks 574
Roll Holder 342, 368

S

Saving Print Jobs 520, 538
Size Options 181
Special Settings 184, 265
Specifications 674
Specifying Paper in the Printer Driver 30, 160, 269
Status Print 460
Support Sheet 187

U

Utility Sheet 186

W

Watermark 146, 147
When to Replace Ink Tanks 583

