

Software for Playing, Merging and Saving Movies

EOS MOVIE Utility

Ver. 1.4



Instruction Manual

● Content of this Instruction Manual

- EMU is used for EOS MOVIE Utility.
- Camera model is displayed as an icon.
Example: EOS-1D C →
- displays the relevant camera model.
- indicates the selection procedure of the menu.
(Example: [File] menu [Quit].)
- Square brackets are used to indicate items such as menu names, button names and window names that appear on the computer screen.
- Text inside < > indicates a key on the keyboard.
- p.** indicates a reference page.
Click to move to the relevant page.
- : Marks information that should be read before use.
- : Marks additional information you may find helpful.

● Switching Between Pages

- Click on arrows on the bottom right of the screen.
 - : next page
 - : previous page
 - : return to a page you had previously displayed
- Click on the headings on the right side of the screen to switch to the contents page of that heading. Also, click the item you want to read about on the table of contents to move to the relevant page.

Introduction

Contents

Preparation

Basic
Screen

Playing Back

Confirming File
Information

Saving

Quitting EMU

Reference

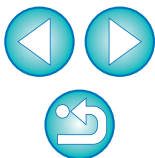

READ CAREFULLY BEFORE USING!

CANON SOFTWARE LICENSE AGREEMENT

IMPORTANT - READ THIS AGREEMENT BEFORE USING THE SOFTWARE ON THE CD-ROM IN THIS BOX. BY USING THE SOFTWARE, YOU AGREE TO BE BOUND BY THE TERMS OF THIS AGREEMENT.

This is a license agreement (the [Agreement]) between you and Canon Inc. ([Canon]).

IF YOU DO NOT AGREE TO THE TERMS AND CONDITIONS OF THIS AGREEMENT, DO NOT USE THE SOFTWARE PROGRAM ON THE CD-ROM AND THE USER MANUAL IN THIS BOX (COLLECTIVELY, THE [SOFTWARE]) AND RETURN THE SOFTWARE WITHIN 30 DAYS FROM THE DATE OF PURCHASE TO YOUR POINT OF PURCHASE FOR A REFUND.

In consideration of the right to use the SOFTWARE, you agree to abide by the terms and conditions of this Agreement.

1. **LICENSE:** Canon grants you the non-exclusive right to use the SOFTWARE only on a single computer. You may physically transfer the SOFTWARE from one computer to another provided that the SOFTWARE is used on only one computer at a time. You shall not install or use the SOFTWARE on a network, multiple CPU, multiple site arrangement, or any other hardware configuration where the SOFTWARE is accessible to more than one CPU or to more than one user.

YOU SHALL NOT ASSIGN, SUBLICENSE, RENT, LEASE, LOAN, CONVEY OR OTHERWISE USE, TRANSFER, COPY, TRANSLATE, CONVERT TO ANOTHER PROGRAMMING LANGUAGE, ALTER, MODIFY, DECOMPILE OR DISASSEMBLE THE SOFTWARE, IN WHOLE OR IN PART, EXCEPT AS EXPRESSLY PROVIDED IN THIS AGREEMENT.

2. **BACK-UP COPY:** You may make one copy of the SOFTWARE solely for back-up purposes, or copy the SOFTWARE onto the permanent storage device (e.g. a hard disk) of your computer and retain the original for back-up purposes. Any other copying of the SOFTWARE is a violation of this Agreement. You must reproduce and include the copyright notice on the back-up copy.

3. **SUPPORT AND UPDATES:** Canon is not responsible for providing maintenance or support for use of the SOFTWARE. No updates, fixes or support will be made available for the SOFTWARE.

4. **LIMITED WARRANTY AND LIMITATION OF LIABILITY:** It is your responsibility to choose, maintain and match the hardware and software components of your computer system. Thus Canon does not guarantee uninterrupted service or correction of errors or that the functions or performance of the SOFTWARE will meet your requirements. THE SOFTWARE IS LICENSED ON AN [AS IS] BASIS AND WITHOUT WARRANTY OF ANY KIND. The CD-ROM storing the SOFTWARE is warranted only against defective material under normal use for a period of ninety (90) days after purchase from an authorized Canon dealer as evidenced by your sales receipt. Your sole remedy for a defective CD-ROM shall be replacement of the same without charge when returned by you at your expense to your point of purchase and proven to be defective upon inspection. The replacement CD-ROM will be warranted for the remainder of the original ninety (90) day warranty period of the defective CD-ROM. The limited warranty does not apply if the failure of the CD-ROM resulted from accident, abuse or misapplication of the SOFTWARE and shall not extend to anyone other than the original user of the SOFTWARE.

EXCEPT AS SPECIFICALLY SET FORTH IN THIS PARAGRAPH 4, CANON, CANON'S SUBSIDIARIES, DISTRIBUTORS AND DEALERS DISCLAIM ALL WARRANTIES, EXPRESS OR IMPLIED, INCLUDING ANY WARRANTY OF MERCHANTABILITY OR FITNESS FOR A PARTICULAR PURPOSE, WITH RESPECT TO THE SOFTWARE.

NEITHER CANON NOR ANY OF CANON'S SUBSIDIARIES, DISTRIBUTORS OR DEALERS IS LIABLE FOR ANY DAMAGES HOWSOEVER CAUSED, INCLUDING WITHOUT LIMITATION, DIRECT, CONSEQUENTIAL OR INCIDENTAL LOSS OR DAMAGE INCLUDING LOSS OF PROFITS, EXPENSE OR INCONVENIENCE HOWSOEVER CAUSED OR ARISING OUT OF THE SOFTWARE OR THE USE THEREOF.

NEITHER CANON, NOR ANY OF CANON'S SUBSIDIARIES, DISTRIBUTORS OR DEALERS SHALL HAVE ANY OBLIGATION TO INDEMNIFY YOU AGAINST ANY CLAIM OR SUIT BROUGHT BY A THIRD PARTY ALLEGING THAT THE SOFTWARE OR THE USE THEREOF INFRINGES ANY INTELLECTUAL PROPERTY OF SUCH THIRD PARTY.

5. **TERM:** This Agreement is effective upon your using the SOFTWARE and remains in effect until expiration of all copyright interests in the SOFTWARE unless earlier terminated. You may terminate this Agreement by destroying the SOFTWARE. This Agreement will also terminate without notice to you if you fail to comply with any of the terms of this Agreement and you must then promptly return the SOFTWARE. In addition, Canon may enforce its other legal rights.

6. **U.S. GOVERNMENT RESTRICTED RIGHTS NOTICE:** The SOFTWARE is provided with restricted rights. Use, duplication or disclosure is subject to restrictions as set forth in either subparagraph (c) (1) (ii) of the Rights in Technical Data and Computer software clause at DFARs 252.227-7013 or subparagraph (c) (1) and (2) of the Commercial Computer Software Restricted Rights Clause at FAR 52.227-19, as applicable.

7. **SEVERABILITY:** In the event that any provision of this Agreement is declared or found to be illegal by any court or tribunal of competent jurisdiction, such provision shall be null and void with respect to the jurisdiction of that court or tribunal and all the remaining provisions of this Agreement shall remain in full force and effect.

8. **CONTROLLING LAW:** The terms of this Agreement as it relates to purchases of the Software in the United States of America shall be governed and construed in all respects in accordance with the laws and regulations of the State of New York, without reference to choice of law principles. The terms of this Agreement as it relates to purchases of the Software in Canada shall be governed by the laws of the province of Ontario.

9. **OWNERSHIP:** All rights, including but not limited to copyrights and trade secret rights, to the SOFTWARE belong to Canon, its affiliated corporations and third party licensors. Your use of the SOFTWARE is subject to the United States, Canada and other applicable copyright and trademark laws and nothing in this Agreement constitutes a waiver of the rights of Canon, its affiliated corporations and third party licensors under such laws.

Nothing contained in Paragraph 1 shall be construed to give Canon any ownership rights in any images, graphics or textual material that you save in connection with the Software.

10. **ACKNOWLEDGEMENT:** BY USING THE SOFTWARE, YOU ACKNOWLEDGE THAT YOU HAVE READ THIS AGREEMENT, UNDERSTOOD IT, AND AGREE TO BE BOUND BY ITS TERMS AND CONDITIONS. YOU ALSO AGREE THAT THIS AGREEMENT IS THE COMPLETE AND EXCLUSIVE STATEMENT OF AGREEMENT BETWEEN YOU AND CANON CONCERNING THE SUBJECT MATTER HEREOF AND SUPERSEDES ALL PROPOSALS OR PRIOR AGREEMENTS, VERBAL OR WRITTEN, AND ANY OTHER COMMUNICATIONS BETWEEN THE PARTIES RELATING TO THE SUBJECT MATTER HEREOF. NO AMENDMENT TO THIS AGREEMENT SHALL BE EFFECTIVE UNLESS SIGNED BY A DULY AUTHORIZED OFFICER OF CANON.

Introduction

Contents

Preparation

Basic Screen

Playing Back

Confirming File Information

Saving

Quitting EMU

Reference

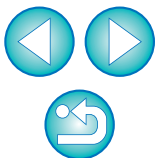

Introduction

EOS MOVIE Utility (hereinafter, “EMU”) is software for playing, merging and saving MOV format movies shot with the supported camera.

● Main Features of EMU

With EMU, you can smoothly play movie files shot with the supported camera. You can also use View Assist for playing movies shot with an EOS-1D C with Canon Log gamma. In addition, you can consecutively play back multiple 4 GB movie files created from one clip (shot successively), merge them into a single file, and save it (with EOS-1D C, EOS 5DS/EOS 5DS R, and EOS 7D Mark II). Extracting still images is also possible.

● What is Canon Log gamma?

This function allows rich gradation expression from dark points to bright points, applying a wide dynamic range. It maximizes the excellent capability of CMOS sensor.

● What is a movie clip?

A movie recorded in a single shooting operation is called a movie clip.

 Do not remove the memory card from the card reader during access.

System Requirements

- Refer to the Canon Web site for information on the system requirements.

Supported Movies

Movie type	Extension
MOV format movies shot with the supported camera*	.MOV

* Video snapshot albums are not supported.

- Video files in MP4 format are not supported.

Supported Camera

EOS-1D C	EOS-1D X	EOS 5DS/ EOS 5DS R
EOS 5D Mark III	EOS 6D	EOS 7D Mark II
EOS 70D	—	—

Introduction

Contents

Preparation

Basic
Screen

Playing Back

Confirming File
Information

Saving

Quitting EMU

Reference

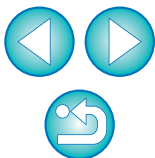

Contents

Introduction	2	Saving All the Frames where Markers are Set as Still Images.....	20
System Requirements.....	2	Merging and Saving Movie Files	21
Supported Movies	2	Checking the Movie Files in a Movie Clip.....	21
Supported Camera.....	2	Merging Split Movie Files and Saving as a Single File... ..	22
Installing the Software.....	4	Merging All the Split Movie Files in the Folder and Saving as a Single File	22
Starting up EMU.....	4	Merging Split Movie Files for a Single Movie Clip and Saving as a Single File	24
Basic Screen	5	Quitting EMU	24
Main Window	5	Reference	25
Playing Back a Movie Clip.....	6	Troubleshooting.....	25
Movie Clip Playback	6	Error Messages	26
Playback Control.....	8	Keyboard Controls.....	27
Adjusting Volume.....	9	Uninstalling the Software.....	28
Changing the Playback Speed	9	About This Instruction Manual.....	29
Moving the Playback Position.....	9	Trademarks	29
Setting Markers.....	10		
Playing a Specified Range.....	11		
Playing Back Movies Shot with Canon Log Gamma set to [On].....	12		
Playing Back in Full Screen.....	13		
Switching the Movie Display Size.....	13		
Confirming the Movie File Information	14		
Saving Still Images.....	15		
Still Image Capture Settings	15		
Still Image Saving Controls.....	17		
Saving Individual Still Images	18		
Saving Multiple Still Images.....	18		

Introduction

Contents

Preparation

Basic Screen

Playing Back

Confirming File Information

Saving

Quitting EMU

Reference

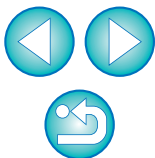

Installing the Software

⚠ When installing this software, an administrator-level privilege is required.

- 1 Double-click the compressed EMU file (.gz format) downloaded from the Canon Web site to open it.
- 2 Double-click “emum1.4.0-installer.dmg” in the folder.
→ The disk image “EMU 1.4.0” is mounted.
- 3 Double-click the disk image “EMU 1.4.0”, and double-click “emum1.4.0-installer” in the displayed folder.
- 4 Follow on-screen instructions for installation.

Starting up EMU

Click the shortcut in your desktop’s Dock.



Click

→ EMU starts up and the main window appears.

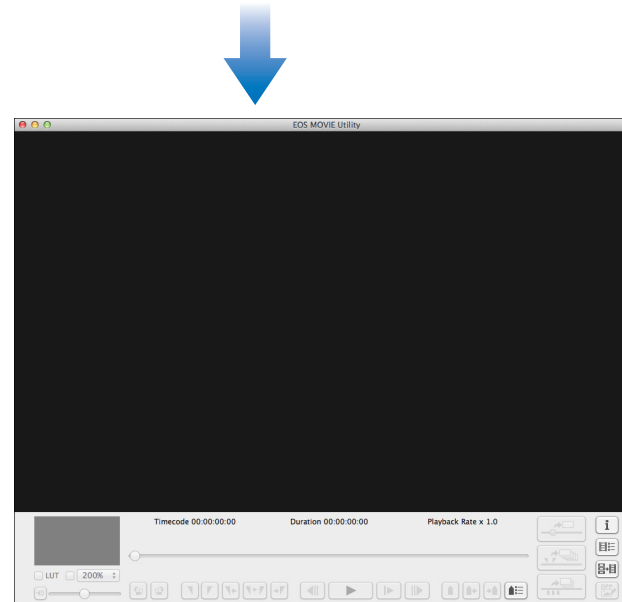

📄 Starting up multiple EMU at the same time is not possible.

Introduction

Contents

Preparation

Basic Screen

Playing Back

Confirming File Information

Saving

Quitting EMU

Reference

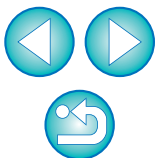

Basic Screen

Main Window

You can view, play back, stop movie clips, save still images or merge and save movie files in the main window.

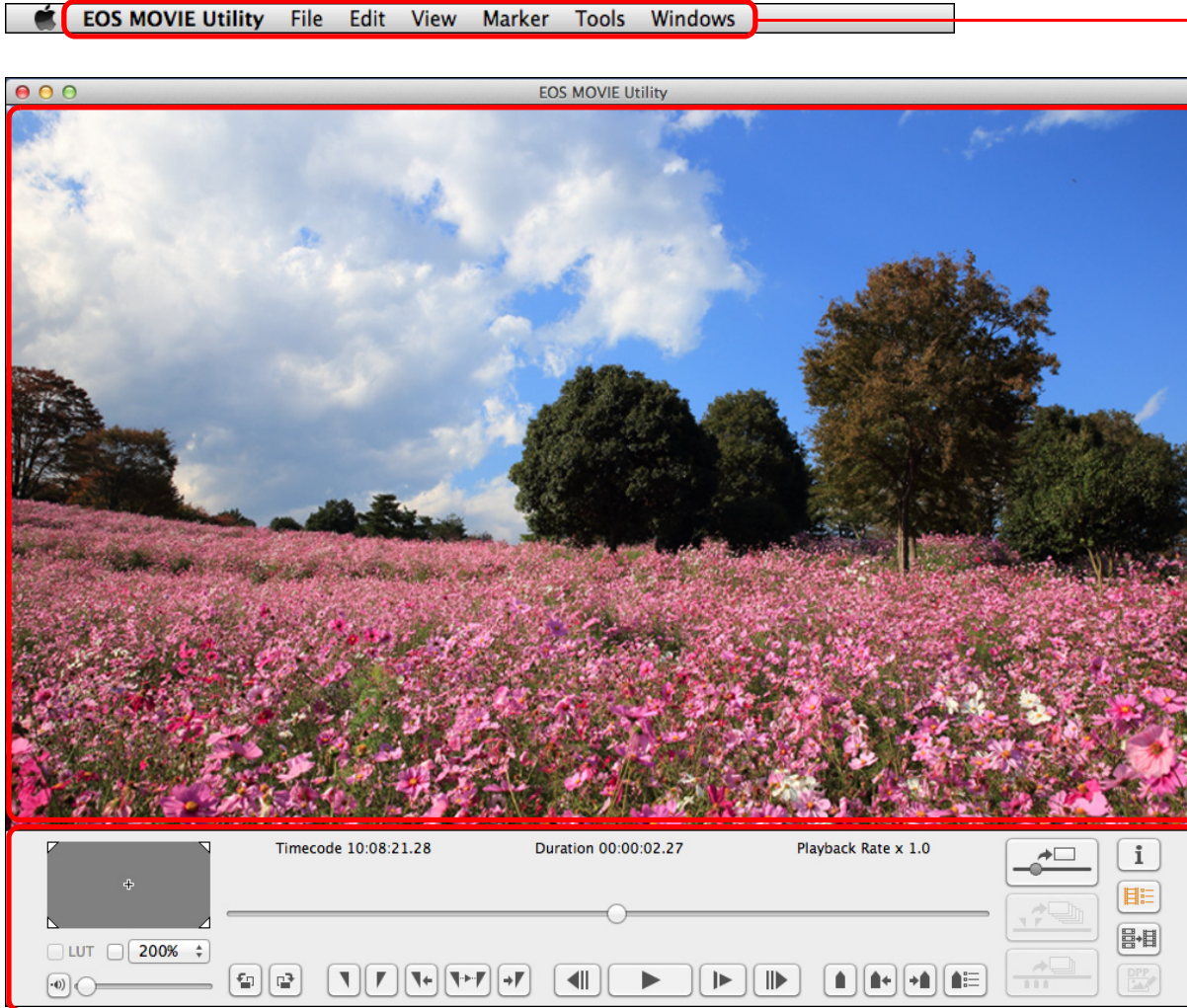

Menu

Menu to execute all functions.

Preview area

Displays a clip to be played back.

Control area

For operations such as controlling playback, capturing still images, merging and saving movie files.

- If you narrow the width of the main window, some of the items in the control area may be hidden. In this case, use the menu to control EMU.

⚠ If the message “Cannot open this file” is displayed, use software other than EMU, such as the movie playback application specified with the computer’s OS settings, to play back the movie file.

Introduction

Contents

Preparation

Basic
Screen

Playing Back

Confirming File
Information

Saving

Quitting EMU

Reference

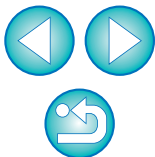

Playing Back a Movie Clip

The method for playing back a movie clip is described here. It is recommended that you first copy the folder where the movie clip is saved on the memory card to your computer with a card reader.

Movie Clip Playback

1 In the main window, select the [File] menu ► [Open...].

→ A dialog box for selecting a folder appears.

2 Select the folder where the movie clip to play is saved, and then click the [Open] button.

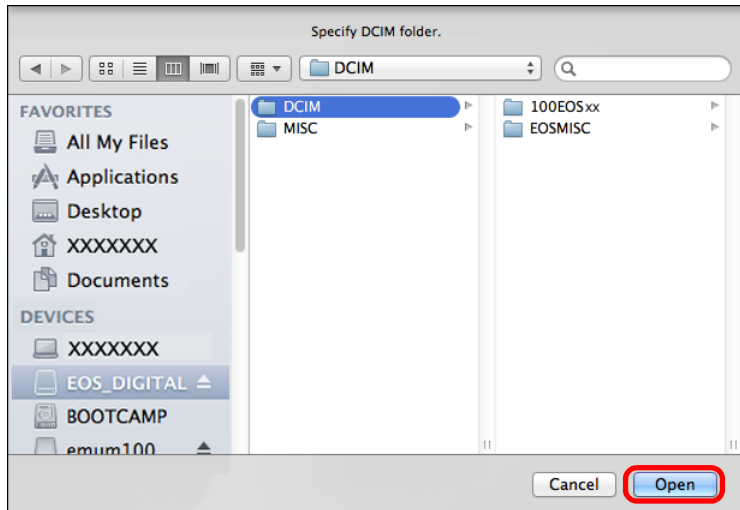

→ The [Clip list] dialog box appears.

- After inserting the memory card in the card reader, you can also connect the reader to the computer to select folders on the memory card directly.
- You cannot connect the camera to the computer to directly select folders on the camera's memory card.

! Movie files shot with a camera are recorded on the memory card with the folder structure shown below.

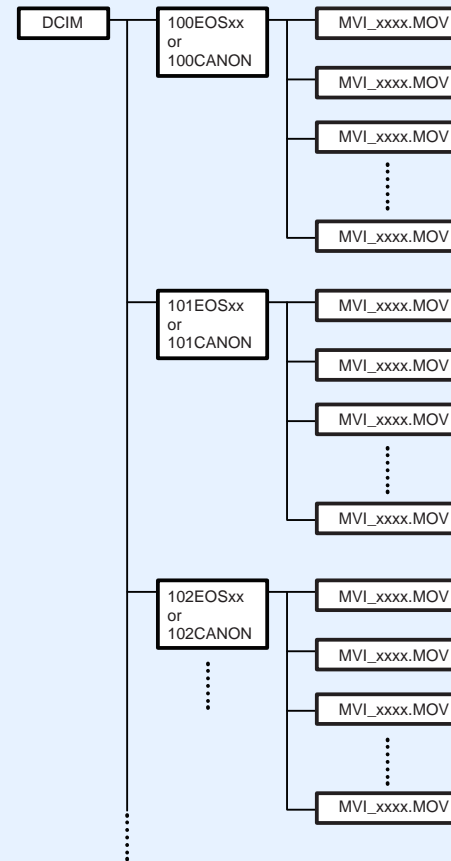

With this software, if the above folder structure is not maintained, it may not be possible to play back the movie clips properly. When playing back movie clips, make sure the above folder structure is maintained and the DCIM folder at the upper layer of the folder structure is selected. Even when the folder structure is maintained, be aware that it may not be possible to play back the clips properly if the name of the selected folder, originally [DCIM], has been changed to another name.

Introduction

Contents

Preparation

Basic Screen

Playing Back

Confirming File Information

Saving

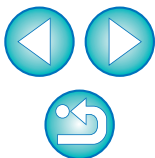

Quitting EMU

Reference

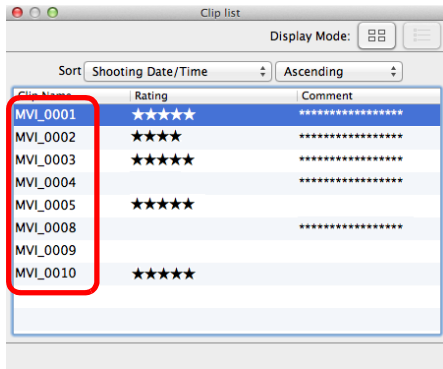

3 Select the movie clip to be played back in the [Clip list] dialog box.



- The image of the movie clip appears in the main window.
- You can click the [] button or [] button at the top of the [Clip list] dialog box to change the manner in which items are displayed.
- You can use the [Sort] function to display items in the [Clip list] by conditions such as [Shooting Date/Time], [Clip Name], [Clip Duration], or [Rating].
- You can change a [Rating] or enter a [Comment] in the [Clip list] in the menu that appears when selecting the clip with clicking while holding down the <control> key.

4 In the main window, click the [] button.

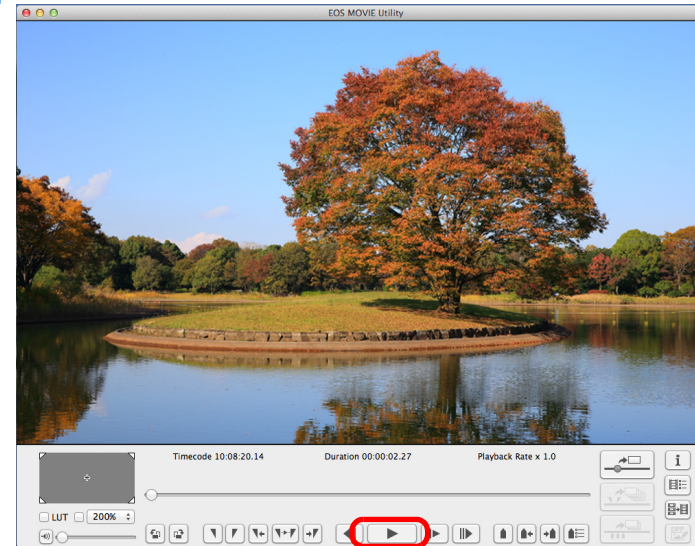

- The movie clip is played.
- Although time-lapse movies have no time codes, the start time code of such clips is indicated as 00:00:00:00 when played back in EMU.
Note that in such cases, [*] is added to the time code indication.
- For operations during playback, see [p.9](#) to [p.13](#) (“Playback Control” to “Switching the Movie Display Size”).

⚠ Consecutive playback of multiple 4 GB movie files created from one clip (shot successively) is supported for **1D C** **5DS/5DS R** **7D Mk II** .

Introduction

Contents

Preparation

Basic Screen

Playing Back

Confirming File Information

Saving

Quitting EMU

Reference

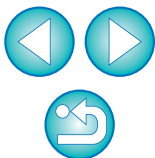

Playback Control

During playback, buttons allow you to perform the following operations.

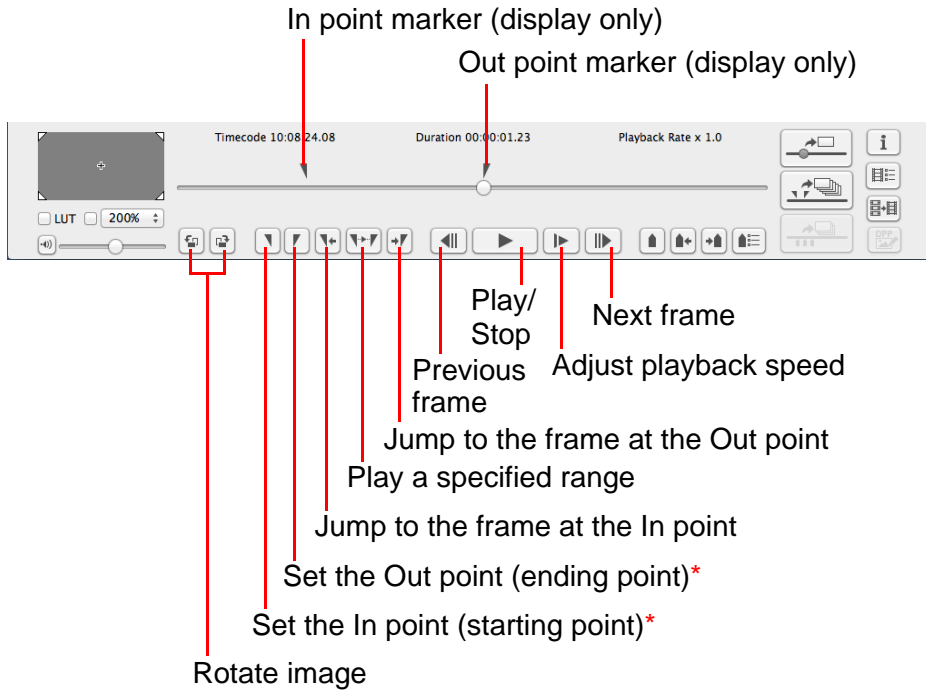

* These buttons specify the In (start) and Out (end) points when specifying a playback range (p.11) or saving multiple still images (p.18).

- If you rotate an image, the rotated state is maintained and also applies the next time you play back the movie clip. Note that the rotated state is not maintained for playback on a camera.
- If you rotate an image, the rotated state also applies to any still images you extract and save from the movie clip.
- In the [Clip list] dialog box, you can switch between movie clips with the <↑><↓> keys on the keyboard or by clicking the mouse.
- You can also double-click a movie clip name in the [Clip list] dialog box to play back a movie clip.
- Even if you close the [Clip list] dialog box, the content of the list is saved. If you click the [Clip list] (Clip list) button in the control area or select [Clip list] from the [View] menu, the [Clip list...] reappears.

Introduction

Contents

Preparation

Basic Screen

Playing Back

Confirming File Information

Saving

Quitting EMU

Reference

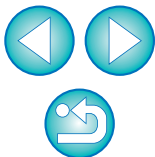

Adjusting Volume

You can adjust volume during playback with the volume slider.

Drag the volume slider left or right.

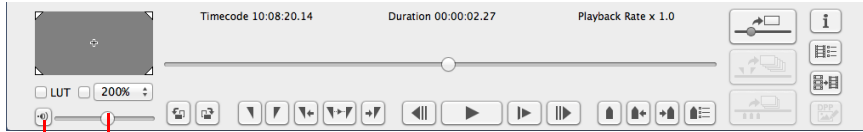

Volume slider

Mute button

- To temporarily turn audio off, click the [] (mute) button.

Changing the Playback Speed

You can change the movie playback speed.

Click the [] button while a movie is played.

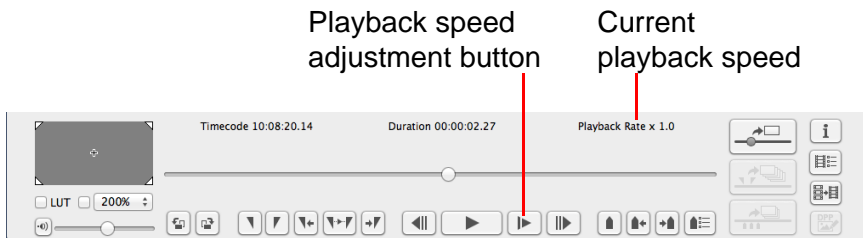

Playback speed
adjustment button

Current
playback speed

- Each time you click the [] button, the playback speed changes as follows.

Movie clip frame rate	Playback speed	Frame rate after changing playback speed
59.94p	x1.0	59.94p
	x0.5	29.97p
	x0.4	23.98p
50p	x1.0	50p
	x0.5	25p
Other than above	x1.0	Movie clip frame rate
	x0.5	1/2 the movie clip frame rate

 Audio is not played during slow playback (when playback speed is x0.5 or x0.4).

Moving the Playback Position

You can move the playback position with the frame position slider.

Drag the frame position slider left or right while a clip is played or stopped.

Frame position slider

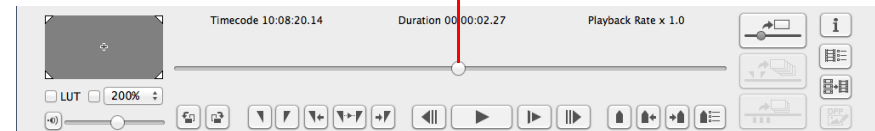

Introduction

Contents

Preparation

Basic
Screen

Playing Back

Confirming File
Information

Saving

Quitting EMU

Reference

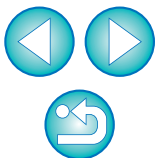

Setting Markers

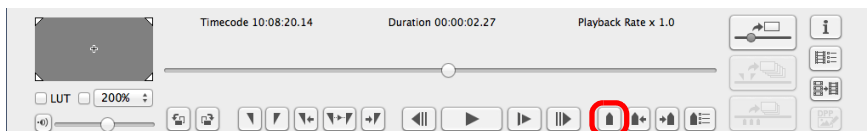

Markers can be used for tasks such as specifying the playback start position. Up to 20 markers can be set.

Drag the frame position slider left or right and click the [] (Add marker) button at the position where you want to set a marker.

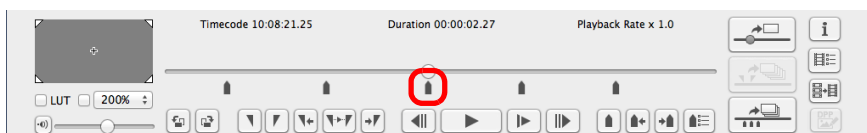

→ The marker is set.



- Click the [] or [] button to select the next marker in the arrow direction and display the frame at that position. If there is no other marker between the selected marker and the start of the clip, the first frame in the clip is selected and displayed. If there is no other marker between the selected marker and the end of the clip, the last frame in the clip is selected and displayed.
- Click the [] (Marker list) button to display the list of markers. It displays a numbered list of markers and time codes in order from the beginning of the clip.

Number	Timecode
1	01:22:28:10
2	01:22:34:22
3	01:22:43:23
4	01:22:50:09

Buttons: Move, Delete, Capture all images

- Select a number from the list and click the [Move] button to move the position of the selected marker, and the frame at that position is displayed. Effective when only one number is selected.
- Select a number from the list and click the [Delete] button to delete the selected maker.
- You can save the frames at all the marker positions on the list as still images. (p.20)
- You can set a marker by clicking the [] (Add marker) button even during playback.



The marker settings in the selected clip are saved automatically, and the settings continue to be effective the next time you work with the clip in EMU.

Introduction

Contents

Preparation

Basic Screen

Playing Back

Confirming File Information

Saving

Quitting EMU

Reference

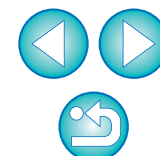

Playing a Specified Range



You can play back only a specified range of a selected clip.

1 Follow steps 1 to 3 in “Movie Clip Playback” (p.6).

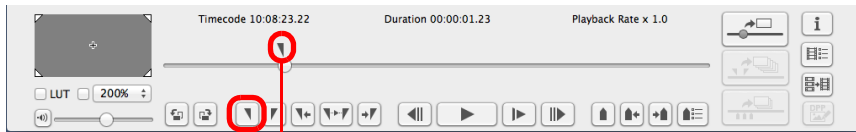
2 Drag the frame position slider left or right until the frame where you want to start playback appears, then click the In point button.





In point button In point marker

- The In point marker is now displayed, and the starting point for playback is set.
- You can click this button even during movie playback to specify the In point.
- Once you have specified the In point, you can jump to the frame at the In point by clicking the [] (move to IN point) button. If no In point has been set, clicking this button jumps to the first frame. You can click the [] (move to IN point) button even during movie playback.

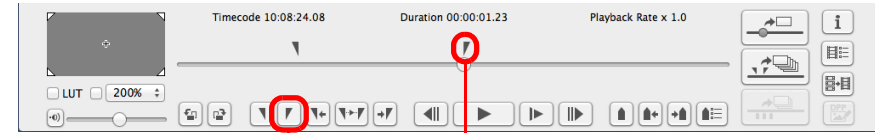
3 Drag the frame position slider left or right until the frame where you want to stop playback appears, then click the Out point button.



Out point button Out point marker

- The Out point marker is now displayed, and the ending point for playback is set.
- You can click this button even during movie playback to specify the Out point.
- Once you have specified the Out point, you can jump to the frame at the Out point by clicking the [] (move to OUT point) button. If no Out point has been set, clicking this button jumps to the last frame. You can click the [] (move to OUT point) button even during movie playback.
- The maximum range between In and Out points is one hour.

Introduction

Contents

Preparation

Basic Screen

Playing Back

Confirming File Information

Saving

Quitting EMU

Reference

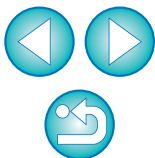

4 Click the [] (Play IN-OUT) button.

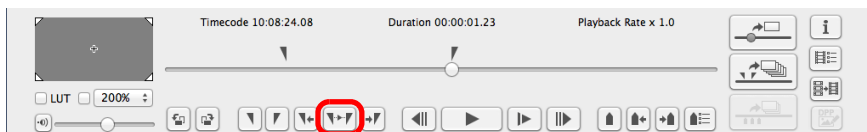

- The range of the clip between the IN point and the Out point is played back.
- The In and Out points can be removed from [Marker] on the main window menu.
Select [Delete IN point], [Delete OUT point], or [Delete both IN point and OUT point] as required.
- When no In or Out point has been set, the range played back is as follows.
 - When no In point has been set, the playback range extends from the first frame of the clip to the Out point.
 - When no Out point has been set, the playback range extends from the In point to the last frame of the clip.
 - When no In point and no Out point have been set, the playback range is the entire clip.
- Select [Play IN-OUT looped] from [Tools] on the main window menu to start looped playback between the In and Out points of the clip.

 The In and Out point settings in the selected clip are saved automatically, and the settings continue to be effective the next time you work with the clip in EMU.

Playing Back Movies Shot with Canon Log Gamma set to [On]



Movies shot with an EOS-1D C with Canon Log gamma (p.2) set to [On] will look dark and have low contrast by default. If you apply a look-up table (LUT) and view the clip, you can check the clip with an image close to normal display.

1 Checkmark the [LUT] checkbox.

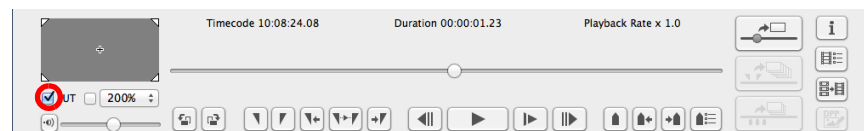

- [LUT] checkbox is not available if movies were shot with Canon Log gamma set to [Off].

2 Play back the selected movie.

- Perform the operations described in “Movie Clip Playback” (p.6).
→ The LUT is applied and the movie is played back.

 You can check or uncheck the LUT checkbox with the key on the keyboard.

Introduction

Contents

Preparation

Basic Screen

Playing Back

Confirming File Information

Saving

Quitting EMU

Reference

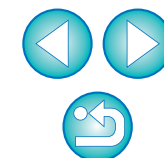

Playing Back in Full Screen

1 Play back a movie.

- Follow operations in “Movie Clip Playback” (p.6).

2 In the main window, select the [View] menu ► [Full Screen].

- The movie played back is displayed in full screen.
- You can also double-click the preview area to display the movie in full screen.
- To cancel full screen display, press the <Esc> key or double-click the mouse.

Switching the Movie Display Size

You can apply either [Fit to window] mode, [100%] mode, or [200%] mode as the method for displaying a movie in the preview area.

Select the [View] menu ► [Fit to window]/[100%] or [200%].

- The image is displayed in the preview area with the selected display mode.
- You can select [100%] or [200%] in the magnification change list box in the control area.
- In [Fit to window] mode, the image is displayed completely within the preview area.
- In [100%] mode, the image is enlarged to 100% (actual pixel size) and displayed in the preview area.
- In [200%] mode, the image is enlarged to 200% and displayed in the preview area.
- To change the display position of an image in [100%] mode or [200%] mode, drag the image in the preview area.

- If you remove the checkmark from the [100%] or [200%] checkbox in the magnification change list box, the display will change to [Fit to window] mode.
- In [100%] or [200%] mode, you can use the guide area, which represents the entire image, to check the position of the image within the preview area.
- If you checkmark the checkbox under the [View] menu ► [Do not zoom when fitting to window], the movie is displayed in the preview area at actual pixel size with no enlargement.

Enlarged position in guide area

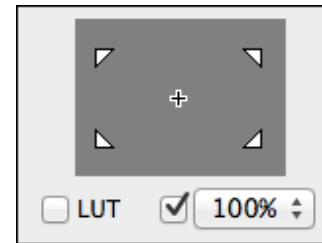

Introduction

Contents

Preparation

Basic Screen

Playing Back

Confirming File Information

Saving

Quitting EMU

Reference

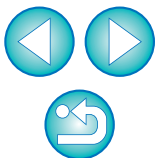

Confirming the Movie File Information

You can display and confirm shooting information for movie clips.

- 1 Click the [] (Clip list) button in the control menu on the main window.

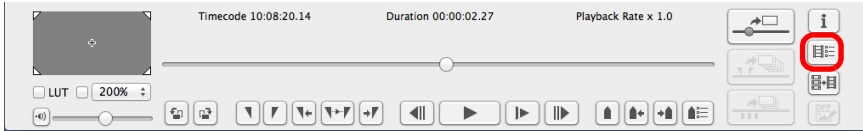

→ The [Clip list] dialog box appears.

- Note that this function is available after you select a folder in which the movie files to be confirmed are saved. If no folder is selected, follow steps 1 to 2 in “Movie Clip Playback” (p.6) to select a folder.

- 2 In the [Clip list] dialog box, select a movie clip to display its shooting information.

- 3 Click the [] (Shooting information) button in the control menu on the main window.

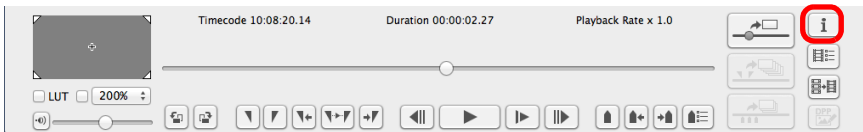

→ The shooting information is displayed in the [Shooting Information] window.

- The shooting information includes the model name of the camera used, and the items displayed may differ depending on the settings used during shooting.

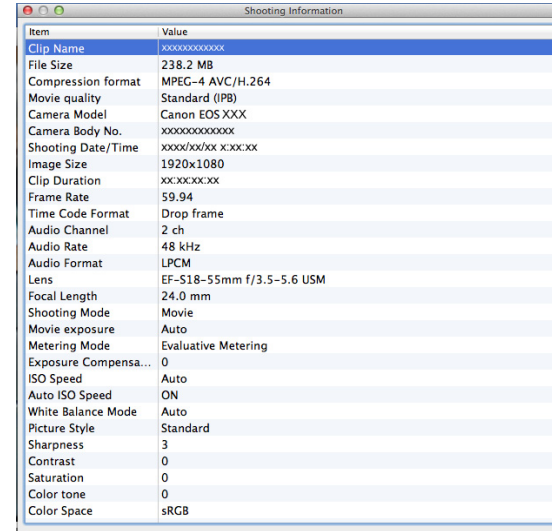

Item	Value
Clip Name	xxxxxxxxxxxx
File Size	238.2 MB
Compression format	MPEG-4 AVC/H.264
Movie quality	Standard (IPB)
Camera Model	Canon EOS XXX
Camera Body No.	xxxxxxxxxxxx
Shooting Date/Time	xxxx/xx/xx x:xx:xx
Image Size	1920x1080
Clip Duration	xx:xxxxxx
Frame Rate	59.94
Time Code Format	Drop frame
Audio Channel	2 ch
Audio Rate	48 kHz
Audio Format	LPCM
Lens	EF-S18-55mm f/3.5-5.6 USM
Focal Length	24.0 mm
Shooting Mode	Movie
Movie exposure	Auto
Metering Mode	Evaluative Metering
Exposure Compensa...	0
ISO Speed	Auto
Auto ISO Speed	ON
White Balance Mode	Auto
Picture Style	Standard
Sharpness	3
Contrast	0
Saturation	0
Color tone	0
Color Space	sRGB

Introduction

Contents

Preparation

Basic Screen

Playing Back

Confirming File Information

Saving

Quitting EMU

Reference

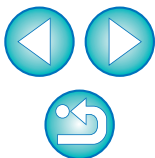

Saving Still Images

Still images can be extracted and saved from the current movie clip.

Still Image Capture Settings

First, complete the settings for how still images are saved from movies.

1 In the main window, select the [EOS MOVIE Utility] menu ► [Still Image Capture Settings...].

→ The [Still Image Capture Settings] dialog box appears.

2 On the [General] tab, complete the settings as necessary.

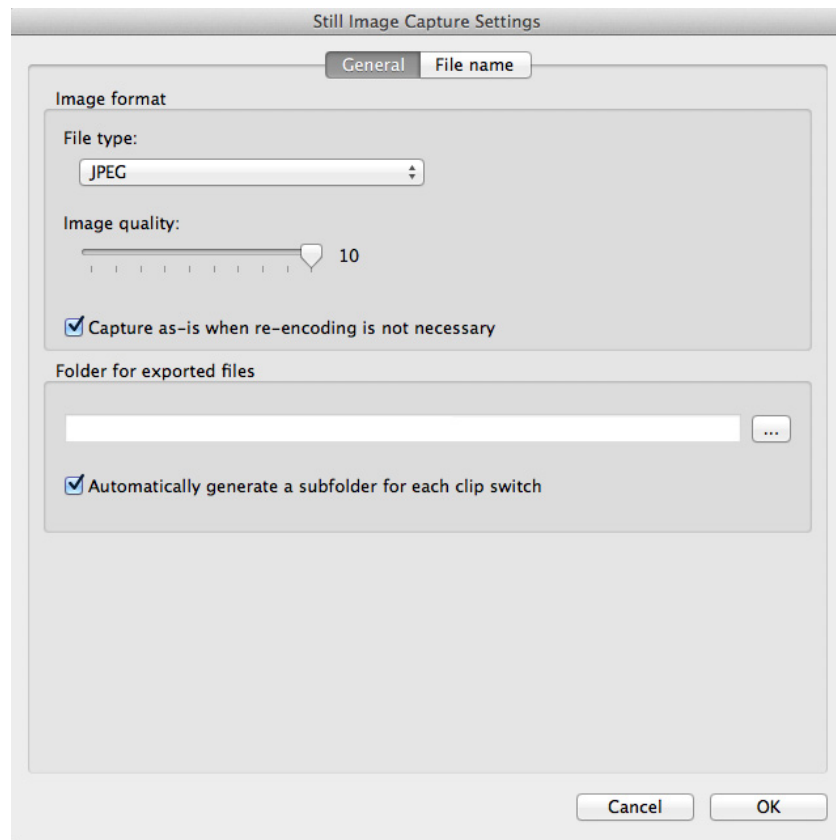

- Under [Kind of file], select the desired file format. Select [TIFF] to save images as uncompressed 8-bit RGB TIFFs. By default, [JPEG] saves images at the highest setting in [Image quality].
- When the file format specified in [Kind of file] under [Image format] is set to [JPEG] and [Capture as-is when re-encoding is not necessary] is checkmarked, still images will be extracted from movies without modifications for the following movies. Faster processing will be achieved.
 - 4K movies shot with Canon Log gamma set to [Off]
 - 4K movies shot with Canon Log gamma set to [On] without applying an LUT
- To specify the destination, click the [...] button under [Folder for Exported Files] and choose the location in the [Browse For Folder] dialog box.
- To save still images in a new subfolder, checkmark [Automatically generate a subfolder for each clip switch]. This option prevents files from being renamed if the destination folder already contains files with the same name.

Introduction

Contents

Preparation

Basic Screen

Playing Back

Confirming File Information

Saving

Quitting EMU

Reference

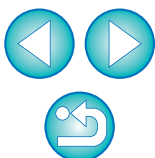

3 On the [File name] tab, complete the settings as necessary and click the [OK] button.

→ The settings are now complete.

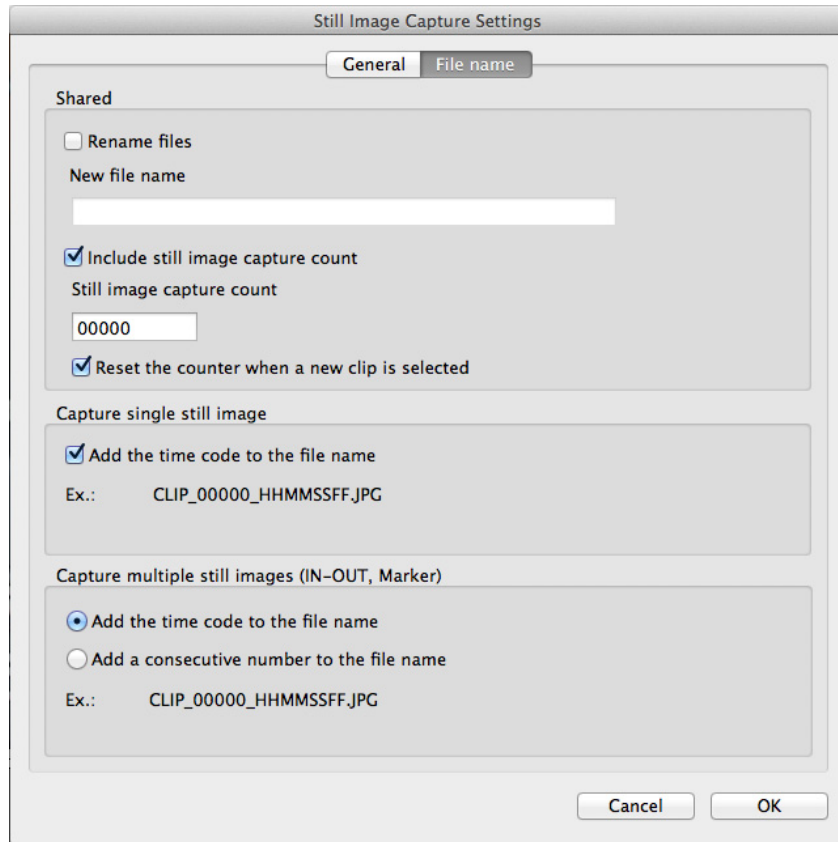

- The settings for the [Shared] items are as follows:
 - To name still image files or edit existing names, checkmark [Rename Files]. In [New file name], enter a name or change the existing name. File names can be up to 30 characters. Note that still image files cannot be renamed unless this option is checkmarked. In such a case, the file name will be the same with the original movie clip.
 - To append a serial number to file names that indicates the number of times still images have been captured from a movie clip, checkmark [Include still image capture count]. In [Still image capture count], enter the first serial number, in the range 0–99999.
 - To reset the serial number in [Still image capture count] when you select another movie clip, checkmark [Reset when selected as clip].
- If the [Include time code] checkbox of the [Capture single still image] item is checked, a time code is appended at the end of the file name when a single still image is saved.
- If [Include time code] is selected for the [Capture multiple still images (IN-OUT, Marker)] item, a time code is appended at the end of each file name when multiple still images are saved. When [Include consecutive numbers] is selected, consecutive numbers are appended at the end the file names.

Introduction

Contents

Preparation

Basic Screen

Playing Back

Confirming File Information

Saving

Quitting EMU

Reference

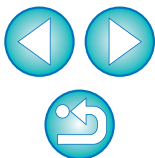

Still Image Saving Controls

When you save still images, you can perform the following operation with buttons.

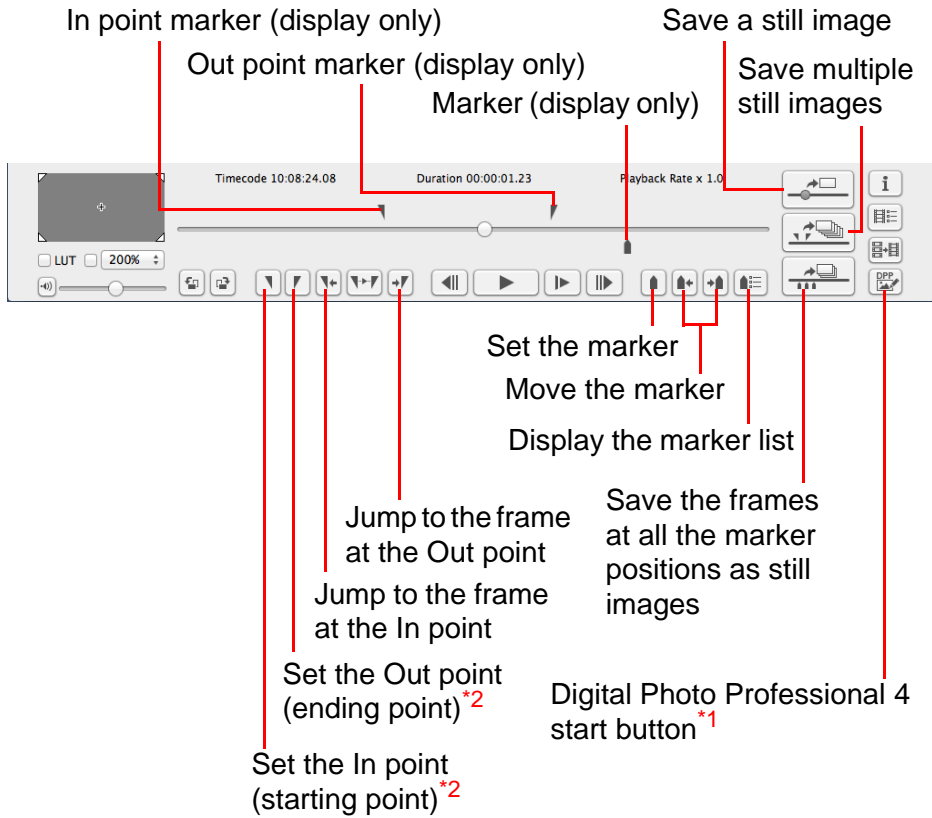

*1 Digital Photo Professional 4 starts up and the still image that was saved before the button was clicked will be displayed. Note that in order to use this function, you must have version 4.3.20 or later of Digital Photo Professional installed on your computer.

*2 These buttons specify the In (start) and Out (end) points when specifying a playback range (p.11) or saving multiple still images (p.18).

- **1D C** : To save still images with the LUT applied, checkmark [LUT] checkbox.
- Focal length, shutter speed, ISO speed, white balance and GPS information in the shooting information appended to the image are values when the movie shooting started. However, the date and time when the still image was actually shot will be calculated and appended as shooting date and time.

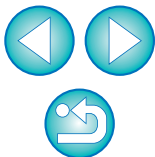

Saving Individual Still Images

- 1 In the main window, select the [View] menu ► [Clip list...].
→ The [Clip list] dialog box appears.
- 2 Select a movie clip in the [Clip list] dialog box.
- 3 Drag the frame position slider left or right to display the frame to save.

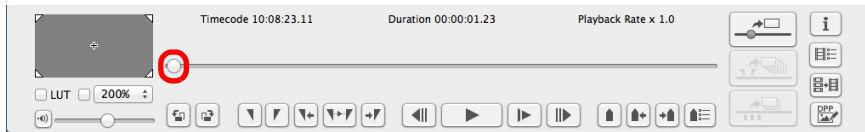

- 4 Click the Capture still image button.

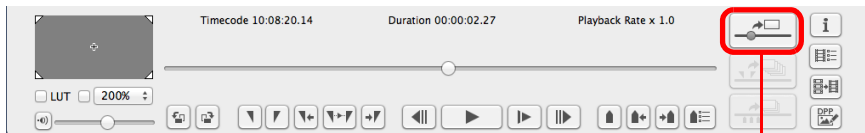

Capture still image button

- A still image is saved following the settings in the [Still Image Capture Settings] dialog box.
- You can also click the Capture still image button during movie playback to save still images. In this case, playback is paused as the current frame is saved as a still image.

Saving Multiple Still Images

By specifying a segment in the current movie clip, you can save all frames within the segment as still images.

- 1 In the main window, select the [View] menu ► [Clip list...].
→ The [Clip list] dialog box appears.
- 2 Select a movie clip in the [Clip list] dialog box.
- 3 Drag the frame position slider left or right to display the starting frame, and then click the In point button when a frame from which you want to start saving appears.

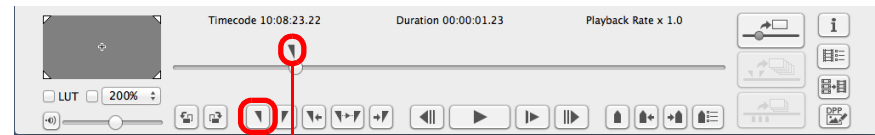

In point button In point marker

- The In point marker is now displayed, and the starting point for still images to save is set.
- You can also click this button during movie playback to specify the In point.
- Once you have specified the In point, you can jump to the frame at the In point by clicking the [] (move to IN point) button. If no In point has been set, clicking this button jumps to the first frame. You can also click the [] (move to IN point) button during movie playback.

Introduction

Contents

Preparation

Basic Screen

Playing Back

Confirming File Information

Saving

Quitting EMU

Reference

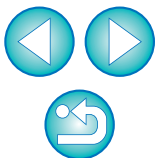

4 Drag the frame position slider left or right to display the ending frame, and then click the Out point button.

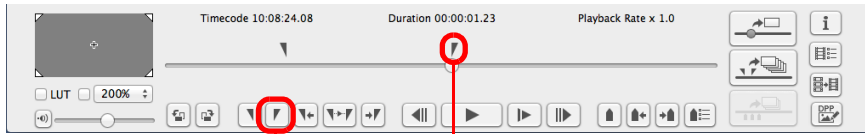

Out point button

Out point marker

- The Out point marker is now displayed, and the ending point for still images to save is set.
- You can also click this button during movie playback to specify the Out point.
- Once you have specified the Out point, you can jump to the frame at the Out point by clicking the [→] (move to OUT point) button. If no Out point has been set, clicking this button jumps to the last frame. You can also click the [→] (move to OUT point) button during movie playback.
- The maximum range between In and Out points is one hour.
- The In and Out points can be removed from [Marker] on the main window menu.
Select [Delete IN point], [Delete OUT point], or [Delete both IN point and OUT point] as required.

5 Click the Capture multiple still images button.

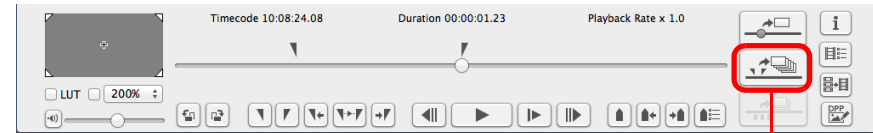

Capture multiple still images button

- Still images are saved following the settings in the [Still Image Capture Settings] dialog box. All frames between the In and Out points are saved as still images.
- You can also click this button during movie playback to save still images. In this case, playback is paused during capture.

 The In and Out point settings in the selected clip are saved automatically, and the settings continue to be effective the next time you work with the clip in EMU.

Introduction

Contents

Preparation

Basic Screen

Playing Back

Confirming File Information

Saving

Quitting EMU

Reference

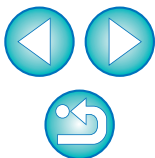

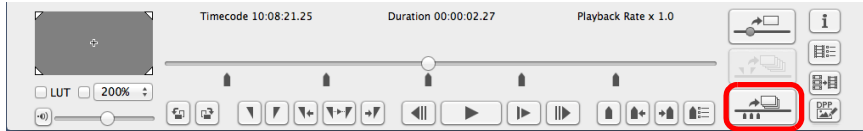

Saving All the Frames where Markers are Set as Still Images

Click the [] button.



→ All the frames specified with the markers are saved as still images using the settings made in the [Still Image Capture Settings] window.

 You can also save all the specified frames with markers in the procedures as below.

- 1 Click the [] (Marker list) button in the control area to display the marker list.
- 2 Click the [Capture all images] button in the marker list.

Introduction

Contents

Preparation

Basic Screen

Playing Back

Confirming File Information

Saving

Quitting EMU

Reference

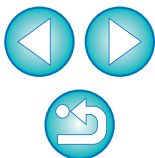

Merging and Saving Movie Files

 1D C 5DS/5DS R 7D Mk II

When you shoot movies with the supported camera, the movie file will be split by 4 GB and multiple movie files will be created automatically, even for a single shooting. You can merge these multiple files and save them as a single file with this function. Note that this function supports movies shot with 1D C 5DS/5DS R 7D Mk II .

Checking the Movie Files in a Movie Clip

In EMU, the split movie files will be displayed as a single movie clip. You can check the structure of a movie clip and see the movie files that consist the movie clip in the procedures as below.

1 In the main window, select the [View] menu ► [Clip list...].

- The [Clip list] dialog box appears.
- To use this function, you must first select the folder in which the movie clips to check are saved. If a folder is not selected, follow steps 1 to 2 of “Movie Clip Playback” (p.6) to select a folder.

2 In the [Clip list] dialog box, select the movie clip whose structure you want to check, then click while holding down the <control> key, and select [Show structure of the clip] from the menu that appears.

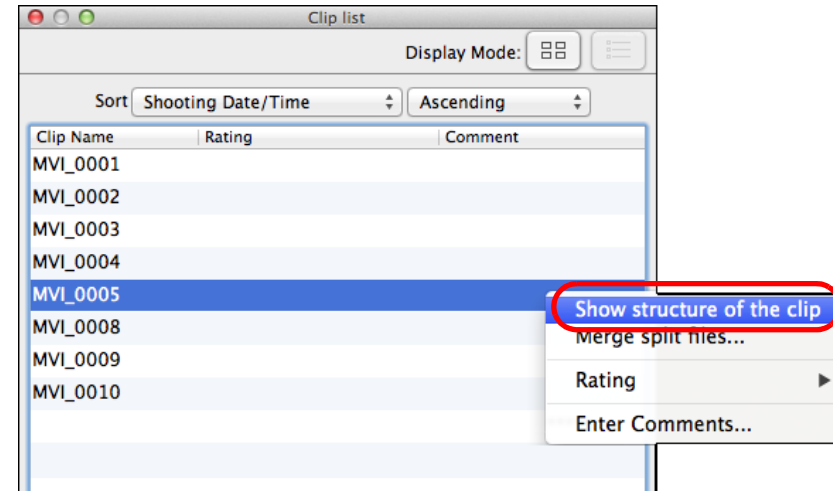

→ The [Structure of Clip] dialog box appears.

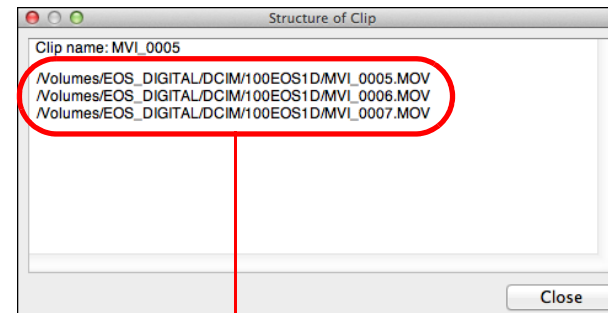

Movie file names are displayed in several lines for a movie clip made up of split movie files.

Introduction

Contents

Preparation

Basic Screen

Playing Back

Confirming File Information

Saving

Quitting EMU

Reference

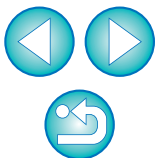

Merging Split Movie Files and Saving as a Single File

You can merge multiple split movie files composing a movie clip and save them as a single file. The original movie files are kept as they are in the folder they were originally saved.

Merging All the Split Movie Files in the Folder and Saving as a Single File

1 Click the Merge split files button in the main window.

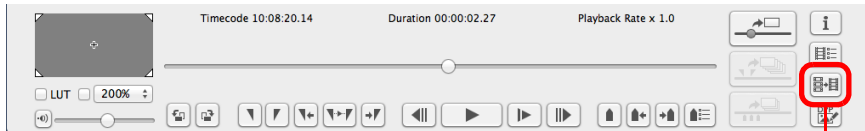

Merge split files button

→ The [Merge Files] dialog box appears.

- In the main window, you can also select the [Tools] menu ► [Merge split files...] to display the [Merge Files] dialog box.

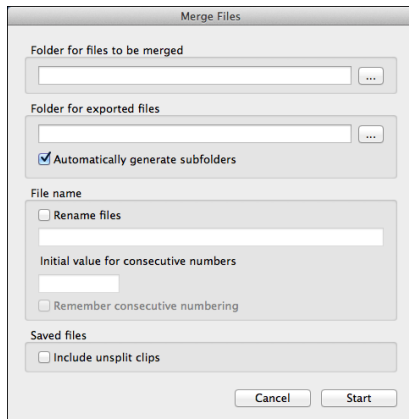

2 Click the [...] button for [Folder for Files to be Merged] and then select the folder in which the movie files to be merged are saved.

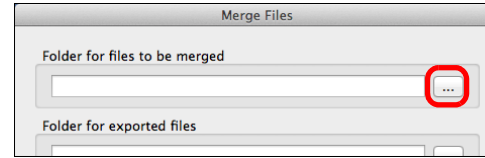

- All the movie files saved in the selected folder will be merged.

Introduction

Contents

Preparation

Basic Screen

Playing Back

Confirming File Information

Saving

Quitting EMU

Reference

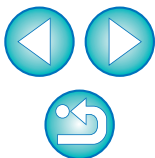

⚠ Movie files shot with a camera are recorded on the memory card with the folder structure shown below.

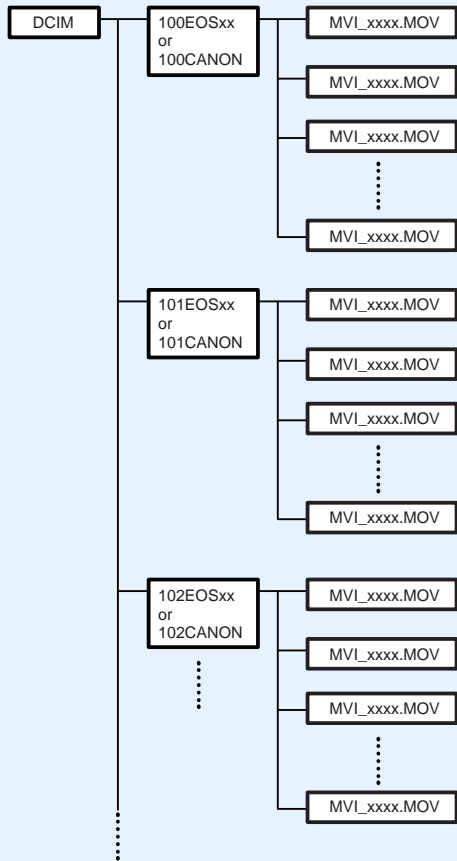

With this software, if the above folder structure is not maintained, it may not be possible to merge the split movie files properly. When performing “Merge all the split movie files in the folder and save as a single file” operation, make sure the above folder structure is maintained and the DCIM folder at the upper layer of the folder structure is selected. Even when the folder structure is maintained, be aware that it may not be possible to merge the movie files properly if the name of the selected folder, originally [DCIM], has been changed to another name.

3 Click the [...] button for [Folder for Exported Files] and then select the folder for saving the merged movie file.

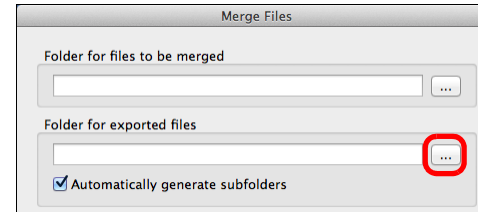

4 Click the [Start] button.

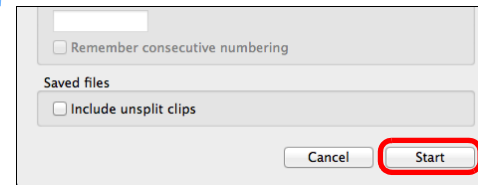

→ Merging and saving starts.

● A message appears when merging and saving are complete.



- If you checkmark [Automatically Generate Subfolders], a subfolder is created in the folder for the merged movie file selected in step 3, then the merged movie file is saved there. A file can be saved without changing its file name even if another file with the same file name is already in the folder.
- If you checkmark [Rename Files], you can change the file name of the merged movie file when saving it.
- To create file names with consecutive numbering, enter the initial value in the [Initial Value for Consecutive Numbers] box. You can enter an initial value that is up to 5 digits. Checkmark [Remember Consecutive Numbering] to allow consecutive numbering to continue even after closing the [Merge Files] dialog box and opening it again to merge and save movie files.
- If you checkmark [Include Unsplit Clips], movie files not split but saved in the folder selected in step 2 are copied to the folder for saving the merged file together.

Introduction

Contents

Preparation

Basic Screen

Playing Back

Confirming File Information

Saving

Quitting EMU

Reference

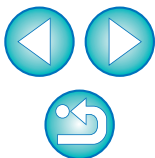

Merging Split Movie Files for a Single Movie Clip and Saving as a Single File

1 In the main window, select the [View] menu ► [Clip list...].

→ The [Clip list] dialog box appears.

- Note that this function is available after you select a folder in which the movie files to be merged are saved. If no folder is selected, follow steps 1 to 2 of “Movie Clip Playback” (p.6) to select a folder.

2 In the [Clip list] dialog box, select the movie clip to be merged, then click while holding down the <control> key, and select [Merge split files...] from the menu that appears.

→ The [Merge Files] dialog box appears.

3 Click the [] button for [Folder for Exported Files] and then select the folder for saving the merged movie file.

4 Click the [Start] button.

→ Merging and saving starts.

- A message appears when merging and saving are complete.

Quitting EMU

In the main window, select the [EOS MOVIE Utility] menu ► [Quit EOS MOVIE Utility].

→ EMU quits.

Introduction

Contents

Preparation

Basic Screen

Playing Back

Confirming File Information

Saving

Quitting EMU

Reference

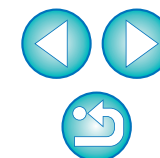

Reference

Troubleshooting

If EMU is not operating correctly, refer to the information below.

EMU does not work

- Even if your computer has the RAM capacity (memory) that meets the system requirements, if other applications are running at the same time as EMU, you may not have sufficient RAM (memory). Quit applications other than EMU.

Introduction

Contents

Preparation

Basic
Screen

Playing Back

Confirming File
Information

Saving

Quitting EMU

Reference

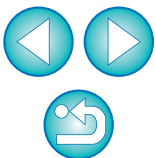

Error Messages

If an error message appears, refer to the information below.

Message	Cause and solution
Cannot write to the selected path.	The memory card specified for the save destination is write-protected. Insert a writable memory card.
Please enter consecutive numbers.	No consecutive numbering is entered. Enter an initial value for consecutive numbering when there are several movie clips with movie files to be merged.
The size of the file you are saving is not supported on the destination file system.	The file system specified for the save destination does not support the size of the file being saved. Change the save destination.
Sufficient consecutive numbers are not provided for the files.	Consecutive numbering for file names exceeds 99999. Change the value entered for numbering or the file save destination.
EOS MOVIE Utility has already started by other user.	Log into the user account in Macintosh in which EOS MOVIE Utility is running, quit EOS MOVIE Utility, and start it up again.
4 GB or larger files may not be supported on the file system of output destination. Do you want to continue?	The merged movie file may not be saved to the drive where the save destination folder is located. Check that the file system specified for the save destination drive supports files of 4 GB or larger.
Could not merge because there was not enough available space.	There is insufficient space on the drive where the save destination folder is located. Create enough space or change the save destination, and then repeat the merge process.

Message	Cause and solution
The merge process has been failed.	Check that there is a save destination folder. If the save destination folder is on an external storage device, check that it is connected to the computer correctly.

Introduction

Contents

Preparation

Basic Screen

Playing Back

Confirming File Information

Saving

Quitting EMU

Reference

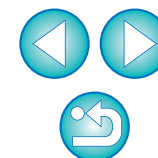

Keyboard Controls

Key	
Space	Play/Stop
Shift+Space	Play range between In and Out points
→	Next frame
←	Previous frame
Shift+→	Jump to Out point for multiple still images
Shift+←	Jump to In point for multiple still images
Shift+↑	Select next marker between current position and start
Shift+↓	Select next marker between current position and end
Home	Jump to first frame
End	Jump to last frame
B	Enable/Disable look-up table [LUT]
L	Play
Shift+L	Play range between In and Out points When pressed in playback state: play again
K	Stop
S	Adjust playback speed
V	Switch display size
F	Full screen display
Command+S	Save a still image
Command+T	Save multiple still images
Command+option+M	Save all the frames where markers are set as still images
D	Merge all split files in folder and save

Introduction

Contents

Preparation

Basic
Screen

Playing Back

Confirming File
Information

Saving

Quitting EMU

Reference

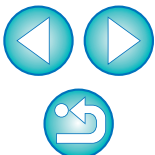

Uninstalling the Software

- Quit any applications before uninstalling the software.
- Log into the account used when installation was performed.
- When you have moved the folders and the software to be deleted to the Trash, select the [Finder] menu ► [Empty Trash...] and empty the Trash. You cannot reinstall the software until you have emptied the Trash.

1 Display the folder in which the software is saved.

- Open the [Canon Utilities] folder.

2 Drag the folder for the software to be uninstalled to the Trash.

3 Select [Finder] menu on the desktop ► [Empty Trash...].

- The software is deleted.
- When uninstallation ends, restart your computer.

⚠ You cannot retrieve deleted data once you have emptied the Trash, so be particularly careful when deleting data.

Introduction

Contents

Preparation

Basic
Screen

Playing Back

Confirming File
Information

Saving

Quitting EMU

Reference

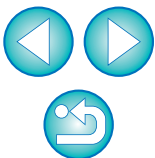

About This Instruction Manual

- It is prohibited to reproduce, in whole or part, the contents of this Instruction Manual without permission.
- Canon may change without notice the software specifications and contents of this Instruction Manual.
- The software screens and displays printed in this Instruction Manual may differ slightly from the actual software.
- Please note that irrespective of the above-mentioned, Canon does not take responsibility for the outcome of the operation of the software.

Trademarks

- Macintosh and Mac OS are trademarks of Apple Inc., registered in the U.S. and other countries.
- All other trademarks are the property of their respective owners.

Introduction

Contents

Preparation

Basic
Screen

Playing Back

Confirming File
Information

Saving

Quitting EMU

Reference

