

Canon

RF

24-240mm F4-6.3 IS USM

Instructions

ENG

Thank you for purchasing a Canon product.

Canon RF24-240mm F4-6.3 IS USM is a high magnification zoom lens for use with EOS R series cameras.

- “IS” stands for Image Stabilizer.
- “USM” stands for Ultrasonic Motor.

Conventions used in these instructions



Warning to prevent lens or camera malfunction or damage.



Supplementary notes on using the lens and taking pictures.

Camera Firmware and Camera Applications

Please use the latest versions of firmware and applications with the camera in use. For details on whether the firmware and applications in use are the latest version or not, and for details on updating them, please check the Canon website.



If the camera's* firmware is not a compatible version, the following limitations will apply.

- Magnified view functionality is not available.
- In some cases, the camera malfunction may occur.

* Applies to the following camera models:
EOS R and EOS RP

Safety Precautions

Precautions to ensure that the camera is used safely. Read these precautions thoroughly. Make sure all details are observed in order to prevent risks and injury to the user and other people.



Warning

Details pertaining to risks that may result in death or serious injury.

- **Do not look directly at the sun or other strong light sources through a lens.** This may result in loss of sight.
- **Do not leave a lens in the sun without the lens cap attached.** The lens may concentrate entering sunlight and cause a malfunction or fire.



Caution

Details pertaining to risks that may result in injury or damage to other objects.

- **Do not leave the product in places exposed to extremely high or low temperatures.** The product may cause burns or injury when touched.
- **Do not insert your hand or fingers into the product.** This may result in injury.

General Precautions

Handling Precautions

- Do not leave the product in excessive heat such as in a car in direct sunlight. High temperatures can cause the product to malfunction.
- If the lens is taken from a cold environment into a warm one, condensation may develop on the lens surface and internal parts. To prevent condensation in this case, first put the lens into an airtight plastic bag before taking it from a cold to warm environment. Then take out the lens after it has warmed gradually. Do the same when taking the lens from a warm environment into a cold one.
- Please also read any lens related handling precautions listed in your camera's instruction manual.

This device complies with Part 15 of the FCC Rules.

Operation is subject to the following two conditions: (1) This device may not cause harmful interference, and (2) this device must accept any interference received, including interference that may cause undesired operation.

Do not make any changes or modifications to the equipment unless otherwise specified in the instructions. If such changes or modifications should be made, you could be required to stop operation of the equipment.

This equipment has been tested and found to comply with the limits for a class B digital device, pursuant to part 15 of the FCC Rules. These limits are designed to provide reasonable protection against harmful interference in a residential installation. This equipment generates, uses and can radiate radio frequency energy and, if not installed and used in accordance with the instructions, may cause harmful interference to radio communications.

However, there is no guarantee that interference will not occur in a particular installation. If this equipment does cause harmful interference to radio or television reception, which can be determined by turning the equipment off and on, the user is encouraged to try to correct the interference by one or more of the following measures:

- Reorient or relocate the receiving antenna.
- Increase the separation between the equipment and receiver.
- Connect the equipment into an outlet on a circuit different from that to which the receiver is connected.
- Consult the dealer or an experienced radio/TV technician for help.

Nomenclature

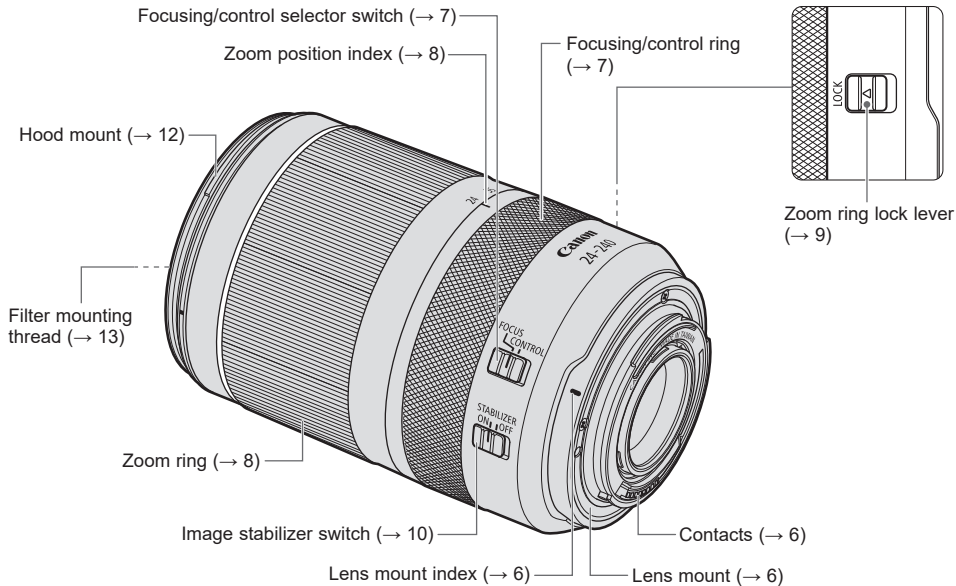

● For detailed information, reference page numbers are provided in parentheses (→ **).

1. Attaching and Detaching the Lens

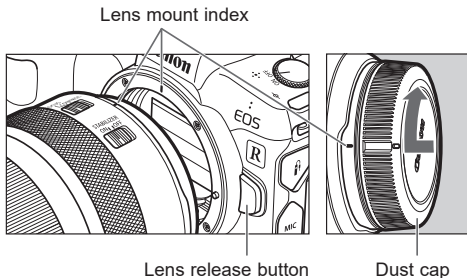

- Set the camera's power switch to OFF when attaching or detaching the lens.
- Attach the lens cap before detaching the lens from the camera.
- After detaching the lens, place the lens with the rear end up and attach the dust cap to prevent the lens surface and contacts from getting scratched. Make sure the lens and dust cap mount indexes are aligned when attaching the dust cap.
- Contacts that are scratched, soiled, or have fingerprints on them may result in faulty connections or corrosion, which may lead to malfunctions. If the contacts get soiled, clean them with a soft cloth.

Attaching the Lens

Align the lens mount indexes of the lens and camera, and turn the lens clockwise until you hear a click.

Detaching the Lens

Turn the lens counterclockwise while pressing the camera's lens release button. Detach the lens once it has stopped turning.

Please refer to the camera's instructions for details.

2. Focusing/control ring

The focusing/control ring can be used as either a focusing ring or a control ring.

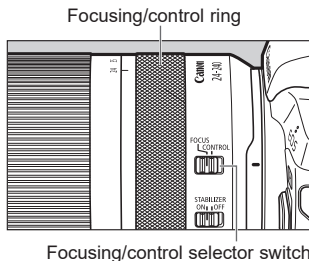

Use as a Focusing Ring

Set the Focusing/control selector switch to FOCUS. Set the focus mode (AF/MF) using the camera's menu.

To shoot in autofocus (AF) mode, set the camera's focus mode to AF.

To use only manual focusing (MF), set the camera's focus mode to MF, and focus by turning the focusing ring (focusing/control ring).

- ⚠ This lens does not have a focus mode switch.
- Delayed focus may occur if the focusing ring (focusing/control ring) is quickly turned.



- The lens' focusing ring (focusing/control ring) is electronic.
- Manual focus is possible even when the camera's focus mode is set to AF. (Full-time manual focus)
However, the camera settings need to be changed. Please refer to the camera's instructions for details.

Use as a Control Ring

Set the Focusing/control selector switch to CONTROL. Set the control ring function using the camera's menu. The control ring can be assigned the functions that are commonly used with cameras, such as shutter speed and aperture settings.

Please refer to the camera's instructions for details on how to use the control ring.

3. Zooming

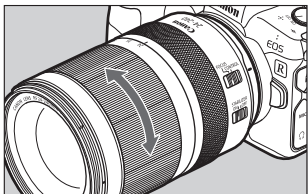

To zoom, turn the lens' zoom ring.

- Be sure to finish zooming before focusing. Zooming after focusing can affect the focus.
- Blurring may temporarily occur if the zoom ring is quickly turned.

4. Fixing the Zoom Ring

The zoom ring can be fixed to keep the lens at the shortest point. This function is convenient for carrying a camera on a strap because it prevents the lens from extending.

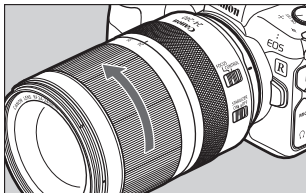
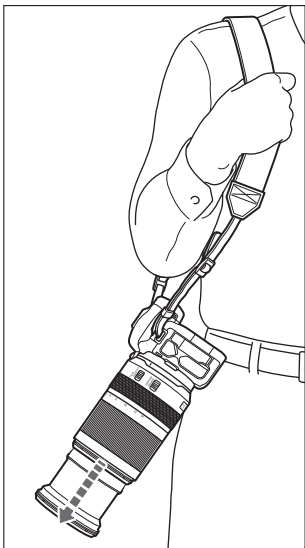

1 Turn the zoom ring to the widest position (24 mm).

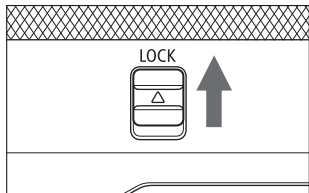

2 Slide the zoom ring lock lever in the direction indicated by the arrow.

- To release the zoom ring, slide the zoom ring lock lever in the direction opposite to the arrow.

- ⓘ ● The zoom ring cannot be fixed in place at any position other than the widest position.

5. Image Stabilizer

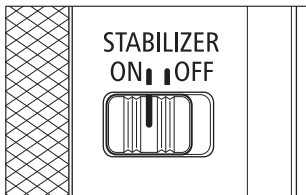

Set the image stabilizer switch to ON when you want to use the Image Stabilizer.

- This function provides image stabilization appropriate for shooting conditions (such as shooting still subjects and panning shots).
- The Image Stabilizer will work in combination with cameras with in-body Image Stabilizer.
 - * Lens firmware: ver.1.0.6 or over.
- Set the image stabilizer switch to OFF when you are not going to use the Image Stabilizer.

- The Image Stabilizer cannot compensate for a blurred shot caused by a subject that moved.
- The Image Stabilizer may not be fully effective if you shoot from a violently shaking vehicle or other transportation.
- The Image Stabilizer operates for about two seconds after turning off the camera. Do not detach the lens during that time. This may cause the lens to malfunction.
- When using a tripod, it is recommended that you set the image stabilizer switch to OFF.
- Even with a monopod, the Image Stabilizer will be as effective as during hand-held shooting. However, depending on the shooting conditions, there are cases in which the Image Stabilizer effect may be less effective.

Image Stabilizer

The Image Stabilizer for this lens is suited to hand-held shots in the following conditions.



- In semi-darkened areas such as indoors or outdoors at night.
- In locations where the flash cannot be used, such as art museums and theater stages.
- In situations where your footing is uncertain.
- In situations where fast shutter speed settings cannot be used.



- Panning shots of vehicles, trains, etc.
It compensates for vertical camera shake during panning shots in a horizontal direction, and compensates for horizontal camera shake during panning shots in a vertical direction.

Dynamic IS (for movie shooting only)

This lens is equipped with a Dynamic IS function which is effective when shooting while walking, etc. since it expands the IS range.

- Effective for wide-angle shooting.
- Automatically activates when the camera is set to movie shooting.

6. Hood

The custom lens hood cuts out unwanted light and protects the front of the lens from rain, snow, and dust.

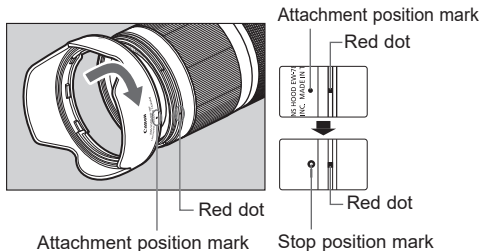

Attaching the Hood

Align the red attachment position mark on the hood with the red dot on the front of the lens, and then turn the hood in the direction of the arrow until you hear a click.

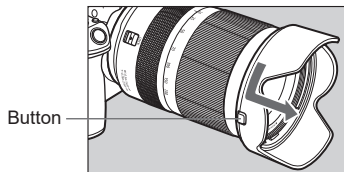

Detaching the Hood

Keep your finger pressed down on the button located on the side of the hood, and then turn the hood in the direction of the arrow until the attachment position mark on the hood is aligned with the red dot on the front of the lens to detach it.

The hood can be reverse-mounted on the lens for storage.

- If the hood is not attached properly, vignetting (darkening of the perimeter of the picture) may occur.
- Grasp and turn the base of the hood when attaching and detaching it. There are cases in which it may become deformed if the hood is turned with it grasped near to the rim.

7. Filters (Sold separately)

You can attach filters to the filter mounting thread on the front of the lens.



- Only one filter may be attached.
- If you need a polarizing filter, use the Canon Circular Polarizing Filter PL-C B.
- Detach the hood when adjusting the polarizing filter.

8. Close-up Lenses (Sold separately)

Attaching a 500D Close-up Lens enables close-up photography. It provides a magnification of 0.05x to 0.57x.



- Close-up Lens 250D cannot be attached because there is no size that fits the lens.
- Manual focus is recommended for accurate focusing.

Specifications

Focal Length/Aperture	24-240mm f/4-6.3
Lens Construction	15 groups, 21 elements
Minimum Aperture	f/22-36*
Angle of View	Horizontal: 74° - 8° 35', Vertical: 53° - 5° 45', Diagonal: 84° - 10° 20'
Min. Focusing Distance	0.5 m/1.64 ft. (at 24 mm), 0.78 m/2.56 ft. (at 240 mm)
Max. Magnification	0.26x (at 240 mm)
Field of View	Approx. 575 x 383 mm/22.64 x 15.08 in. (at 24 mm, 0.5 m/1.64 ft.) Approx. 134 x 90 mm/5.28 x 3.54 in. (at 240 mm, 0.78 m/2.56 ft.)
Filter Diameter	72 mm
Max. Diameter and Length	Approx. 80.4 x 122.5 mm/3.17 x 4.82 in.
Weight	Approx. 750 g/26.5 oz.
Hood	EW-78F (Sold separately)
Lens Cap	E-72 II
Case	LP1219 (Sold separately)

* Based on one-third-stop f-number scale. f/22-38 when using one-half-stop f-number scale.

- The lens length is measured from the lens mount surface to the front end of the lens.
Add 24.2 mm/0.95 in. when including the lens cap and dust cap.
- The maximum diameter, length and weight listed are for the lens itself only.
- All data listed is measured according to Canon standards.
- Product specifications and appearance are subject to change without notice.

Specifications

- Multiple exposure shooting is not possible when using this lens on certain cameras*.
* EOS R, RP, Ra, R5, R6
- There are cases in which using the zoom function during continuous shooting may result in conspicuous image distortion.
- There are cases in which excessive camera shake may result in conspicuous light irregularities.
- When the aperture is changed from the maximum aperture by an amount equivalent to one click only, the display of the aperture value may not change or may change by two clicks in some cases. This phenomenon is due to restrictions related to the display of the aperture values, but the actual exposure control is being performed properly.

Canon