

Canon MACRO PHOTO LENS

MP-E 65mm f/2.8 1-5×



Thank you for purchasing a Canon product.

Canon Macro Photo Lens MP-E 65mm f/2.8 1-5× is a high-magnification macro lens that can magnify the subject anywhere from 1× to 5×. It is dedicated to Canon EOS cameras.

Features

1. The UD element, three-group floating system, and other features result in excellent delineation at all focusing distances from life-size to 5× magnification.
2. The lens can attain a magnification of up to 5×.
3. A Canon macro flash makes it easy to take close-up flash pictures.

Conventions used in this instruction



Warning to prevent lens or camera malfunction or damage.



Supplementary notes on using the lens and taking pictures.

Safety Precautions

Safety Precautions

- **Do not look at the sun or a bright light source through the lens or camera.** Doing so could result in loss of vision. Looking at the sun directly through the lens is especially hazardous.
- **Whether it is attached to the camera or not, do not leave the lens under the sun without the lens cap attached.** This is to prevent the lens from concentrating the sun's rays, which could cause a fire.

Handling Cautions

- **If the lens is taken from a cold environment into a warm one, condensation may develop on the lens surface and internal parts.** To prevent condensation in this case, first put the lens into an airtight plastic bag before taking it from a cold to warm environment. Then take out the lens after it has warmed gradually. Do the same when taking the lens from a warm environment into a cold one.
- Do not leave the lens in excessive heat such as in a car in direct sunlight. **High temperatures can cause the lens to malfunction.**

This device complies with Part 15 of the FCC Rules. Operation is subject to the following two conditions: (1) This device may not cause harmful interference, and (2) this device must accept any interference received, including interference that may cause undesired operation.

Do not make any changes or modifications to the equipment unless otherwise specified in the instructions. If such changes or modifications should be made, you could be required to stop operation of the equipment.

This equipment has been tested and found to comply with the limits for a class B digital device, pursuant to part 15 of the FCC Rules. These limits are designed to provide reasonable protection against harmful interference in a residential installation. This equipment generates, uses and can radiate radio frequency energy and, if not installed and used in accordance with the instructions, may cause harmful interference to radio communications.

However, there is no guarantee that interference will not occur in a particular installation. If this equipment does cause harmful interference to radio or television reception, which can be determined by turning the equipment off and on, the user is encouraged to try to correct the interference by one or more of the following measures:

- Reorient or relocate the receiving antenna.
- Increase the separation between the equipment and receiver.
- Consult the dealer or an experienced radio/TV technician for help.

This Class B digital apparatus complies with Canadian ICES-003.

Nomenclature

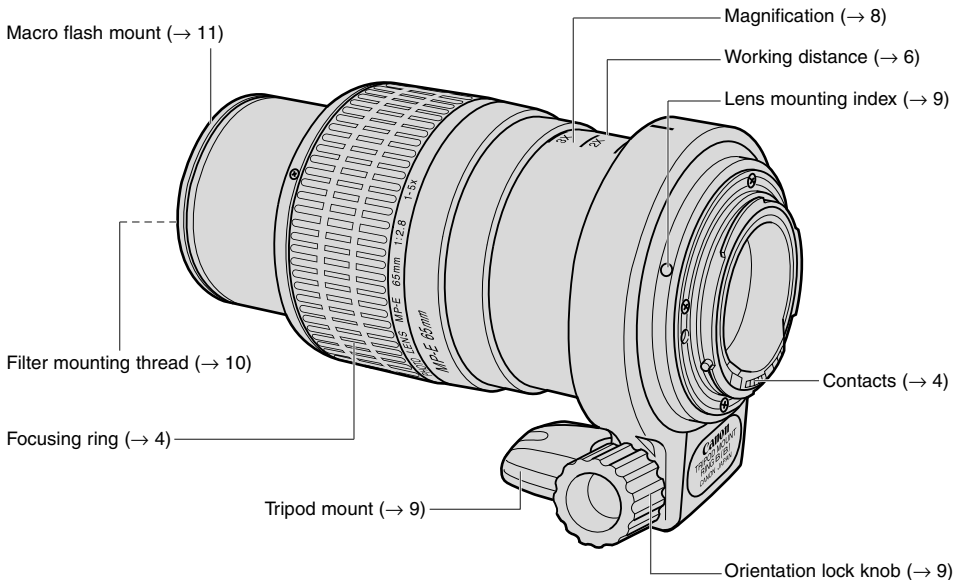

For detailed information, reference page numbers are provided in parentheses (→ **).

1. Mounting and Detaching the Lens

See your camera's instructions for details on mounting and detaching the lens.

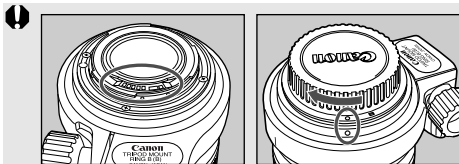

- After detaching the lens, place the lens with the rear end up to prevent the lens surface and electrical contacts from getting scratched.
- If the contacts get soiled, scratched, or have fingerprints on them, corrosion or faulty connections can result. The camera and lens may not operate properly.
- If the contacts get soiled or have fingerprints on them, clean them with a soft cloth.
- If you remove the lens, cover it with the dust cap. To attach it properly, align the lens mount index and the ○ index of the dust cap as shown in the diagram, and turn clockwise. To remove it, reverse the order.

2. Focusing

To focus, turn the focusing ring on the MP-E 65mm f/2.8 1-5× lens (AF is not possible). You can focus in two ways, either by setting the magnification first or by framing the subject first.

Since macro shots have a very shallow depth of field, focus carefully to obtain proper sharpness.

The magnification refers to the ratio between the subject's size and the corresponding image size on the focal plane. The available magnifications are marked on the lens barrel.

• Setting the Magnification First

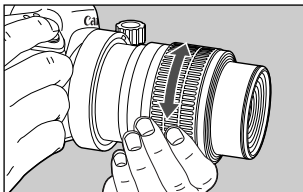

- 1** Set the magnification.
Turn the focusing ring to the desired magnification marked on the lens barrel.

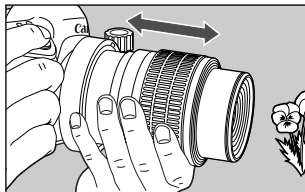

- 2** Focus the subject roughly.
While looking through viewfinder, move the camera forward or back to find the proper focus.

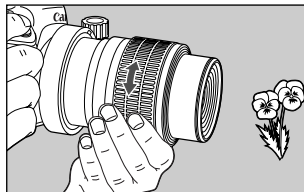

- 3** Focus the subject finely.
Turn the focusing ring for fine focusing of the subject.

• Framing the Subject First

While looking through the viewfinder to frame and focus, turn the focusing ring. After framing the subject, follow steps 2 and 3 above.

Focusing

- With the lens attached to the camera, the in-focus indicator in the viewfinder will not display properly. When focusing, do not rely on the in-focus indicator.
- With high-magnification macro shots, the working distance (distance between the front of the lens and the subject) becomes very short. Be careful not to bump into the subject.



- To prevent camera shake, use a tripod and the Remote Switch (sold separately).
- For magnification-priority macro photography, a focusing rail (commercially available) will make focusing easier.
- With high-magnification shots, the viewfinder image will darken, making it difficult to focus. Using Angle Finder C (sold separately) will make it easier to focus.
- To check the depth of field, refer to the Depth-of-field Table or use the camera's depth-of-field preview.

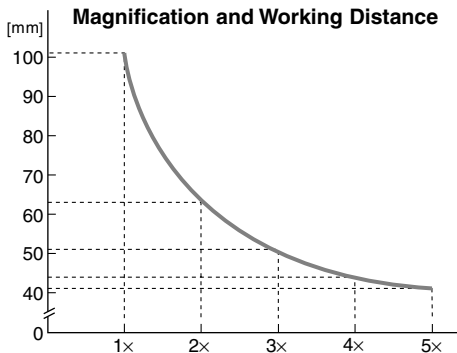

Depth-of-field Table

[mm]

Magnification	f/2.8	f/4	f/5.6	f/8	f/11	f/16
1x	0.396	0.560	0.792	1.120	1.584	2.240
2x	0.148	0.210	0.297	0.420	0.594	0.840
3x	0.088	0.124	0.176	0.249	0.352	0.498
4x	0.062	0.088	0.124	0.175	0.247	0.350
5x	0.048	0.067	0.095	0.134	0.190	0.269

3. Setting the Exposure

Magnification and Effective f-number

The aperture displayed by the camera assumes that the focus is set to infinity. The actual aperture (effective f-number) becomes darker (effective f-number increases) at closer focusing distances (magnification increases). This does not cause exposure problems for normal picture-taking. However, for closeup photography, you cannot ignore the change in the effective f-number.

When you use a handheld exposure meter to set the exposure, you must take into account the exposure factor shown in the following table.

Use the following formula to calculate the effective f-number:

$$\text{Effective f-number} = \text{f-number} \times (\text{Magnification} + 1)$$

For example, if the aperture displayed by the camera is $f/2.8$ and the magnification is $1\times$, the effective f-number will be $f/5.6$.

Magnification	1×	2×	3×	4×	5×
Effective f/No.	5.6	8.4	11.2	14.0	16.8

Setting the Exposure

The correct exposure for a close-up shot largely depends on the subject. Therefore, try to bracket the exposure for the same subject.

With the EOS-1Ds Mark III, 1Ds Mark II, 1Ds, 1D Mark III, 1D Mark II N, 1D Mark II, 1D, 1, 1N/DP/HS, and 1V/HS TTL autoexposure metering is possible from $1\times$ to $5\times$. Select the desired picture-taking mode and check the shutter speed and aperture.

With Other EOS Cameras

Since there will be a slight exposure error, using AE metering is not recommended. Take test shots first or use a handheld meter to determine the proper exposure based on the effective f-number. If you use the f-number displayed by the camera, use the exposure factor in the table below to convert it.

Magnification	1×	2×	3×	4×	5×
Exposure Factor (stops)*	+2	+3 $\frac{1}{3}$	+4	+4 $\frac{2}{3}$	+5 $\frac{1}{3}$
	+2	+3	+4	+4 $\frac{1}{2}$	+5

* Upper values: 1/3 stops. Lower values: 1/2 stops.

Setting the Exposure

Effective f-number for the Magnification and Camera's f/No.

For Cameras Displaying $\frac{1}{3}$ Stops

f-number	1×	2×	3×	4×	5×
2.8	5.6	8.4	11.2	14	16.8
3.2	6.4	9.6	12.8	16	19.2
3.5	7	10.5	14	17.5	21
4	8	12	16	20	24
4.5	9	13.5	18	22.5	27
5	10	15	20	25	30
5.6	11.2	16.8	22.4	28	33.6
6.3	12.6	18.9	25.2	31.5	37.8
7.1	14.2	21.3	28.4	35.5	42.6
8	16	24	32	40	48
9	18	27	36	45	54
10	20	30	40	50	60
11	22	33	44	55	66
13	26	39	52	65	78
14	28	42	56	70	84
16	32	48	64	80	96

For Cameras Displaying $\frac{1}{2}$ Stops

f-number	1×	2×	3×	4×	5×
2.8	5.6	8.4	11.2	14	16.8
3.5	7	10.5	14	17.5	21
4	8	12	16	20	24
4.5	9	13.5	18	22.5	27
5.6	11.2	16.8	22.4	28	33.6
6.7	13.4	20.1	26.8	33.5	40.2
8	16	24	32	40	48
9.5	19	28.5	38	47.5	57
11	22	33	44	55	66
13	26	39	52	65	78
16	32	48	64	80	96



- With the EOS-1 and EOS-1N/DP/HS, fine spot metering cannot be used because an exposure error will result.
- During remote control shooting, etc., when you take your eye off the eyepiece, cover the eyepiece with the eyepiece shutter or cover. Otherwise, stray light may enter the eyepiece and affect the proper exposure reading.



- With the EOS-3, using a Laser Matte focusing screen will enable AE metering at all magnifications from 1× to 5×.
- Using aperture-priority AE (**Av**) or Manual (**M**) picture-taking modes are recommended as it is easy to adjust depth of field and exposure in these modes.

4. Using the Tripod Mount

Adjusting the Revolving Mount

You can loosen the orientation lock-knob on the tripod mount to allow it to rotate as needed to fit a particular camera model for switching between vertical and horizontal positions.

Detaching

First remove the lens from the camera and then remove the tripod mount from the lens as shown below. To attach the tripod mount, reverse the procedure.

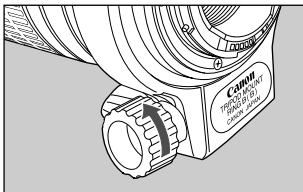

- 1 Loosen the orientation locking knob.

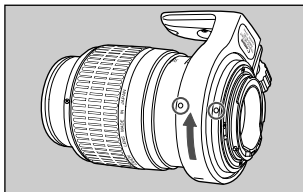

- 2 Rotate the tripod mount and align the mounting indicator on the tripod mount with the one on the lens.

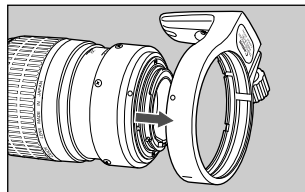

- 3 Slide off the tripod collar away from the rear of the lens.

Using the Tripod Mount

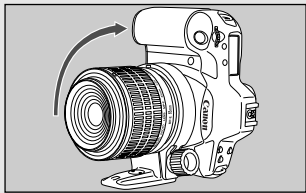

- When switching to vertical shooting, rotate the camera so that the grip is at the top. Rotating the camera in the opposite direction will have the grip bump into the tripod mount.
- Before attaching or detaching the lens, set the tripod mount back to its normal position (horizontal shooting position). Otherwise, the tripod mount may bump into the camera grip or pentaprism and prevent the lens from being attached to or detached from the camera.

5. Filters (Sold Separately)

You can attach filters to the filter mounting thread on the front of the lens.



- Filters and the macro flash cannot be used on this lens at the same time.
- If you need a polarizing filter, use the Canon Circular Polarizing Filter (58mm).

6. Macro Flash (Sold Separately)

The Canon Macro Ring Lite MR-14EX or the Macro Twin Lite MT-24EX enable fully automatic macro flash photography from life-size to 5X magnification in E-TTL autoflash mode.

Flash Range with Macro Ring Lite MR-14EX and MP-E 65mm Lens

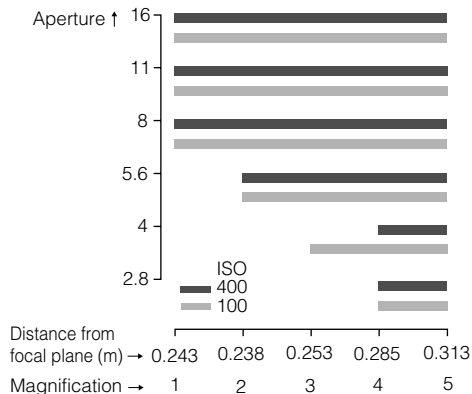

- For information on operating the Canon Macro Ring Lite MR-14EX or the Macro Twin Lite MT-24EX, refer to the individual instruction booklets.
- Using aperture-priority AE (**Av**) or Manual (**M**) picture-taking modes are recommended for macro photography as it is easy to adjust depth of field and exposure in these modes.
- When using the MT-24EX, it is recommended to use the hood designed for the MP-E65 sold separately.



Compared to normal picture-taking, the proper exposure for macro photography largely depends on the subject. It is difficult to obtain the proper exposure the first time. Therefore, you should bracket the exposure.

7. Other Notes

Multiple, EOS-dedicated Speedlites can be used for fully automatic wired or wireless flash photography.

8. Specifications

Focal Length & Max. Aperture	65 mm, f/2.8
Lens Construction	10 elements in 8 groups
Min. Aperture	f/16
Angle of View (at 1×)	Diagonal: 18°40' Vertical: 10°35' Horizontal: 15°40'
Focusing Distance	0.238 - 0.313 m / 0.78 - 1.02 ft.
Max. Magnification & Field of view	1× - 5×, 24 × 36 mm - 4.8 × 7.2 mm / 0.9 × 1.4 inch - 0.2 × 0.3 inch
Filter Diameter	58 mm
Max. Diameter & Length	81 × 98 mm / 3.2 × 3.8 inch
Weight	710 g / 25 oz
Hood	MP-E65 Hood (sold separately)
Lens Cap	E-58
Case	LP1216

- The lens length is measured from the mount surface to the front end of the lens. Add 21.5 mm when including the lens cap and dust cap.
- The size and weight listed are for the lens only, except as indicated.
- The EF1.4X II/EF2X II extender, the EF12 II/EF25 II extension tube, and 250D/500D close-up lenses cannot be used with this lens.
- Aperture settings are specified on the camera.
- All data listed is measured according to Canon standards.
- Product specifications and appearance are subject to change without notice.

Canon