

Canon

Video Display

DP-V3010

Instruction Manual

- Before use, be sure to read this guide, including the safety and handling precautions.
- Reading this guide will help you learn to use the video display properly.
- Store this guide safely so that you can use it in the future.

English

Table of Content

Introduction	4
About this manual	4
Trademarks	4
Safety Precautions	5
Handling Precautions	6
Features	8
Supplied Accessories	10
Nomenclature	11
Main Unit.....	11
Display Controller	13
Installation/Connection	15
How to Carry the Main Unit	15
Preventing from Tipping	15
Connecting the Main Unit to Input Devices	16
Connecting the Main Unit to the Display Controller	19
Installing the Display Controller on the Rack	20
Mounting the Main Unit on a Stand or Wall.....	21
Turning on the Power	22
Turning on the Power of the Main Unit.....	22
Turning on Main Unit Power from the Display Controller.....	22
Pairing	23
Pairing the Main Unit with the Display Controller	23
Re-pairing	24
Operating the Display Controller	25
Adjusting the Image Quality	25
Adjusting the Image Quality on CDL	25
Temporarily Saving Parameters (Anchor Point Setting).....	26
Using the Function (F) Buttons	26
Using the Channel (CH) Button.....	27
Checking Signal Information and Status of the Main Unit.....	27
Using the OSD Menu	28
Basic Operation	28
Adjusting Image Quality While Viewing the Entire Image	29
Calibration without a PC.....	31
Export/Import.....	32
Set Date/Time	34
Inputting Characters.....	35

OSD Menu	36
OSD Menu Index.....	36
Adjustment.....	41
Channel Settings.....	51
Display Settings.....	53
Marker Settings.....	56
Function Settings.....	61
System Settings.....	66
Signal Information.....	70
System Information.....	70
Main specifications/Performance	71
Main Unit.....	71
Display Controller.....	72
Dimensions.....	73
Appendix	74
Supported Signal Format.....	74
Image/Frame Display.....	89
Error Messages	91
Troubleshooting	93
Software Used in This Product	95
Index	97

Introduction





Thank you for purchasing the Video Display DP-V3010.

The On Screen Display (thereafter referred to OSD) default language setting is English. To change the OSD menu language setting, please refer to p. 66.

About this manual

Some of the illustration used in the manual have been simplified for clarity.

Conventions used in this manual

- : Indicates a reference page.
-  Note: Indicates a note.
-  Reference: Indicates reference information.
-  CAUTION: Indicates an item you must observe.

Trademarks

- DisplayPort and VESA are registered trademarks or trademarks of Video Electronics Standards Association in the U.S and other countries.
- Other product and company names herein are trademarks or registered trademarks of their respective owners.

Safety Precautions

For the customers in the U.S.A.

This equipment has been tested and found to comply with the limits for a Class A digital device, pursuant to Part 15 of the FCC Rules.

These limits are designed to provide reasonable protection against harmful interference when the equipment is operated in a commercial environment. This equipment generates, uses, and can radiate radio frequency energy and, if not installed and used in accordance with the instruction manual, may cause harmful interference to radio communications. Operation of this equipment in a residential area is likely to cause harmful interference in which case the user will be required to correct the interference at his own expense.

Do not make any changes or modifications to the equipment unless otherwise specified in the manual. If such changes or modifications should be made, you could be required to stop operation of the equipment.

Use of shielded cable is required to comply with class A limits in Subpart B of Part 15 of FCC Rules.

This device complies with Part 15 of the FCC Rules. Operation is subject to the following two conditions: (1) This device may not cause harmful interference, and (2) this device must accept any interference received, including interference that may cause undesired operation.

Canon U.S.A Inc.
One Canon Park, Melville, NY 11747, U.S.A.
Tel No. (631)330-5000

For the customers in Canada

CAN ICES-3 (A) / NMB-3 (A)

For the customers in Europe

Warning:

This is a class A product. In a domestic environment this product may cause radio interference in which case the user may be required to take adequate measures.

CANON INC.
30-2, Shimomaruko 3-chome, Ohta-ku, Tokyo 146-8501, Japan

CANON EUROPA N.V.
Bovenkerkerweg 59, 1185 XB Amstelveen, The Netherlands



Only for European Union and EEA (Norway, Iceland and Liechtenstein)

This symbol indicates that this product is not to be disposed of with your household waste, according to the WEEE Directive (2012/19/EU) and national legislation. This product should be handed over to a designated collection point, e.g., on an authorized one-for-one basis when you buy a new similar product or to an authorized collection site for recycling waste electrical and electronic equipment (EEE). Improper handling of this type of waste could have a possible negative impact on the environment and human health due to potentially hazardous substances that are generally associated with EEE. At the same time, your cooperation in the correct disposal of this product will contribute to the effective usage of natural resources. For more information about where you can drop off your waste equipment for recycling, please contact your local city office, waste authority, approved WEEE scheme or your household waste disposal service. For more information regarding return and recycling of WEEE products, please visit www.canon-europe.com/weee.

Handling Precautions

Places to avoid using the video display

Do not use the video display in the following places or conditions.

- Places with excessive dust or humidity
- Places that will expose the video display to direct sunlight, smoke (such as from a kerosene heater or other such source) or steam
- Near heat sources, humidifiers or flammable gas
- Near a window during rain or snow
- Near water or other places that could cause moisture to form on the video display

Screen Handling

- The screen may be damaged if it is exposed directly to strong light source. Please take precautions when placing it near a window.
- Do not press firmly on the screen, scratch it or place an object on the screen. It can cause non-uniformity or damage to the panel.
- The screen and cabinet may become warm during use. Note this does not constitute a malfunction.

About Backlight

The backlight has a limited service life so its brightness may degrade and color may change due to aging.

About Temporary Screen burn-in

If a stationary image is displayed for a prolonged period, screen burn-in may occur where you see remnants of what was displayed. This is a characteristic of LCD and is not a failure. However, this is only temporary and will disappear when playing video.

About the LCD screen

The screen is produced using extremely high-precision manufacturing techniques, with more than 99.99% of the pixels operating to specification. Less than 0.01% of the pixels may occasionally misfire or appear as black, red, blue or green dots. In addition, this tendency may increase through long term use due to characteristic of the LCD panel. These do not constitute a malfunction.

Condensation

If this equipment is brought into a warm room while it is cold or if the room is heated suddenly, condensation may form on the surface or inside the equipment. Note that the equipment may be damaged if it is used under such condition. If condensation has formed on the surface or inside the equipment, do not use the video display as it may get damaged. Turn the power off and wait until the condensation has evaporated before using the video display.

Cleaning

- Before cleaning, please unplug the power plug from the wall outlet.
- The screen has a special surface treatment, avoid touching it directly with your hand. In addition, never affix adhesive objects such as seals.
- Never use alcohol or benzene, thinner, acidic cleaning solution, alkaline cleaning solution, abrasive or chemical wipes because these will damage the screen.
- If the screen is dirty, wipe gently with soft dry cloth such as cleaning cloth or eye glasses cleaning cloth. Wiping the screen too hard may cause unevenness on the screen or damage the LCD panel. The screen may be scratched if wiped too hard with a cleaning cloth with foreign particles attached.
- When the screen is extremely dirty, wipe with soft cloth such as cleaning cloth or eye glasses cleaning cloth moistened with water-diluted neutral detergent.
- Use a blower to remove dust from the surface of the screen.
- Since the cabinet around the screen has a special surface treatment, wiping off the area may fade its surface color.
- Wipe dirt on cabinet with a soft cloth. If the screen is very dirty, use a moistened cloth with water or mild detergent diluted with water. Do not use alcohol, benzene, paint thinner, or pesticides as they may damage the surface finish or erase characters on the cabinet.

Disposing

- Do not dispose together with normal waste. Do not include the video display in waste that will be taken to landfill.
- Observe the rules and regulations of your local authorities when disposing.

Features

DP-V3010 video display is packed with the essence of Canon's image-making know-how such as high-definition IPS LCD panel, display engine and backlight technology. It provides optimal performance and functions in the field of video production such as color grading and VFX (Visual Effects).

Faithful Color Reproduction

The display features a Canon-designed RGB LED backlight system and IPS LCD panel which reproduce a rich array of colors. Besides the DCI (Digital Cinema Initiatives) color gamut, it is also ideally suited to displaying the color gamuts of a multiple number of other broadcast standards, namely, ITU-R BT.709, ITU-R BT.2020, EBU, SMPTE-C and Adobe RGB.

High-Resolution/High Definition

4K content is displayed dot-by-dot with 10.5 megapixels resolution (4096x2560) and 157.5 µm pixel pitch.

High Contrast

DCI-P3 standard contrast ratio of 2000:1 or greater is achieved by adopting image processing technology implemented through the use of high contrast panel and Canon's proprietary algorithm.

Aspect Ratio Suitable for Video Production (16:10)

The aspect ratio enables dot-by-dot display of digital cinema (1.896:1) or HDTV broadcast (16:9) contents for color grading work, as well as display standard PC signal (16:10) in full, which is ideal for VFX work.

2K/Full-HD High Definition View

Canon's proprietary algorithm reduces jagged lines and produces smooth display when expanding 2K/Full-HD content.

Specialized Performance and Functions for Video Production Display

- Use with other Canon equipment
 - Equipped with color gamut settings for monitoring Cinema Gamut and DCI-P3+ videos recorded by the CINEMA EOS SYSTEM digital cinema camera, the special picture mode and Gamma, optimally display the “Canon Log”, “Canon Log 2” and “Canon Log 3.”
 - Being compliant with the ACESproxy (ACES 0.7/1.0), ACES workflow is provided when used with an ACESproxy-ready CINEMA EOS SYSTEM digital cinema camera.
- Equipped with the High Dynamic Range (HDR) display function.
- Supports gamma equivalent to CRT standardized by ITU-R BT.1886.
- ASC CDL Support
Color adjustment using CDL (Color Decision List) recommended by ASC (American Society of Cinematographers) enables the consistent application of the color parameters from production to post-production.
- LUT Import Support
Easy importing of 1D/3D-LUT makes it possible to recreate the same color and gradation expression sought after by producers at shooting locations.
- Backlight Scan
“Blurred video” specific to LCD panel is reduced by integrating the Backlight Scan feature, which partially turns off the backlight area and reduces the image hold period when displaying images.

- Calibration without a PC
Calibration can be performed easily without the use of dedicated application. Calibration enables brightness and color to maintain factory default settings. You can also adjust the video display condition to match your requirements, purpose, and the ambient light.
- Operability
All settings are possible with display controller operation. Minimum necessary operations are also possible from the main unit, providing means of operation depending on the use cases.

Other

- Functions to check videos
Equipped with functions including Peaking, False Color, Wave Form Monitor, Vector Scope, Zoom, Screen Capture and other markers.
- Supported interfaces
 - Equipped with 3G/HD-SDI terminal that is standard in the broadcast industry and DisplayPort terminal used in PC with high resolution.
 - Equipped with a USB terminal for connecting a controller for color grading (element-Tk by Tangent Wave Ltd), an external sensor for calibration or a USB memory device.
- Multiple Format Support
Supports 1280x720 / 24.00P, 25.00P, 30.00P, 50.00P, 60.00P to 4096x2160 / 24.00P, 25.00P, 30.00P, 48.00P, 50.00P, 60.00P, 50.00i, 60.00i SDI and 640x480 to 4096x2560 DisplayPort signals to enable viewing of a variety of signal.
- Equipment Design Enabling Effective Use of Space
The space-saving installation against a wall is possible thanks to the proprietary heat dissipation.

Supplied Accessories

The following items are supplied with this product. Please check before using.

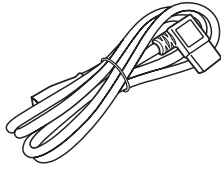

AC Power Cord VT-20

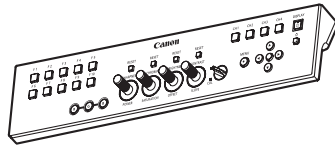

Display Controller CL-01

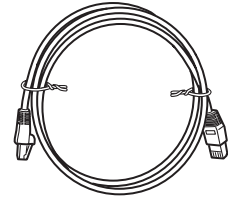

LAN Cable LN-30
(3 m)

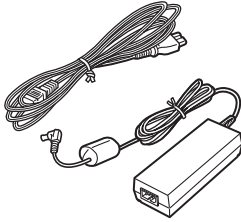

Compact Power Adapter
CA-PS700 and AC cable

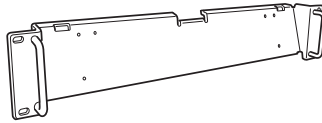

Rack Mount Bracket RB-01



Rack Mount Bracket Screw SW-02
(M3 x 6 mm x 4)

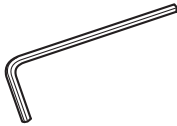

Hex Key HK-01
(Allen wrench 3 mm)

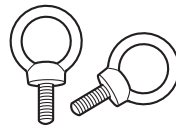

Tip Prevention Fitting TP-01
(M6 x 10 mm x 2)

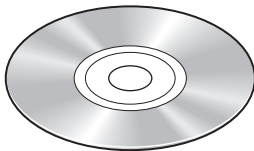

Instruction Manual Disc*

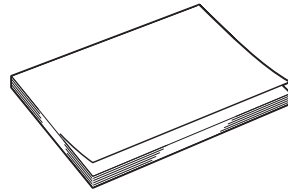

DP-V3010 Instruction Manual
(this document)

*** Instruction Manual Disc**

This disc contains the Japanese, English, French, German, and Simplified Chinese instruction manuals in PDF format. Adobe Reader 11.0 or above must be installed on your computer to view the instruction manuals in PDF format.

Nomenclature

Main Unit

■ Front

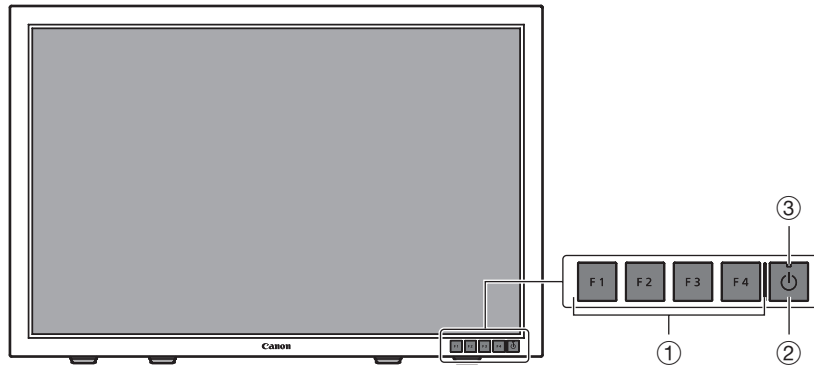

①	F1 to F4 button	Executes the defined function. The following functions have been assigned at the factory. These functions can be changed if necessary. F1: Channel UP F2: Channel DOWN F3: Time Code (On/Off) F4: Aspect Marker (On/Off)	26
②	⏻ button (Power button)	Turns power On/Off.	22
③	Power indicator	Displays the status of the main unit. The brightness of the power indicator can also be set from "1 (dark) to 5 (brightest)". Even when the power indicator is "Off", it will flash during firmware update, network settings reset, or when an error is detected. Off: main power supply "Off" Green lit: main power supply "On"/Power "On" Green flash: during calibration, firmware update, network settings reset in progress, or pairing with the display controller Amber lit: standby (Main power supply "On" and power supply "Off") Amber flash: when error is detected	67 93

■ Rear

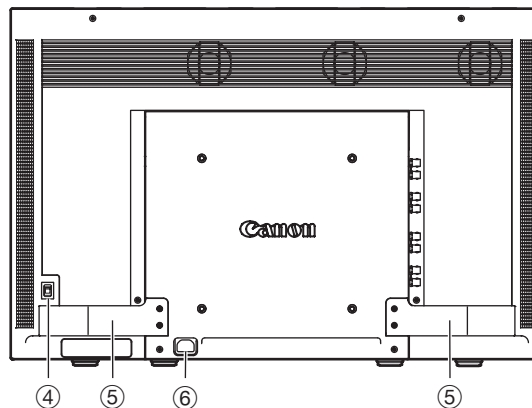

④	Main power supply switch	Turns main power supply On/Off.	22
⑤	Handle	Use for carrying the main unit.	-
⑥	AC power input terminal	Connects the supplied AC power supply cord.	22

■ Interface

Left side

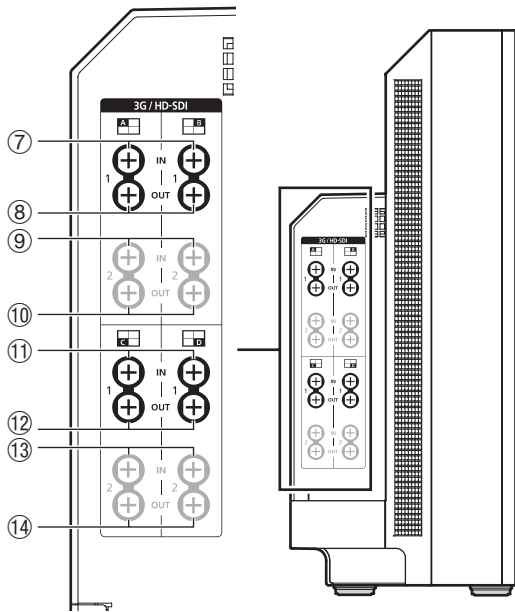

Right side

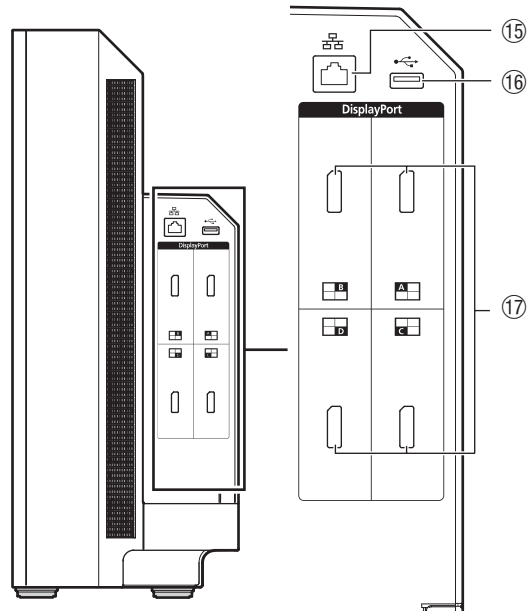

⑦⑪	3G/HD-SDI input terminal 1	Two input systems corresponding to input 1.
⑧⑫	3G/HD-SDI output terminal 1	Monitor output corresponding to ⑦⑪
⑨⑬	3G/HD-SDI input terminal 2	Two input systems corresponding to input 2.
⑩⑭	3G/HD-SDI output terminal 2	Monitor output corresponding to ⑨⑬

⑮	LAN (10/100 BASE) terminal	Connects to display controller. The main unit connects 1 to 1 with the display controller. It can also be connected via a hub.
⑯	USB port	Used to connect an external sensor for calibration (⑳31), USB memory, hub, or controller for color grading (element-Tk made by Tangent Wave Ltd.).
⑰	DisplayPort input terminal	One input system available.

⚠ CAUTION

- When connecting an external sensor for calibration to the USB port, cable length must not exceed 3 m. Otherwise, communication error may occur and correct calibration may not be possible.
- Directly connect external sensors without using a hub.
- For safety, do not connect any connector that may have excessive voltage to the terminal of the video display when connecting peripheral devices.

📝 Note

- Dual Link HD-SDI is used for connecting two input systems (⑰17)
- Both FAT16 and FAT32 USB memory devices are supported.
- Proper operation cannot be guaranteed for all USB memories.
- It may take 10 seconds or more for the USB memory to be recognized. If a USB memory is used during recognition, the message "Detecting USB memory." is displayed.

Display Controller

■ Front

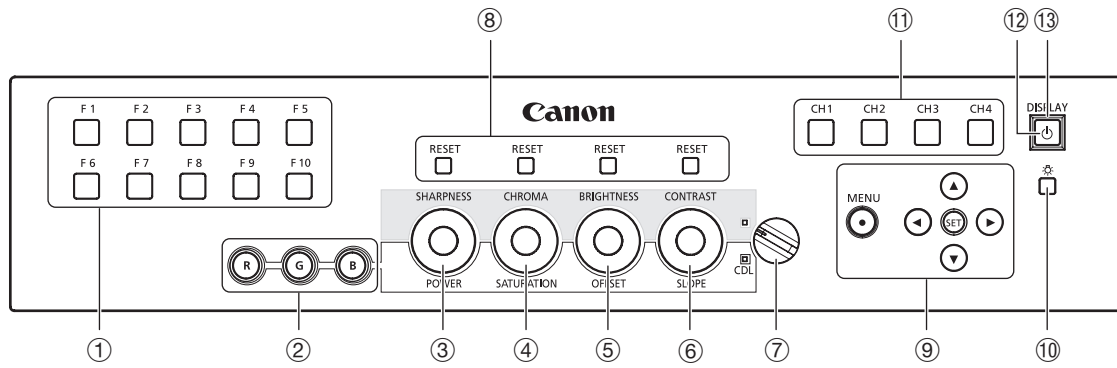

①	F1-F10 buttons	Executes the assigned function.	26
②	RGB select button (when using CDL)	Selects and adjusts RGB during CDL adjustment.	
③	SHARPNESS knob (normal use)	Adjusts the sharpness of the Image.	Provides the same control as the ▲▼ buttons in the OSD menu.
	POWER knob (when using CDL)	Adjusts the gamma of the image.	
④	CHROMA knob (normal use)	Adjusts the color saturation of the image.	Provides the same control as the ◀▶ buttons in the OSD menu.
	SATURATION knob (when using CDL)		
⑤	BRIGHTNESS knob (normal use)	Adjusts the black level of the image.	25 28
	OFFSET knob (when using CDL)		
⑥	CONTRAST knob (normal use)	Adjusts the white level of the image.	
	SLOPE knob (when using CDL)		
⑦	CDL select switch	Switches between normal and CDL mode.	
⑧	RESET button	Returns adjustments ③ to ⑥ to default value. When adjusting the values using the slider in the OSD menu, press the RESET button above SHARPNESS or CHROMA to return to the default value.	
⑨	MENU button	Opens/closes the OSD menu, or moves up one level in a menu.	28
	▲▼◀▶	Moves the selection frame within the OSD menu. Changes settings.	
	SET button	Confirms an OSD menu setting or moves the selection frame up/down 1 level. When the OSD menu is closed, displays various banners.	27 28
⑩	☀ button	Sets the button brightness. Rotates among "Off→1 (dark)→2 (normal)→3 (bright)" each time button is pressed. Even when the power indicator (⑬) is "Off", it will flash during firmware update, network settings reset, or when an error is detected.	-
⑪	CH1-CH4 buttons	Changes channel.	27
⑫	⏻ button (Power button)	Turns the power of main unit On/Off.	22
⑬	Power indicator	Off: power off Green On: main power supply "On" of display/Power "On" / during calibration Green flash: when main unit power is turned on from the display controller, during firmware update, or network settings reset in progress Amber On: main power of the connected display is "off" or standby or when not paired with the connected display. Amber flash: when error is detected	-

■ Rear (lid opened)

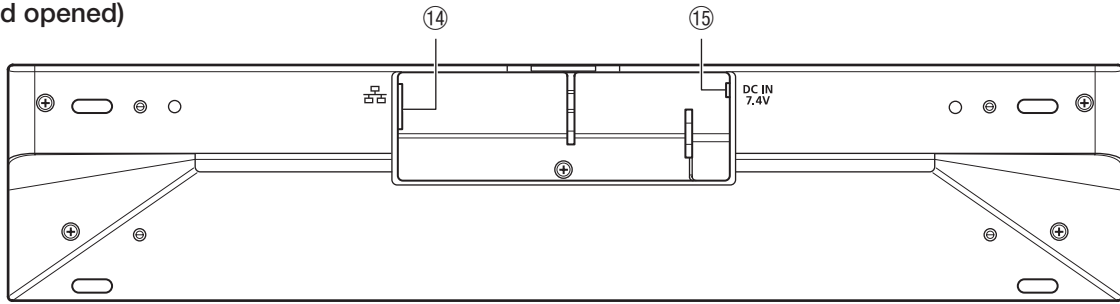

⑭	LAN terminal	Connects the main unit to the display controller using a LAN cable.	📖 19
⑮	DC IN terminal	Connects to compact power adapter CA-PS700.	

Installation/Connection

⚠ CAUTION

- When unpacking, carrying, installing, or connecting the main unit, please note that at least two people are required.
- Do not touch or damage the screen during installation and connection.

How to Carry the Main Unit

Please carry the main unit as illustrated in the figure below.

⚠ CAUTION

- Do not pick up the main unit by the handle only. Please take particular care as the main unit may tilt and cause injury or get damaged, when carried.

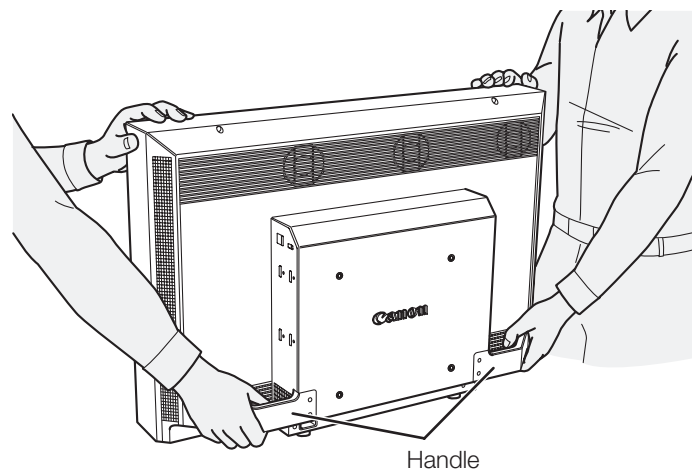

Preventing from Tipping

The supplied tip prevention fitting TP-01 can be used to significantly reduce the risk of the main unit tipping or falling. Make sure to complete the power and input device connections beforehand.

⚠ CAUTION

- When securing the main unit to a stand, please ensure the stand is strong enough to support the weight of the main unit.
- Do not move the main unit after it is secured.

1. Remove two top screws at the rear of the main unit using the supplied hex key HK-01.

Do not lose the removed screw. Do not use these screws for other purposes.

2. Insert the tip prevention fitting TP-01 into the two top screw holes and secure.

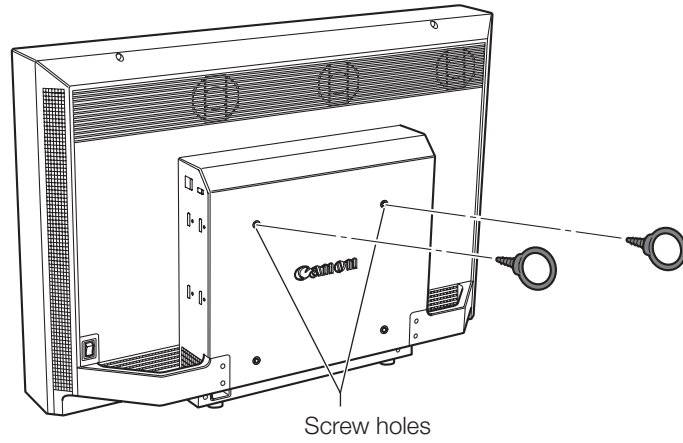

3. Pass a safety strap through the ring of the tip prevention fitting TP-01 and secure to the wall or stand.

Connecting the Main Unit to Input Devices

This main unit has four inputs which correspond to a display area. The display area icons located in the input terminal area shows where the input video is displayed on the screen. Please ensure these are connected correctly as indicated by the icons.

In addition, SDI has two I/O systems. Please ensure these are connected correctly according to the input number.

CAUTION

- Check that the main power of the main unit and input devices is switched off before connecting.
- For safety, do not connect connector that may have excessive voltage to the terminal of this main unit when connecting peripheral devices.

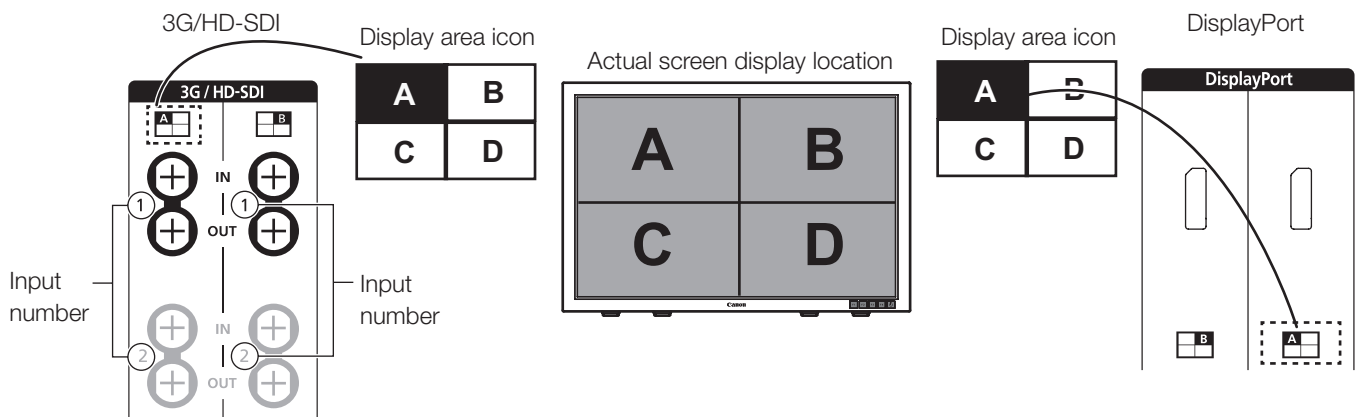

■ **4K or QFHD signals input through SDI**

Displays using 4 inputs.

3G/HD-SDI

3G/HD-SDI supports two input systems.

Input 3G/HD-SDI 1 to input 1,

Input 3G/HD-SDI 2 to input 2 ("Input Configuration"  51).

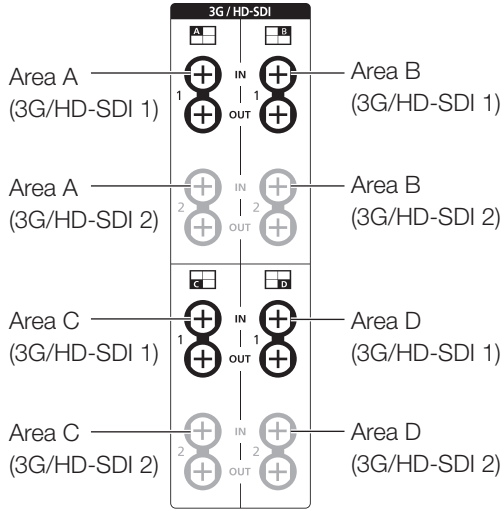

Dual Link HD-SDI

Input Link A signal to input 1, Link B signal to input 2.

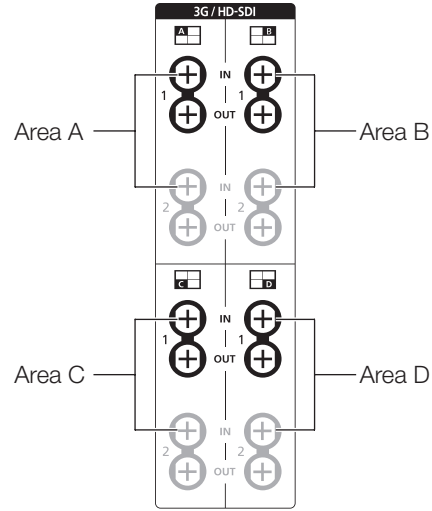

■ **2K or Full-HD signals input through SDI**

Displays using 1 input. To center the displayed content, select "Channel Settings" → "Select Input Signal" → "Single Input" and select the area to display from A to D ( 51).

3G/HD-SDI

3G/HD-SDI supports two input systems.

Input 3G/HD-SDI 1 to input 1.

Input 3G/HD-SDI 2 to input 2 ("Input Configuration"  51).

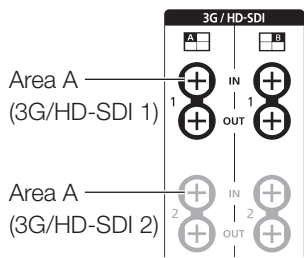

Dual Link HD-SDI

Input Link A signal to input 1, Link B signal to input 2.

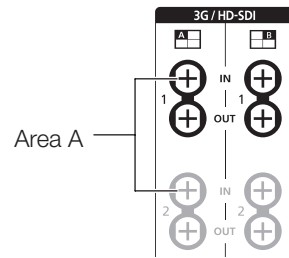

 **Reference**

- The connection is checked using Canare Corp. BNC cable (multi) 4VS03A-5C.

■ 4K or QFHD signals input through DisplayPort

Displays using 4 inputs.

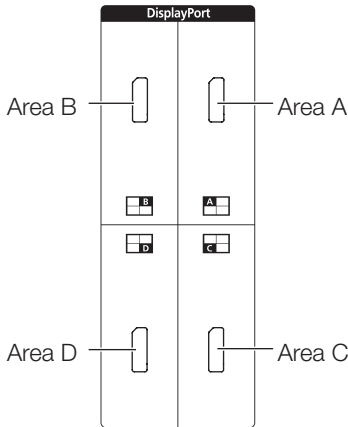

■ 2K or Full-HD signals input through DisplayPort

Displays using 1 input. To center the displayed content, select "Channel Settings" → "Select Input Signal" → "Single Input" and select the area to display from A to D (📖 51).

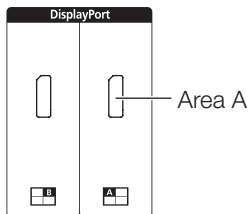

When connecting with the DisplayPort cable, use the cable with the following wiring specifications.

DisplayPort male	DisplayPort male	DisplayPort male	DisplayPort male
1 _____	12 _____	11 _____	2 _____
2 _____	11 _____	12 _____	1 _____
3 _____	10 _____	13 _____	13 _____
4 _____	9 _____	14 _____	14 _____
5 _____	8 _____	15 _____	15 _____
6 _____	7 _____	16 _____	16 _____
7 _____	6 _____	17 _____	17 _____
8 _____	5 _____	18 _____	18 _____
9 _____	4 _____	19 _____	19 _____
10 _____	3 _____	SHELL _____	SHELL _____

⚠ CAUTION

- Be sure to use shielded type cable no longer than 3 m in order to prevent malfunction due to noise.

ℹ Reference

- The connection is confirmed using ELECOM DisplayPort cable CAC-DP30BK.

Connecting the Main Unit to the Display Controller

This section describes how to connect the main unit to the display controller.

⚠ CAUTION

- When using a commercially available LAN cable, please use a shielded type cable no longer than 3 m in order to prevent malfunction due to noise.

1. Open the lid on the back of the display controller.

While holding the display controller with one hand, place your finger in the cutout portion of the lid and pull forward.

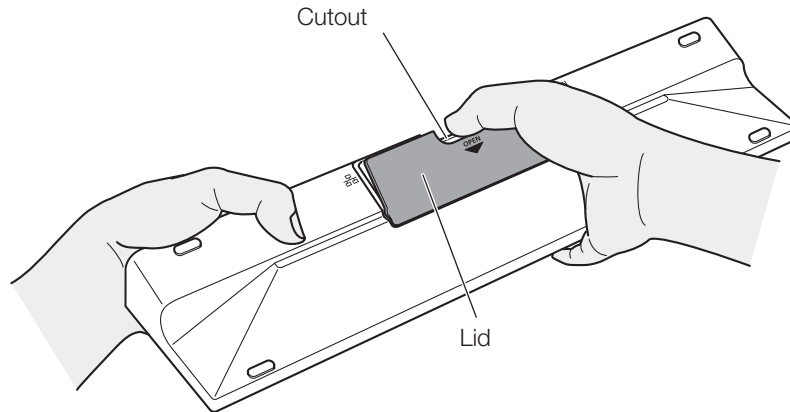

2. Connect the supplied LAN cable LN-30 and the compact power adapter CA-PS700.

Insert the connector of the LAN cable LN-30 and plug of the compact power adapter CA-PS700 as shown in the figure below. Use the cutout section to pass the cables, as illustrated.

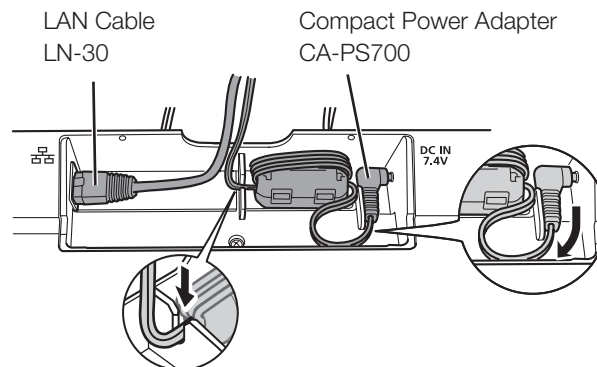

3. Close the lid with cables hanging out from the cutout area.

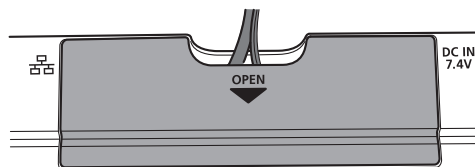

4. Connect the other end of the LAN cable to the LAN terminal of the main unit.

Installing the Display Controller on the Rack

The display controller can be installed on an EIA standard compliant 19-inch rack.

CAUTION

- Make sure that the display controller does not fall during installation/removal.

1. Place the display controller on the rack mount bracket RB-01 as shown in the figure and match the screw holes.

Make sure the cable does not get caught in the rack mount bracket during installing.

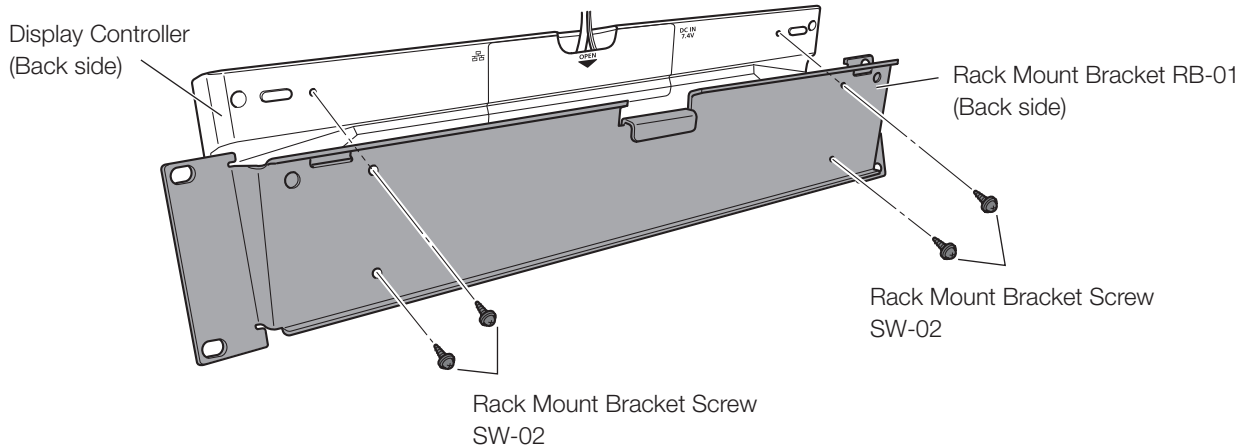

2. Insert the rack mount bracket screw SW-02 into the rack mount bracket screw holes at the back and tighten the screws to secure the display controller.

3. Mount the display controller on the rack using commercially available screws.

Use screws appropriate for the rack.

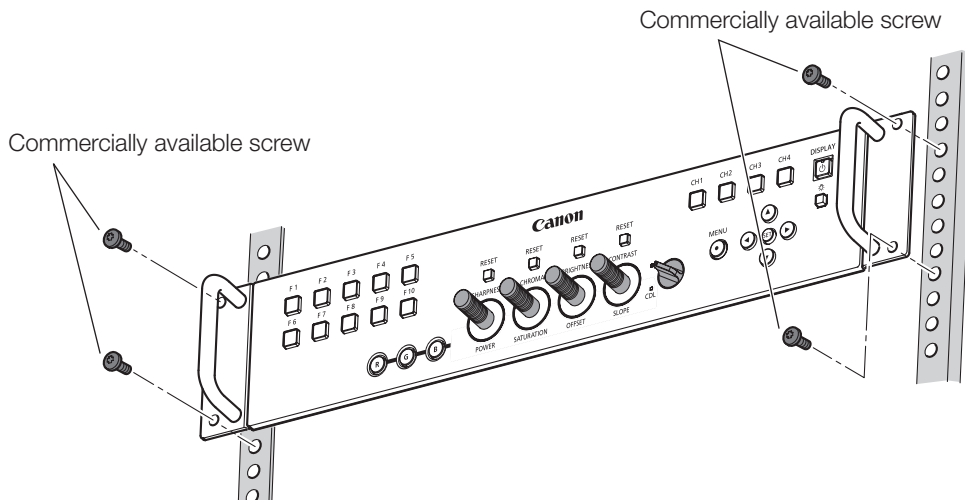

Mounting the Main Unit on a Stand or Wall

This main unit can be fitted to a stand* or to a wall mount bracket*.

Screws compatible with this main unit are M6 x 10 mm (VESA Standard 200 x 200 mm).

* Commercially available.

⚠ CAUTION

- Make sure to perform this step, with at least two people.
- When mounting the main unit on a wall, make sure the wall has sufficient strength. If necessary, apply reinforcement. Also, make sure to check the load capacity of the stand or wall mount bracket.
- Make sure that the main unit does not fall during installation/removal.

1. Remove four screws at the rear of the main unit using the supplied hex key HK-01.

Do not lose the removed screw. Do not use these screws for other purposes.

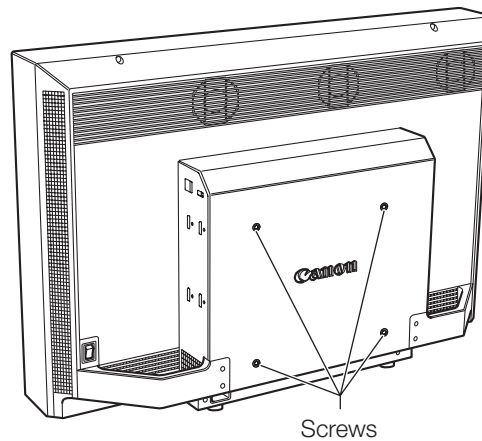

2. Mount the main unit on a stand or wall mount bracket.

Turning on the Power

This section describes how to turn on the power of the main unit.

Turning on the Power of the Main Unit

1. Plug the AC power cord VT-20 to the power supply input terminal at the rear of the main unit.

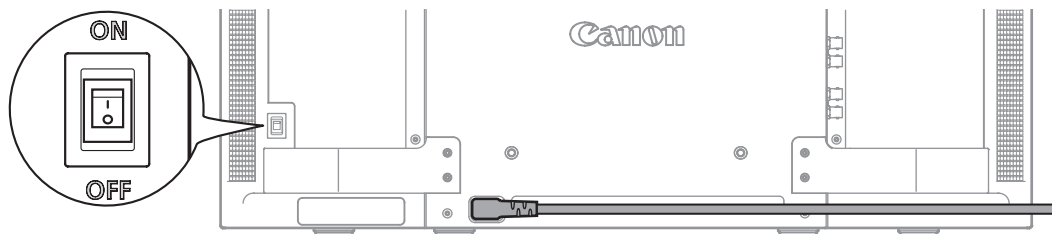



2. Turn on the main power supply switch (I) at the back.
The main unit goes into standby and the power indicator flashes amber.
3. Press the power supply button  at the front.
The power indicator lights green.

Note

- Warming-up is necessary to stabilize the brightness of the video display. Wait at least 10 minutes after turning on the power before using.

Turning on Main Unit Power from the Display Controller

The power button on the display controller remotely turns On/Off the power of the main unit instead of turning On/Off the display controller.

1. Connect the main unit to the display controller ( 19).
2. Press the Power button  on the display controller.
The power indicator of the display controller flashes green and then lights.

Note

- The power indicator on the display controller is lit amber when the main power of the main unit is "Off"/standby. Even when it is lit, the main power of the main unit cannot be turned on/off from the display controller if the main power of the main unit is "Off".

Pairing

To operate the main unit using the display controller, the main unit needs to be registered (paring) to the display controller.

Pairing the Main Unit with the Display Controller

1. **Connect the main unit to the display controller** (📖 19).

2. **Turn on the power of the main unit ("Turning on the Power of the Main Unit" 📖 22).**

This automatically completes pairing and the power indicator of the main unit flashes green and the power indicator of the display controller also lights green.

Note

- Directly pair the main unit and the display controller and then connect to your network environment. Correct pairing may not be possible when multiple devices are connected to the network.
- If the button brightness setting of the display controller is sets to "Off", it will not turn on when pairing completes. Set the button brightness to 1, 2 or 3 if you want to verify when pairing completes (📖 13).
- Manually configure the "IP Address" and "Subnet Mask" as necessary (📖 66).

■ Controlling multiple displays using one display controller

Connected displays are registered to F buttons (F1 to F10) of the display controller in ascending order from F1. Up to ten displays can be registered. You can change the display to be controlled by following the procedures below.

1. **Connect the display to be controlled to the display controller.**

2. **Turn on the power of the display.**

3. **Press the F button the display is registered to while holding down the SET button of the display controller.**

The power indicator of the display flashes green and the power indicator of the display controller lights green.

Note

- You can check the displays registered to F1 to F10 buttons in "Display List" under "System Settings" (📖 67). You can cancel a display registered to an F button or register a display to a different button.

Re-pairing

To pair a display and the display controller again for example when a paired display controller is reconnected.

1. **Connect the main unit to the display controller** (📖 19).
2. **Enable communication between the main unit and the display controller.**

Reset the network settings of the main unit.

To reset the pairing information, press and hold the main unit's F3 and F4 buttons simultaneously for about 3 seconds until the power indicator flashes green. "Configure an IP Address" is set to "Automatic".

Reset the network settings of the display controller.

To reset the pairing information, press and hold the display controller's ◀▶ buttons, and SET buttons simultaneously for about 3 seconds until the power indicator flashes green. "Configure an IP Address" is set to "Automatic". "Display List" is also reset.

When resetting of pairing information is finished for both units and re-pairing is complete, the power indicator of the display controller lights green.

Note

- Directly pair the main unit and the display controller and then connect to your network environment. Correct pairing may not be possible when multiple devices are connected to the network.
- If the button brightness setting of the display controller is set to "Off", it will not turn on when pairing completes. Set the button brightness to 1, 2 or 3 if you want to verify when pairing completes (📖 13).
- Manually configure the "IP Address" and "Subnet Mask" as necessary (📖 66).

Operating the Display Controller

The display controller allows you to easily adjust the input signal settings and image quality. In addition, you can assign the frequently used functions to dedicated buttons.

Adjusting the Image Quality

1. Adjust the image quality by rotating each knob.

Use the slider that appears at the bottom of the screen as guide.

- SHARPNESS
Adjusts the sharpness of the image.
- CHROMA
Adjusts the color saturation of the image.
- BRIGHTNESS
Adjusts the black level of the image.
- CONTRAST
Adjusts the white level of the image.

Adjusting the Image Quality on CDL

1. Switch the CDL select switch to CDL.

2. Use the RGB select button to select the color to adjust.

3. Adjust the image quality by rotating each knob.

- POWER
Adjusts the gamma of the image.
- SATURATION
Adjusts the color saturation of the image.
RGB cannot be selected for SATURATION.
- OFFSET
Adjusts the black level of the image.
- SLOPE
Adjusts the white level of the image.

Item	Setting options (underline indicates the factory default)
POWER	0.50 to 4.00 (<u>1.00</u>) (Increments of 0.01)
SATURATION	0.000 to 2.000 (<u>1.000</u>) (Increments of 0.001)
OFFSET	-1.000 to 1.000 (<u>0.000</u>) (Increments of 0.001)
SLOPE	0.000 to 2.000 (<u>1.000</u>) (Increments of 0.001)

Note

- Press the RESET button above the relevant adjustment, to return to factory default. In "User 1-7" mode where you are performing calibration, the setting returns to the value after calibration instead of the factory default.
- Warming-up is necessary to stabilize the brightness of the video display. Wait at least 10 minutes after turning on the power before using.
- If no operation is performed for approximately 1 minute, OSD menu will disappear automatically. The slider will disappear automatically if no operation is performed for approximately 10 seconds.
- The settings that cannot be set, are grayed out.

Temporarily Saving Parameters (Anchor Point Setting)

Temporarily saves parameters while adjusting SHARPNESS, CHROMA, BRIGHTNESS, and CONTRAST allows you to bring those parameters back. See [📖 46](#) for setting anchor points during CDL adjustment.

1. **Press the MENU button to open the OSD menu.**
2. **Select "Adjustment" with the ▲▼ buttons and press the SET button.**
The selection frame moves to sub menu.
3. **Select "Anchor Adjustment" with the ▲▼ buttons and press the SET button.**
When the confirmation screen appears, select "OK". The parameter is saved and sets anchor point.
4. **After readjusting the image quality, press the RESET button above the relevant adjustment on the display controller.**
Press the RESET button above the relevant adjustment to return to each saved anchor point.

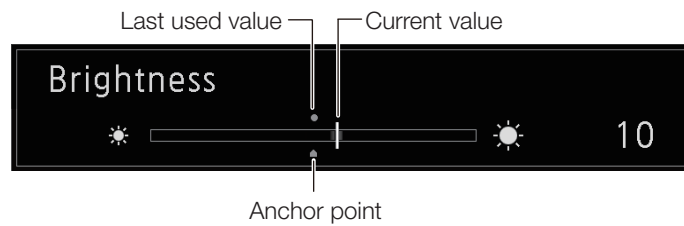

Note

- When selecting "Reset" under "Adjustment" or "Reset All Settings" under "System Settings", any saved anchor points are discarded and the settings return to their factory default values.
- When calibration is performed in "User 1-7" under "Picture Mode", the values are saved as anchor points.

Using the Function (F) Buttons

You can assign functions to the F buttons on the display controller to execute them instantly.

1. **Press the MENU button to open the OSD menu.**
2. **Select "System Settings" → "Function/Channel Button" → "Controller Function" and press the SET button.**
A new window opens and displays button names F1 to F10.
3. **Select a button name with the ▲▼ buttons and press the SET button.**
The selection frame moves to next OSD menu level.
4. **Select the function to assign with ▲▼.**
See "Controller Function" ([📖 66](#)) for the available functions.
5. **Press the SET button.**
The setting is confirmed.

Reference

- You can also assign functions to buttons F1 to F4 on the main unit. Select "Display Function" in step 2 ([📖 66](#)).
- Select "Function Settings" → "Various Function" and set "Function Guide" to "On", then to check the list of functions assigned to an F button on the main unit and display controller, press the SET button while OSD menu is closed ([📖 65](#)).

Using the Channel (CH) Button

You can assign channels (various settings related to input signal) to the CH buttons on the display controller and switch channels instantly.

1. **Press the MENU button to open the OSD menu.**
2. **Select "System Settings"→"Function/Channel Button"→"Controller Channel" and press the SET button.**
A new window opens and displays button names CH1 to CH4.
3. **Select a button name with the ▲▼ buttons and press the SET button.**
The selection frame moves to next OSD menu level.
4. **Select the channel to assign with ▲▼.**
See "Channel Settings" (📖 51) for the configurable settings.
5. **Press the SET button.**
The setting is confirmed.

The channel buttons on the display controller are preset with the following factory defaults.

	CH1	CH2	CH3	CH4
Input Configuration	3G/HD-SDI 1	3G/HD-SDI 2	Dual Link HD-SDI	DisplayPort
Select Input Signal	Automatic	Automatic	Automatic	Automatic
Format	Automatic	Automatic	Automatic	Automatic
Internal Sync	Off	Off	Off	Off
Channel Name	(Blank)	(Blank)	(Blank)	(Blank)
Picture Mode	DCI-P3	DCI-P3	DCI-P3	DCI-P3
Color Range	Automatic	Automatic	Automatic	Automatic

Checking Signal Information and Status of the Main Unit

The video display is equipped with a banner function which displays signal information or the status of the main unit.

1. **Press the SET button when the OSD menu is closed.**
The channel name, signal information, and status of the main unit will be displayed in the banner. It will automatically disappear after 6 seconds.

Note

- For more detailed signal information, please refer to the section on "Signal Information" (📖 70).
- The "Detecting sync." banner will continue to appear until the input signal is synchronized.

Using the OSD Menu

You can access the OSD menu from the display controller.

Basic Operation

1. Press the MENU button to open the OSD menu.

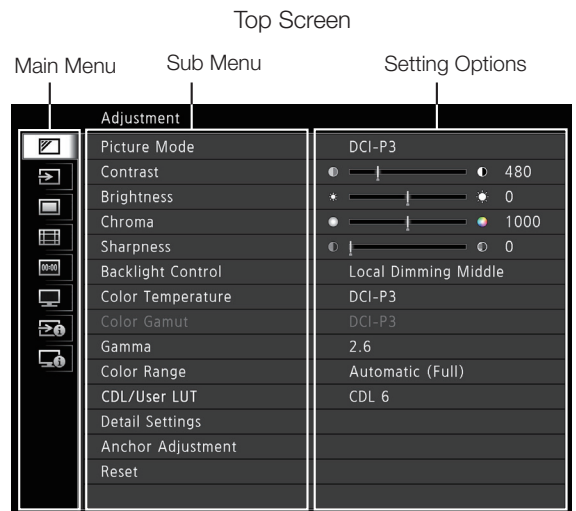

2. Select an item with the ▲▼ buttons and press the SET button.

The selection frame moves to sub menu.

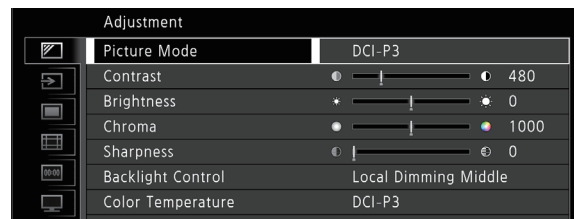

3. Select an item with the ▲▼ buttons and press the SET button.

The selection frame moves to setting options.

4. Select the setting with the ▲▼◀▶ buttons.

The button function for selecting the setting is as follows:

Slider		List	
◀	▶	▲	▼
Decreases value	Increases value	Scrolls up the OSD menu	Scrolls down the OSD menu

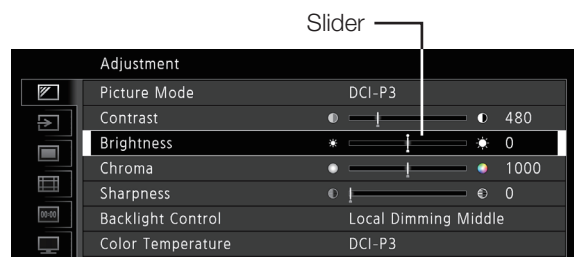

5. Press the SET button.

The selection frame returns to sub menu.

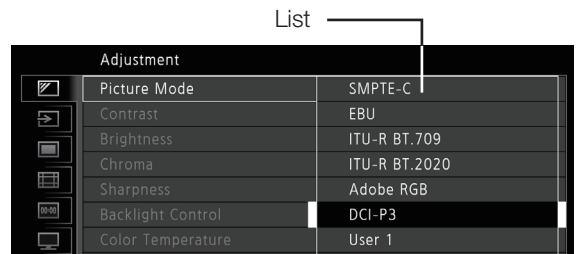

6. Exit menu.

To exit the menu, move the selection frame all the way to the main menu on the top screen and then press the MENU button.

Adjusting Image Quality While Viewing the Entire Image

You can adjust the OSD menu to display as a slider at the bottom of the screen. This allows for the image quality to be adjusted whilst it is displayed on the screen.

1. **Press the SET button when the selection frame is on setting options.**
A slider appears at the bottom of the screen.
2. **Use the slider as guide and adjust with ▲▼◀▶ buttons.**
3. **Press the SET button when finished.**
The screen returns to the original OSD menu.

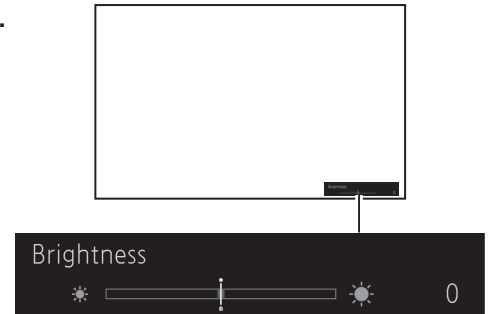

■ Adjusting "Gain R/G/B, Bias R/G/B" under "Color Temperature"

You can adjust RGB all at once or individually when the slider for adjusting "Gain R/G/B" and "Bias R/G/B" are displayed.



1. **Change the guide on the top-right corner of the slide bar screen using the ▲▼ buttons and make adjustments using the ◀▶ buttons.**

The indication changes to "RGB", "R", "G", and "B".

Using the SHARPNESS, CHROMA, BRIGHTNESS, and CONTRAST knobs on the display controller, you can adjust RGB at the same time or R, G, and B individually.

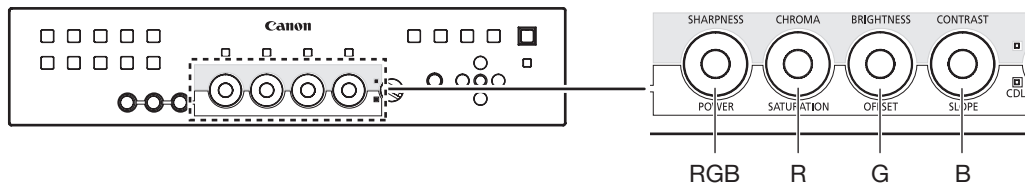

2. **When adjustments are completed, press the SET button.**
The screen returns to the original OSD menu.

■ Adjusting "x, y" under "Color Temperature"

You can adjust "x, y" in "Color Temperature" on the color map.

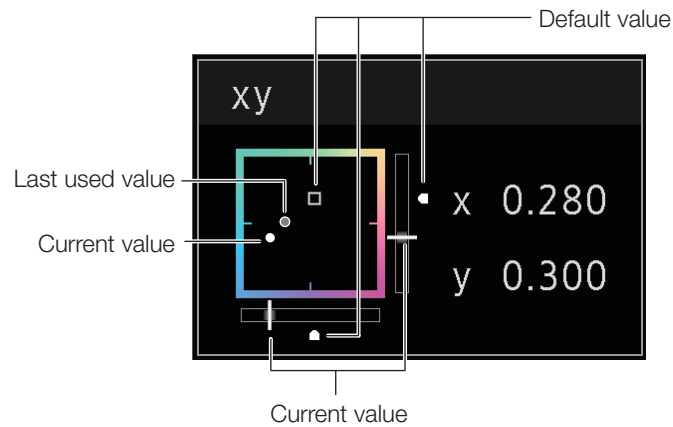

1. Adjust "x" with the ◀▶ button and "y" with ▲▼ button.

The adjusted value is indicated by the "○" mark on the color map.

You can adjust "x" using the POWER knob on the display controller and "y" using the SATURATION knob.

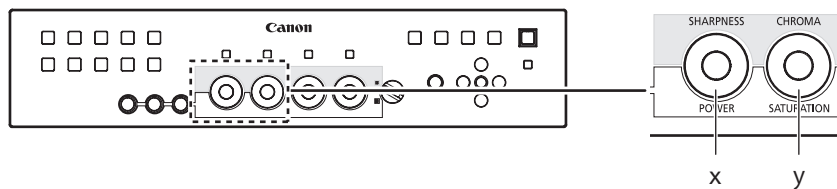

2. When adjustments are completed, press the SET button.

The screen returns to the original OSD menu.

Calibration without a PC (📖 48)

When "User 1-7" under "Picture Mode" is selected, you can perform calibration using an external sensor, without using the computer.

The supported external sensors are Konica Minolta Display Color Analyzers CA-310 and CA-210. Be sure to also read the instruction manual of the CA-310 and CA-210.

- 1. Connect the display color analyzer to the USB port of the main unit.**
- 2. Open the OSD menu and select "Adjustment"→"Detail Settings"→"Calibration".**
Set each target value.
- 3. Select "Start" with the SET button.**
Please follow the information indicated on the screen.
- 4. Initialize the sensor.**
Set the mode dial of the Universal Measuring Probe to "0-CAL".
Select "OK" with the SET button on the and perform initialization.
- 5. Place the sensor facing the center of the main unit.**
Set the mode dial of the Universal Measuring Probe to "MEAS" and place the probe as shown below according to the displayed content. Select "OK" with the SET button on the display controller and perform calibration.

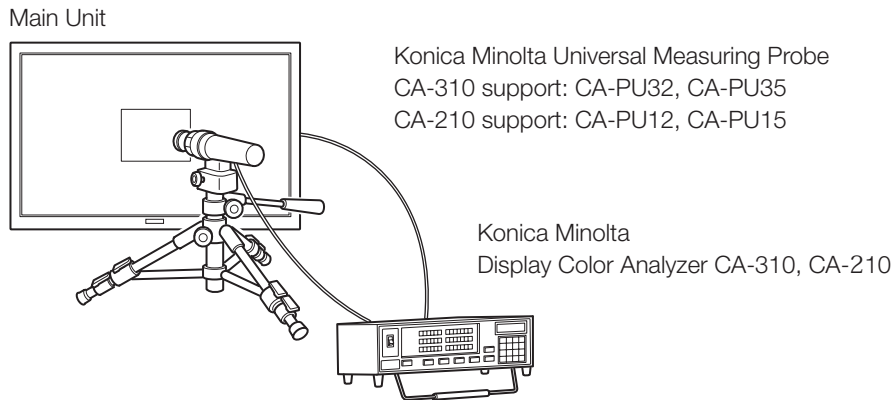

- 6. Finish calibration.**
When the message "Calibration is completed." appears, select "OK" with the SET button.
 - If the message "Calibration error." is displayed.
Calibration has been terminated due to an error. The main unit returns to the state before calibration (📖91).
 - To cancel calibration
Select "Cancel" with the SET button during calibration. The main unit returns to the state before calibration.

Note

- Due to the characteristic of LCD panel and individual difference of CA-310 and CA-210, the calibration results may differ.
- Perform matrix calibration of the display color analyzer prior to calibration. If calibration is performed without performing matrix calibration, an error may occur. Refer to the CA-310 and CA-210 instruction manual for the detail operation.
- Warming-up is necessary to stabilize the brightness of the video display. Wait at least 10 minutes after turning on the power before calibration.
- Perform calibration in a dark room so that no external light enters the sensor. If external light enters the sensor, low brightness characteristics cannot be calibrated correctly.

Export/Import

You can export/import LUT and CDL parameters as well as main menu settings. Insert a USB memory into the USB port of the main unit.

■ LUT Import (47)

Setting is enabled except when "Canon Log (select "Color Gamut" → "ACESproxy")" or "ACESproxy" is selected for "Picture Mode".

1. **Press the MENU button to open the OSD menu.**
2. **Select "Adjustment" → "Detail Settings" → "LUT Import".**
3. **Select a file.**
In the "Filename" field, search and display a file with extension ".clut" in the root folder.
4. **Select the LUT type.**
 - Select the LUT type by using "User LUT", "Gamma LUT" or "Gamut LUT".
 - Refer to the "Concept Drawing of Display Image Processing and LUT". Or, also refer to the "User LUT Creation Guide" on the Canon website.
5. **In "Select LUT", select the destination to save the file.**
Select User LUT/Gamma LUT/Gamut LUT 1-8.
6. **Select the standard color gamut.**
Select the color gamut used when creating the LUT (when "Gamut LUT" under "LUT Type" is selected).
7. **Select "Execute".**
When the confirmation screen appears, select "OK". Import starts.

Note

- The LUT file is proprietary to Canon Video Display. Refer to the Canon website for the file format and how to create.
- Up to 1000 LUT import files are recognized.
- You can delete the imported LUT. You can specify the name of LUT ( 47).

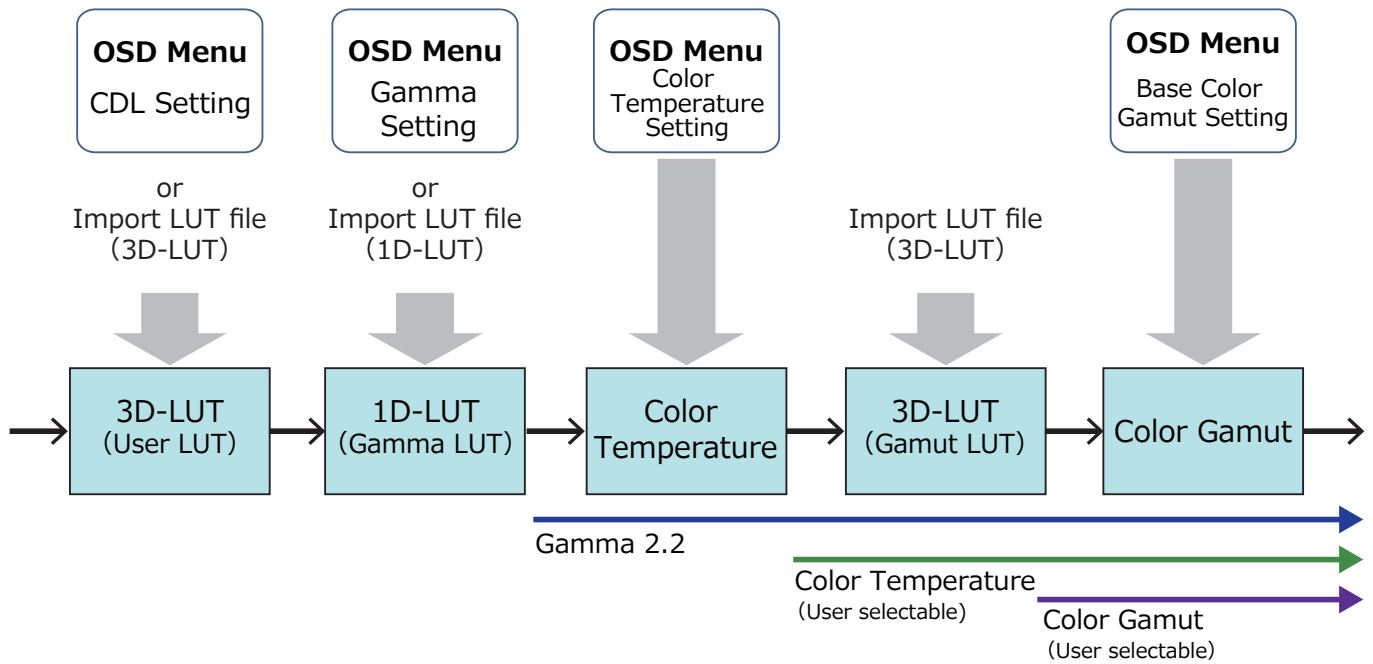

Concept Drawing of Display Image Processing and LUT

■ Export/Import Main Menu Settings (📖68)

1. Press the MENU button to open the OSD menu.
2. Select "System Settings"→"Export/Import".
3. Select "Export" or "Import".

Exporting

- ① Select "Target" from "USB" or "User 1-3".
Export "USB" to the USB memory and "User 1-3" to the built-in memory of the main unit.
- ② Select "Filename".
Factory default is "dinfo.dat". You can change the name of the file to be exported to the USB memory within 16 one-byte characters including alphabetical characters, numbers, and symbols.
- ③ Select "Execute".
When the confirmation screen appears, select "OK". Export starts.

Importing

- ① Select "Target" from "USB" or "User 1-3".
Specify the destination to save the file to be imported.
- ② Select "Filename".
- ③ In "Settings", select "All" or Main Menu name.
- ④ Select "Execute".
When the confirmation screen appears, select "OK". Import starts.

Note

- After export to "User 1-3", you can select the configurations at startup from "User 1-3" in "Power on Setting" in "System Settings" (📖68).

■ Export/Import CDL Parameters (📖 46)

1. Press the MENU button to open the OSD menu.
2. Select "Adjustment" → "CDL/User LUT" → "Type".
Select "CDL".
3. Select "Detail Settings" → "CDL Export" or "CDL Import".

Exporting

- ① Select "CDL Preset".
 - ② Select a file format ".ccc" or ".cdl".
 - ③ Select "Execute".
- When the confirmation screen appears, select "OK". Export starts.

Importing

- ① Select "Filename".
 - ② Select "CDL Preset".
 - ③ Select "Execute".
- When the confirmation screen appears, select "OK". Import starts.

i Reference

- The exported file is automatically saved under the name "YYYYMMDDhhmmss_Preset name.ccc (cdl)".
- Up to 1000 CDL import files are recognized.
- Data in ".cdl" format exported from this product cannot be imported to products of which firmware version is earlier than the version of this product. To import data, update the firmware to the latest version.

Set Date/Time (📖 67)

This section describes how to set the Date/Time. The Date/Time of this video display will be reset if the main power is turned off for about 20 days.

1. Press the MENU button to open the OSD menu.
2. Select "System Settings" → "Date/Time".
A screen to input the Date/Time appears.
3. Set the Date/Time.
Press the ◀▶ buttons to move the selection frame. Use the ▲▼ buttons to change the numeric value. Repeat until you complete setting the year, month, date, hour, and minute.
4. Press the SET button when you are finished.
The selection frame moves to "OK".
5. Check the content and press the SET button to confirm settings.

i Reference

- When selecting "Cancel" or pressing MENU button before selecting "OK", the settings will be discarded and the previous screen will be displayed.

Inputting Characters

This section describes how to input characters. Use this function to specify a channel name, a display name, or filename.

1. Press the MENU button to open the OSD menu.
2. The character input screen appears automatically when character input is required.

Use the ◀▶ buttons to move the selection frame as required.

3. Press the ▲▼ buttons to select the required character.

The following characters can be selected: Press ▲▼ buttons to display them one by one. You can input up to 16 characters.

Alphanumeric characters: A to Z, a to z, 0 to 9

Symbols: , . : ; ' ` - + / = % & ! ? # _ | \$ ^ ~ @ { } [] < > () space

Some characters cannot be used for a filename. In this case, they are automatically skipped.

4. Repeat steps 2 and 3 until the desired text has been inputted.
5. Press the SET button when input is complete.
The selection frame moves to "OK".
6. Check the content and press the SET button to confirm settings.

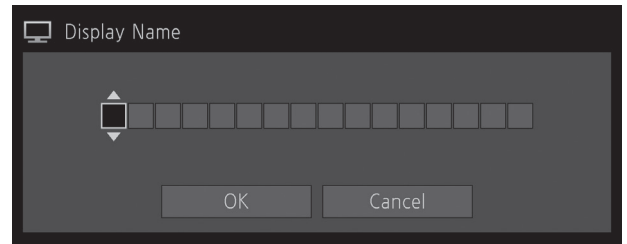

Reference

- When selecting "Cancel" or pressing MENU button before selecting "OK", the settings will be discarded and the previous screen will be displayed.
- To erase the character in the selection frame, press the RESET button above SHARPNESS or CHROMA.

OSD Menu

OSD Menu Index

Adjustment (📖 41)

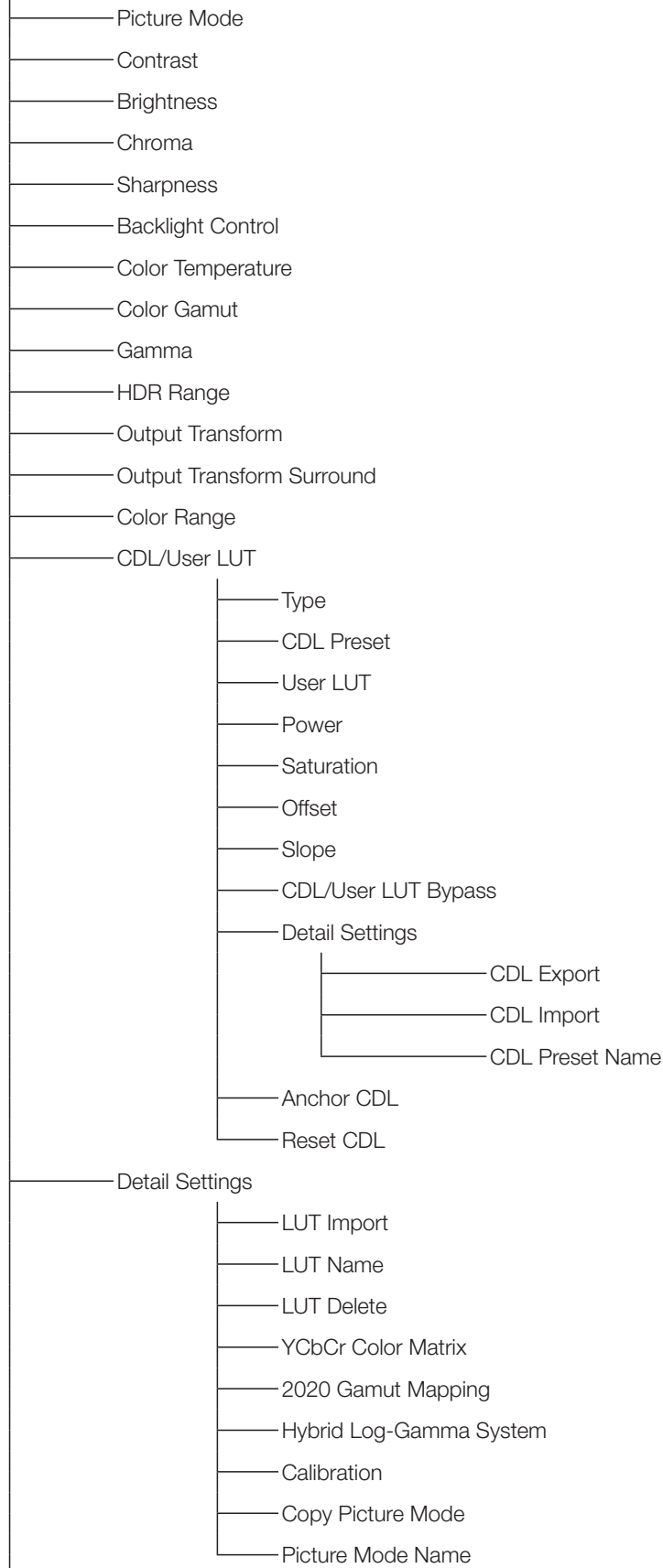

- Anchor Adjustment
- Reset

Channel Settings (📖 51)

- Select Channel
- Input Configuration
- Select Input Signal
- Format
- Internal Sync
- Channel Name
- Picture Mode
- Color Range

Display Settings (📖 53)

- Screen Scaling
- Zoom
- Scaling Method
- Frame Hold
- Background Color
- I/PsF
- I/P Conversion
- PsF
- Film Cadence

Marker Settings (📖 56)

- Marker Preset
- Aspect Marker
 - Enable
 - Mask
 - Aspect Ratio
 - Line
 - Line Width
 - Line Color
 - Line Brightness
 - H Position
 - V Position
- Safety Zone Marker 1, 2
 - Enable
 - Aspect Ratio
 - Area Size
 - Rate (%)
 - Width (dot)
 - Height (dot)
 - Shape
 - Line Width

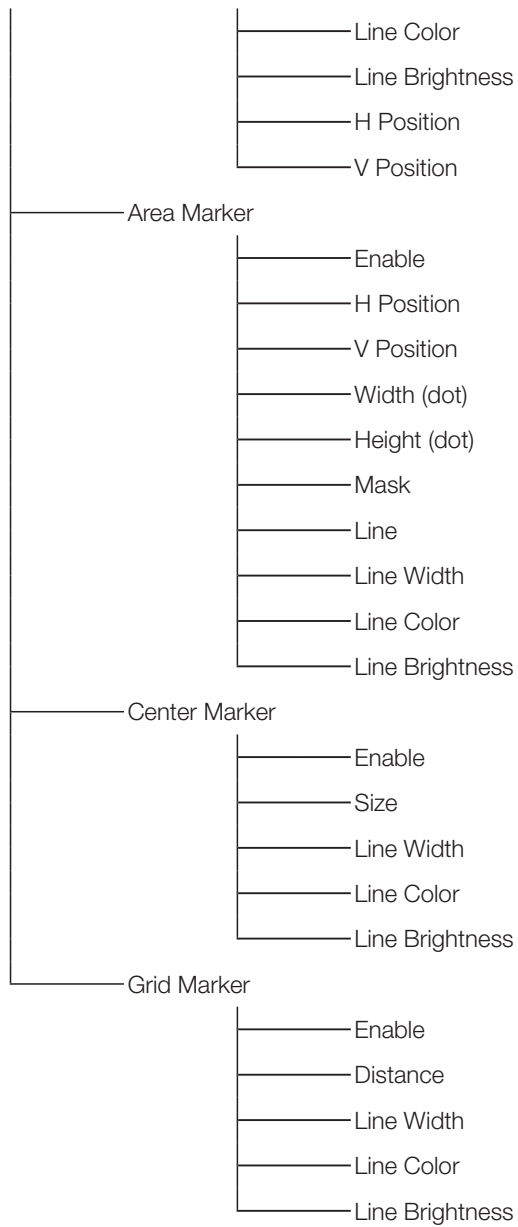

Function Settings (📖 61)

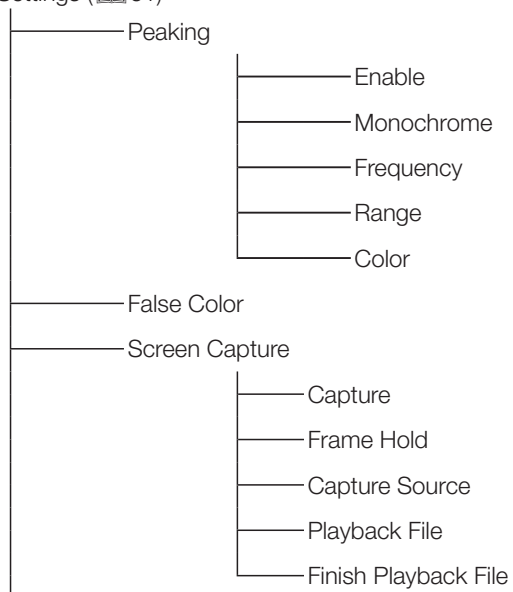

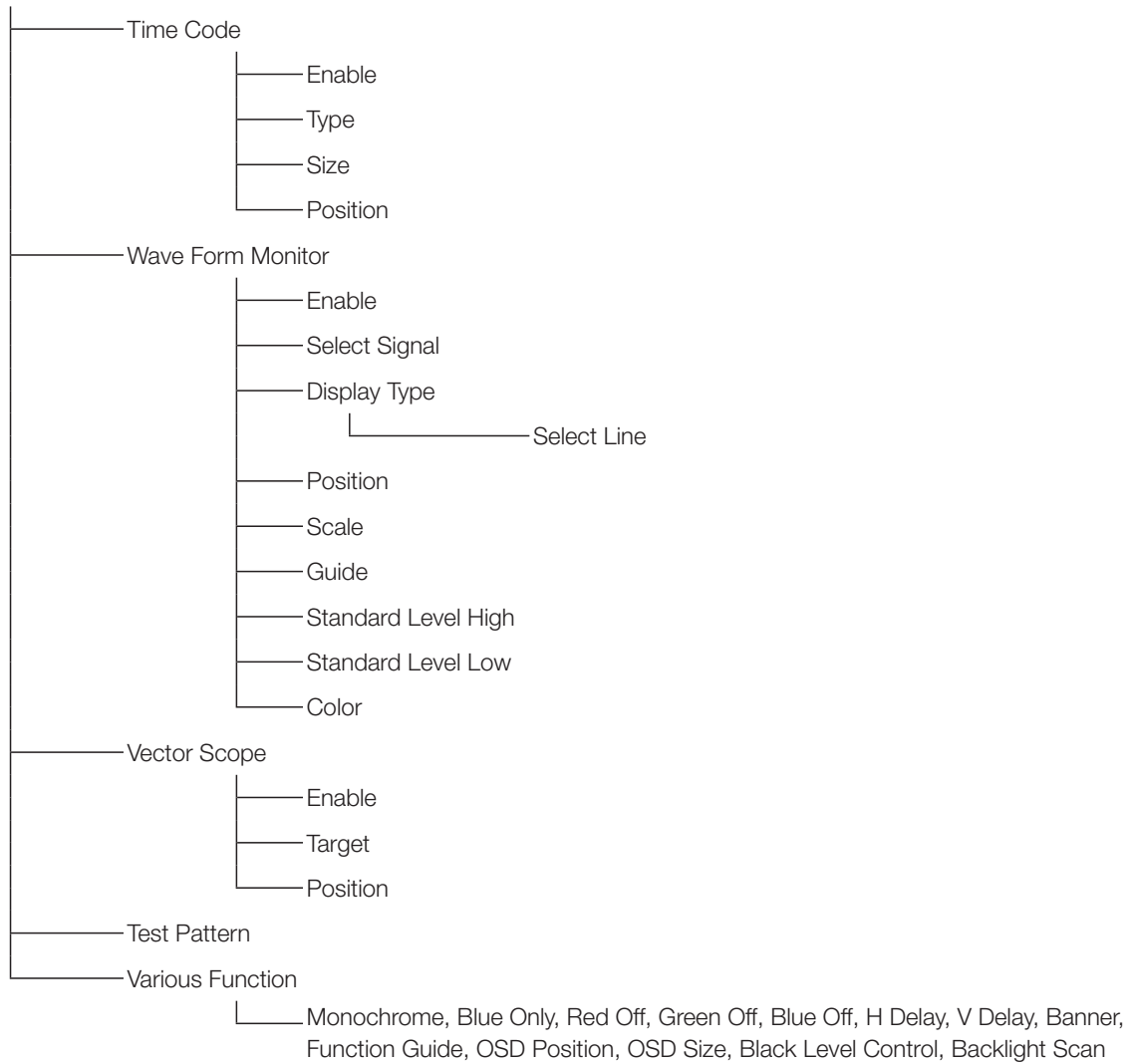

System Settings (📖 66)

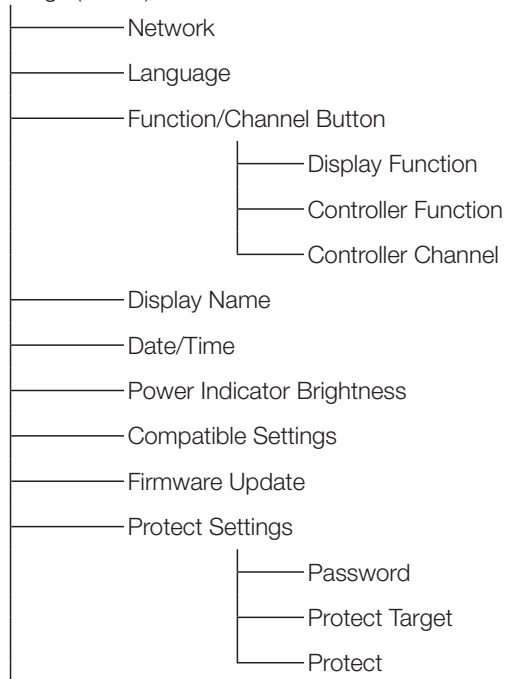

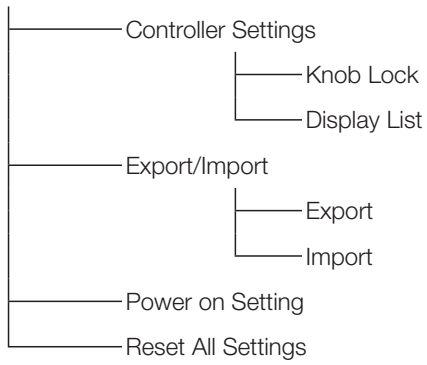

Signal Information (📖 70)

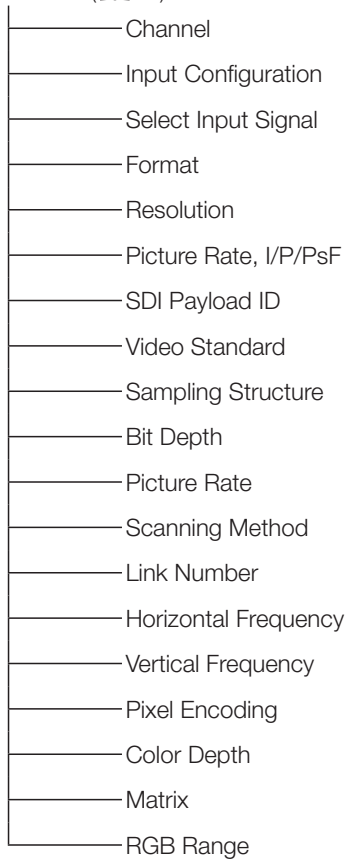



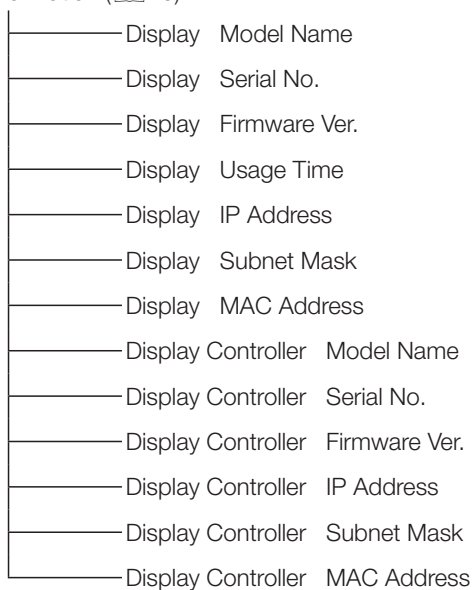

System Information (📖 70)



Adjustment

This menu is used to adjust the image quality and perform calibration without a PC.

Item	Setting Options (underline indicates factory default)
Picture Mode	<p>Select a preset mode. See  49 for each setting.</p> <p>SMPTE-C, EBU, ITU-R BT.709, ITU-R BT.2020, Adobe RGB, DCI-P3: Mode set to the brightness, color temperature, gamma, and color gamut of the three primary colors chromaticity points of each standard.</p> <p>User 1-7: Custom modes. Set each item of "Adjustment". You can change the mode name within 16 one-byte characters including alphabetical characters, numbers, and symbols.</p> <p>Canon Log: Canon Log is ideal when viewing image captured with CINEMA EOS SYSTEM camera/video camera. Displays Canon Log video without having to import Viewing LUT.</p> <p>ACESproxy: This mode is used to display ACESproxy (ACES 0.7/1.0) videos with the optimum gamma and color gamut. The version of ACESproxy can be selected from "Compatible Settings" under "System Settings".</p>
Contrast	<p>Adjusts the white level of the image. (Increments of 1)</p> <p>0 to 2000</p>
Brightness	<p>Adjusts the black level of the image. (Increments of 1)</p> <p>-500 to 500</p>
Chroma	<p>Adjusts the color saturation of the image (color depth). (Increments of 1)</p> <p>0 to 2000</p> <p> Note</p> <ul style="list-style-type: none"> You cannot adjust when "User LUT" in "CDL/User LUT" is selected.
Sharpness	<p>Adjusts the sharpness of the image. (Increments of 1)</p> <p>0 to 100</p>
Backlight Control	<p>Switches the backlight control method.</p> <p>Local Dimming (Auto, High, Middle, Low): Local dimming is a technology to control the amount of light emitted by the backlight for each area. The backlight of bright area is increased and the dark area is decreased according to the displayed content. Contrast increases as local dimming increases ("High").</p> <p>When "Auto" is set, the amount of light is automatically controlled according to the contrast value. Increasing the contrast value makes the backlight darker in dark portions of the image as compared to "High"/"Middle"/"Low".</p> <p>Global Dimming: Global dimming is the ability to control the amount of light emitted by the backlight on the entire screen. If the image is dark, the whole display is darkened.</p> <p>Off: No backlight dimming is applied.</p> <p> Note</p> <ul style="list-style-type: none"> When "Global Dimming" is selected, the contrast may change temporarily in order to maintain gradation depending on the image. If this is undesirable, turn it "Off" and see if it improves.



Item	Setting Options (underline indicates factory default)																		
Color Temperature	<p>Sets the color temperature.</p> <p>D93, D65, D61, D60, D56, D50, DCI-P3: Select from preset color temperatures.</p> <p>Gain R/G/B, Bias R/G/B: Can be adjusted in increments of 1 when a preset color temperature is selected.</p> <p>Gain R/G/B: 0 to 1023</p> <p>Bias R/G/B: -500 to 500</p> <p>Custom (xy): You can adjust CIE x, y in increments of 0.001.</p> <p>x: 0.260 to 0.360</p> <p>y: 0.260 to 0.360</p> <p>Off: Color temperature is not set.</p> <p> Note</p> <ul style="list-style-type: none"> • "Custom (xy)" and "Gain R/G/B" or "Bias R/G/B" cannot be selected at the same time. • When "Gain R/G/B" or "Bias R/G/B" value is adjusted, an asterisk "*" is displayed by color temperature preset mode. • The displayed color coordinates (x, y) are just a guide and not guaranteed absolute values. 																		
Color Gamut	<p>Color gamut can be selected when "User 1-7" or "Canon Log" is selected for "Picture Mode".</p> <p>SMPTE-C, EBU, ITU-R BT.709, ITU-R BT.2020, Adobe RGB, DCI-P3: Color gamut compliant to each standard.</p> <p>Native: Color gamut that can be displayed by this video display.</p> <p>Cinema Gamut to 709, Cinema Gamut to 2020, Cinema Gamut to DCI, DCI-P3+ to 709, DCI-P3+ to DCI, DCI-P3 to 709, ITU-R BT.2020 to 709: Modes where the color gamut is converted to monitor Cinema Gamut, DCI-P3+, ITU-R BT.2020, and DCI-P3 videos recorded by the Digital cinema camera of the CINEMA EOS SYSTEM.</p> <p>ACESproxy: Displays the color gamut of ACESproxy when "Canon Log" is selected.</p> <p>Gamut LUT 1 to Gamut LUT 8: Selects an external LUT.</p> <p> Note</p> <ul style="list-style-type: none"> • To check a video recorded using a CINEMA EOS SYSTEM digital cinema camera, refer to the "Parameter of Cinema EOS System and DP-V3010 (150)". • When "ITU-R BT.2020", "Cinema Gamut to 709", "Cinema Gamut to 2020", "Cinema Gamut to DCI", "DCI-P3+ to 709", "DCI-P3+ to DCI", "DCI-P3 to 709", or "ITU-R BT.2020 to 709" is selected, the DP-V3010 displays images after converting the color gamut as shown below. Data outside of the color gamut after conversion is also displayed at the optimum level. <table border="1" data-bbox="619 1339 1302 1778"> <thead> <tr> <th data-bbox="619 1339 962 1417">Input video color gamut</th> <th data-bbox="962 1339 1302 1417">Color gamut after conversion on the DP-V3010</th> </tr> </thead> <tbody> <tr> <td data-bbox="619 1417 962 1462">ITU-R BT.2020</td> <td data-bbox="962 1417 1302 1462">Native</td> </tr> <tr> <td data-bbox="619 1462 962 1507">Cinema Gamut to 709</td> <td data-bbox="962 1462 1302 1507">ITU-R BT.709</td> </tr> <tr> <td data-bbox="619 1507 962 1552">Cinema Gamut to 2020</td> <td data-bbox="962 1507 1302 1552">Native</td> </tr> <tr> <td data-bbox="619 1552 962 1597">Cinema Gamut to DCI</td> <td data-bbox="962 1552 1302 1597">DCI-P3</td> </tr> <tr> <td data-bbox="619 1597 962 1641">DCI-P3+ to 709</td> <td data-bbox="962 1597 1302 1641">ITU-R BT.709</td> </tr> <tr> <td data-bbox="619 1641 962 1686">DCI-P3+ to DCI</td> <td data-bbox="962 1641 1302 1686">DCI-P3</td> </tr> <tr> <td data-bbox="619 1686 962 1731">DCI-P3 to 709</td> <td data-bbox="962 1686 1302 1731">ITU-R BT.709</td> </tr> <tr> <td data-bbox="619 1731 962 1778">ITU-R BT.2020 to 709</td> <td data-bbox="962 1731 1302 1778">ITU-R BT.709</td> </tr> </tbody> </table>	Input video color gamut	Color gamut after conversion on the DP-V3010	ITU-R BT.2020	Native	Cinema Gamut to 709	ITU-R BT.709	Cinema Gamut to 2020	Native	Cinema Gamut to DCI	DCI-P3	DCI-P3+ to 709	ITU-R BT.709	DCI-P3+ to DCI	DCI-P3	DCI-P3 to 709	ITU-R BT.709	ITU-R BT.2020 to 709	ITU-R BT.709
Input video color gamut	Color gamut after conversion on the DP-V3010																		
ITU-R BT.2020	Native																		
Cinema Gamut to 709	ITU-R BT.709																		
Cinema Gamut to 2020	Native																		
Cinema Gamut to DCI	DCI-P3																		
DCI-P3+ to 709	ITU-R BT.709																		
DCI-P3+ to DCI	DCI-P3																		
DCI-P3 to 709	ITU-R BT.709																		
ITU-R BT.2020 to 709	ITU-R BT.709																		

Item	Setting Options (underline indicates factory default)
Gamma	<p>Sets the Gamma. 2.2, 2.35, 2.4, 2.6, ITU-R BT.1886, Canon Log, Canon Log 2, Canon Log 3: Select the preset gamma. Canon Log (HDR), Canon Log 2 (HDR), Canon Log 3 (HDR), SMPTE ST 2084, Hybrid Log-Gamma Y, Hybrid Log-Gamma RGB: Select the gamma for HDR display. Gamma LUT 1 to Gamma LUT 8: Selects an external LUT. Off: Gamma is not set.</p> <p> Note</p> <ul style="list-style-type: none"> To check a video recorded using a CINEMA EOS SYSTEM digital cinema camera, refer to the "Parameter of Cinema EOS System and DP-V3010 (P.50).

The relationship between "Color Gamut" and "Gamma" that can be selected is shown below. When "Color Gamut" is changed, gamma is changed to the underlined value (default value) only when current gamma value is not selectable.

Picture Mode	Color Gamut	Selectable Gamma
SMPTE-C	Cannot be selected	Off, <u>2.2</u> , 2.35, 2.4, 2.6, ITU-R BT.1886, Canon Log, Canon Log (HDR), SMPTE ST 2084, Gamma LUT 1 to Gamma LUT 8
EBU		Off, 2.2, <u>2.35</u> , 2.4, 2.6, ITU-R BT.1886, Canon Log, Canon Log (HDR), SMPTE ST 2084, Gamma LUT 1 to Gamma LUT 8
ITU-R BT.709, ITU-R BT.2020		Off, <u>2.2</u> , 2.35, 2.4, 2.6, ITU-R BT.1886, Canon Log, Canon Log (HDR), Canon Log 2, Canon Log 2 (HDR), Canon Log 3, Canon Log 3 (HDR), SMPTE ST 2084, Hybrid Log-Gamma Y, Hybrid Log-Gamma RGB, Gamma LUT 1 to Gamma LUT 8
DCI-P3		Off, 2.2, 2.35, 2.4, <u>2.6</u> , ITU-R BT.1886, Canon Log, Canon Log (HDR), Canon Log 2, Canon Log 2 (HDR), Canon Log 3, Canon Log 3 (HDR), SMPTE ST 2084, Gamma LUT 1 to Gamma LUT 8
Adobe RGB		Off, <u>2.2</u> , 2.35, 2.4, 2.6, ITU-R BT.1886, Gamma LUT 1 to Gamma LUT 8
Canon Log, User 1-7	SMPTE-C	Off, <u>2.2</u> , 2.35, 2.4, 2.6, ITU-R BT.1886, Canon Log, Canon Log (HDR), SMPTE ST 2084, Gamma LUT 1 to Gamma LUT 8
	EBU	Off, 2.2, <u>2.35</u> , 2.4, 2.6, ITU-R BT.1886, Canon Log, Canon Log (HDR), SMPTE ST 2084, Gamma LUT 1 to Gamma LUT 8
	ITU-R BT.709, ITU-R BT.2020	Off, <u>2.2</u> , 2.35, 2.4, 2.6, ITU-R BT.1886, Canon Log, Canon Log (HDR), Canon Log 2, Canon Log 2 (HDR), Canon Log 3, Canon Log 3 (HDR), SMPTE ST 2084, Hybrid Log-Gamma Y, Hybrid Log-Gamma RGB, Gamma LUT 1 to Gamma LUT 8
	Adobe RGB	Off, <u>2.2</u> , 2.35, 2.4, 2.6, ITU-R BT.1886, Gamma LUT 1 to Gamma LUT 8
	DCI-P3	Off, 2.2, 2.35, 2.4, <u>2.6</u> , ITU-R BT.1886, Canon Log, Canon Log (HDR), Canon Log 2, Canon Log 2 (HDR), Canon Log 3, Canon Log 3 (HDR), SMPTE ST 2084, Gamma LUT 1 to Gamma LUT 8
	Native	Off, <u>2.2</u> , 2.35, 2.4, 2.6, ITU-R BT.1886, SMPTE ST 2084, Gamma LUT 1 to Gamma LUT 8
	Cinema Gamut to 709, Cinema Gamut to DCI	<u>Canon Log</u> , Canon Log (HDR), Canon Log 2, Canon Log 2 (HDR), Canon Log 3, Canon Log 3 (HDR)
	Cinema Gamut to 2020	<u>Canon Log 2</u> , Canon Log 2 (HDR), Canon Log 3, Canon Log 3 (HDR)
	DCI-P3 to 709, ITU-R BT.2020 to 709	<u>Canon Log 2</u> , Canon Log 3
	DCI-P3+ to 709, DCI-P3+ to DCI	<u>Canon Log</u> , Canon Log (HDR)
Gamut LUT 1 to Gamut LUT 8	Off, <u>2.2</u> , 2.35, 2.4, 2.6, ITU-R BT.1886, Gamma LUT 1 to Gamma LUT 8	

Item	Setting Options (<u>underline indicates factory default</u>)
HDR Range	<p>Sets the display method when Gamma for HDR display is selected.</p> <p>Canon Log (HDR): Sets the "Canon Log" dynamic range to be displayed, from 0 to 800%. (in 100 increments) 100 to <u>800</u></p> <p>Canon Log 2 (HDR): Sets the "Canon Log 2" dynamic range to be displayed, from 0 to 1600%. (in 100 increments) 100 to <u>1600</u></p> <p>Canon Log 3 (HDR): Sets the "Canon Log 3" dynamic range to be displayed, from 0 to 1600%. (in 100 increments) 100 to <u>1600</u></p> <p>SMPTE ST 2084: Sets the dynamic range to be displayed from 0.005 to 10,000 nit that "SMPTE ST 2084" has. (in 100 increments) 100 to <u>4000 (2000)</u></p> <p>Hybrid Log-Gamma Y/RGB: Sets how far to display the "Hybrid Log-Gamma" dynamic range. (100 to 1000 in increments of 100) The upper limit value will change to match the settings of "Hybrid Log-Gamma System". (47) Hybrid Log-Gamma Y: 100 to 1000/2000/4000 Hybrid Log-Gamma RGB: 100 to 1000/2000</p> <p>❖ Setting procedures The procedures below use Canon Log (HDR) as an example. When the maximum value (800%) is specified, the 800% dynamic range of Canon Log is assigned to the dynamic range of the video display. Although the brightness in appearance lowers, you can check the dynamic range included in video signals. When 200% is specified, part exceeding 200% is clipped (gradation is saturated) and part up to 200% is assigned to the dynamic range of the video display. "SMPTE ST 2084" has the dynamic range of 0.005 to 10,000 nit. Therefore, when the maximum value (4000 nit) is specified, part exceeding 4000 nit is clipped and part up to 4000 nit is assigned to the dynamic range of the video display. Although the brightness in appearance lowers, you can check the dynamic range up to 4000 nit. When 1000 nit is specified, part exceeding 1000 nit is clipped and part up to 1000 nit is assigned to the dynamic range of the video display. The brightness of the video display corresponds to the value set for Contrast.</p> <p style="text-align: center;">Canon Log 800% signal (Contrast: 2000)</p> <div style="display: flex; justify-content: space-around;"> <div style="text-align: center;"> <p><u>Canon Log (HDR): Set to 800</u></p> <p>Canon Log range: 0 to 800%</p> <p>DP-V3010 range: 0 to 200%</p> <p>Gradation is reproduced by assigning the range to the range of the DP-V3010 (which lowers the brightness).</p> </div> <div style="text-align: center;"> <p><u>Canon Log (HDR): Set to 200</u></p> <p>Canon Log range: 0 to 800%</p> <p>DP-V3010 range: 0 to 200%</p> <p>Clip (Saturates gradation.)</p> <p>Brightness value corresponding to the contrast setting</p> </div> </div>

Item	Setting Options (underline indicates factory default)															
Output Transform	<p>This is displayed instead of Gamma and Color Gamut when "Canon Log (select "Color Gamut" → "ACESproxy")" or "ACESproxy" is selected for "Picture Mode".</p> <p>ITU-R BT.709, ITU-R BT.2020, DCI-P3: ACESproxy is converted into respective mode.</p> <p> Note</p> <ul style="list-style-type: none"> • "ITU-R BT.2020" can be used only when "1.0" is selected for "ACES" under "Compatible Settings". 															
Output Transform Surround	<p>This is displayed instead of "Gamma" and "Color Gamut" when "Canon Log (select "Color Gamut" → "ACESproxy")" or "ACESproxy" is selected for "Picture Mode".</p> <p>Can be used only when "1.0" is selected for "ACES" under "Compatible Settings".</p> <p>Dim Surround: Enables Dim Surround process specified by ACESproxy (ACES 1.0).</p> <p>Dark Surround: Enables Dark Surround process specified by ACESproxy (ACES 1.0).</p>															
Color Range	<p>Sets the quantization range.</p> <p>Automatic: Sets the range based on signal information automatically.</p> <p>Full (0-255): Sets to Black level: 0; White level: 1023 (10-bit)/4095 (12-bit).</p> <p>Limited 1 (16-235): Limits the black and white range. Black level: 64 (10-bit)/256 (12-bit) White level: 940 (10-bit)/3760 (12-bit)</p> <p>Limited 2 (16-255): Limits the black range. Black level: 64 (10-bit)/256 (12-bit) White level: 1023 (10-bit)/4095 (12-bit)</p> <p> Note</p> <ul style="list-style-type: none"> • When "1.0" is selected for "ACES", under "Compatible Settings", it can be used except when "ACESproxy" is selected for "Picture Mode" or "ACESproxy" is selected for "Color Gamut". • Operations when "Automatic" is selected are described below. <ul style="list-style-type: none"> - When DisplayPort is selected, "Full (0-255)" or "Limited 1 (16-235)" is set automatically depending on DisplayPort signal information. - When SDI is selected, the setting is configured according to the settings for Picture Mode, Color Gamut, and Gamma. <table border="1" data-bbox="496 1189 1445 1653"> <thead> <tr> <th></th> <th>Setting Options</th> <th>Color Range to be Set</th> </tr> </thead> <tbody> <tr> <td>Picture Mode</td> <td>DCI-P3</td> <td rowspan="3">Full (0-255)</td> </tr> <tr> <td>Color Gamut</td> <td>DCI-P3, Cinema Gamut to DCI, DCI-P3+ to DCI</td> </tr> <tr> <td rowspan="2">Gamma</td> <td>Canon Log (HDR), Canon Log 2 (HDR), Canon Log 3 (HDR), SMPTE ST 2084</td> </tr> <tr> <td>Canon Log, Canon Log 2, Canon Log 3</td> <td>Limited 2 (16-255)</td> </tr> <tr> <td>Other than the above</td> <td></td> <td>Limited 1 (16-235)</td> </tr> </tbody> </table>		Setting Options	Color Range to be Set	Picture Mode	DCI-P3	Full (0-255)	Color Gamut	DCI-P3, Cinema Gamut to DCI, DCI-P3+ to DCI	Gamma	Canon Log (HDR), Canon Log 2 (HDR), Canon Log 3 (HDR), SMPTE ST 2084	Canon Log, Canon Log 2, Canon Log 3	Limited 2 (16-255)	Other than the above		Limited 1 (16-235)
	Setting Options	Color Range to be Set														
Picture Mode	DCI-P3	Full (0-255)														
Color Gamut	DCI-P3, Cinema Gamut to DCI, DCI-P3+ to DCI															
Gamma	Canon Log (HDR), Canon Log 2 (HDR), Canon Log 3 (HDR), SMPTE ST 2084															
	Canon Log, Canon Log 2, Canon Log 3	Limited 2 (16-255)														
Other than the above		Limited 1 (16-235)														

Item	Setting Options (underline indicates factory default)
CDL/User LUT	<p>Configures settings for CDL or User LUT.</p> <p>Type (CDL, User LUT, Off): Select the type.</p> <p>■ When "CDL" is selected</p> <p>CDL Preset: Select "CDL Preset". CDL 1 to CDL 15</p> <p>Power: Adjusts the Gamma of the image. (0.01 increments) 0.50 to 4.00 (1.00)</p> <p>Saturation: Adjusts the color saturation of the image. (0.001 increments) 0.000 to 2.000 (1.000)</p> <p>Offset: Adjusts the black level of the image. (0.001 increments) -1.000 to 1.000 (0.000)</p> <p>Slope: Adjusts the white level of the image. (0.001 increments) 0.000 to 2.000 (1.000)</p> <p>CDL/User LUT Bypass: When set to "On", you can temporarily disable the CDL adjustment result and return to previously set image quality. On, Off</p> <p>Detail Settings</p> <p>CDL Export: Exports CDL parameters. CDL Preset (CDL 1 to CDL 15, All), File Type (CCC, CDL), Execute</p> <p>CDL Import: Imports CDL parameters. Filename, CDL Preset (CDL 1 to CDL 15), Execute</p> <p>CDL Preset Name: You can specify the name of preset mode within 16 one-byte characters including alphabetical characters, numbers, and symbols.</p> <p>Anchor CDL: You can temporarily save parameters for "Power", "Saturation ", "Offset ", and "Slope" and recover the values. (anchor point setting)</p> <p>Reset CDL: Resets CDL parameters.</p> <p>■ When "User LUT" is selected</p> <p>User LUT: Sets preset of the User LUT. User LUT 1 to User LUT 8</p> <p>CDL/User LUT Bypass: When set to "On", you can return to the image quality before user LUT was applied. On, Off</p> <p> Note</p> <ul style="list-style-type: none"> • When "User LUT" is selected, all "CDL" items, "Chroma", and "Blue Only" cannot be changed.

Item	Setting Options (underline indicates factory default)
Detail Settings	Sets details for Picture Mode.
LUT Import	<p>LUT can be imported except when "Canon Log (select "Color Gamut" → "ACESproxy")" or "ACESproxy" is selected for "Picture Mode". File names that can be imported can be up to 48 one-byte characters, including alphabetical characters, numbers, and symbols (including file extensions).</p> <p>Filename: Select a filename.</p> <p>LUT Type (User LUT, Gamma LUT, Gamut LUT): Select the LUT type.</p> <p>Select LUT: Selects User LUT/Gamma LUT/Gamut LUT 1-8.</p> <p>Base Color Gamut (SMPTE-C, EBU, ITU-R BT.709, Adobe RGB, DCI-P3, Native): Selects the color gamut used when creating the LUT (when "Gamut LUT" under "LUT Type" is selected).</p> <p>Execute: Performs import.</p>
LUT Name	<p>You can specify the name of LUT within one-byte 24 characters including alphabetical characters, numbers, and symbols.</p> <p>LUT Type (User LUT, Gamma LUT, Gamut LUT): Select the LUT type.</p> <p>Select LUT: Selects User LUT/Gamma LUT/Gamut LUT 1-8.</p> <p>Input Name: Input the LUT name.</p>
LUT Delete	<p>Deletes imported LUT.</p> <p>LUT Type (User LUT, Gamma LUT, Gamut LUT): Select the LUT type.</p> <p>Select LUT: Selects User LUT/Gamma LUT/Gamut LUT 1-8.</p> <p>Delete: Deletes LUT.</p>
YCbCr Color Matrix	<p>Sets the matrix conversion method for input signals in YCbCr format.</p> <p>Automatic: Matrix coefficient is set in conformance with the ITU-R BT.2020 standard when the "Picture Mode" or "Color Gamut" setting is "ITU-R BT.2020" and in conformance with the ITU-R BT.709 standard otherwise.</p> <p>ITU-R BT.709: Matrix coefficient is set in conformance with the ITU-R BT.709 standard.</p> <p>ITU-R BT.2020: Matrix coefficient is set in conformance with the ITU-R BT.2020 standard.</p>
2020 Gamut Mapping	<p>Set this item when "ITU-R BT.2020" is selected for "Picture Mode" or when "User 1-7" or "Canon Log" is selected for "Picture Mode" and also "ITU-R BT.2020" is selected for "Color Gamut".</p> <p>Gamut Mapping: Mapping is performed on colors outside the native color gamut by Canon's unique method.</p> <p>Clipping: Colors outside the native color gamut are clipped by a general method.</p>
Hybrid Log-Gamma System	<p>Sets the peak brightness when selecting "Hybrid Log-Gamma Y" or "Hybrid Log-Gamma RGB" in "Gamma".</p> <p>The maximum value for each setting becomes the upper limit value of "HDR Range".</p> <p>■ When "Hybrid Log-Gamma Y" is selected <u>γ1.2 - 1000 cd/m²</u>, <u>γ1.325 - 2000 cd/m²</u>, <u>γ1.45 - 4000 cd/m²</u></p> <p>■ When "Hybrid Log-Gamma RGB" is selected <u>γ1.2 - 1000 cd/m²</u>, <u>γ1.2 - 2000 cd/m²</u></p>

Item	Setting Options (underline indicates factory default)
Calibration	<p>Performs calibration based on set target values when "User 1-7" is selected for "Picture Mode".</p> <p>Luminance: Sets the target luminance. <u>48</u> to 200 cd/m²</p> <p>Color Temperature: Sets the target color temperature. D93, D65, D61, D60, D56, D50, DCI-P3: Select from preset color temperatures. Custom (xy): You can adjust CIE x, y in increments of 0.001. x: 0.260 to 0.360 (0.314)/y: 0.260 to 0.360 (0.351)</p> <p>Color Gamut: Sets the color gamut. SMPTE-C, EBU, ITU-R BT.709, ITU-R BT.2020, Adobe RGB, DCI-P3</p> <p>Gamma: Sets the target gamma. 2.2, 2.35, 2.4, 2.6, ITU-R BT.1886</p> <p>Start: Performs calibration.</p> <p> Note</p> <ul style="list-style-type: none"> When "Luminance" is set to high brightness, it may be calibrated beyond the brightness adjustment range and set lower than the target value depending on the "Color Temperature" setting. In that case, set the "Luminance" again.
Copy Picture Mode	<p>When "User 1-7" is selected for "Picture Mode", the content of the selected picture mode is copied. The following modes can be selected:</p> <p>Picture Mode: SMPTE-C, EBU, ITU-R BT.709, ITU-R BT.2020, Adobe RGB, DCI-P3, User 1-7 (other than the currently set parameter)</p> <p>Execute: Performs copy.</p>
Picture Mode Name	<p>You can change the name of "User 1-7" within 16 characters including alphabetical characters, numbers, and symbols.</p>
Anchor Adjustment	<p>Temporarily saves parameters while adjusting SHARPNESS, CHROMA, BRIGHTNESS, and CONTRAST (anchor point setting).</p> <p>OK: Performs anchor point setting.</p> <p>Cancel: Returns to the previous screen without setting anchor point.</p>
Reset	<p>Return "Picture Mode" to factory default. Note that in "User 1-7" mode where you are performing calibration, the setting returns to the value after calibration instead of the factory default. When selected, the message "Reset Adjustment settings to defaults?" appears.</p> <p>OK: Performs reset.</p> <p>Cancel: Returns to the previous screen without resetting.</p>

The factory default settings for each "Picture Mode" is as follows:

Item		SMPTE-C	EBU	ITU-R BT. 709	ITU-R BT.2020	Adobe RGB
Contrast		1000	1000	1000	1000	1000
Brightness		0	0	0	0	0
Chroma		1000	1000	1000	1000	1000
Sharpness		0	0	0	0	0
Local Dimming		Middle	Middle	Middle	Middle	Middle
Color Temperature	Preset	D65	D65	D65	D65	D65
	x	0.313	0.313	0.313	0.313	0.313
	y	0.329	0.329	0.329	0.329	0.329
	Gain R/G/B	1023	1023	1023	1023	1023
	Bias R/G/B	0	0	0	0	0
Gamma		2.2	2.35	2.2	2.2	2.2
Color Gamut		SMPTE-C	EBU	ITU-R BT.709	ITU-R BT.2020	Adobe RGB
Color Range		Automatic	Automatic	Automatic	Automatic	Automatic
Output Transform		-	-	-	-	-
Output Transform Surround		-	-	-	-	-
CDL Preset		CDL 1	CDL 2	CDL 3	CDL 4	CDL 5
User LUT		User LUT 1	User LUT 1	User LUT 1	User LUT 1	User LUT 1
YCbCr Color Matrix		Automatic	Automatic	Automatic	Automatic	Automatic
2020 Gamut Mapping		Gamut Mapping	Gamut Mapping	Gamut Mapping	Gamut Mapping	Gamut Mapping
Hybrid Log-Gamma System		$\gamma 1.2 - 1000 \text{ cd/m}^2$	$\gamma 1.2 - 1000 \text{ cd/m}^2$	$\gamma 1.2 - 1000 \text{ cd/m}^2$	$\gamma 1.2 - 1000 \text{ cd/m}^2$	$\gamma 1.2 - 1000 \text{ cd/m}^2$

Item		DCI-P3	User 1-7	Canon Log	ACESproxy
Contrast		480	480	1000	480
Brightness		0	0	0	0
Chroma		1000	1000	1000	1000
Sharpness		0	0	0	0
Local Dimming		Middle	Middle	Middle	Middle
Color Temperature	Preset	DCI-P3	DCI-P3	D65	D60
	x	0.314	0.314	0.313	0.322
	y	0.351	0.351	0.329	0.338
	Gain R/G/B	1023	1023	1023	1023
	Bias R/G/B	0	0	0	0
Gamma		2.6	2.6	Canon Log	–
Color Gamut		DCI-P3	DCI-P3	ITU-R BT.709	ACESproxy
Color Range		Automatic	Automatic	Automatic	Automatic
Output Transform		–	–	DCI-P3	DCI-P3
Output Transform Surround		–	–	Dark Surround	Dark Surround
CDL Preset		CDL 6	CDL 7-13	CDL 14	CDL 15
User LUT		User LUT 1	User LUT 1	User LUT 1	User LUT 1
YCbCr Color Matrix		Automatic	Automatic	Automatic	Automatic
2020 Gamut Mapping		Gamut Mapping	Gamut Mapping	Gamut Mapping	Gamut Mapping
Hybrid Log-Gamma System		γ 1.2 - 1000 cd/m ²	γ 1.2 - 1000 cd/m ²	γ 1.2 - 1000 cd/m ²	γ 1.2 - 1000 cd/m ²

Parameter of Cinema EOS System and DP-V3010

Cinema EOS System		DP-V3010			
Color Space	Gamma	Color Gamut	Gamma	Color Temperature	Color Range
BT.709	Canon Log	ITU-R BT.709	Canon Log	D65	Automatic
BT.2020		ITU-R BT.2020		D65	
Cinema Gamut		Cinema Gamut to 709		D65	
		Cinema Gamut to DCI-P3		DCI-P3	
DCI-P3+		DCI-P3+ to 709		D65	
	DCI-P3+ to DCI-P3	DCI-P3			
BT.2020	Canon Log 2, Canon Log 3	ITU-R BT.2020	Canon Log 2, Canon Log 3	D65	
Cinema Gamut		Cinema Gamut to 709		D65	
		Cinema Gamut to DCI-P3		DCI-P3	

Channel Settings

This menu is used for input related settings. Select the "Select Channel" item and choose a channel number from CH1 to CH30. Finally define the parameter of each of the "Channel Settings".

Item	Setting Options (<u>underline indicates factory default</u>)
Select Channel	<p>Displays the channel number. In addition, you can assign each content of "Channel Settings" to each channel (📖 52).</p> <p>CH1 to CH30</p> <p>📎 Note</p> <ul style="list-style-type: none"> It may take 10 seconds when switching channels.
Input Configuration	<p>Select the input. Factory default depends on the channel (📖 52).</p> <p>3G/HD-SDI 1, 3G/HD-SDI 2, Dual Link HD-SDI, DisplayPort, — (Not set)</p>
Select Input Signal	<p>Sets the signal display method (📖 16).</p> <p>Automatic: "4K Input" and "Single Input" are automatically determined.</p> <p>4K Input: Displays the signal transmitted over four inputs.</p> <div data-bbox="491 734 1129 927" style="text-align: center;"> </div> <p>Single Input: Displays the signal of a single input onto the center of the screen. Select from A to D.</p> <div data-bbox="496 1025 794 1205" style="text-align: center;"> </div>
Format	<p>Sets the color format and gradation.</p> <p>Automatic, 4:2:2 YCbCr 10-bit, 4:2:2 YCbCr 12-bit, 4:4:4 YCbCr 10-bit, 4:4:4 YCbCr 12-bit, 4:4:4 RGB 10-bit, 4:4:4 RGB 12-bit, 4:4:4 XYZ 12-bit</p> <p>📎 Note</p> <ul style="list-style-type: none"> HD-SDI is fixed to "4:2:2 YCbCr 10-bit". DisplayPort is fixed to "Automatic". Operations when "Automatic" is selected are described below: <ul style="list-style-type: none"> When "4K Input" is selected, they are rendered in a Payload that is selected in the order of priority A → B → C → D in the display area. When receiving 3G-SDI or Dual Link HD-SDI input, all signals without a payload format will be rendered in "4:4:4 RGB 10-bit".
Internal Sync	<p>Synchronizes four inputs for "4K Input".</p> <p>On: Force synchronization.</p> <p>Off: Do not force synchronization.</p>
Channel Name	<p>Sets the name of the selected channel. You can input up to 16 alphanumeric characters.</p>
Picture Mode	<p>Sets the "Picture Mode".</p>

Item	Setting Options (<u>underline indicates factory default</u>)																
Color Range	<p>Sets the quantization range.</p> <p>Automatic: Sets the range based on signal information automatically.</p> <p>Full (0-255): Sets to Black level: 0; White level: 1023 (10-bit)/4095 (12-bit).</p> <p>Limited 1 (16-235): Limits the black and white range. Black level: 64 (10-bit)/256 (12-bit) White level: 940 (10-bit)/3760 (12-bit)</p> <p>Limited 2 (16-255): Limits the black range. Black level: 64 (10-bit)/256 (12-bit) White level: 1023 (10-bit)/4095 (12-bit)</p> <p> Note</p> <ul style="list-style-type: none"> • When "1.0" is selected for "ACES", under "Compatible Settings", it can be used except when "ACESproxy" is selected for "Picture Mode" or "ACESproxy" is selected for "Color Gamut". • Operations when "Automatic" is selected are described below. <ul style="list-style-type: none"> - When DisplayPort is selected, "Full (0-255)" or "Limited 1 (16-235)" is set automatically depending on DisplayPort signal information. - When SDI is selected, the setting is configured according to the settings for Picture Mode, Color Gamut, and Gamma. <table border="1" style="width: 100%; border-collapse: collapse;"> <thead> <tr> <th></th> <th>Setting Options</th> <th>Color Range to be Set</th> </tr> </thead> <tbody> <tr> <td>Picture Mode</td> <td>DCI-P3</td> <td rowspan="3">Full (0-255)</td> </tr> <tr> <td>Color Gamut</td> <td>DCI-P3, Cinema Gamut to DCI, DCI-P3+ to DCI</td> </tr> <tr> <td>Gamma</td> <td>Canon Log (HDR), Canon Log 2 (HDR), Canon Log 3 (HDR), SMPTE ST 2084</td> </tr> <tr> <td></td> <td>Canon Log, Canon Log 2, Canon Log 3</td> <td>Limited 2 (16-255)</td> </tr> <tr> <td>Other than the above</td> <td></td> <td>Limited 1 (16-235)</td> </tr> </tbody> </table>		Setting Options	Color Range to be Set	Picture Mode	DCI-P3	Full (0-255)	Color Gamut	DCI-P3, Cinema Gamut to DCI, DCI-P3+ to DCI	Gamma	Canon Log (HDR), Canon Log 2 (HDR), Canon Log 3 (HDR), SMPTE ST 2084		Canon Log, Canon Log 2, Canon Log 3	Limited 2 (16-255)	Other than the above		Limited 1 (16-235)
	Setting Options	Color Range to be Set															
Picture Mode	DCI-P3	Full (0-255)															
Color Gamut	DCI-P3, Cinema Gamut to DCI, DCI-P3+ to DCI																
Gamma	Canon Log (HDR), Canon Log 2 (HDR), Canon Log 3 (HDR), SMPTE ST 2084																
	Canon Log, Canon Log 2, Canon Log 3	Limited 2 (16-255)															
Other than the above		Limited 1 (16-235)															





The factory default settings for each channel is shown in the following table.





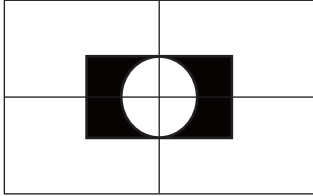
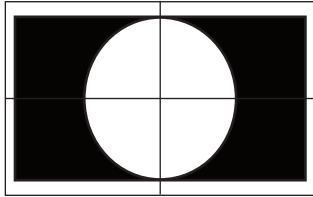
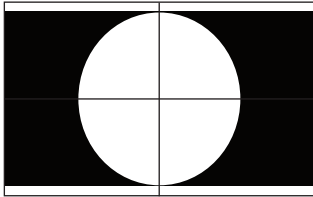

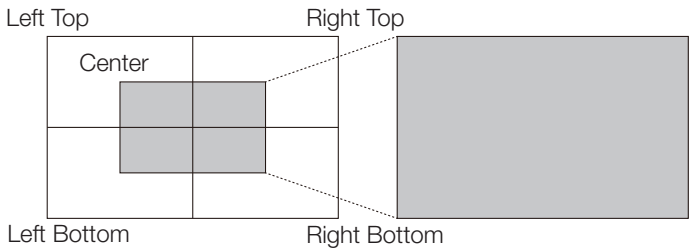
	CH1	CH2	CH3	CH4	CH5 to CH30
Input Configuration	3G/HD-SDI 1	3G/HD-SDI 2	Dual Link HD-SDI	DisplayPort	–
Select Input Signal	Automatic	Automatic	Automatic	Automatic	Automatic
Format	Automatic	Automatic	Automatic	Automatic	Automatic
Internal Sync	Off	Off	Off	Off	Off
Channel Name	(Blank)	(Blank)	(Blank)	(Blank)	(Blank)
Picture Mode	DCI-P3	DCI-P3	DCI-P3	DCI-P3	DCI-P3
Color Range	Automatic	Automatic	Automatic	Automatic	Automatic

– : not set

Display Settings

This menu is used to configure the display method.





Item	Setting Options (<u>underline indicates factory default</u>)
<p>Screen Scaling</p>	<p>Defines how the video is scaled and displayed on the screen. Native Input Resolution: Displays the input signal without scaling.</p>  <p>1920x1080 (original)</p> <p>200%: Doubles the vertical and horizontal dimensions.</p>  <p>1920x1080→3840x2160</p> <p>Automatic: Enlarges to full screen.</p>  <p>1920x1080→4096x2304</p> <p> Note</p> <ul style="list-style-type: none"> • Even if "Automatic" is selected, the magnification is up to 200% in the following cases: <ul style="list-style-type: none"> - When "Peaking 1" or "Peaking 2" is selected - When "False Color" is "On"
<p>Zoom</p>	<p>When the resolution is 4096x2560, 4096x2160 or 3840x2160, the enlarged image is displayed at the center of the screen or at the position selected screen of a 4-screen layout.</p> <p>Center, Top Left, Top Right, Bottom Left, Bottom Right, <u>Off</u></p>  <p> Note</p> <ul style="list-style-type: none"> • In the case of SDI signal, setting is disabled when "H Delay" or "V Delay" is "On". • When DisplayPort is selected, "Center" cannot be selected.



Item	Setting Options (underline indicates factory default)
Scaling Method	<p>Sets the interpolation method when "Screen Scaling" is set to "200%" or "Automatic".</p> <p><u>Shape Trace</u>: Canon original processing that produces smooth slopes with reduced jagged lines.</p>  <p>Bicubic: General interpolation process that uses neighboring pixel information to create interpolated pixels.</p>  <p>Nearest Neighbor: Process that uses nearest neighbor pixel information to create (copy) new pixels. This is useful as it enlarges the original pixels, thus making any jagged lines visible.</p>  <p> Note</p> <ul style="list-style-type: none"> • In the case of SDI signal, setting is disabled when "H Delay" or "V Delay" is "On".
Frame Hold	<p>Pauses the video.</p> <p>On, <u>Off</u></p> <p> Note</p> <ul style="list-style-type: none"> • Setting is disabled when "Peaking 1" or "Peaking 2" is selected. • Setting is disabled when "False Color" is set to "On".
Background Color	<p>Sets the color of the black band to check the boundary of the black band and video image.</p> <p>White, Gray, <u>Off</u></p> <p> Note</p> <ul style="list-style-type: none"> • Setting is disabled when "Peaking 1" or "Peaking 2" is selected.
I/PsF	<p>Defines how the interlace signal or PsF signal is displayed.</p> <p><u>Automatic</u>: Automatically determined based on payload and displayed. If there is no payload, the signal is displayed as an interlace signal.</p> <p>Interlace: Displayed as an interlace signal.</p> <p>PsF: Displayed as a PsF signal.</p>
I/P Conversion	<p>Sets the interlaced signal I/P conversion method.</p> <p>Image Priority: This mode gives priority to image quality. Processing time will be longer than "Speed Priority".</p> <p>Speed Priority: This mode gives priority to speed.</p>
PsF	<p>Defines how the PsF signal is displayed.</p> <p>Progressive: Interpolates giving preference to image quality by detecting paired fields.</p> <p>Interlace: Interpolates using two adjacent fields giving priority to speed.</p>



Item	Setting Options (underline indicates factory default)
Film Cadence	<p>Sets the film cadence mode.</p> <p>2-2: Displays progressive image after conversion for 2-2 pulldown processed interlaced signal input.</p> <p>2-3: Displays progressive image after conversion for 2-3 pulldown processed interlaced signal input.</p> <p>2-3-3-2: Displays progressive image after conversion for 2-3-3-2 pulldown processed interlaced signal input.</p> <p>Off: Does not perform film cadence mode progressive conversion.</p> <p> Note</p> <ul style="list-style-type: none"> • This can be set only when "I/P Conversion" is set to "Image Priority".



Marker Settings



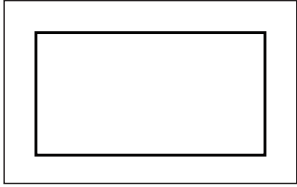

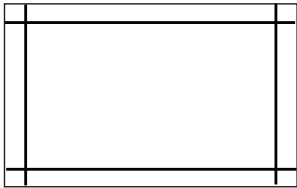
This menu is used to configure various markers.

Item	Setting Options (underline indicates factory default)
Marker Preset	Customizes markers which are assigned to markers 1 to 5. Marker 1 to 5, Off
Aspect Marker	An aspect marker displays a range in accordance with the specified aspect ratio.  <p> Note</p> <ul style="list-style-type: none"> • In the case of SDI signal, setting is disabled when "H Delay" or "V Delay" is "On". • Aspect marker is not displayed in the following cases: <ul style="list-style-type: none"> - When there is no signal, unsupported signal, or a channel with "Input Configuration" not set is selected - When an enlarged image is displayed - During the execution of "Playback File" under "Screen Capture" - When "H Delay" or "V Delay" is "On" - When a "Test Pattern" is displayed - When "Peaking 1" or "Peaking 2" is selected
Enable	Switches the aspect marker On, Off. On, Off
Mask	Switches the mask color. Mask is the blanking area outside the range of the marker. Black:  Half (50% gray):  Off: Turns mask off. <p> Note</p> <ul style="list-style-type: none"> • Because the Wave Form Monitor, Vector Scope and Time Code appear under the Mask, a part of them is hidden by the Mask.

Item	Setting Options (underline indicates factory default)
Aspect Ratio	Sets the aspect ratio of the aspect marker. 16:9, 15:9, 14:9, 13:9, 4:3, 2.39:1, 2.35:1, 1.896:1, 1.85:1, 1.66:1, Variable The aspect ratio can be entered as a numeric value when you select "Variable" (0.01:1 increments). The grayed out slider becomes active and can be used to set the aspect ratio. 1.00:1 to 3.00:1 (1.78:1)
Line	Active when "Black" or "Half" is selected for "Mask". Switches lines on mask On, Off. On, Off
Line Width	Sets the thickness of the aspect marker line. Thick, Normal, Thin
Line Color	Sets the color of the aspect marker line. White, Red, Green, Blue, Yellow, Cyan, Magenta
Line Brightness	Sets the brightness of the aspect marker line. High, Low
H Position	Changes horizontal position without changing the aspect. -65 to 65 (0)
V Position	Changes vertical position without changing the aspect. -35 to 35 (0)
Safety Zone Marker 1, 2	<p>There are two types of safety zone marker: 1 and 2, which share the same settings. A safety zone marker is used to set the safe zone of the image (actual displayed area) to check the image.</p>  <p> Note</p> <ul style="list-style-type: none"> • In the case of SDI signal, setting is disabled when "H Delay" or "V Delay" is "On". • Safety zone marker is not displayed in the following cases: <ul style="list-style-type: none"> - When there is no signal, unsupported signal, or a channel with "Input Configuration" not set is selected - When an enlarged image is displayed - During the execution of "Playback File" under "Screen Capture" - When "H Delay"/"V Delay" is "On" - When a "Test Pattern" is displayed - When "Peaking 1" or "Peaking 2" is selected
Enable	Switches the safety zone marker On, Off. On, Off
Aspect Ratio	Sets the aspect ratio of the safety zone marker. 16:9, 15:9, 14:9, 13:9, 4:3, 2.39:1, 2.35:1, 1.896:1, 1.85:1, 1.66:1, Variable The aspect ratio can be entered as a numeric value when you select "Variable" (0.01:1 increments). The grayed out slider becomes active and can be used to set the aspect ratio. 1.00:1 to 3.00:1 (1.78:1) <p> Note</p> <ul style="list-style-type: none"> • When "Area Size" is set to "Variable (dot)", you cannot select "Aspect Ratio".



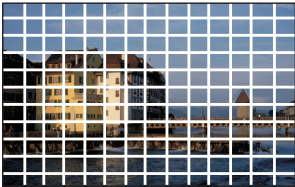































Item	Setting Options (underline indicates factory default)
Area Size	Sets the safety zone marker area size. 80%, 88%, 90%, 93%, Variable (%), Variable (dot) When "Variable (%)" is selected, the grayed out "Rate (%)" becomes active. When "Variable (dot)" is selected, the grayed out "Width (dot)" and "Height (dot)" become active. This can be set by moving the slider.
Rate (%)	Becomes active when you select "Variable (%)" under the menu "Area Size". Move the slider to set the displayed marker area size without changing the aspect ratio in 1 % increments. 50 to 100 (80)
Width (dot)	Becomes active when you select "Variable (dot)" under the menu "Area Size". Move the slider to set the area width in 2 dot increment. 360 to 4096 (3276)
Height (dot)	Becomes active when you select "Variable (dot)" under the menu "Area Size". Move the slider to set the area height in 2 dot increment. 240 to 2560 (1728)
Shape	Sets the area shape of the safety zone marker. Box:  Brackets:  Enclosure: 
Line Width	Sets the width of the safety zone marker line. Thick, Normal, Thin
Line Color	Sets the color of the safety zone marker line. White, Red, Green, Blue, Yellow, Cyan, Magenta
Line Brightness	Sets the brightness of the safety zone marker line. High, Low
H Position	Adjusts the marker horizontal position with the set aspect and size. -65 to 65 (0)
V Position	Adjusts the marker vertical position with the set aspect and size. -35 to 35 (0)



Item	Setting Options (underline indicates factory default)
Area Marker	<p>"Area Marker" is used to check a specific area using a rectangular box.</p>  <p> Note</p> <ul style="list-style-type: none"> • In the case of SDI signal, setting is disabled when "H Delay" or "V Delay" is "On". • "Area Marker" is not displayed in the following cases: <ul style="list-style-type: none"> - When there is no signal, unsupported signal, or a channel with "Input Configuration" not set is selected - When an enlarged image is displayed - During the execution of "Playback File" under "Screen Capture" - When "H Delay"/"V Delay" is "On" - When a "Test Pattern" is displayed - When "Peaking 1" or "Peaking 2" is selected
Enable	Switches the area marker On, Off. On, <u>Off</u>
H Position	Sets the start position (x-coordinate) to draw the rectangle (in increments of 2). 0 to 4086 (<u>240</u>)
V Position	Sets the start position (y-coordinate) to draw the rectangle (in increments of 2). 0 to 2550 (<u>120</u>)
Width (dot)	Sets the width of the rectangle (in increments of 2). 10 to 4096 (<u>240</u>)
Height (dot)	Sets the height of the rectangle (in increments of 2). 10 to 2560 (<u>120</u>)
Mask	Switches the mask color (in the marker). Black, Half, <u>Off</u> <p> Note</p> <ul style="list-style-type: none"> • Because the Wave Form Monitor, Vector Scope and Time Code appear under the Mask, a part of them is hidden by the Mask.
Line	Turns On/Off the outlines of the rectangular box. On, <u>Off</u>
Line Width	Sets the width of the area marker line. Thick, <u>Normal</u>, Thin
Line Color	Sets the color of the area marker line. <u>White</u>, Red, Green, Blue, Yellow, Cyan, Magenta
Line Brightness	Sets the brightness of the area marker line. High, <u>Low</u>

Item	Setting Options (underline indicates factory default)										
Center Marker	<p>The center marker shows the center of the image.</p>  <p> Note</p> <ul style="list-style-type: none"> • "Center Marker" cannot be displayed when a zoomed image is displayed. • "Center Marker" cannot be displayed when "Peaking 1" or "Peaking 2" is selected. <table border="1" data-bbox="231 577 1481 958"> <tr> <td data-bbox="231 577 384 656">Enable</td> <td data-bbox="384 577 1481 656">Switches the center marker On, Off. On, <u>Off</u></td> </tr> <tr> <td data-bbox="231 656 384 734">Size</td> <td data-bbox="384 656 1481 734">Sets the size of the center marker. Large, <u>Small</u></td> </tr> <tr> <td data-bbox="231 734 384 813">Line Width</td> <td data-bbox="384 734 1481 813">Sets the width of the center marker line. Thick, <u>Normal</u>, Thin</td> </tr> <tr> <td data-bbox="231 813 384 891">Line Color</td> <td data-bbox="384 813 1481 891">Sets the color of the center marker line. <u>White</u>, Red, Green, Blue, Yellow, Cyan, Magenta</td> </tr> <tr> <td data-bbox="231 891 384 958">Line Brightness</td> <td data-bbox="384 891 1481 958">Sets the brightness of the center marker line. High, <u>Low</u></td> </tr> </table>	Enable	Switches the center marker On, Off. On, <u>Off</u>	Size	Sets the size of the center marker. Large, <u>Small</u>	Line Width	Sets the width of the center marker line. Thick, <u>Normal</u>, Thin	Line Color	Sets the color of the center marker line. <u>White</u>, Red, Green, Blue, Yellow, Cyan, Magenta	Line Brightness	Sets the brightness of the center marker line. High, <u>Low</u>
Enable	Switches the center marker On, Off. On, <u>Off</u>										
Size	Sets the size of the center marker. Large, <u>Small</u>										
Line Width	Sets the width of the center marker line. Thick, <u>Normal</u>, Thin										
Line Color	Sets the color of the center marker line. <u>White</u>, Red, Green, Blue, Yellow, Cyan, Magenta										
Line Brightness	Sets the brightness of the center marker line. High, <u>Low</u>										
Grid Marker	<p>Grid markers are markers used to check the horizontal and vertical position.</p>  <p> Note</p> <ul style="list-style-type: none"> • "Grid Marker" cannot be displayed when a zoomed image is displayed. • "Grid Marker" cannot be displayed when "Peaking 1" or "Peaking 2" is selected. <table border="1" data-bbox="231 1384 1481 1769"> <tr> <td data-bbox="231 1384 384 1462">Enable</td> <td data-bbox="384 1384 1481 1462">Switches the grid marker On, Off. On, <u>Off</u></td> </tr> <tr> <td data-bbox="231 1462 384 1541">Distance</td> <td data-bbox="384 1462 1481 1541">Sets the horizontal and vertical line distance. <u>160 dots</u>, 240 dots, 320 dots</td> </tr> <tr> <td data-bbox="231 1541 384 1619">Line Width</td> <td data-bbox="384 1541 1481 1619">Sets the width of the grid marker line. Thick, <u>Normal</u>, Thin</td> </tr> <tr> <td data-bbox="231 1619 384 1697">Line Color</td> <td data-bbox="384 1619 1481 1697">Sets the color of the grid marker line. <u>White</u>, Red, Green, Blue, Yellow, Cyan, Magenta</td> </tr> <tr> <td data-bbox="231 1697 384 1769">Line Brightness</td> <td data-bbox="384 1697 1481 1769">Sets the brightness of the grid marker line. High, <u>Low</u></td> </tr> </table>	Enable	Switches the grid marker On, Off. On, <u>Off</u>	Distance	Sets the horizontal and vertical line distance. <u>160 dots</u>, 240 dots, 320 dots	Line Width	Sets the width of the grid marker line. Thick, <u>Normal</u>, Thin	Line Color	Sets the color of the grid marker line. <u>White</u>, Red, Green, Blue, Yellow, Cyan, Magenta	Line Brightness	Sets the brightness of the grid marker line. High, <u>Low</u>
Enable	Switches the grid marker On, Off. On, <u>Off</u>										
Distance	Sets the horizontal and vertical line distance. <u>160 dots</u>, 240 dots, 320 dots										
Line Width	Sets the width of the grid marker line. Thick, <u>Normal</u>, Thin										
Line Color	Sets the color of the grid marker line. <u>White</u>, Red, Green, Blue, Yellow, Cyan, Magenta										
Line Brightness	Sets the brightness of the grid marker line. High, <u>Low</u>										

Function Settings



This menu is used to display, define and apply various functions.

Item	Setting Options (underline indicates factory default)																																	
Peaking	<p>Customizes peakings which are assigned to Peaking 1 or Peaking 2. The outline is displayed in a color, used to check the focus.</p> <p> Note</p> <ul style="list-style-type: none"> • "Peaking" cannot be displayed during the execution of "Playback File" under "Screen Capture". • In the case of SDI signal, setting is disabled when "H Delay" or "V Delay" is "On". 																																	
Enable	<p>Switches the peaking display mode and also sets peaking to Off.</p> <p>Peaking 1, Peaking 2, <u>Off</u></p> <p>Configures detailed settings for "Peaking 1" or "Peaking 2".</p> <p>Monochrome: Displays video in monochrome.</p> <p><u>On, Off</u></p> <p>Frequency: Sets the central frequency of contour enhancement signals.</p> <p>Peaking 1 (Low, <u>Middle, High</u>), Peaking 2 (Low, <u>Middle, High</u>)</p> <p>Range: Sets the width of the range to be colored.</p> <p>-3 ~ +3 (<u>0</u>)</p> <p>Color: Sets the color to be used.</p> <p><u>White, Red, Green, Blue, Yellow, Cyan, Magenta</u></p>																																	
False Color	<p>When set to "On", different colors are displayed according to video's brightness level so that you can check the exposure condition easily.</p> <p><u>On, Off</u></p> <p>Below are details of the chart. Numbers indicate the level of Y-signals.</p> <table border="1" data-bbox="421 1048 884 1429"> <tr><td>941 ~ 1023</td><td></td><td>Red</td></tr> <tr><td>877 ~ 940</td><td></td><td>Orange</td></tr> <tr><td>813 ~ 876</td><td></td><td>Light orange</td></tr> <tr><td>749 ~ 812</td><td></td><td>Yellow</td></tr> <tr><td>584 ~ 748</td><td></td><td>Light gray</td></tr> <tr><td>420 ~ 583</td><td></td><td>Medium gray</td></tr> <tr><td>256 ~ 419</td><td></td><td>Dark gray</td></tr> <tr><td>192 ~ 255</td><td></td><td>Blue</td></tr> <tr><td>128 ~ 191</td><td></td><td>Blue purple</td></tr> <tr><td>64 ~ 127</td><td></td><td>Light purple</td></tr> <tr><td>0 ~ 63</td><td></td><td>Purple</td></tr> </table> <p> Note</p> <ul style="list-style-type: none"> • "False Color" cannot be displayed during the execution of "Playback File" under "Screen Capture". • In the case of SDI signal, setting is disabled when "H Delay" or "V Delay" is "On". 	941 ~ 1023		Red	877 ~ 940		Orange	813 ~ 876		Light orange	749 ~ 812		Yellow	584 ~ 748		Light gray	420 ~ 583		Medium gray	256 ~ 419		Dark gray	192 ~ 255		Blue	128 ~ 191		Blue purple	64 ~ 127		Light purple	0 ~ 63		Purple
941 ~ 1023		Red																																
877 ~ 940		Orange																																
813 ~ 876		Light orange																																
749 ~ 812		Yellow																																
584 ~ 748		Light gray																																
420 ~ 583		Medium gray																																
256 ~ 419		Dark gray																																
192 ~ 255		Blue																																
128 ~ 191		Blue purple																																
64 ~ 127		Light purple																																
0 ~ 63		Purple																																
Screen Capture	<p>Captures the screen.</p> <table border="1" data-bbox="240 1675 1477 1957"> <tr> <td data-bbox="240 1675 411 1749">Capture</td> <td data-bbox="416 1675 1477 1749">Captures the screen. The data is saved under the name "YYYYMMDD_hhmmss.bmp" in the root folder of the USB memory.</td> </tr> <tr> <td data-bbox="240 1756 411 1830">Frame Hold</td> <td data-bbox="416 1756 1477 1830">Pauses the video. <u>On, Off</u></td> </tr> <tr> <td data-bbox="240 1836 411 1957">Capture Source</td> <td data-bbox="416 1836 1477 1957">Selects the sources to capture. All: Everything is captured including video assistance functions such as markers and wave form monitor as well as OSD menu. Video: Only video signals are captured.</td> </tr> </table>	Capture	Captures the screen. The data is saved under the name "YYYYMMDD_hhmmss.bmp" in the root folder of the USB memory.	Frame Hold	Pauses the video. <u>On, Off</u>	Capture Source	Selects the sources to capture. All: Everything is captured including video assistance functions such as markers and wave form monitor as well as OSD menu. Video: Only video signals are captured.																											
Capture	Captures the screen. The data is saved under the name "YYYYMMDD_hhmmss.bmp" in the root folder of the USB memory.																																	
Frame Hold	Pauses the video. <u>On, Off</u>																																	
Capture Source	Selects the sources to capture. All: Everything is captured including video assistance functions such as markers and wave form monitor as well as OSD menu. Video: Only video signals are captured.																																	

Item	Setting Options (underline indicates factory default)
Playback File	Plays back captured images. Select File: Selects a file. Execute: Plays back the image.  Note <ul style="list-style-type: none"> When playing back captured images on other DP-V3010 or PC, color may not be played back precisely.
Finish Playback File	Finishes playback.
Time Code	Display the time code superimposed on the SDI signal.   Note <ul style="list-style-type: none"> "Time Code" is not displayed in the following cases: <ul style="list-style-type: none"> - When an enlarged image is displayed - When "Frame Hold" is set to "On" - When "Peaking 1" or "Peaking 2" is selected - During the execution of "Playback File" under "Screen Capture" - When a "Test Pattern" is displayed
Enable	Switches the time code display On, Off. <u>On, Off</u>
Type	Selects the type. <u>VITC, LTC</u>
Size	Selects the size. <u>Large, Small</u>
Position	Selects the display position. <u>Top Left, Top Right, Bottom Left, Bottom Right</u>







Item	Setting Options (<u>underline indicates factory default</u>)
Wave Form Monitor	<p>Wave Form Monitor is displayed for SDI signals. On the wave form monitor, the horizontal axis shows the horizontal resolution of the video and the vertical line shows the signal level.</p> <div data-bbox="635 255 1241 573" data-label="Figure"> <p>The figure is a line graph with a grid. The vertical axis is labeled 'Signal level' and 'IRE' with values -4%, 0%, 50%, and 100%. The horizontal axis is labeled 'Horizontal resolution of video' and '0' to '255'. A jagged line represents the signal level across the horizontal axis.</p> </div> <p>Note</p> <ul style="list-style-type: none"> • "Wave Form Monitor" is not displayed in the following cases: <ul style="list-style-type: none"> - When "Frame Hold" or "False Color" is "On" - When "Peaking 1" or "Peaking 2" is selected - During the execution of "Playback File" under "Screen Capture" - When a "Test Pattern" is displayed - When "H Delay"/"V Delay" is "On" • When "Wave Form Monitor" is "On", "Vector Scope" is "Off".
Enable	Switches the wave form monitor On, Off. On, Off
Select Signal	Sets the wave form to be displayed. Y, Cb, Cr, R, G, B
Display Type	Sets the display type. When "Line" is selected, data for one line is displayed. All, Line Selects the line to be displayed when "Line" is selected. Select Line: 1 to 2160
Position	Selects the display position. Bottom Left, Bottom Right
Scale	Sets the scale of the wave form monitor. Automatic : Sets the scale of the wave form monitor according to the Gamma setting. IRE, Canon Log, Canon Log 2, Canon Log 3, SMPTE ST 2084 : Select the scale.
Guide	A guide is displayed at the specified position. "Guide" is not displayed when "255" is selected. 1 to 255
Standard Level High	Sets the standard display level (high). "Standard Level High" is not displayed when "255" is selected. 190 to 255
Standard Level Low	Sets the standard display level (low). "Standard Level Low" is not displayed when "0" is selected. 0 to 64

Item	Setting Options (<u>underline indicates factory default</u>)						
Color	<p>Sets the signals to be displayed and the color of signals exceeding the standard level. Y, Cb, Cr, R, G, B: Selects the signal. Selects the color of the selected signal. White, Red, Green, Blue, Yellow, Cyan, Magenta Default value of each signal is shown below. Y (<u>White</u>), Cb (<u>White</u>), Cr (<u>White</u>), R (<u>Red</u>), G (<u>Green</u>), B (<u>Blue</u>) Standard Level High, Standard Level Low: Selects the standard level. White, Red, Green, Blue, Yellow, Cyan, Magenta Default value of each standard level is shown below. Standard Level High (<u>Magenta</u>), Standard Level Low (<u>Cyan</u>)</p>						
Vector Scope	<p>Vector Scope is displayed for SDI signals. Vector scope displays the intensity of color signals and hue with the horizontal axis showing the color difference signal Cb and the vertical line showing Cr.</p> <div data-bbox="635 577 1169 958" data-label="Figure"> </div> <p>Note</p> <ul style="list-style-type: none"> • "Vector Scope" is not displayed in the following cases: <ul style="list-style-type: none"> - When "Frame Hold" or "False Color" is "On" - When "Peaking 1" or "Peaking 2" is selected - During the execution of "Playback File" under "Screen Capture" - When a "Test Pattern" is displayed - When "H Delay"/"V Delay" is "On" • When "Vector Scope" is "On", "Wave Form Monitor" is "Off". <table border="1" data-bbox="240 1323 1477 1552"> <tr> <td data-bbox="240 1323 411 1402">Enable</td> <td data-bbox="411 1323 1477 1402">Switches the vector scope On, Off. On, Off</td> </tr> <tr> <td data-bbox="240 1402 411 1480">Target</td> <td data-bbox="411 1402 1477 1480">Sets the target. 75%, 100%</td> </tr> <tr> <td data-bbox="240 1480 411 1552">Position</td> <td data-bbox="411 1480 1477 1552">Selects the display position. Bottom Left, Bottom Right</td> </tr> </table>	Enable	Switches the vector scope On, Off. On, Off	Target	Sets the target. 75%, 100%	Position	Selects the display position. Bottom Left, Bottom Right
Enable	Switches the vector scope On, Off. On, Off						
Target	Sets the target. 75%, 100%						
Position	Selects the display position. Bottom Left, Bottom Right						

Item	Setting Options (underline indicates factory default)
Test Pattern	<p>Sets the test pattern built into the main unit. White, Gray (20%), Black, Red, Green, Blue, Ramp, 5 Step, Color Bars, PLUGE, <u>Off</u></p> <p> Note</p> <ul style="list-style-type: none"> • If the power is turned off once and then back on, the test pattern will not be displayed. • The test pattern will be erased in the following cases: <ul style="list-style-type: none"> - When calibration has been started - When the channel is changed using the CH button, F button assigned for Channel UP/ Channel DOWN, or "Select Channel" under "Channel Settings" - When changing "Input Configuration" or "Select Input Signal" under "Channel Settings" - When "Reset All Settings" is executed
Various Function	<p>Displays the function list to execute functions. Monochrome (On, <u>Off</u>), Blue Only (On, <u>Off</u>), Red Off (On, <u>Off</u>), Green Off (On, <u>Off</u>), Blue Off (On, <u>Off</u>), H Delay (On, <u>Off</u>), V Delay (On, <u>Off</u>), Banner (On, <u>Off</u>)^{*1}, Function Guide (On, <u>Off</u>)^{*2}, OSD Position (<u>Mode 1 (4096x2560)</u>, Mode 2 (3840x2160))^{*3}, OSD Size (<u>Large</u>, Small)^{*4}, Black Level Control (On, <u>Off</u>)^{*5}, Backlight Scan (High, Low, <u>Off</u>)</p> <p>^{*1} Banner When "Banner" is set to "Off", the banner is displayed only when you press the SET button while OSD menu is closed.</p> <p>^{*2} Function Guide <u>On</u>: You can display the list of functions assigned to an F button on the video display by pressing the SET button while OSD menu is closed. <u>Off</u>: Function guide is not displayed.</p> <p>^{*3} OSD Position <u>Mode 1 (4096x2560)</u>: OSD is displayed in a 4096x2560 area. <u>Mode 2 (3840x2160)</u>: OSD is displayed in a 3840x2160 area.</p> <p>^{*4} OSD Size: The size of the OSD menu can be selected from "Large" and "Small".</p> <p>^{*5} Black Level Control: Adjust the black level of dark portions of the image when "Backlight Control" is set to "Local Dimming".</p> <p> Note</p> <ul style="list-style-type: none"> • "H Delay" and "V Delay" can be used only for SDI signals. Setting is enabled only when "Peaking 1" or "Peaking 2" is selected and "False Color" is "Off". • When "H Delay" is "ON", the image display position can be adjusted using the display controller's ◀▶ for video in 1280x720 / 24.00P, 25.00P, 30.00P format. Adjust with the menu screen closed. • When checking the blanking area using "H Delay"/"V Delay", an audio signal check can be performed, however some data is not displayed. • When "CDL/User LUT" is set to "User LUT", "Blue Only" cannot be selected.

System Settings

This menu is used to set the settings related to the main unit and display controller system.

Item	Setting Options (underline indicates factory default)
Network	<p>Sets the main unit and display controller network settings.</p> <p> Note</p> <ul style="list-style-type: none"> Setting is disabled when "Power on Setting" is set to "User 1-3".
Configure an IP Address	<p>Automatic: Configures an IP address automatically with DHCP/Automatic IP. Manual: Configure an IP address and subnet mask manually.</p>
Display	192.168.0.1
Display Controller	192.168.0.10
Subnet Mask	255.255.255.0
Language	<p>Sets the language of the OSD menu and messages.</p> <p>English, 日本語, 簡体中文</p>
Function/Channel Button	<p>Sets the function or channel to assign to the F buttons or CH button.</p>
Display Function	<p>Sets the function to assign to the F buttons of the main unit. Select an F button and assign a function from the list ( 69). The factory defaults for the main unit F buttons is as follow:</p> <p>F1 : Channel UP F2 : Channel DOWN F3 : Time Code F4 : Aspect Marker</p> <p> Note</p> <ul style="list-style-type: none"> When changing channels with "Channel UP/DOWN", the channels with "Input Configuration" ( 51) set to "-" are skipped. "Hide OSD" is a function to hide all OSD. When "On" is selected, OSD and "Background Color" are hidden but the menu can be used.
Controller Function	<p>Sets the function to assign to the F button on the display controller. Select an F button and assign a function from the list ( 69). The factory defaults for the display controller F buttons is as follow:</p> <p>F1 : H Delay F2 : V Delay F3 : Monochrome F4 : Blue Only F5 : Red Off F6 : Green Off F7 : Blue Off F8 : Screen Scaling F9 : Backlight Scan F10 : Knob Lock</p> <p> Note</p> <ul style="list-style-type: none"> When changing channels with "Channel UP/DOWN", the channels with "Input Configuration" ( 51) set to "-" are skipped. "Hide OSD" is a function to hide all OSD. When "On" is selected, OSD and "Background Color" are hidden but the menu can be used.

Item		Setting Options (<u>underline indicates factory default</u>)
Controller Channel	Channel	Sets the channel to assign to the CH button on the display controller. Select a CH button and register a channel number. A list of settings under the menu "Channel Settings" (📖 51) is displayed.
Display Name		Sets the name of the main unit. You can input up to 16 alphanumeric characters.
Date/Time		Sets the year/month/date/hour/minute.
Power Indicator Brightness		Adjusts the brightness of the power indicator on the main unit. 5 is the brightest. Off, 1 to 5 (2)
Compatible Settings		Sets the version of ACESproxy. 0.7, 1.0
ACES		
Firmware Update		This function is used to update the video display firmware. Refer to the Canon website for detailed information.
Protect Settings		Locks the settings so they cannot be changed. When you press the MENU button, "Signal/System Information" appears, but other operations are grayed out because they are locked. <ul style="list-style-type: none"> Unlocking Protect Settings Move the selection frame to "Protect" and press the SET button for approximately 3 seconds. When a password has been set, enter the password and select "OK".
Password		Set a password to protect settings. Use a four-digit number (0000 to 9999). The initial password is blank.
Protect Target		You can remove Picture Mode and Select Channel from the items to be protected. Picture Mode: Select "On" to protect or "Off" to exclude settings for "Picture Mode". On, Off Select Channel: Select "On" to protect or "Off" to exclude settings for "Select Channel". On, Off
Protect		Select "OK" to protect. When a password has been set, enter the password and select "OK".
Controller Settings		Configures settings for the display controller.
Knob Lock		Locks the SHARPNESS, CHROMA, BRIGHTNESS, and CONTRAST knobs and RESET buttons on the display controller when the OSD menu is closed (also applied when CDL is selected). Also set using the F10 button on the display controller (📖 66). On, Off
Display List		Displays the list of displays registered to the display controller. You can delete displays or change their listed order when two or more displays are recognized. Delete: Delete the registered displays. Switch: Change F button (F1 to F10) that registered the display.

Item	Setting Options (<u>underline indicates factory default</u>)								
Export/Import	<p>Sets the export/import main menu settings.</p> <p> Note</p> <ul style="list-style-type: none"> The following settings cannot be exported or imported. <table border="1" data-bbox="483 349 1469 539"> <tr> <td>Adjustment</td> <td>Target values of Calibration (including calibration results)</td> </tr> <tr> <td>Display Settings</td> <td>Zoom, Frame Hold</td> </tr> <tr> <td>Function Settings</td> <td>Test Pattern, Various Function (Monochrome, Blue Only, Red Off, Green Off, Blue Off, H Delay, V Delay)</td> </tr> <tr> <td>System Settings</td> <td>Date/Time, Export/Import, Power on Setting</td> </tr> </table> <ul style="list-style-type: none"> User LUT data cannot be exported or imported to "User 1 to 3" under "Target". Data exported from this product may not be imported to products of which firmware version is earlier than the version of this product. To import data, update the firmware to the latest version. 	Adjustment	Target values of Calibration (including calibration results)	Display Settings	Zoom, Frame Hold	Function Settings	Test Pattern, Various Function (Monochrome, Blue Only, Red Off, Green Off, Blue Off, H Delay, V Delay)	System Settings	Date/Time, Export/Import, Power on Setting
Adjustment	Target values of Calibration (including calibration results)								
Display Settings	Zoom, Frame Hold								
Function Settings	Test Pattern, Various Function (Monochrome, Blue Only, Red Off, Green Off, Blue Off, H Delay, V Delay)								
System Settings	Date/Time, Export/Import, Power on Setting								
Export	<p>Target: Select the export destination.</p> <p>USB: Export to a USB memory.</p> <p>User 1-3: Export to the built-in memory of the main unit.</p> <p>Filename: Factory default is "dinfo.dat". You can change the name of the file to be exported to the USB memory within 16 one-byte characters including alphabetical characters, numbers, and symbols.</p> <p>Execute: Performs export.</p>								
Import	<p>Target: Specify the destination to save the file to be imported.</p> <p>USB, User 1-3</p> <p>Filename: Displays files with the extension ".dat" so you can select from among them.</p> <p>Settings (All, Adjustment, Channel Settings, Display Settings, Marker Settings, Function Settings, System Settings): Select the settings to import.</p> <p>Execute: Performs import.</p>								
Power on Setting	<p>You can select the state of the display when the power is turned on.</p> <p>Last memory: The video display starts up with the settings last used.</p> <p>User 1-3: It starts up with the settings saved in "User 1-3" under "Export".</p>								
Reset All Settings	<p>Returns all settings to factory default. When selected, the message "Reset all settings to factory defaults?" appears.</p> <p>OK: Performs reset.</p> <p>Cancel: Returns to the previous screen without resetting.</p>								

The following functions can also be assigned to an F button of the main unit or display controller (66).

Item	Options
Adjustment	Picture Mode
	Backlight Control
	Gamma
	HDR
	HDR Range
	Gain
	Bias
	xy
	Picture Mode
EBU	
ITU-R BT.709	
ITU-R BT.2020	
Adobe RGB	
DCI-P3	
User 1 to User 7	
Canon Log	
ACESproxy	
Color Gamut	SMPTE-C
	EBU
	ITU-R BT.709
	ITU-R BT.2020
	Adobe RGB
	DCI-P3
	Native
	Cinema Gamut to 709
	Cinema Gamut to 2020
	Cinema Gamut to DCI
	DCI-P3+ to 709
	DCI-P3+ to DCI
	DCI-P3 to 709
	ITU-R BT.2020 to 709
	ACESproxy
Gamut LUT 1 to Gamut LUT 8	
Gamma	2.2
	2.35
	2.4
	2.6
	ITU-R BT.1886
	Canon Log
	Canon Log (HDR)
	Canon Log 2
	Canon Log 2 (HDR)
	Canon Log 3
	Canon Log 3 (HDR)
	SMPTE ST 2084
	Hybrid Log-Gamma Y
	Hybrid Log-Gamma RGB
	Gamma LUT 1 to Gamma LUT 8

Item	Options
CDL	CDL Preset
	User LUT
	CDL/User LUT Bypass
	CDL Export/Import
	CDL Save to Memory
	CDL Load from Memory
	Channel Settings
Channel DOWN	
Select Input Signal	
CH1 to CH20	
Display Settings	Screen Scaling
	Zoom
	Scaling Method
	Frame Hold
	Background Color
Marker Settings	Marker Preset
	Aspect Marker
	Safety Zone Marker 1
	Safety Zone Marker 2
	Area Marker
	Center Marker
	Grid Marker
Function Settings	Peaking
	Peaking 1
	Peaking 2
	False Color
	Capture
	Time Code
	WFM/VEC
	Wave Form Monitor
	WFM Select Signal
	Vector Scope
	Monochrome
	Blue Only
	Red Off
	Green Off
	Blue Off
H Delay	
V Delay	
Backlight Scan	
System Settings	Hide OSD
	Knob Lock

Signal Information

Shows the signal information. When "Select Input Signal" is "4K Input", information for the entire signal and each input is displayed. Select a signal with the SET or ◀▶ buttons according to the guide at top right corner of the menu. When signal information has been obtained although it is not displayed on the screen, the content of the information is grayed out.

SDI Signal		DisplayPort Signal	
Item	Display Example	Item	Display Example
Channel	CH1	Channel	CH4
Input Configuration	3G/HD-SDI 1 (3G Level A)	Input Configuration	DisplayPort
Select Input Signal	Automatic	Select Input Signal	Automatic
Format	Automatic	Format	Automatic
Resolution	4096x2160	Resolution	4096x2560
Picture Rate, I/P/PsF*	24.00P	Horizontal Frequency	79.57 kHz
SDI Payload ID	89 C3 46 01	Vertical Frequency	59.96 Hz
Video Standard	3G-SDI	Pixel Encoding	4:4:4 RGB
Sampling Structure	4:4:4:4 GBRA	Color Depth	10-bit
Bit Depth	10-bit	Matrix	sRGB
Picture Rate	24.00	RGB Range	Full
Scanning Method	Progressive/Progressive (Transport/Picture)		
Link Number	Single/Link_1		

* When a content is grayed out, an asterisk "*" may be displayed indicating low "Picture Rate" accuracy such as "24.00P *".

System Information

Shows the video display status and network information.

Item	Display Example
Display	DP-V3010
Serial No.	000000000000
Firmware Ver.	1.3
Usage Time*	5 h
IP Address	192.168.0.1
Subnet Mask	255.255.255.0
MAC Address	FF:FF:FF:FF:FF:FF
Display Controller	CL-01
Serial No.	00000000
Firmware Ver.	4.0.0
IP Address	192.168.0.10
Subnet Mask	255.255.255.0
MAC Address	FF:FF:FF:FF:FF:FF

* The "Usage Time" is not always "0" when you purchase the display due to factory inspection.

Main specifications/Performance

Main Unit

Panel		
Panel Type	IPS LCD panel	
Screen Size	30 inch (76.1 cm)	
Aspect Ratio	16:10	
Resolution	4096x2560 (10.5 megapixels)	
Active Display Area	Approximately 645.1 x 403.2 mm	
Pixel Pitch	157.5 μ m	
Panel Driver	1024 gradations, 10-bit for each RGB color	
Image quality		
Brightness (Standard)	48 cd/m ² (DCI-P3), 100 cd/m ²	
View Angle (Up, Down, Left, Right)	89° (contrast ratio 10 : 1 or higher)	
Surface Treatment	Low-Reflection Glare	
General		
Backlight Type	RGB LED, direct down type	
Power	Rated Voltage: 100 – 240 V AC Rated Frequency: 50/60 Hz	
Power consumption	At maximum load (including change in brightness through aging): Approximately 370 W At factory shipment: Approximately 130 W	
Environmental Conditions	Operating	Temperature and humidity: 5 – 35 °C (41 – 95 °F), 20 – 80 %RH (no condensation) recommended: 15 – 30 °C (59 – 86 °F) Pressure: 700 – 1060 hPa
	Storage/ Transporting	Temperature and humidity: -20 – 40 °C (-4 – 104 °F), 10 – 85 %RH (no condensation) 41 – 60 °C (105 – 140 °F), 10 – 40 %RH (no condensation) Pressure: 700 – 1060 hPa
Dimensions (width x height x depth)	Approximately 708 x 474 x 189 mm (27.9 x 18.7 x 7.4 in.)	
Weight	Approximately 24 kg (52.8 lb)	
Mounting Hole Pitch	VESA standard 200 x 200 mm (7.9 x 7.9 in.)	
Interface		
Input	3G/HD-SDI	8 (2 systems) BNC (75 Ω) receptacle terminal 3G-SDI: SMPTE 2048-2/274M/296/372/425-1/428-19/428-9 compliant HD-SDI: SMPTE 2048-2/274M/292-1/296/428-19/428-9 compliant HD-SDI Dual: SMPTE 2048-2/274M/372/428-19/428-9 compliant
	DisplayPort	4 (1 system) DisplayPort terminal DisplayPort Standard Specification Ver.1.1a compliant
Output	3G/HD-SDI	8 (2 pass-thru systems)

Interface		
Control	USB	1 USB A receptacle port Universal Serial bus specification revision 2.0 compliant LS (Low Speed)/FS (Full Speed)/HS (High Speed) mode compatible Enhanced host controller interface specification revision 1.0 compliant
	LAN	1 RJ-45 terminal IEEE802.3 10BASE-TX / IEEE802.3u 100BASE-TX compliant

Display Controller

General		
Power		Rated Voltage: 100 – 240 V AC Rated Frequency: 50/60 Hz
Power consumption		At maximum load: Approximately 2 W At factory shipment: Approximately 2 W
Environmental Conditions	Operating	Temperature and humidity: 5 – 35 °C (41 – 95 °F), 20 – 80 %RH (no condensation)
	Storage/Transporting	Temperature and humidity: -20 – 40 °C (-4 – 104 °F), 10 – 85 %RH (no condensation) 41 – 60 °C (105 – 140 °F), 10 – 40 %RH (no condensation)
Dimensions (width x height x depth)		Approximately 419 x 56 x 88 mm (16.5 x 2.2 x 3.5 in.)
Weight		Approximately 460 g (16.2 oz)
Mounting Hole Pitch		EIA2U standard 76.2 x 465.9 mm (3.0 x 18.3 in.)
Interface		
Control	LAN	1 RJ-45 terminal

Weight and dimensions are approximate. Error and omissions excepted.

The information in this manual is verified as of May 2016. It is subject to change without notice.

Dimensions

■ Main Unit

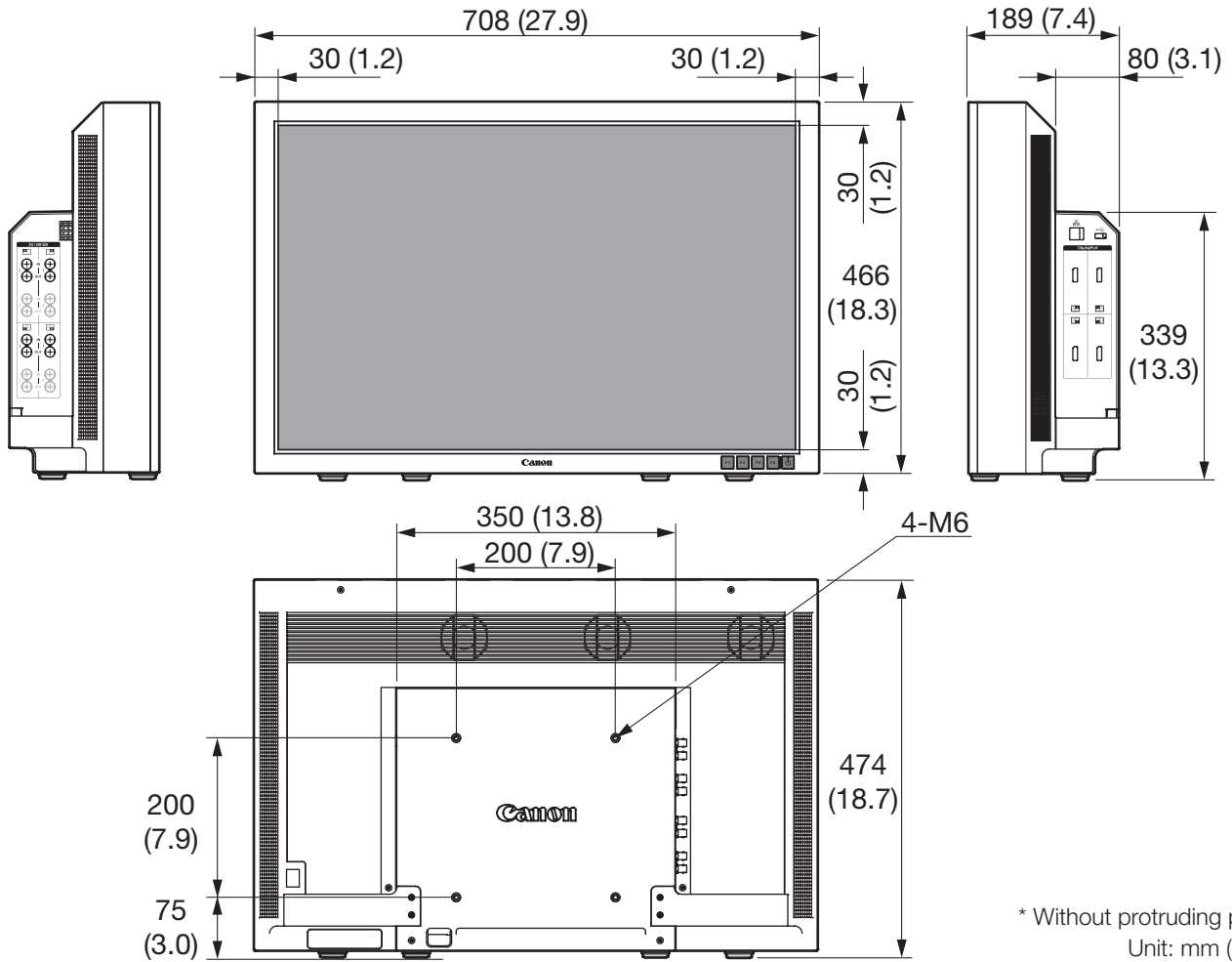

* Without protruding parts
Unit: mm (inch)

■ Display Controller

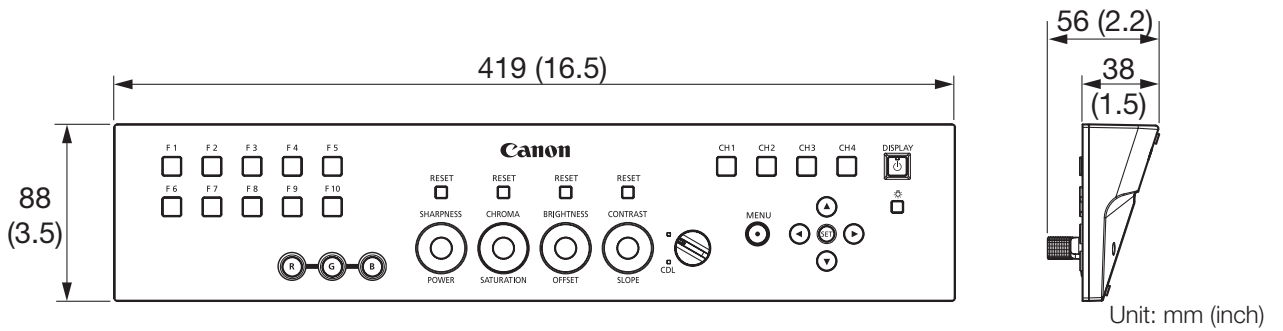

Unit: mm (inch)

■ Other accessories (Rack Mount Bracket RB-01)

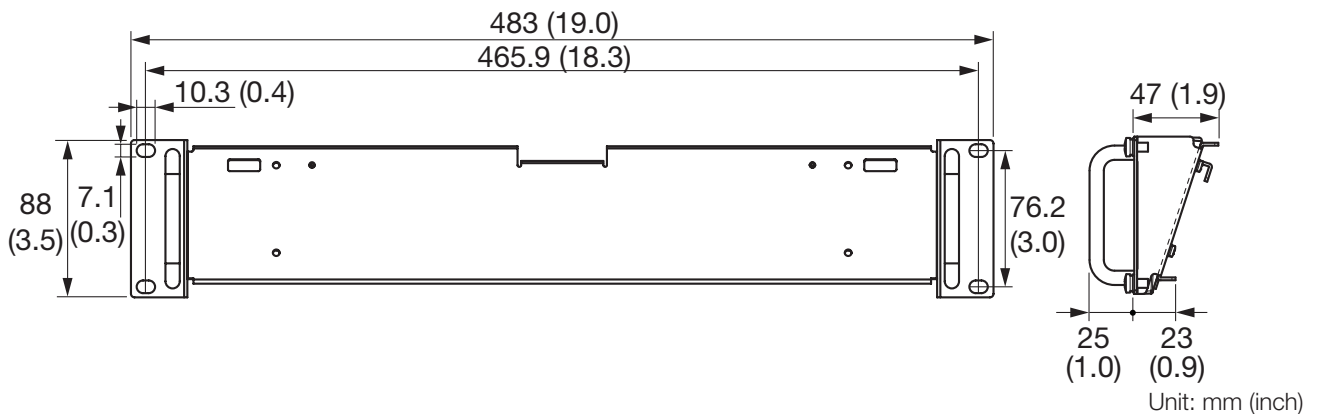

Unit: mm (inch)

Appendix

Supported Signal Format

■ SDI

Transmission method	Signal format	Color format	Color depth	Standards
HD-SDI x 1	1280x720P 59.94/60.00 Hz	4:2:2 YCbCr	10-bit	SMPTE 292-1 SMPTE 296
	1280x720P 50.00 Hz			
	1280x720P 29.97/30.00 Hz			
	1280x720P 25.00 Hz			
	1280x720P 23.98/24.00 Hz			
	1920x1080i 59.94/60.00 Hz			
	1920x1080i 50.00 Hz			
	1920x1080P 29.97/30.00 Hz			
	1920x1080PsF 29.97/30.00 Hz			
	1920x1080P 25.00 Hz			
	1920x1080PsF 25.00 Hz			
	1920x1080P 23.98/24.00 Hz			SMPTE 292-1 SMPTE 428-9 SMPTE 428-19 SMPTE 2048-2
	1920x1080PsF 23.98/24.00 Hz			
	2048x1080i 59.94/60.00 Hz			
	2048x1080i 50.00 Hz			
	2048x1080P 29.97/30.00 Hz			
	2048x1080PsF 29.97/30.00 Hz			
	2048x1080P 25.00 Hz			
	2048x1080PsF 25.00 Hz			
	2048x1080P 23.98/24.00 Hz			
2048x1080PsF 23.98/24.00 Hz				

Transmission method	Signal format	Color format	Color depth	Standards	
HD-SDI Dual x 1	1920x1080P 59.94/60.00 Hz	4:2:2 YCbCr	10-bit	SMPTE 372 SMPTE 274M	
	1920x1080i 59.94/60.00 Hz	4:4:4 RGB 4:4:4 YCbCr	12-bit/10-bit		
		4:2:2 YCbCr	12-bit		
	1920x1080P 50.00 Hz	4:2:2 YCbCr	10-bit		
	1920x1080i 50.00 Hz	4:4:4 RGB 4:4:4 YCbCr	12-bit/10-bit		
		4:2:2 YCbCr	12-bit		
	1920x1080P 29.97/30.00 Hz	4:4:4 RGB 4:4:4 YCbCr	12-bit/10-bit		
		4:2:2 YCbCr	12-bit		
	1920x1080PsF 29.97/30.00 Hz	4:4:4 RGB 4:4:4 YCbCr	12-bit/10-bit		
		4:2:2 YCbCr	12-bit		
	1920x1080P 25.00 Hz	4:4:4 RGB 4:4:4 YCbCr	12-bit/10-bit		
		4:2:2 YCbCr	12-bit		
	1920x1080PsF 25.00 Hz	4:4:4 RGB 4:4:4 YCbCr	12-bit/10-bit		
		4:2:2 YCbCr	12-bit		
	1920x1080P 23.98/24.00 Hz	4:4:4 RGB 4:4:4 YCbCr	12-bit/10-bit		
		4:2:2 YCbCr	12-bit		
	1920x1080PsF 23.98/24.00 Hz	4:4:4 RGB 4:4:4 YCbCr	12-bit/10-bit		
		4:2:2 YCbCr	12-bit		
	2048x1080P 59.94/60.00 Hz	4:2:2 YCbCr	10-bit	SMPTE 372 SMPTE 428-9 SMPTE 428-19 SMPTE 2048-2	
	2048x1080i 59.94/60.00 Hz	4:4:4 RGB 4:4:4 YCbCr	12-bit/10-bit		
4:4:4 X'Y'Z' 4:2:2 YCbCr		12-bit			
2048x1080P 50.00 Hz	4:2:2 YCbCr	10-bit	SMPTE 372 SMPTE 2048-2		
2048x1080i 50.00 Hz	4:4:4 RGB 4:4:4 YCbCr	12-bit/10-bit			
	4:4:4 X'Y'Z' 4:2:2 YCbCr	12-bit			
2048x1080P 47.95/48.00 Hz	4:2:2 YCbCr	10-bit	SMPTE 372 SMPTE 2048-2		

Transmission method	Signal format	Color format	Color depth	Standards
HD-SDI Dual x 1	2048x1080P 29.97/30.00 Hz	4:4:4 RGB	12-bit/10-bit	SMPTE 372 SMPTE 428-9
		4:4:4 X'Y'Z'	12-bit	SMPTE 428-19 SMPTE 2048-2
		4:4:4 YCbCr	12-bit/10-bit	SMPTE 372
		4:2:2 YCbCr	12-bit	SMPTE 2048-2
	2048x1080PsF 29.97/30.00 Hz	4:4:4 RGB	12-bit/10-bit	SMPTE 372 SMPTE 428-9
		4:4:4 X'Y'Z'	12-bit	SMPTE 428-19 SMPTE 2048-2
		4:4:4 YCbCr	12-bit/10-bit	SMPTE 372
		4:2:2 YCbCr	12-bit	SMPTE 2048-2
	2048x1080P 25.00 Hz	4:4:4 RGB	12-bit/10-bit	SMPTE 372 SMPTE 428-9
		4:4:4 X'Y'Z'	12-bit	SMPTE 428-19 SMPTE 2048-2
		4:4:4 YCbCr	12-bit/10-bit	SMPTE 372
		4:2:2 YCbCr	12-bit	SMPTE 2048-2
	2048x1080PsF 25.00 Hz	4:4:4 RGB	12-bit/10-bit	SMPTE 372 SMPTE 428-9
		4:4:4 X'Y'Z'	12-bit	SMPTE 428-19 SMPTE 2048-2
		4:4:4 YCbCr	12-bit/10-bit	SMPTE 372
		4:2:2 YCbCr	12-bit	SMPTE 2048-2
	2048x1080P 23.98/24.00 Hz	4:4:4 RGB	12-bit/10-bit	SMPTE 372 SMPTE 428-9
		4:4:4 X'Y'Z'	12-bit	SMPTE 428-19 SMPTE 2048-2
		4:4:4 YCbCr	12-bit/10-bit	SMPTE 372
		4:2:2 YCbCr	12-bit	SMPTE 2048-2
2048x1080PsF 23.98/24.00 Hz	4:4:4 RGB	12-bit/10-bit	SMPTE 372 SMPTE 428-9	
	4:4:4 X'Y'Z'	12-bit	SMPTE 428-19 SMPTE 2048-2	
	4:4:4 YCbCr	12-bit/10-bit	SMPTE 372	
	4:2:2 YCbCr	12-bit	SMPTE 2048-2	
3G-SDI Level A x 1	1280x720P 59.94/60.00 Hz	4:4:4 RGB	10-bit	SMPTE 425-1 SMPTE 296
	1280x720P 50.00 Hz	4:4:4 YCbCr		
	1280x720P 29.97/30.00 Hz			
	1280x720P 25.00 Hz			
	1280x720P 23.98/24.00 Hz			
	1920x1080P 59.94/60.00 Hz	4:2:2 YCbCr	10-bit	SMPTE 425-1 SMPTE 274M

Transmission method	Signal format	Color format	Color depth	Standards
3G-SDI Level A x 1	1920x1080i 59.94/60.00 Hz	4:4:4 RGB	12-bit/10-bit	SMPTE 425-1 SMPTE 274M
		4:4:4 YCbCr		
	1920x1080P 50.00 Hz	4:2:2 YCbCr	12-bit	
		4:2:2 YCbCr	10-bit	
	1920x1080i 50.00 Hz	4:4:4 RGB	12-bit/10-bit	
		4:4:4 YCbCr		
	1920x1080P 29.97/30.00 Hz	4:2:2 YCbCr	12-bit	
		4:4:4 RGB	12-bit/10-bit	
	1920x1080P 29.97/30.00 Hz	4:4:4 YCbCr		
		4:2:2 YCbCr	12-bit	
	1920x1080PsF 29.97/30.00 Hz	4:4:4 RGB	10-bit	
			12-bit	
		4:4:4 YCbCr	12-bit	
			10-bit	SMPTE 425-1 SMPTE 274M
	1920x1080P 25.00 Hz	4:2:2 YCbCr	12-bit	
		4:4:4 RGB	12-bit/10-bit	
	1920x1080PsF 25.00 Hz	4:4:4 YCbCr	12-bit	
			10-bit	
		4:4:4 RGB	10-bit	
			12-bit	
	1920x1080P 23.98/24.00 Hz	4:2:2 YCbCr	12-bit	
		4:4:4 RGB	12-bit/10-bit	
	1920x1080PsF 23.98/24.00 Hz	4:4:4 YCbCr	12-bit	
			10-bit	SMPTE 425-1 SMPTE 274M
4:4:4 RGB		10-bit		
		12-bit		
2048x1080P 59.94/60.00 Hz	4:2:2 YCbCr	10-bit	SMPTE 425-1 SMPTE 428-9 SMPTE 428-19 SMPTE 2048-2	
	4:4:4 RGB	12-bit/10-bit		
2048x1080i 59.94/60.00 Hz	4:4:4 YCbCr			
	4:4:4 X'Y'Z'	12-bit		
	4:2:2 YCbCr			

Transmission method	Signal format	Color format	Color depth	Standards
3G-SDI Level A x 1	2048x1080P 50.00 Hz	4:2:2 YCbCr	10-bit	SMPTE 425-1 SMPTE 2048-2
	2048x1080i 50.00 Hz	4:4:4 RGB 4:4:4 YCbCr	12-bit/10-bit	
		4:4:4 X'Y'Z'	12-bit	
		4:2:2 YCbCr		
	2048x1080P 47.95/48.00 Hz	4:2:2 YCbCr	10-bit	SMPTE 425-1 SMPTE 2048-2
	2048x1080P 29.97/30.00 Hz	4:4:4 RGB	12-bit/10-bit	SMPTE 425-1 SMPTE 428-9
		4:4:4 X'Y'Z'	12-bit	SMPTE 428-19 SMPTE 2048-2
		4:4:4 YCbCr	12-bit/10-bit	SMPTE 425-1
		4:2:2 YCbCr	12-bit	SMPTE 2048-2
	2048x1080PsF 29.97/30.00 Hz	4:4:4 RGB	12-bit/10-bit	SMPTE 425-1 SMPTE 428-9
		4:4:4 X'Y'Z'	12-bit	SMPTE 428-19 SMPTE 2048-2
		4:4:4 YCbCr	12-bit/10-bit	SMPTE 425-1
		4:2:2 YCbCr	12-bit	SMPTE 2048-2
	2048x1080P 25.00 Hz	4:4:4 RGB	12-bit/10-bit	SMPTE 425-1 SMPTE 428-9
		4:4:4 X'Y'Z'	12-bit	SMPTE 428-19 SMPTE 2048-2
		4:4:4 YCbCr	12-bit/10-bit	SMPTE 425-1
		4:2:2 YCbCr	12-bit	SMPTE 2048-2
	2048x1080PsF 25.00 Hz	4:4:4 RGB	12-bit/10-bit	SMPTE 425-1 SMPTE 428-9
		4:4:4 X'Y'Z'	12-bit	SMPTE 428-19 SMPTE 2048-2
		4:4:4 YCbCr	12-bit/10-bit	SMPTE 425-1
		4:2:2 YCbCr	12-bit	SMPTE 2048-2
	2048x1080P 23.98/24.00 Hz	4:4:4 RGB	12-bit/10-bit	SMPTE 425-1 SMPTE 428-9
		4:4:4 X'Y'Z'	12-bit	SMPTE 428-19 SMPTE 2048-2
		4:4:4 YCbCr	12-bit/10-bit	SMPTE 425-1
		4:2:2 YCbCr	12-bit	SMPTE 2048-2
	2048x1080PsF 23.98/24.00 Hz	4:4:4 RGB	12-bit/10-bit	SMPTE 425-1 SMPTE 428-9
		4:4:4 X'Y'Z'	12-bit	SMPTE 428-19 SMPTE 2048-2
		4:4:4 YCbCr	12-bit/10-bit	SMPTE 425-1
4:2:2 YCbCr		12-bit	SMPTE 2048-2	

Transmission method	Signal format	Color format	Color depth	Standards	
3G-SDI Level B x 1	1920x1080P 59.94/60.00 Hz	4:2:2 YCbCr	10-bit	SMPTE 425-1 SMPTE 372 SMPTE 274M	
	1920x1080i 59.94/60.00 Hz	4:4:4 RGB 4:4:4 YCbCr	12-bit/10-bit		
		4:2:2 YCbCr	12-bit		
	1920x1080P 50.00 Hz	4:2:2 YCbCr	10-bit		
	1920x1080i 50.00 Hz	4:4:4 RGB 4:4:4 YCbCr	12-bit/10-bit		
		4:2:2 YCbCr	12-bit		
	1920x1080P 29.97/30.00 Hz	4:4:4 RGB 4:4:4 YCbCr	12-bit/10-bit		
		4:2:2 YCbCr	12-bit		
	1920x1080PsF 29.97/30.00 Hz	4:4:4 RGB 4:4:4 YCbCr	12-bit/10-bit		
		4:2:2 YCbCr	12-bit		
	1920x1080P 25.00 Hz	4:4:4 RGB 4:4:4 YCbCr	12-bit/10-bit		
		4:2:2 YCbCr	12-bit		
	1920x1080PsF 25.00 Hz	4:4:4 RGB 4:4:4 YCbCr	12-bit/10-bit		
		4:2:2 YCbCr	12-bit		
	1920x1080P 23.98/24.00 Hz	4:4:4 RGB 4:4:4 YCbCr	12-bit/10-bit		
		4:2:2 YCbCr	12-bit		
	1920x1080PsF 23.98/24.00 Hz	4:4:4 RGB 4:4:4 YCbCr	12-bit/10-bit		
		4:2:2 YCbCr	12-bit		
	2048x1080P 59.94/60.00 Hz	4:2:2 YCbCr	10-bit	SMPTE 425-1 SMPTE 372 SMPTE 428-9 SMPTE 428-19 SMPTE 2048-2	
	2048x1080i 59.94/60.00 Hz	4:4:4 RGB 4:4:4 YCbCr	12-bit/10-bit		
4:4:4 X'Y'Z' 4:2:2 YCbCr		12-bit			
2048x1080P 50.00 Hz	4:2:2 YCbCr	10-bit	SMPTE 425-1 SMPTE 372 SMPTE 2048-2		
2048x1080i 50.00 Hz	4:4:4 RGB 4:4:4 YCbCr	12-bit/10-bit			
	4:4:4 X'Y'Z' 4:2:2 YCbCr	12-bit			
2048x1080P 47.95/48.00 Hz	4:2:2 YCbCr	10-bit	SMPTE 425-1 SMPTE 372 SMPTE 2048-2		

Transmission method	Signal format	Color format	Color depth	Standards
3G-SDI Level B x 1	2048x1080P 29.97/30.00 Hz	4:4:4 RGB	12-bit/10-bit	SMPTE 425-1 SMPTE 372 SMPTE 428-9 SMPTE 428-19 SMPTE 2048-2
		4:4:4 X'Y'Z'	12-bit	
		4:4:4 YCbCr	12-bit/10-bit	SMPTE 425-1 SMPTE 372 SMPTE 2048-2
		4:2:2 YCbCr	12-bit	
	2048x1080PsF 29.97/30.00 Hz	4:4:4 RGB	12-bit/10-bit	SMPTE 425-1 SMPTE 372 SMPTE 428-9 SMPTE 428-19 SMPTE 2048-2
		4:4:4 X'Y'Z'	12-bit	
		4:4:4 YCbCr	12-bit/10-bit	SMPTE 425-1 SMPTE 372 SMPTE 2048-2
		4:2:2 YCbCr	12-bit	
	2048x1080P 25.00 Hz	4:4:4 RGB	12-bit/10-bit	SMPTE 425-1 SMPTE 372 SMPTE 428-9 SMPTE 428-19 SMPTE 2048-2
		4:4:4 X'Y'Z'	12-bit	
		4:4:4 YCbCr	12-bit/10-bit	SMPTE 425-1 SMPTE 372 SMPTE 2048-2
		4:2:2 YCbCr	12-bit	
	2048x1080PsF 25.00 Hz	4:4:4 RGB	12-bit/10-bit	SMPTE 425-1 SMPTE 372 SMPTE 428-9 SMPTE 428-19 SMPTE 2048-2
		4:4:4 X'Y'Z'	12-bit	
		4:4:4 YCbCr	12-bit/10-bit	SMPTE 425-1 SMPTE 372 SMPTE 2048-2
		4:2:2 YCbCr	12-bit	
2048x1080P 23.98/24.00 Hz	4:4:4 RGB	12-bit/10-bit	SMPTE 425-1 SMPTE 372 SMPTE 428-9 SMPTE 428-19 SMPTE 2048-2	
	4:4:4 X'Y'Z'	12-bit		
	4:4:4 YCbCr	12-bit/10-bit	SMPTE 425-1 SMPTE 372 SMPTE 2048-2	
	4:2:2 YCbCr	12-bit		

Transmission method	Signal format	Color format	Color depth	Standards
3G-SDI Level B x 1	2048x1080PsF 23.98/24.00 Hz	4:4:4 RGB	12-bit/10-bit	SMPTE 425-1 SMPTE 372 SMPTE 428-9 SMPTE 428-19 SMPTE 2048-2
		4:4:4 X'Y'Z'	12-bit	
		4:4:4 YCbCr	12-bit/10-bit	SMPTE 425-1 SMPTE 372 SMPTE 2048-2
		4:2:2 YCbCr	12-bit	
HD-SDI x 4	3840x2160i 59.94/60.00 Hz	4:2:2 YCbCr	10-bit	SMPTE 292-1 SMPTE 274M
	3840x2160i 50.00 Hz			
	3840x2160P 29.97/30.00 Hz			
	3840x2160PsF 29.97/30.00 Hz			
	3840x2160P 25.00 Hz			
	3840x2160PsF 25.00 Hz			
	3840x2160P 23.98/24.00 Hz			
	3840x2160PsF 23.98/24.00 Hz			
	4096x2160i 59.94/60.00 Hz			
	4096x2160i 50.00 Hz			
	4096x2160P 29.97/30.00 Hz			
	4096x2160PsF 29.97/30.00 Hz			
	4096x2160P 25.00 Hz			
	4096x2160PsF 25.00 Hz			
	4096x2160P 23.98/24.00 Hz			
	4096x2160PsF 23.98/24.00 Hz			
				SMPTE 292-1 SMPTE 428-9 SMPTE 428-19 SMPTE 2048-2

Transmission method	Signal format	Color format	Color depth	Standards					
HD-SDI Dual x 4	3840x2160P 59.94/60.00 Hz	4:2:2 YCbCr	10-bit	SMPTE 372 SMPTE 274M					
	3840x2160i 59.94/60.00 Hz	4:4:4 RGB 4:4:4 YCbCr	12-bit/10-bit						
		4:2:2 YCbCr	12-bit						
	3840x2160P 50.00 Hz	4:2:2 YCbCr	12-bit		SMPTE 372 SMPTE 274M				
	3840x2160i 50.00 Hz	4:4:4 RGB 4:4:4 YCbCr	12-bit/10-bit						
		4:2:2 YCbCr	12-bit						
	3840x2160P 29.97/30.00 Hz	4:4:4 RGB 4:4:4 YCbCr	12-bit/10-bit			SMPTE 372 SMPTE 274M			
		4:2:2 YCbCr	12-bit						
	3840x2160PsF 29.97/30.00 Hz	4:4:4 RGB 4:4:4 YCbCr	12-bit/10-bit				SMPTE 372 SMPTE 274M		
		4:2:2 YCbCr	12-bit						
	3840x2160P 25.00 Hz	4:4:4 RGB 4:4:4 YCbCr	12-bit/10-bit					SMPTE 372 SMPTE 274M	
		4:2:2 YCbCr	12-bit						
	3840x2160PsF 25.00 Hz	4:4:4 RGB 4:4:4 YCbCr	12-bit/10-bit	SMPTE 372 SMPTE 274M					
		4:2:2 YCbCr	12-bit						
	3840x2160P 23.98/24.00 Hz	4:4:4 RGB 4:4:4 YCbCr	12-bit/10-bit						SMPTE 372 SMPTE 274M
		4:2:2 YCbCr	12-bit						
	3840x2160PsF 23.98/24.00 Hz	4:4:4 RGB 4:4:4 YCbCr	12-bit/10-bit		SMPTE 372 SMPTE 274M				
		4:2:2 YCbCr	12-bit						
	4096x2160P 59.94/60.00 Hz	4:2:2 YCbCr	10-bit			SMPTE 372 SMPTE 428-9 SMPTE 428-19 SMPTE 2048-2			
	4096x2160i 59.94/60.00 Hz	4:4:4 RGB 4:4:4 YCbCr	12-bit/10-bit						
4:4:4 X'Y'Z' 4:2:2 YCbCr		12-bit							
4096x2160P 50.00 Hz	4:2:2 YCbCr	10-bit	SMPTE 372 SMPTE 2048-2						
4096x2160i 50.00 Hz	4:4:4 RGB 4:4:4 YCbCr	12-bit/10-bit							
	4:4:4 X'Y'Z' 4:2:2 YCbCr	12-bit							
4096x2160P 47.95/48.00 Hz	4:2:2 YCbCr	10-bit	SMPTE 372 SMPTE 2048-2						

Transmission method	Signal format	Color format	Color depth	Standards
HD-SDI Dual x 4	4096x2160P 29.97/30.00 Hz	4:4:4 RGB	12-bit/10-bit	SMPTE 372
		4:4:4 X'Y'Z'	12-bit	SMPTE 428-9 SMPTE 428-19 SMPTE 2048-2
		4:4:4 YCbCr	12-bit/10-bit	SMPTE 372
		4:2:2 YCbCr	12-bit	SMPTE 2048-2
	4096x2160PsF 29.97/30.00 Hz	4:4:4 RGB	12-bit/10-bit	SMPTE 372
		4:4:4 X'Y'Z'	12-bit	SMPTE 428-9 SMPTE 428-19 SMPTE 2048-2
		4:4:4 YCbCr	12-bit/10-bit	SMPTE 372
		4:2:2 YCbCr	12-bit	SMPTE 2048-2
	4096x2160P 25.00 Hz	4:4:4 RGB	12-bit/10-bit	SMPTE 372
		4:4:4 X'Y'Z'	12-bit	SMPTE 428-9 SMPTE 428-19 SMPTE 2048-2
		4:4:4 YCbCr	12-bit/10-bit	SMPTE 372
		4:2:2 YCbCr	12-bit	SMPTE 2048-2
	4096x2160PsF 25.00 Hz	4:4:4 RGB	12-bit/10-bit	SMPTE 372
		4:4:4 X'Y'Z'	12-bit	SMPTE 428-9 SMPTE 428-19 SMPTE 2048-2
		4:4:4 YCbCr	12-bit/10-bit	SMPTE 372
		4:2:2 YCbCr	12-bit	SMPTE 2048-2
	4096x2160P 23.98/24.00 Hz	4:4:4 RGB	12-bit/10-bit	SMPTE 372
		4:4:4 X'Y'Z'	12-bit	SMPTE 428-9 SMPTE 428-19 SMPTE 2048-2
		4:4:4 YCbCr	12-bit/10-bit	SMPTE 372
		4:2:2 YCbCr	12-bit	SMPTE 2048-2
4096x2160PsF 23.98/24.00 Hz	4:4:4 RGB	12-bit/10-bit	SMPTE 372	
	4:4:4 X'Y'Z'	12-bit	SMPTE 428-9 SMPTE 428-19 SMPTE 2048-2	
	4:4:4 YCbCr	12-bit/10-bit	SMPTE 372	
	4:2:2 YCbCr	12-bit	SMPTE 2048-2	

Transmission method	Signal format	Color format	Color depth	Standards
3G-SDI Level A x 4	3840x2160P 59.94/60.00 Hz	4:2:2 YCbCr	10-bit	SMPTE 425-1 SMPTE 274M
	3840x2160i 59.94/60.00 Hz	4:4:4 RGB 4:4:4 YCbCr	12-bit/10-bit	
		4:2:2 YCbCr	12-bit	
	3840x2160P 50.00 Hz	4:2:2 YCbCr	12-bit	
	3840x2160i 50.00 Hz	4:4:4 RGB 4:4:4 YCbCr	12-bit/10-bit	
		4:2:2 YCbCr	12-bit	
	3840x2160P 29.97/30.00 Hz	4:4:4 RGB 4:4:4 YCbCr	12-bit/10-bit	
		4:2:2 YCbCr	12-bit	
	3840x2160PsF 29.97/30.00 Hz	4:4:4 RGB	10-bit	
			12-bit	
		4:4:4 YCbCr	12-bit	
		4:4:4 YCbCr	10-bit	SMPTE 425-1 SMPTE 274M
	4:2:2 YCbCr	12-bit		
	3840x2160P 25.00 Hz	4:4:4 RGB 4:4:4 YCbCr	12-bit/10-bit	
		4:2:2 YCbCr	12-bit	
	3840x2160PsF 25.00 Hz	4:4:4 RGB	10-bit	
			12-bit	
		4:4:4 YCbCr	12-bit	
		4:4:4 YCbCr	10-bit	SMPTE 425-1 SMPTE 274M
	4:2:2 YCbCr	12-bit		
	3840x2160P 23.98/24.00 Hz	4:2:2 YCbCr 4:4:4 YCbCr	12-bit/10-bit	
		4:2:2 YCbCr	12-bit	
	3840x2160PsF 23.98/24.00 Hz	4:4:4 RGB	10-bit	
			12-bit	
		4:4:4 YCbCr	12-bit	
		4:4:4 YCbCr	10-bit	SMPTE 425-1 SMPTE 274M
	4:2:2 YCbCr	12-bit		
	4096x2160P 59.94/60.00 Hz	4:2:2 YCbCr	10-bit	SMPTE 425-1 SMPTE 428-9 SMPTE 428-19 SMPTE 2048-2
4096x2160i 59.94/60.00 Hz	4:4:4 RGB 4:4:4 YCbCr	12-bit/10-bit		
	4:4:4 X'Y'Z' 4:2:2 YCbCr	12-bit		

Transmission method	Signal format	Color format	Color depth	Standards
3G-SDI Level A x 4	4096x2160P 50.00 Hz	4:2:2 YCbCr	10-bit	SMPTE 425-1 SMPTE 2048-2
	4096x2160i 50.00 Hz	4:4:4 RGB 4:4:4 YCbCr	12-bit/10-bit	
		4:4:4 X'Y'Z' 4:2:2 YCbCr	12-bit	
	4096x2160P 47.95/48.00 Hz	4:2:2 YCbCr	10-bit	SMPTE 425-1 SMPTE 2048-2
	4096x2160P 29.97/30.00 Hz	4:4:4 RGB	12-bit/10-bit	SMPTE 425-1 SMPTE 428-9 SMPTE 428-19 SMPTE 2048-2
		4:4:4 X'Y'Z'	12-bit	
		4:4:4 YCbCr	12-bit/10-bit	SMPTE 425-1 SMPTE 2048-2
		4:2:2 YCbCr	12-bit	
	4096x2160PsF 29.97/30.00 Hz	4:4:4 RGB	12-bit/10-bit	SMPTE 425-1 SMPTE 428-9 SMPTE 428-19 SMPTE 2048-2
		4:4:4 X'Y'Z'	12-bit	
		4:4:4 YCbCr	12-bit/10-bit	SMPTE 425-1 SMPTE 2048-2
		4:2:2 YCbCr	12-bit	
	4096x2160P 25.00 Hz	4:4:4 RGB	12-bit/10-bit	SMPTE 425-1 SMPTE 428-9 SMPTE 428-19 SMPTE 2048-2
		4:4:4 X'Y'Z'	12-bit	
		4:4:4 YCbCr	12-bit/10-bit	SMPTE 425-1 SMPTE 2048-2
		4:2:2 YCbCr	12-bit	
	4096x2160PsF 25.00 Hz	4:4:4 RGB	12-bit/10-bit	SMPTE 425-1 SMPTE 428-9 SMPTE 428-19 SMPTE 2048-2
		4:4:4 X'Y'Z'	12-bit	
		4:4:4 YCbCr	12-bit/10-bit	SMPTE 425-1 SMPTE 2048-2
		4:2:2 YCbCr	12-bit	
	4096x2160P 23.98/24.00 Hz	4:4:4 RGB	12-bit/10-bit	SMPTE 425-1 SMPTE 428-9 SMPTE 428-19 SMPTE 2048-2
		4:4:4 X'Y'Z'	12-bit	
		4:4:4 YCbCr	12-bit/10-bit	SMPTE 425-1 SMPTE 2048-2
		4:2:2 YCbCr	12-bit	
	4096x2160PsF 23.98/24.00 Hz	4:4:4 RGB	12-bit/10-bit	SMPTE 425-1 SMPTE 428-9 SMPTE 428-19 SMPTE 2048-2
		4:4:4 X'Y'Z'	12-bit	
		4:4:4 YCbCr	12-bit/10-bit	SMPTE 425-1 SMPTE 2048-2
		4:2:2 YCbCr	12-bit	

Transmission method	Signal format	Color format	Color depth	Standards
3G-SDI Level B x 4	3840x2160P 59.94/60.00 Hz	4:2:2 YCbCr	10-bit	SMPTE 425-1 SMPTE 372 SMPTE 274M
	3840x2160i 59.94/60.00 Hz	4:4:4 RGB	12-bit/10-bit	
		4:4:4 YCbCr		
	3840x2160P 50.00 Hz	4:2:2 YCbCr	12-bit	
		4:2:2 YCbCr	10-bit	
	3840x2160i 50.00 Hz	4:4:4 RGB	12-bit/10-bit	
		4:4:4 YCbCr		
	3840x2160P 29.97/30.00 Hz	4:2:2 YCbCr	12-bit	
		4:4:4 RGB	12-bit/10-bit	
	4:4:4 YCbCr			
		4:2:2 YCbCr	12-bit	
	3840x2160PsF 29.97/30.00 Hz	4:4:4 RGB	12-bit/10-bit	
		4:4:4 YCbCr		
	3840x2160PsF 25.00 Hz	4:2:2 YCbCr	12-bit	
		4:4:4 RGB	12-bit/10-bit	
	4:4:4 YCbCr			
		4:2:2 YCbCr	12-bit	
	3840x2160PsF 25.00 Hz	4:4:4 RGB	12-bit/10-bit	
		4:4:4 YCbCr		
	3840x2160P 23.98/24.00 Hz	4:2:2 YCbCr	12-bit	
4:4:4 RGB		12-bit/10-bit		
4:4:4 YCbCr				
	4:2:2 YCbCr	12-bit		
3840x2160PsF 23.98/24.00 Hz	4:4:4 RGB	12-bit/10-bit		
	4:4:4 YCbCr			
4096x2160P 59.94/60.00 Hz	4:2:2 YCbCr	10-bit	SMPTE 425-1 SMPTE 372 SMPTE 428-9 SMPTE 428-19 SMPTE 2048-2	
	4096x2160i 59.94/60.00 Hz	4:4:4 RGB		12-bit/10-bit
4096x2160i 59.94/60.00 Hz	4:4:4 YCbCr			
	4:4:4 X'Y'Z'	12-bit		
4:2:2 YCbCr				
4096x2160P 50.00 Hz	4:2:2 YCbCr	10-bit	SMPTE 425-1 SMPTE 372 SMPTE 2048-2	
	4096x2160i 50.00 Hz	4:4:4 RGB		12-bit/10-bit
4096x2160i 50.00 Hz	4:4:4 YCbCr			
	4:4:4 X'Y'Z'	12-bit		
4:2:2 YCbCr				

Transmission method	Signal format	Color format	Color depth	Standards
3G-SDI Level B x 4	4096x2160P 47.95/48.00 Hz	4:2:2 YCbCr	10-bit	SMPTE 425-1 SMPTE 372 SMPTE 2048-2
	4096x2160P 29.97/30.00 Hz	4:4:4 RGB	12-bit/10-bit	SMPTE 425-1 SMPTE 372 SMPTE 428-9 SMPTE 428-19 SMPTE 2048-2
		4:4:4 X'Y'Z'	12-bit	
		4:4:4 YCbCr	12-bit/10-bit	SMPTE 425-1 SMPTE 372 SMPTE 2048-2
		4:2:2 YCbCr	12-bit	
	4096x2160PsF 29.97/30.00 Hz	4:4:4 RGB	12-bit/10-bit	SMPTE 425-1 SMPTE 372 SMPTE 428-9 SMPTE 428-19 SMPTE 2048-2
		4:4:4 X'Y'Z'	12-bit	
		4:4:4 YCbCr	12-bit/10-bit	SMPTE 425-1 SMPTE 372 SMPTE 2048-2
		4:2:2 YCbCr	12-bit	
	4096x2160P 25.00 Hz	4:4:4 RGB	12-bit/10-bit	SMPTE 425-1 SMPTE 372 SMPTE 428-9 SMPTE 428-19 SMPTE 2048-2
		4:4:4 X'Y'Z'	12-bit	
		4:4:4 YCbCr	12-bit/10-bit	SMPTE 425-1 SMPTE 372 SMPTE 2048-2
		4:2:2 YCbCr	12-bit	
	4096x2160PsF 25.00 Hz	4:4:4 RGB	12-bit/10-bit	SMPTE 425-1 SMPTE 372 SMPTE 428-9 SMPTE 428-19 SMPTE 2048-2
		4:4:4 X'Y'Z'	12-bit	
		4:4:4 YCbCr	12-bit/10-bit	SMPTE 425-1 SMPTE 372 SMPTE 2048-2
		4:2:2 YCbCr	12-bit	
	4096x2160P 23.98/24.00 Hz	4:4:4 RGB	12-bit/10-bit	SMPTE 425-1 SMPTE 372 SMPTE 428-9 SMPTE 428-19 SMPTE 2048-2
		4:4:4 X'Y'Z'	12-bit	
		4:4:4 YCbCr	12-bit/10-bit	SMPTE 425-1 SMPTE 372 SMPTE 2048-2
4:2:2 YCbCr		12-bit		
4096x2160PsF 23.98/24.00 Hz	4:4:4 YCbCr	12-bit/10-bit	SMPTE 425-1 SMPTE 372 SMPTE 2048-2	
	4:2:2 YCbCr	12-bit		

■ DisplayPort

Signal format	Standards	PixelClock [MHz]	Horizontal frequency [kHz]	Vertical frequency [Hz]
640x480	VESA DMT	25.175	31.469	59.940
800x600	VESA DMT	40.000	37.879	60.317
1024x768	VESA DMT	65.000	48.363	60.004
1920x1080	VESA DMT	148.500	67.500	60.000
2048x1080 CVTRB	VESA CVT	147.000	66.576	59.924
2048x1280 CVTRB	VESA CVT	174.250	78.918	59.922
2048x1280	VESA CVT	220.250	79.570	59.962
3840x2160*	VESA DMT	148.500	67.500	60.000
4096x2160 CVTRB*	VESA CVT	147.000	66.576	59.924
4096x2560 CVTRB*	VESA CVT	174.250	78.918	59.922
4096x2560*	VESA CVT	220.250	79.570	59.962

* Values for one terminal are shown for PixelClock and Horizontal frequency.

Image/Frame Display

■ SDI

Input (Signal system)			Output (Display frame rate)	
1280x720	23.98/24.00	P	47.96/48.00	P*
	25.00	P	50.00	P*
	29.97/30.00	P	59.94/60.00	P*
	50.00	P	50.00	P
	59.94/60.00	P	59.94/60.00	P
1920x1080	50.00	i	50.00	P
	59.94/60.00	i	59.94/60.00	P
	23.98/24.00	PsF	47.96/48.00	P*
	25.00	PsF	50.00	P*
	29.97/30.00	PsF	59.94/60.00	P*
	23.98/24.00	P	47.96/48.00	P*
	25.00	P	50.00	P*
	29.97/30.00	P	59.94/60.00	P*
	50.00	P	50.00	P
	59.94/60.00	P	59.94/60.00	P
2048x1080	50.00	i	50.00	P
	59.94/60.00	i	59.94/60.00	P
	23.98/24.00	PsF	47.96/48.00	P*
	25.00	PsF	50.00	P*
	29.97/30.00	PsF	59.94/60.00	P*
	23.98/24.00	P	47.96/48.00	P*
	25.00	P	50.00	P*
	29.97/30.00	P	59.94/60.00	P*
	47.95/48.00	P	47.95/48.00	P
	50.00	P	50.00	P
59.94/60.00	P	59.94/60.00	P	
3840x2160	50.00	i	50.00	P
	59.94/60.00	i	59.94/60.00	P
	23.98/24.00	PsF	47.96/48.00	P*
	25.00	PsF	50.00	P*
	29.97/30.00	PsF	59.94/60.00	P*
	23.98/24.00	P	47.96/48.00	P*
	25.00	P	50.00	P*
	29.97/30.00	P	59.94/60.00	P*
	50.00	P	50.00	P
59.94/60.00	P	59.94/60.00	P	

Input (Signal system)			Output (Display frame rate)	
4096x2160	50.00	i	50.00	P
	59.94/60.00	i	59.94/60.00	P
	23.98/24.00	PsF	47.96/48.00	P*
	25.00	PsF	50.00	P*
	29.97/30.00	PsF	59.94/60.00	P*
	23.98/24.00	P	47.96/48.00	P*
	25.00	P	50.00	P*
	29.97/30.00	P	59.94/60.00	P*
	47.95/48.00	P	47.95/48.00	P
	50.00	P	50.00	P
	59.94/60.00	P	59.94/60.00	P

* : Displaying same frame

■ DisplayPort



Input (Signal system)			Output (Display frame rate)	
640x480	59.940	P	59.940	P
800x600	60.317	P	60.317	P
1024x768	60.004	P	60.004	P
1920x1080	60.00	P	60.00	P
2048x1080	59.924	P	59.924	P
2048x1280	59.922/59.962	P	59.922/59.962	P
3840x2160	60.00	P	60.00	P
4096x2160	59.924	P	59.924	P
4096x2560	59.922/59.962	P	59.922/59.962	P



Error Messages

Message		Description and Action
Calibration	Failed to initialize the external sensor.	See CA-310 and CA-210 instruction manual.
	Calibration error.	<ul style="list-style-type: none"> • Check the installation and connection of the external sensor and retry (📖31). • Perform matrix calibration of CA-310 and CA-210 (📖32).
	Calibration is completed. (Brightness setting is lower than target brightness.)	Set the "Luminance" in calibration again (📖48).
	Failed to detect the external sensor. Please check the connection with the sensor.	Correctly connect the external sensor to the USB port of this main unit.
Network	Communication error.	IP address may be in conflict or there may be a network communication error. Check the network environment.
	Invalid IP Address.	Enter the correct IP address.
	Invalid Subnet Mask.	Enter the correct subnet mask.
Various settings, CDL export	The USB memory is full.	Use another USB memory or delete the content of the memory.
	Failed to write file.	The USB memory may be defective or protected. Check the USB memory.
LUT, Various settings, CDL import	(LUT Import) "LUT Type" is different. (CDL Import) "File Type" is different.	Select the correct file format.
	Failed to read file.	The USB memory may be defective or protected. Check the USB memory.
	Failed to Import.	There is an error in the file to be imported. Check the file.
	No import file.	Check and ensure that the file has been saved to the USB memory or imported to "User 1-3".
Screen Capture	Failed to capture.	The USB memory may be defective or protected. Check the USB memory.
	Invalid Signal.	A screen displaying no video is being captured for example there is no signal or an unsupported signal is being input. Check the signal, input it again, and capture it.
	Copy protected signal.	The signal you tried to capture may be protected by HDCP which is a copy prevention standard for DisplayPort. In this case, the signal cannot be captured. Check the DisplayPort signal.
	Failed to playback file.	The USB memory or the file may be defective or protected. Check the USB memory or the file.
	No capture file.	Check and ensure that the file has been saved to the USB memory.

Message		Description and Action
Hardware error	Backlight error.	Turn off the main power once and then back on. If the message persists, contact Canon Customer Center.
	Fan error.	
	Panel error.	
	I/F error.	
	System error.	
Input signal	No Signal	Displayed when there is no video signal input.
	Unsupported	Unsupported video signal is input. Check the supported signal format (74).
	"Input Configuration" is different from Payload.	Check the "Input Configuration" (51) and "Signal Information" (70) settings. Reset any incorrect "Input Configuration" settings.
Operation	Invalid operation.	Operation is disabled. Check the setting items.
	"Protect Settings" is on.	To use the OSD menu, move the selection frame to "Protect" and press the SET button for approximately 3 seconds.
	"CDL/User LUT Bypass" is on.	When "CDL/User LUT Bypass" is turned "On", you cannot adjust the "Power", "Saturation", "Offset", or "Slope".
	Invalid Password.	Enter the correct password.
	"Knob Lock" is on.	If the knobs are not functioning, please set "Knob Lock" to "Off".
USB memory	USB memory is not connected.	Correctly connect the USB memory to the USB port of this main unit.
	Unsupported USB memory.	Check the USB memory format and make sure it is not protected.

Troubleshooting

Symptom	Cause and Action	
Power does not turn on. (Power indicator does not turn on.)	<ul style="list-style-type: none"> • Turn on the main power. • Check that the AC power cord is connected correctly. • Brightness of the power indicator may be turned "Off". Turn it on and check once more. 	11 22 67
	The screen is dark. When the power indicator does not turn on: <ul style="list-style-type: none"> • Turn on the main power. • Check that the AC power cord is connected correctly. 	11 22
	When the power indicator is lit orange: <ul style="list-style-type: none"> • Press the  button. 	11
Main unit cannot be controlled with the display controller.	When the power indicator is flashing orange: <ul style="list-style-type: none"> • Flashing once every 3 seconds : Contact Canon Customer Center. • Flashing twice every 3 seconds : Turn on the power with the  button. If the power still does not turn on, contact Canon Customer Center. 	11
	<ul style="list-style-type: none"> • Check that the main unit and the display controller are connected correctly. • Pairing may not be performed correctly. Try re-pairing. • Check "Display List". When your display is not found in the list, the display controller does not recognize it. Check also network settings and your network state. 	19 23 66, 67
	The image does not display. <ul style="list-style-type: none"> • Set each item in "Channel Settings" according to input signal. 	51
There is a blank area when set to 4K Input.	<ul style="list-style-type: none"> • There may be no input signal. Look at the display area icon in the interface area and check that the input area and signal cables are properly connected. • Signals with different resolution or frequency may be input from each terminal. Check the signal. 	17 70
	Screen is too bright/dark. <ul style="list-style-type: none"> • Adjust the "Contrast" on the OSD menu. • There is a limit on the service life of LCD backlight. If the screen becomes dark or starts flickering, contact Canon Customer Center. 	41
Burn-in image appears.	<ul style="list-style-type: none"> • This is a characteristic of the LCD panel and you should avoid displaying stationary image for a long time. 	—
There is an unlit or red, blue, green, or white dot on screen.	<ul style="list-style-type: none"> • LCD display is made of very high precision technology. It has effective pixels of 99.99% or more, but there may be black dots or red, blue, or green dots that may be always on. This is not a failure. 	—
There is an interference pattern or trace that remains when the LCD panel is pressed.	<ul style="list-style-type: none"> • The symptom may be resolved by displaying a white or black image on the entire screen. 	—
OSD menu cannot be used.	<ul style="list-style-type: none"> • Check that "Protect Settings" is not set. 	67

Symptom	Cause and Action	
"Aspect Marker", "Safety Zone Marker" or "Area Marker" does not appear.	<ul style="list-style-type: none"> • A channel with no signal, unsupported signal, or with "Input Configuration" not set may be selected. Check the signal. 	70
	<ul style="list-style-type: none"> • "H Delay" or "V Delay" is turned "On". Set to "Off". • Not displayed when "Peaking 1" or "Peaking 2" is selected. Set it to "Off". 	61, 65, 66
You forgot the password for "Protect Settings".	<ul style="list-style-type: none"> • Press the F1 button and the  button on the main unit while the video display is in standby. The configuration will be reset to the state where no password is set. 	11
The video display does not start up in the condition that the power was turned off last time.	<ul style="list-style-type: none"> • Check the "Power on Setting" on the OSD menu. Set "Last memory" to start up the video display in the condition that the power is turned off last time. 	68
The image quality for the User mode in "Picture Mode" differs from the image quality of presets.	<ul style="list-style-type: none"> • Select the preset mode by "Copy Picture Mode" and copy the settings. 	48

Software Used in This Product

Software installed with this product includes software modules from Canon or third parties.

Software Developed by Canon and Free Software

Software developed or created by Canon and accompanying document is protected by copyright law, terms of an international convention and any other governing laws.

This product uses software modules under copyright by third parties and distributed as free software. Some of these software modules are subject to the GNU General Public License v2 (GPL), GNU Lesser General Public License v2.1 (LGPL) or any other license.

Acquiring Source Code for Free Software

Some free software requires the acquirement of the source code of modules in order to distribute the executable form of those software modules. For information on how to acquire the source code for free software such as these and confirming terms of the GPL, LGPL and other license agreements, please check with the distributor from whom the product was purchased.

The following free software modules are installed to this product:

- linux kernel
- SquashFS
- avahi-autoipd
- busybox
- FUSE
- libxml
- glibc
- libfuse
- zlib
- JFFS2
- libupnp
- libpng

License Agreement for this Product

Obligation to Present License Agreement

The copyright holders of software modules installed with this product require its license agreement to be displayed. This license agreement is as follows:

■libupnp License

Copyright (c) 2000-2003 Intel Corporation All rights reserved.

Redistribution and use in source and binary forms, with or without modification, are permitted provided that the following conditions are met:

- * Redistributions of source code must retain the above copyright notice, this list of conditions and the following disclaimer.
- * Redistributions in binary form must reproduce the above copyright notice, this list of conditions and the following disclaimer in the documentation and/or other materials provided with the distribution.
- * Neither name of Intel Corporation nor the names of its contributors may be used to endorse or promote products derived from this software without specific prior written permission.

THIS SOFTWARE IS PROVIDED BY THE COPYRIGHT HOLDERS AND CONTRIBUTORS "AS IS" AND ANY EXPRESS OR IMPLIED WARRANTIES, INCLUDING, BUT NOT LIMITED TO, THE IMPLIED WARRANTIES OF MERCHANTABILITY AND FITNESS FOR A PARTICULAR PURPOSE ARE DISCLAIMED. IN NO EVENT SHALL INTEL OR CONTRIBUTORS BE LIABLE FOR ANY DIRECT, INDIRECT, INCIDENTAL, SPECIAL, EXEMPLARY, OR CONSEQUENTIAL DAMAGES (INCLUDING, BUT NOT LIMITED TO, PROCUREMENT OF SUBSTITUTE GOODS OR SERVICES; LOSS OF USE, DATA, OR PROFITS; OR BUSINESS INTERRUPTION) HOWEVER CAUSED AND ON ANY THEORY OF LIABILITY, WHETHER IN CONTRACT, STRICT LIABILITY, OR TORT (INCLUDING NEGLIGENCE OR OTHERWISE) ARISING IN ANY WAY OUT OF THE USE OF THIS SOFTWARE, EVEN IF ADVISED OF THE POSSIBILITY OF SUCH DAMAGE.

■libxml License

Copyright (C) 1998-2003 Daniel Veillard. All Rights Reserved.

Permission is hereby granted, free of charge, to any person obtaining a copy of this software and associated documentation files (the "Software"), to deal in the Software without restriction, including without limitation the rights to use, copy, modify, merge, publish, distribute, sublicense, and/or sell copies of the Software, and to permit persons to whom the Software is furnished to do so, subject to the following conditions:

The above copyright notice and this permission notice shall be included in all copies or substantial portions of the Software.

THE SOFTWARE IS PROVIDED "AS IS", WITHOUT WARRANTY OF ANY KIND, EXPRESS OR IMPLIED, INCLUDING BUT NOT LIMITED TO THE WARRANTIES OF MERCHANTABILITY, FITNESS FOR A PARTICULAR PURPOSE AND NONINFRINGEMENT. IN NO EVENT SHALL THE DANIEL VEILLARD BE LIABLE FOR ANY CLAIM, DAMAGES OR OTHER LIABILITY, WHETHER IN AN ACTION OF CONTRACT, TORT OR OTHERWISE, ARISING FROM, OUT OF OR IN CONNECTION WITH THE SOFTWARE OR THE USE OR OTHER DEALINGS IN THE SOFTWARE.

Except as contained in this notice, the name of Daniel Veillard shall not be used in advertising or otherwise to promote the sale, use or other dealings in this Software without prior written authorization from him.

Index

Number	
3G/HD-SDI.....	12, 17
4K Input	51
5 Step (Test Pattern).....	65
200% (Screen Scaling)	53
2020 Gamut Mapping	47
A	
ACESproxy.....	41
Adjustment.....	41
Adobe RGB.....	41
Anchor Adjustment.....	26, 48
Area Marker.....	59
Aspect Marker.....	56
B	
Background Color	54
Backlight Control.....	41
Backlight Scan	65
Banner	65
Bias R/G/B.....	42
Bicubic	54
Black Level Control.....	65
Black (Test Pattern).....	65
Blue Off	65
Blue Only.....	65
Blue (Test Pattern)	65
Brightness	25, 41
C	
Calibration	31, 48
Canon Log, CanonLog 2, Canon Log 3.....	43
CDL Export/Import	34, 46
CDL/User LUT Bypass	46
Center Marker	60
Channel Name.....	35, 51
Channel Settings	51
Channel UP/Channel DOWN	66
Chroma	25, 41
Cinema Gamut to 709	42
Cinema Gamut to 2020.....	42
Cinema Gamut to DCI	42
Color Bars (Test Pattern).....	65
Color Gamut.....	42
Color Range.....	45, 52
Color Temperature.....	42
Compatible Settings	67
Configure an IP Address.....	66
Contrast	25, 41
Controller Channel.....	67
Controller Function	66
Custom (xy) (Color Temperature).....	42
D	
Date/Time	34, 67
DCI-P3	41
DCI-P3+ to 709.....	42
DCI-P3+ to DCI.....	42
Detail Settings	
Adjustment	47
CDL.....	46
Display Function	66
Display Name	35, 67
DisplayPort.....	12, 18
Display Settings.....	53
Dual Link HD-SDI	12, 17
E	
EBU.....	41
Export/Import	32, 68
F	
False Color	61
Film Cadence	55
Firmware Ver.....	70
Format.....	51
Frame Hold	54, 61
Function Guide	65
Function Settings.....	61
G	
Gain R/G/B.....	42
Gamma	43
Gamma LUT.....	43
Gamut LUT.....	42
Global Dimming.....	41
Gray (20%) (Test Pattern).....	65
Green Off.....	65

Green (Test Pattern).....	65	OSD Size.....	65
Grid Marker	60	Output Transform	45
H		P	
H Delay	65	Password	67
HD-SDI.....	12, 17	Peaking	61
Hide OSD	69	Picture Mode.....	41
Hybrid Log-Gamma System	47	PLUGE (Test Pattern).....	65
Hybrid Log-Gamma Y/RGB.....	44	Power.....	25, 46
I		Power Indicator Brightness.....	67
Image Priority	54	Power on Setting.....	68
Input Configuration	51	Protect Settings.....	67
Internal Sync	51	PsF.....	54
I/P Conversion.....	54	R	
I/PsF.....	54	Ramp (Test Pattern).....	65
ITU-R BT.709.....	41	Red Off.....	65
ITU-R BT.1886.....	43	Red (Test Pattern)	65
ITU-R BT.2020.....	41	Reset.....	48
K		Reset All Settings	68
Knob Lock.....	67	S	
L		Safety Zone Marker 1, 2	57
LAN.....	12, 19	Saturation.....	25, 46
Language	66	Scaling Method	54
Local Dimming	41	Screen Capture	61
LTC	62	Screen Scaling	53
Luminance.....	48	Select Channel	51
LUT Import	32, 47	Select Input Signal.....	51
M		Serial No.	70
MAC Address.....	70	Settings.....	33, 68
Marker Preset.....	56	Shape Trace	54
Marker Settings	56	Sharpness	25, 41
Monochrome.....	65	Signal Information.....	70
N		Single Input	51
Native Input Resolution (Screen Scaling).....	53	Slope.....	25, 46
Nearest Neighbor	54	SMPTE-C	41
Network	66	Speed Priority.....	54
O		Subnet Mask.....	66
Offset	25, 46	System Information.....	70
OSD Menu	28, 36	System Settings	66
OSD Position.....	65	T	
		Test Pattern	65
		Time Code	62

U

Usage Time 70
USB 12, 31, 32
User 1-7 41
User LUT 46

V

Various Function (Function Settings) 65
V Delay 65
Vector Scope 64
VITC 62

W

Wave Form Monitor 63
White (Test Pattern) 65

Y

YCbCr Color Matrix 47

Z

Zoom 53

CANON PROFESSIONAL DISPLAY LIMITED WARRANTY FOR PRODUCTS PURCHASED IN THE UNITED STATES

The limited warranty set forth below is given by Canon U.S.A., Inc. ('Canon USA') with respect to Canon Professional Display Equipment (the 'Equipment') accompanying this limited warranty in the Equipment's original container, when purchased in the United States. This limited warranty is only effective upon presentation of your Bill of Sale or other proof of purchase.

Canon USA warrants to the original end-user purchaser, when delivered in new condition in its original container, that the Equipment will be free from defects in materials and workmanship under normal use and service for a period of ONE-YEAR from the date of original purchase. When returning Equipment under this warranty, you must pre-pay the shipping charges, and you must enclose a copy of the Bill of Sale or other proof of purchase with a complete explanation of the problem. Equipment returned to a Canon USA factory service facility, and proven to be defective upon inspection, will be, without charge,:

- (a) repaired utilizing new or comparable refurbished parts, or
- (b) exchanged for refurbished or new Equipment

as determined in the Canon USA's repair facility's sole discretion. The repaired or exchanged Equipment will be shipped back free of charge. Warranty exchange or replacement does not extend the original warranty period of the Equipment. For repairs after the warranty period has expired, an estimate of the cost of repair and an opportunity to approve or reject the repair expense before it is incurred will be provided. If you approve, repairs will be made and the Equipment will be returned at your risk and expense. If you reject, the Equipment will be returned to you at no charge to you to an address within the United States.

This limited warranty only applies if the Equipment is used in conjunction with compatible computer equipment, compatible peripheral equipment and compatible software, as to which items Canon USA will have no responsibility. Canon USA shall have no responsibility under this limited warranty for use of the Equipment in conjunction with incompatible peripheral equipment and/or incompatible software. Non-Canon brand peripheral equipment and software which may be distributed with, or be factory loaded on, the Equipment, are sold 'AS IS' without warranty of any kind by Canon USA, including any implied warranty regarding merchantability or fitness for a particular purpose. The sole warranty with respect to such non-Canon brand items is given by the manufacturer or producer thereof. If the Equipment contains a hard disk drive, Canon USA recommends that data stored on that drive be duplicated or backed up to prevent its loss in the event of failure or other malfunction of such drive.

In order to obtain warranty service, please contact the authorized Canon retail dealer from whom you purchased the Equipment or contact the CANON INFORMATION CENTER AT **855-4K-CANON** (855-452-2666) or on the internet at pro.usa.canon.com/support. You will be directed to the nearest service facility for your Equipment.

Technical support program specifics subject to change without notice.

This Limited Warranty covers all defects encountered in normal use of the Equipment and does not apply in the following cases:

- A. Loss or damage to the Equipment due to abuse, neglect, mishandling, electric current fluctuation, accident, improper maintenance, use of non-Canon accessories or failure to follow operating, maintenance or environmental instructions prescribed in Canon USA's user's manual;
- B. If the Equipment is defective as a result of sand, dirt or water damage;
- C. If defects or damages are caused by the use of parts or supplies (other than those sold by Canon USA) that cause damage to the Equipment or that cause abnormally frequent service calls or service problems;
- D. If defects or damages are caused by service other than Canon USA's factory service centers or authorized service facilities;
- E. Any internal modification to product hardware or firmware;
- F. Any maintenance of the Equipment, including any fees for such Maintenance;
- G. If the Equipment has had its serial number or dating altered or removed.

This Limited Warranty does not apply to Equipment purchased outside the United States. This Limited Warranty does not apply to accessories or consumables for the Equipment, which are sold "AS IS", without warranty of any kind by Canon USA. Please retain this warranty card and your Bill of Sale as a permanent record of your purchase. This card ensures that you are contacted promptly should there be a safety inspection, modification or product recall under applicable laws or regulations. This card ensures that you are contacted promptly should there be a safety inspection, modification or product recall under applicable laws or regulations.

NO IMPLIED WARRANTY, INCLUDING MERCHANTABILITY AND FITNESS FOR A PARTICULAR PURPOSE APPLIES TO THIS EQUIPMENT AFTER THE APPLICABLE PERIOD OF EXPRESS WARRANTY OR GUARANTY UNDER THIS WARRANTY (EXCEPT AS MENTIONED ABOVE). (SOME STATES DO NOT ALLOW LIMITATIONS ON HOW LONG AN IMPLIED WARRANTY LASTS, SO THE ABOVE LIMITATION OR EXCLUSION MAY NOT APPLY TO YOU). CANON USA SHALL NOT BE LIABLE FOR LOSS OF REVENUES OR PROFITS, EXPENSE FOR SUBSTITUTE EQUIPMENT OR SERVICE, STORAGE CHARGES, LOSS OR CORRUPTION OF DATA, INCLUDING WITHOUT LIMITATION, LOSS OR CORRUPTION OF DATA STORED ON THE EQUIPMENT'S HARD DRIVE, OR ANY OTHER SPECIAL, INCIDENTAL OR CONSEQUENTIAL DAMAGES CAUSED BY THE USE, MISUSE OR INABILITY TO USE THE EQUIPMENT, REGARDLESS OF THE LEGAL THEORY ON WHICH THE CLAIM IS BASED, AND EVEN IF CANON USA HAS BEEN ADVISED OF THE POSSIBILITY OF SUCH DAMAGES. NOR SHALL RECOVERY OF ANY KIND AGAINST CANON USA BE GREATER THAN THE PURCHASE PRICE OF THE EQUIPMENT SOLD BY CANON USA AND CAUSING THE ALLEGED DAMAGE. WITHOUT LIMITING THE FOREGOING, YOU ASSUME ALL RISK AND LIABILITY FOR LOSS, DAMAGE OR INJURY TO YOU AND YOUR PROPERTY AND TO OTHERS AND THEIR PROPERTY ARISING OUT OF USE, MISUSE OR INABILITY TO USE THE EQUIPMENT NOT CAUSED DIRECTLY BY THE NEGLIGENCE OF CANON USA (SOME STATES DO NOT ALLOW THE EXCLUSION OR LIMITATION OF INCIDENTAL OR CONSEQUENTIAL DAMAGES, SO THE ABOVE LIMITATION MAY NOT APPLY TO YOU). THIS WARRANTY SHALL NOT EXTEND TO ANYONE OTHER THAN THE ORIGINAL PURCHASER OF THIS EQUIPMENT OR THE PERSON FOR WHOM IT WAS PURCHASED AS A GIFT.

This warranty gives you specific legal rights, and you may also have other rights which vary from state to state.

CANON U.S.A., INC

CANON PROFESSIONAL DISPLAY LIMITED WARRANTY FOR PRODUCTS PURCHASED IN CANADA

The limited warranty set forth below is given by Canon Canada Inc. ('Canon Canada') with respect to Canon Professional Display Equipment (the 'Equipment') accompanying this limited warranty in the Equipment's original container, when purchased in Canada. This limited warranty is only effective upon presentation of your bill of sale or other proof of purchase.

Canon Canada warrants to the original end-user purchaser, when delivered in new condition in its original container, that the Equipment will be free from defects in materials and workmanship under normal use and service for a period of ONE YEAR from the date of original purchase. When returning Equipment under this limited warranty, you must pre-pay the shipping charges, and you must enclose a copy of the bill of sale or other proof of purchase with a complete explanation of the problem. Equipment returned to a Canon Canada factory service facility and proven to be defective upon inspection will be, without charge:

- (a) repaired utilizing new or comparable refurbished parts, or
- (b) exchanged for refurbished or new Equipment,

as determined by the Canon Canada factory service center, in its sole discretion. The repaired or exchanged Equipment will be shipped back free of charge. Warranty exchange or replacement does not extend the original warranty period of the Equipment. For repairs after the warranty period has expired, an estimate of the cost of repair and an opportunity to approve or reject the repair expense before it is incurred will be provided. If you approve the proposed repairs, repairs will be made and the Equipment will be returned at your risk and expense. If you reject the proposed repairs, the Equipment will be returned to you at no charge to you to an address within Canada.

This limited warranty only applies if the Equipment is used in conjunction with compatible computer equipment, compatible peripheral equipment and compatible software, as to which items Canon Canada will have no responsibility. Canon Canada shall have no responsibility under this limited warranty for use of the Equipment in conjunction with incompatible computer equipment, peripheral equipment and/or incompatible software. Non-Canon brand peripheral equipment and software which may be distributed with, or be factory loaded on, the Equipment, are sold 'AS IS' without warranty or condition of any kind by Canon Canada, including any implied warranty or condition regarding merchantability or fitness for a particular purpose. The sole warranty with respect to such non-Canon brand items is given by the manufacturer or producer thereof. If the Equipment contains a hard disk drive, Canon Canada recommends that data stored on that drive be duplicated or backed up to prevent its loss in the event of failure or other malfunction of such drive.

In order to obtain warranty service, please contact the authorized Canon retail dealer from whom you purchased the Equipment or contact the CANON INFORMATION CENTER at **800-667-2666** or on the internet at www.canon.ca/pro.

Technical support program specifics are subject to change without notice.

This limited warranty covers all defects encountered in normal use of the Equipment and does not apply in the following cases:

- A. Loss or damage to the Equipment due to abuse, neglect, mishandling, electric current fluctuation, accident, improper maintenance, use of non-Canon accessories or failure to follow operating, maintenance or environmental instructions prescribed in Canon Canada's users manual;
- B. If the Equipment is defective as a result of sand, dirt or water damage;
- C. If defects or damages are caused by the use of parts or supplies (other than those sold by Canon Canada) that cause damage to the Equipment or that cause abnormally frequent service calls or service problems
- D. If defects or damages are caused by service other than Canon Canada's factory service centers or authorized service facilities;
- E. Any internal modification to product hardware or firmware;
- F. Any maintenance of the Equipment, including any fees for such maintenance; or
- G. If the Equipment has had its serial number or dating altered or removed.

This limited warranty does not apply to Equipment purchased outside Canada. This limited warranty does not apply to accessories or consumables for the Equipment, which are sold "AS IS", without warranty or condition of any kind by Canon Canada. Please retain this warranty card and your bill of sale or other proof of purchase as a permanent record of your purchase. This card ensures that you are contacted promptly should there be a safety inspection, modification or product recall under applicable laws or regulations.

NO IMPLIED WARRANTY OR CONDITION, INCLUDING IN RESPECT OF THE MERCHANTABILITY AND FITNESS FOR A PARTICULAR PURPOSE, APPLIES TO THIS EQUIPMENT AFTER THE EXPIRATION OF THE APPLICABLE PERIOD OF EXPRESS WARRANTY OR GUARANTEE UNDER THIS LIMITED WARRANTY (EXCEPT AS MENTIONED ABOVE). (SOME PROVINCES DO NOT ALLOW LIMITATIONS ON HOW LONG AN IMPLIED WARRANTY LASTS, SO THE ABOVE LIMITATION OR EXCLUSION MAY NOT APPLY TO YOU). CANON CANADA SHALL NOT BE LIABLE FOR LOSS OF REVENUES OR PROFITS, EXPENSE FOR SUBSTITUTE EQUIPMENT OR SERVICE, STORAGE CHARGES, LOSS OR CORRUPTION OF DATA, INCLUDING WITHOUT LIMITATION, LOSS OR CORRUPTION OF DATA STORED ON THE EQUIPMENT'S HARD DRIVE, OR ANY OTHER SPECIAL, INCIDENTAL OR CONSEQUENTIAL DAMAGES CAUSED BY THE USE, MISUSE OR INABILITY TO USE THE EQUIPMENT, REGARDLESS OF THE LEGAL THEORY ON WHICH THE CLAIM IS BASED, AND EVEN IF CANON CANADA HAS BEEN ADVISED OF THE POSSIBILITY OF SUCH DAMAGES. NOR SHALL RECOVERY OF ANY KIND AGAINST CANON CANADA BE GREATER THAN THE PURCHASE PRICE OF THE EQUIPMENT SOLD BY CANON CANADA AND CAUSING THE ALLEGED DAMAGE. WITHOUT LIMITING THE FOREGOING, YOU ASSUME ALL RISK AND LIABILITY FOR LOSS, DAMAGE OR INJURY TO YOU AND YOUR PROPERTY AND TO OTHERS AND THEIR PROPERTY ARISING OUT OF USE, MISUSE OR INABILITY TO USE THE EQUIPMENT NOT CAUSED DIRECTLY BY THE NEGLIGENCE OF CANON CANADA (SOME PROVINCES DO NOT ALLOW THE EXCLUSION OR LIMITATION OF INCIDENTAL OR CONSEQUENTIAL DAMAGES, SO THE ABOVE LIMITATION MAY NOT APPLY TO YOU). THIS LIMITED WARRANTY SHALL NOT EXTEND TO ANYONE OTHER THAN THE ORIGINAL PURCHASER OF THIS EQUIPMENT OR THE PERSON FOR WHOM IT WAS PURCHASED AS A GIFT.

This limited warranty gives you specific legal rights, and you may also have other rights which vary from province to province.

CANON CANADA INC.



Canon Inc. 30-2, Shimomaruko 3-chome, Ohta-ku, Tokyo 146-8501, Japan

AUSTRALIA www.canon.com.au

Canon Australia Pty Ltd

☎ 13-13-83 (within Australia only)

☎ (61) 02-9805-2000

CANADA

CANON CANADA INC.

<http://www.canon.ca/pro>

❖ Professional Product Support / Soutien des produits professionnels

☎ (800) 667-2666

CENTRO Y SURAMÉRICA

CANON LATIN AMERICA, INC.

<http://www.cla.canon.com>

EUROPE www.canon-europa.com

Canon Europa N.V.

Bovenkerkerweg 59,

1185 XB Amstelveen, The Netherlands

MÉXICO

CANON MEXICANA, S DE RL DE CV

<http://www.canon.com.mx>

☎ 52 (55) 5249-4900

NEW ZEALAND www.canon.co.nz

Canon New Zealand Ltd

☎ 0800-222-666 (within New Zealand only)

☎ (64) 09-489-0300

UNITED KINGDOM www.canon.co.uk

Canon UK Ltd

CCI Service Centre, Unit 130, Centennial Park,
Borehamwood, Hertfordshire, WD6 3SE

☎ 0844-369-0100

USA

CANON U.S.A., INC.

<http://pro.usa.canon.com>

<http://pro.usa.canon.com/support>

☎ (855) 4K-CANON (855-452-2666)
(USA only)

캐논코리아컨슈머이미징㈜

<http://www.canon-ci.co.kr>

서울특별시 강남구 테헤란로607, 캐논빌딩 5층
대표전화+82(0)2-1588-8133

Canon Korea Consumer Imaging Inc.

<http://www.canon-ci.co.kr>

5F, Canon Bldg, 607, Teheran-ro, Gangnam-gu,
Seoul, Korea

☎ +82(0)2-1588-8133

Visit your local Canon website to download the latest version of this instruction manual.