



MultiPASS™ MP730
MultiPASS™ MP700

Quick Reference Guide



Copyright

Copyright © 2003 by Canon Inc. All rights reserved. No part of this publication may be reproduced, transmitted, transcribed, stored in a retrieval system, or translated into any language or computer language in any form or by any means, electronic, mechanical, magnetic, optical, chemical, manual, or otherwise, without the prior written permission of Canon Inc.

Trademarks

Canon and BJ are registered trademarks. BCI, MultiPASS, UHQ, and ScanGear are trademarks of Canon Inc.

All other product and brand names are registered trademarks, trademarks or service marks of their respective owners.



As an ENERGY STAR® Partner, Canon Inc. has determined that this product meets the ENERGY STAR® guidelines for energy efficiency.



Super G3 is a phrase used to describe the new generation of fax machines that use ITU-T V.34 standard 33.6 Kbps* modems. Super G3 High Speed Fax machines allow transmission time of approximately 3 seconds* per page which results in reduced telephone line charges.

* Approximately 3 seconds per page fax transmission time based on ITU-T No. 1 Chart (Standard Mode) at 33.6 Kbps modem speed. The Public Switched Telephone Network (PSTN) currently supports 28.8 Kbps modem speeds or lower, depending on telephone line conditions.

► How to use the documentation provided

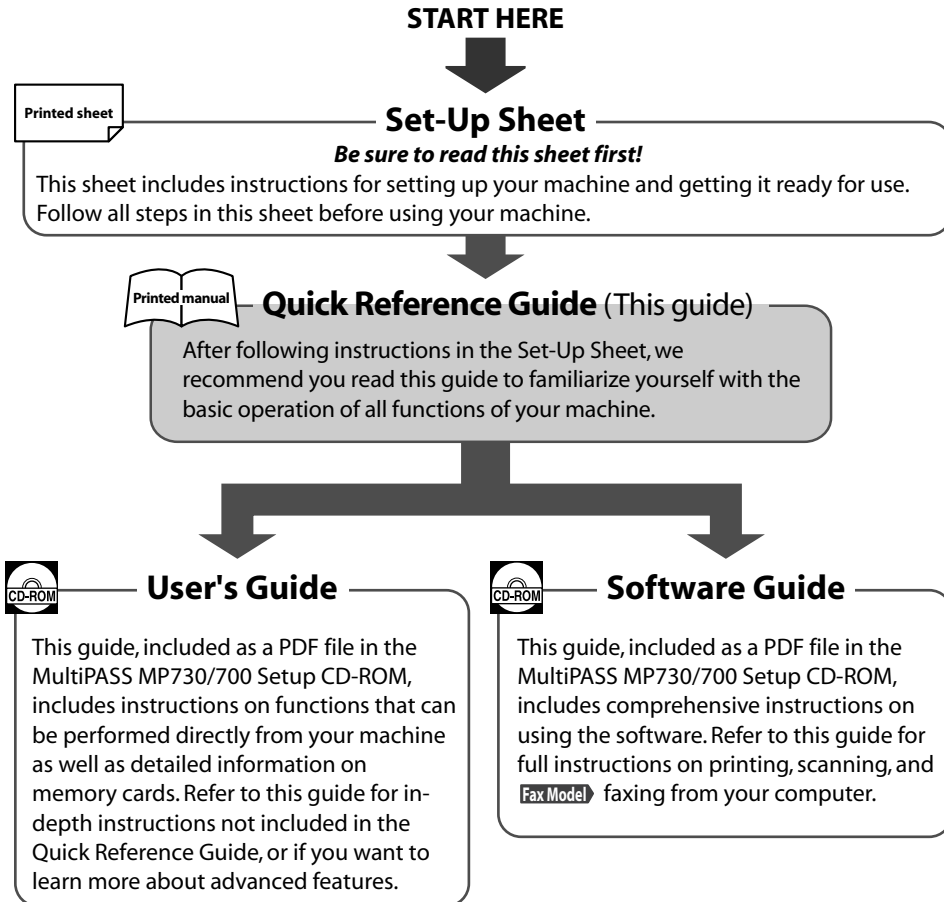

NOTE

- In addition to the above documentation, you can also refer to the online help in the software for online information about a window or dialog box, and for step by step instructions on performing software tasks. To access the online help, select or click [Help] in the software.

► Reading the documentation

Installing the Utility Software

To Install the Utility Software, in the [MP Setup] screen, click [Install Utility Software].

Software included in this CD-ROM:

- **Easy-WebPrint**

Easy-WebPrint is a plug-in program for Internet Explorer that allows you to print a whole web page without complicated settings.

- **Easy-PhotoPrint**

Easy-PhotoPrint is an application that allows you to print an image in your digital camera only by selecting the image and paper type. Easy-Photoprint also allows you to perform simple image modification such as rotating and trimming an image.

- **Scansoft OmniPage**

OmniPage is an application that converts PDF and paper documents– letters, contracts, tables, manuals– using OCR technology, into editable word processing and spreadsheet documents.

- **Presto! PageManager**

Presto! PageManager is an application that allows you to scan, share and organize photos and documents.

- **Adobe Acrobat Reader**

Adobe Acrobat Reader allows you to read Adobe Portable Document Format (PDF) files.

Viewing the documentation on the CD-ROM

1 Insert the MultiPASS MP730/700 Setup CD-ROM into the disk drive.

- The [MP Setup] screen will be displayed. If this screen is not displayed, on the Windows desktop, double-click [My Computer] (Windows XP: Click [Start], then click [My Computer]). Open the CD-ROM icon, then double-click [setup(setup.exe)].



▲ CAUTION

- **The documentation included in the CD-ROM is in PDF and HTML format.**
- **To view the documentation in PDF format, you will need to have Adobe Acrobat Reader installed. If you do not have Adobe Acrobat Reader installed, in the [MP Setup] screen, click [Install Utility Software] to install the software.**

2 In the [MP Setup] screen, click [View User's Manual].

3 In the [View User's Manual] screen, click the button of the guide you want to view.

- You can copy the documentation onto your computer and display start-up icons for the “MP Software Guide” (PDF), “MP User's Guide” (PDF), and “Application Guide” (HTML) on the Windows desktop.

● To copy the documentation to your computer

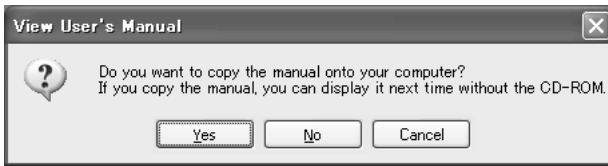

Click [Yes].

The guide will be displayed after it is copied onto your computer's hard disk.

● To not copy the documentation to your computer

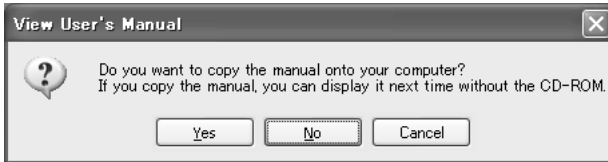

Click [No].

The guide will be displayed without being copied onto your computer's hard disk.

As you copy them, a start-up icon for each guide will be placed on the Windows desktop.







Double-click the icon of the guide you want to open.

NOTE

- Go to the following folder if you want to delete the installed documentation.
/Program Files/Canon/MP Drivers/MP730700

▶ Type conventions

Please read the list below of symbols, terms, and abbreviations used in this guide.

| | |
|--|---|
|  WARNING | Indicates a warning concerning operations that may lead to death or injury to persons if not performed correctly. In order to use the machine safely, always pay attention to these warnings. |
|  CAUTION | Indicates a caution concerning operations that may lead to injury to persons or damage to property if not performed correctly. In order to use the machine safely, always pay attention to these cautions. |
|  IMPORTANT | Indicates operational warnings and restrictions. Be certain to read these items to operate the machine correctly, and to avoid damage to the machine. |
|  NOTE | Indicates notes for operation or additional explanations. Reading these is highly recommended. |
|  Fax Model | Indicates information exclusively for the MultiPASS MP730 model. |
| (→ p. n-nn) | Indicates a page number where additional information can be found. |
| → <i>Set-Up Sheet</i> | Refer to the Set-Up Sheet for more details. |
| → <i>User's Guide</i> | Refer to the User's Guide (included in the CD-ROM) for more details. |
| → <i>Software Guide</i> | Refer to the Software Guide (included in the CD-ROM) for more details. |
| machine | General term used to represent the MultiPASS MP730 or MultiPASS MP700. |
| default | A setting that remains in effect unless you change it. |
| document | The original sheet(s) of paper you copy or scan with the machine. |
| menu | A list of settings from which you select an item to set up or change. A menu has a title which appears in the LCD. |
| [key name] | Text enclosed in these brackets indicate a key name or item on the computer you have to click, double-click, or point to. |
| <message> | Text enclosed in these brackets indicate an LCD message. |
| click, double-click | Term used to select or choose a command or option on your computer, generally with a mouse. |
| <i>Fax model only:</i> | |
| fax or document | The original sheet(s) of paper you send or receive with the machine. |
| transaction number | A four-digit number assigned automatically to any document you send or receive. |
| TX/RX NO. | Denotes <i>Transaction number</i> . |
| TX | Denotes <i>Sending</i> . |
| RX | Denotes <i>Receiving</i> . |

▶ Contents

1: Introduction

| | |
|--------------------------------------|-----|
| Unpacking your machine | 1-1 |
| System requirements | 1-2 |
| Main components of the machine | 1-3 |
| Operation panel of the machine | 1-4 |

2: Documents and print media

| | |
|---|-----|
| Documents | 2-1 |
| Document requirements | 2-1 |
| Loading documents | 2-2 |
| Using the platen glass | 2-2 |
| [Fax Model] Using the ADF | 2-2 |
| Print media | 2-3 |
| Loading requirements | 2-3 |
| Setting the paper thickness lever | 2-4 |
| Setting the print media size and type | 2-4 |
| Loading print media | 2-5 |

3: Printing from your computer — Basic operation

| | |
|--|-----|
| Printing documents | 3-1 |
| Setting the paper type and print quality/[Main] tab | 3-2 |
| More information | 3-3 |

4: Photo printing from a memory card —Basic operation

| | |
|---|------|
| Before printing from a memory card | 4-1 |
| Inserting/removing a memory card | 4-2 |
| Inserting a memory card | 4-2 |
| Removing a memory card | 4-3 |
| Printing methods | 4-4 |
| Printing an index | 4-5 |
| Printing all frames | 4-6 |
| Printing a single frame | 4-8 |
| Reading data from or writing data to a memory card | 4-10 |
| Enabling/disabling overwriting memory card data | 4-10 |
| More information | 4-11 |

5: Copying —Basic operation

| | |
|--|-----|
| Before copying | 5-1 |
| Making copies | 5-1 |
| Improving copied images | 5-1 |
| Setting color or black & white copying | 5-1 |
| Adjusting the image quality (resolution) | 5-2 |
| Adjusting the exposure (density) | 5-2 |
| More information | 5-2 |

6: [Fax Model] PC Faxing —Basic operation

| | |
|--|-----|
| Sending a fax | 6-1 |
| Characters and symbols for fax numbers | 6-2 |
| More information | 6-2 |

7: [Fax Model] Faxing with your machine — Basic operation

| | |
|--|-----|
| Sending faxes from your machine | 7-1 |
| Before sending faxes | 7-1 |
| Sending methods | 7-3 |
| Memory sending | 7-3 |
| Speed dialing | 7-4 |
| Registering one-touch speed dialing | 7-4 |
| Registering coded speed dialing | 7-5 |
| Using speed dialing | 7-6 |
| Receiving faxes to your machine | 7-7 |
| Before receiving faxes to your machine | 7-7 |
| Receiving faxes manually | 7-8 |
| Canceling receiving | 7-8 |
| More information | 7-8 |

8: Scanning —Basic operation

| | |
|---|-----|
| Scanning methods | 8-1 |
| Using the [Scan] key on the operation panel | 8-1 |
| More information | 8-1 |

9: Maintenance

| | |
|--|-----|
| Replacing ink tanks | 9-1 |
| When to replace an ink tank | 9-1 |
| Guidelines | 9-1 |
| Replacing an ink tank | 9-2 |
| Maintaining the printhead | 9-3 |
| Flowchart of printhead maintenance | 9-3 |
| Printing the nozzle check pattern | 9-4 |
| Cleaning the printhead | 9-4 |
| Aligning the printhead | 9-5 |
| More information | 9-6 |

10: Troubleshooting

| | |
|--|-------|
| Problems installing and removing software... | 10-1 |
| Problems turning on the computer..... | 10-2 |
| Problems printing from your computer..... | 10-2 |
| Copying problems..... | 10-5 |
| Problems scanning | 10-6 |
| Fax Model Problems receiving faxes..... | 10-8 |
| Fax Model Problems sending faxes | 10-11 |
| Fax Model Telephone problems | 10-12 |
| Problems using a memory card | 10-12 |
| If nothing displays in the LCD (if there is no power)..... | 10-14 |
| Fax Model If the power disconnects unexpectedly..... | 10-15 |
| Removing jammed paper..... | 10-15 |
| Removing jams in the paper output tray. | 10-15 |
| Removing jams from the machine's interior | 10-15 |
| If there are repeated paper jams..... | 10-16 |
| Fax Model Removing jammed documents | 10-16 |
| If the nozzle check pattern does not print properly | 10-18 |
| Interpreting the messages..... | 10-18 |
| LCD messages | 10-18 |
| If you cannot solve the problem..... | 10-18 |

11: Machine settings

| | |
|--|------|
| Fax Model Printing a list to check the current settings..... | 11-1 |
| Accessing the machine settings | 11-1 |
| Settings..... | 11-2 |

Appendix: Specifications

| | |
|----------------------------------|-----|
| General specifications | A-1 |
| System requirements..... | A-3 |
| Ink specifications..... | A-3 |
| Print specifications | A-4 |
| Photo print specifications | A-4 |
| Copy specifications | A-4 |
| Fax specifications | A-5 |
| Scan specifications | A-6 |
| Telephone specifications..... | A-6 |

| | |
|--------------------|-----|
| Index | I-1 |
|--------------------|-----|

► Safety information

Read this safety information thoroughly before using your machine, and keep it handy in case you need to refer to it later.

▲ WARNING

- **This product emits low level magnetic flux. If you use a cardiac pacemaker and feel abnormalities, please move away from this product and consult your doctor.**

▲ CAUTION

- **Do not disassemble or modify. There are high-temperature and high-voltage components inside the machine which may result in fire or electrical shock.**
- **Follow all warnings and instructions marked on the machine.**

Location

▲ WARNING

- **Do not place the machine near alcohol, paint thinner, or other flammable substances. If flammable substances come into contact with electrical parts inside the machine, it may result in fire or electrical shock.**



▲ CAUTION

- **Do not place the machine on top of a carpet or rug which has long pile. The threads may get inside the machine and cause a fire.**
- **Place the machine on a flat, stable, vibration-free surface that is strong enough to support its weight. (For the weight of the machine, see the Appendix.)**

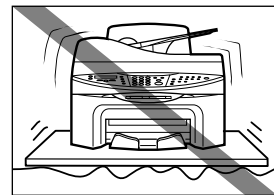

- **Do not place objects around the power plug so that you are able to readily disconnect the power plug from the wall socket at any time. Otherwise you will be unable to disconnect the power plug in case of an emergency.**
- Make sure the area is free from dust.
- Make sure the location is not affected by extreme temperature changes, and always stays between 59° and 81.5°F (15° and 27.5°C).
- Make sure the relative humidity of the area is between 20% and 80%.
- Keep the machine away from direct sunlight.
- Do not use or store the machine outdoors.
- Do not install the machine near devices that contain magnets or generate magnetic fields, such as speakers.

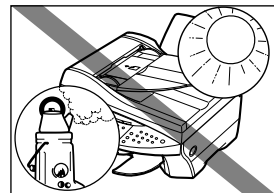

Power Supply

⚠ WARNING

- Do not damage or modify the power cord and power plug. Also do not place heavy objects on the power cord, pull on it, or extensively bend it. These actions may cause electrical damage and result in fire or electrical shock.

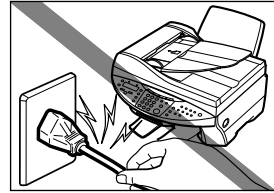

- Do not insert or unplug the power plug with wet hands, as this may result in electrical shock.

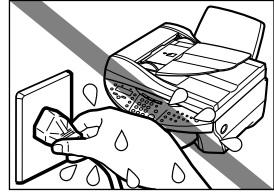

- Do not overload the wall outlet with too many electrical appliances, as this may result in fire or electrical shock.
- Plug the machine into a standard 120 V AC, 60 Hz, three-prong outlet. Operate the machine only from the type of power source indicated on the machine's label or a fire, electrical shock or malfunction may occur. If you are not sure of the type of power available, consult your local power company.
- Do not allow the power cord to be near objects that emit heat. The outer cover of the power cord may melt resulting in fire or electrical shock.
- Make sure the power cord is fully extended and has no knots in it when electricity is running through it. Knots etc. in the cord may result in fire or electrical shock.
- Fully insert the power plug securely into the electrical outlet. If the prongs of the power plug come into contact with metallic objects etc., it may result in fire or electrical shock.

⚠ CAUTION

- During electrical storms, turn off the power and disconnect the power cord from the power outlet. (Please note that any documents stored in the machine's memory will be deleted when you turn off the power.)

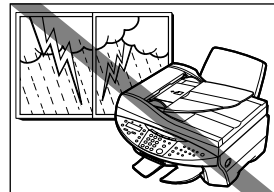

- Do not use an extension cord as this may result in fire or electrical shock.
- Turn off the power and disconnect the power cord if the machine will not be used for a long period such as during holidays.

ⓘ IMPORTANT

- If dust accumulates around the plug of the power cord when it is connected to a power outlet, unplug the machine and wipe the plug with a clean, dry cloth.
- **Fax Mode** Do not plug the machine into the same circuit as appliances such as an air conditioner, television, or copier. These devices generate electrical noise which may interfere with your machine's operation.
- Whenever you turn off the power and unplug the machine, wait at least five seconds before you plug it in again.
- Use only the power cord that came with the machine.
- Turn off the power and unplug the machine in the following conditions:
 - When the power cord or plug is damaged or frayed.
 - If liquid has spilled into the machine.
 - If the machine has been exposed to rain or water.
 - If the machine does not operate normally when you have followed the instructions in the guides included with your machine. Adjust only those controls that are covered by the instructions in the guides since improper adjustment of other controls may result in damage and will often require extensive work by a qualified technician to restore the product to normal operation.
 - If the machine has been dropped or damaged.
 - If the machine exhibits a distinct change in performance, indicating a need for servicing.

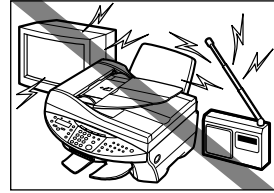

Handling

⚠ WARNING

- Do not drop paper clips, staples, or other metal objects inside the machine. Also do not spill water, liquid, or flammable substances inside the machine. If these items come into contact with high-voltage parts inside the machine, it may result in fire or electrical shock. If these items are dropped or spilled in the machine, turn off the power and unplug the power cord immediately with dry hands. Then contact the Canon Customer Care Center.
- Do not use any highly flammable sprays near the machine. If gas from a spray comes into contact with the electrical components inside the machine, it will result in fire.
- There are high-voltage components inside the machine. If you are looking inside the machine to remove paper jams etc., do not allow metallic objects such as jewelry to come into contact with the inside of the machine. Contact may result in burns or electrical shock.

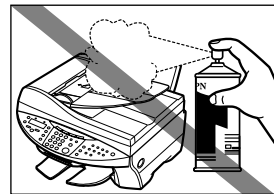
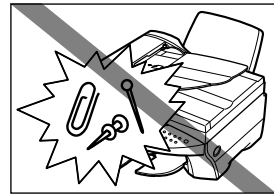

⚠ CAUTION

- Close the document cover and scanning unit gently to avoid catching your hand. Failing to do so may result in personal injury.

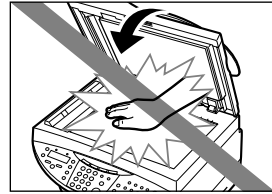

- Do not press down hard on the document cover or **Fax Model** ADF when using the platen glass to scan thick books. This may damage the platen glass and/or result in personal injury.

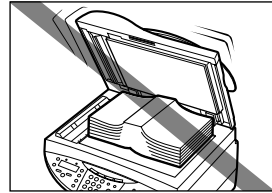

- Do not place the following objects on top of the machine. If such objects come into contact with internal electrical components, the machine may short-circuit resulting in fire or electrical shock.
 - Metallic objects such as jewelry and watches
 - Containers of water or other liquids such as glasses, vases, or pot plantsIf water etc. does spill inside the machine, turn off the power immediately, disconnect the power cord and contact the Canon Customer Care Center.
- Do not touch the high-voltage electrical parts as this may result in electrical shock.
- Do not place heavy objects on top of the machine as these may topple over and result in injury.
- Do not insert your hands into the machine while it is printing as parts inside the machine are moving and this may result in injury.
- After printing, do not touch the electrical contacts of the printhead. They will be hot and may result in burns or electrical shock.
- Do not subject the machine to strong physical shock or vibration.
- Turn off the power and unplug the machine before moving it.
- Do not lift the machine by any of its attachments. Lift it by the recessed areas on the sides of the machine.
- A distinct change in performance may indicate a need for servicing.

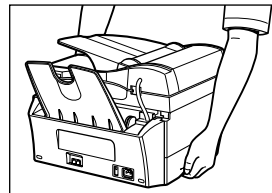

Maintenance

⚠ WARNING

- Do not service the machine yourself except as specifically described in this guide. If further servicing is required, contact the Canon Customer Care Center.
- Keep the machine clean. Dust accumulation may prevent the machine from operating properly.

► Legal limitation on usage of your product and the use of images

Using your product to scan, print or otherwise reproduce certain documents, and the use of such images as scanned, printed or otherwise reproduced by your product, may be prohibited by law and may result in criminal and/or civil liability. A non-exhaustive list of these documents is set forth below. This list is intended to be a guide only. If you are uncertain about the legality of using your product to scan, print or otherwise reproduce any particular document, and/or of the use of the images scanned, printed or otherwise reproduced, you should consult in advance with your legal advisor for guidance.

- Paper money
- Money orders
- Certificates of deposit
- Postage stamps (canceled or uncanceled)
- Identifying badges or insignias
- Selective service or draft papers
- Checks or drafts issued by governmental agencies
- Motor vehicle licenses and certificates of title
- Traveler's checks
- Food stamps
- Passports
- Immigration papers
- Internal revenue stamps (canceled or uncanceled)
- Bonds or other certificates of indebtedness
- Stock certificates
- Copyrighted works/works of art without permission of copyright owner

► Users in the U.S.A.

Pre-installation requirements for Canon facsimile equipment

A. Location

Supply a suitable table, cabinet, or desk. See the Appendix for the machine's dimensions and weight.

B. Order information

1. Only a single line, touch-tone or rotary telephone set is to be used.
2. Order an RJ11-C modular jack (USOC code), which should be installed by the telephone company. If the RJ11-C jack is not present, installation cannot occur.
3. Order a normal business line from your telephone company's business representative. The line should be a regular voice grade line or the equivalent. Use one line per machine.
DDD (DIRECT DISTANCE DIAL) LINE
-or-
IDDD (INTERNATIONAL DIRECT DISTANCE DIAL) LINE IF YOU COMMUNICATE OVERSEAS

NOTE

- Canon recommends an individual line following industry standards, e.g., the 2500 (Touch Tone) or 500 (Rotary/Pulse Dial) telephones. A dedicated extension off a PBX unit without "Call Waiting" can be used with the MultiPASS MP730. Key telephone systems are not recommended because they send non-standard signals to individual telephones for ringing and special codes, which may cause a fax error.

C. Power requirements

This equipment should be connected to a standard 120-volt AC, three-wire grounded outlet only. Do not connect this machine to an outlet or power line shared with other appliances that cause "electrical noise." Air conditioners, electric typewriters, copiers, and machines of this sort generate electrical noise which often interferes with communications equipment and the sending and receiving of documents.

Connection of the equipment

This equipment complies with Part 68 of the FCC rules and the requirements adopted by the ACTA. On the rear panel of this equipment is a label that contains, among other information, a product identifier in the format US:AAAEQ##TXXXX. If requested, this number must be provided to the telephone company.

The REN is used to determine the number of devices that may be connected to a telephone line. Excessive RENs on a telephone line may result in the devices not ringing in response to an incoming call. In most but not all areas, the sum of RENs should not exceed five (5.0). To be certain of the number of devices that may be connected to a line, as determined by the total RENs, contact the local telephone company. The REN for this product is part of the product identifier that has the format US:AAAEQ##TXXXX. The digits represented by ## are the REN without a decimal point (e.g., 03 is a REN of 0.3).

This equipment may not be used on coin service provided by the telephone company. Connection to party lines is subjected to state tariffs.

In case of equipment malfunction

Should any malfunction occur which cannot be corrected by the procedures described in this guide, disconnect the equipment from the telephone line or turn off the power and unplug the power cord. The telephone line should not be reconnected or the power cord plugged in until the problem is completely resolved. Users should contact Canon Authorized Service Facilities for servicing of equipment. Information regarding Authorized Service Facility locations can be obtained by calling the Canon Customer Care Center. (1-800-423-2366)

Rights of the telephone company

Should the equipment cause harm to the telephone network, the telephone company may temporarily disconnect service. The telephone company also retains the right to make changes in facilities and services which may affect the operation of this equipment. When such changes are necessary, the telephone company is required to give adequate prior notice to the user.

FCC Notice

MultiPASS MP730: Facsimile Transceiver, Model H12269

MultiPASS MP700: H12270

This device complies with Part 15 of the FCC Rules.

Operation is subject to the following two conditions:

- (1) This device may not cause harmful interference, and
- (2) this device must accept an interference received, including interference that may cause undesired operation.

NOTE

- This equipment has been tested and found to comply with the limits for a class B digital device, pursuant to Part 15 of the FCC Rules. These limits are designed to provide reasonable protection against harmful interference in a residential installation. This equipment generates, uses and can radiate radio frequency energy and, if not installed and used in accordance with the instructions, may cause harmful interference to radio communications. However, there is no guarantee that interference will not occur in a particular installation. If this equipment does cause harmful interference to radio or television reception, which can be determined by turning the equipment off and on, the user is encouraged to try to correct the interference by one or more of the following measures:

- Reorient or relocate the receiving antenna.
- Increase the separation between the equipment and receiver.
- Connect the equipment into an outlet on a circuit different from that to which the receiver is connected.
- Consult the dealer or an experienced radio/TV technician for help.

Use of shielded cable is required to comply with class B limits in Subpart B of Part 15 of the FCC Rules. Do not make any changes or modifications to the equipment unless otherwise specified in this guide. If such changes or modifications should be made, you could be required to stop operation of the equipment.

Canon U.S.A. Inc.
One Canon Plaza, Lake Success, NY 11042, U.S.A.
TEL No. (516) 328-5600

The Telephone Consumer Protection Act of 1991 makes it unlawful for any person to use a computer or other electronic device to send any message via a telephone fax machine unless such message clearly contains in a margin at the top or bottom of each transmitted page or on the first page of the transmission, the date and time it is sent and an identification of the business or other entity, or other individual sending the message and the telephone number of the sending machine or such business, other entity, or individual.

To automatically enter this information into your machine, follow the instructions on p. 7-1 or p. 8-1 of this guide.

► Users in Canada

Pre-installation requirements for Canon facsimile equipment

A. Location

Supply a suitable table, cabinet, or desk. See the Appendix for the machine's dimensions and weight.

B. Order information

1. Provide only a single-line to touch-tone or rotary telephone set terminated with a standard 4-pin modular phone plug. (Touch-tone is recommended if available in your area.)
2. Order an RJ11-C modular jack (USOC code), which should be installed by the telephone company. If the RJ11-C jack is not present, installation cannot occur.
3. Order a normal business line from your telephone company's business representative. The line should be a regular voice grade line or equivalent. Use one line per machine.
DDD (DIRECT DISTANCE DIAL) LINE
-or-
IDDD (INTERNATIONAL DIRECT DISTANCE DIAL) LINE IF YOU COMMUNICATE OVERSEAS

NOTE

- Canon recommends an individual line following industry standards [e.g., the 2500 (touch tone) or 500 (rotary/pulse dial) telephones]. A dedicated extension off a PBX unit without "Camp On" signals is also permissible with your MultiPASS MP730. Key telephone systems are not recommended because they send non-standard signals to individual telephones for ringing and special codes, which may cause a fax error.

C. Power requirements

The power outlet should be a three-prong grounded receptacle (Single or Duplex). It should be independent from copiers, heaters, air conditioners or any electric equipment that is thermostatically controlled. The rated value is 120 volts and 15 amperes. The RJ11-C modular jack should be relatively close to the power outlet to facilitate installation.

NOTICE

This equipment meets the applicable Industry Canada Terminal Equipment Technical Specifications. This is confirmed by the registration number. The abbreviation, IC, before the registration number signifies that registration was performed based on a Declaration of Conformity indicating that Industry Canada technical specifications were met. It does not imply that Industry Canada approved the equipment.

Cet appareil est conforme aux Spécifications techniques des équipements terminaux de l'Industrie du Canada. Ceci est confirmé par le numéro d'enregistrement. L'abréviation IC précédant le numéro d'enregistrement signifie que l'enregistrement a été effectué sur la base de la Déclaration de conformité indiquant que le produit est conforme aux spécifications techniques du Canada. Ceci n'implique pas que le produit ait été approuvé par l'industrie du Canada.

Before installing this equipment, users should ensure that it is permissible to be connected to the facilities of the local telecommunications company. The equipment must also be installed using an acceptable method of connection. The customer should be aware that compliance with the above conditions may not prevent degradation of service in some situations.

Repairs to certified equipment should be coordinated by a representative designated by the supplier. Any repairs or alterations made by the user to this equipment, or equipment malfunctions, may give the telecommunications company cause to request the user to disconnect the equipment.

Users should ensure for their own protection that the electrical ground connections of the power utility, telephone lines and internal metallic water pipe system, if present, are connected together. This precaution may be particularly important in rural areas.

CAUTION

- **Users should not attempt to make such connections themselves, but should contact the appropriate electric inspection authority, or electrician, as appropriate.**

IMPORTANT

- **This Class B digital apparatus meets all requirements of the Canadian Interference-Causing Equipment Regulations.**
- **Cet appareil numérique de la classe B respecte toutes les exigences du Règlement sur le matériel brouilleur du Canada.**

The Ringer Equivalence Number (REN) for this terminal equipment is 0.3. The REN assigned to each terminal equipment provides an indication of the maximum number of terminals allowed to be connected to a telephone interface. The termination on an interface may consist of any combination of devices subject only to the requirement that the sum of the Ringer Equivalence Numbers of all the devices does not exceed five.

Le Nombre d'équivalence Ringer (REN) de cet appareil terminal est 0.3. Le REN attribué à chaque équipement terminal fournit une indication sur le nombre maximum de terminaux pouvant être connectés sur une interface téléphonique. La terminaison sur une interface peut consister en n'importe quelle combinaison d'appareils, à la condition seulement que la somme des Nombres d'équivalence Ringer de tous les appareils ne soit pas supérieure à 5.

CANON CANADA INC.

1-800-OK-CANON

24 HOURS A DAY, SEVEN DAYS A WEEK

<http://www.canon.ca>

Introduction

► Unpacking your machine

When you unpack your machine, check that you have the following components:

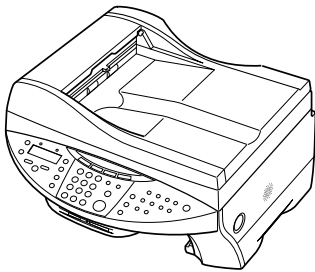

• **Fax Model** MP730

Machine

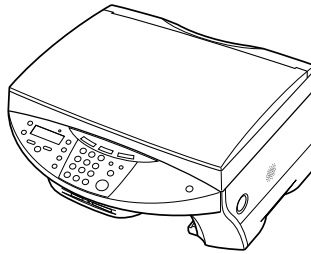

• MP700

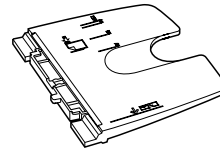

• **Multi-purpose tray**

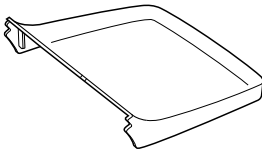

• **Tray cover**

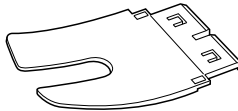

• **Paper output tray**

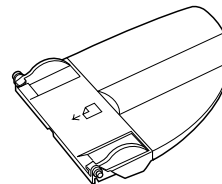

• **Fax Model** **Document tray**

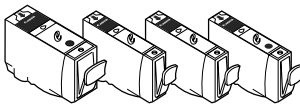

• **Ink tanks**

(Black, cyan, magenta, yellow)

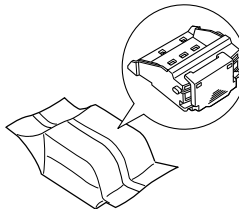

• **Printhead**

- **Power cord**
- **Documentation**
(Set-Up Sheet,
Quick Reference Guide)
- **MultiPASS MP730/700
Setup CD-ROM**
- **Fax Model** **Telephone line cord**
- **Fax Model** **Destination labels**

NOTE

- A USB cable is not included. You must purchase a USB cable (less than 16 $\frac{3}{8}$ ft./5 m) to connect your machine to a computer.

► System requirements

To successfully install and operate the software, your system must meet the following requirements:

- CD-ROM drive, or access to one over a network connection
- 256-color SVGA monitor or greater
- Microsoft Internet Explorer version 4.01 or later (Service Pack 2 or later)
- 65 MB of available hard disk space (150 MB recommended)
 - MP drivers : 50 MB
 - MP Toolbox : 15 MB
- USB cable 16.4 ft. (5 m) or shorter

● Windows 98

- IBM or compatible computer with a Pentium® 90 processor or higher
- 32 MB of RAM (64 MB or more recommended)

● Windows Me

- IBM or compatible computer with a Pentium® 150 processor or higher
- 32 MB of RAM (64 MB or more recommended)

● Windows 2000 (Service Pack 1 or later)

- IBM or compatible computer with a Pentium® 133 processor or higher
- 64 MB of RAM (128 MB or more recommended)

● Windows XP

- IBM or compatible computer with a Pentium® 300 processor or higher
- 64 MB of RAM (128 MB or more recommended)

User privileges when using Windows 2000/XP

When installing, you must have Administrator privileges.

When using, you must have user privileges or greater.

► Main components of the machine

Fax model shown here.

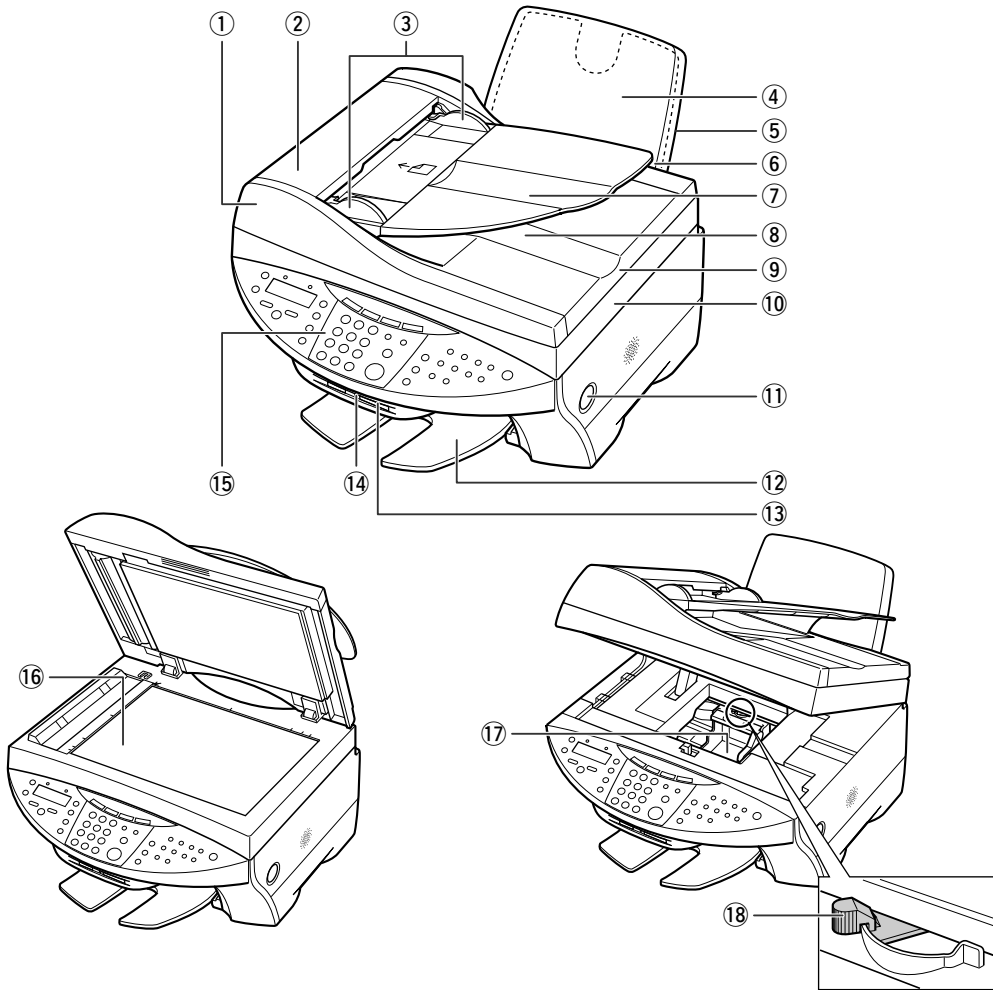

- | | |
|---|---------------------------------|
| ① Fax Model ADF (Automatic Document Feeder) | ⑩ Scanning unit (Printer cover) |
| ② Fax Model Feeder cover | ⑪ [Open] button |
| ③ Fax Model Document guides | ⑫ Paper output tray |
| ④ Multi-purpose tray | ⑬ Card slot |
| ⑤ Tray cover | ⑭ Indicator light |
| ⑥ Automatic sheet feeder | ⑮ Operation panel |
| ⑦ Fax Model Document tray | ⑯ Platen glass |
| ⑧ Fax Model Document output slot | ⑰ Printhead holder |
| ⑨ Document cover | ⑱ Paper thickness lever |

Operation panel of the machine

Fax model shown here.

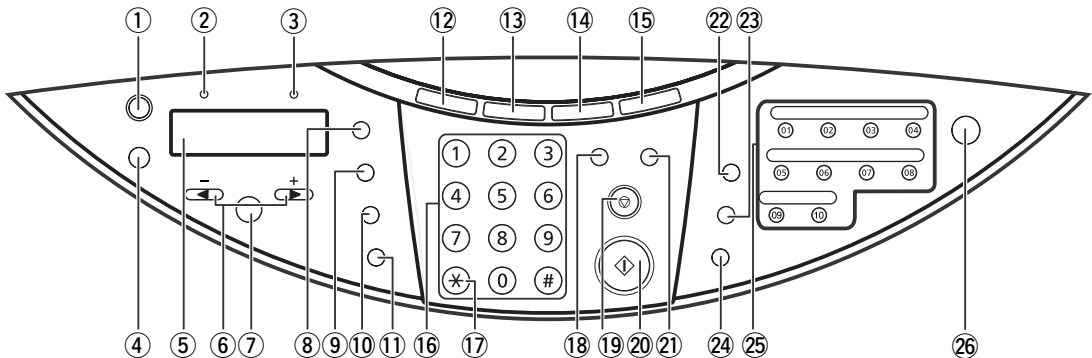

- ① **[Resume] key**
Resumes an operation after an error is corrected. **Fax Model** Also ejects a document remaining in the ADF.
- ② **Fax Model In Use/Memory light**
Blinks or lights during operation. Lights also when there are documents in the machine's memory.
- ③ **Alarm light**
Blinks when an error occurs or when the machine needs attention.
- ④ **[Menu] key**
Accesses the settings to customize operation of your machine.
- ⑤ **LCD**
Displays messages and selections, and prompts during operation.
- ⑥ **[◀]([−]) and [▶]([+]) keys**
Scroll through selections, select the number of copies, and the photograph file number.
Fax Model [◀] also clears an entry and [▶] enters a space between characters.
- ⑦ **[Set] key**
Selects or confirms settings.
- ⑧ **[Enlarge/Reduce] key**
Sets the copy enlargement or reduction ratio.
- ⑨ **[Paper Select] key**
Selects the paper size and paper type for copying and **Fax Model** received faxes.
- ⑩ **[Exposure] key**
Selects the copy exposure and **Fax Model** fax exposure.
- ⑪ **[Image Quality] key**
Selects the copy resolution and **Fax Model** fax resolution.
- ⑫ **[Copy] key**
Switches the machine to copy mode.
- ⑬ **Fax Model [Fax] key**
Switches the machine to fax mode.

- ⑭ **[Scan] key**
Scans a document to your computer according to the action selected.
- ⑮ **[Photo Print] key**
Switches the machine to photo card print mode.
- ⑯ **Numeric keys**
Enter numerical values as well as **Fax Model** fax/telephone numbers and characters.
- ⑰ ****Fax Model** [Tone] key**
Switches temporarily to tone dialing.
- ⑱ **[Color] key**
Sets the machine for color copying and **Fax Model** color sending.
- ⑲ **[Stop/Reset] key**
Cancels operations and returns the machine to standby mode.
- ⑳ **[Start] key**
Starts operations.
- ㉑ **[B&W] key**
Sets the machine for black & white copying and **Fax Model** black & white sending.
- ㉒ ****Fax Model** [Redial/Pause] key**
Redials the last number dialed with the numeric keys. Also enters pauses between or after numbers when dialing or registering numbers.
- ㉓ ****Fax Model** [Coded Dial] key**
Press this key and a two-digit code to dial a pre-registered fax/telephone number or group.
- ㉔ ****Fax Model** [Hook] key**
Engages or disengages the telephone line.
- ㉕ ****Fax Model** One-touch speed dialing keys**
Dial a pre-registered fax/telephone number or group.
- ㉖ **[ON/OFF (1 sec.)] key**
Turns the machine on and off (keep pressed for a brief interval). **Before turning on the machine, make sure the document cover is closed.**

IMPORTANT

- **To prevent the printhead from drying up, the machine automatically caps it when the power is turned off with the [ON/OFF (1 sec.)] key. If you need to disconnect the machine from the main power source (e.g. disconnect the power cord), be sure to turn off the machine first by pressing [ON/OFF (1 sec.)] before disconnecting it.**
- **If you are not using the machine for a long period of time, we recommend that you print (in black and color) or clean the printhead approximately once a month to maintain the printhead in good working condition. The printhead contains high-precision nozzles that will become blocked if the printhead is not used for a long period of time.**

NOTE

- The power cannot be turned off when the machine is operating or **Fax Model** when the In Use/Memory light is on or blinking.
- Your machine performs printhead cleaning every time you turn on the machine. This ensures optimum print quality, but also consumes a small amount of ink during the cleaning process. For this reason, it is recommended that you always leave your machine turned on, and only turn it off when instructed to do so in this guide, or when not using the machine for a long period of time (one month or more). This will avoid unnecessary ink consumption.

Documents and print media

► Documents

Document requirements

The documents you load on the platen glass or **Fax Model** ADF for copying, scanning, or **Fax Model** sending must meet these requirements:

| | Platen glass | Fax Model ADF |
|------------------------|--|---|
| Document type | <ul style="list-style-type: none"> • Special types of paper • Photographs • Book • Fax Model Documents that are not suitable for the ADF. | Multipage documents of the same size, thickness, and weight. |
| Size (W × L) | Max. 8 ½ × 14 in. (216 × 356 mm) Fax Model Max. 8 ½ × 11 ¾ in. (216 × 297 mm) | Max. 8 ½ × 39 in. (216 mm × 1 m) Min. 4 ⅛ × 5 ⅞ in. (105 × 148 mm) |
| Quantity | <ul style="list-style-type: none"> • 1 sheet • 10 photographs for multi-scan | <ul style="list-style-type: none"> • Max. 35 letter- or A4-size sheets (20 lb. or 75 g/m² paper) • Max. 30 legal-size sheets (20 lb. or 75 g/m² paper) • 1 sheet for sizes other than these. |
| Thickness | Max. ¾ in. (20 mm) | 0.002 to 0.005 in. (0.06 to 0.13 mm) |
| Weight | — | 13 to 24 lb. (50 to 90 g/m ²) |

Problem documents

- Make sure any glue, ink, or correction fluid on the document is completely dry before loading.
- Remove all fasteners (staples, paper clips, etc.) before loading.
- **Fax Model** To prevent jams in the ADF, do not use any of the following:
 - Wrinkled or creased paper
 - Curled or rolled paper
 - Torn paper
 - Hole-punched paper
 - Carbon paper or carbon-backed paper
 - Coated paper
 - Onion skin or thin paper

Loading documents

You can load your document on the platen glass or **Fax Model** ADF. Where you load it depends on the type of document and the machine you are using (→ p. 2-1).

Using the platen glass

 **NOTE**

- **Fax Model** Load legal-size documents in the ADF.

Follow this procedure to load your document on the platen glass:

- 1 Lift the document cover.**
- 2 Place your document face down on the platen glass. Align the upper left corner of your document with the alignment mark on the upper left corner of the platen glass.**

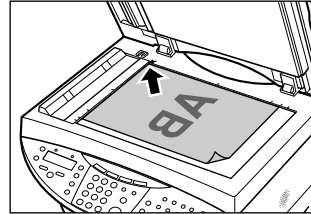

- 3 Gently lower the document cover.**

Fax Model Using the ADF

 **NOTE**

- For clearer scans, use the platen glass.

Follow this procedure to load your document in the ADF:

- 1 Check first that there is no document on the platen glass.**
- 2 Insert the top of your document, face up, into the ADF until you hear a beep ①. Then adjust the document guides to the width of the document ②.**

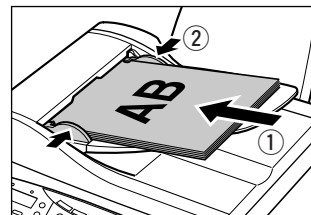

► Print media

Loading requirements

| Print media | Maximum loading quantity | Paper thickness lever position | Printer driver setting ([Media Type]) |
|----------------------------------|---|--------------------------------|---------------------------------------|
| Plain paper | Approx. 150 sheets or Maximum stack height of ½ in. (13 mm) | Left | [Plain Paper] |
| Envelopes | 10 envelopes | Right | [Envelope] |
| High Resolution Paper HR-101N | Approx. 80 sheets or Maximum stack height of ½ in. (13 mm) | Left | [High Resolution Paper] |
| Glossy Photo Paper GP-301/GP301N | 10 sheets | Left | [Glossy Photo Paper] |
| Matte Photo Paper MP-101 | 10 sheets | Left | [Matte Photo Paper] |
| Photo Paper Plus Glossy PP-101 | • Letter, A4: 10 sheets • 4 × 6 in. (101.6 × 152.4 mm): 20 sheets • 5 × 7 in. (127.0 × 177.8 mm): 10 sheets | Left | [Photo Paper Plus Glossy] |
| Photo Paper Pro PR-101 | • Letter, A4: 10 sheets • 4 × 6 in. (101.6 × 152.4 mm): 20 sheets • 5 × 7 in. (127.0 × 177.8 mm): 10 sheets | Left | [Photo Paper Pro] |
| Photo Paper Pro PC-101S | 20 sheets | Left | [Photo Paper Pro] |
| Transparencies CF-102 | 30 sheets | Left | [Transparency] |
| T-Shirt Transfers TR-201 | 1 sheet | Right | [T-Shirt Transfer] |

 **NOTE**

- For detailed description of print media types, refer to the *User's Guide*.

Setting the paper thickness lever

The paper thickness lever adjusts the gap between the printhead and the print media to suit the print media's thickness. Before printing, be sure to set the paper thickness lever.

Follow this procedure to set the paper thickness lever:

1 Press [Open] ① and lift up the scanning unit ②.

- The printhead holder automatically moves to the center of the machine.

⚠ CAUTION

- **Do not try to manually move or stop the printhead holder.**
- **Do not touch any metal parts.**

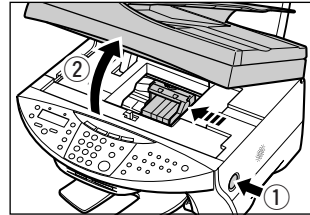

2 Move the paper thickness lever to the appropriate setting.

- For details on which position to set for the print media you are using, see p. 2-2.

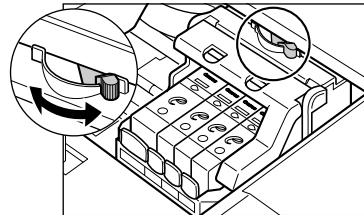

3 Close the scanning unit until it locks into place.

Setting the print media size and type

For copying and **Fax Model** receiving faxes, you need to set the size and type of print media loaded in the multi-purpose tray.

📎 NOTE

- For documents printed from your computer, specify the print media size and type on your computer (→ *Software Guide*).
- For photo printing, specify the print media size as described in Chapter 4.

Follow this procedure to set the print media size and type:

1 Press [Copy] or **Fax Model [Fax].**

2 Press [Paper Select].

Ex:

| | | | |
|--------|---|-------|---|
| SIZE : | < | LTR | > |
| TYPE : | | PLAIN | |

3 Use [◀] or [▶] to select the print media size.

- Select:
 - <LTR> for letter-size print media.
 - <LGL> for legal-size print media.
 - <4" × 6"> for card-size print media.
 - <5" × 7"> for card-size print media.
 - <A4> for A4-size print media.
- **Fax Model** For received faxes, select <LTR>, <LGL>, or <A4>.

4 Press [Set].

Ex:

| | |
|--------|-----------|
| SIZE : | LTR |
| TYPE : | < PLAIN > |

5 Use [◀] or [▶] to select the print media type.

- Select:
 - <PLAIN> for plain paper.
 - <GLOSSY> for glossy photo paper.
 - <H.RES.> for high resolution paper.
 - <TRANS.> for transparencies.
 - <PHOTO> for photo paper pro, photo paper plus glossy, or matte photo paper.

6 Press [Set].

Loading print media

For details on loading print media in the multi-purpose tray, refer to the *Set-Up Sheet* or the *User's Guide*.

Printing from your computer

—Basic operation

▶ Printing documents

The general steps for printing a document are set out below.

- 1 **Load paper in the printer.**
- 2 **Open the application from which you will print the document and select the command to print. (This in most cases will be [Print] in the File menu.)**
To print with the current printer driver settings, click the print button on the Toolbar.

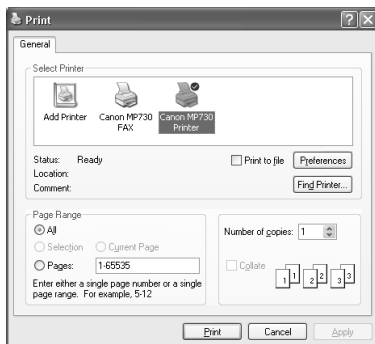

[Print] dialog box

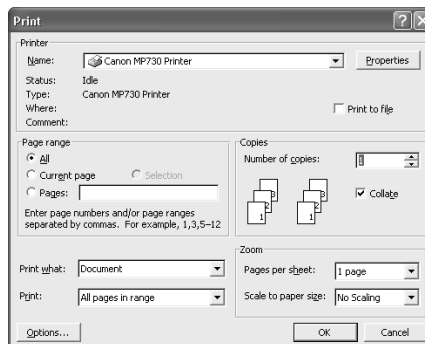

[Print] dialog box in Word

- 3 **In the [Print] dialog box, in [Select Printer] or [Name], select the printer, then click [Preferences] or [Properties].**
- 4 **Specify the required settings, then click [OK] (→ p. 3-2).**
- 5 **Click [Print] or [OK] to begin printing.**

► Setting the paper type and print quality/[Main] tab

In the [Printer Properties] dialog box, on the [Main] tab, you can change settings such as print media type, paper source and print quality.

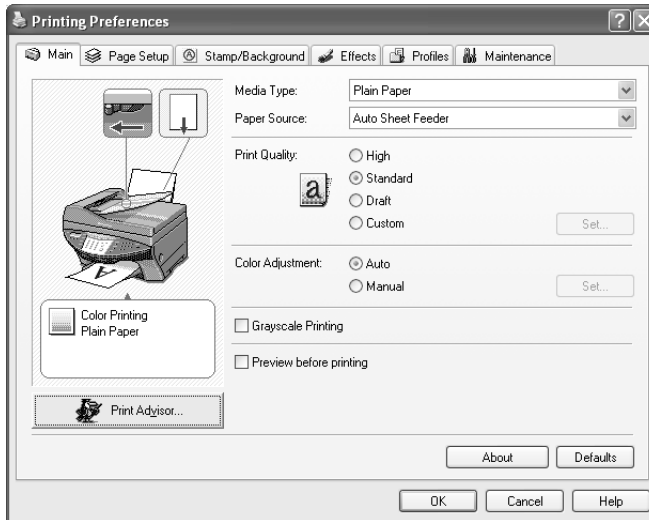

[Main] tab

[Media Type]

Select the print media type (e.g. plain paper) for printing. Depending on the print media you select, the choices available for the other items will change.

[Paper Source]

• **Auto Sheet Feeder**

Display the source from which paper is supplied.

[Print Quality]

Select a print quality suitable for the document to be printed.

• **[High]**

The print quality will be higher but printing speed will be slower.

• **[Standard]**

For average printing speed and quality.

• **[Draft]**

Printing quality will be reduced but the printing speed will be faster. This setting is suitable when printing multiple-page documents or printing drafts of documents.

• **[Custom]**

For selecting image quality and halftone settings individually (→ *Software Guide*).

[Color Adjustment]

Select the color adjustment method for printing.

• **[Auto]**

For automatic color correction by the printer driver.

• **[Manual]**

For adjusting color with detailed specifications (→ *Software Guide*).

[Grayscale Printing]

Select to print a color document in black and white.

[Preview before printing]

Select if you want to display a preview of your document before printing to check how it will print (→ *Software Guide*).

[Print Advisor]

Select to use the Print Advisor to help you configure printer driver settings by answering a series of questions.

The printer illustration at the left of the [Main] tab shows the current settings.

► More information

For detailed information on all printing features, refer to the online help or the *Software Guide*.

Photo printing from a memory card

—Basic operation

This feature allows you to insert a memory card directly into your machine and print photographs from it. You can also read data from and write data to a memory card from your computer.

► Before printing from a memory card

Before printing from a memory card, check the following:

● Is your digital camera's memory card compatible with the machine?

The following cards are compatible with the machine:

- Compact flash type I
- Compact flash type II (Except Microdrive memory cards)
- Memory stick
- Smart media
- Multimedia card
- SD memory card

▲ CAUTION

- You cannot use **Microdrive memory cards**.
- You cannot use **Smart media that has less than 2 MB of memory**.

📝 NOTE

- The above cards are acceptable for this machine. However, due to varying specifications, Canon cannot guarantee that all card brands will be fully compatible.
- The file format is compatible with the JPEG (DCF/Exif 2.2 or lower/JFIF) format.
- Some digital cameras are not compatible with 64 MB and 128 MB memory cards. Photographs on memory cards that are not compatible with the camera may be unreadable or the image data may be damaged.
- Format the memory card with a digital camera. The memory card may not be able to be used with the machine if formatted by a computer.
- For information on memory cards compatible with your digital camera, contact your digital camera manufacturer.
- If you have edited memory card data on your computer, be sure to print this data from your computer. Saving photographs edited on your computer onto a memory card and then printing them from your machine will not produce good results.

● Is the correct print media loaded in the multi-purpose tray?

Although you can use plain paper, Photo Paper Pro paper is recommended for high-quality images (→ p. 2-2).

▶ Inserting/removing a memory card

Inserting a memory card

Follow this procedure to insert a memory card into the machine:

🔔 IMPORTANT

- The machine only recognizes one memory card at a time. Do not insert memory cards into both slots or the same slot at the same time as the machine will not recognize them.
- When switching between memory cards of the same type or inserting a memory card into a different card slot, press [ON/OFF (1 sec.)] to turn off the power before removing the card. Once removed, press [ON/OFF (1 sec.)] again to turn on the power before inserting the other memory card.
- In Windows 2000, if you turn off the machine, the [Unsafe Removal of Device] screen will be displayed. In this case, click [OK]. This will not affect your machine or computer's operation.
- If you insert memory cards into both slots, the compact flash card will be recognized.

1 Make sure the machine is on.

- If not, press [ON/OFF (1 sec.)].

2 Insert a memory card into the appropriate slot.

- The indicator light (A) will blink when the memory card is being accessed.
- Insert the Multimedia card into the same slot as the SD memory card.

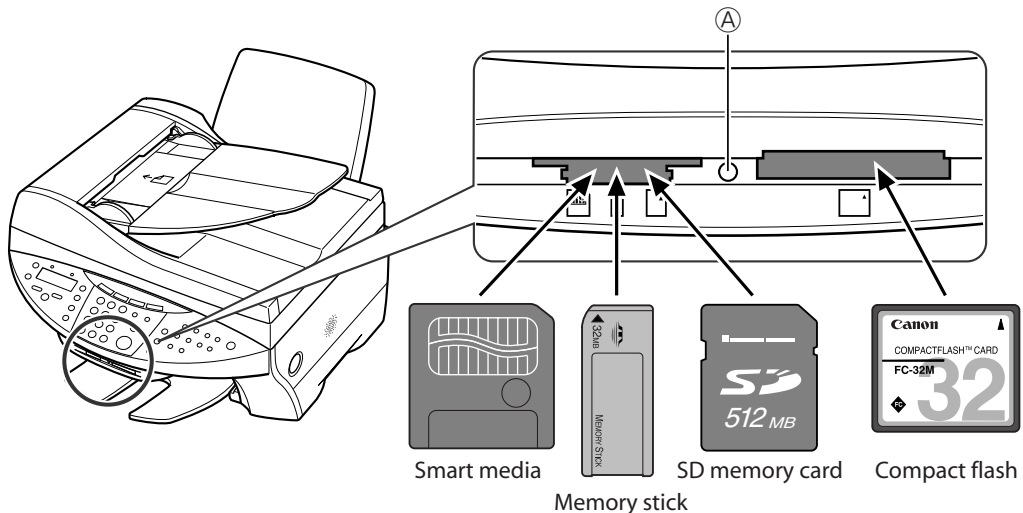

📎 NOTE

- If the memory card cannot be read, check that:
 - the memory card is inserted all the way into the card slot.
 - the memory card was not removed while being read.
 - you are using a compatible memory card.
 - your memory card contains photographs.

Removing a memory card

Follow this procedure to remove a memory card from the machine:

⚠ CAUTION

- Do not remove the memory card or turn off the machine when the indicator light is blinking as this may damage the data in the memory card.

🔔 IMPORTANT

- If an error occurs during printing (e.g. paper runs out), do not remove the memory card as this may damage the data in the memory card.

- 1 Check that the indicator light is not blinking ①, then press [ON/OFF (1 sec.)] to turn the machine off ②.

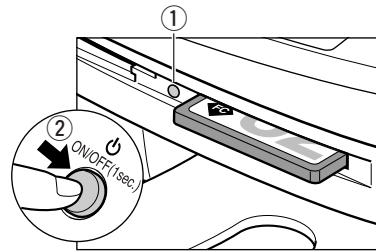

- 2 Remove the memory card.

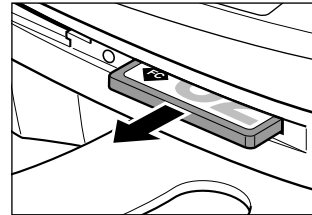

► Printing methods

There are different methods for printing photographs from a memory card. Follow this general procedure to print photographs:

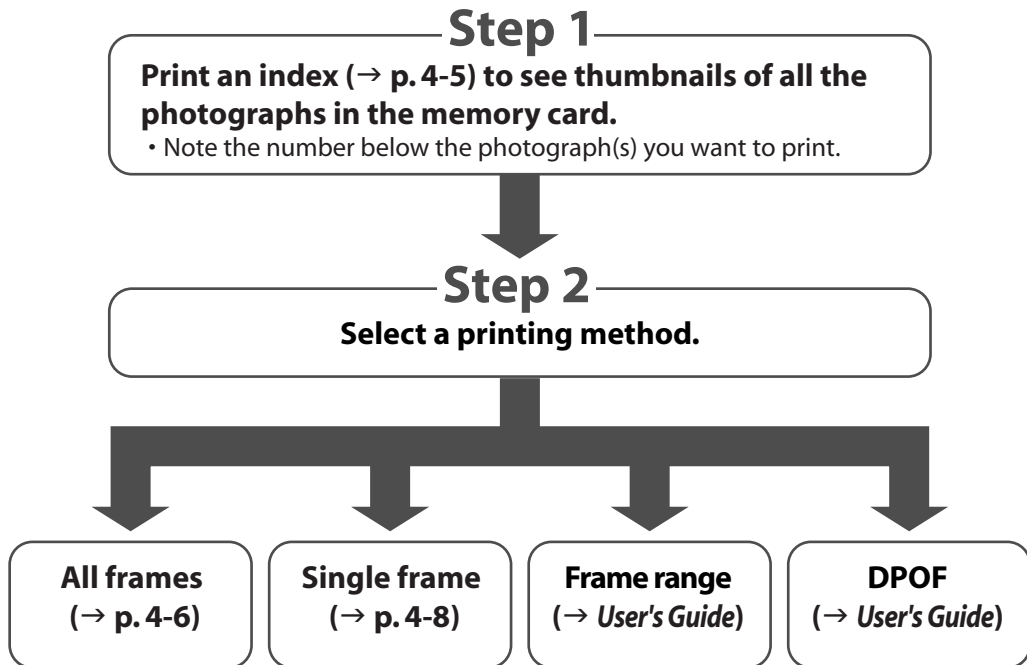

NOTE

- You may not be able to print photographs if their file sizes are too large.
- You can set vivid photo printing to make your photographs appear more vibrant. For details, see the *User's Guide*.
- For each printing method except DPOF, you can set date printing from the machine. For details, see the *User's Guide*.

Printing an index

This printing method prints thumbnails of the photographs in a memory card. An index is useful to see small versions of all photographs in a memory card without having to print each photograph individually.

When you print an index, a number (A) is assigned to each thumbnail. You will need these numbers to select the photographs you want to print in a larger format.

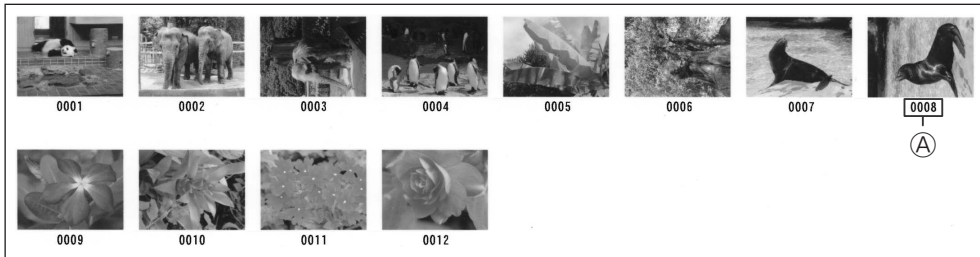

If “?” appears in the index, see p. 10-13.

Follow this procedure to print an index:

1 Load the correct print media in the multi-purpose tray.
• For details on print media, see p. 2-3 and how to load it, see the *Set-Up Sheet* or *User’s Guide*.

2 Insert the memory card as described on p. 4-2.

3 Press [Photo Print].

4 Press [Menu].

5 Press [Set].

Ex:

| |
|------------------|
| PHOTO PRINT MODE |
| INDEX |

6 Use [◀] or [▶] to select <INDEX>.

7 Press [Set].

Ex:

| |
|-------------------|
| SELECT PAPER SIZE |
| LTR |

8 Use [◀] or [▶] to select the print media size.

- Select:
 - <LTR> for letter-size print media.
 - <4" × 6"> for card-size print media.
 - <5" × 7"> for card-size print media.
 - <A4> for A4-size print media.

9 Press [Set].

Ex:

| |
|-------------------|
| SELECT PAPER TYPE |
| PHOTO PAPER PRO |

10 Use [◀] or [▶] to select the print media type.

- Select from the following:
 - <PHOTO PAPER PRO>
 - <PLAIN PAPER>
- If you selected <4" × 6"> or <5" × 7"> in step 8, you can only select <PHOTO PAPER PRO>.

11 Press [Set].

Ex:

| |
|-----------|
| [INDEX] |
| PHOTO LTR |

12 Press [Start].

- To cancel printing, press [Stop/Reset].

NOTE

- You can only print one index at a time.
- The number assigned to each thumbnail on the index is different from the ID numbers assigned by the digital camera.

Printing all frames

This printing method prints individually all photographs stored in a memory card.



Follow this procedure to print individually all photographs in a memory card:

1 Load the correct print media in the multi-purpose tray.

- For details on print media, see p. 2-3 and how to load it, see the *Set-Up Sheet* or *User's Guide*.

2 Insert the memory card as described on p. 4-2.

3 Press [Photo Print].

4 Press [Menu].

5 Press [Set].

Ex:

| |
|------------------|
| PHOTO PRINT MODE |
| INDEX |

6 Use [◀] or [▶] to select <ALL FRAMES>.

7 Press [Set].

Ex:

| |
|-------------------|
| SELECT PAPER SIZE |
| LTR |

8 Use [◀] or [▶] to select the print media size.

- Select:
 - <LTR> for letter-size print media.
 - <4" × 6"> for card-size print media.
 - <5" × 7"> for card-size print media.
 - <A4> for A4-size print media.

9 Press [Set].

Ex:

| |
|--------------------------------------|
| SELECT PAPER TYPE PHOTO PAPER PRO |
|--------------------------------------|

10 Use [◀] or [▶] to select the print media type.

- Select from the following:
 - <PHOTO PAPER PRO>
 - <PLAIN PAPER>
- If you selected <4" × 6"> or <5" × 7"> in step 8, you can only select <PHOTO PAPER PRO>.

● If you selected <PLAIN PAPER> in step 10:**11 Go to step 13.****● If you selected <PHOTO PAPER PRO> in step 10:****11 Press [Set].**

Ex:

| |
|-------------------------|
| BORDERLESS PRINT OFF |
|-------------------------|

12 Use [◀] or [▶] to select borderless printing.

- Select:
 - <OFF> to print the photographs with borders.
 - <ON> to print the photographs without borders.

13 Press [Set].

Ex:

| |
|-----------------------------|
| [ALL FRAMES] PHOTO LTR |
|-----------------------------|

14 Press [Start].** NOTE**

- Printing is enlarged or reduced automatically according the print media size. Depending on the print media type and whether borderless printing is selected, the photographs may be cropped.
- A margin may still appear even if you select borderless printing on letter-size print media.
- You can select the width cropped from the borders of the original image (→ <EXTENSION AMOUNT>, *User's Guide*).

Printing a single frame

This printing method prints a specified single photograph from a memory card. In order to select the photograph you want to print, you will need to print the index and note the number assigned to the photograph. To print an index, see p. 4-5.



Without a border



With a border

Follow this procedure to print a single photograph from a memory card:

1 Load the correct print media in the multi-purpose tray.

- For details on print media, see p. 2-3 and how to load it, see the *Set-Up Sheet* or *User's Guide*.

2 Insert the memory card as described on p. 4-2.

3 Press [Photo Print].

4 Press [Menu].

5 Press [Set].

Ex:

| |
|---------------------------|
| PHOTO PRINT MODE INDEX |
|---------------------------|

6 Use [◀] or [▶] to select <SINGLE FRAME>.

7 Press [Set].

| |
|------------------|
| FILE NO: 0001 |
|------------------|

8 Use the numeric keys to enter the frame number.

- You can also use [◀] or [▶] to select the frame number.
- To find the frame number, you will need to print the index beforehand (→ p. 4-5).

9 Press [Set].

| |
|-----------------------------|
| NUMBER OF PRINTS 1COPIES |
|-----------------------------|

10 Use the numeric keys to enter the number of copies of the photograph you want.

- You can also use [◀] or [▶] to select the quantity.

11 Press [Set].

Ex:

| |
|--------------------------|
| SELECT PAPER SIZE LTR |
|--------------------------|

12 Use [◀] or [▶] to select the print media size.

- Select:
 - <LTR> for letter-size print media.
 - <4" × 6"> for card-size print media.
 - <5" × 7"> for card-size print media.
 - <A4> for A4-size print media.

13 Press [Set].

Ex:

| |
|--------------------------------------|
| SELECT PAPER TYPE PHOTO PAPER PRO |
|--------------------------------------|

14 Use [◀] or [▶] to select the print media type.

- Select from the following:
 - <PHOTO PAPER PRO>
 - <PLAIN PAPER>
- If you selected <4" × 6"> or <5" × 7"> in step 12, you can only select <PHOTO PAPER PRO>.

● If you selected <PLAIN PAPER> in step 14:**15 Go to step 17.****● If you selected <PHOTO PAPER PRO> in step 14:****15 Press [Set].**

Ex:

| |
|-------------------------|
| BORDERLESS PRINT OFF |
|-------------------------|

16 Use [◀] or [▶] to select borderless printing.

- Select:
 - <OFF> to print the photograph with a border.
 - <ON> to print the photograph without a border.

17 Press [Set].

- Use [◀] or [▶] to view your settings in the LCD.

Ex:

| |
|-------------------------------|
| 【 SINGLE FRAME 】 PHOTO LTR |
|-------------------------------|

 or

| |
|--|
| 【 SINGLE FRAME 】 ◀ NO. 0002 01 |
|--|

18 Press [Start]. **NOTE**

- Printing is enlarged or reduced automatically according the print media size. Depending on the print media type and whether borderless printing is selected, the photograph may be cropped.
- A margin may still appear even if you select borderless printing on letter-size print media.
- You can select the width cropped from the borders of the original image (→ <EXTENSION AMOUNT>, *User's Guide*).

► Reading data from or writing data to a memory card

When your machine is connected to a computer, the memory card drive (Removable Disk) will appear on your computer's [My Computer].

By inserting a memory card in the machine, you can view photographs on the memory card by opening the [Removable Disk] on your computer. You can then copy the photographs to your computer's hard disk (similar to copying other files on the hard disk), or by changing the setting, can copy hard disk files onto the memory card.

🔔 IMPORTANT

- **Do not put your computer in standby or sleep mode when a memory card is inserted in a card slot. Also, do not remove or switch memory cards when your computer is in standby or sleep mode.**
- **Insert only one memory card at a time into the machine.**
- **When switching between memory cards of the same type or inserting a memory card into a different card slot, press [ON/OFF (1 sec.)] to turn off the power before removing the card. Once removed, press [ON/OFF (1 sec.)] again to turn on the power before inserting the other memory card.**
- In Windows 2000, if you turn off the machine, the [Unsafe Removal of Device] screen will be displayed. In this case, click [OK]. This will not affect your machine or computer's operation.
- If you insert memory cards into both slots, the compact flash card will be recognized.

Enabling/disabling overwriting memory card data

You can enable or disable overwriting memory card data. This setting is initially set to disable overwriting.

Follow this procedure to change the setting:

- 1 Make sure there is no memory card inserted in the machine.**
- 2 Press [Menu].**
- 3 Use [◀] or [▶] to select <USER DATA>.**
- 4 Press [Set].**



```
USER DATA
1. TEL REGISTRATION
```

- 5 Use [◀] or [▶] to select <SYSTEM SETTINGS>.**
- 6 Press [Set].**
- 7 Use [◀] or [▶] to select <CARD PROTECT>.**
- 8 Press [Set].**



```
CARD PROTECT
ON
```

- 9 Use [◀] or [▶] to select <ON> to disable overwriting or <OFF> to enable overwriting.**
- 10 Press [Set].**
- 11 Press [Stop/Reset] to return to standby mode.**

12 Press [Copy], [Fax], or [Scan] to select a mode other than photo print mode.

- To avoid damage to data being accessed on a memory card, you cannot overwrite data in photo print mode.

13 Insert a memory card into the appropriate slot.

🔔 IMPORTANT

- **If you change the above setting while a memory card is inserted in a card slot, turn the machine off then on again. The new setting will not be activated until you do so.**

▶ More information

For detailed information on all photo printing features, refer to the *User's Guide*.

Copying

—Basic operation

► Before copying

Before copying, check the following:

- **Does the document you want to copy meet the requirements for loading on the platen glass or **Fax Model** ADF?**
For details, see p. 2-1.
- **Is the correct print media loaded in the multi-purpose tray?**
For details, see p. 2-4.

► Making copies

Follow this procedure to make color or black & white copies:

- 1 Load the document on the platen glass or **Fax Model** ADF.**
 - For details on how to load documents, see p. 2-2.
- 2 Press [Copy].**
- 3 Use the numeric keys to enter the number of copies.**
- 4 Adjust any necessary settings for your document.**
 - Press [Color] for color copying, or [B&W] for black & white copying (→ below).
 - Press [Paper Select] to select the print media size and type (→ p. 2-4).
 - Press [Image Quality] to select the scanning resolution (→ p. 5-2).
 - Press [Exposure] to select the scanning exposure (→ p. 5-2).
 - Press [Enlarge/Reduce] to select the copy ratio (→ *User's Guide*).
- 5 Press [Start].**
 - To cancel copying, press [Stop/Reset].

► Improving copied images

Setting color or black & white copying

Refer to *Making copies* above and in step 4, set color or black & white copying as follows:

For color copying: Press [Color] to turn on its light.

For black & white copying: Press [B&W] to turn on its light.

Adjusting the image quality (resolution)

Refer to *Making copies* on p. 5-1 and in step 4, adjust the image quality as follows:

1 Press [Image Quality].

2 Use [◀] or [▶] to select the image quality.

- In black & white mode, select:
 - <B&W TEXT> for text-only documents.
 - <B&W PHOTO> for photographs.
 - <B&W DRAFT> for high-speed copying at a lower resolution.*
- In color mode, select:
 - <COLOR NORMAL> for color text-only documents.**
 - <COLOR FINE> for color photographs.
 - <COLOR FAST> for high-speed color copying at a lower resolution.*

3 Press [Set].

NOTE

- When using <COLOR FAST>, if the color output is different from that expected, select <COLOR NORMAL> or <COLOR FINE> and try copying again.

Adjusting the exposure (density)

Exposure (density) is the degree of difference between light and dark. A high exposure setting will make blacks darker and whites brighter, whereas a low exposure setting will make the differences between black and white less marked.

Refer to *Making copies* on p. 5-1 and in step 4, adjust the exposure as follows:

1 Press [Exposure].

2 Use [◀] or [▶] to select the exposure.

3 Press [Set].

More information

For detailed information on all copying features, refer to the *User's Guide*.

* This setting is only available when <PLAIN> is selected as the print media type (→ p. 2-4).

** This setting is not available when <GLOSSY> or <PHOTO> is selected as the print media type (→ p. 2-4).

PC Faxing

—Basic operation

► Sending a fax

With the fax driver, you can send documents created in applications that support document printing.

You can only send to one recipient at a time.

- 1 With the document you want to fax open in an application (such as Word), click the Print command. (In most Windows applications, the command is [Print] on the File menu.)**

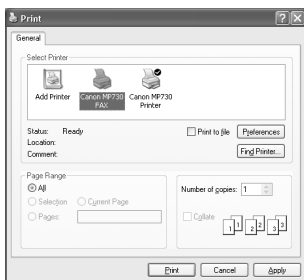

[Print] dialog box

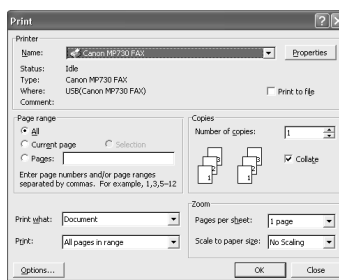

[Print] dialog box in Word

- 2 In the [Print] dialog box, in the [Select Printer] or [Name] list, select [Canon MP730 FAX], then click [Print] or [OK].**

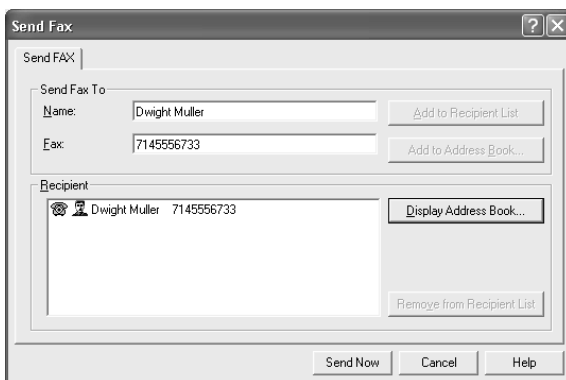

[Send Fax] dialog box

- 3 In the [Send Fax] dialog box, enter the [Name] and [Fax] of the recipient, then click [Add to Recipient List].**
 - You can also send by just entering the [Fax] of the recipient.
 - You can only enter one recipient.
 - You can use 0 through 9, dash (-), and parentheses () etc. in fax numbers (→ below).
 - You can specify a recipient from the Address Book (→ *Software Guide*).
 - If you register a recipient in the Address Book, you can use the information the next time you send a fax to the same recipient (→ *Software Guide*).
- 4 Click [Send Now].**

Characters and symbols for fax numbers

You can use the following characters and symbols in the faxes you send from your computer or for a recipient you register in the Address Book.

| Character/symbol | Explanation |
|------------------|--|
| 0–9 * # | For use in telephone and fax numbers. |
| , p | To place a pause between numbers. |
| P | To place a pause at the end of an array of numbers. |
| T | Numbers after the T will be sent as a tone signal. |
| + - (), space | To make the number easier to read. You cannot insert a space at the front of a number. |

► More information

For detailed information on all faxing features that can be performed from your computer, refer to the online help or the *Software Guide*.

Faxing with your machine

—Basic operation

► Sending faxes from your machine

Before sending faxes

Before sending faxes from your machine, check the following:

- **Does the document you want to send meet the requirements for loading on the platen glass or ADF?**

For details, see p. 2-1.

- **Have you entered the sender information?**

Before sending faxes, you must register the date and time, your name and fax/telephone number so that they are printed at the top of faxes you send. For more details on what sender information is, see the *User's Guide*.

Follow this procedure to enter the sender information:

- 1 Press [Menu].
- 2 Use [◀] or [▶] to select <USER DATA>.
- 3 Press [Set].

```
USER DATA
1.TEL REGISTRATION
```

- 4 Use [◀] or [▶] to select <FAX SETTINGS>.
- 5 Press [Set] three times.

```
DATE & TIME
12/27/2003 15:10
```

- 6 Use the numeric keys to enter the date (month/day/year) and time (in 24-hour format).
 - Enter only the last two digits of the year.

- 7 Press [Set].

```
USER SETTINGS
2.DATE SETUP
```

- 8 Use [◀] or [▶] to select <UNIT TELEPHONE #>.

9 Press [Set].

```
UNIT TELEPHONE #  
TEL=
```

10 Use the numeric keys to enter your fax/telephone number (max. 20 digits, including spaces).

- To enter a plus sign (+) before the number, press [#].

11 Press [Set] twice.

```
UNIT NAME          : A  
_
```

12 Use the numeric keys to enter your name (max. 24 characters, including spaces).

| Key | Letters | Number |
|-----|---------------------------------|--------|
| [1] | | 1 |
| [2] | ABCabc | 2 |
| [3] | DEFdef | 3 |
| [4] | GHIghi | 4 |
| [5] | JKLjkl | 5 |
| [6] | MNOmno | 6 |
| [7] | PQRSpqrs | 7 |
| [8] | TUVtuv | 8 |
| [9] | WXYZwxyz | 9 |
| [0] | | 0 |
| [#] | -.*#!";:~^`_=/ '?\$@%&+()[]{}<> | |

[*] switches between letter mode (:A), and number mode (:1).

- **To enter a space:** Press [▶].
- **To delete a character:** Press [◀].
- **To delete an entire entry:** Press and hold [◀].

13 Press [Set].

14 Press [Stop/Reset].

● Have you set the correct telephone line type?

Before using your machine, make sure you have set the correct telephone line type for your telephone line. If you are unsure of your telephone line type, contact your telephone company.

NOTE

- You can print the USER'S DATA LIST to check the current setting (→ *User's Guide*).

Follow this procedure to set the telephone line type:

- 1 Press [Menu].
- 2 Use [◀] or [▶] to select <USER DATA>.
- 3 Press [Set].

USER DATA
1.TEL REGISTRATION

- 4 Use [◀] or [▶] to select <FAX SETTINGS>.
- 5 Press [Set] twice.

USER SETTINGS
1.DATE & TIME

- 6 Use [◀] or [▶] to select <TEL LINE TYPE>.
- 7 Press [Set].

Ex: TEL LINE TYPE
TOUCH TONE

- 8 Use [◀] or [▶] to select the telephone line type.
 - Select:
 - <TOUCH TONE> for tone dialing.
 - <ROTARY PULSE> for pulse dialing.
- 9 Press [Set].
- 10 Press [Stop/Reset].

Sending methods

There are two methods of sending faxes from your machine:

- Memory sending (→ below)
- Manual sending (→ *User's Guide*)

Memory sending

You should normally use memory sending to send documents fast and efficiently.

Follow this procedure for memory sending:

- 1 **Load the document on the platen glass or ADF.**
 - For details on how to load documents, see p. 2-1.
- 2 Press [Fax].
- 3 Press [Color] for color sending, or [B&W] for black & white sending.
- 4 Press [Image Quality].

5 Use [◀] or [▶] to select the resolution.

- In black & white mode, select:
 - <B&W STANDARD> for text-only documents.
 - <B&W FINE> for fine-print documents.
 - <B&W PHOTO> for photographs.
- In color mode select:
 - <COLOR STANDARD> for normal color documents.
 - <COLOR FINE> for fine color documents.

6 Press [Set].

7 Press [Exposure].

8 Use [◀] or [▶] to select the exposure.

9 Press [Set].

10 Dial the recipient's number.

- For details on the different dialing methods, see the *User's Guide*.

11 Press [Start].

If you are using the platen glass, you will be prompted when the page has been scanned. Load the next page (for a multipage document) and press [Start]. To start sending, press [Set].

To cancel memory sending: Press [Stop/Reset] and follow any instructions in the LCD.

Speed dialing

You can simplify dialing of fax/telephone numbers by registering numbers under speed dialing keys or codes.

Registering one-touch speed dialing

Before you can use one-touch speed dialing (→ p. 7-6), you need to register the recipients' numbers. Follow this procedure:

1 Press [Menu].

2 Use [◀] or [▶] to select <USER DATA>.

3 Press [Set] three times.

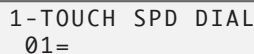

1-TOUCH SPD DIAL
01=

4 Use [◀] or [▶] to select a one-touch speed dialing key (01 to 10).

- You can also select a key by pressing the one-touch speed dialing key.

5 Press [Set] twice.



TELEPHONE NUMBER
TEL= _

6 Use the numeric keys to enter the fax/telephone number you want to register (max. 120 digits, including spaces and pauses).

- For details on how to enter or delete numbers, see p. 7-2.

7 Press [Set] twice.

NAME : A
_

8 Use the numeric keys to enter a name for the one-touch speed dialing key (max. 16 characters, including spaces).

- For details on how to enter or delete characters, see p. 7-2.

9 Press [Set].

10 To continue registering one-touch speed dialing keys, repeat the procedure from step 4.

-or-

Press [Stop/Reset] to return to standby mode.

 **NOTE**

- Use the destination labels provided with your machine to label the one-touch speed dialing keys with the recipients' names.
- For a list of the recipients you have registered, print the one-touch speed dialing list (→ *User's Guide*).

To change or delete an entry: Refer to the *User's Guide*.

Registering coded speed dialing

Before you can use coded speed dialing (→ p. 7-6), you need to register the recipients' numbers. Follow this procedure:

1 Press [Menu].

2 Use [◀] or [▶] to select <USER DATA>.

3 Press [Set] twice.

TEL REGISTRATION
1.1-TOUCH SPD DIAL

4 Use [◀] or [▶] to select <CODED SPEED DIAL>.

5 Press [Set].

CODED SPEED DIAL
*00=

6 Use [◀] or [▶] to select a coded speed dialing code (00 to 99).

- You can also select a code by pressing [Coded Dial] and then using the numeric keys to enter a two-digit code.

7 Press [Set] twice.

TELEPHONE NUMBER
TEL=_

8 Use the numeric keys to enter the fax/telephone number you want to register (max. 120 digits, including spaces and pauses).

- For details on how to enter or delete numbers, see p. 7-2.

9 Press [Set] twice.



10 Use the numeric keys to enter a name for the coded speed dialing code (max. 16 characters, including spaces).

- For details on how to enter or delete characters, see p. 7-2.

11 Press [Set].

**12 To continue registering coded speed dialing codes, repeat the procedure from step 6.
-or-
Press [Stop/Reset] to return to standby mode.**

 **NOTE**

- For a list of the recipients you have registered, print the coded speed dialing list (→ *User's Guide*).

To change or delete an entry: Refer to the *User's Guide*.

Using speed dialing

Follow this procedure to dial speed dialing number:

● **One-touch speed dialing:**

- 1** Press the one-touch speed dialing key assigned to the number you want to dial (01 to 10).



● **Coded speed dialing:**

- 1** Press [Coded Dial].



- 2** Use the numeric keys to enter the two-digit code assigned to the number you want to dial (00 to 99).

If you use speed dialing to send a fax, press [Start] after dialing, or wait a few seconds for the machine to automatically begin scanning your document for sending. If you do not want the machine to begin scanning automatically, disable the <TIME OUT> setting (→ *User's Guide*).

► Receiving faxes to your machine

Before receiving faxes to your machine

Before receiving faxes, check the following:

● Is the power turned on?

You cannot receive faxes if the power is turned off.

● Is the correct paper loaded in the multi-purpose tray?

Load plain paper in the multi-purpose tray. For details, see the *Set-Up sheet* or *User's Guide*.

● Have you set the paper size setting?

Before receiving faxes, you must set the paper size setting for the paper loaded in the multi-purpose tray. For details, see p. 2-4.

● Have you set the receive mode?

Before using your machine to receive faxes, you need to set the receive mode according to how you plan to use your machine.

Follow this procedure to set the receive mode:

1 Press [Fax].

2 Press [Menu].

3 Press [Set].



RECEIVE MODE
FAX/TEL AUTO SW

4 Use [◀] or [▶] to select the receive mode:

- Select:
 - <FAX/TEL AUTO SW> to automatically switch between fax and voice calls. Faxes will be received automatically, and the machine will ring for voice calls.
 - <FAX ONLY MODE> to automatically receive faxes only. Voice calls will be disconnected.
 - <DRPD> if you have subscribed to a DRP (Distinctive Ring Pattern) service offered by some companies.
 - <MANUAL MODE> for the machine to ring for fax and voice calls. Fax calls must be answered manually.
 - <ANS.MACHINE MODE> to receive faxes automatically and route voice calls to an answering machine connected to your machine.

5 Press [Set].

- The receive mode will be displayed on the bottom left of the LCD.

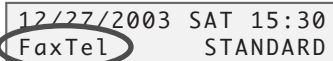

12/27/2003 SAT 15:30
FaxTel STANDARD

● Have you connected the external devices correctly?

Depending on how you plan to use your machine, you may need to connect an external device to it. For details on the different connection combinations, refer to the *Set-Up Sheet*.

Receiving faxes manually

If you have set <MANUAL MODE>, follow this procedure to receive a fax manually:

- 1** Make sure you have set <MANUAL MODE> (→ p. 7-7).
- 2** Make sure you have connected a telephone to your machine (→ *Set-Up Sheet*).
- 3** When the telephone rings, pick up the handset.
- 4**
 - **If you hear a person's voice:**
Start your conversation. If the caller wants to send a fax after talking to you, ask them to perform the operation to begin sending. When you hear a slow beep tone, press [Start] on your machine to begin receiving the fax. Hang up the handset.
 - **If you hear a slow beep tone or silence:**
Someone is trying to send you a fax. If your telephone is close to your machine, press [Start] on the machine to begin receiving the fax. Hang up the handset. If you are far from your machine, dial 25 (the remote receiving ID) on your telephone and hang up.

NOTE

- You can customize remote receiving by enabling/disabling it, or by changing the remote receiving ID (→ <REMOTE RX>, p. 11-5).
- If you have an answering machine connected to your machine that can carry out remote-control operations (controlling your answering machine from a remote telephone), the security code for this function may be the same as the remote receiving ID. If so, make sure you change the machine's remote receiving ID to make it distinct from the answering machine's security code (→ <REMOTE RX ID>, p. 11-5).

Canceling receiving

Press [Stop/Reset] and follow any instructions in the LCD.

More information

For detailed information on all faxing features that can be performed directly from your machine, refer to the *User's Guide*.

Scanning

—Basic operation

► Scanning methods

There are three methods of scanning images to your computer:

- Using the MP Toolbox
- Using a TWAIN- or WIA- (Windows XP) compliant Windows application
- Using the [Scan] key on the operation panel

This section explains how to scan using the [Scan] key on the operation panel.

Using the [Scan] key on the operation panel

By pressing the [Scan] key on the machine, you can scan documents to your computer. Pressing the [Scan] key has the same effect as clicking the [Save] key in the MP Toolbox.

1 Load the document on the platen glass or **FaxModel** ADF.

- For details on how to load documents, see p. 2-2.

2 Press the [Scan] key on the operation panel.

The document will be scanned.

The MP Toolbox and the MP Toolbox settings dialog box will open but the document will scan without you having to click [Scan].

Your document will be processed according to your settings.

When you use the [Scan] key for the first time, a folder with the scanning date will be created in the [My Pictures] folder in the [My Documents] folder, and your document will be saved in this folder. If there is no [My Pictures] folder, the folder with the scanning date will be created in the [My Documents] folder and your document saved in this folder.

► More information

For detailed information on all scanning features, refer to the online help or the *Software Guide*.

Maintenance

► Replacing ink tanks

When to replace an ink tank

If one of the following messages appears in the LCD, replace the necessary ink tank(s) as described on p. 9-2:

<C INK EMPTY>Cyan ink tank empty

<M INK EMPTY>Magenta ink tank empty

<Y INK EMPTY>Yellow ink tank empty

<Bk INK EMPTY>Black ink tank empty

If more than one ink tank is empty, several letters may appear (e.g. <C Y INK EMPTY>).

If no message appears but print quality is below standard, refer to the flow chart to determine the problem (→ p. 9-3).

Guidelines

⚠ CAUTION

- **Keep the printhead and ink tanks out of the reach of children. If a child inadvertently ingests ink, consult a physician immediately.**
- **Damage caused by using refilled ink tanks is not covered by Canon's warranty. To ensure optimum printing results and to avoid printing problems, Canon recommends using original Canon ink tank only.**
- Ink tanks compatible with the machine are as follows:
 - Black ink tank: BCI-3eBK – Cyan ink tank: BCI-3eC
 - Magenta ink tank: BCI-3eM – Yellow ink tank: BCI-3eY
- Replaced ink tanks should be new. If you install partially used ink tanks, the nozzles may block and the ink tank replacement warning may not be accurate.
- For best ink quality, use ink tanks within one year of purchase. After placing ink tanks in the machine, use the ink tanks within six months.
- Do not open the ink tank packaging until ready to install.
- Do not touch printed paper with wet hands or spill liquids on it as the ink may run.
- Replace ink tanks quickly and do not leave them out in the open. Doing so may cause the ink tank not to function properly when reinstalled in the machine.

Replacing an ink tank

This section describes how to replace an ink tank. Before replacing an ink tank, be sure to read the section *When to replace an ink tank* (→ p. 9-1).

⚠ CAUTION

- Do not replace ink tanks while the machine is printing or performing another operation.

Follow this procedure to replace an ink tank:

- 1 Make sure the power is turned on.
- 2 Press [Open] ① and lift up the scanning unit ②.

- The printhead holder automatically moves to the center of the machine.

⚠ CAUTION

- Do not try to manually move or stop the printhead holder.
- Do not touch any metal parts.

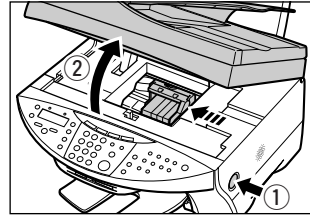

- 3 Press on the tab to release the empty ink tank ①, then remove it from its slot ②.

⚠ CAUTION

- Do not remove the printhead from the machine.
- If several ink tanks need replacing, remove and replace each one individually.

👏 IMPORTANT

- Discard the empty ink tank immediately according to local laws and regulations for disposal of consumables.
- Handle ink tanks carefully to avoid staining clothing or the surrounding area.

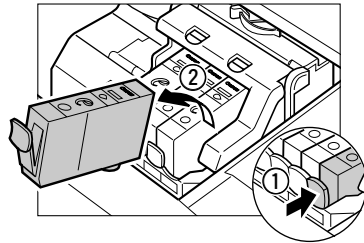

- 4 On the new ink tank, pull the orange tape in the direction of the arrow and remove the plastic wrapper so you can see the air hole ①. Turn the ink tank over so that the protective cap ② is facing up. Then hold the ink tank as shown and remove the protective cap ②.

- To avoid spilling ink, never press on the long sides of the ink tank ③.
- Once you remove the cap ②, do not touch the ink port ④.

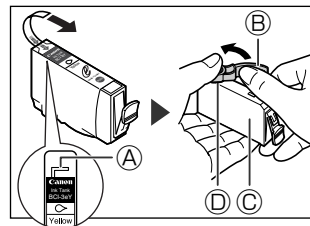

- 5 Insert the ink tank into the empty slot on the printhead. Press down gently on the ink tank until an audible click is heard.

- Make sure the ink tank is the correct color for the slot.

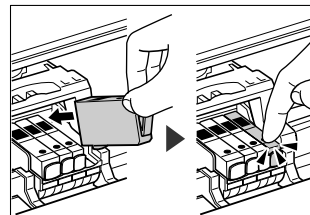

- 6 Close the scanning unit until it locks into place.

► Maintaining the printhead

NOTE

- Before doing the following, open the scanning unit, press "PUSH" on the ink tanks and check that they are securely inserted. Check how much ink is left and if there is none, replace the ink tank (→ p. 9-1).

Flowchart of printhead maintenance

If print quality deteriorates, follow this procedure:

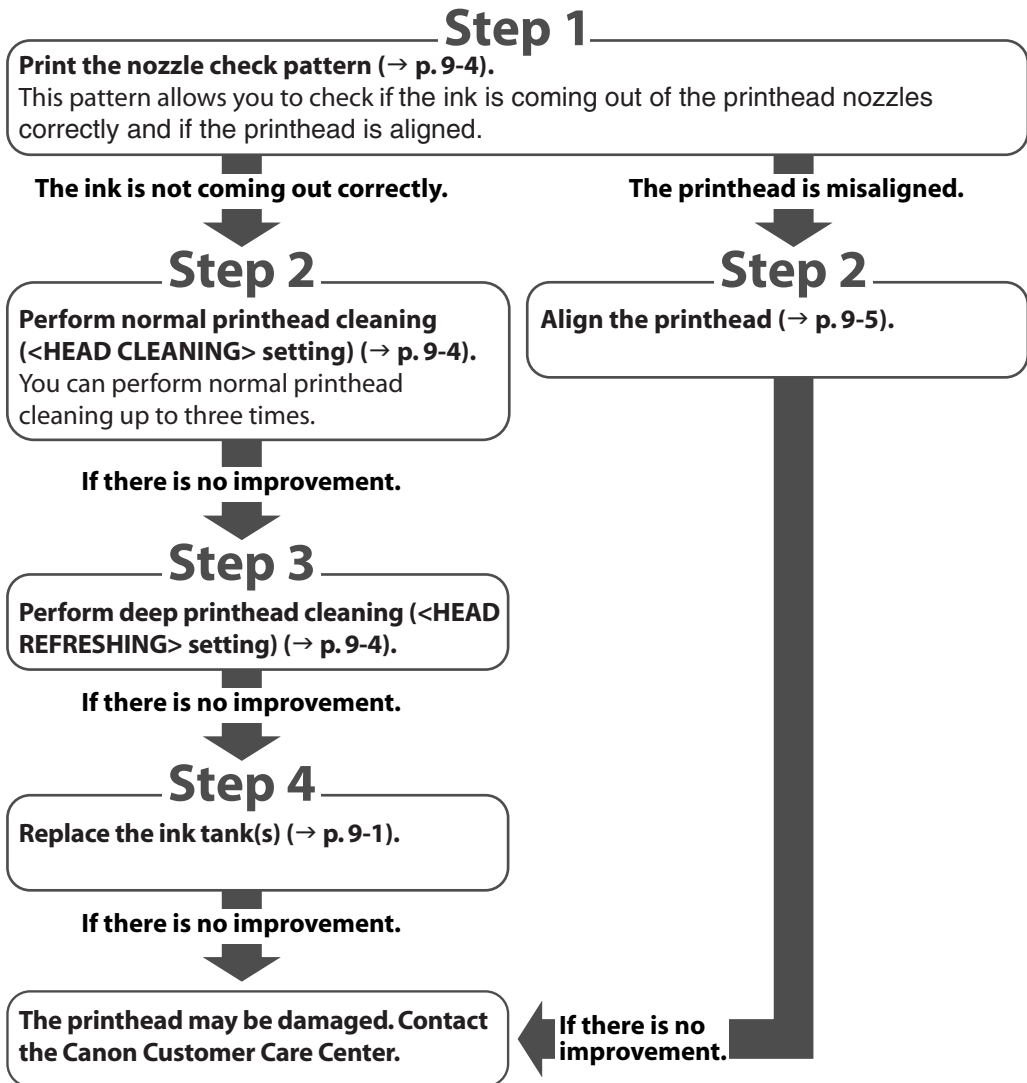

Printing the nozzle check pattern

The nozzle check pattern shows if each printhead nozzle is operating properly.

NOTE

- You can also print the nozzle check pattern from your computer (→ *Software Guide*).

Follow this procedure to print the nozzle check pattern from the machine:

- 1 Load letter-size plain paper in the multi-purpose tray.**
- 2 Press [Menu].**
- 3 Use [◀] or [▶] to select <MAINTENANCE>.**
- 4 Press [Set] twice.**

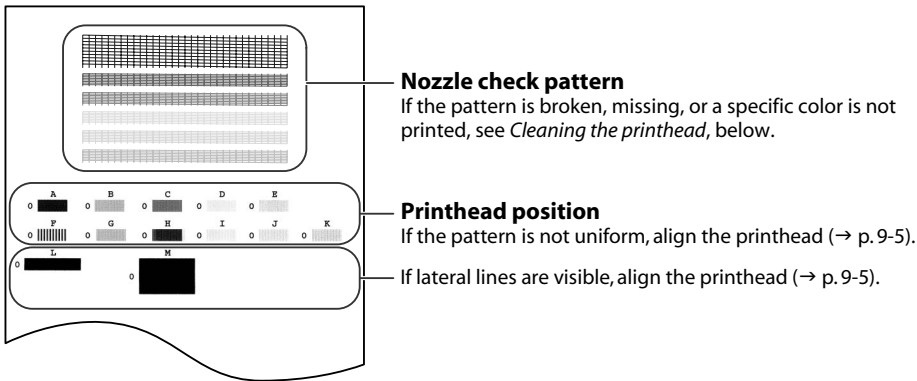

Cleaning the printhead

If the printed nozzle check pattern is broken, missing, or a specific color is not printed, clean the printhead.

NOTE

- Cleaning the printhead consumes a small amount of ink. Cleaning too often reduces the amount of ink in the ink tanks.
- You can also clean the printhead from your computer (→ *Software Guide*).

Follow this procedure to clean the printhead from the machine:

- 1 Press [Menu].**
- 2 Use [◀] or [▶] to select <MAINTENANCE>.**
- 3 Press [Set].**

```
MAINTENANCE
1. NOZZLE CHECK
```

- 4 Use [◀] or [▶] to select the cleaning setting you want.**
 - Select:
 - <HEAD CLEANING> for normal printhead cleaning.
 - <HEAD REFRESHING> for deep printhead cleaning.
 - For details on which to select, see p. 9-3.
- 5 Press [Set].**

Aligning the printhead

To align the printhead after you have just installed it, follow the procedure in the Set-Up Sheet. If you have printed the nozzle check pattern (→ p. 9-4) and determined that the printhead needs aligning, align it from the operation panel (→ below) or from the software (→ *Software Guide*).

Follow this procedure to align the printhead from the operation panel:

- 1 Load letter-size plain paper in the multi-purpose tray.**
- 2 Press [Menu].**
- 3 Use [◀] or [▶] to select <MAINTENANCE>.**
- 4 Press [Set].**

```
MAINTENANCE
1.NOZZLE CHECK
```

- 5 Use [◀] or [▶] to select <ALIGN PRINT HEAD>.**

- 6 Press [Set].**
 - The machine prints a horizontal pattern.

```
CHANGE H VALUE
A 0
```

- 7 In column A on the printout, note which box has the most solid image. Note the value next to this box and use [◀] or [▶] to enter it.**



- 8 Press [Set].**
- 9 Repeat steps 7 and 8 for columns B to K.**
When all values have been entered, the LCD displays the following:

```
PRINT VERT. PATTERN?
YES=(*) NO=(#)
```

- 10 Press [✱].**

- 11** When the horizontal pattern has been adjusted, the machine will print a vertical pattern.
- 12** In column L on the printout, note which box has the most solid image. Note the value next to this box and use [◀] or [▶] to enter it.

| |
|----------------|
| CHANGE V VALUE |
| L 0 |

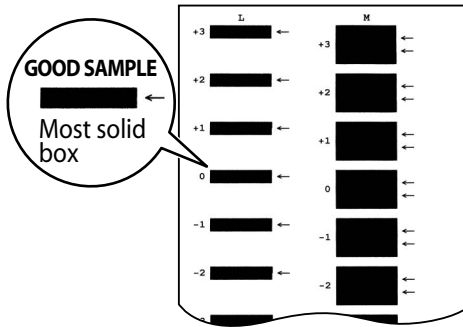

- 13** Press [Set].
- 14** Repeat steps 12 and 13 for column M.

► More information

For detailed information on cleaning your machine, refer to the *User's Guide*.

Troubleshooting

▶ Problems installing and removing software

See below if you were unable to install or remove the software.

[MP Drivers/MP Toolbox]

● Cannot install the software.

1. Have you followed the instructions in the Set-Up Sheet to install the software?

If you have not followed the installation procedure correctly, try reinstalling the software. If there was an error during installation and installation was not completed, restart your computer and try reinstalling the software.

2. Are any other applications open?

If you have other applications open, quit all of these and try reinstalling the software.

3. Have you installed an earlier version of the software (version 4.4 or earlier)? (Is Canon MultiPASS registered as the startup item in the Start menu program?)

Remove the old version of the software following the instructions in the Software Guide of that version and try reinstalling the new version.

[MP Toolbox only]

● Installation or removal of the MP Toolbox cannot be completed.

1. To prepare for forced re-installation, on the Windows desktop, double-click [My Computer].

Open the CD-ROM icon, then double-click [\\MP\English\Toolbox\Setup\FrcInst.exe].

2. Return to a folder a level above, then double-click [\\MP\English\Toolbox\Setup.exe] to re-install (→ *Software Guide*).

[MP Drivers only]

● Removal of the MP drivers takes too long (Windows XP).

Removal of the software will take longer if an application such as a virus checker is running. Quit any applications (including virus checkers) before removing the software.

● Removal of the software was completed, but [Canon] remains.

When removing the software, if you remove the MP drivers before removing the MP Toolbox, [Canon] will remain displayed in [(All) Programs]. To remove [Canon], in the Start menu, open [Taskbar and Start Menu Properties] and remove it from here.

● The message <Version conflict> appears on your computer (Windows 98).

If the message <Version conflict> or <Windows 98 file language or ...> appears during installation, click [Yes] or [No]. Whichever you click, installation thereafter will continue trouble-free.

This message will appear if you have Photoshop installed on your computer.

- **Cannot use the software after upgrading to Windows XP.**

If the software was installed in Windows 98/Me/2000 and you upgraded to Windows XP without removing the software, the machine may not be able to be recognized. Remove the software and then reinstall it (→ *Software Guide*).

- **In [Device Manager], green mark “?” is displayed (Windows Me).**

Under [Device Manager], green mark “?” is displayed on [USB Composite Device] in [USB (Universal Serial Bus) Controller] in Windows Me. However, this is not a problem so continue to use it as is.

▶ Problems turning on the computer

See below if you cannot start your computer.

- **Computer will not start.**

Did you turn on your computer with a memory card inserted in the machine?

If a memory card is inserted in the machine and the machine is connected to the computer, your computer may not start depending on its settings.

In the computer's BIOS settings, if you set up the order so that the hard disk that starts Windows starts before the USB device, your computer will start even with a memory card inserted in the machine. For details on BIOS settings, refer to your computer's documentation.

▶ Problems printing from your computer

See below if you have tried unsuccessfully to print from your computer, or if you cannot print images scanned to your computer.

The  mark indicates problems that also occur when printing copies or receiving faxes on your machine.

- **Cannot print at all.**

-  **1. Is there anything displayed in the LCD?**

If nothing is displayed, see p. 10-14.

-  **2. Is the Alarm light blinking?**

If it is blinking, see p. 10-18.

- 3. Is the background of the BJ Status Monitor picture yellow or red?**

Follow the instructions in the BJ Status Monitor (→ *Software Guide*).

If <Service error 5100> appears.

Remove the paper jam or whatever is preventing the printhead holder from moving (→ p. 10-15).

If the message remains, press [ON/OFF (1 sec.)] to turn the machine off, then press again to turn it on.

-  **4. Are the ink tanks installed correctly?**

Press [Open] and lift up the scanning unit (printer cover). Press “PUSH” on the ink tanks and check that they are securely inserted. Also, check that the ink tanks are inserted in the correct slots (→ p. 9-2).

-  **5. Print the nozzle check pattern (→ *Maintaining the printhead*, p. 9-3).**

- 6. Are you trying to print in DOS?**

You can only print in Windows and not in DOS.

7. Is there an application error or General Protection Fault error displayed on the computer? Is the application you are using to print with compatible with the operating system?

Refer to the application's documentation. If the application is not compatible, generally you will be unable to print.

Has the application been allocated enough memory?

If other applications are open, close them to increase the available memory.

Refer to the application's documentation to check the amount of memory the application requires.

If a problem occurs when printing a specific document.

Try printing again after opening and editing the document.

8. Does the hard disk have enough available space?

If not, delete files you do not need to increase the available disk space.

9. Restart the computer.

10. There may be a problem with the printer driver.

Remove the printer driver and try reinstalling (→ *Software Guide*).

● **Cannot print to a shared printer.**

1. Is the server (the computer to which the machine is connected) turned on?

Turn the server on.

2. Is the server set up for printer sharing?

Set up the server for printer sharing (→ *Software Guide*).

3. Is the server set up to allow your system access to the shared printer?

Set up the server to allow your system access to the shared printer.

● **Printing stops in the middle.**

 **1. Has the machine been printing continuously over a long period?**

If so, the printhead will overheat. To protect the printhead, printing will stop temporarily and resume after a period of time. Interrupt printing when appropriate, turn off the machine and wait 15 minutes.

 **CAUTION**

• **The area around the printhead may become extremely hot. Do not under any circumstances touch it.**

 **2. Are you printing large files such as photographs or illustrations?**

If you are printing large files, it will take time to process the data and printing will appear to have stopped. Wait until data is processed.

* If you are printing a document with a large printing area or are printing more than two pages, printing may stop to allow the ink time to dry.

● **Paper does not feed properly.**

 **1. Is the paper the correct weight?**

Use 17–28 lb. (64–105 g/m²) paper.

 **2. Does the paper stack exceed the paper limit mark (▶) or tab, or exceed the capacity of the multi-purpose tray?**

If so, reduce the amount of paper.

 **3. Has the paper been loaded correctly?**

Check that the paper has been loaded correctly and that the paper guide is properly adjusted (→ *Set-Up Sheet*).

 **4. Is the paper creased or curled?**

You cannot use paper that is creased. Uncurl curled paper.

 **5. Clean the roller (→ *User's Guide*).**

 **6. Is there some foreign matter in the multi-purpose tray?**

Check and remove any foreign matter.

● Paper curls.

🔧 1. Remove the printed page after 30 to 60 seconds.

The paper may curl if you use thin paper and print images that use a large quantity of ink such as photographs or pictures.

Leave the printed page in the paper output tray for 30 to 60 seconds and remove when the ink has dried.

2. Is intensity set too high?

The paper may curl or rub if intensity is set too high in the printer driver. In the [Properties] dialog box, on the Main tab, click [Manual] in Color Adjustment, then click [Set]. In the [Manual Color Adjustment] dialog box, reduce the intensity with the Intensity slider.

🔧 3. Are you using thin paper?

The paper may curl if you use thin paper and print images that use a large quantity of ink such as photographs or pictures with intense colors. Use thicker paper such as high resolution paper or glossy photo paper (→ p. 2-3).

🔧 4. Was the paper already curled before loading?

Uncurl the paper and reload.

● Meaningless characters and symbols are printing.

If this problem only occurs when printing a specific document.

Open and edit the document and try printing again. If this does not work, there may be a problem with the application. Contact the application's manufacturer.

● White streaks appear on the printout.

🔧 1. Print the nozzle check pattern (→ *Maintaining the printhead*, p. 9-3).

2. Are you printing on coated paper?

In the [Properties] dialog box, on the Main tab, click [High] in Print Quality.

● Printout is rubbed or stained.

🔧 1. Is the paper thickness lever set correctly?

When you print documents that contain large quantities of ink such as documents with a lot of detail, the paper may curl and rub. Move the paper thickness lever to the right (→ p. 2-4).

🔧 2. Does the paper stack exceed the paper limit mark (▶) or tab, or exceed the capacity of the multi-purpose tray?

If so, reduce the amount of paper.

3. Are you printing outside the printable area?

Change the margin settings in the application to keep the document within the recommended printable area.

4. Is intensity set too high?

The paper may curl or rub if intensity is set too high in the printer driver.

In the [Properties] dialog box, on the Main tab, click [Manual] in Color Adjustment, then click [Set]. In the [Manual Color Adjustment] dialog box, reduce the intensity with the Intensity slider.

🔧 5. Are you using recommended print media?

For recommended print media, see p. 2-3.

🔧 6. Clean the machine's interior.

If the machine's interior is dirty with ink or there is a build-up of paper dust, your printout may contain ink stains. Clean the machine (→ *User's Guide*).

🔧 7. Are you printing on the wrong side of the paper?

Some papers have a right side for printing. Turn the paper over and try printing again. There are also types of paper such as Photo Paper Pro that can only be printed on one side.

● **The ink empty message is displayed differently on the printer status monitor than how it is displayed on the machine's LCD.**

While you are printing from your computer, if the ink empty message is displayed on the printer status monitor and on the machine's LCD, press [Resume] on the machine and cancel the job. On the printer status monitor, the message changes to [Ink low] and you can continue printing for a short period of time.

However, the ink empty message on the machine's LCD does not change so replace the appropriate ink tank.

▶ Copying problems

See below if you are having problems copying.

For printing-related problems, see the items marked with  in *Problems printing from your computer*, p. 10-2.

● **Cannot make a copy (the document or paper will not feed into the machine).**

1. **Is there anything displayed in the LCD?**

If nothing is displayed, see p. 10-14.

2. **Is the Alarm light blinking?**

If it is blinking, see p. 10-18.

3. **Is the document loaded correctly?**

Check that the document is loaded correctly on the platen glass or  ADF (→ p. 2-2).

4. **See *Paper does not feed properly* on p. 10-3.**

5. **Are the ink tanks installed correctly?**

Press [Open] and lift up the scanning unit (Printer cover). Press "PUSH" on the tanks and check that they are securely inserted.

6. **Print the nozzle check pattern (→ *Maintaining the printhead*, p. 9-3).**

● **Paper comes out but there is nothing copied on it.**

1. **Is the document loaded correctly?**

If placing the document on the platen glass, the side to be copied should be face down.  If placing the document in the ADF, the side to be copied should be face up (→ p. 2-2).

2. **Has ink run out?**

If nothing prints or one of the colors does not print, check if the ink tanks are empty. Replace the ink tank(s) if necessary. Also, make sure the orange tape has been completely removed from the ink tanks.

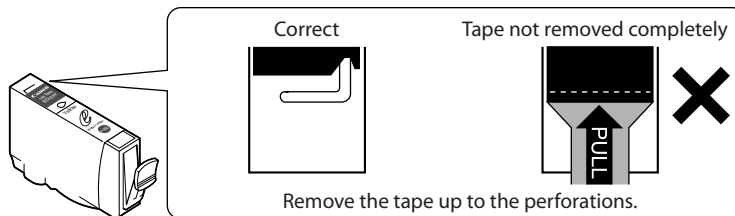

3. **Print the nozzle check pattern (→ *Maintaining the printhead*, p. 9-3).**

● Copy quality is poor.

1. Are you copying a document or photograph printed from your machine?

Image quality may be poor when you copy a document or photograph printed from your machine. Try printing the photograph from the memory card, or the document from your computer.

2. Clean the scanning area (→ *User's Guide*) and the **Fax Model** ADF area (→ *User's Guide*).

3. Clean the printhead (→ p. 9-4).

4. Does the LCD show the correct type of print media loaded?

If not, set the print media type (→ p. 2-4).

5. Is the image quality displayed in the LCD suitable for the document?

If not, set an image quality suitable for the document (→ p. 5-2).

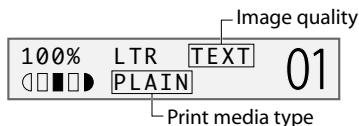

► Problems scanning

See below if you have problems scanning a document to your computer from the machine.

● Cannot scan a document.

1. Is there anything displayed in the LCD?

If nothing is displayed, see p. 10-14.

2. Is the Alarm light blinking?

If it is blinking, see p. 10-18.

3. Is the document loaded correctly?

Check that the document is loaded correctly on the platen glass or **Fax Model** ADF (→ p. 2-2).

4. Restart the computer.

5. If using a USB hub or repeater, try connecting the USB cable directly to the computer.

If you can scan documents successfully after connecting the USB cable directly to the computer, the USB hub or repeater may be broken. Replace if necessary.

6. Are you using a USB 2.0-compatible USB hub?

If you are connecting a USB 2.0-equipped computer and the printer using a USB 2.0-compatible USB hub, you may not be able to scan. In this case, connect the USB cable directly to the computer.

If you want to connect the printer and computer via a USB 2.0-compatible hub, follow the steps below to modify the INI file. It is recommended that before opening the file in step 1 below, you make a backup copy of the file in another folder before making any changes to it.

1. Open the following file in Notepad or another text editor application.

Windows 98/Me:

windows\system\CNCMP50.ini

Windows 2000:

winnt\system32\CNCMP50.ini

Windows XP:

windows\system32\CNCMP50.ini

2. Below the last line, add the following two lines, then save the file. Take care not to modify any other parts.

[Scan]

ReadSize=16

7. **Fax Model** Is the [Select source] setting in the MP Toolbox, ScanGear MP, or WIA driver set correctly?

Choose between loading the document on the platen glass or ADF.

8. After installing the software, did you install a TWAIN-compatible application?

If this is the case, the TWAIN system file is replaced with something inappropriate and you will be unable to scan images. If this happens, remove the software (→ *Software Guide*) and reinstall (→ *Set-Up Sheet*).

9. Is the machine recognized in the [Scanners and Cameras] window of [Control Panel] ?

Follow this procedure to check if the machine icon is present in [Scanners and Cameras] of the [Control Panel]:

1. On the Windows desktop, click [Start], point to [Settings], then click [Control Panel]. (Windows XP: On the desktop, click [Start], then [Control Panel].)
2. Double click [Scanners and Cameras]. (Windows XP: In the [Control Panel] window, click [Printers and Other Hardware], then [Scanners and Cameras].)
3. In the [Scanners and Cameras] window, if [Canon MP730] or [Canon MP700] (Windows XP: [WIA Canon MP730] or [WIA Canon MP700]) is present, the machine is recognized. If not, remove the software (→ *Software Guide*) and reinstall (→ *Set-Up Sheet*).

● You tried to create a multipage PDF, but were not able to scan several documents.

Click a button on the MP Toolbox and in the settings dialog box, select [Use the scanner driver to make advanced settings]. When ScanGear MP opens, if you scan with the [Automatically quit ScanGear MP after scanning] setting selected in [Preferences] of Advanced Mode, only the documents placed at one time on the platen glass will be scanned. If you want to scan additional documents, clear the [Automatically quit ScanGear MP after scanning] setting before scanning.

● Computer has hung up or frozen.

1. Quit other open applications and try again.

Memory may be insufficient. Quit other open applications and try again.

2. Does the hard disk have enough available space?

Check that the hard disk has enough available space, in particular when scanning large documents at a high resolution. For example, a letter-size document scanned at 600 dpi, full color requires a minimum of 300 MB of space.

* If you do not have enough available space, scan the document at a lower resolution.

3. If an error occurs when scanning an image in Photoshop.

Change the allocated memory. On the Edit menu, point to [References], then click [Memory & Image Cache]. Change the Physical Memory Usage to 10% or 20%.

4. Remove the software (→ *Software Guide*) and reinstall (→ *Set-Up Sheet*).

● You installed the applications on the MultiPASS MP730/700 Setup CD-ROM but they were not registered in the MP Toolbox.

If you install the applications with the MP Toolbox open, the applications will not be registered in the MP Toolbox. Click [Defaults] to register them (→ *Software Guide*).

● When you click a key on the MP Toolbox, another application opens.

When you click a key on the MP Toolbox, you may want another application to open.

Click a key on the MP Toolbox and select the application you want to open for that key. Repeat for the other keys (→ *Software Guide*).

● You opened the [Preferences] dialog box from the [Scanners and Cameras] icon and changed the settings, but the settings were not activated (Windows 2000).

In Windows 2000, if you open [Scanners and Cameras] in [Control Panel] and change the settings in [Events], the settings will not be activated unless you restart your computer. Once you have changed your settings, restart your computer.

● You canceled a scan before completion and the document became jammed in the ADF.

Press [Resume] to eject the document from the ADF (→ *Software Guide*).

● The image you have scanned looks dirty.

1. **If the image looks grainy, increase the scan resolution (→ *Software Guide*).**
2. **Display the image at 100%.**
Some applications do not display an image well at small sizes. Try displaying the image at 100% magnification.
3. **There is more when you scan printed material.**
In ScanGear MP, click [Descreen] (→ *Software Guide*).
4. **Set the monitor display colors to 16-bit or higher.**
In [Display Properties], set the display colors to 16-bit color, 24-bit color or higher.
5. **Clean the platen glass and document cover (→ *User's Guide*).**

● White margins appear around the scanned image.

Specify the scan area.

In ScanGear MP, click [Multi-Scan] to automatically specify the scan area.

If there are white margins around documents such as photographs, or if you want to trim a document (i.e. you want to scan only one part of a document), specify the area of the scan manually (→ *Software Guide*). To display ScanGear MP when scanning, click a button on the MP Toolbox and select [Use the scanner driver to make advanced settings]. Clear this setting if you do not want ScanGear MP to display (→ *Software Guide*).

● White lines appear on the left side of the image.

Place the document approximately $\frac{1}{8}$ inch (3 mm) from the edge of the platen glass.

● Cannot scan correctly with multi-scan.

1. **Does the position of the photographs and the way they are positioned fulfill the following requirements?**
 - There should be a gap of at least $\frac{3}{8}$ inch (1 cm) between the edge of the platen glass and photographs.
 - There should be a gap of at least $\frac{3}{8}$ inch (1 cm) between the edges of the photographs.
 - There should be no more than ten photographs.
 - The photographs should be straight (any tilting should be kept within 10 degrees).
2. **Some applications do not accept multiple scans of more than two images.**
Check the application's documentation or contact the application's manufacturer.
3. **Clean the platen glass and document cover (→ *User's Guide*).**
4. **When scanning from the platen glass, thick or curled photographs may not be scanned properly.**
Press lightly on the document cover when scanning.
5. **Is the document smaller than $\frac{9}{64}$ inch² (1 cm²)?**
You cannot use multi-scan for documents smaller than $\frac{3}{8}$ inch \times $\frac{3}{8}$ inch (1 cm \times 1 cm). Scan each document separately.
6. **Is the ratio of the long and short sides of the document greater than 1:4?**
You cannot use multi-scan if the long side of the document is 4 or more times longer than the short side. Scan each document separately.

● Scanned image is displayed at a large (small) size on the computer screen.

1. **Enlarge or reduce the image display in the application.**
However, if you open the image in Paint or Imaging, it may display at a large size and you will not be able to reduce it.
2. **Change the resolution and scan again.**
The image will be large if resolution is high. It will be small if resolution is low (→ *Software Guide*).

Fax Model Problems receiving faxes

See below if you are having problems receiving faxes.

● Cannot receive a fax, cannot print a fax.

1. Is there anything displayed in the LCD?

If nothing is displayed, see p. 10-14.

2. Is the Alarm light blinking?

If it is blinking, see p. 10-18.

3. Is the machine making a noise and is the In Use/Memory light blinking?

A telephone (or other peripheral device such as an answering machine or computer modem) is connected to the ☐ jack. Reconnect to the ☐ jack (→ *Set-Up Sheet*).

4. Nothing is printed on the printout.

Print the nozzle check pattern (→ p. 9-4).

If the nozzle check pattern does not print properly, see p. 9-3.

If the nozzle check pattern does print properly, see the items marked with ☐ in *Problems printing from your computer*, p. 10-2.

✎ NOTE

• Once printed, received faxes are automatically deleted from the machine's memory. Accordingly make sure the printhead is cleaned periodically (→ p. 9-4) to avoid clogging and potential loss of data.

5. In manual receive mode, did you pick up the handset to receive a fax and before replacing the handset, did you press [Start] or dial the remote receiving ID number?

If you replace the handset without doing either of these things, the call will disconnect.

6. Which receive mode is displayed on the bottom left of the LCD? Have you followed the procedure for that receive mode correctly?

| |
|----------------------|
| 12/27/2003 SAT 15:00 |
| FaxTel STANDARD |

└─ Receive mode

<FAX/TEL AUTO SW>: Fax calls are received automatically and the telephone rings for voice calls. There are no procedures to follow for receiving faxes. Ringing indicates a voice call so pick up the handset.

<FAX ONLY MODE>: The machine automatically receives faxes without ringing. You cannot manually answer calls.

<DRPD>: Set this mode if you have subscribed to a DRP (Distinctive Ring Pattern) service offered by some companies. The machine will then ring differently depending on whether a call is a fax or voice call.

<MANUAL MODE>: The machine rings for both voice and fax calls. If you hear the machine ring, pick up the handset and either press [Start] or dial the remote receiving ID to receive a fax.

<ANS.MACHINE MODE>: Fax calls are received automatically and voice calls are received by the answering machine connected to the machine. There are no procedures to follow for receiving faxes. The answering machine should be left connected.

7. Are there documents in the machine's memory?

The memory may be full. Either print or delete documents (→ the *User's Guide*) to free up memory. Then ask the sender to resend the fax.

8. Was there an error during reception?

Check the LCD for an error message (→ p. 10-18).

Print the ACTIVITY REPORT and check for an error (→ p. 10-2).

9. Is there a telephone line connected?

Check that the telephone line is correctly connected (→ *Set-Up Sheet*).

● Cannot receive faxes automatically.

1. Is <FaxTel>, <FaxOnly>, <DRPD>, or <AnsMode> receive mode displayed on the bottom left of the LCD?

If <Manual> is displayed, you cannot receive faxes unless you pick up the handset and either press [Start] or dial the remote receiving ID.

If you want to receive faxes automatically which means not having to do anything when you are sent a fax, set the receive mode to <FAX/TEL AUTO SW>, <FAX ONLY MODE>, <DRPD>, or <ANS.MACHINE MODE> (→ p. 7-7).

If set to <ANS.MACHINE MODE>, connect an answering machine to the machine (→ *Set-Up Sheet*) and check that a message plays when the answering machine answers.

● Machine does not switch automatically between voice and fax reception.

1. Is <FaxTel>, <DRPD>, or <AnsMode> receive mode displayed on the bottom left of the LCD?

There will be no automatic switching between voice and fax calls unless the receive mode is set to <FAX/TEL AUTO SW>, <DRPD>, or <ANS.MACHINE MODE>. If set to <ANS.MACHINE MODE>, connect an answering machine to the machine (→ *Set-Up Sheet*) and check that a message plays when the answering machine answers.

2. Is the sender's fax machine unable to send a CNG signal (the signal which indicates that the call is a fax call)?

Some fax machines are not able to send CNG signals. If so, receive the fax manually (→ p. 7-8).

● Quality of received fax is poor.

1. Are you using recommended print media?

For recommended print media, see p. 2-3.

2. Print the nozzle check pattern (→ *Maintaining the printhead*, p. 9-3).

Print the nozzle check pattern (→ p. 9-4).

If the nozzle check pattern does not print properly, see p. 9-3.

3. Is <ECM RX> set to <OFF>?

Set <ECM RX> to <ON> (→ p. 11-4).

4. The printed fax is poor quality.

See the items marked with  in *Problems printing from your computer*, p. 10-2.

5. Check whether the sender's fax machine is dirty.

The image quality of the fax is mainly determined by the sender's fax machine. Contact the sender and check whether the document cover and platen glass of his fax machine are dirty.

● Cannot receive a fax in ECM mode.

If you receive a fax in ECM mode, "ECM" will show on the ACTIVITY REPORT. If "ECM" is not shown, the fax was not received in ECM mode.

1. Is <ECM RX> set to <OFF>?

Set <ECM RX> to <ON> (→ p. 11-4).

2. Is the sender's fax machine ECM-compatible?

If the sender's fax machine is not ECM-compatible, the fax will be received in standard mode without error correction.

● Repeated errors occur when you receive a fax.

If there is an error, a message will be displayed in the LCD. The ACTIVITY REPORT and RX REPORT will show "NG" and an error code.

1. Reduce the reception start speed (→ <RX START SPEED>, p. 11-5).

If there is a bad line or connection, reducing the reception start speed may correct the error.

2. Check whether the sender's fax machine is operating normally.

Contact the sender and check whether his fax machine is operating normally.

Fax Model Problems sending faxes

See the items marked with **M** (machine) if you are having problems sending a fax from the machine.

See the items marked with **C** (computer) if you are having problems sending a fax from your computer.

● Cannot send a fax.

M C 1. Is the machine making a noise and is the In Use/Memory light blinking?

The telephone line is connected to the  jack. Reconnect to the  jack (→ *Set-Up Sheet*).

M C 2. Did you set the correct line type?

You can still receive faxes even if the telephone line type is not set correctly. If you can receive but cannot send, check the telephone line type setting (→ p. 7-2).

M C 3. Is there anything displayed in the LCD?

If nothing is displayed, see p. 10-14.

M C 4. Is the Alarm light blinking?

If it is blinking, see p. 10-18.

M C 5. Is the telephone line cord connected properly?

Check that the telephone line cord is connected properly (→ *Set-Up Sheet*).

M C 6. Press [Hook] or pick up the handset of the telephone connected to the machine. Can you hear a tone?

If not, there is a problem with the telephone line. Contact your telephone company.

M 7. Is the document loaded correctly?

Check that the document is loaded correctly on the platen glass or ADF (→ p. 2-2).

M 8. Is one-touch or coded speed dialing registered with fax numbers?

If you are using one-touch or coded speed dialing, check that the fax number is correctly registered (→ p. 7-4).

M C 9. Is the number dialed correct?

Check the number and try dialing again.

M C 10. Is the In Use/Memory light blinking? Is the fax recipient shown in the LCD?

Another document is being sent from memory. Wait until the document has finished sending.

M 11. Was there an error during transmission?

Print the ACTIVITY REPORT and check for an error (→ *User's Guide*).

M C 12. Is the recipient's fax machine G3-compatible?

Check that the recipient's fax machine is G3-compatible. If not, you will be unable to send faxes.

● Fax sent is dirty.

M 1. Is the document loaded correctly?

Check that the document is loaded correctly on the platen glass or ADF (→ p. 2-2).

M 2. Try making a copy.

If you can make a clean copy, it is probably that the recipient's fax machine is the source of the problem. Contact the recipient to confirm.

If you are unable to make a clean copy, clean the machine (→ *User's Guide*).

● Cannot send a fax in ECM mode.

If you send a fax in ECM mode, "ECM" will show on the ACTIVITY REPORT. If "ECM" is not shown, the fax was not sent in ECM mode.

M C 1. Is <ECM TX> set to <OFF>?

Set <ECM TX> to <ON> (→ p. 11-4).

2. Is the recipient's fax machine ECM-compatible?

If the recipient's fax machine is not ECM-compatible, the fax will be sent in standard mode without error correction.

● Repeated errors occur when you send a fax.

- MG 1. Reduce the transmission start speed** (→ <TX START SPEED>, p. 11-4).

If there is a bad line or connection, reducing the transmission start speed may correct the error.

▶ Fax Model Telephone problems

See below if you have problems using the telephone.

● Cannot dial.

1. **Is there anything displayed in the LCD?**

If nothing is displayed, see p. 10-14.

2. **Is the Alarm light blinking?**

If it is blinking, see p. 10-18.

3. **Is the telephone line cord correctly connected?**

Check that the telephone line cord is correctly connected (→ *Set-Up Sheet*).

4. **Did you set the correct telephone line type?**

Make sure the machine is set for the correct telephone line type (→ p. 7-2).

● Telephone disconnects during a call.

This will happen if the power cord is not connected securely to the machine and wall outlet.

Check that the power cord is securely inserted into the machine and wall outlet, and that the power is on (→ *Set-Up Sheet*).

If the machine is connected to a table tap, OA tap or extension cord, make sure they are connected correctly and, if there is a power switch, that it is on.

▶ Problems using a memory card

See below if the memory card is not recognized when inserted into the machine's slot, or if the image data is not being read.

● Memory card is not recognized.

1. **Is the memory card securely inserted into the machine's slot?**

2. **Is the memory card inserted into the correct slot?**

For details on which slot to insert the memory card, see p. 4-2.

3. **The memory card is not recognized although it is inserted securely into the machine's slot.**

Remove and reinsert the memory card as explained on p. 4-2.

4. **Are there any images on the memory card?**

Check if there is any image data on the memory card using your digital camera or computer.

5. **Is the image data valid?**

If standby mode is displayed in photo print mode, there are valid images on the memory card. If a message is displayed, see p. 10-18.

6. **Try again with another memory card.**

1. If you can print without any problems using a different memory card, the first memory card may be damaged. In this case, reformatting the memory card with a digital camera may fix the problem. However, please note that when you reformat the memory card with a digital camera, all the data will be deleted. If you can read the image data on the computer, copy the image data to your computer before reformatting the memory card.
2. If you still have problems with another memory card, it is having difficulty operating with the machine. Try again with a recommended memory card (→ p. 4-1).

- **"?" is printed in the index.**

Yellow "?":The photograph data is large. Printing of this photograph may take a long time when printing in single frame, frame range, or all frame mode.

Red "?":The photograph data is damaged and cannot be printed on your machine.

- **Cannot write to the memory card (write protect error displayed in Windows).**

1. **Is the machine in photo print mode and the <CARD PROTECT> setting set to <ON>?**

Switch to a different mode and set the <CARD PROTECT> setting to <OFF> (→ p. 4-10). Then turn the machine off and on again.

2. **If a delayed write failed error is displayed in Windows 2000. Is the machine in photo print mode and the <CARD PROTECT> setting set to <ON>?**

Switch to a different mode and set the <CARD PROTECT> setting to <OFF> (→ p. 4-10). Then turn the machine off and on again.

If you want to enable card protection, set the <CARD PROTECT> setting to <ON> (→ p. 4-10). Then turn the machine off and on again.

⚠ CAUTION

- **In Windows 2000, if you set the <CARD PROTECT> setting to <ON>, turn the machine off then on again. If you copy data from the hard disk to the memory card and a delayed write failed error occurs, the original file may be lost.**

3. **Have you connected in Windows XP?**

The date and time of access is written in the Windows XP preview, and if <CARD PROTECT> is set to <ON> or photo print mode is selected, a write protect error may be displayed. Turn the machine off then on again.

- **Removable disk does not appear in Windows Explorer.**

This behavior can occur if you map a network drive to the next available drive letter after the local volumes and CD-ROM drives have been assigned drive letters. Do the following if you experience this problem:

1. Assign the network drive to any other drive letters.
2. Restart your computer.

- **The [Unplug/Eject] icon does not appear (Windows 2000).**

In Windows 2000, the [Unplug/Eject] icon does not appear even when you select [Show Unplug/Eject icon in the taskbar] in the [Unsafe Removal of Device] dialog box that is displayed when you turn off the machine or disconnect the USB cable.

You do not need to use the [Unplug/Eject] icon when you turn off the machine or disconnect the USB cable.

- **The machine does not appear in [Hardware devices] in the [Add/Remove Hardware] dialog box (Windows 2000).**

In Windows 2000, the machine does not appear in [Hardware devices] in the [Select Device to Unplug] dialog box in [Add/Remove Hardware] of [Control Panel].

In Windows 2000, the [Unsafe Removal of Device] dialog box will appear when you turn off the machine or disconnect the USB cable, and the message [To safely unplug or eject any of the following devices, first use the Hardware wizard in the Control Panel to stop the device] will appear. There is however no need to unplug a device with [Add/Remove Hardware] when you turn off the machine or disconnect the USB cable.

● **In Windows Explorer, you cannot display [Thumbnails] (Windows 2000).**

In Windows 2000, if you display the contents of a memory card in Windows Explorer, and change the display to [Thumbnails] on the [View] menu, the images may not display and the computer may freeze. This is a problem that occurs with USB card readers in general, and not just with this machine.

If you want to change the display to [Thumbnails] in Windows Explorer, set the <CARD PROTECT> setting to <OFF> (→ p. 4-10). Then turn the machine off and on again.

● **The memory card is recognized as a drive other than [Removable Disk].**

Did you start your computer with a memory card inserted in a card slot?

Depending on your computer, this may occur if you start your computer with a memory card inserted in the machine.

Remove the memory card and restart your computer.

▶ **If nothing displays in the LCD (if there is no power)**

When you connect the power cord to the machine and wall outlet, and press [ON/OFF (1 sec.)], the machine powers up and a message is displayed in the LCD.

While the Alarm light blinks, the machine is initializing and you will not be able to use it. Wait until the Alarm light stops blinking.

If nothing is displayed in the LCD, make the checks in the following order until something is displayed.

1. Is the power cord correctly connected?

Securely connect the power cord to the machine and wall outlet.

2. Have you pressed [ON/OFF (1 sec.)]?

The machine will power up and the LCD will show a message when you connect the power cord and press [ON/OFF (1 sec.)].

3. Check that the wall outlet is working normally.

Connect another electrical appliance to the wall outlet and check whether the wall outlet is working properly.

4. Connect the power cord directly to the wall outlet.

Disconnect the power cord from any table taps, OA taps or extension cords and connect directly to the wall outlet. If the machine powers up when the power cord is connected directly, the table taps, OA taps or extension cords are probably defective and should be replaced.

If they have a power switch, turn it on.

5. Check that the power cord is not defective.

Either replace the power cord with another, or using a tester, check whether the cord is defective.

If the power disconnects unexpectedly

User data and speed dialing settings are stored using the internal battery if there is a power failure or if you accidentally disconnect the power cord. However, all documents stored in memory will be deleted.

If the power disconnects, the following will apply:

- You will not be able to send or receive faxes, or make copies.
- If a telephone is connected to the machine, you may be able to receive and/or make voice calls (depending on your telephone).

When power is restored, the MEMORY CLEAR REPORT will be printed automatically listing the documents deleted from memory. Note however that this report will not be printed if the print media size is set to a setting other than <LTR>, <LGL>, or <A4>, or if black ink or paper has run out.

Removing jammed paper

If <CLEAR PAPER JAM> is displayed in the LCD, follow this procedure to clear the paper jam.

Fax Model If a paper jam occurs when receiving a fax, that fax will be stored in memory and printed automatically when you clear the jam and press [Resume].

Removing jams in the paper output tray

Follow this procedure to remove jams from the paper output tray:

- 1 Gently pull any jammed paper out of the paper output tray.**
 - If you cannot see any jammed paper in the paper output tray, remove it from the machine's interior (→ below).
- 2 Press [Resume].**
 - If you are printing from a Windows application, follow the instructions displayed on your computer.

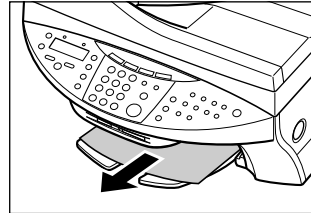

Removing jams from the machine's interior

Follow this procedure to remove jams from the machine's interior:

- 1 Press [Open] ① and lift up the scanning unit ②.**

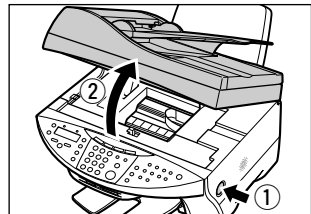

2 Gently gather the jammed paper to the center of the opening and then remove it.

▲ CAUTION

• **Be careful not to touch the components inside the machine.**

- If the jammed paper tears while you are pulling and you cannot remove the torn pieces, turn the machine off then on with the [ON/OFF (1 sec.)] key. The jammed pieces will automatically be ejected.

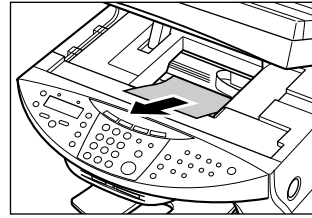

3 Close the scanning unit until it locks into place.

4 Press [Resume].

- If you are printing from a Windows application, follow the instructions displayed on your computer.

If there are repeated paper jams

Paying attention to the following points, reload the paper.

1. Fan out the sheets of paper well so that they do not stick together.
2. Align the edges of the paper.
3. Adjust the paper guide correctly.
4. Make sure the paper stack does not exceed the paper limit mark (▶) or tab.
5. Make sure the paper loaded does not exceed the capacity of the multi-purpose tray (→ p. 2-1).
6. Do not force paper into the multi-purpose tray.
7. Only use the same type of paper.
8. Use recommended print media (→ p. 2-3).

▶ **Fax Model** Removing jammed documents

If documents jam in the ADF or do not feed properly, <DOC. TOO LONG> is displayed in the LCD. You do not need to turn off the power when clearing document jams.

1 Press [Stop/Reset].

2 If a multipage document is loaded, remove from the ADF all pages except for the jammed page.

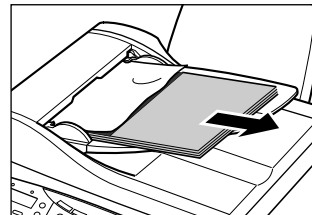

3 Open the feeder cover.

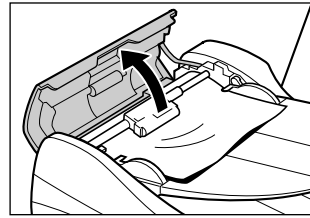

4 Raise the paper release lever **(A)** and slide the page under the roller towards the feeder cover.

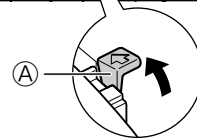
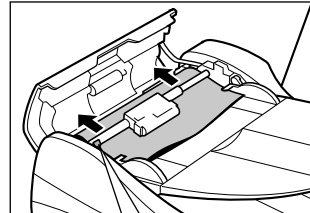

5 Pull out the jammed page from the ADF.

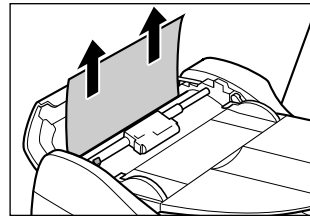

6 Lower the paper release lever **(A)**, then close the feeder cover.

- If [Stop/Reset] is pressed during scanning and the document remains in the ADF, wait for the machine to return to standby mode, then press [Resume]. Documents left in the ADF will be ejected automatically.

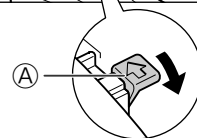
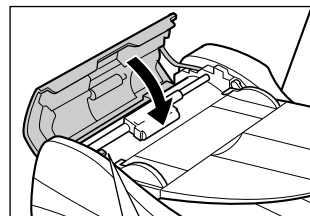

▶ If the nozzle check pattern does not print properly

Refer to *Maintaining the printhead*, p. 9-3.

▶ Interpreting the messages

When the Alarm light blinks

Check the message in the LCD. If there is a message, follow the instructions and correct the error. Then to resume operation, press [Resume]. The Alarm light will turn off.

If the error remains, turn off the machine and disconnect the power cord. Wait 15 seconds, then reconnect the power cord and turn on the power.

If you cannot clear a paper jam

Turn off the machine and disconnect the power cord. Wait five seconds, reconnect the power cord and turn on the power. If the problem has been resolved, the Alarm light will turn off.

If the Alarm light still lights even after you have turned the power on again

Contact the Canon Customer Care Center.

Error codes are printed in the ACTIVITY REPORT.

LCD messages

For detailed information on LCD messages and error codes, refer to the *User's Guide*.

▶ If you cannot solve the problem

If you have a problem with your machine that you cannot solve with the information provided in this chapter, contact the Canon Customer Care Center.

⚠ CAUTION

- **If the machine makes strange noises, emits smoke or strange smells, unplug it immediately and contact the Canon Customer Care Center. Do not attempt to disassemble or repair the machine yourself.**

🔔 IMPORTANT

- **Attempting to repair the machine yourself may void the limited warranty.**

If you contact the Canon Customer Care Center, make sure you have the following information ready:

- Product name: MultiPASS MP730 or MultiPASS MP700
- Serial number (located on the label located at the back of the machine)
- Details of the problem
- Steps taken to try to resolve the problem and the results

Machine settings

▶ **Fax Model** ▶ Printing a list to check the current settings

Before changing any settings, you can print the USER'S DATA LIST to check the current settings of your machine. For details, see the *User's Guide*.

▶ Accessing the machine settings

Follow this procedure to change a setting:

1 Refer to the lists on the following pages to find the setting you want to change.

2 If there is a reference for the setting ①, refer to that page for details. If not, at the top of the list, note under which function key ② and menu ③ the setting is located.

3 Press [Copy], [Scan], [Photo Print], or **Fax Model** [Fax] depending under which function key ② the setting is located.

4 Press [Menu].

5 Use [◀] or [▶] to select the menu ③ under which the setting is located.

6 Press [Set].

- You have now accessed the settings in the list.

7 Use [◀] or [▶] to select the setting you want.

8 Press [Set].

9 Follow these guidelines to scroll through and register settings:

- Use [◀] or [▶] to scroll through settings.
- To register a setting or access sub-settings, press [Set].
- To return to a previous level, press [Menu].

10 When you have finished, press [Stop/Reset].

Example:

| Name | Description | Setting | Page |
|--------------------|--|---------|------|
| 1. 2 on 1 | Copies two pages on one page (letter- or A4-size only). | — | UG |
| 2. BORDERLESS COPY | Copies without any borders (letter-, 4" × 6", 5" × 7", or A4-size only). | — | UG |
| 3. IMAGE REPEAT | Prints multiple copies of an image on a single sheet. | — | UG |
| AUTO | Automatically selects the number of repetitions. | — | — |
| MANUAL | Manually selects the number of repetitions. | — | — |
| VERTICAL | Selects the number of vertical repetitions. | 1/2/3/4 | — |
| HORIZONTAL | Selects the number of horizontal repetitions. | 1/2/3/4 | — |
| 4. MIRROR IMAGE | Prints a mirror image of the original. | — | UG |
| 5. ENTIRE IMAGE | Prints the original image to fit the selected print media size. | — | UG |

▶ Settings

Reference abbreviation
UG=User's Guide

 **NOTE**

- Default settings are shown in **bold** type.

Menu: SPECIAL COPY Function key: [Copy]

| Name | Description | Setting | Details |
|--------------------|--|---------|---------|
| 1. 2 on 1 | Copies two pages on one page (letter- or A4-size only). | — | UG |
| 2. BORDERLESS COPY | Copies without any borders (letter-, 4" × 6"-, 5" × 7"-, or A4-size only). | — | UG |
| 3. IMAGE REPEAT | Prints multiple copies of an image on a single sheet. | — | UG |
| AUTO | Automatically selects the number of repetitions. | — | |
| MANUAL | Manually selects the number of repetitions. | | |
| VERTICAL | Selects the number of vertical repetitions. | 1/2/3/4 | |
| HORIZONTAL | Selects the number of horizontal repetitions. | 1/2/3/4 | |
| 4. MIRROR IMAGE | Prints a mirror image of the original. | — | UG |
| 5. ENTIRE IMAGE | Prints the original image to fit the selected print media size. | — | UG |

Menu: MAINTENANCE Function keys: [Copy], [Scan], [Photo Print], [Fax Model] [Fax]

| Name | Description | Setting | Details |
|----------------------|--|--|---------|
| 1. NOZZLE CHECK | Prints the nozzle check pattern. | — | p. 9-4 |
| 2. HEAD CLEANING | Performs normal printhead cleaning. | — | p. 9-4 |
| 3. HEAD REFRESHING | Performs deep printhead cleaning. | — | p. 9-4 |
| 4. ALIGN PRINT HEAD | Aligns the printhead. | — | p. 9-5 |
| HORIZ. PATTERN | Prints the horizontal pattern. | — | |
| CHANGE H VALUE | Selects the horizontal value for columns A to K on the printout. | A,B,C,D,E:-3 to +7 F,G,H,I,J,K:-5 to +5 | |
| PRINT VERT. PATTERN? | Selects whether the vertical pattern is printed. | YES=(*) NO=(#) | |
| VERTICAL PATTERN | Prints the vertical pattern. | | |
| CHANGE V VALUE | Selects the vertical value for columns L and M on the printout. | L, M: -3 to +3 | |
| 5. ROLLER CLEANING | Cleans the roller. | — | UG |

Menu: USER DATA Function keys: [Copy], [Scan], [Photo Print], Fax Model [Fax]

| Name | Description | Setting | Details |
|--|--|--|---------|
| <small>Fax Model</small> 1. TEL REGISTRATION | — | — | |
| 1. 1-TOUCH SPD DIAL | Registers one-touch speed dialing. | — | p. 7-4 |
| 2. CODED SPEED DIAL | Registers coded speed dialing. | — | p. 7-5 |
| 3. GROUP DIAL | Registers group dialing. | — | UG |
| <small>Fax Model</small> 2. FAX SETTINGS | — | — | |
| 1. USER SETTINGS | — | — | |
| 1. DATE & TIME | Sets the current date and time. | — | p. 7-1 |
| 2. DATE SETUP | Selects the date format displayed in the LCD and printed on faxes you send. | MM/DD/YYYY DD/MM YYYY YYYY MM/DD | |
| 3. UNIT TELEPHONE # | Enters the fax/telephone number printed on faxes you send. | — | p. 7-1 |
| 4. UNIT NAME | Enters the name printed on faxes you send. | — | p. 7-1 |
| 5. TX TERMINAL ID | — | — | |
| 1. TTI POSITION | Selects the position of the sender information (outside or inside the image area) when sending black & white faxes. (Automatically set inside the image area for color faxes.) | OUTSIDE IMAGE INSIDE IMAGE | |
| 2. TELEPHONE # MARK | Selects the mark to appear before the fax/telephone number printed on faxes you send. | FAX TEL | |
| 6. OFFHOOK ALARM | Enables/disables the alarm that alerts you if the handset is not hung up properly. | ON OFF | |
| 7. VOLUME CONTROL | — | — | |
| 1. CALLING VOLUME | When the machine is set to ring, selects the ring volume. | 1/2/3 | |
| 2. LINE MONITOR VOL | Selects the dialing and on-hook volume. | 0 (off)/1/2/3 | |
| 8. RX CALL LEVEL | Selects the ring type for incoming calls. | HIGH STANDARD | |
| 9. TEL LINE TYPE | Selects the telephone line type setting for your machine. | TOUCH TONE ROTARY PULSE | UG |
| 2. REPORT SETTINGS | — | — | |
| 1. TX REPORT | Enables/disables automatic printing of a transmission report after sending. | PRINT ERROR ONLY OUTPUT YES OUTPUT NO | UG |
| PRINT WITH IMAGE | If you select <PRINT ERROR ONLY> or <OUTPUT YES>, selects whether the first page of the fax is printed under the report (black & white faxes only). | ON OFF | |
| 2. RX REPORT | Enables/disables automatic printing of a reception report after receiving. | OUTPUT NO PRINT ERROR ONLY OUTPUT YES | UG |

| Name | Description | Setting | Details |
|--------------------|--|--|---------|
| 3. ACTIVITY REPORT | Enables/disables automatic printing of an ACTIVITY REPORT after every 20 transactions. | AUTO PRINT ON AUTO PRINT OFF | UG |
| 3. TX SETTINGS | — | — | |
| 1. ECM TX | Enables/disables Error Correction Mode (ECM) during sending. | ON OFF | |
| 2. MID PAUSE SET | Selects the pause length when you press [Redial/Pause]. | 2 SEC (1 to 15) | |
| 3. AUTO REDIAL | Enables/disables automatic redialing. | ON OFF | UG |
| 1. REDIAL TIMES | If you select <ON>, selects the number of redialings. | 2 TIMES (1 to 10) | |
| 2. REDIAL INTERVAL | If you select <ON>, selects the length of time between redialings. | 2 MIN. (2 to 99) | |
| 4. TIME OUT | Enables/disables automatic scanning without having to press [Start] after using speed dialing or redialing to send a document. | ON OFF | |
| 5. TX START SPEED | Selects the speed at which the machine starts transmitting. | 33600bps 14400bps 9600bps 7200bps 4800bps 2400bps | |
| 6. COLOR DIRECT TX | Enables/disables sending of color documents to fax machines that do not have color faxing capability. | OFF ON | |
| 4. RX SETTINGS | — | — | |
| 1. ECM RX | Enables/disables Error Correction Mode (ECM) during reception. | ON OFF | |
| 2. FAX/TEL AUTO SW | If you select <FAX/TEL AUTO SW> as the receive mode, customizes its settings. | — | UG |
| 1. RING START TIME | Selects the time the machine takes to check whether a call is a fax or voice call. | 8 SEC (0 to 30) | |
| 2. F/T RING TIME | Selects the ring length for voice calls. | 15 SEC (10 to 45) | |
| 3. DEFAULT ACTION | Selects whether the machine switches to receive mode after the ring time has elapsed, or whether it disconnects the call. | RECEIVE DISCONNECT | |
| 3. DRPD:SELECT FAX | If you select <DRPD> as the receive mode, select the ring pattern for the machine. | DOUBLE RING SHORT-SHORT-LONG SHORT-LONG-SHORT OTHER RING TYPE NORMAL RING | |
| 4. INCOMING RING | If you select <FAX/TEL AUTO SW>, <DRPD>, or <FAX ONLY MODE> as the receive mode, enables/disables ringing for fax calls. (A telephone must be connected to your machine for ringing to occur.) | OFF ON | |

| Name | Description | Setting | Details |
|---------------------------------------|--|--|---------|
| RING COUNT | If you select <ON>, selects the number of rings for fax calls. | 2 TIMES (1 to 99) | |
| 5. MAN/AUTO SWITCH | If you select <MANUAL MODE> as the receive mode, selects if the machine switches to fax receive mode after ringing for a specified length of time. | OFF ON | |
| F/T RING TIME | If you select <ON>, selects the length of time the machine rings before switching to fax receive mode. | 15 SEC (5 to 99) | |
| 6. REMOTE RX | Enables/disables remote receiving. | ON OFF | |
| REMOTE RX ID | If you select <ON>, selects the remote receiving ID. | 25 (00 to 99) | |
| 7. RX REDUCTION | Enables/disables automatic reduction of faxes to fit the paper loaded. | ON OFF | |
| REDUCE DIMENSION | Selects the direction of the reduction. | VERTICAL ONLY HORIZ&VERTICAL | |
| 8. RX START SPEED | Selects the speed at which the machine starts receiving. | 3360bps 14400bps 9600bps 7200bps 4800bps 2400bps | |
| 3. PRINTER SETTINGS | — | — | |
| 1. QUIET MODE | Enables/disables quiet printing mode. | OFF ON | |
| 2. EXTENSION AMOUNT | For borderless printing or copying, selects the width cropped from the borders of the original image. | SMALL LARGE | |
| 4. SYSTEM SETTINGS | — | | |
| 1. Fax Model AUDIBLE TONES | | | |
| 1. KEYPAD VOLUME | Selects the beep volume when pressing keys on the operation panel. | 0 (off)/1/ 2 /3 | |
| 2. ALARM VOLUME | Selects the alarm volume. | 0 (off)/1/ 2 /3 | |
| 2. CARD PROTECT | Enables/disables overwriting memory card data in all modes except photo print mode. | ON OFF | p. 4-10 |
| 3. DISPLAY LANGUAGE | Selects the language for LCD messages and reports. | ENGLISH FRENCH SPANISH PORTUGUESE | |
| 4. Fax Model DAYLGH T SAV TIME | Enables/disables daylight saving. If you select <ON>, you can select additional sub-settings. | ON OFF | UG |

Fax Model **Menu: RECEIVE MODE** **Function key: [Fax]**

| Name | Description | Setting | Details |
|------------------|--|---------|---------|
| FAX/TEL AUTO SW | Selects <FAX/TEL AUTO SW> receive mode. | — | UG |
| FAX ONLY MODE | Selects <FAX ONLY MODE> receive mode. | — | UG |
| DRPD | Selects <DRPD> receive mode. | — | UG |
| MANUAL MODE | Selects <MANUAL MODE> receive mode. | — | p. 7-8 |
| ANS.MACHINE MODE | Selects <ANS.MACHINE MODE> receive mode. | — | UG |

Fax Model **Menu: MEMORY REFERENCE** **Function key: [Fax]**

These settings can only be accessed when there is a document in memory.

| Name | Description | Setting | Details |
|---------------------|-------------------------------|---------|---------|
| 1. DOC. MEMORY LIST | Prints the DOC. MEMORY LIST. | — | UG |
| 2. PRINT DOCUMENT | Prints a document in memory. | — | UG |
| 3. DELETE DOCUMENT | Deletes a document in memory. | — | UG |

Fax Model **Menu: REPORTS/LISTS** **Function key: [Fax]**

| Name | Description | Setting | Details |
|---------------------|--|-----------------|---------|
| 1. ACTIVITY REPORT | Prints an ACTIVITY REPORT. | — | UG |
| 2. SPEED DIAL LIST | — | — | |
| 1. 1-TOUCH LIST | Prints the 1-TOUCH SPD DIAL LIST. | — | UG |
| SORTED OUTPUT | Selects the order of the destinations in the list. <YES=(*)>: Prints the list in alphabetical order. <NO=#>: Prints the list in key order. | YES=(*) NO=# | |
| 2. CODED DIAL LIST | Prints the CODED SPEED DIAL LIST. | — | UG |
| SORTED OUTPUT | Selects the order of the destinations in the list. <YES=(*)>: Prints the list in alphabetical order. <NO=#>: Prints the list in key order. | YES=(*) NO=# | |
| 3. GROUP DIAL LIST | Prints the GROUP DIAL LIST. | — | UG |
| 3. USER DATA LIST | Prints the USER DATA LIST. | — | UG |
| 4. DOC. MEMORY LIST | Prints the DOC. MEMORY LIST. | — | UG |

Menu: PHOTO PRINT MODE Function key: [Photo Print]

| Name | Description | Setting | Details |
|---------------------|--|--|---------|
| 1. PHOTO PRINT MODE | | — | |
| INDEX | — | | p. 4-5 |
| SELECT PAPER SIZE | Selects the print media size for the index. | LTR 4" × 6" 5" × 7" A4 | |
| SELECT PAPER TYPE | Selects the print media type for the index. | PHOTO PAPER PRO PLAIN PAPER | |
| ALL FRAMES | — | — | p. 4-6 |
| SELECT PAPER SIZE | Selects the print media size for the photographs. | LTR 4" × 6" 5" × 7" A4 | |
| SELECT PAPER TYPE | Selects the print media type for the photographs. | PHOTO PAPER PRO PLAIN PAPER | |
| BORDERLESS PRINT | If you select <PHOTO PAPER PRO>, enables/disables borderless printing for the photographs. | OFF ON | |
| SINGLE FRAME | — | — | p. 4-8 |
| FILE NO: | Selects the file number. | 0001 to 9999 | |
| NUMBER OF PRINTS | Selects the number of copies. | 1 to 99 COPIES | |
| SELECT PAPER SIZE | Selects the print media size for the photograph. | LTR 4" × 6" 5" × 7" A4 | |
| SELECT PAPER TYPE | Selects the print media type for the photograph. | PHOTO PAPER PRO PLAIN PAPER | |
| BORDERLESS PRINT | If you select <PHOTO PAPER PRO>, enables/disables borderless printing for the photograph. | OFF ON | |
| FRAME RANGE | — | — | UG |
| FIRST FILE: | Selects the first photograph number. | 0001 to 9999 | |
| LAST FILE: | Selects the last photograph number. | 0001 to 9999 | |
| SELECT PAPER SIZE | Selects the print media size for the photographs. | LTR 4" × 6" 5" × 7" A4 | |
| SELECT PAPER TYPE | Selects the print media type for the photograph. | PHOTO PAPER PRO PLAIN PAPER | |
| BORDERLESS PRINT | If you select <PHOTO PAPER PRO>, enables/disables borderless printing for the photographs. | OFF ON | |

| Name | Description | Setting | Details |
|----------------------|--|--|---------|
| DPOF | — | — | UG |
| SELECT PAPER SIZE | Selects the print media size for the photographs. | LTR 4" × 6" 5" × 7" A4 | |
| SELECT PAPER TYPE | Selects the print media type for the photographs. | PHOTOPAPER PRO PLAIN PAPER | |
| BORDERLESS PRINT | If you select <PHOTO PAPER PRO>, enables/disables borderless printing for the photographs. | OFF ON | |
| 2. VIVID PHOTO PRINT | Enables/disables to make colors, especially blues and greens, appear more vibrant. | OFF ON | UG |
| 3. PRINT PHOTO DATE | Enables/disables date printing. | OFF ON | UG |

► General specifications

| | |
|--|---|
| Power source | 120 V/60 Hz |
| Power consumption | <ul style="list-style-type: none"> • Maximum: Approx. 39.1 W • Fax Model Approx. 51.5 W • Standby: Approx. 8.0 W • Fax Model Approx. 10.4 W |
| Weight (Components attached) | 24 lb./10.9 kg |
| Dimensions | Fax Model 28.2 lb./12.8 kg |

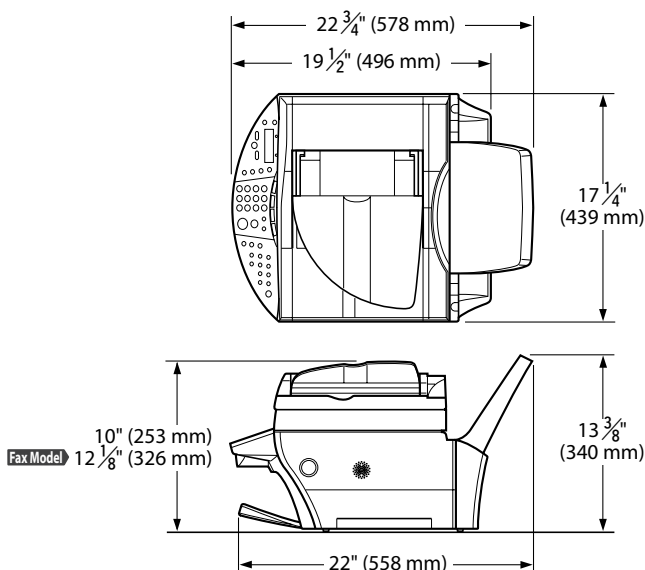

| | |
|--------------------------------------|---|
| Environmental conditions | <ul style="list-style-type: none"> • Temperature: 59°–81.5°F (15°–27.5°C) • Humidity: 20%–80% |
| Liquid Crystal Display (LCD) | 20 × 2 |
| Display languages | English/French/Spanish/Portuguese |
| Applicable standards | <ul style="list-style-type: none"> • Electrical safety: UL 1950, C-UL • Radiation: FCC Part 15 Class B, IC, Class B • Fax Model PTT: FCC part 68, IC CS-03 • Other: Energy Star Compliant, FCC sec.255 |
| Fax Model ADF capacity | → p. 2-1 |
| Multi-purpose tray capacity | → p. 2-3 |

Printable areas

Note on printing area illustrations:

Printing area: Canon recommends that you print within (dark shade) this area.

Printable area: The area where it is possible to print. (light shade) However, printing in this area can adversely affect print quality or paper feed precision.

• Paper printable areas:

Letter size: $8 \times 10 \frac{3}{4}$ in. (203.2 \times 271.4 mm)

Legal size: $8 \times 13 \frac{3}{4}$ in. (203.2 \times 347.6 mm)

4" \times 6" size: $3 \frac{3}{4} \times 5 \frac{3}{4}$ in. (94.8 \times 144.4 mm)

5" \times 7" size: $4 \frac{3}{4} \times 6 \frac{3}{4}$ in. (120.2 \times 169.8 mm)

A4 size: $8 \times 11 \frac{3}{8}$ in. (203.2 \times 289 mm)

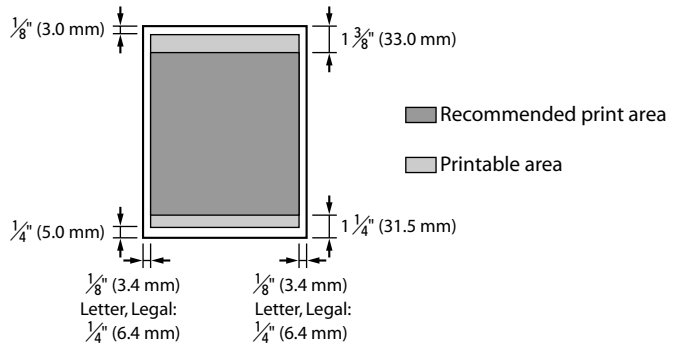

NOTE

- Borderless printing allows you to make prints with no margins. However, it may cause the top and bottom paper edges to decrease in print quality or become soiled.

• Envelope printable areas:

US COM #10: $8 \frac{3}{8} \times 3 \frac{7}{8}$ in. (211.8 \times 98 mm)

European DL: $7 \frac{1}{2} \times 4 \frac{1}{8}$ in. (190.5 \times 103.2 mm)

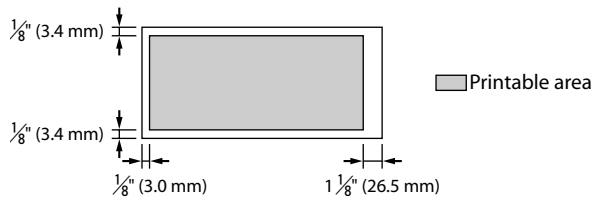

• **Banner paper printable areas:**

Letter size: $8 \times 65 \frac{3}{4}$ in. (203.2 \times 1668.4 mm)

A4 size: $8 \times 69 \frac{7}{8}$ in. (203.2 \times 1774 mm)

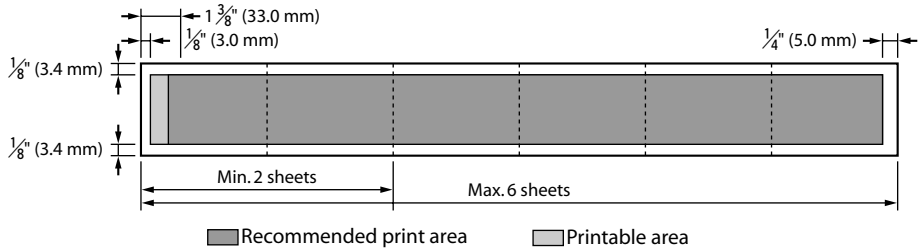

Scanned area

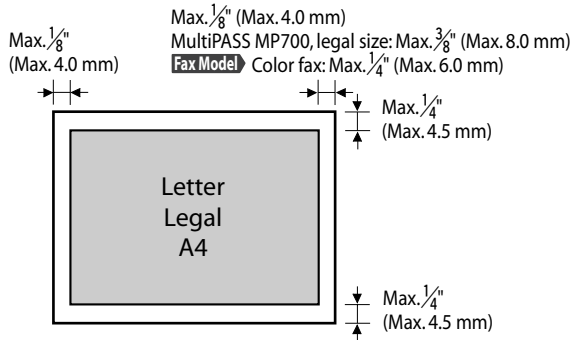

NOTE

- For entire image copying, the entire area of the document is scanned.

► **System requirements**

→ p. 1-2

► **Ink specifications**

Ink tank colors/capacity

- Black (BCI-3eBK): approx. 775*, approx. 1500*
- Cyan (BCI-3eC): approx. 570**
- Magenta (BCI-3eM): approx. 440**
- Yellow (BCI-3eY): approx. 380**

* 1500 characters per page, normal text, at standard and plain paper mode with XP printer driver.

** Based on printing the ISO JIS-SCID No. 5 pattern at standard and plain paper mode with XP printer driver.

► Print specifications

| | |
|------------------------------------|--|
| Printing method | Bubble jet on-demand |
| Paper handling | Automatic feed |
| Print media size and weight | → p. 2-3 |
| Recommended print media | → p. 2-3 |
| Print speed | <ul style="list-style-type: none">• Black printing: Fast: 22 pages/minute Standard: 13.0 pages/minute• Color printing: Fast: 14 pages/minute Standard: 9.0 pages/minute (Based on Canon standard pattern) |
| Print width | <ul style="list-style-type: none">• Max. 8 in. (203.2 mm)• Borderless printing: 8 ½ in. (216.0 mm) |
| Printing resolution | Max. 4800 (horizontal) × 1200 (vertical) dpi |

► Photo print specifications

| | |
|--------------------|--|
| Interface | Card slot |
| Memory card | <ul style="list-style-type: none">• Compact flash (Except Microdrive)—Type I, II• Smart media• Memory stick• SD memory card• Multimedia card |
| Print media | <ul style="list-style-type: none">• Plain paper• Photo Paper Pro PR-101/PC-101S• Photo Paper Plus Glossy PP-101• Matte Photo Paper MP-101 |
| Layout | <ul style="list-style-type: none">• Photo Paper Pro: Letter/A4: With/without borders, index (max. 70 frames) Card: With borders, index (max. 15 frames)• Plain paper: Letter/A4: With/without borders, index (max. 70 frames) |
| Features | <ul style="list-style-type: none">• Date printing• Vivid photo printing• DPOF function-compatible (Index printing, specified quantity, specified frames, date printing, image number printing) |

► Copy specifications

| | |
|---------------------------|---|
| Copy speed | <ul style="list-style-type: none">• Black & white: <B&W DRAFT> Approx. 22 pages/minute (letter size)• Color: <COLOR FAST> Approx. 14 pages/minute (letter size) (Based on BJ printer specific speed test pattern.) |
| No. of copies | Maximum 99 copies |
| Density adjustment | 9 levels |
| Zoom | 25%–400% |

Fax Model Fax specifications

| | |
|----------------------------------|---|
| Applicable line | Public Switched Telephone Network (PSTN) |
| Compatibility | G3 |
| Data compressing system | MH, MR, MMR, JBIG, JPEG |
| Modem type | Fax modem |
| Modem speed | 33600/14400/9600/7200/4800/2400 bps Automatic fallback |
| Transmission speed | <ul style="list-style-type: none">• Black & white: Approx. 3 seconds/page at 33.6 Kbps, ECM-MMR, transmitting from memory (Based on ITU-T No.1 Chart, standard mode.)• Color: Approx. 1 minute/page at 33.6 Kbps, ECM-JPEG, transmitting from memory (Based on Canon COLOR FAX TEST SHEET.) |
| Scanning image processing | <ul style="list-style-type: none">• UHQ™ (Ultra High Quality) image enhancement• Halftones: 64 levels of gray• Density adjustment: 3 levels |
| Memory | Transmission/reception: 250 pages (Based on ITU-T No.1 Chart, standard mode.) |
| Fax scanning speed | Approx. 5.3 seconds/page (Based on ITU-T No.1 Chart, standard mode.) |
| Fax resolution | <ul style="list-style-type: none">• <B&W STANDARD>: 203 pels/in. × 98 lines/in. (8 pels/mm × 3.85 lines/mm)• <B&W FINE>, <B&W PHOTO>: 203 pels/in. × 196 lines/in. (8 pels/mm × 7.70 lines/mm)• <COLOR STANDARD>, <COLOR FINE>: 200 × 200 dpi |
| Dialing | <ul style="list-style-type: none">• Automatic dialing• One-touch speed dialing (10 destinations)• Coded speed dialing (100 destinations)• Group dialing (Max. 109 destinations)• Regular dialing (with numeric keys)• Automatic redialing• Manual redialing (with [Redial/Pause] key) |
| Networking | <ul style="list-style-type: none">• Sequential broadcast (Max. 111 destinations)• Automatic reception• Automatic fax/tel switchover• DRPD (Distinctive Ring Pattern Detection)• Remote reception by telephone (Default ID: 25)• Non-ring reception• ECM deactivation• ACTIVITY REPORT (after every 20 transactions)• Non-delivery report• TTI (Transmit Terminal Identification) |

► Scan specifications

| | |
|----------------------------------|--|
| Compatibility | TWAIN/WIA (Windows XP) |
| Scanning speed | <ul style="list-style-type: none">• Black & white text/grayscale, 300 dpi: Min. 5.3 seconds/page (Letter size)• Color, 150 dpi: Min. 15.9 seconds/page (Letter size) (Data transfer not included) |
| Scanning resolution | <ul style="list-style-type: none">• 1200 × 2400• 9600 dpi enhanced |
| Scanning image processing | <ul style="list-style-type: none">• Halftones: 256 levels of gray• Color: 16,777,216 colours |

► Telephone specifications

| | |
|-------------------|---|
| Connection | Telephone/answering machine (CNG detecting signal)/data modem |
|-------------------|---|

Specifications subject to change without notice.

Index

- ◀ (-) key 1-4
- ▶ (+) key 1-4
- ADF 1-3
 - loading documents in 2-2
 - requirements for loading 2-1
- Alarm light 1-4
- Aligning printhead 9-5, 9-6
- All frames printing 4-6, 4-7
- Automatic Document Feeder. *See* ADF
- B&W key 1-5
- Black & white
 - copying 5-1
 - sending from machine 7-3
- Canceling
 - memory sending from machine 7-3
- Card slot 1-3
- CD-ROM 1-1
- Characters, entering 7-2
- Cleaning
 - printhead 9-4
- Coded Dial key 1-5
- Coded speed dialing
 - registering 7-5, 7-6
 - using 7-6
- Color
 - copying 5-1
 - key 1-5
 - sending from machine 7-3
- Components 1-3 to 1-5
- Computer
 - problems printing from 10-2 to 10-5
 - problems turning on 10-2
- Copy key 1-4
- Copying 5-1
 - adjusting exposure 5-2
 - adjusting image quality 5-2
 - document requirements 2-1
 - in black & white 5-1
 - in color 5-1
 - problems 10-12
- Date entering 7-1
- Density. *See* Exposure
- Destination labels 1-1
- Document
 - cover 1-3
 - guides 1-3
 - loading 2-2
 - output slot 1-3
 - problems 2-1
 - removing jams 10-16, 10-17
 - requirements 2-1
 - tray 1-1, 1-3
- Documentation 1-1
- Enlarge/Reduce key 1-4
- Envelopes 2-3
- Exposure
 - adjusting for copying 5-2
 - key 1-4
- Fax
 - key 1-4
 - Resolution. *See* Image quality
 - sending 6-1
- Features 1-1
- Feeder cover 1-3
- Glossy Photo Paper GP-301/GP301N 2-3
- High Resolution Paper HR-101N 2-3
- Hook key 1-5
- Image quality
 - adjusting for copying 5-2
 - adjusting for sending from machine 7-3, 7-4
- Image Quality key 1-4
- In Use/Memory light 1-4
- Index printing 4-5
- Indicator light 1-3
- Ink tank 1-1
 - guidelines 9-1
 - replacing 9-2
 - when to replace 9-1
- Jams
 - removing document 10-16, 10-17
 - removing paper 10-15, 10-16
- LCD 1-4
 - if nothing displays 10-14
- Machine 1-1
- MAINTENANCE menu 11-2
- MANUAL MODE 7-8
- Matte Photo Paper MP-101 2-3

- Memory card 4-1
 - Inserting 4-2
 - problems using 10-12, 10-13
 - removing 4-2
- MEMORY REFERENCE menu 11-6
- Memory sending from machine 7-3
- Menu key 1-4
- Menus 11-2 to 11-8 . *See also individual menu names*
- Multi-purpose tray 1-1, 1-3
- Nozzle check pattern, printing 9-4
- Numeric keys 1-5
- ON/OFF (1 sec.) key 1-5
- One-touch speed dialing
 - keys 1-5
 - registering 7-4, 7-5
 - using 7-6
- Open button 1-3
- Operation panel 1-3 to 1-5
- Paper
 - loading 2-5
 - removing jams 10-15, 10-16
 - Select key 1-4
- Paper output tray 1-1, 1-3
 - removing jams in 10-15
- Paper thickness lever 1-3
 - setting 2-4
- Photo Paper
 - Plus Glossy PP-101 2-3
 - Pro PC-101S 2-3
 - Pro PR-101 2-3
- Photo Print key 1-5
- PHOTO PRINT MODE menu 11-7
- Photo printing
 - all frames 4-6, 4-7
 - index 4-5, 4-6
 - methods 4-4
 - problems 10-12, 10-13
 - single frame 4-8 to 4-9
- Plain paper 2-3
- Platen glass 1-3
 - loading documents on 2-2
 - requirements for loading on 2-1
- Power
 - cord 1-1
 - problems 10-14
- Print media
 - recommended 2-3
 - setting size 2-4
 - setting type 2-4
- Printer cover 1-3
- Printhead 1-1
 - aligning 9-5, 9-6
 - cleaning 9-4
 - holder 1-3
 - maintaining 9-3
- Printing
 - document 3-1
 - problems 10-2 to 10-5
- Problems
 - cannot solve 10-18
 - copying 10-12
 - documents 2-1
 - installing software 10-1
 - power 10-14
 - printing from computer 10-2 to 10-5
 - receiving faxes 10-8, 10-10
 - removing software 10-1
 - scanning 10-6, 10-8
 - sending 10-11, 10-12
 - telephone 10-12
 - turning on computer 10-2
 - using memory card 10-12, 10-13
- Receive mode
 - setting from machine 7-7
- RECEIVE MODE menu 11-6
- Receiving to machine problems 10-12
- Redial/Pause key 1-5
- Replacing ink tanks 9-2
- REPORTS/LISTS menu 11-6
- Resolution. *See* Image quality
- Resume key 1-4
- Scan
 - exposure. *See* Exposure
 - key 1-5, 8-1
- Scanning
 - document requirements 2-1
 - methods 8-1
 - problems 10-6, 10-8
 - with Scan key 8-1
- Scanning unit 1-3
- Sender information
 - entering from machine 7-1, 7-2
- Sending from computer problems 10-11, 10-12
- Sending from machine
 - document requirements 2-1
 - memory 7-3
 - methods 7-3
- Sending from machine problems 10-11, 10-12
- Set key 1-4
- Settings 11-2 to 11-8
 - accessing 11-1
- Single frame printing 4-8 to 4-9
- Software
 - problems installing 10-1

- problems removing 10-1
- SPECIAL COPY menu 11-2
- Speed dialing
 - registering 7-4 to 7-6
 - using 7-6
- Start key 1-5
- Stop/Reset key 1-5
- Symbols, entering 7-2
- System requirements 1-2
- Telephone line
 - cord 1-1
- Telephone line type
 - setting from machine 7-1
- Telephone problems 10-12
- Tone key 1-5
- Transparencies CF-102 2-3
- Tray cover 1-3
- T-Shirt Transfers TR-201 2-3
- USER DATA menu 11-3 to 11-5
- VIVID PHOTO PRINT menu 11-8

Canon U.S.A., Inc.
Limited Warranty—U.S. Only

The limited warranty set forth below is given by Canon U.S.A., Inc. ("Canon") with respect to the Canon brand computer peripheral product (the "product") that you have purchased, when purchased and used in the United States. The product that you have purchased is the only product to which this warranty card and the limited warranty provided by Canon and stated on the card apply.

Your product, when delivered to you in new condition in its original container, is warranted against defects in materials or workmanship as follows: for a period of one (1) year from the date of original purchase, defective parts or a defective product returned to a Canon repair facility or a Canon Authorized Service Facility ("ASF") for such product, as applicable, and proven to be defective upon inspection, will be exchanged for new or comparable rebuilt parts, or a refurbished product, as determined by the Canon repair facility or the ASF. Warranty repair or replacement shall not extend the original warranty period of the defective product. This limited warranty does not cover any supplies or accessories, including without limitation print heads, ink cartridges and ink tanks, as to which there shall be no warranty or replacement.

This limited warranty shall only apply if the product is used in conjunction with compatible computer equipment and compatible software, as to which items Canon shall have no responsibility.

Non-Canon brand equipment and software that may be distributed with the product are sold "as is," without warranty of any kind by Canon, including any implied warranty regarding merchantability or fitness for a particular purpose, and all such warranties are disclaimed. The sole warranty, if any, with respect to such non-Canon brand items is given by the manufacturer or producer thereof.

This limited warranty covers all defects encountered in normal use of the product, and does not apply in the following cases:

- (a) Loss of or damage to the product due to abuse, mishandling, improper packaging by you, alteration, accident, electrical current fluctuations, failure to follow operating, maintenance or environmental instructions prescribed in Canon's instruction manual, or service performed by other than a Canon repair facility or an ASF.
- (b) Use of parts or supplies (other than those sold by Canon) that cause damage to the product or cause abnormally frequent service calls or service problems.
- (c) If the product has had its serial number or dating altered or removed.

NO IMPLIED WARRANTY, INCLUDING ANY IMPLIED WARRANTY OF MERCHANTABILITY OR FITNESS FOR A PARTICULAR PURPOSE, APPLIES TO THE PRODUCT AFTER THE APPLICABLE PERIOD OF THE EXPRESS LIMITED WARRANTY STATED ABOVE, AND NO OTHER EXPRESS WARRANTY OR GUARANTY, EXCEPT AS MENTIONED ABOVE, GIVEN BY ANY PERSON OR ENTITY WITH RESPECT TO THE PRODUCT SHALL BIND CANON. (SOME STATES DO NOT ALLOW LIMITATIONS ON HOW LONG AN IMPLIED WARRANTY LASTS, SO THE ABOVE LIMITATION MAY NOT APPLY TO YOU.) CANON SHALL NOT BE LIABLE FOR LOSS OF REVENUES OR PROFITS, INCONVENIENCE, EXPENSE FOR SUBSTITUTE EQUIPMENT OR SERVICE, STORAGE CHARGES, LOSS OR CORRUPTION OF DATA, OR ANY OTHER SPECIAL, INCIDENTAL OR CONSEQUENTIAL DAMAGES CAUSED BY THE USE OR MISUSE OF, OR INABILITY TO USE THE PRODUCT, REGARDLESS OF THE LEGAL THEORY ON WHICH THE CLAIM IS BASED, AND EVEN IF CANON HAS BEEN ADVISED OF THE POSSIBILITY OF SUCH DAMAGES. IN NO EVENT SHALL RECOVERY OF ANY KIND AGAINST CANON BE GREATER IN AMOUNT THAN THE PURCHASE PRICE OF THE PRODUCT SOLD BY CANON WHICH CAUSED THE ALLEGED DAMAGE. WITHOUT LIMITING THE FOREGOING, YOU ASSUME ALL RISK AND LIABILITY FOR LOSS, DAMAGE OR INJURY TO YOU AND YOUR PROPERTY AND TO OTHERS AND THEIR PROPERTY ARISING OUT OF USE OR MISUSE OF, OR INABILITY TO USE THE PRODUCT NOT CAUSED DIRECTLY BY THE NEGLIGENCE OF CANON. (SOME STATES DO NOT ALLOW THE EXCLUSION OR LIMITATION OF INCIDENTAL OR CONSEQUENTIAL DAMAGES, SO THE ABOVE EXCLUSION OR LIMITATION MAY NOT APPLY TO YOU.) THIS LIMITED WARRANTY SHALL NOT EXTEND TO ANYONE OTHER THAN THE ORIGINAL PURCHASER OF THE PRODUCT, OR THE PERSON FOR WHOM IT WAS PURCHASED AS A GIFT, AND STATES YOUR EXCLUSIVE REMEDY.

You may obtain technical support* for your product as follows:

- For e-mail technical support, the latest driver downloads and answers to frequently asked questions (www.usa.canon.com/consumer)
- 24-hour, 7-day-a-week, automated support for troubleshooting issues on most current products (1-800-423-2366)
- 24-hour, Fax-On-Demand System for product specifications and technical information (1-800-526-4345)
- Free technical support Monday–Saturday (excluding holidays) for products still under warranty (1-757-413-2848)
- Technical support 7 days a week (excluding holidays) for products no longer under warranty, at \$9.99 per incident (1-757-413-2848)

If the problem can't be corrected by using one of the above technical support options, you will be asked to follow the applicable procedures for warranty service. **Note that a dated proof of purchase (bill of sale) is required to verify eligibility at the time of service. This requirement will be satisfied by providing a copy of your dated bill of sale. You will also need to supply the product serial number.**

InstantExchange[†]

InstantExchange is a warranty program that expedites, usually by the next business day, ^{††} the exchange of a defective product with a refurbished product. The refurbished product you receive will be covered by the balance of the period remaining on your original limited warranty. **Note that by using this service you will keep the replacement product that is sent to you, and your originally purchased product shall become the property of Canon.**

InstantExchange warranty program service is available only during the express limited-warranty period for your product and only in the continental United States, Alaska and Hawaii during such period.

If the Canon Customer Care Center representative cannot correct the problem with your product over the telephone, and you elect InstantExchange warranty program service, the representative will issue you a reference number upon verification of warranty eligibility. You will be asked for information pertaining to your defective product and for a ship-to location for the replacement product (street address only). You must also provide a major credit card number that will be pre-authorized by Canon in an amount up to the cost of a new product at the time you elect InstantExchange warranty program service. **Your credit card number will be charged in an amount up to the cost of a new product** (i) if you do not return your defective product to a Canon repair facility by the date specified by Canon and in the manner described below; (ii) if the defect(s) in the product is/are not covered by this limited warranty; or (iii) if the warranty period on the product has expired or has not been sufficiently established by your supplying the appropriate documentation.

The Canon repair facility will ship out the replacement product via overnight courier, prepaid by Canon.

After receipt of the replacement product (with instructions and a pre-paid return waybill), follow the instructions to ship the defective product to a Canon repair facility. You must return the defective product in the shipping carton in which the replacement product was packed (be sure to retain your ink cartridges and tanks), and you must include the reference number, **a copy of your dated proof of purchase** (bill of sale) and a complete explanation of the problem. **Do not include any other items in the return shipping container.**

Carry-In/ Mail-In

Carry-In/Mail-In is a service program by which your defective product is repaired by an ASF. The name and telephone number of the ASF(s) nearest to your location may be obtained from our Web site at www.usa.canon.com, or by calling the Canon Customer Care Center at 1-800-423-2366. If shipping is involved, it is your responsibility to properly package and send your defective product, together with your dated proof of purchase, a complete explanation of the problem and a return address, to the ASF at your expense. **Do not include any other items with your product.** The repair(s) covered by this limited warranty will be made and the product will be returned to you without charge by the ASF. Repairs not covered under this limited warranty will be charged to you at such costs as each ASF may generally establish from time to time.

This limited warranty gives you specific legal rights, and you may also have other rights that vary from state to state.

* Support program specifics are subject to change without notice.

† InstantExchange warranty program service is subject to availability of refurbished replacement units.

†† 9 a.m.–5 p.m.(local), Monday–Friday (excluding holidays). The Canon Customer Care Center must receive pertinent information by 3 p.m. (E.S.T.) to ensure next-business-day InstantExchange warranty program service (two-business-day InstantExchange warranty service for Alaska and Hawaii). Canon does not guarantee next-business-day service in the event of factors beyond Canon's reasonable control.

Index

- 2 (-) key 1-4
- 3 (+) key 1-4
- ADF 1-3
 - loading documents in 2-2
 - requirements for loading 2-1
- Alarm light 1-4
- Aligning printhead 9-5, 9-6
- All frames printing 4-6, 4-7
- Automatic Document Feeder. *see* ADF
- B&W key 1-5
- Black & white
 - copying 5-1
 - sending from machine 7-3
- Canceling
 - memory sending from machine 7-3
- Card slot 1-3
- CD-ROM 1-1
- Characters, entering 7-2
- Cleaning
 - printhead 9-4
- Coded Dial key 1-5
- Coded speed dialing
 - registering 7-5, 7-6
 - using 7-6
- Color
 - copying 5-1
 - key 1-5
 - sending from machine 7-3
- Components 1-3 to 1-5
- Computer
 - problems printing from 10-2 to 10-5
 - problems turning on 10-2
- Copy key 1-4
- Copying 5-1
 - adjusting exposure 5-2
 - adjusting image quality 5-2
 - document requirements 2-1
 - in black & white 5-1
 - in color 5-1
 - problems 10-12
- Date entering 7-1
- Density. *See* Exposure
- Destination labels 1-1
- Document
 - cover 1-3
 - guides 1-3
 - loading 2-2
 - output slot 1-3
 - problems 2-1
 - removing jams 10-16, 10-17
 - requirements 2-1
 - tray 1-1, 1-3
- Documentation 1-1
- Enlarge/Reduce key 1-4
- Envelopes 2-3
- Exposure
 - adjusting for copying 5-2
 - key 1-4
- Fax
 - key 1-4
 - Resolution. *See* Image quality
 - sending 6-1
- Features 1-1
- Feeder cover 1-3
- Glossy Photo Paper GP-301/GP301N 2-3
- High Resolution Paper HR-101N 2-3
- Hook key 1-5
- Image quality
 - adjusting for copying 5-2
 - adjusting for sending from machine 7-3, 7-4
- Image Quality key 1-4
- In Use/Memory light 1-4
- Index printing 4-5
- Indicator light 1-3
- Ink tank 1-1
 - guidelines 9-1
 - replacing 9-2
 - when to replace 9-1
- Jams
 - removing document 10-16, 10-17
 - removing paper 10-15, 10-16
- LCD 1-4
 - if nothing displays 10-14
- Machine 1-1
- MAINTENANCE menu 11-2
- MANUAL MODE 7-8
- Matte Photo Paper MP-101 2-3
- Memory card 4-1
 - Inserting 4-2
 - problems using 10-12, 10-13

- removing 4-2
- MEMORY REFERENCE menu 11-6
- Memory sending from machine 7-3
- Menu key 1-4
- Menus 11-2 to 11-8
 - . See also individual menu names
- Multi-purpose tray 1-1, 1-3
- Nozzle check pattern, printing 9-4
- Numeric keys 1-5
- ON/OFF (1 sec.) key 1-5
- One-touch speed dialing
 - keys 1-5
 - registering 7-4, 7-5
 - using 7-6
- Open button 1-3
- Operation panel 1-3 to 1-5
- Paper
 - loading 2-5
 - removing jams 10-15, 10-16
 - Select key 1-4
- Paper output tray 1-1, 1-3
 - removing jams in 10-15
- Paper thickness lever 1-3
 - setting 2-4
- Photo Paper
 - Plus Glossy PP-101 2-3
 - Pro PC-101S 2-3
 - Pro PR-101 2-3
- Photo Print key 1-5
- PHOTO PRINT MODE menu 11-7
- Photo printing
 - all frames 4-6, 4-7
 - index 4-5, 4-6
 - methods 4-4
 - problems 10-12, 10-13
 - single frame 4-8 to 4-9
- Plain paper 2-3
- Platen glass 1-3
 - loading documents on 2-2
 - requirements for loading on 2-1
- Power
 - cord 1-1
 - problems 10-14
- Print media
 - recommended 2-3
 - setting size 2-4
 - setting type 2-4
- Printer cover 1-3
- Printhead 1-1
 - aligning 9-5, 9-6
 - cleaning 9-4
 - holder 1-3
 - maintaining 9-3
- Printing
 - document 3-1
 - problems 10-2 to 10-5
- Problems
 - cannot solve 10-18
 - copying 10-12
 - documents 2-1
 - installing software 10-1
 - power 10-14
 - printing from computer 10-2 to 10-5
 - receiving faxes 10-8, 10-10
 - removing software 10-1
 - scanning 10-6, 10-8
 - sending 10-11, 10-12
 - telephone 10-12
 - turning on computer 10-2
 - using memory card 10-12, 10-13
- Receive mode
 - setting from machine 7-7
- RECEIVE MODE menu 11-6
- Receiving to machine problems 10-12
- Redial/Pause key 1-5
- Replacing ink tanks 9-2
- REPORTS/LISTS menu 11-6
- Resolution. See Image quality
- Resume key 1-4
- Scan
 - exposure. See Exposure
 - key 1-5, 8-1
- Scanning
 - document requirements 2-1
 - methods 8-1
 - problems 10-6, 10-8
 - with Scan key 8-1
- Scanning unit 1-3
- Sender information
 - entering from machine 7-1, 7-2
- Sending from computer problems 10-11, 10-12
- Sending from machine
 - document requirements 2-1
 - memory 7-3
 - methods 7-3
- Sending from machine problems 10-11, 10-12
- Set key 1-4
- Settings 11-2 to 11-8
 - accessing 11-1
- Single frame printing 4-8 to 4-9
- Software
 - problems installing 10-1
 - problems removing 10-1
- SPECIAL COPY menu 11-2

Speed dialing
 registering 7-4 to 7-6
 using 7-6
Start key 1-5
Stop/Reset key 1-5
Symbols, entering 7-2
System requirements 1-2
Telephone line
 cord 1-1
Telephone line type
 setting from machine 7-1
Telephone problems 10-12
Tone key 1-5
Transparencies CF-102 2-3
Tray cover 1-3
T-Shirt Transfers TR-201 2-3
USER DATA menu 11-3 to 11-5
VIVID PHOTO PRINT menu 11-8

Quick Reference Guide

Canon U.S.A., Inc.

One Canon Plaza, Lake Success, NY 11042, U.S.A.

Canon Inc.

30-2, Shimomaruko 3-chome, Ohta-ku, Tokyo 146-8501, Japan

Canon Australia Pty. Ltd.

1 Thomas Holt Drive, North Ryde, Sydney, N.S.W. 2113, Australia

Canon Canada, Inc.

6390 Dixie Road, Mississauga, Ontario, L5T 1P7, Canada

Canon Deutschland GmbH

Europark Fichtenhain A10, 47807 Krefeld, Germany

Canon Europa N.V.

Bovenkerkerweg 59-61 P.O. BOX 2262, 1180 EG Amstelveen, The Netherlands

Canon France S.A.

17 quai du Président Paul Doumer, 92414 Courbevoie Cedex, France

Canon Hong Kong Co., Ltd.

9/F, The Hong Kong Club Building, 3A Chater Road, Central, Hong Kong

Canon Latin America, Inc.

703 Waterford Way, Suite 400, Miami, FL 33126, U.S.A.

Canon Mexicana S. de R.L. de C.V.

Periferico Sur No. 4124 Col. Ex-Rancho de Anzaldo, C.P. 01900, Mexico, D.F.

Canon Singapore Pte. Ltd.

79 Anson Road, #09-01/06, Singapore 079906

Canon (U.K.) Ltd.

Woodhatch, Reigate, Surrey, RH2 8BF, United Kingdom