

Canon

Exif Print



PictBridge

Photo Printer

PIXMA iP100 series

Quick Start Guide



QT51438V02

Getting Help from Canon

Help Us Help You Better

Before you contact Canon, please record the following information.

Serial Number (located on the back of the product): _____

Model Number (located on the top of the product): _____

Setup CD-ROM number (located on the CD-ROM): _____

Purchase Date: _____

Customer Technical Support Sequence*

1. Internet — www.canontechsupport.com

For quick and comprehensive self-help in an intuitively guided interactive troubleshooting environment, the place to start is our helpful tech support web site. In addition, the latest driver downloads, answers to frequently asked questions, product information, and “where to buy” instructions are found here.

2. Email Tech Support — www.canontechsupport.com

For individual attention to a special issue, try emailing our friendly technical support representatives, specially trained to communicate quick, easy, and logical solutions to your inquiries within 24 hours.

3. Toll-Free Live Tech Support — (1-800-828-4040)

This option provides live telephone technical support, free of service charges, Monday-Saturday (excluding holidays), during your product's 1 year limited warranty period. Telephone Device for the Deaf (TDD) support is available at (1-866-251-3752).

4. Extended Service and Support — www.canonesp.com

Canon CarePAK Extended Service Plan is a cost-attractive and easy-to-use extended service program that provides up to three full years of service and support coverage at a very attractive price. CarePAK offers toll-free Canon technical support and includes Canon's superb InstantExchange product replacement program. For further information about extending your Canon service and support, call (1-800-385-2155), or visit our Web site at www.canonesp.com. CarePAK must be purchased during your product's warranty period.

For more information and updated program specifics, please visit our web site at www.canontechsupport.com.

* Support program specifics are subject to change without notice.

Canon

PIXMA iP100 series

Photo Printer

Quick Start Guide

© **CANON INC.2008**

All rights reserved. No part of this publication may be transmitted or copied in any form whatsoever without the express written permission.

Disclaimer

Canon U.S.A., Inc. has reviewed this manual thoroughly in order that it will be an easy-to-use guide to your Canon PIXMA iP100 series Photo Printer. All statements, technical information and recommendations in this manual and in any guides or related documents are believed reliable, but the accuracy and completeness thereof are not guaranteed or warranted, and they are not intended to be, nor should they be understood to be, representation or warranties concerning the products described.

Specifications are subject to change without notice.

Depending on your application program, operations may differ. For details, refer to the instruction manual of your application. The steps described in this manual are in Windows Vista™ operating system Ultimate Edition (hereafter referred to as “Windows Vista”) and Mac® OS X v.10.4.x.

All information regarding non-Canon products was compiled from publicly available information. No representation is made regarding the accuracy thereof.



As an ENERGY STAR® Partner, Canon Inc. has determined that this product meets the ENERGY STAR® guidelines for energy efficiency.

About Consumables

Consumables (ink tanks / FINE Cartridges) are available for 5 years after production has stopped.

Trademarks

- “Microsoft” is a registered trademark of Microsoft Corporation.
- “Windows” is a trademark of Microsoft Corporation, registered in the U.S. and other countries.
- “Windows Vista” is a trademark of Microsoft Corporation.
- “Macintosh” and “Mac” are trademarks of Apple Inc., registered in the U.S. and other countries.
- “IrDA Feature Trademark” is owned by the Infrared Data Association and used under license therefrom.
- “Bluetooth” is a trademark of Bluetooth SIG, Inc., U.S.A. and licensed to Canon Inc.

Table of Contents

Introduction	2	My Printer (Windows Only).....	79
Safety Precautions	3	Specifications	80
Before Using the Printer	6	Users in the U.S.A.	82
Included Items	6	For California, USA only	85
Accessories	7	Index	86
Turning the Printer On and Off	8		
Loading Printing Paper	10		
Printing from Your Computer	18		
Printing with Windows.....	18		
Printing with Macintosh.....	19		
Printing Photographs Directly			
from a Compliant Device	20		
Printing Photographs Directly			
from a Compliant Device	20		
About PictBridge Print Settings.....	22		
Routine Maintenance	24		
When Printing Becomes Faint or Colors			
Are Incorrect	24		
Printing the Nozzle Check Pattern.....	25		
Examining the Nozzle Check Pattern	27		
Print Head Cleaning.....	28		
Print Head Deep Cleaning.....	31		
Aligning the Print Head.....	33		
Replacing an Ink Tank	43		
Keeping the Best Printing Results	49		
Cleaning Your Printer	50		
Troubleshooting	57		
Cannot Install the Printer Driver.....	58		
Cannot Connect to Computer Properly.....	60		
Print Results Not Satisfactory	61		
Printer Does Not Start.....	64		
Printer Moves But Ink Is Not Ejected.....	65		
Paper Does Not Feed Properly.....	65		
Paper Jams.....	66		
Alarm Lamp Flashes Orange.....	67		
Power Lamp Flashes Green and Alarm			
Lamp Flashes Orange Alternately.....	69		
Message Appears on the Computer			
Screen	70		
Error Message Appears on a PictBridge			
Compliant Device.....	74		
Cannot Print Properly through Infrared			
Communication.....	75		
Cannot Print Properly via Bluetooth			
Communication.....	75		
Appendix	76		
Carrying the Printer.....	76		
Traveling Abroad with the Printer	76		
How to Use the Documentation Provided.....	77		
Reading the On-screen Manuals.....	78		
Solution Menu (Windows Only)	79		

Introduction

This Quick Start Guide uses the following symbols to indicate important information. Always observe the instructions indicated by these symbols.

Warning

Instructions that, if ignored, could result in death or serious personal injury caused by incorrect operation of the equipment. These must be observed for safe operation.

Caution

Instructions that, if ignored, could result in personal injury or material damage caused by incorrect operation of the equipment. These must be observed for safe operation.

Important

Instructions that must be observed for safe operation.

▲ Safety Precautions

Please read the safety warnings and cautions provided in this manual to ensure that you use the printer safely. Do not attempt to use the printer in any way not described in this manual.

▲ Warning

- This product emits low level magnetic flux. If you use a cardiac pacemaker and feel abnormalities, please move away from this product and consult your doctor.
- You may cause an electric shock, fire, or damage the printer if you ignore any of these safety precautions.

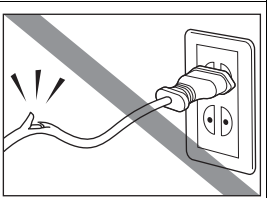
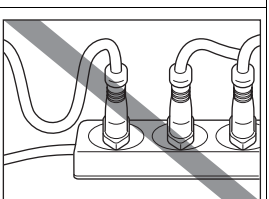
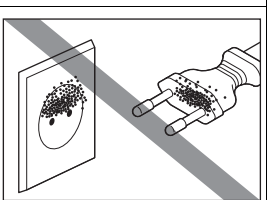
Choosing a location	Do not place the printer close to flammable solvents such as alcohol or thinners.	
Power supply	Never attempt to plug in or unplug the printer from the power supply when your hands are wet.	
	Always push the plug all the way into the power outlet.	
	Never damage, modify, stretch or excessively bend or twist the universal AC adapter and power cord. Do not place heavy objects on the power cord.	
	Never plug the printer into a power socket that is shared with other equipment (extension lead/cord, 2- or 3-way adapter, etc.).	
	Never use the printer if the power cord is bundled or knotted.	
	If you detect smoke, unusual smells or strange noises around the printer, immediately unplug the printer at the power supply and call for service.	
	Periodically, unplug the printer and use a dry cloth to wipe off any dust or dirt collected on the plug and the power outlet. If the printer is placed at a location exposed to a lot of dust, smoke, or high humidity, the dust collected on the plug absorbs moisture and may cause insulation failure and fire.	
	If you hear thunder, disconnect the power supply of the printer and refrain from using it. Leaving the printer plugged in may cause fire, electric shock, or damage to the printer, depending on the thunder storm.	
	Use the power cable included with the printer.	
	Use only power supplies listed in the user instructions (Canon AC Adapter: K30287, Li-ion Battery Pack: K30274, Car Adapter: K30275). Do not use them for other products.	

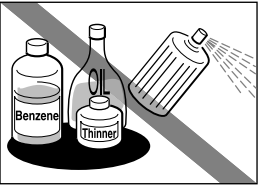
<p>Cleaning the printer</p>	<p>Use a damp cloth to clean the printer. Never use flammable solvents such as alcohol, benzene or thinners. If flammable solvents come in contact with electrical components inside the printer, it could cause a fire or electric shock.</p>	
<p>Always unplug the printer from the power outlet before cleaning the printer. If you accidentally switch the printer on while cleaning it, you could injure yourself or damage the printer.</p>		
<p>Maintaining the printer</p>	<p>Do not attempt to disassemble or modify the printer. There are no user serviceable parts inside the printer. The printer contains high-voltage components. Never attempt any maintenance procedure not described in this guide.</p>	
<p>Working around the printer</p>	<p>Do not use highly flammable sprays near the printer. This could cause a fire or electric shock if the spray comes into contact with electrical components inside the printer.</p>	

⚠ Caution

You may cause injury or damage the printer if you ignore any of these safety precautions.

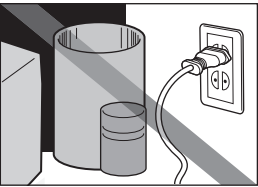
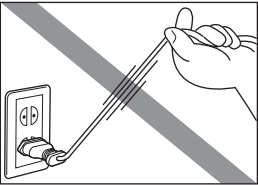
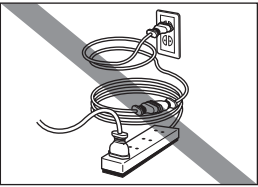
<p>Choosing a location</p>	<p>Do not install the printer in a location that is unstable or subject to excessive vibration. Do not install the printer in locations that are very humid or dusty, in direct sunlight, outdoors, or close to a heating source. To avoid the risk of fire or electric shocks, install the printer in a location with an ambient temperature range of 5°C to 35°C (41°F to 95°F) and humidity of 10% to 90% (condensation free). Do not place the printer on a thick rug or carpet.</p>	
<p>Power supply</p>	<p>Ensure that the area around the power outlet is kept clear at all times so you can easily unplug the power cord if necessary.</p>	
<p>Never remove the plug by pulling on the cord.</p>		
		
<p>Do not use an extension lead/cord.</p>		
		

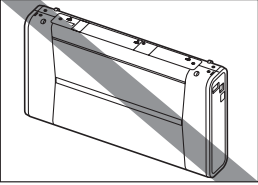
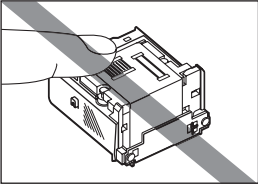
Working around the printer	<p>Never put your hands or fingers in the printer while it is printing.</p> <p>Do not carry or store the printer with the front of printer (the Paper Output Slot Cover side) down. A failure can result.</p> 
	<p>Do not place any object on the printer.</p>
	<p>Do not place metal objects (paper clips, staples, etc.) or containers of flammable solvents (alcohol, thinners, etc.) on top of the printer.</p>
	<p>If any foreign object (metal or liquid) fall into the printer, unplug the power cord and call for service.</p>
Print Heads and ink tanks	<p>Keep ink tanks out of the reach of children.</p> <p>In case ink is accidentally licked or swallowed, rinse out mouth or give one or two glasses of water to drink.</p> <p>If irritation or discomfort occurs, obtain medical advice immediately.</p>
	<p>In case ink gets in contact with eyes, rinse with water immediately.</p> <p>In case ink gets in contact with skin, wash with soap and water immediately.</p> <p>If irritation to eyes or skin persists, obtain medical advice immediately.</p>
	<p>Do not shake Print Heads or ink tanks.</p> <p>Ink may leak out and stain clothing or the surrounding area.</p>
	<p>Never touch the electrical contacts on a Print Head after printing. The metal parts may be very hot and could cause burns.</p> 
	<p>Do not throw ink tanks into fire.</p>
Universal AC Adapter	<p>When you pack the universal AC adapter for travel or storage, never wrap the cord around the body of the AC adapter to prevent the cord from splitting or separating from the body of the AC adapter and causing a short circuit.</p>

Before Using the Printer

Included Items

Check that all the following items are in the box. If anything is missing or damaged, contact your Canon Service representative.

- Printer
- Setup CD-ROM
- Easy Setup Instructions (Setup Sheet)
- Quick Start Guide
- Print Head
- Ink tanks (PGI-35 Black, CLI-36 Color)
- Universal AC Adapter
- Power cord
- Additional documents

* A USB cable is necessary to connect the printer with your computer.

Accessories

The following accessories are available for this printer. Confirm the product names when you purchase the accessories.

* Certain accessories may not be available in some countries or regions.

■ Portable Kit LK-62 series

This kit allows you to use the Canon printer in location where a power outlet is unavailable. The kit contains a battery pack (A) and a battery attachment (B). To charge the battery, load the battery pack in the battery attachment, and attach it to the printer, and then connect the AC adapter to the printer. For details, refer to the kit's instruction manual.

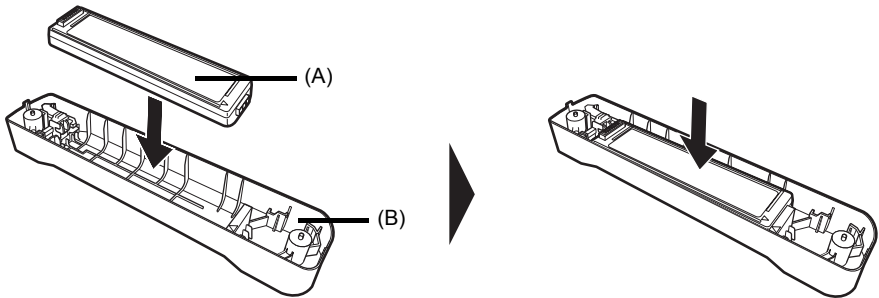

■ Power Cord for Universal AC Adapter

■ Canon Automobile Power Unit PU-200U

This accessory allows you to supply power from a cigarette lighter outlet of a car to your printer for operation or battery charging.

■ Bluetooth Unit BU-30

This accessory allows you to print wireless from a Bluetooth device.

For further information on the installation or the Bluetooth settings, refer to the *Bluetooth Guide* on-screen manual.

Turning the Printer On and Off

Turn on the printer before printing.

■ Turning on the Printer

Note

If preparatory operations below are not complete, follow your setup sheet to complete them.

- The Print Head and ink tanks are set into place.
 - The printer is connected to your computer (or a compatible device).
 - The printer driver is installed.
-

1 Open the Rear Tray Cover.

The Paper Output Slot Cover will open automatically.

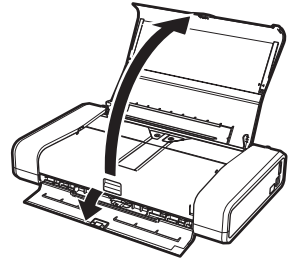

2 Press the **Power** button.

The **Power** lamp flashes green, and changes to steady, non-flashing light.

Important

- If you use the battery, make sure that it is charged. For details, refer to the battery's instruction manual.
 - If the **Alarm** lamp begins to flash orange, see "Alarm Lamp Flashes Orange" on page 67.
-

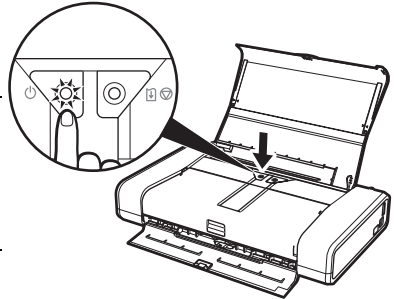

3 Turn on your computer.

■ Turning off the Printer

- 1 To turn off the printer, press the **Power** button.

When the **Power** lamp stops flashing, the printer is turned off.

This takes a few seconds or as long as around 30 seconds.

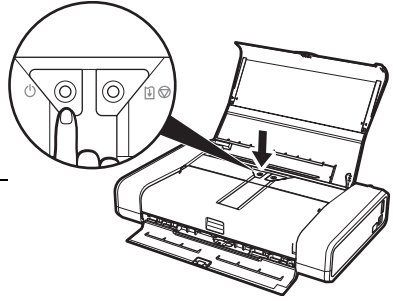

Note

Auto Power Off Feature

You can set the printer to turn off automatically.

Set this setting in the **Maintenance** sheet of the printer driver in Windows[®], and in the **Canon IJ Printer Utility** on a Macintosh[®]. For setting details, refer to the *PC Printing Guide* on-screen manual.

Important

When turning off the printer

Follow the procedure below to turn off the printer.

1. Confirm that the **Power** lamp on the printer has gone out.
2. Unplug the power plug from the wall outlet.

When you press the **Power** button to turn off the printer, the printer automatically puts a protective cap on the Print Head to prevent the ink from drying. If you remove the power plug before the **Power** lamp goes out, this capping will not be done properly, causing the Print Head to dry and clog.

If you stand the printer up or carry the printer before the Power lamp goes out, this may cause the ink to leak or the printer to break.

Loading Printing Paper

This section describes how to load printing paper in the Rear Tray.

■ Using Specialty Media

Canon recommends that you use Canon genuine media to ensure optimal print quality.

● Photo Quality Media

- Glossy Photo Paper “Everyday Use”
- Photo Paper Plus Semi-gloss
- Photo Paper Plus Glossy
- Photo Paper Plus Glossy II
- Photo Paper Plus Double Sided
- Photo Paper Pro
- Matte Photo Paper
- Photo Stickers



● Media Suited for Business Documents

- High Resolution Paper
- Super White Paper



■ Paper Handling

● Recommended Paper and Requirements

Media Type	Model*1	Paper Support Load Limit	Limit of the Outputted Paper	Paper Thickness Lever*2	Printer Driver Setting for Media Type	
Plain Paper*3	—	Around 50 sheets	Around 10 sheets	Right	Plain Paper	
Envelopes	—	10 envelopes	5 envelope	Left	Envelope	
High Resolution Paper	HR-101N	30 sheets	10 sheets	Right	High Resolution Paper	
Super White Paper	SW-201	40 sheets	10 sheets	Right	Plain Paper	
Glossy Photo Paper "Everyday Use"*5	GP-501	10 sheets	*4	Right	Glossy Photo Paper	
Matte Photo Paper	MP-101			Right	Matte Photo Paper	
Photo Paper Glossy*5	GP-502			Right	Glossy Photo Paper	
Photo Paper Plus Semi-gloss*5	SG-201			Right	Photo Paper Plus Semi-gloss	
Photo Paper Pro*5	PR-101			Right	Photo Paper Pro	
Photo Paper Plus Glossy*5	PP-101			Right	Photo Paper Plus Glossy	
Photo Paper Plus Glossy II	PP-201			Right	Photo Paper Plus Glossy II	
Photo Paper Plus Double Sided*6	PP-101D			1 sheet	Right	Photo Paper Plus Double Sided
Photo Stickers*7	PS-101			1 sheet	Right	Glossy Photo Paper
T-Shirt Transfers	TR-301			1 sheet	Left	T-Shirt Transfers

*1 Paper with a Model Number is Canon specialty media. Refer to the instruction manual supplied with the paper for detailed information on the printable side and notes on handling paper. For information on the paper sizes available for each Canon genuine paper, visit our website. You may not be able to purchase some Canon genuine papers depending on the country or region of purchase. Paper is not sold in the US by Model Number. Purchase paper by name.

*2 If the corners or edges of the paper are smudged, try to print with the Paper Thickness Lever set to the left. It may improve print quality.
Reset the Paper Thickness Lever when you finish printing.
For details on the Paper Thickness Lever, refer to "Front View" in "Main Components" of the *User's Guide* on-screen manual.

*3 Proper feeding of paper may not be possible at the maximum capacity depending on the type of paper or environmental conditions (either very high or low temperature and humidity). In such cases, reduce the sheets of paper you load at a time to around half (around 0.1 inches / 2.5 mm in paper stack height).

*4 We recommend that you remove the previously printed sheet from the Paper Output Slot Cover before continuously printing to avoid blurs and discoloration.

*5 When loading paper in stacks, the print side may be marked as it is fed in or sheets may be stuck to one another causing them not to be fed properly. In this case, load one sheet at a time.

*6 This paper cannot be used in Macintosh.

*7 When printing photos to sticker paper from a mobile phone or PDA via infrared communication or Bluetooth communication, be sure to select **Sticker Paper** in **Paper Size** on the Canon Setup Utility. Refer to “Setting the Page Size, Media Type, and Layout When Printing from a Mobile Phone or a PDA” in “Printing through Wireless Communication” of the *User’s Guide* on-screen manual.

Important

Put unused paper back into the package, and store them avoiding heat, humidity, and direct sunlight.

Note

- To specify the page size and media type when printing photos via infrared communication or Bluetooth communication, refer to “Setting the Page Size, Media Type, and Layout When Printing from a Mobile Phone or a PDA” in “Printing through Wireless Communication” of the *User’s Guide* on-screen manual.
 - For a detailed description of printing media types, refer to “Printing Media” in the *User’s Guide* on-screen manual.
-

● **Media Types You Cannot Use**

Do not use the following types of paper. Using such paper will not only produce unsatisfactory results, but can also cause the printer to jam or malfunction. Additionally, when printing on A5 or smaller sized paper, do not use paper thinner than a post card, including plain paper or notepad paper cut to a small size.

- Folded, curled, or wrinkled paper
- Damp paper
- Paper that is too thin (weighing less than 17 lb / 64 gsm)
- Paper that is too thick (plain paper, except for Canon genuine paper, weighing more than 28 lb / 105 gsm)
- Picture postcards
- Postcards affixed with photos or stickers
- Paper that is not rectangular
- Paper bound with staples or glue
- Paper with adhesives
- Paper decorated with glitter, etc.

■ Loading Paper

Important

- You cannot print on postcards affixed with photos or stickers.
- Always load paper in portrait orientation (A). Loading paper in landscape orientation (B) can cause the paper to be jammed.

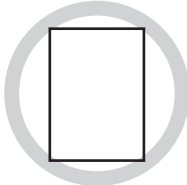

(A)

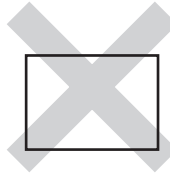

(B)

Note

We recommend using genuine Canon photo media when printing photographs. For details on the specialty media Canon provides for use with its various printers, see "Using Specialty Media" on page 10.

When Printing on Plain Paper

- You can use general copy paper or Canon's Super White Paper. When printing on both sides, we recommend Canon's Super White Paper Double-Sided.
Paper size:
 - Standard sizes: A4, B5, A5, Letter, and Legal
 - Non-standard sizes: 2.13 x 3.39 inches to 8.5 x 23 inches / 54.0 x 86.0 mm to 215.9 x 584.2 mmPaper weight: 17 to 28 lb / 64 to 105 gsm (non-Canon genuine plain paper)
 - If you cut plain paper to 4" x 6" / 101.6 x 152.4 mm, 5" x 7" / 127.0 x 177.8 mm, or 2.13" x 3.39" / 54.0 x 86.0 mm (credit card-size) for a trial print, it can cause paper jams.
 - 100% recycled paper can be used.
-

1 Flatten the four corners of the paper before loading it.

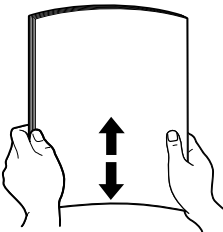

Note

- Align the edges of paper neatly before loading. Loading paper without aligning the edges may cause paper jams.
 - If paper is curled, hold the opposing curled corners and gently bend them in the opposite direction until the paper becomes completely flat. See "Paper is curled." on page 63.
 - To avoid curling, handle paper as follows.
 - When you are not using the printer, remove paper from the Rear Tray, and put unused paper back into the package and keep them on a level surface.
 - Take out only the necessary number of sheets from the package, just before printing.
-

2 Prepare to load paper.

- (1) Open the Rear Tray Cover.
The Paper Output Slot Cover will open automatically.
- (2) Pull out the Paper Support completely until the \triangleright mark and the \triangleleft mark are aligned.
- (3) Adjust the position of the Paper Thickness Lever.
The Paper Thickness Lever switches the clearance between the Print Head and the loaded paper to match the media type.
Set it to the left when printing on envelopes or T-shirt transfers, and right when printing on any other type of the paper.

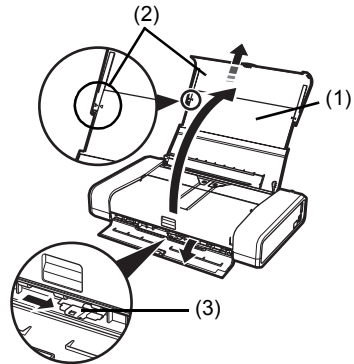

Note

If the corners or edges of the paper are smudged, try to print with the Paper Thickness Lever set to the left. It may improve print quality.
Reset the Paper Thickness Lever to the right when you finish printing.

3 Load the paper.

- (1) Slide the Paper Guide to the left side of the Rear Tray.
- (2) Load the paper in the Rear Tray with the print side facing UP.
- (3) Align the paper stack against the guide on the right side of the Rear Tray.
- (4) Slide the Paper Guide against the left side of the paper stack.
Do not slide the Paper Guide too strong. Paper may not be fed properly.

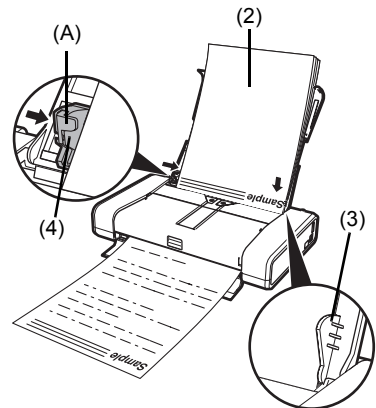

* Do not load higher than the projection (A).

4 Specify the page size and media type settings according to the loaded paper.

Note

Select the size and type of the loaded paper in **Page Size** (or **Paper Size**) and **Media Type** in the printer driver.
For details on printer driver settings, see "Printing with Windows" on page 18 or "Printing with Macintosh" on page 19.

■ Loading Envelopes

Use either European DL or US Comm. Env. #10-sized envelope.

With proper printer driver settings, the address will be printed according to the direction of envelope.

🚫 Important

Do not use the following envelopes:

- Envelopes with a double flap (or sticker flaps)
 - Envelopes with an embossed or treated surface
 - Envelopes with pressure seals
 - Envelopes whose gummed flaps are already moistened and adhesive
-

1 Prepare the envelopes.

- Press down on all four corners and edges of the envelopes to flatten them.

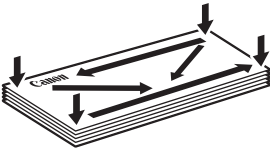

- If the envelopes are curled, hold the opposite corners and gently twist them in the opposite direction.

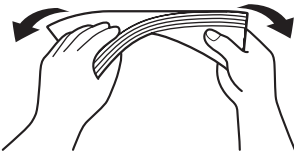

- If the corner of the envelope flap is folded, flatten it.
- If the leading edge of an envelope is puffed up or curled, use a pen to press the envelope flat and sharpen the crease. Press the envelope flat, working from the middle to the edge.

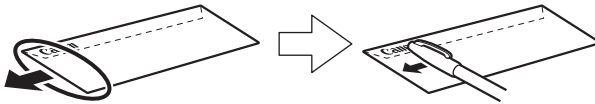

* The above illustrations show a side view of the leading edge of the envelope.

🚫 Important

- The envelopes may jam in the printer if they are not flat or the edges are not aligned.
 - Make sure that no curl or puff exceeds 0.1 inches / 3 mm.
-

2 Load the envelopes.

- (1) Slide the Paper Guide to the left side of the Rear Tray.
- (2) Load the envelope against the guide on the right side of the Rear Tray. Load with the address side facing UP and the rear flaps DOWN on the left. Up to 10 envelopes can be loaded at once.
- (3) Slide the Paper Guide against the left side of the envelope.
Do not slide the Paper Guide too strong. Paper may not be fed properly.
- (4) Set the Paper Thickness Lever to the left.
Reset the Paper Thickness Lever to the right when you finish printing.

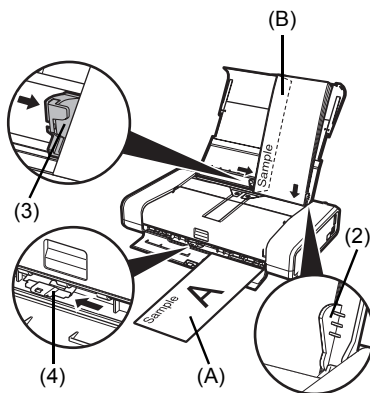

- (A) Printing orientation
(B) Make sure the flaps are folded.

3 Specify the settings in the printer driver.

- (1) Select **Envelope** in **Media Type**.
- (2) Select the size for envelopes.
In Windows, select **DL Env.** or **Comm. Env. #10** in **Page Size**.
In Macintosh, select **DL Envelope** or **#10 Envelope** in **Paper Size**.
- (3) Select **Landscape** in **Orientation**.

Important

Be sure to set the printer driver setting properly. If you do not, the address will be printed in the wrong direction.

Note

For details on printer driver settings, see "Printing with Windows" on page 18 or "Printing with Macintosh" on page 19.

■ Loading Small-Sized Paper

You can use 4" x 6" / 101.6 x 152.4 mm, 5" x 7" / 127.0 x 177.8 mm, and Credit card-sized papers.

⚠ Important

Always load paper in portrait orientation (A). Loading paper in landscape orientation (B) can cause the paper to be jammed.

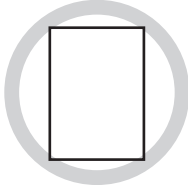

(A)

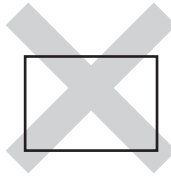

(B)

1 Load the paper.

- (1) Slide the Paper Guide to the left side of the Rear Tray.
- (2) Load the small-sized paper against the guide on the right side of the Rear Tray with the print side facing UP.
- (3) Slide the Paper Guide against the left side of the paper stack.
Do not slide the Paper Guide too strong. Paper may not be fed properly.
- (4) Set the Paper Thickness Lever to the right.

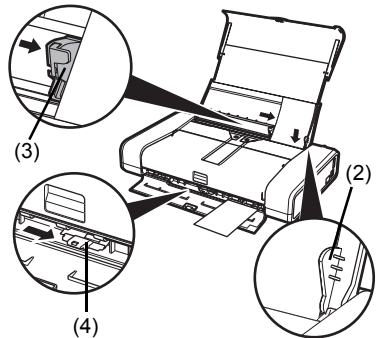

2 Specify the page size and media type settings according to the loaded paper.

📖 Note

Select the size and type of the loaded paper in **Page Size** (or **Paper Size**) and **Media Type** in the printer driver.

For details on printer driver settings, see "Printing with Windows" on page 18 or "Printing with Macintosh" on page 19.

Printing from Your Computer

This section describes the procedure for basic printing.

Printing with Windows

- 1 Turn on the printer and load the paper in the printer.
For details on how to load the paper, see “Loading Printing Paper” on page 10.
If you use the battery, make sure that it is charged.
- 2 Create a document or open a file to print using an appropriate application software.
- 3 Select **Print** on the application software’s **File** menu.
- 4 Make sure that your printer’s name is selected in **Select Printer**, and click **Preferences** (or **Properties**).

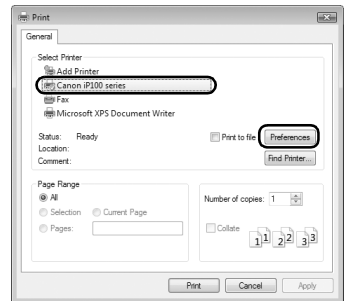

- 5 Specify the required settings and click **OK**.

Note

For details on other printer driver functions, click **Help** or **Instructions** to view the online help or the *PC Printing Guide* on-screen manual. **Instructions** is only displayed when the on-screen manuals are installed.

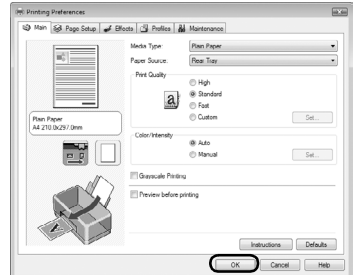

- 6 Click **Print** (or **OK**).



Printing with Macintosh

- 1 Turn on the printer and load the paper in the printer.
For details on how to load the paper, see “Loading Printing Paper” on page 10.
If you use the battery, make sure that it is charged.
- 2 Create a document or open a file to print using an appropriate application software.
- 3 Select **Page Setup** on the application software’s **File** menu.
- 4 Make sure that your printer’s name is selected in **Format for**.
- 5 Select the desired paper size in **Paper Size**.
- 6 Click **OK**.
- 7 Select **Print** on the application software’s **File** menu.
- 8 Select **Quality & Media** in the pop-up menu.
- 9 Specify the required settings.

Note

For details on other printer driver functions, click  to view the *PC Printing Guide* on-screen manual. If the on-screen manuals are not installed, the *PC Printing Guide* on-screen manual is not displayed even if  is clicked.

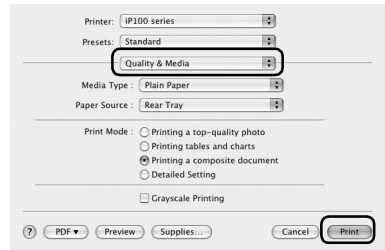
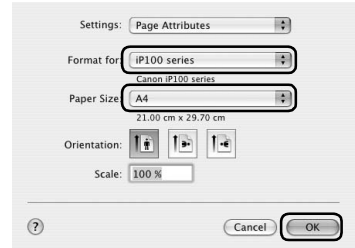

- 10 Click **Print**.

Printing Photographs Directly from a Compliant Device

You can connect a PictBridge compliant device such as a digital camera, camcorder, or mobile phone using a USB cable recommended by the device's manufacturer, and print recorded images directly without using a computer.

● Connectable Devices

PictBridge is an industry standard enabling a range of digital photo solutions, including the direct printing of photos from a digital still camera, camcorder or mobile phone* without the need to use a computer. A device can be connected to this printer for direct printing regardless of the manufacturer or the model as long as it complies with the PictBridge standard.

* PictBridge compatible digital still cameras, digital camcorders, and camera-equipped mobile phones are hereafter collectively referred to as "PictBridge compliant device".



A device with this mark is PictBridge compliant.

● Printable Image Data Format

This printer prints images taken with a DCF (Design rule for Camera File system) ver. 1.0/2.0-compatible digital camera (Exif ver. 2.2/2.21 compliant), as well as PNG files.

Printing Photographs Directly from a Compliant Device

To connect a PictBridge compliant device to this printer, use a USB cable recommended by the device's manufacturer.

Caution

Do not connect any equipment other than PictBridge compliant devices or the optional Bluetooth Unit BU-30 to the Direct Print Port of the printer. If you do so, electric shock, fire, or damage to the printer could result.

Important

Never disconnect the USB cable during printing unless when explicitly allowed to by the PictBridge compliant device. When disconnecting the USB cable between the PictBridge compliant device and printer, follow the instructions given in the device's instruction manual.

Note

When printing photos with the PictBridge compliant device connected to the printer, we recommend the use of the AC adapter supplied with the device. If you are using the device battery, be sure to charge it fully.

1 Prepare for printing.

- (1) Turn on the printer.
See "Turning the Printer On and Off" on page 8.
- (2) Load paper.
See "Loading Printing Paper" on page 10.

2 Connect the PictBridge compliant device to the printer.

Note

Depending on the model or brand of your device, you may have to select a print mode compliant with PictBridge before connecting the device. You may also have to turn on the device or select Play mode manually after connecting the device to the printer.

Perform necessary operations on the PictBridge compliant device before connecting it to this printer according to instructions given in the device's instruction manual.

- (1) Make sure that the PictBridge compliant device is turned off.
- (2) Connect the PictBridge compliant device to the printer using a USB cable recommended by the manufacturer of the device. The device turns on automatically. If your device does not turn on automatically, turn it on manually.
- (3) Set up the PictBridge compliant device for direct printing.
 will appear on the LCD of the device when the printer is correctly connected.

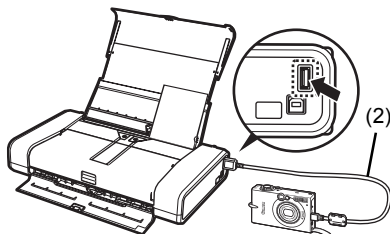

3 Specify the print settings such as paper type and layout.

See “About PictBridge Print Settings” on page 22.

You can make settings using the menu on the LCD of your PictBridge compliant device. Select the size and type of paper that you loaded in the printer.

4 Start printing from your PictBridge compliant device.

About PictBridge Print Settings

■ Settings on a PictBridge Compliant Device

This section describes the print settings on a PictBridge compliant device. When operating the device, be sure to follow the instructions given in the instruction manual of your PictBridge compliant device.

Note

- In the following description, names of setting items are given according to those used in Canon-brand PictBridge compliant devices. Setting item names may be different depending on the brand or model of your device.

- Some setting items explained below may not be available on some devices.

When you cannot change print settings on a device, the printer prints images as follows:

- Paper size: 4" x 6" / 101.6 x 152.4 mm
- Paper type: Photo
- Layout: 1-up, Borderless
- Date/File No. Print: Off (not printed)
- Image Optimize: On (the shooting information will be used for optimized printing)

● Paper size and Paper type Settings

The following sizes and types of printing paper can be used when printing from a PictBridge compliant device.

- Paper size

4" x 6" / 10 x 15 cm, 5" x 7"^{*1}, Credit card / 5.4 x 8.6 cm, 8" x 10" / 20 x 25 cm, A4, 8.5" x 11" (Letter), 4" x 7.1" / 10.1 x 18 cm^{*2}

- Paper type

Paper Type Setting	Loadable Paper ^{*4}
Plain ^{*3}	Super White Paper or other plain paper
Photo	Photo Paper Plus Glossy
	Photo Paper Plus Glossy II ^{*5}
	Glossy Photo Paper
	Glossy Photo Paper "Everyday Use"
	Photo Paper Glossy
	Photo Paper Plus Semi-gloss ^{*5}
	Photo Stickers ^{*6}
Fast Photo	Photo Paper Pro

The available page sizes vary depending on the media type. For details, visit our website.

^{*1} Can be selected only on certain Canon-brand PictBridge compliant devices.

^{*2} May appear as "Hi-Vision" on a non Canon-brand PictBridge compliant device.

^{*3} **Plain** can be selected for **Paper type** only when **Paper size** is set to **A4** or **8.5" x 11" (Letter)**. When **Paper type** is set to **Plain**, borderless printing will be disabled even when **Layout** is set to **Borderless**.

^{*4} You may not be able to purchase some Canon genuine papers depending on the country or region of purchase.

^{*5} When printing on 8" x 10" / 203.2 x 254.0 mm paper, select **8" x 10" / 20 x 25 cm** for **Paper size** and **Default** for **Paper type**.

*6 Exclusively used to print photo stickers. When printing on sticker paper, select **4" x 6"/10 x 15 cm** in **Paper size** and **Photo** for **Paper type**. Do not set **Layout** to **Borderless**.

● Layout Setting

Various layout options are available.

- **Bordered/Borderless**: You can select whether or not to print an image with a border.
- **N-up**: You can use this option when printing on sticker paper, or A4- or Letter-sized paper.
Sticker paper: When you select **4" x 6"/10 x 15 cm** for **Paper size**, you can print 16 images on a single sheet of paper.
A4 or Letter-sized paper: When you select **A4** or **8.5" x 11" (Letter)** for **Paper size**, you can print 4 images on a single sheet of paper.
- **Shooting Info (Exif Data)*1**: You can print shooting info (Exif Data) along with the image. The following two options are available.
1-up*2: Prints the shooting info (Exif Data) in the margin of selected individual images.
20-up*3: Prints 20 images specified with DPOF*4 and their shooting info (Exif Data) in list format on a single sheet of paper.
- **35 mm Film Style Layout (Contact Printing Layout)*1*3**: You can print the multiple images specified with DPOF*4 in a list format that looks like a negative film.

Besides the above options, you can also specify to print an index of images in the DPOF print settings menu.

*1 Can be selected only on certain Canon-brand PictBridge compliant devices.

*2 You can use this option only when **4" x 6"/10 x 15 cm**, **5" x 7"**, **8" x 10"/20 x 25 cm**, **A4** or **8.5" x 11" (Letter)** is selected for **Paper Size**.

*3 You can use this option only when **A4** or **8.5" x 11" (Letter)** is selected for **Paper size**.

*4 DPOF (Digital Print Order Format) is a standard format to record the specified information regarding images, such as which image or number of copies to print.

● Date/File No. Print Setting

You can specify whether the date and/or file number will be printed.

Note

- If the images already have dates superimposed when shot, set this PictBridge setting item to **Off**. If you select **Date**, **File No.**, or **Both**, the date and/or file number will be printed over the date printed by the device's function.
 - Depending on the paper size and layout, the date will only be printed even when **Both** is selected.
-

● Image Optimize Setting

You can select the optimization method to obtain high print quality. When you select **On**, the shooting information is used to print the optimized image.

If you are using a Canon-brand PictBridge compliant device, the following additional options may be available, depending on the model.

- **VIVID** makes green and blue more lively.
- **NR** (Noise Reduction) reduces the noise on blue areas like the sky as well as on black areas.
- **Face** brightens a darkened face on the photo taken against the light.
- **Red-Eye** corrects red eyes in portraits caused by flash photography.

● Trimming Setting

You can select an area to print.

Routine Maintenance

When Printing Becomes Faint or Colors Are Incorrect

When printing becomes faint or colors are incorrect even if ink remains in the ink tanks, the print head nozzles are probably clogged. Print the nozzle check pattern to confirm the condition of the nozzles and then perform Print Head Cleaning.

If print results are not satisfactory, performing Print Head Alignment may improve print quality.

Note

Before performing maintenance

- Open the Print Head Cover and make sure that both lamps for the ink tanks are lit red. If not, see “Getting the Ink Status Information” on page 43 and take the appropriate action.
- Make sure that the ink tank is set properly. See “Replacing Ink Tanks” on page 45.
- If the **Alarm** lamp flashes orange, see “Alarm Lamp Flashes Orange” on page 67.
- Increase the **Print Quality** setting in the printer driver settings.

Refer to the *PC Printing Guide* on-screen manual.

Step 1

See “Printing the Nozzle Check Pattern” on page 25.

If lines are missing or if white streaks appear



Step 2

See “Print Head Cleaning” on page 28.

If the problem is not resolved after performing
Print Head Cleaning twice



Step 3

See “Print Head Deep Cleaning” on page 31.



After cleaning the
Print Head, print
and examine the
nozzle check
pattern.

Note

If performing to Step 3 does not solve the problem, turn off the printer and perform another Print Head Deep Cleaning after 24 hours.

If this does not solve the problem, the Print Head may be damaged. Contact your Canon Service representative.

● If the Ruled Lines Are Shifted

See “Aligning the Print Head” on page 33.

Printing the Nozzle Check Pattern

Print the nozzle check pattern to determine whether the ink ejects properly from the print head nozzles.

Note

Printing the Nozzle Check Pattern Without a Computer

The nozzle check pattern printing can also be performed without a computer, using the **RESUME/CANCEL** button.

1. Make sure that the printer is on and then load a sheet of A4 or Letter-sized plain paper in the Rear Tray.
2. Set the Paper Thickness Lever to the right. For details on the Paper Thickness Lever, refer to “Front View” in “Main Components” of the *User’s Guide* on-screen manual.
3. Hold down the **RESUME/CANCEL** button until the **Power** lamp flashes green twice, and then release it immediately.

The nozzle check pattern is printed. Do not open the Print Head Cover while printing.

Examine the pattern and take the appropriate action. See “Examining the Nozzle Check Pattern” on page 27.

Windows

- 1 Make sure that the printer is on and then load a sheet of A4 or Letter-sized plain paper in the Rear Tray.

Set the Paper Thickness Lever to the right. For details on the Paper Thickness Lever, refer to “Front View” in “Main Components” of the *User’s Guide* on-screen manual.

- 2 Open the printer properties dialog box.

- 3 Print the Nozzle Check Pattern.

- (1) Click the **Maintenance** tab.
- (2) Click **Nozzle Check**.
- (3) Confirm the displayed message and click **Print Check Pattern**.

The nozzle check pattern is printed. Do not open the Print Head Cover while printing.

Note

Clicking **Initial Check Items** displays the items to be checked before printing the pattern.

- 4 Examine the pattern and take the appropriate action.

See “Examining the Nozzle Check Pattern” on page 27.

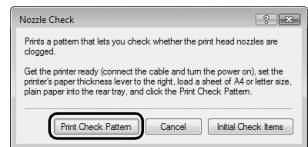

- 1 Make sure that the printer is on and then load a sheet of A4 or Letter-sized plain paper in the Rear Tray.
Set the Paper Thickness Lever to the right. For details on the Paper Thickness Lever, refer to “Front View” in “Main Components” of the *User’s Guide* on-screen manual.

- 2 Open the **Canon IJ Printer Utility** dialog box.

- 3 Print the Nozzle Check Pattern.

- (1) Select **Test Print** in the pop-up menu.
- (2) Click **Nozzle Check**.
- (3) Confirm the displayed message and click **Print Check Pattern**.

The nozzle check pattern is printed. Do not open the Print Head Cover while printing.



 **Note**

Clicking **Initial Check Items** displays the items to be checked before printing the pattern.

- 4 Examine the pattern and take the appropriate action.
See “Examining the Nozzle Check Pattern” on page 27.

Examining the Nozzle Check Pattern

Examine the nozzle check pattern output by the printer, and clean the Print Head if necessary.

Note

The nozzle check pattern will not be printed correctly if there is not enough ink. Replace the ink tank if the remaining amount of ink is insufficient.

See “Replacing an Ink Tank” on page 43.

1 Confirm the printed nozzle check pattern.

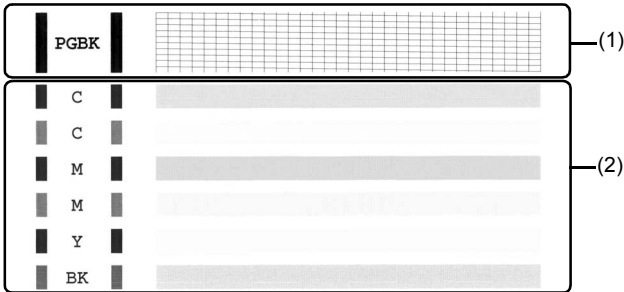

- (1) If lines of this pattern are missing, the **Black** print head nozzle needs cleaning.
Example: When lines are missing

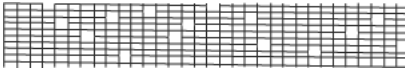

- (2) If these patterns have white streaks, the **Color** print head nozzle needs cleaning.
Example: When white streaks appear



2 Take the appropriate action.

● When cleaning is necessary

Windows

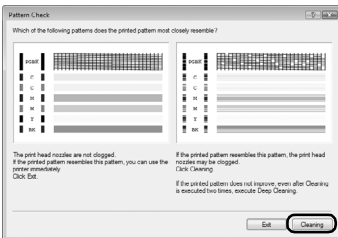

Macintosh

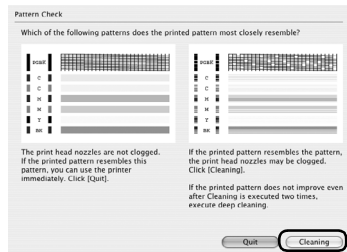

Click **Cleaning**, and then go to step 3-(3) of the Windows or Macintosh Print Head Cleaning procedure, depending on your platform. See “Print Head Cleaning” on page 28.

● When cleaning is not necessary

Click **Exit** or **Quit** on the **Pattern Check** dialog box to exit nozzle check pattern examination.

Print Head Cleaning

Clean the Print Head if lines are missing or if white streaks appear in the printed nozzle check pattern. Cleaning unclogs the nozzles and restores the print head condition. Note that cleaning the Print Head causes used ink to be absorbed in the ink absorber. Cleaning the Print Head consumes ink, so perform Print Head Cleaning only when necessary.

Note

Cleaning the Print Head Without a Computer

The Print Head cleaning can also be performed without a computer, using the **RESUME/CANCEL** button.

1. Make sure that the printer is on.
2. Hold down the **RESUME/CANCEL** button until the **Power** lamp flashes green once, and then release it immediately.

Windows

If you click **Cleaning** on the **Pattern Check** dialog box that is displayed after printing the nozzle check pattern, go to step 3-(3).

- 1 Make sure that the printer is on.
- 2 Open the printer properties dialog box.
- 3 Start Print Head Cleaning.
 - (1) Click the **Maintenance** tab.
 - (2) Click **Cleaning**.
 - (3) Select the ink group to be cleaned.

Note

Clicking **Initial Check Items** displays the items to be checked before cleaning.

- (4) Click **Execute**.
Print Head Cleaning starts when the **Power** lamp starts flashing green.

Do not perform any other operations until Print Head Cleaning finishes. This takes about 2 minutes.

- (5) Load a sheet of A4 or Letter-sized plain paper in the Rear Tray and set the Paper Thickness Lever to the right.

For details on the Paper Thickness Lever, refer to "Front View" in "Main Components" of the *User's Guide* on-screen manual.

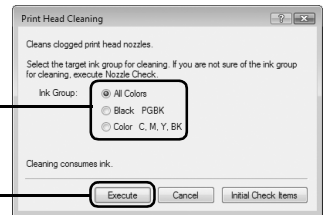

- (6) Confirm the displayed message and click **Print Check Pattern**.

The nozzle check pattern is printed.

Do not perform any other operations until the nozzle check pattern finishes printing.

 **Note**

The nozzle check pattern will not be printed correctly if there is not enough ink. Replace the ink tank if the remaining amount of ink is insufficient. See “Replacing an Ink Tank” on page 43.

- 4** Check the print head condition with the printed nozzle check pattern, and take the appropriate action.

See “Examining the Nozzle Check Pattern” on page 27.

 **Note**

If the problem is not resolved after performing steps 3 and 4 twice, try **Print Head Deep Cleaning**. See “Print Head Deep Cleaning” on page 31.

Macintosh

If you click **Cleaning** on the **Pattern Check** dialog box that is displayed after printing the nozzle check pattern, go to step 3-(3).

- 1** Make sure that the printer is on.
- 2** Open the **Canon IJ Printer Utility** dialog box.
- 3** Start Print Head Cleaning.

- (1) Make sure that **Cleaning** is selected in the pop-up menu.
- (2) Click **Cleaning**.
- (3) Select the ink group to be cleaned.

 **Note**

Clicking **Initial Check Items** displays the items to be checked before cleaning.

- (4) Click **OK**.
Print Head Cleaning starts when the **Power** lamp starts flashing green.
Do not perform any other operations until Print Head Cleaning finishes. This takes about 2 minutes.

- (5) Load a sheet of A4 or Letter-sized plain paper in the Rear Tray and set the Paper Thickness Lever to the right.

For details on the Paper Thickness Lever, refer to “Front View” in “Main Components” of the *User’s Guide* on-screen manual.

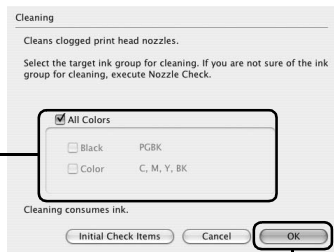

(6) Confirm the displayed message and click **Print Check Pattern**.

The nozzle check pattern is printed.

Do not perform any other operations until the nozzle check pattern finishes printing.

 **Note**

The nozzle check pattern will not be printed correctly if there is not enough ink. Replace the ink tank if the remaining amount of ink is insufficient. See "Replacing an Ink Tank" on page 43.

4 Check the print head condition with the printed nozzle check pattern, and take the appropriate action.

See "Examining the Nozzle Check Pattern" on page 27.

 **Note**

If the problem is not resolved after performing steps 3 and 4 twice, try **Print Head Deep Cleaning**. See "Print Head Deep Cleaning" on page 31.

Print Head Deep Cleaning

If print quality does not improve by standard Print Head Cleaning, try Print Head Deep Cleaning, which is a more powerful process. Note that cleaning the Print Head causes used ink to be absorbed in the ink absorber. Print Head Deep Cleaning consumes more ink than standard Print Head Cleaning, so perform this procedure only when necessary.

Windows

- 1 Make sure that the printer is on.
- 2 Open the printer properties dialog box.
- 3 Start Print Head Deep Cleaning.
 - (1) Click the **Maintenance** tab.
 - (2) Click **Deep Cleaning**.
 - (3) Select the ink group to be deeply cleaned.

Note

Clicking **Initial Check Items** displays the items to be checked before deep cleaning.

- (4) Click **Execute**.

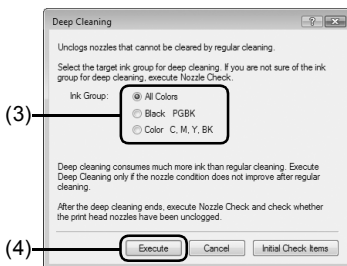

- (5) Confirm the displayed message and click **OK**.

Print Head Deep Cleaning starts when the **Power** lamp starts flashing green.

Do not perform any other operations until Print Head Deep Cleaning finishes. This takes about 2 minutes.

- 4 Check the condition of the Print Head.
 - (1) Load a sheet of A4 or Letter-sized plain paper in the Rear Tray and set the Paper Thickness Lever to the right.

For details on the Paper Thickness Lever, refer to "Front View" in "Main Components" of the *User's Guide* on-screen manual.
 - (2) Print the nozzle check pattern to check the print head condition.

See "Printing the Nozzle Check Pattern" on page 25.
 - (3) If the print head nozzles are still not clean, turn off the printer and perform another Print Head Deep Cleaning after 24 hours.
 - (4) If this does not solve the problem, the Print Head may be damaged. Contact your Canon Service representative.

- 1 Make sure that the printer is on.
- 2 Open the **Canon IJ Printer Utility** dialog box.
- 3 Start Print Head Deep Cleaning.
 - (1) Make sure that **Cleaning** is selected in the pop-up menu.
 - (2) Click **Deep Cleaning**.
 - (3) Select the ink group to be deeply cleaned.

 **Note**

Clicking **Initial Check Items** displays the items to be checked before deep cleaning.

- (4) Click **OK**.

Print Head Deep Cleaning starts when the **Power** lamp starts flashing green.

Do not perform any other operations until Print Head Deep Cleaning finishes. This takes about 2 minutes.

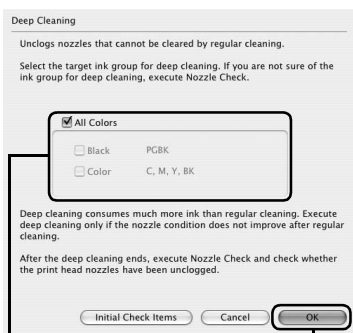

- 4 Check the condition of the Print Head.
 - (1) Load a sheet of A4 or Letter-sized plain paper in the Rear Tray and set the Paper Thickness Lever to the right.

For details on the Paper Thickness Lever, refer to "Front View" in "Main Components" of the *User's Guide* on-screen manual.
 - (2) Print the nozzle check pattern to check the print head condition.

See "Printing the Nozzle Check Pattern" on page 25.
 - (3) If the print head nozzles are still not clean, turn off the printer and perform another Print Head Deep Cleaning after 24 hours.
 - (4) If this does not solve the problem, the Print Head may be damaged. Contact your Canon Service representative.

Aligning the Print Head

If ruled lines are printed misaligned or print results are otherwise unsatisfactory, adjust the print head position.

■ Automatic Print Head Alignment

For Automatic Print Head Alignment, follow the procedure below.

Note

- The print head alignment pattern is printed in black and blue only.
- **Aligning the Print Head without a Computer**
The Print Head Alignment can also be performed without a computer, using the **RESUME/CANCEL** button.

If the printer driver is not installed in the computer, align the Print Head in this way.

1. Make sure that the printer is turned on, and then load a sheet of the supplied paper (Paper For Print Head Alignment) or A4/Letter-sized Canon Matte Photo Paper MP-101 with the printing side (whiter side) facing up in the Rear Tray.
2. Set the Paper Thickness Lever to the right. For details on the Paper Thickness Lever, refer to “Front View” in “Main Components” of the *User’s Guide* on-screen manual.
3. Hold down the **RESUME/CANCEL** button until the **Power** lamp flashes green four times, and then release it immediately.

The print head alignment pattern is printed. Do not open the Print Head Cover while printing. The print head position is adjusted automatically when the print head alignment pattern finishes printing.

Windows

- 1 Make sure that the printer is turned on, and then load a sheet of the supplied paper (Paper For Print Head Alignment) or A4/Letter-sized Canon Matte Photo Paper MP-101 with the printing side (whiter side) facing up in the Rear Tray.

Set the Paper Thickness Lever to the right. For details on the Paper Thickness Lever, refer to “Front View” in “Main Components” of the *User’s Guide* on-screen manual.

- 2 Open the printer properties dialog box.

- 3 Adjust the print head pattern.

(1) Click the **Maintenance** tab.

(2) Click **Print Head Alignment**.

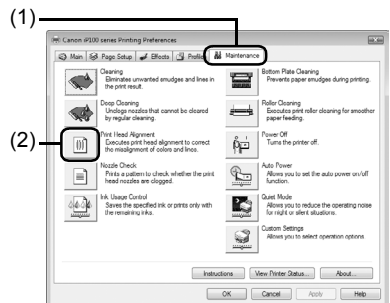

- (3) Confirm the displayed message and click **Align Print Head**.
The print head alignment pattern is printed.
Printing takes about 4 minutes to complete.

 **Important**

Do not open the Print Head Cover while printing.

 **Note**

Clicking **Print Alignment Value** prints the current settings and finishes Print Head Alignment.

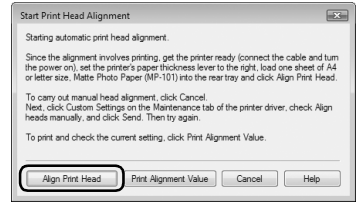

If the pattern is printed as shown right, the Print Head is aligned automatically.

 **Note**

- If the pattern is not printed successfully, see "Alarm Lamp Flashes Orange" on page 67.
 - If results of Automatic Print Head Alignment are not satisfactory, see "Manual Print Head Alignment" on page 36 and align the Print Head manually.
-

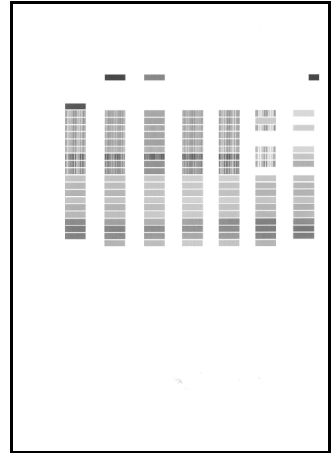

Macintosh

- 1 Make sure that the printer is turned on, and then load a sheet of the supplied paper (Paper For Print Head Alignment) or A4/Letter-sized Canon Matte Photo Paper MP-101 with the printing side (whiter side) facing up in the Rear Tray.
Set the Paper Thickness Lever to the right. For details on the Paper Thickness Lever, refer to "Front View" in "Main Components" of the *User's Guide* on-screen manual.
- 2 Open the **Canon IJ Printer Utility** dialog box.
- 3 Adjust the print head pattern.

(1) Select **Test Print** in the pop-up menu.

(2) Click **Print Head Alignment**.

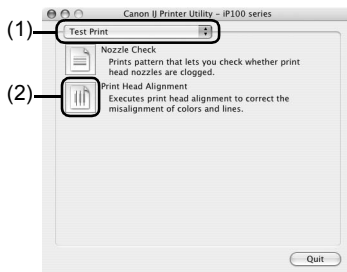

(3) Confirm the displayed message and click

Align Print Head.

The print head alignment pattern is printed.

Printing takes about 4 minutes to complete.

 **Important**

Do not open the Print Head Cover while printing.

 **Note**

Clicking **Print Alignment Value** prints the current settings and finishes Print Head Alignment.

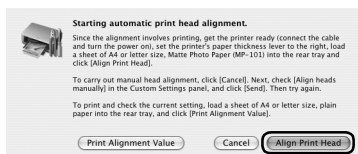

If the pattern is printed as shown right, the Print Head is aligned automatically.

 **Note**

- If the pattern is not printed successfully, see "Alarm Lamp Flashes Orange" on page 67.
 - If results of Automatic Print Head Alignment are not satisfactory, see "Manual Print Head Alignment" on page 36 and align the Print Head manually.
-

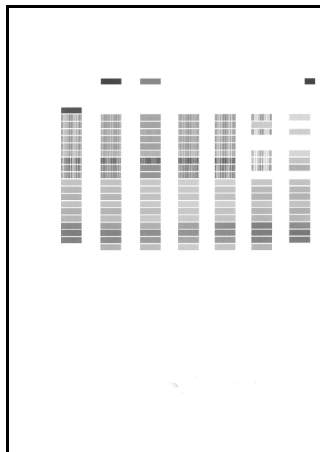

■ Manual Print Head Alignment

If the results of Automatic Print Head Alignment are not satisfactory, follow the procedure below to perform Manual Print Head Alignment to precisely align the Print Head.

For details on performing Automatic Print Head Alignment, see “Automatic Print Head Alignment” on page 33.

Windows

- 1 Make sure that the printer is on and then load two sheets of A4 or Letter-sized plain paper in the Rear Tray.

Set the Paper Thickness Lever to the right. For details on the Paper Thickness Lever, refer to “Front View” in “Main Components” of the *User’s Guide* on-screen manual.

- 2 Print the pattern.

- (1) Open the printer properties dialog box.
- (2) Click the **Maintenance** tab and then **Custom Settings**.
- (3) Select the **Align heads manually** check box, and then click **Send**.
- (4) Confirm the displayed message and click **OK**.
- (5) In the **Maintenance** sheet click **Print Head Alignment**.
- (6) Confirm the displayed message and click **Align Print Head**.

Important

Do not open the Print Head Cover while printing.

Note

Clicking **Print Alignment Value** prints the current settings and finishes Print Head Alignment.

- (7) After the pattern is printed, click **Yes**.
The dialog for entering a print head alignment value is displayed.

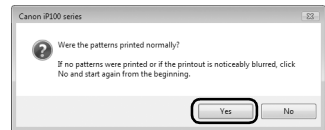
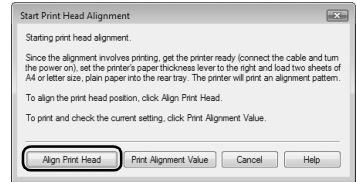

3 Look at the first printout and adjust the print head position.

- (1) Check the printed patterns and select the number of the pattern in column A that has the least noticeable streaks.

 **Note**

If it is difficult to pick the best pattern, pick the setting that produces the least noticeable vertical white streaks.



(A)



(B)

(A) Less noticeable vertical white streaks

(B) More noticeable vertical white streaks

- (2) Repeat the procedure until you finish inputting the pattern number for column N, then click **OK**.

- (3) Confirm the displayed message and click **OK**. The second pattern is printed.

 **Important**

Do not open the Print Head Cover while printing.

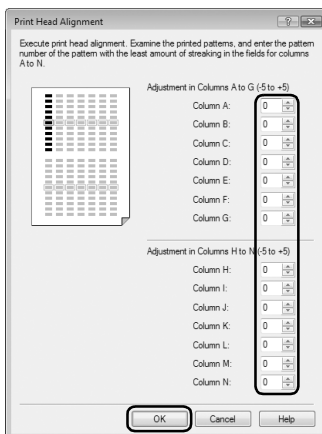
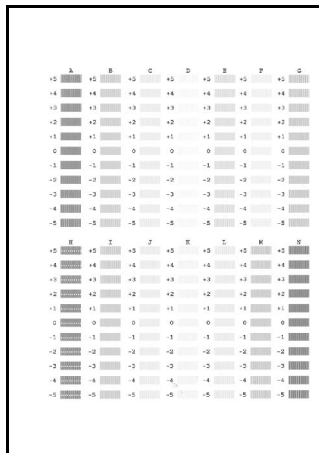

4 Look at the second printout and adjust the print head position.

- (1) Check the printed patterns and select the number of the pattern in column O that has the least noticeable horizontal streaks.

Note

If it is difficult to pick the best pattern, pick the setting that produces the least noticeable horizontal white streaks.



(C)



(D)

- (C) Less noticeable horizontal white streaks
(D) More noticeable horizontal white streaks
- (2) Repeat the procedure until you finish inputting the pattern number for column V, then click **OK**.
 - (3) Confirm the displayed message, load a sheet of A4 or Letter-sized plain paper in the Rear Tray, and then click **OK**. The third pattern is printed.

Important

Do not open the Print Head Cover while printing.

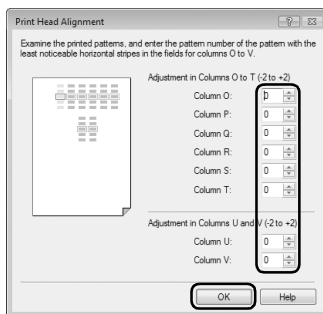
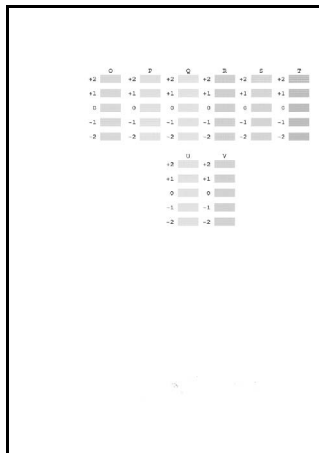

5 Look at the third printout and adjust the print head position.

- (1) Check the printed patterns and select the number of the pattern in column W that has the least noticeable streaks.

 **Note**

If it is difficult to pick the best pattern, pick the setting that produces the least noticeable white streaks.



(E)



(F)

(E) Less noticeable horizontal white streaks

(F) More noticeable horizontal white streaks

- (2) Similarly, select the number of the pattern in column X that has the least noticeable streaks, then click **OK**.
- (3) Confirm the displayed message and click **OK**.

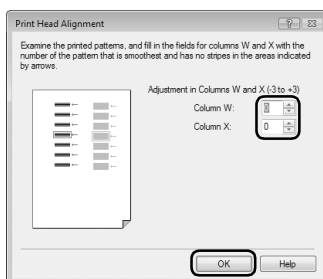
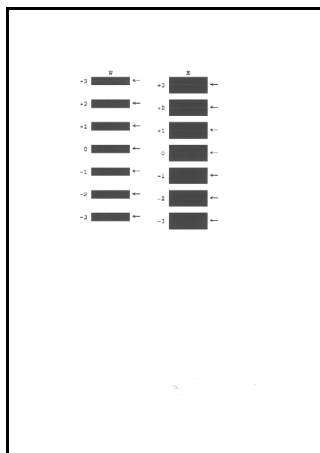

Macintosh

1 Make sure that the printer is on and then load two sheets of A4 or Letter-sized plain paper in the Rear Tray.

Set the Paper Thickness Lever to the right. For details on the Paper Thickness Lever, refer to “Front View” in “Main Components” of the *User’s Guide* on-screen manual.

2 Print the pattern.

- (1) Open the **Canon IJ Printer Utility** dialog box.
- (2) Select **Custom Settings** in the pop-up menu.
- (3) Select the **Align heads manually** check box, and then click **Send**.
- (4) Confirm the displayed message and click **OK**.
- (5) Select **Test Print** in the pop-up menu.
- (6) Click **Print Head Alignment**.

- (7) Confirm the displayed message and click **Align Print Head**.
The print head alignment pattern is printed.

Important

Do not open the Print Head Cover while printing.

Note

Clicking **Print Alignment Value** prints the current settings and finishes Print Head Alignment.

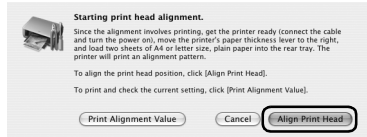

3 Look at the first printout and adjust the print head position.

- (1) Check the printed patterns and select the number of the pattern in column A that has the least noticeable streaks.

Note

If it is difficult to pick the best pattern, pick the setting that produces the least noticeable vertical white streaks.



(A)



(B)

- (A) Less noticeable vertical white streaks
(B) More noticeable vertical white streaks
- (2) Repeat the procedure until you finish inputting the pattern number for column N, then click **Send**.
- (3) Confirm the displayed message and click **OK**.
The second pattern is printed.

Important

Do not open the Print Head Cover while printing.

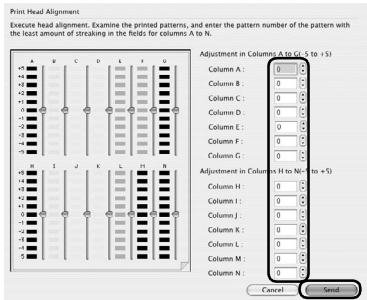
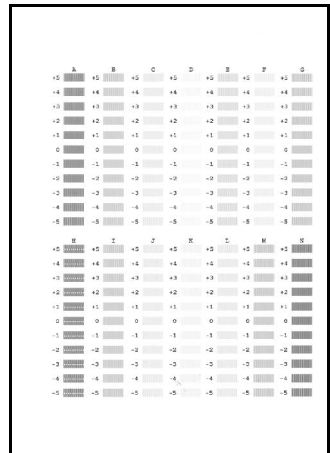

4 Look at the second printout and adjust the print head position.

- (1) Check the printed patterns and select the number of the pattern in column O that has the least noticeable horizontal streaks.

 **Note**

If it is difficult to pick the best pattern, pick the setting that produces the least noticeable horizontal white streaks.



(C)



(D)

(C) Less noticeable horizontal white streaks

(D) More noticeable horizontal white streaks

- (2) Repeat the procedure until you finish inputting the pattern number for column V, then click **Send**.
- (3) Confirm the displayed message, load a sheet of A4 or Letter-sized plain paper in the Rear Tray, and then click **OK**. The third pattern is printed.

 **Important**

Do not open the Print Head Cover while printing.

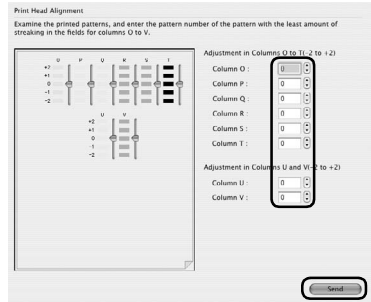
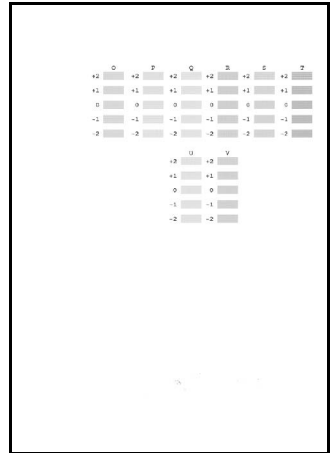

5 Look at the third printout and adjust the print head position.

- (1) Check the printed patterns and select the number of the pattern in column W that has the least noticeable streaks.

 **Note**

If it is difficult to pick the best pattern, pick the setting that produces the least noticeable white streaks.



(E)



(F)

(E) Less noticeable horizontal white streaks

(F) More noticeable horizontal white streaks

- (2) Similarly, select the number of the pattern in column X that has the least noticeable streaks, then click **Send**.

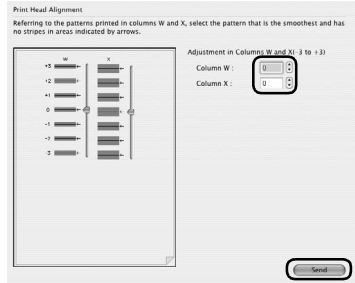
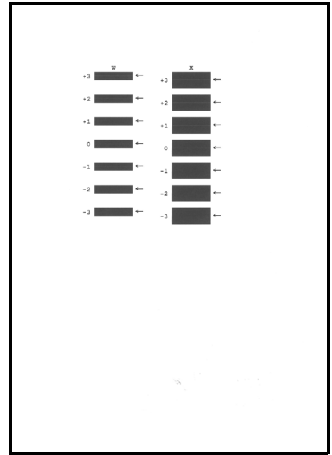

Replacing an Ink Tank

This section explains the way to confirm the ink status and the procedure to replace ink tanks.

When ink runs out or other errors occur, the **Alarm** lamp flashes orange to inform you of the error. See “Alarm Lamp Flashes Orange” on page 67 and confirm how to handle it. When printing from your computer, error messages appear on your computer screen as well.

Note

- For information on the compatible ink tanks, refer to the back cover of this guide.
 - If printing becomes faint or white streaks appear despite sufficient ink levels, see “When Printing Becomes Faint or Colors Are Incorrect” on page 24.
-

■ Getting the Ink Status Information

You can confirm the status of ink tanks in the following two ways:

- “With the Ink Lamps” on page 43
- “With the Computer Screen” on page 44

● With the Ink Lamps

You can confirm the status of each ink tank by the ink lamps. Open the Print Head Cover of the printer to confirm how the ink lamps light or flash.

● Ink lamp is on

The ink tank is correctly set and there is enough ink remaining to print.

● Ink lamp is flashing

Flashing slowly (at around 3-second intervals)



Ink is low. You can continue printing for a while, but we recommend you to have a new ink tank available.

Flashing quickly (at around 1-second intervals)



The ink tank is empty. Replace it with a new one.

● Ink lamp is off

The tank is not set properly or the function for detecting the remaining ink level is disabled.

If the ink tank is not set properly, press the  mark on the ink tank until the tank clicks into place.

If the function for detecting the remaining ink level is disabled, replace the ink tank with a new one. See “Replacing Ink Tanks” on page 45.

If the lamps are still off after reinserting the ink tanks, there has been an error and the printer cannot print. Confirm the number of times the **Alarm** lamp is flashing, take the appropriate action to resolve the error. See “Alarm Lamp Flashes Orange” on page 67.

● With the Computer Screen

You can confirm the status of each ink tank on the printer status monitor (Windows) and **Canon IJ Printer Utility** (Macintosh).

Windows

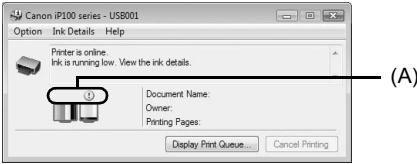

Macintosh

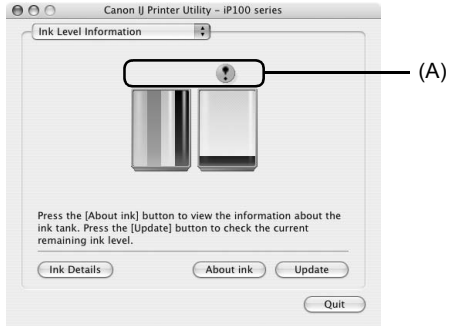

(A) Confirm whether any symbols are displayed here.

- ❗ Ink is low. You can continue printing for a while, but we recommend you to have a new ink tank available.
- ⊗ Ink may have run out. Confirm the number of the times the **Alarm** lamp is flashing, and see "Four Flashes: The Print Head Lock Lever is not locked properly. / Ink tank is not installed properly. / Ink may have run out." on page 67 or "Seventeen Flashes: Ink has run out." on page 69 in "Alarm Lamp Flashes Orange" on page 67, and take the appropriate action.

📖 Note

Message may be displayed during printing. Confirm the displayed message and take the appropriate action.

Follow the procedure below to open each of the confirmation screens.

Windows

- (1) Open the printer properties dialog box.
Refer to "Opening the Printer Properties Dialog Box Directly from Control Panel" in "Opening the Printer Properties Dialog Box (Windows)" of the *User's Guide* on-screen manual.
- (2) Click **View Printer Status** on the **Maintenance** sheet.
To confirm the ink tank information, click the **Ink Details** menu.

📖 Note

You can also display the printer status monitor by clicking the **Canon XXX** (where "XXX" is your printer's name) which appears on the taskbar during printing.

* When infrared communication is performed with the computer, the printer status monitor screen is not displayed.

Macintosh

- (1) Open the **Canon IJ Printer Utility**.
Refer to "Opening the Canon IJ Printer Utility (Macintosh)" in the *User's Guide* on-screen manual.

- (2) Select **Ink Level Information** in the pop-up menu.
To confirm the ink tank information, click **Ink Details**.

■ Replacing Ink Tanks

When ink tanks run out of ink, replace them using the following steps.

⚠ Important

Handling Ink

- To maintain optimal printing quality, we recommend the use of specified Canon brand ink tanks. Refilling ink is not recommended.
- Once you remove an ink tank, replace it immediately. Do not leave the printer with ink tanks removed.
- Replace empty tanks with new ones. Inserting partially used ink tanks may cause the nozzles to clog. Furthermore, with such tanks, the printer will not be able to inform you when to replace the tanks properly.
- Once an ink tank has been installed, do not remove it from the printer and leave it out in the open. This will cause the ink tank to dry out, and the printer may not operate properly when it is reinstalled. To maintain optimal printing quality, use an ink tank within six months of first use.
- Color ink may be consumed even when printing a black-and-white document or when black-and-white printing is specified.
Color ink is also consumed in Print Head Cleaning and Print Head Deep Cleaning, which may be necessary to maintain the printer's performance. When an ink tank is out of ink, replace it immediately with a new one.

1 Make sure that the printer is on, and then open the Print Head Cover.

The Print Head Holder moves to the center.

⚠ Caution

- Do not hold the Print Head Holder to stop or move it.
- Do not touch the metallic parts or other parts inside the printer.

⚠ Important

If the Print Head Cover is left open for more than 10 minutes, the Print Head Holder moves to the right. Close and reopen the Print Head Cover to return the holder to the center.

2 Remove the ink tank whose lamp is flashing fast.

(1) Push the tab and remove the ink tank.

⚠ Important

- Handle ink tanks carefully to avoid staining clothing or the surrounding area.
- Discard empty ink tanks according to the local laws and regulations regarding disposal of consumables.

📖 Note

- Do not remove both ink tanks at a time. Be sure to replace ink tanks one by one when replacing both ink tanks.
- For details on ink tank flashing speed, see "Getting the Ink Status Information" on page 43.

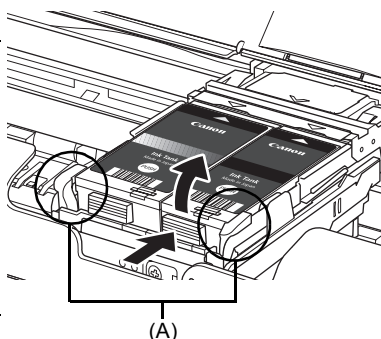

- (A) Do NOT touch the Print Head Lock Lever; remove only the ink tank. If you pull up the Print Head Lock Lever, refer to "Inside" in "Main Components" of the *User's Guide* on-screen manual and lock it again.

3 Prepare the replacement tank.

Remove the new ink tank from its packaging, then remove the orange protective cap (A) from the bottom of the ink tank.

Discard the cap once it is removed.

Important

- Do not touch the electrical contacts (B) on the ink tank. Doing so can cause the printer to malfunction or become unable to print.
 - Shaking ink tanks may cause ink to spill out and stain clothing or the surrounding area. Handle ink tanks carefully.
 - Be careful not to stain your clothes and hands with ink on the removed protective cap.
 - Do not reattach the protective cap once you have removed it. Discard it according to the local laws and regulations regarding disposal of consumables.
 - Do not touch the open ink port (C) once the protective cap is removed, as this may prevent the ink from being ejected properly.
-

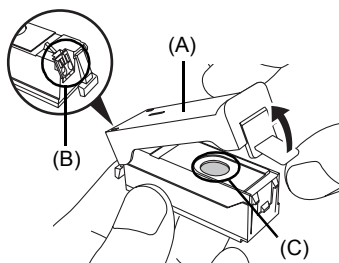

4 Install the ink tank.

- (1) Insert the front end of the ink tank into the Print Head by aligning the \triangle mark on the ink tank with the ∇ mark on the Print Head Holder.
- (2) Press on the **PUSH** mark on the ink tank until the ink tank snaps firmly into place.
- (3) Make sure that the ink lamp lights up red.

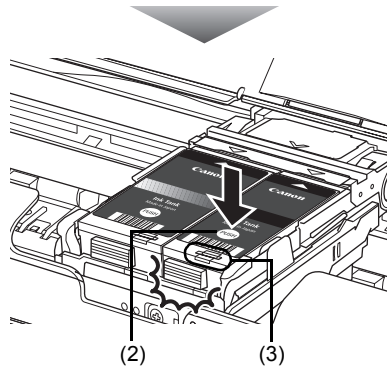
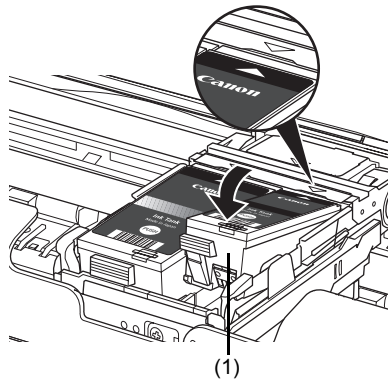

Important

- Install both ink tanks to print. The printer cannot be used unless both ink tanks are installed.
- If the front (innermost) part of the ink tank (A) is sticking up, push down on the Canon logo on the ink tank as illustrated below. Do not remove the ink tank forcibly.

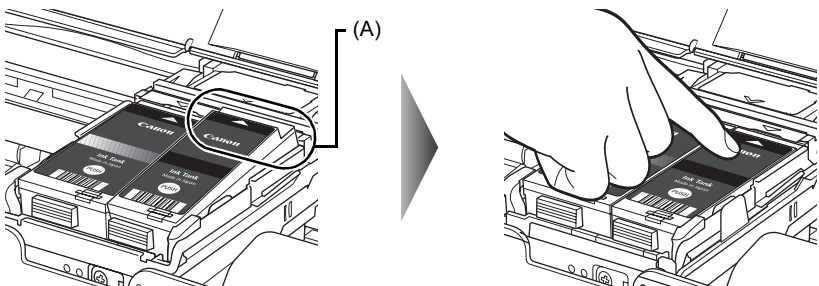

5 Close the Print Head Cover.

Note

- If the **Alarm** lamp still flashes orange after the Print Head Cover is closed, see “Alarm Lamp Flashes Orange” on page 67.
 - When you start printing after replacing the ink tank, Print Head Cleaning is performed automatically. Do not perform any other operations until Print Head Cleaning finishes. The **Power** lamp flashes green during cleaning.
-

Keeping the Best Printing Results

To avoid drying of the Print Head and clogging of the nozzles, note the following.

Note

- Ink may blur depending on the paper in the following cases;
 - Printed area is traced with a highlight pen or paint-stick, or
 - Printed area is stained with water or sweat
 - If the print head nozzles get clogged, printouts will become faint or particular colors will not be printed properly. For details, "When Printing Becomes Faint or Colors Are Incorrect" on page 24.
-

■ When You Turn Off the Printer

Follow the procedure below to turn off the printer.

- (1) Press the **Power** button to turn off the printer.
- (2) Confirm that the **Power** lamp has gone out.
This takes a few seconds or as long as around 30 seconds.
- (3) Unplug the power plug from the wall outlet.

When you press the **Power** button to turn off the printer, the printer automatically puts a protective cap on the Print Head to prevent the ink from drying. If you remove the power plug before the **Power** lamp goes out, this capping will not be done properly, causing the Print Head to dry and clog.

If you stand the printer up or carry the printer before the Power lamp goes out, this may cause the ink to leak or the printer to break.

■ When You Are Not Using the Printer for a Long Time

When you are not using the printer for a long time, print in both black & white and in color, or perform Print Head Cleaning, about once a month to prevent degradation of the Print Head.

Numerous nozzles are installed in the Print Head for high-precision printing. Just as the uncapped tip of a ballpoint pen or marker becomes dry and unusable if it is not used for a long period of time, the print head nozzles become blocked by dried ink. Periodically printing or cleaning the Print Head can prevent this blockage.

If you have not used the printer for a long time, print out the nozzle check pattern to check the print head condition before printing.

Cleaning Your Printer

This section describes the cleaning procedure that is needed to maintain your printer.

Caution

- Do not use tissue paper, paper towels, or similar materials for cleaning so as not to scratch the surface. Paper tissue powders or fine threads may remain inside the printer and cause problems such as Print Head blockage and poor printing results. Make sure to use a soft cloth.
 - Never use volatile liquids such as thinners, benzene, acetone, or any other chemical cleaner to clean the printer, as this may cause a malfunction or damage the printer's surface.
-

■ **Wiping Off Dirt on the Printer**

Be sure to use a soft cloth such as eyeglasses cleaning cloth and wipe off dirt on the surface with it gently. Smooth out wrinkles on the cloth if necessary before cleaning.

Caution

- Be sure to turn off the power and disconnect the power plug before cleaning the printer.
 - Do not use tissue paper, rough-textured cloth, or similar materials, as this may scratch the surface.
-

■ **Cleaning the Paper Feed Roller (Roller Cleaning)**

Clean the Paper Feed Roller if paper is not fed properly. Cleaning the Paper Feed Roller will wear the roller, so perform this only when necessary.

Note

Cleaning the Paper Feed Roller Without a Computer

The Roller Cleaning can also be performed without a computer, using the **RESUME/CANCEL** button.

1. Make sure that the printer is on, and then remove any paper from the Rear Tray.
 2. Hold down the **RESUME/CANCEL** button until the **Power** lamp flashes green three times, and then release it immediately.
The Paper Feed Roller will rotate as they clean. The **Power** lamp is flashing green while the Paper Feed Roller is rotating. The **Power** lamp is lit green when the Paper Feed Roller finishes rotating.
 3. Repeat step 2 twice.
 4. Make sure that the Paper Feed Roller stops rotating, then load three or more sheets of A4 or Letter-sized plain paper in portrait orientation in the Rear Tray.
The roller cleaning requires three sheets of A4 or Letter-sized plain paper.
 5. Set the Paper Thickness Lever to the right. For details on the Paper Thickness Lever, refer to "Front View" in "Main Components" of the *User's Guide* on-screen manual.
 6. Hold down the **RESUME/CANCEL** button until the **Power** lamp flashes green three times, and then release it immediately.
The paper cleans the Paper Feed Roller as it feeds through the printer.
 7. Repeat step 6 twice.
If the problem is not resolved, turn off the printer, unplug the power plug, and then wipe the Paper Feed Roller located on the right side inside the Rear Tray with a moistened cotton swab or the like. Rotate the roller manually as you clean it. Do not touch the roller with your fingers; rotate it with the cotton swab. If this does not solve the problem, contact your Canon Service representative.
-

- 1** Make sure that the printer is on, and then remove any paper from the Rear Tray.
- 2** Open the printer properties dialog box.
- 3** Click the **Maintenance** tab and then **Roller Cleaning**.
- 4** Confirm the displayed message, and then click **OK**.
The Paper Feed Roller will rotate as they clean.
- 5** Make sure that the Paper Feed Roller stops rotating. When the message appears, load three or more sheets of A4 or Letter-sized plain paper in portrait orientation in the Rear Tray.
The roller cleaning requires three sheets of A4 or Letter-sized plain paper.
Set the Paper Thickness Lever to the right. For details on the Paper Thickness Lever, refer to "Front View" in "Main Components" of the *User's Guide* on-screen manual.
- 6** Confirm the displayed message and click **OK**.
The paper that is loaded in the printer will feed through the printer and be ejected. Do not perform any other operation while the Paper Feed Roller is being cleaned.
- 7** Confirm the displayed message and click **OK**.
If the problem is not resolved, turn off the printer, unplug the power plug, and then wipe the Paper Feed Roller (A) located on the right side inside the Rear Tray with a moistened cotton swab or the like. Rotate the roller (A) manually as you clean it. Do not touch the roller with your fingers; rotate it with the cotton swab. If this does not solve the problem, contact your Canon Service representative.

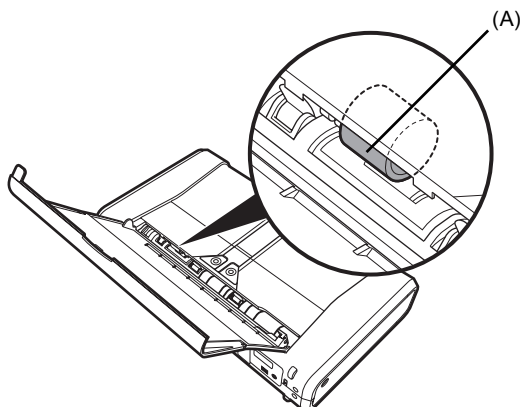

- 1** Make sure that the printer is on, and then remove any paper from the Rear Tray.
- 2** Open the **Canon IJ Printer Utility** dialog box.
- 3** Make sure that **Cleaning** is selected in the pop-up menu.
- 4** Click **Roller Cleaning**.
- 5** Confirm the displayed message and click **OK**.
The Paper Feed Roller will rotate as they clean.
- 6** Make sure that the Paper Feed Roller stops rotating. When the message appears, load three or more sheets of A4 or Letter-sized plain paper in portrait orientation in the Rear Tray.
The roller cleaning requires three sheets of A4 or Letter-sized plain paper.
Set the Paper Thickness Lever to the right. For details on the Paper Thickness Lever, refer to "Front View" in "Main Components" of the *User's Guide* on-screen manual.
- 7** Confirm the displayed message, and then click **OK**.

The paper that is loaded in the printer will feed through the printer and be ejected. Do not perform any other operation while the Paper Feed Roller is being cleaned.

If the problem is not resolved, turn off the printer, unplug the power plug, and then wipe the Paper Feed Roller (A) located on the right side inside the Rear Tray with a moistened cotton swab or the like. Rotate the roller (A) manually as you clean it. Do not touch the roller with your fingers; rotate it with the cotton swab. If this does not solve the problem, contact your Canon Service representative.

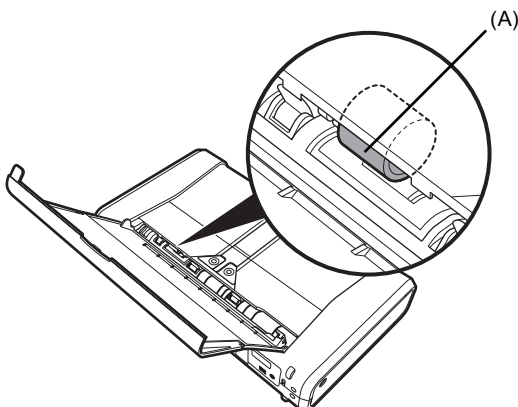

■ Cleaning the Inside of the Printer

If the printed paper is smudged, the inside of the printer may be dirty.

To always get best quality printing result, periodical cleaning of the inside of the printer is recommended.

You can clean this part in two ways:

- See “Cleaning with the Printer Driver (Bottom Plate Cleaning)” on page 53.
- See “Cleaning the Protrusions Inside the Printer” on page 56.

● Cleaning with the Printer Driver (Bottom Plate Cleaning)

This section describes how to clean the inside of the printer. If the inside of the printer becomes dirty, printed paper may get dirty, so we recommend performing cleaning regularly.

Note

Cleaning the Inside of the Printer without a Computer

The Bottom Plate Cleaning can also be performed without a computer, using the **RESUME/CANCEL** button.

1. Prepare two sheets of A4 or Letter-sized plain paper.
2. Make sure that the printer is on, and then load only one sheet of paper in the Rear Tray.
3. Fold the other paper in half widthwise, and then unfold it.
4. Load the paper folded in step 3 on the paper loaded in step 2.
Load the paper folded in step 3 with the open side facing up.
5. Set the Paper Thickness Lever to the right. For details on the Paper Thickness Lever, refer to “Front View” in “Main Components” of the *User’s Guide* on-screen manual.
6. Hold down the **RESUME/CANCEL** button until the **Power** lamp flashes green five times, and then release it immediately.

Bottom Plate Cleaning is performed and only the paper folded in step 3 is ejected. Check the folded part of the ejected paper. If it is smudged with ink, perform Bottom Plate Cleaning again.

When performing Bottom Plate Cleaning again, make sure to use a new piece of paper, and proceed from step 3.

If the problem is not resolved after performing cleaning twice, the protrusions inside the printer may be stained. Clean them according to instructions. See “Cleaning the Protrusions Inside the Printer” on page 56.

- 1 Prepare two sheets of A4 or Letter-sized plain paper.
- 2 Make sure that the printer is on, and then load only one sheet of paper in the Rear Tray.
- 3 Fold the other paper in half widthwise, and then unfold it.
- 4 Load the paper folded in step 3 on the paper loaded in step 2.

Load the paper folded in step 3 with the open side facing up.

Set the Paper Thickness Lever to the right.

For details on the Paper Thickness Lever, refer to “Front View” in “Main Components” of the *User’s Guide* on-screen manual.

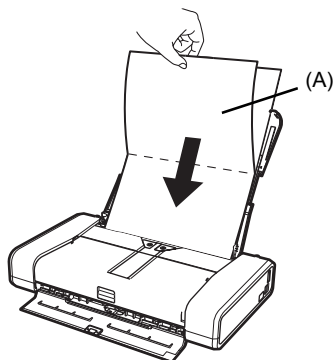

(A) Load the paper after unfolding it.

- 5 Open the printer properties dialog box.
- 6 Click the **Maintenance** tab, and then **Bottom Plate Cleaning**.
- 7 Confirm the displayed message and click **Execute**.

Bottom Plate Cleaning is performed and only the paper folded in step 3 is ejected.

Important

Do not perform any other operation while the bottom plate is being cleaned.

Check the folded part of the ejected paper. If it is smudged with ink, perform Bottom Plate Cleaning again.

Note

When performing Bottom Plate Cleaning again, make sure to use a new piece of paper, and proceed from step 3.

If the problem is not resolved after performing cleaning twice, the protrusions inside the printer may be stained. Clean them according to instructions. See “Cleaning the Protrusions Inside the Printer” on page 56.

Macintosh

- 1 Prepare two sheets of A4 or Letter-sized plain paper.
- 2 Make sure that the printer is on, and then load only one sheet of paper in the Rear Tray.
- 3 Fold the other paper in half widthwise, and then unfold it.
- 4 Load the paper folded in step 3 on the paper loaded in step 2.

Load the paper folded in step 3 with the open side facing up.

Set the Paper Thickness Lever to the right.

For details on the Paper Thickness Lever, refer to “Front View” in “Main Components” of the *User’s Guide* on-screen manual.

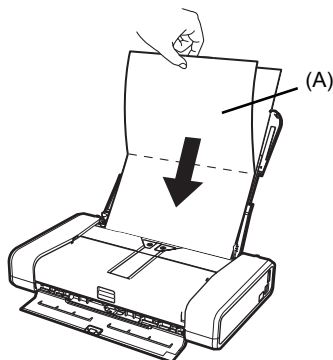

(A) Load the paper after unfolding it.

- 5 Open the **Canon IJ Printer Utility** dialog box.
- 6 Make sure that **Cleaning** is selected in the pop-up menu.
- 7 Click **Bottom Plate Cleaning**.
- 8 Confirm the displayed message and click **OK**.
Bottom Plate Cleaning is performed and only the paper folded in step 3 is ejected.

Important

Do not perform any other operation while the bottom plate is being cleaned.

Check the folded part of the ejected paper. If it is smudged with ink, perform Bottom Plate Cleaning again.

Note

When performing Bottom Plate Cleaning again, make sure to use a new piece of paper, and proceed from step 3.

If the problem is not resolved after performing cleaning twice, the protrusions inside the printer may be stained. Clean them according to instructions. See “Cleaning the Protrusions Inside the Printer” on page 56.

- **Cleaning the Protrusions Inside the Printer**

If protrusions inside the printer are stained, wipe off any ink from the protrusions using a cotton swab or the like.

⚠ Caution

Be sure to turn off the power and disconnect the power plug before cleaning the printer.

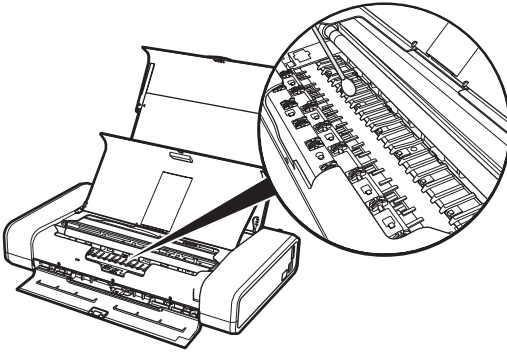

Troubleshooting

This section describes troubleshooting tips for problems you may encounter when using the printer.

Note

This section mainly describes the methods of printer operation for troubleshooting. To handle problems using your computer, refer to “Troubleshooting” in the *User’s Guide* on-screen manual. For details on how to view the on-screen manuals, see “Reading the On-screen Manuals” on page 78.

- “Cannot Install the Printer Driver” on page 58
- “Cannot Connect to Computer Properly” on page 60
- “Print Results Not Satisfactory” on page 61
- “Printer Does Not Start” on page 64
- “Printer Moves But Ink Is Not Ejected” on page 65
- “Paper Does Not Feed Properly” on page 65
- “Paper Jams” on page 66
- “Alarm Lamp Flashes Orange” on page 67
- “Power Lamp Flashes Green and Alarm Lamp Flashes Orange Alternately” on page 69
- “Message Appears on the Computer Screen” on page 70
- “Error Message Appears on a PictBridge Compliant Device” on page 74
- “Cannot Print Properly through Infrared Communication” on page 75
- “Cannot Print Properly via Bluetooth Communication” on page 75

If an Error Occurs When the Printer Is Connected to a Computer

When an error occurs in printing such as the printer is out of paper or paper is jammed, a troubleshooting message is displayed automatically. Take the appropriate action described in the message.

The message may vary depending on the version of your operating system.

Windows

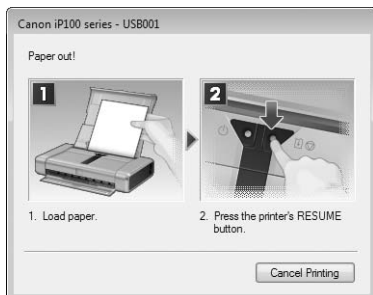

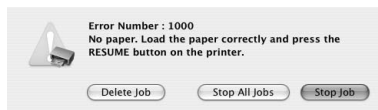

Macintosh

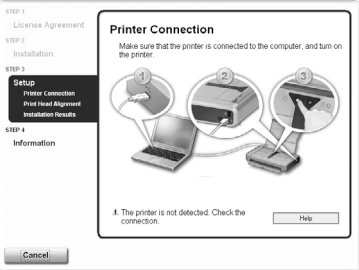

* When infrared communication is performed with the computer, the printer status monitor screen is not displayed.

Cannot Install the Printer Driver

Cause	Action
<p> Unable to proceed beyond the Printer Connection screen.</p>	<p>If you were unable to proceed beyond the Printer Connection screen, follow the procedure below to reinstall the printer driver.</p>  <ul style="list-style-type: none">● When connecting with a USB cable<ol style="list-style-type: none">(1) Click Cancel on the Printer Connection screen.(2) Click Start Over on the Installation Failure screen.(3) Click Back on the screen that appears next.(4) Click Exit, then remove the CD-ROM.(5) Turn the printer off.(6) Restart the computer.(7) Make sure you have no application software running.(8) Follow the procedure described in your setup sheet to reinstall the printer driver.● When connecting through infrared communication<ol style="list-style-type: none">(1) Click Cancel on the Printer Connection screen.(2) Click Start Over on the Installation Failure screen.(3) Click Back on the screen that appears next.(4) Click Custom Install.(5) Select the checkbox of the software to install, and then click Next.(6) Click Install.(7) Click Yes on the License Agreement screen.(8) Click Manual Selection on the Printer Connection screen.(9) Select IR.(10) Click Next.(11) Follow the procedure described in your setup sheet to reinstall the printer driver.

Cause	Action
<p>Installation does not start automatically when the <i>Setup CD-ROM</i> is inserted into your computer's disc drive.</p>	<p>Windows</p> <p>(1) Click Start then Computer. In Windows XP, click Start then My Computer. In Windows 2000, double-click the My Computer icon on the desktop.</p> <p>(2) Double-click the CD-ROM icon  on the displayed window. If the contents of the CD-ROM are displayed, double-click MSETUP4.EXE.</p> <p>Macintosh</p> <p>(1) Double-click the CD-ROM icon  on your desktop to start installation.</p> <p>Note</p> <p>If the CD-ROM icon is not displayed, try the followings:</p> <ul style="list-style-type: none"> ● Remove the CD-ROM from your computer, then insert it again. ● Restart your computer. <p>If the icon is still not displayed, try different discs and see if they are displayed. If other discs are displayed, there is a problem with the Setup CD-ROM. Contact a Canon Service representative.</p>
<p>Installation procedure not followed correctly.</p>	<p>Follow the procedure described in your setup sheet for proper installation.</p> <p>If the drivers were not installed correctly, uninstall the printer driver, restart your computer, and then reinstall the drivers. Refer to the <i>PC Printing Guide</i> on-screen manual.</p> <p>Windows</p> <p>Note</p> <p>If the installer was forced to be terminated due to a Windows error, the system may be in an unstable condition and you may not be able to install the drivers. Restart your computer before reinstalling.</p>

Cannot Connect to Computer Properly

■ Printing Speed Is Slow / USB 2.0 Hi-Speed Connection Does Not Work

Cause	Action
Your system environment is not fully compatible with USB 2.0 Hi-Speed.	<p>If your system environment is not fully compatible with USB 2.0 Hi-Speed, the printer will operate at a lower speed provided under USB 1.1. In this case, the printer operates properly but printing speed may slow down due to communication speed.</p> <p>Check the following to ensure that your system environment supports USB 2.0 Hi-Speed connection.</p> <ul style="list-style-type: none">● The USB port on your computer supports USB 2.0 Hi-Speed connection.● The USB cable, and the USB hub if you are using one, support USB 2.0 Hi-Speed connection. <p>Be sure to use a certified USB 2.0 Hi-Speed cable. We recommend the cable to be no longer than around 10 feet / 3 meters.</p> <ul style="list-style-type: none">● The operating system of your computer supports USB 2.0 Hi-Speed connection. <p>Obtain and install the latest update for your computer.</p> <ul style="list-style-type: none">● The USB 2.0 Hi-Speed driver operates properly. <p>Obtain the latest version of the USB 2.0 Hi-Speed driver compatible with your hardware and install it on your computer.</p> <p> Important</p> <p>For details on USB 2.0 Hi-Speed of your system environment, contact the manufacturer of your computer, USB cable, or USB hub.</p>



■ “This Device Can Perform Faster” Message Is Displayed

Cause	Action
Your system environment is not fully compatible with USB 2.0 Hi-Speed.	Your system environment is not compatible with USB 2.0. See “Printing Speed Is Slow / USB 2.0 Hi-Speed Connection Does Not Work” on page 60.

Print Results Not Satisfactory

If the print result is not satisfactory such as white streaks, misaligned lines, and uneven colors, confirm the paper and print quality settings first.

● Check 1: Do the page size and media type settings match the size and type of the loaded paper?

When these settings are incorrect, you cannot obtain a proper print result. If you are printing a photograph or an illustration, incorrect paper type setting may reduce the quality of printout color. Also, if you print with an incorrect paper type setting, the printed surface may be scratched. In borderless printing, uneven coloring may occur depending on the combination of the paper type setting and the loaded paper.

● Check 2: Did you set the print quality setting appropriately?

Select a print quality option suitable to the paper and image for printing. If you notice blurs or uneven colors, increase the print quality setting and try printing again.

* You cannot change the print quality setting when printing from a wireless communication device or PictBridge compliant device. (You may change the print quality setting with some Bluetooth devices.)

The method to confirm the paper and print quality settings differs depending on what you do with your printer.

To print from a PictBridge-compliant device	Confirm by using your PictBridge compliant device. See "Printing Photographs Directly from a Compliant Device" on page 20.
To print from a wireless communication device	Confirm by using the Canon Setup Utility. Refer to "Printing through Wireless Communication" and "Using the Canon Setup Utility" of the <i>User's Guide</i> on-screen manual.
To print from a computer	Confirm by using the printer driver. Refer to the <i>PC Printing Guide</i> on-screen manual.

● Check 3: If the problem is not resolved, there may be other causes.

See also the sections below.

- "Printing Does Not Start/Printing Is Blurred/Colors Are Wrong/Straight Lines Are Misaligned" on page 62
- "White Streaks" on page 62
- "Printed Paper Curls or Has Ink Blots" on page 62
- "Printed Surface Is Scratched/Paper Is Smudged" on page 62
- "Colors Are Uneven or Streaked" on page 64

■ Printing Does Not Start/Printing Is Blurred/Colors Are Wrong/Straight Lines Are Misaligned

Cause	Action
The media is loaded with the wrong side facing upwards.	When using paper with one printable surface, make sure the paper is loaded with the printable side facing up. Printing on the wrong side of such paper may cause unclear prints or prints with reduced quality. Refer to the instruction manual supplied with the paper for detailed information on the printable side.
Ink tank is empty.	Open the Print Head Cover of the printer to confirm how the ink lamps light or flash, and then take the appropriate action depending on the error condition. For details, see "Getting the Ink Status Information" on page 43.
Print Head nozzles are clogged.	See "When Printing Becomes Faint or Colors Are Incorrect" on page 24 and perform any necessary maintenance operation.
Print Head is misaligned.	If you did not align the Print Head after installation, straight lines may be printed misaligned. Make sure to align the Print Head after you install it. See "Automatic Print Head Alignment" on page 33 and perform Automatic Print Head Alignment. If this does not solve the problem, see "Manual Print Head Alignment" on page 36 and perform Manual Print Head Alignment.

■ White Streaks

Cause	Action
Print Head nozzles are clogged.	See "When Printing Becomes Faint or Colors Are Incorrect" on page 24 and perform any necessary maintenance operation.

■ Printed Paper Curls or Has Ink Blots

Cause	Action
Paper is too thin.	When printing data with high color saturation such as photographs or images in deep color, we recommend using Photo Paper Pro or other Canon specialty paper. See "Using Specialty Media" on page 10.

■ Printed Surface Is Scratched/Paper Is Smudged

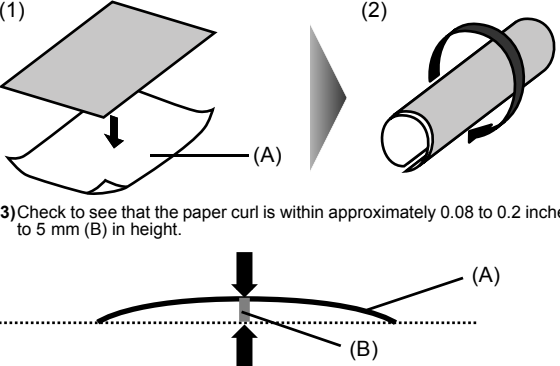

Cause	Action
Paper Feed Roller is dirty.	Clean the Paper Feed Roller. Cleaning the Paper Feed Roller will wear the roller, so perform this procedure only when necessary. For details on cleaning, see "Cleaning the Paper Feed Roller (Roller Cleaning)" on page 50.
Inside of the printer is dirty.	When performing duplex printing, if the specified paper size does not match the actual size of paper loaded in the Rear Tray, the inside will become stained with ink, causing printed paper to become smudged. Perform the Bottom Plate Cleaning to clean the inside of the printer. For details, see "Cleaning the Inside of the Printer" on page 53.  Note To prevent the inside of the printer from stains, set the paper size correctly.
Printing on inappropriate type of paper.	<ul style="list-style-type: none"> ● Check to see if the paper you are printing on is not too thick or curled. See "Media Types You Cannot Use" on page 12 to make sure that the paper you are using is suitable. If the paper is curled, see "Paper is curled." on page 63 to correct paper curl. ● When performing Borderless Printing, print quality may be reduced at the top and bottom edges of the paper. Make sure that the paper you are using is suitable for Borderless Printing. For details, refer to "Printing Area" in the <i>User's Guide</i> on-screen manual.

Cause	Action
<p>Inappropriate Paper Thickness Lever setting.</p>	<p>Adjust the position of the Paper Thickness Lever according to the type of paper you are printing on.</p> <p>See "Loading Printing Paper" on page 10.</p> <p>Depending on the printing content, the printing surface may become scratched or the corners or edges of the paper may become smudged even for the types of paper to set the lever to the right. In this case, set the Paper Thickness Lever to the left.</p> <p>* Reset the Paper Thickness Lever to the right when you finish printing. If the lever is not set back to the right, the inside of the printer is more likely to get dirty due to the wider clearance between the print head and the loaded paper. It may also reduce print quality.</p>
<p>Printing graphics with the Intensity setting in the printer driver set too high.</p>	<p>Especially if you are using plain paper to print images with high intensity, the paper may absorb too much ink and become wavy, causing paper abrasion. Refer to "Print Results Not Satisfactory" in the <i>User's Guide</i> on-screen manual.</p>
<p>Printing beyond the recommended printing area.</p>	<p>If you are printing beyond the recommended printing area of your printing paper, the lower edge of the paper may become stained with ink.</p> <p>Resize your original document in your application software.</p> <p>For details on recommended printing area, refer to "Printing Area" in the <i>User's Guide</i> on-screen manual.</p>
<p>Paper is curled.</p>	<p>For Plain Paper</p> <p>Turn the paper over and reload it to print on the other side.</p> <p>Leaving the paper loaded in the Rear Tray for a long time may cause the paper to curl. If this happens, load the paper with the other side facing up. It may resolve the problem.</p> <p>We recommend putting unused paper back into the package and keep them on a level surface.</p> <p>For Other Paper</p> <p>If you are using paper with either any of the corners or the whole printing surface curled, the paper may become dirty, not feed properly, or both. Use such paper after correcting paper curl as follows.</p> <p>(1) With the printing side (A) facing up, cover the paper with a fresh sheet of plain paper to avoid staining or scratching the surface.</p> <p>(2) Roll up the paper in a direction opposite to paper curl as seen below.</p>  <p>(3) Check to see that the paper curl is within approximately 0.08 to 0.2 inches / 2 to 5 mm (B) in height.</p> <p>We recommend printing curl-corrected paper one sheet at a time.</p> <p>Note</p> <p>Depending on the media type, the paper may be smudged or may not be fed properly even if it is not curled.</p> <p>In such case, follow the procedure described the above in "For Other Paper" to curl the paper before printing.</p> <p>This may improve the print result.</p>

■ Colors Are Uneven or Streaked

Cause	Action
Print Head nozzles are clogged.	See "When Printing Becomes Faint or Colors Are Incorrect" on page 24 and perform any necessary maintenance operations.
Print Head is misaligned.	If you did not align the Print Head after installation, straight lines may be printed misaligned. Make sure to align the Print Head after you install it. See "Automatic Print Head Alignment" on page 33 and perform Automatic Print Head Alignment. If this does not solve the problem, see "Manual Print Head Alignment" on page 36 and perform Manual Print Head Alignment.

Printer Does Not Start

Cause	Action
Ink tank is empty.	Open the Print Head Cover of the printer to confirm how the ink lamps light or flash, and then take the appropriate action depending on the error condition. For details, see "Getting the Ink Status Information" on page 43.
Ink tank is not installed securely.	Open the Print Head Cover, then press the  mark and the Canon logo on the ink tank until it clicks into place.
Unnecessary print jobs are left in queue. / Computer problems.	<p>Restarting your computer may solve the problem. If there are any unnecessary print jobs, follow the procedure below to delete them.</p> <p>Windows</p> <p>(1) Open the printer properties dialog box. Refer to "Opening the Printer Properties Dialog Box Directly from Control Panel" in "Opening the Printer Properties Dialog Box (Windows)" of the <i>User's Guide</i> on-screen manual.</p> <p>(2) Click the Maintenance tab and then View Printer Status. The printer status monitor is displayed.</p> <p>(3) Click Display Print Queue.</p> <p>(4) Select Cancel All Documents on the Printer menu. You may not be able to select this depending on the privileges of the account.</p> <p>(5) When the confirmation message is displayed, click Yes. The print jobs are deleted.</p> <p>Macintosh</p> <p>(1) Click the printer icon in the Dock to display the list of print jobs in progress.</p> <p>(2) Select the print job to delete and click . The print jobs are deleted.</p>
The printer is not ready.	<p>Check if the Power lamp is lit green. If the Power lamp is off, turn the printer on. While the Power lamp is flashing green, the printer is initializing. Wait until the Power lamp stops flashing and remains lit green.</p> <p>Note</p> <p>When printing large data such as a photo or graphics, it may take longer to start printing. While the Power lamp is flashing green, the computer is processing data and sending them to the printer. Wait until printing starts.</p>

Printer Moves But Ink Is Not Ejected

Cause	Action
Ink tank is empty.	Open the Print Head Cover of the printer to confirm how the ink lamps light or flash, and then take the appropriate action depending on the error condition. For details, see "Getting the Ink Status Information" on page 43.
Print Head nozzles are clogged.	See "When Printing Becomes Faint or Colors Are Incorrect" on page 24 and perform any necessary maintenance operations.



Paper Does Not Feed Properly

Cause	Action
Printing on inappropriate type of paper.	Check to see if the paper you are printing on is not too thick or curled. See "Loading Printing Paper" on page 10 and make sure that the paper you are using is suitable. If the paper is curled, see "Paper is curled." on page 63 to correct paper curl.
Paper Feed Roller is dirty.	Clean the Paper Feed Roller. Cleaning the Paper Feed Roller will wear the roller, so perform this procedure only when necessary. For details on cleaning, see "Cleaning the Paper Feed Roller (Roller Cleaning)" on page 50.
Paper not loaded properly.	Make sure of the following when you load paper in the printer. <ul style="list-style-type: none">● When loading two or more sheets of paper, align the edges of the sheets before loading.● Always load the paper in portrait orientation in the Rear Tray, regardless of the printing orientation.● Load the paper with the print side facing UP. Align the paper stack against the guide on the right side of the Rear Tray and slide the Paper Guide so that it just touches the left edge of the stack. For details on loading paper, see "Loading Paper" on page 13.
Too much paper loaded.	Make sure that the paper stack does not exceed the paper support load limit. However, proper feeding of paper may not be possible at this maximum capacity depending on the type of paper or environmental conditions (either very high or low temperature and humidity). In such cases, reduce the sheets of paper you load at a time to around half of the paper support load limit. For details on loading paper, see "Loading Paper" on page 13.
Foreign object in the Rear Tray.	Make sure that there are no foreign objects in the Rear Tray.
Envelopes not prepared or loaded properly.	<ul style="list-style-type: none">● When printing on envelopes, see "Loading Envelopes" on page 15, and prepare the envelopes before printing. Once you have prepared the envelopes, load them in the printer in portrait orientation. If the envelopes are placed in landscape orientation, they will not feed properly.● Set the Paper Thickness Lever to the left.

Paper Jams

Important

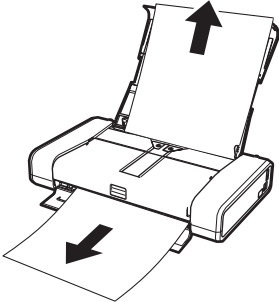
If you need to turn off the printer to remove jammed paper during printing, refer to “Printing from Your Computer” in the *User’s Guide* on-screen manual to cancel print jobs before turning off the printer.

Cause	Action
<p>Paper jammed in the Paper Output Slot or the Rear Tray.</p>	<p>Remove the paper following the procedure below.</p> <p>(1) Slowly pull the paper out, either from the Rear Tray or from the Paper Output Slot, whichever is easier.</p>  <ul style="list-style-type: none"> ● If the paper tears and a piece remains inside the printer, turn the printer off, and open the Print Head Cover and remove it. <ul style="list-style-type: none"> * Be careful not to touch the components inside the printer. After removing all paper, close the Print Head Cover, and turn it back on. ● If you cannot pull the paper out, turn the printer off and turn it back on. The paper may be ejected automatically. <p>(2) Reload the paper in the printer, and press the RESUME/CANCEL button on the printer.</p> <p>If you turned off the printer in step (1), all print jobs in queue are canceled. Reprint if necessary.</p> <p> Note</p> <ul style="list-style-type: none"> ● For details on how to load paper, see “Loading Printing Paper” on page 10. ● When reloading the paper in the printer, see “Paper Does Not Feed Properly” on page 65 to confirm that you are using the correct paper and are loading it into the printer correctly. ● A5-sized paper are suited to print documents consisting mainly of text. We do not recommend using such paper to print documents with photos or graphics, since the printout may curl and cause paper exit jams. <p>If you cannot remove the paper or the paper tears inside the printer, or if the paper jam error continues after removing the paper, contact your Canon Service representative.</p>
<p>Landscape credit card-sized paper jammed inside the printer.</p>	<p>Do not load credit card-sized paper in the landscape orientation. Remove the paper following the procedure below.</p> <p>(1) Turn the printer off.</p> <p>(2) Open the Print Head Cover.</p> <p>(3) Push out the jammed paper toward the Paper Output Slot. <ul style="list-style-type: none"> * Be careful not to touch the components inside the printer. </p> <p>(4) Slowly pull out the paper from the Paper Output Slot.</p> <p>(5) Turn the printer on.</p> <p>All print jobs in queue are canceled. Reprint if necessary.</p> <p>If you cannot remove the jammed paper or the paper jam error continues after removing the paper, contact your Canon Service representative.</p>

Alarm Lamp Flashes Orange

When a printer error occurs, the **Alarm** lamp flashes orange as shown below. The number of flashes indicates the type of error that has occurred. Count the flashes and take the appropriate action to correct the error.



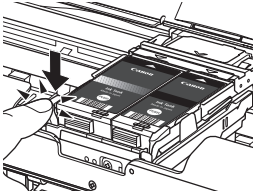
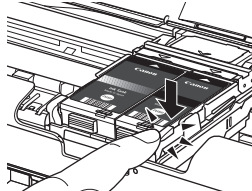

(A) Note the number of flashes

(B) Flashes repeatedly

Cause	Action
Two flashes: Printer is out of paper. / Paper does not feed.	Reload paper in the Rear Tray and press the RESUME/CANCEL button.
Three flashes: Paper jam.	The paper may be jammed. Remove the jammed paper, reload paper properly in the printer, and then press the RESUME/CANCEL button. See "Paper Jams" on page 66.
Four Flashes: The Print Head Lock Lever is not locked properly. / Ink tank is not installed properly. / Ink may have run out.	<p>Possible causes are as follows:</p> <ul style="list-style-type: none"> ● The lock lever of the Print Head is not locked properly (there are two tabs of the lock lever). Push both tabs (left and right) until each clicks into place. <div style="display: flex; justify-content: space-around; align-items: center;"> <div style="text-align: center;"> <p>Push the left tab.</p>  </div> <div style="text-align: center;"> <p>Push the right tab.</p>  </div> </div> <ul style="list-style-type: none"> ● If the lamp on the ink tank is not lit, the ink tank may not be installed properly. Push the ink tank until it clicks into place. ● If the lamp on the ink tank is flashing, ink may have run out. Replacing the ink tank is recommended. <p>If printing is in progress and you want to continue printing, press the RESUME/CANCEL button with the ink tank installed. Then printing can continue. Replacing the ink tank is recommended after the printing. The printer may be damaged if printing is continued under the ink out condition. See "Replacing an Ink Tank" on page 43.</p>
Five flashes: Print Head is not installed. / Print Head is defective.	<p>Follow the directions given in your setup sheet to install the Print Head. If the Print Head is already installed, remove the Print Head once and then reinstall it.</p> <p>If the error is still not resolved, the Print Head may be damaged. Contact your Canon Service representative.</p>
Eight flashes: Ink absorber is almost full.	<p>The printer has a built-in ink absorber to hold the ink used during Print Head Cleaning, for example.</p> <p>Eight flashes indicates that the ink absorber is nearly full.</p> <p>Press the RESUME/CANCEL button to cancel the error so you can continue printing.</p> <p>However, because printing is disabled once the ink absorber becomes completely full and until the ink absorber is replaced, you are recommended to contact your Canon service representative as early as possible (You will need to replace a particular part of the printer).</p>

Cause	Action
<p>Nine flashes: No response from connected digital camera or video camcorder. / Connected digital camera or video camcorder is not compatible with this printer. / PictBridge compliant devices are attached to both Direct Print Port and Bluetooth Unit Connector. / Bluetooth units are attached to both Direct Print Port and Bluetooth Unit Connector.</p>	<ul style="list-style-type: none"> ● A communication time out occurs if printing takes a long time or if it takes too much time to send data. This may cancel printing. Disconnect the USB cable connecting the printer and the device, and then reconnect it. When printing from a PictBridge compliant device, depending on the model or brand of your device, you may have to select a PictBridge compliant print mode on the device before connecting it to the printer. You may also have to turn on the camera or select Play mode manually after connecting the device to the printer. Perform necessary operations according your device's instruction manual before reconnecting it to the printer. ● Check the device connected to the Direct Print Port or Bluetooth Unit Connector on the printer. PictBridge compliant devices or the optional Bluetooth unit BU-30 can be connected to the printer for direct printing. ● When PictBridge compliant devices are attached to the both Direct Print Port and Bluetooth Unit Connector on the printer, disconnect both PictBridge compliant devices and connect either of the PictBridge compliant devices again. ● When the optional Bluetooth units BU-30 are attached to the both Direct Print Port and Bluetooth Unit Connector on the printer, turn off the printer, and then remove either of the Bluetooth units. For details on how to remove the Bluetooth unit, refer to the <i>Bluetooth Guide</i> on screen manual.
<p>Eleven flashes: Automatic Print Head Alignment failed.</p>	<p>Possible causes are as follows:</p> <ul style="list-style-type: none"> ● Paper of size other than A4 or Letter is loaded in the Rear Tray. Press the RESUME/CANCEL button on the printer to dismiss the error, then load a sheet of the supplied paper (Paper For Print Head Alignment) or A4/Letter-sized Canon Matte Photo Paper MP-101 with the printing side (whiter side) facing UP in the Rear Tray. ● Print Head nozzles are clogged. Press the RESUME/CANCEL button to dismiss the error, and print the nozzle check pattern to check the status of the Print Head. See "Printing the Nozzle Check Pattern" on page 25. ● The Paper Output Slot is exposed to strong light. Press the RESUME/CANCEL button to dismiss the error, and then adjust your operating environment and/or the position of the printer so that the Paper Output Slot is not exposed directly to strong light. <p>After carrying out the above measures, if the problem continues after aligning the Print Head again, press the RESUME/CANCEL button to dismiss the error, and then perform Manual Print Head Alignment. For details on Manual Print Head Alignment, see "Manual Print Head Alignment" on page 36.</p>
<p>Twelve Flashes: Low battery level.</p>	<p>The battery is running low. Connect the supplied Universal AC Adapter and charge the battery. For details on the charge level indication of the battery, refer to its instruction manual.</p>
<p>Fifteen Flashes: Ink tank cannot be recognized.</p>	<p>An Ink tank error has occurred. (The lamp on the ink tank is off.) Confirm how the ink lamps light or flash, and then take the appropriate action depending on the error condition. See "Getting the Ink Status Information" on page 43. If this does not solve the problem, replace the ink tank. See "Replacing Ink Tanks" on page 45.</p>

Cause	Action
Seventeen Flashes: Ink has run out.	<p>Ink has run out. (The lamp on the ink tank flashes.) Replace the ink tank and close the Print Head Cover. Printing under the current condition may damage the printer. If you want to continue printing in this condition, you need to release the function for detecting the remaining ink level. Press and hold the RESUME/CANCEL button for at least 5 seconds, and then release it. With this operation, releasing the function for detecting the remaining ink level is memorized. Please be advised that Canon shall not be liable for any malfunction or trouble which may be caused by continuation of printing under the ink out condition. See "Replacing an Ink Tank" on page 43.</p> <p> Note If the function for detecting the remaining in level is disabled, the ink tank is displayed in gray on the printer status monitor (Windows) and Canon IJ Printer Utility (Macintosh). See "With the Computer Screen" on page 44.</p>
Eighteen Flashes: Printer detected ink out condition.	<p>Printer detected ink out condition. (The lamp on the ink tank flashes.) Replace the ink tank and close the Print Head Cover. Printing with an ink tank that was once empty may damage the printer. If you want to continue printing in this condition, you need to release the function for detecting the remaining ink level. Press and hold the RESUME/CANCEL button for at least 5 seconds, and then release it. With this operation, releasing the function for detecting the remaining ink level is memorized. Please be advised that Canon shall not be liable for any malfunction or trouble caused by continuation of printing under the ink out condition or refilled ink tanks. See "Replacing an Ink Tank" on page 43.</p> <p> Note If the function for detecting the remaining in level is disabled, the ink tank is displayed in gray on the printer status monitor (Windows) and Canon IJ Printer Utility (Macintosh). See "With the Computer Screen" on page 44.</p>
Nineteen Flashes: A USB hub is connected.	<p>If a USB hub is connected to the Direct Print Port or the Bluetooth Unit Connector on the printer, remove the hub. Connect the PictBridge compliant device or the Bluetooth Unit directly to the printer.</p>

Power Lamp Flashes Green and Alarm Lamp Flashes Orange Alternately

Follow the procedure below to resolve the problem.

- 1 Disconnect the printer cable from the printer, turn the printer off, and then unplug the printer from the power supply.
 If the battery is attached, remove it once.
- 2 Plug the printer back in and turn the printer back on after leaving it for five minutes or more.
 If the problem is not resolved, make sure that the ink tank is set properly.

Caution

If you cannot confirm that the ink tank is set properly since the Print Head Holder moves to the right, contact your Canon service representative.
 If the ink tank is not set properly, do not remove it forcibly. Press the Canon logo on the ink tank and set the ink tank properly. After that, perform the steps 1 and 2 once again.
 If the problem is not resolved, contact your Canon Service representative.

Message Appears on the Computer Screen

■ Service Error 5100 Is Displayed

Cause	Action
<p>Movement of the Print Head Holder is blocked.</p>	<p>Follow the procedure below to resolve the problem.</p> <p>(1) Disconnect the printer cable from the printer, turn the printer off, and then unplug the printer from the power supply. If the battery is attached, remove it once.</p> <p>(2) Plug the printer back in and turn the printer back on after leaving it for five minutes or more.</p> <p>If the problem is not resolved, make sure that the ink tank is set properly.</p> <p>⚠ Caution If you cannot confirm that the ink tank is set properly since the Print Head Holder moves to the right, contact your Canon service representative. If the ink tank is not set properly, do not remove it forcibly. Press the Canon logo on the ink tank and set the ink tank properly. After that, perform the steps (1) and (2) once again. If the problem is not resolved, contact your Canon Service representative.</p>



■ Writing Error/Output Error/Communication Error

Cause	Action
<p>The printer is not ready.</p>	<p>Confirm that the Power lamp is lit green. If the Power lamp is off, turn the printer on. While the Power lamp is flashing green, the printer is initializing. Wait until the Power lamp stops flashing and remains lit green. If the Alarm lamp is flashing orange, an error may have occurred in the printer. For details on how to resolve the error, see "Alarm Lamp Flashes Orange" on page 67.</p>
<p>The printer is not connected properly.</p>	<p>Make sure that the USB cable is securely plugged into the printer and the computer.</p> <ul style="list-style-type: none"> ● If you are using a relay device such as a USB hub, disconnect it, connect the printer directly to the computer, and try printing again. If printing starts normally, there is a problem with the relay device. Consult the reseller of the relay device for details. ● There could also be a problem with the USB cable. Replace the USB cable and try printing again.

Cause	Action
Printer port setting does not match the computer's interface connecting the printer.	<p>Check the printer port settings.</p> <p>* In the following instruction, "XXX" signifies your printer's name.</p> <p>(1) Log on as a user account with administrator privilege.</p> <p>(2) Click Control Panel, then Printer under Hardware and Sound. In Windows XP, click Control Panel, Printers and Other Hardware, then Printers and Faxes. In Windows 2000, click Control Panel then Printers.</p> <p>(3) Right-click the Canon XXX icon, then select Properties.</p> <p>(4) Click the Ports tab to confirm the port settings. Make sure that a port named USBnnn (where "n" is a number) with Canon XXX appearing in the Printer column is selected for Print to the following port(s). If the port setting is not correct, reinstall the printer driver or change the port setting.</p> <p> Note</p> <p>When printing from the computer through infrared communication, select IR as the printer port. For details, refer to "The printer port setting is wrong." in "Cannot Print Properly through Infrared Communication" of the <i>User's Guide</i> on-screen manual.</p>
Printer driver is not installed properly.	The printer driver may not be installed properly. Uninstall them following the procedure described in the <i>PC Printing Guide</i> on-screen manual and reinstall them following the procedure described in your setup sheet.

■ Error Regarding Automatic Print Head Alignment Is Displayed

Cause	Action
Automatic Print Head Alignment has failed.	See "Eleven flashes: Automatic Print Head Alignment failed." on page 68 in "Alarm Lamp Flashes Orange" on page 67.

Macintosh

■ Error Number: 300 Is Displayed

Cause	Action
The printer is not ready.	<p>Confirm that the Power lamp is lit green.</p> <p>If the Power lamp is off, turn the printer on.</p> <p>While the Power lamp is flashing green, the printer is initializing. Wait until the Power lamp stops flashing and remains lit green.</p> <p>If the Alarm lamp is flashing orange, an error may have occurred in the printer. For details on how to resolve the error, see "Alarm Lamp Flashes Orange" on page 67.</p>
Printer is not connected properly.	<p>Make sure that the USB cable is securely plugged in to the printer and the computer.</p> <ul style="list-style-type: none"> ● If you are using a relay device such as a USB hub, disconnect it, connect the printer directly to the computer, and try printing again. If printing starts normally, there is a problem with the relay device. Consult the reseller of the relay device for details. ● There could also be a problem with the USB cable. Replace the USB cable and try printing again.

Cause	Action
Your printer is not selected in Printer on the Print dialog box.	<p>Select your printer's name in Printer on the Print dialog box.</p> <p>If your printer's name does not appear in Printer, follow the procedure below to check that the driver for your printer is installed to your computer.</p> <p>(1) Select Print & Fax Preferences from Printer.</p> <p>In Mac OS X v.10.3.9, select Edit Printer List from Printer.</p> <p>(2) Check that your printer's name is displayed in the list of printers and that the check box is selected.</p> <p>(3) If your printer's name is not displayed, click Add(+) to add the printer.</p> <p>If you cannot add the printer, follow the procedure described in your setup sheet to reinstall the printer driver.</p>

Macintosh

■ Error Number: 1700 Is Displayed

Cause	Action
The ink absorber is almost full.	See "Eight flashes: Ink absorber is almost full." on page 67 in "Alarm Lamp Flashes Orange" on page 67.

Macintosh

■ Error Number: 2001 Is Displayed

Cause	Action
No response from connected digital camera or video camcorder. / Connected digital camera or video camcorder connected is not compatible with this printer. / PictBridge compliant devices are attached to both Direct Print Port and Bluetooth Unit Connector. / Bluetooth units are attached to both Direct Print Port and Bluetooth Unit Connector.	See "Nine flashes: No response from connected digital camera or video camcorder. / Connected digital camera or video camcorder is not compatible with this printer. / PictBridge compliant devices are attached to both Direct Print Port and Bluetooth Unit Connector. / Bluetooth units are attached to both Direct Print Port and Bluetooth Unit Connector." on page 68 in "Alarm Lamp Flashes Orange" on page 67.

Macintosh

■ Error Number: 2002 Is Displayed

Cause	Action
A USB hub is connected.	See "Nineteen Flashes: A USB hub is connected." on page 69 in "Alarm Lamp Flashes Orange" on page 67.

Macintosh

■ Error Number: 2500 Is Displayed

Cause	Action
Automatic Print Head Alignment has failed.	See "Eleven flashes: Automatic Print Head Alignment failed." on page 68 in "Alarm Lamp Flashes Orange" on page 67.

Macintosh

■ Ink Info Number: 1600 Is Displayed

Cause	Action
Ink may have run out.	See "Four Flashes: The Print Head Lock Lever is not locked properly. / Ink tank is not installed properly. / Ink may have run out." on page 67 in "Alarm Lamp Flashes Orange" on page 67.

Macintosh

■ Ink Info Number: 1688 Is Displayed

Cause	Action
Ink has run out.	See "Seventeen Flashes: Ink has run out." on page 69 in "Alarm Lamp Flashes Orange" on page 67.

Macintosh

■ Ink Info Number: 1689 Is Displayed

Cause	Action
Printer detected ink out condition.	See "Eighteen Flashes: Printer detected ink out condition." on page 69 in "Alarm Lamp Flashes Orange" on page 67.

Error Message Appears on a PictBridge Compliant Device

The following are the possible errors that may occur when printing directly from a PictBridge compliant device and the countermeasures to clear them.

Note

- This section describes errors that are indicated on Canon-brand PictBridge compliant devices. The error messages and operations may vary depending on the device you are using. For errors on non-Canon PictBridge compliant devices, check the status of the **Alarm** lamp and take the appropriate action to clear the error. For details, see "Alarm Lamp Flashes Orange" on page 67.
- For the errors indicated on the PictBridge compliant device and their solution, also refer to the instruction manual of the device. For other troubles on the device, contact the manufacturer.

Error Message On PictBridge Compliant Device	Action
"Printer in use"	<p>Images are being printed from the computer.</p> <p>Wait until printing ends.</p> <p>If the printer is warming up, wait until the warm-up ends. When it is ready, the printer starts printing automatically.</p>
"No paper"	<p>Load paper in the Rear Tray, and select Continue* in the display on your PictBridge compliant device.</p> <p>* To resume printing, you can press the RESUME/CANCEL button on the printer instead of selecting Continue.</p>
"Paper jam"	<p>Select Stop in the display on your PictBridge compliant device to stop printing.</p> <p>Remove the jammed paper, load new paper, press the RESUME/CANCEL button on the printer, and try printing again.</p>
"Paper lever error"	<p>Adjust the position of the Paper Thickness Lever according to the type of paper you are printing on.</p> <p>See "Paper Handling" on page 11.</p> <p>Depending on the printing content, the printing surface may become scratched or the corners or edges of the paper may become smudged even for the types of paper to set the lever to the right. In this case, set the Paper Thickness Lever to the left.</p> <p>* Reset the Paper Thickness Lever to the right when you finish printing. If the lever is not set back to the right, the inside of the printer is more likely to get dirty due to the wider clearance between the print head and the loaded paper. It may also reduce print quality.</p>
"Printer cover open"	<p>Close the Print Head Cover on the printer.</p>
"No print head"	<p>The Print Head is defective or is not installed.</p> <p>For details on how to resolve the error, see "Five flashes: Print Head is not installed. / Print Head is defective." on page 67 in "Alarm Lamp Flashes Orange" on page 67.</p>
"Waste tank full" / "ink absorber full"	<p>The ink absorber is nearly full.</p> <p>For details on how to resolve the error, see "Eight flashes: Ink absorber is almost full." on page 67 in "Alarm Lamp Flashes Orange" on page 67.</p>
"No ink" / "Ink cassette error"	<p>The ink tank is not installed properly or empty.</p> <p>Check the number of how many the Alarm lamp flashes and take the appropriate action to resolve the error.</p> <p>See "Alarm Lamp Flashes Orange" on page 67.</p>
"Ink Error"	<p>An ink tank that was once empty is installed.</p> <p>For details on how to resolve the error, see "Eleven flashes: Automatic Print Head Alignment failed." on page 68 in "Alarm Lamp Flashes Orange" on page 67.</p>

Error Message On PictBridge Compliant Device	Action
"Hardware Error"	<p>If the battery is attached, the charge level of the battery is low. Connect the supplied Universal AC Adapter and charge the battery. For details on the charge level indication of the battery, refer to its instruction manual.</p> <p>If the error cannot be canceled, an Ink tank error has occurred. Confirm how the ink lamps light or flash, and then take the appropriate action depending on the error condition.</p> <p>See "Getting the Ink Status Information" on page 43.</p> <p>If this does not solve the problem, replace the ink tank.</p> <p>See "Replacing Ink Tanks" on page 45.</p>
"Printer error"	<p>An error requiring servicing may have occurred. (Printer Power lamp flashes green and Alarm lamp flashes orange alternately.)</p> <p>Disconnect the USB cable between the printer and the PictBridge compliant device, turn off the printer, and unplug the power cord of the printer from the power supply. If the battery is attached, remove it once. After leaving it for five minutes or more, plug the power cord of the printer back in, turn on the printer, and then reconnect the PictBridge compliant device to the printer.</p> <p>If the same error occurs, contact your Canon Service representative.</p>

Cannot Print Properly through Infrared Communication

To troubleshoot printing through infrared communication, refer to the *User's Guide* on-screen manual.

Cannot Print Properly via Bluetooth Communication

To troubleshoot printing via Bluetooth communication, refer to the *Bluetooth Guide* on-screen manual.

Appendix

Carrying the Printer

When you remove the power cord, carry the printer, or stand it up, check that the Power lamp is off.

Important

- If you repeatedly remove the power cord, carry the printer, or stand it up while the **Power** lamp is on or flashing, this may cause the ink to leak or the printer to break. (The same problem is caused even if you use the optional portable kit.) For details on turning off the printer, see “Turning off the Printer” on page 9.
- When carrying the printer, be careful not to shock the printer, to subject it to strong vibrations, to place it in the heat, or to put a heavy thing on it. This causes the printer to break or the ink to leak.

Note

- Pack the printer carefully when carrying. Refer to “Transporting the Printer” in the *User’s Guide* on-screen manual.
- X-ray and any other baggage inspection devices have no adverse effect on this printer.

Traveling Abroad with the Printer

Before traveling abroad with the printer, ensure that the following notes.

■ About Universal AC Adapter and Power Cord

The Universal AC Adapter can be used abroad to power the printer from power supplies ranging from AC 100 V to 240 V. However, the specification of the power cord differs depending on the country or region of use. Please purchase a power cord that conforms to the specifications of the country or region of use. We recommend using a Canon genuine power cord.

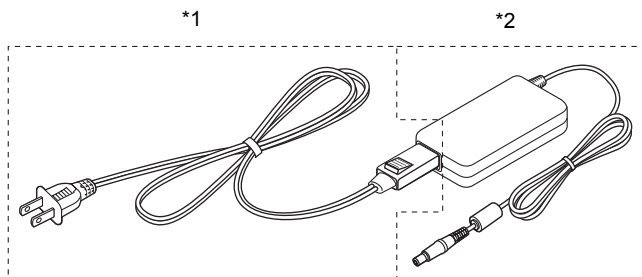

*1 Power Cord

*2 Universal AC Adapter

(1) Power Cord

The specification of the power cord differs for each country or region.

(2) Universal AC Adapter

Universal AC Adapter is not dependent on the specifications of the country or region of use.

■ Fill Out the CIWS Card

Fill out the CIWS Card (Canon International Warranty System) with the date of purchase and the name of where the printer was purchased. Carry this warranty card with you when you travel, so you can request repairs or servicing of the printer at your destination. For details, refer to the CIWS card.

How to Use the Documentation Provided



Printed Documentation

Setup Sheet

Be sure to read this sheet first.

This sheet includes instructions for setting up your printer and getting it ready for use.



Quick Start Guide (This guide)

Read this guide when starting to use the printer.

After following instructions in your setup sheet, we recommend you read this guide to familiarize yourself with the basic operations, for example, printing from your computer and a PictBridge compliant device.



On-screen Manuals

User's Guide

Read this guide when starting to use the printer.

If the *Quick Start Guide* does not provide you enough information, please refer to the *User's Guide* that can be installed from the *Setup CD-ROM*. This guide provides detailed instructions for:

- printing media
- printing from your computer
- printing through wireless communication
- routine maintenance
- troubleshooting

Additional guides are also available for advanced features.

PC Printing Guide

Refer to this guide for full instructions on printer driver setting.

PC Photo Printing Guide

Refer to this guide for instructions on using the various application software included on the *Setup CD-ROM*.

Bluetooth Guide

Refer to this guide for full instructions of printing from computers and devices that support Bluetooth communication, and on troubleshooting them.

Reading the On-screen Manuals

For detailed instructions on installing the on-screen manuals, refer to your setup sheet.

You can view the on-screen manuals in the following way:

Windows

To view the on-screen manual, double-click the **XXX On-screen Manual** shortcut icon on the desktop, or click **Start > All Programs** (or **Programs**) > **Canon XXX Manual > XXX On-screen Manual** (where “**XXX**” is your printer’s name).

System Requirements

Browser: Windows HTML Help Viewer

Note

- Microsoft® Internet Explorer 5.0 or later must be installed.
 - The on-screen manual may not be displayed properly depending on your operating system or Internet Explorer version. We recommend that you keep your system up to date with Windows Update.
-

Macintosh

To view the on-screen manual, double-click the **XXX On-screen Manual** alias (where “**XXX**” is your printer’s name) on the desktop.

System Requirements

Browser: Help Viewer

Note

- The on-screen manual may not be displayed properly depending on your operating system. We recommend that you keep your system up to date.
 - We recommend using Safari as your Web browser to view the HTML format on-screen manuals. If Safari is not installed on your computer, download it from Apple Inc. website and install it.
-

Solution Menu (Windows Only)



This menu screen helps you to easily launch bundled applications or on-screen manuals. Also, you can easily access useful web sites to get tips on how to use your printer. Experience how easy it is to launch menu items by using the menu screen that appears automatically when your computer starts up. For details, refer to the *Introduction to Solution Menu* on-screen manual.

My Printer (Windows Only)



This application helps you to operate this printer. Use this application to open the printer driver or the status monitor screen and confirm or change both the printer settings or status. Also, this application has a menu to provide troubleshooting tips when problems arise. Double-click the icon on the desktop and experience how easy operating the printer can be.

Specifications

General Specifications	
Printing resolution (dpi)	9600 (horizontal)* x 2400 (vertical) * Ink droplets can be placed with a pitch of 1/9600 inch at minimum.
Interface	USB 2.0 High Speed* ¹ IrDA ver.1.4* ² Bluetooth v2.0 (option)* ³ *1 A computer that complies with USB 2.0 Hi-Speed standard is required. Since the USB 2.0 Hi-Speed interface has full backward compatibility with USB Full-Speed (USB 1.1), it can be used at USB Full-Speed (USB 1.1). *2 Maximum speed: FIR 4Mbps Maximum communication range: 20 cm (8 inches) *3 Bluetooth connection is for printing only.
Print width	8 inches / 203.2 mm max. (for Borderless Printing: 8.5 inches / 216 mm)
Acoustic noise level	Approx. 38.5 dB (A) * When printing in the highest print quality mode on Photo Paper Pro.
Operating environment	Temperature: 5 to 35°C (41 to 95°F) Humidity: 10 to 90% RH (no condensation)
Storage environment	Temperature: 0 to 40°C (32 to 104°F) Humidity: 5 to 95% RH (no condensation)
Power supply	AC adapter 100-240 V, 50/60 Hz
Power consumption	Printing: Approx. 9 W Standby (minimum): Approx. 1.5 W OFF: Approx. 0.4 W
External dimensions	Approx. 12.7 (W) x 7.3 (D) x 2.4 (H) inches / Approx. 322 (W) x 185 (D) x 61.7 (H) mm * With the Paper Support and Paper Output Slot Cover retracted.
Weight	Approx. 2.0 kg (Approx. 4.4 lb.) * With the Print Head and Ink Tanks installed.
Print Head	Total 1,856 nozzles (PGBK: 320 nozzles, C/M each 512 nozzles, BK/Y each 256 nozzles)

Camera Direct Print (PictBridge)	
Paper size	4" x 6" / 10 x 15 cm, 5" x 7" ¹ , Credit card / 5.4 x 8.6 cm, 8" x 10" / 20 x 25 cm, A4, 8.5" x 11" (Letter), 4" x 7.1" / 10.1 x 18 cm * Can be selected only on certain Canon-brand PictBridge compliant devices.
Paper type	Default (Photo Paper Plus Glossy), Photo (Photo Paper Plus Glossy, Photo Paper Plus Glossy II, Glossy Photo Paper, Glossy Photo Paper "Everyday Use", Photo Paper Glossy, Photo Paper Plus Semi-gloss, Photo Stickers), Fast Photo (Photo Paper Pro), Plain Paper (Only A4/Letter)
Layout	Default (Borderless), Borderless, Bordered, N-up (2, 4, 9, 16* ¹), 20-up* ² , 35-up* ³ *1 Layout compatible with Canon-brand sticker above. See "Recommended Paper and Requirements" on page 11. *2 You can print shooting Info (Exif Data) on photos in list format (20-up), or in the margins of specified photos (1-up). Select Layout, then select the item displayed with the [i] icon. (Note that this print setting cannot be used for some models.) *3 Selected photos are printed in 35 mm film style layout (contact printing layout). This print setting is only available with certain Canon PictBridge compliant devices.
Image optimize	Default (Exif Print), On, Off, VIVID*, NR (Noise Reduction)*, Face*, Red eye* * If using a Canon PictBridge compliant device, you can select it.

Camera Direct Print (PictBridge)

Print date & file no.	Default (Off: No printing), Date, File No., Both, Off
Trimming	Default (Off: No trimming), On (follow camera's setting), Off

Minimum System Requirements

Note

Conform to the operating system's requirements when higher than those given here.

	Windows	Macintosh
Operating System	Windows Vista Pentium II (including compatible processors) 300 MHz 128 MB	Mac OS X v.10.4 Intel processor PowerPC G3 256 MB
Processor	Windows XP SP2 Pentium II (including compatible processors) 300 MHz 128 MB	Mac OS X v.10.3.9 PowerPC G3 128 MB
RAM	Windows 2000 Professional SP4 Pentium II (including compatible processors) 300 MHz 128 MB	Note Hard Disk must be formatted as Mac OS Extended (Journaled) or Mac OS Extended.
	Note Operation can only be guaranteed on a PC pre-installed Windows Vista, XP or 2000.	
Browser	Internet Explorer 6.0 or later	Safari
Hard Disk Space	400 MB Note For bundled software installation.	450 MB Note For bundled software installation.
CD-ROM Drive	Required	
Other restrictions	SVGA 800 x 600	

- To upgrade from Windows XP to Windows Vista, first uninstall software bundled with the Canon inkjet printer.

Additional System Requirements for On-Screen Manuals

Windows	Macintosh
Browser: Windows HTML Help Viewer Note: Microsoft Internet Explorer 5.0 or later must be installed. The on-screen manual may not be displayed properly depending on your operating system or Internet Explorer version. We recommend that you keep your system up to date with Windows Update.	Browser: Help Viewer Note: The on-screen manual may not be displayed properly depending on your operating system or Help Viewer version. We recommend that you keep your system up to date with Software Update.

Specifications are subject to change without notice.

Users in the U.S.A.

■ Regulatory Information

FCC Notice (U.S.A. Only)

For 120V, 60Hz model

Model Number: K10296

This device complies with Part 15 of the FCC Rules. Operation is subject to the following two conditions: (1) This device may not cause harmful interference, and (2) this device must accept any interference received, including interference that may cause undesired operation.

Note: This equipment has been tested and found to comply with the limits for a Class B digital device, pursuant to Part 15 of the FCC Rules. These limits are designed to provide reasonable protection against harmful interference in a residential installation. This equipment generates, uses and can radiate radio frequency energy and, if not installed and used in accordance with the instructions, may cause harmful interference to radio communications.

However, there is no guarantee that interference will not occur in a particular installation. If this equipment does cause harmful interference to radio or television reception, which can be determined by turning the equipment off and on, the user is encouraged to try to correct the interference by one or more of the following measures:

- Reorient or relocate the receiving antenna.
- Increase the separation between the equipment and receiver.
- Connect the equipment into an outlet on a circuit different from that to which the receiver is connected.
- Consult the dealer or an experienced radio/TV technician for help.

Use of a shielded cable is required to comply with Class B limits in Subpart B of Part 15 of the FCC Rules.

Do not make any changes or modifications to the equipment unless otherwise specified in the manual. If such changes or modifications should be made, you could be required to stop operation of the equipment.

Canon U.S.A., Inc.
One Canon Plaza
Lake Success, NY 11042
1-516-328-5600

■ Canon U.S.A., INC. LIMITED WARRANTY --- (U.S.A. Only)

The limited warranty set forth below is given by Canon U.S.A., Inc. ("Canon USA") with respect to the new or refurbished Canon-brand product ("Product") packaged with this limited warranty, when purchased and used in the United States only.

The Product is warranted against defects in materials and workmanship under normal use and service (a) for a period of one (1) year from the date of original purchase when delivered to you in new condition in its original container or (b) for 90 days from the date of original purchase for refurbished Products. Product returned to a Canon USA repair facility or a Canon USA Authorized Service Facility ("ASF"), and proven to be defective upon inspection will be (a) repaired utilizing new, remanufactured, repaired and/or recycled parts (b) exchanged for new or; (c) exchanged for a refurbished Product, as determined by the Canon USA repair facility or the ASF. Warranty repair or replacement shall not extend the original warranty period of the Product. A dated proof of purchase is required at the time of warranty service. A copy of your dated bill of sale will satisfy this requirement. This warranty does not cover any accessories, or any consumables, such as paper or ink cartridges, as to which there shall be no warranty or replacement.

This limited warranty shall only apply if the Product is used in conjunction with compatible computers, peripheral equipment and software. Canon USA shall have no responsibility for such items except for compatible Canon brand peripheral equipment covered by a separate warranty ("Separate Warranty"). Repairs of such Canon brand peripheral equipment shall be governed by the terms of the Separate Warranty. Non-Canon brand equipment and software that may be distributed with the Product are sold "as is" and without warranty of any kind by Canon USA, including any implied warranty regarding merchantability or fitness for a particular purpose, and all such warranties are disclaimed. The sole warranty, if any, with respect to such non-Canon brand items is given by the manufacturer or producer thereof.

This limited warranty covers all defects encountered in normal use of the Product and does not apply in the following cases:

- (a) Loss of or damage to the Product due to abuse, neglect, mishandling, improper packaging by you, alteration, accident, electrical current fluctuations, improper use, failure to follow operating or maintenance instructions in, or environmental conditions prescribed in, Canon USA's user's manual or other documentation, or services performed by someone other than a Canon USA repair facility or ASF. Without limiting the foregoing, dropping the Product, scratches, and abrasions will be presumed to have resulted from misuse, abuse or failure to operate the Product as set forth in the user's manual or other documentation for the Product.
- (b) Use of parts, media, software or supplies (other than those sold by Canon USA), including non-Canon ink cartridges or refilled ink cartridges, that cause damage to the Product or cause abnormally frequent service calls or service problems.
- (c) If the Product has had its serial number or dating defaced, altered or removed.

ANY SYSTEM SOFTWARE (WHETHER FACTORY LOADED ON THE PRODUCT OR CONTAINED ON THE SOFTWARE DISKETTES OR CD-ROMS ENCLOSED WITH, OR ACCOMPANYING, THE PRODUCT), AND ANY UTILITY SOFTWARE, DISTRIBUTED WITH OR FOR THE PRODUCT, IS SOLD "AS IS" AND WITHOUT WARRANTY BY CANON USA. THE SOLE WARRANTY WITH RESPECT TO SUCH SOFTWARE IS CONTAINED IN THE SOFTWARE MANUFACTURER'S LICENSE AGREEMENT DISTRIBUTED THEREWITH, INCLUDING ANY LIMITATIONS AND DISCLAIMERS THEREON. PLEASE CONTACT CANON USA IMMEDIATELY IF YOU HAVE NOT RECEIVED A COPY OF THE SOFTWARE MANUFACTURER'S LICENSE AGREEMENT.

NO IMPLIED WARRANTY, INCLUDING ANY IMPLIED WARRANTY OF MERCHANTABILITY OR FITNESS FOR A PARTICULAR PURPOSE, APPLIES TO THE PRODUCT AFTER THE APPLICABLE PERIOD OF THE EXPRESS LIMITED WARRANTY STATED ABOVE, AND NO OTHER EXPRESS WARRANTY OR GUARANTY, EXCEPT AS MENTIONED ABOVE, GIVEN BY ANY PERSON OR ENTITY WITH RESPECT TO THE PRODUCT SHALL BIND CANON USA, OR ITS ASF. (SOME STATES DO NOT ALLOW LIMITATIONS ON HOW LONG AN IMPLIED WARRANTY LASTS, SO THE ABOVE LIMITATION MAY NOT APPLY TO YOU.) CANON USA SHALL NOT BE LIABLE FOR LOSS OF REVENUES OR PROFITS, INCONVENIENCE, EXPENSE FOR SUBSTITUTE EQUIPMENT OR SERVICE, STORAGE CHARGES, LOSS OR CORRUPTION OF DATA, OR ANY OTHER SPECIAL, INCIDENTAL OR CONSEQUENTIAL DAMAGES CAUSED BY THE USE, MISUSE, OR INABILITY TO USE THE PRODUCT REGARDLESS OF THE LEGAL THEORY ON WHICH THE CLAIM IS BASED, AND EVEN IF CANON USA OR ITS ASF HAS BEEN ADVISED OF THE POSSIBILITY OF SUCH DAMAGES. NOR SHALL RECOVERY OF ANY KIND AGAINST CANON USA OR ITS ASF BE GREATER IN AMOUNT THAN THE PURCHASE PRICE OF THE PRODUCT CAUSING THE ALLEGED DAMAGE. WITHOUT LIMITING THE FOREGOING, YOU ASSUME ALL RISK AND LIABILITY FOR LOSS, DAMAGE OR INJURY TO YOU AND YOUR PROPERTY AND TO OTHERS AND THEIR PROPERTY ARISING OUT OF THE POSSESSION, USE, MISUSE, OR INABILITY TO USE THE PRODUCT SOLD BY CANON USA NOT CAUSED SOLELY AND DIRECTLY BY THE NEGLIGENCE OF CANON USA, OR ITS ASF. (SOME STATES DO NOT ALLOW THE EXCLUSION OR LIMITATION OF INCIDENTAL OR CONSEQUENTIAL DAMAGES, SO THE ABOVE EXCLUSION OR LIMITATION MAY NOT APPLY TO YOU.) THIS LIMITED WARRANTY SHALL NOT EXTEND TO ANYONE OTHER THAN THE ORIGINAL

PURCHASER OF THE PRODUCT OR THE PERSON FOR WHOM IT WAS PURCHASED AS A GIFT, AND STATES YOUR EXCLUSIVE REMEDY.

Canon USA offers a range of customer technical support* options:

- Interactive troubleshooting, e-mail technical support, the latest driver downloads and answers to frequently asked questions (www.canontechsupport.com)
- Toll-free live technical support Monday—Saturday (excluding holidays) at 1-800-828-4040
- Telephone Device for the Deaf (TDD-1-866-251-3752)
- Repair or Exchange Service Options:
In the event service is required for the Product during the limited warranty period, Canon USA offers two hardware support options:

Authorized Service Facility Carry-In / Mail-In Service

Canon USA's Carry-In/Mail-In Service provides repair or exchange, at Canon USA's option, through Canon USA's Authorized Service Facility (ASF) network. The name and telephone number of the ASF(s) near you may be obtained from Canon USA's Web site at www.canontechsupport.com or by calling the Canon USA Customer Care Center at 1-800-828-4040, or any time while speaking to a technical support person. A Product covered by this limited warranty will be repaired or exchanged, as determined by Canon USA, and returned without charge by the ASF.

InstantExchange Service **

A Canon Customer Care Center or ASF technician will attempt to diagnose the nature of the problem and, if possible, correct it over the telephone. If the problem cannot be corrected over the telephone, and you elect the InstantExchange option, a reference number will be issued to you. You will be asked for the Product serial number and other information pertaining to your Product and for a ship-to location for the replacement Product (must include street address).

The Canon USA repair facility will ship out the replacement Product prepaid by Canon USA. After receipt of the replacement Product (with instructions and a prepaid waybill), follow the enclosed instructions on how to ship your product to the Canon USA repair facility. Your Product must be returned in the shipping carton in which the replacement Product was packed and include the reference number, A COPY OF YOUR DATED PROOF OF PURCHASE (BILL OF SALE), and a complete explanation of the problem. DO NOT INCLUDE ANY OTHER ITEMS WITH THE YOUR PRODUCT IN THE RETURN SHIPPING CARTON, AND BE SURE TO RETAIN YOUR PRINTHEAD, INK CARTRIDGE(S) AND TANK(S).

InstantExchange Service exchanges your Product with a replacement Product, which will normally be shipped the same day if your request for this service is by 3 p.m. E.T. Monday through Friday, except holidays. Canon USA does not guarantee same day shipment in the event of the occurrence of factors beyond its reasonable control. The replacement Product you receive may be a refurbished or reconditioned unit and will be covered for the balance of the period remaining on your original limited warranty. NOTE THAT BY USING THIS SERVICE YOU WILL KEEP THE REPLACEMENT PRODUCT THAT IS SENT TO YOU. CANON USA WILL RETAIN THE PRODUCT THAT YOU ORIGINALLY PURCHASED, WHICH SHALL BECOME THE PROPERTY OF CANON USA. InstantExchange warranty program service is available only during the express limited-warranty period for your Product and only in the continental United States, Alaska and Hawaii during such period.

This limited warranty gives you specific legal rights, and you may also have other rights, which vary from state to state.

* Support program specifics are subject to change without notice.

** InstantExchange warranty service is subject to the availability of refurbished or new replacement units.

Canon U.S.A., Inc.
One Canon Plaza
Lake Success, NY 11042
USA

© 2008 Canon U.S.A., Inc. Canon is a registered trademark of Canon Inc. in the United States and may also be a registered trademark in other countries.

For California, USA only

This product contains an internal battery for backup purposes.

Included battery contains Perchlorate Material-special handling may apply.

See <http://www.dtsc.ca.gov/hazardouswaste/perchlorate/> for details.

Index

A

Appendix 76

B

Before Using the Printer 6

C

Canon U.S.A., Inc. Limited Warranty - USA Only 82

Cleaning

exterior 50

inside 53

protrusions inside the printer 56

roller 50

I

Ink Lamp

ink level indication on the computer 44

ink level indication on the printer 43

L

Loading Printing Paper

envelopes 15

paper 13

recommended paper and requirements 11

small-sized paper 17

M

Media

cannot use 12

specialty 10

Media Type 11

N

Nozzle Check Pattern

examining 27

printing 25

P

Print Head

aligning 33

cleaning 28

deep cleaning 31

Printing from Your Computer 18

Macintosh 19

Windows 18

Printing Photographs Directly from a Compliant

Device 20

PictBridge print settings 22

R

Replacing Ink Tanks 45

ink status information 43

Routine Maintenance 24

S

Safety Precautions 3

Specialty Media 10

Specifications

general 80

PictBridge 80

System Requirements 81

T

Troubleshooting 57

Turning off the Printer 9

Turning on the Printer 8

Ordering Information

For additional supplies, use the following descriptions and order numbers.

Description	Order #
FINE Cartridges	
PGI-35 Black	1509B002
CLI-36 Color	1511B002
Canon Specialty Papers	
All Occasion Photo Cards (4" x 8"/ 50 sheets)	1029A069
Glossy Photo Paper Credit Card Size (100 sheets)	9157A023
High Resolution Paper (8.5" x 11"/ 100 sheets)	1033A011
Matte Photo Paper (4" x 6"/ 120 sheets)	7981A014
Matte Photo Paper (8.5" x 11"/ 50 sheets)	7981A004
Photo Paper Glossy (4" x 6"/ 50 sheets)	0775B021
Photo Paper Glossy (4" x 6"/ 100 sheets)	0775B022
Photo Paper Glossy (8.5" x 11"/ 50 sheets)	0775B023
Photo Paper Glossy (8.5" x 11"/ 100 sheets)	0775B024
Photo Paper Plus Double Sided (5" x 7"/ 10 sheets)	9981A006
Photo Paper Plus Double Sided (8.5" x 11"/ 10 sheets)	9981A005
Photo Paper Plus Double Sided Album Kit (5" x 7")	0041B005
Photo Paper Plus Double Sided Album Kit (8.5" x 11")	0041B006
Photo Paper Plus Glossy (4" x 6"/ 50 sheets)	7980A012
Photo Paper Plus Glossy (4" x 6"/ 120 sheets)	7980A022
Photo Paper Plus Glossy (5" x 7"/ 20 sheets)	7980A019
Photo Paper Plus Glossy (8.5" x 11"/ 20 sheets)	7980A006
Photo Paper Plus Glossy II (4" x 6"/ 50 Sheets)	2311B022
Photo Paper Plus Glossy II (4" x 6"/ 100 Sheets)	2311B023
Photo Paper Plus Glossy II (4" x 6"/ 400 Sheets)	2311B031
Photo Paper Plus Glossy II (5" x 7"/ 20 Sheets)	2311B024
Photo Paper Plus Glossy II (8" x 10"/ 20 Sheets)	2311B025
Photo Paper Plus Glossy II (8.5" x 11"/ 20 Sheets)	2311B001
Photo Paper Plus Semi-gloss (4" x 6"/ 50 sheets)	1686B014
Photo Paper Plus Semi-gloss (8" x 10"/ 20 sheets)	1686B017
Photo Paper Plus Semi-gloss (8.5" x 11"/ 20 sheets)	1686B020
Photo Paper Pro (8" x 10"/ 20 sheets)	1029A059
Photo Paper Pro (8.5" x 11"/ 15 sheets)	1029A004
Photo Stickers (16 stickers/sheet, 5 sheets/pack)	0001C001

Call **1-800-OK-CANON** to locate a dealer near you, or visit the Canon eStore at www.estore.usa.canon.com.

The following ink tanks are compatible with this product.



CLI-36 Color



PGI-35 Black

For information on product specifications, please visit our website at www.usa.canon.com