

Canon

SPEEDLITE TRANSMITTER ST-E3-RT (Ver.2)



Advanced User Guide

Introduction

The Canon Speedlite Transmitter ST-E3-RT (Ver.2) is a transmitter for wireless flash shooting. It can control up to 5 groups (15 units) of Canon Speedlites that have a wireless multiple flash shooting function using radio transmission. The transmitter also has dust and water resistance equivalent to EOS-1D series cameras.

- **Read this instruction manual while also referring to the instruction manuals of your camera and Speedlite.**

Before using the transmitter, read this instruction manual and the instruction manuals of your camera and Speedlite to familiarize yourself with the operations.

Using the transmitter with a Camera

- **Using with an EOS digital camera**
 - You can perform wireless autoflash shooting with easy operations.
- **Using with an EOS film camera**
 - **When using with an EOS film camera compatible with E-TTL II and E-TTL autoflash systems**, you can perform autoflash shooting with easy operations.
 - **This unit cannot be used with an EOS film camera with TTL autoflash system.**

Chapters

	Introduction	2
1	Getting Started Preparations for wireless flash shooting	11
2	Wireless Flash Shooting: Radio Transmission Wireless flash shooting with radio transmission	15
3	Setting Transmitter Functions with Camera Operations Setting the transmitter functions from the camera's menu screen	49
4	Customizing the Transmitter Customizing with Custom Functions and Personal Functions	55
5	Reference System map, FAQ	61

Contents

Introduction	2
Chapters	3
Nomenclature.....	6
Conventions Used in this Manual	10
1 Getting Started	11
Installing the Batteries.....	12
Attaching and Detaching the Transmitter.....	13
Turning on the Power.....	13
2 Wireless Flash Shooting: Radio Transmission	15
(☑) Wireless Flash Shooting	16
Wireless Settings	20
ETTL : Fully Automatic Wireless Flash.....	24
Using Fully Automatic Wireless Flash.....	27
ETTL : Wireless Multiple Flash Shooting with Flash Ratio	32
M : Wireless Multiple Flash Shooting with Manual Flash Output	35
Gr : Shooting with a Different Flash Mode for Each Group	40
Clearing Transmitter Settings	42
Test Flash from a Receiver Unit.....	42
Modeling Flash.....	43
Remote Release from a Receiver Unit.....	44
Linked Shooting	45
3 Setting Transmitter Functions with Camera Operations	49
Transmitter Control from Camera's Menu Screen	50

4 Customizing the Transmitter 55

C.Fn / P.Fn: Setting Custom and Personal Functions	56
C.Fn: Setting Custom Functions	58
P.Fn: Setting Personal Functions	60

5 Reference 61

ST-E3-RT (Ver.2) System	62
Troubleshooting Guide	63
Specifications	66
Index	70

Nomenclature

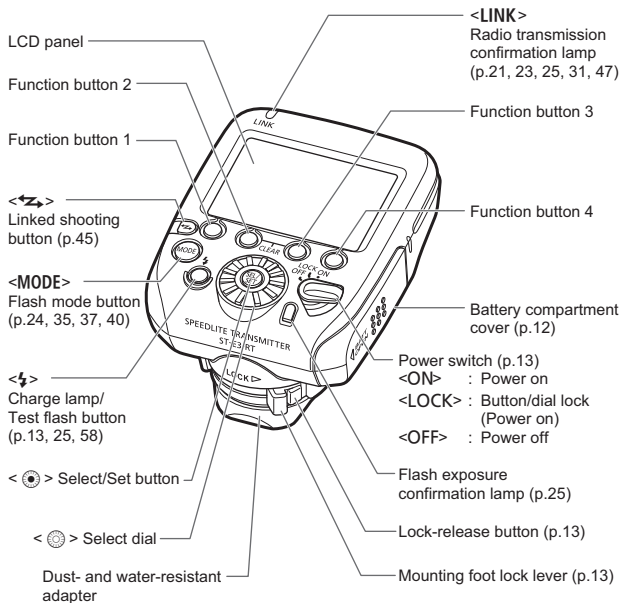

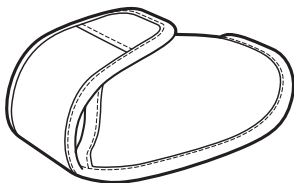
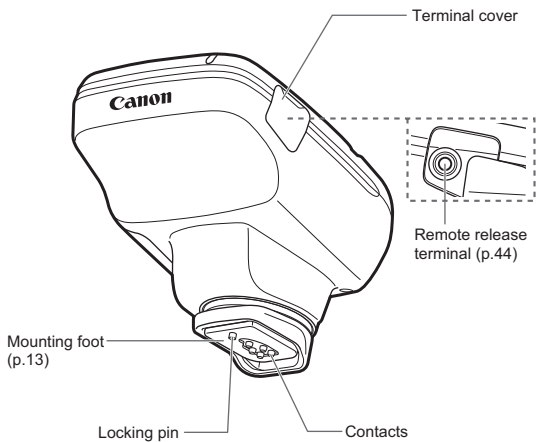
**Case**

LCD panel

Radio transmission wireless shooting (p.15)

● E-TTL II/E-TTL autoflash (p.24)

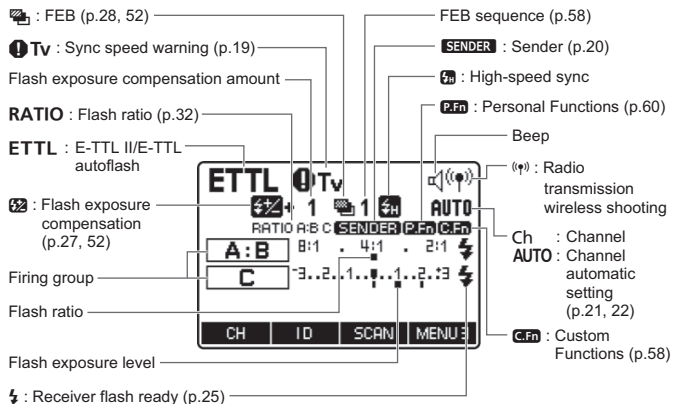

● Manual flash (p.35)

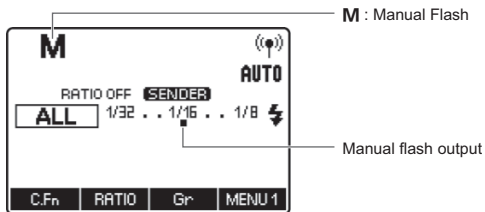

- The display will show only the settings currently applied.
- The functions displayed above function buttons 1 to 4, such as **C.Fn** and **1/16**, change according to the setting's status.
- When a button or dial is operated, the LCD panel illuminates (p.14).

● Stroboscopic flash (p.37)

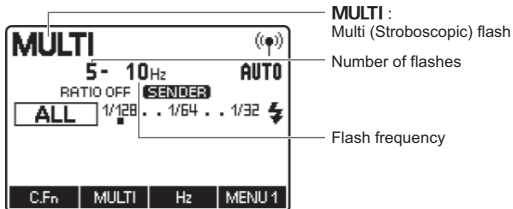

● Group firing (p.40)

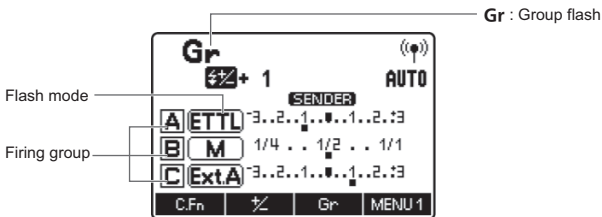



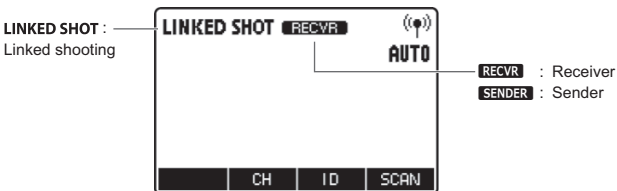



● Linked shooting (p.45)



Conventions Used in this Manual

Icons in this Manual

-  : Indicates the selection dial.
-  : Indicates the select/set button.
-  /  /  : Indicates that the respective function remains active for 4 sec., 6 sec. or 16 sec. after you let go of the button.
- (p.**)
-  : Warning to prevent shooting problems.
-  : Supplemental information.

Basic Assumptions

- The operation procedures assume that the power switches of the camera, transmitter and Speedlite are already set to <ON>.
- The icons used for buttons, dials and symbols in the text match the icons found on the camera, transmitter and Speedlite.
- The operation procedures assume that the menu and Custom Functions of the camera and the Custom Functions and Personal Functions of the transmitter and the Speedlite are at their default settings.
- All figures are based on the use of two AA/LR6 alkaline batteries and Canon's testing standards.

1

Getting Started

This chapter describes the preparations before starting wireless flash shooting.

Installing the Batteries

Install two AA/LR6 batteries.

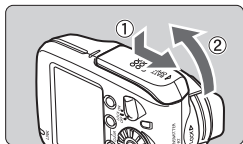

1 Open the cover.

- Slide the cover down as shown in ① and open the battery compartment cover.

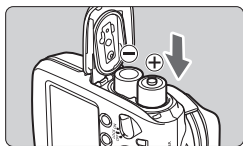

2 Install the batteries.

- Make sure the + and – battery contacts are correctly oriented as shown in the battery compartment.
- The grooves on the side surfaces of the battery compartment indicate –. This is convenient when replacing the batteries in a dark place.

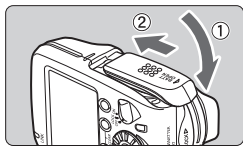

3 Close the cover.



- Close the battery compartment cover and slide it up.
- Slide the cover until it clicks in place.

Wireless Flash Shooting Time

You can perform wireless flash shooting for approx. 10 hours* continuously.

* Based on new AA/LR6 alkaline batteries and Canon's testing standards.

 Using AA/LR6 batteries other than the alkaline type may cause improper battery contact due to the irregular shape of the battery contacts.

- 
- When  is displayed, replace the batteries with new ones.
 - Use a new set of two batteries of the same brand. When replacing the batteries, replace both batteries at once.
 - AA/LR6 rechargeable Ni-MH or lithium batteries can also be used.

Attaching and Detaching the Transmitter

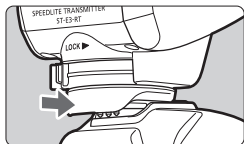

1 Attach the transmitter.

- Slip the transmitter's mounting foot **all the way into** the camera's hot shoe.

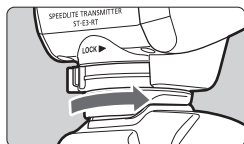

2 Secure the transmitter.

- On the mounting foot, slide the lock lever to the right.
- ▶ When the lock lever clicks in place, it will be locked.

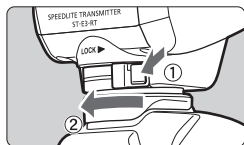

3 Detach the transmitter.

- While pressing the lock-release button, slide the lock lever to the left and detach the transmitter.



Before attaching or detaching the transmitter, be sure to turn the transmitter power off.

Turning on the Power

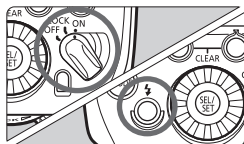

Set the power switch to <ON>.

- ▶ The LCD panel illuminates.
- The charge lamp lights when the wireless shooting (receiver) is ready.
- During wireless shooting, press the transmitter's charge lamp (test flash button) to fire a test flash.

About Auto Power Off

To save battery power, the power will turn off automatically after 5 min. of idle use. To turn on the transmitter again, press the camera's shutter button halfway, or press the test flash button (charge lamp).

About the Lock Function

By setting the power switch to <LOCK>, you can disable flash's button and dial operations. Use this to prevent the transmitter function settings from being accidentally changed after you set them.

If you operate a button or dial, <LOCKED> is displayed on the LCD panel (the functions displayed above function buttons 1 to 4, such as <C.Fn > and < 1/2 >, are not displayed).

About the LCD Panel Illumination

When a button or dial is operated, the LCD panel illuminates in green for 12 sec. When setting a function, the illumination continues until the setting is complete.

If the transmitter is the sender unit in linked shooting, the LCD panel illuminates in green. If the transmitter is a receiver unit, it illuminates in orange.





- You cannot use the test flash while the camera's 4/6/16 timer is operating.
- The transmitter settings are stored even when the power is turned off. To retain the settings when replacing the batteries, replace the batteries within 1 min. of turning off the power switch and removing the batteries.
- You can fire a test flash even when the power switch is set to the <LOCK> position. Also, when a button or dial is operated, the LCD panel illuminates.
- You can set a beep to sound when the receiver unit is fully charged (C.Fn-20/p.59).
- Auto power off can be disabled (C.Fn-01/p.58).
- You can change the duration of the LCD panel illumination (C.Fn-22/p.59).
- You can change the color of the LCD panel illumination (P.Fn-03, 04/p.60).

2

Wireless Flash Shooting: Radio Transmission

This chapter describes wireless flash shooting.
**For the accessories required for wireless shooting,
see the system map (p.62).**

 **When the camera's shooting mode is set to a fully automatic mode or an Image Zone mode, the operations in this chapter are not available. Set the camera's shooting mode to P/Tv/Av/M/ B (Creative Zone mode).**

 The transmitter attached to the camera is called the sender unit, and a flash that is wirelessly controlled is called the receiver unit.

(☑) Wireless Flash Shooting

Using a transmitter and a Canon Speedlite compatible with radio transmission wireless shooting makes it easy to shoot with advanced wireless multiple flash lighting, in the same way as normal E-TTL II/E-TTL autoflash shooting.

The system is designed so that the settings of the transmitter attached to the camera (sender) are automatically reflected on the Speedlite that is wirelessly controlled (receiver). Therefore, you do not need to operate the receiver unit while shooting.

The basic relative positions and operating range are as shown in the figure. You can then perform wireless E-TTL II/E-TTL autoflash shooting just by setting the sender unit to <ETTL>.

Positioning and Operation Range (Example of wireless flash shooting)

● Autoflash Shooting Using One Receiver Unit (p.24)

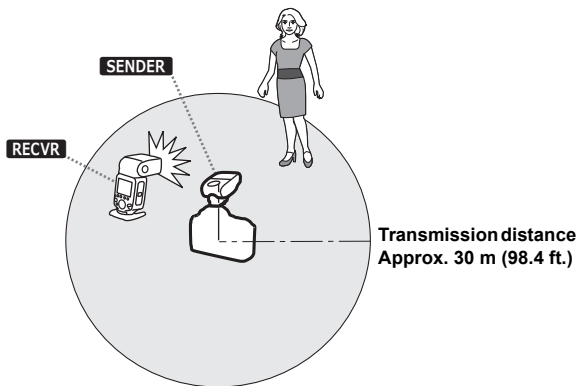

- Position the receiver unit using the mini stand supplied with the flash.
- Before shooting, perform a test flash (p.13) and test shooting.
- The transmission distance may be shorter depending on the conditions such as the positioning of receiver units, the surrounding environment and weather conditions.

Wireless Multiple Flash Shooting

You can divide the receiver units into two or three groups and perform E-TTL II/E-TTL autoflash shooting while changing the flash ratio (factor). In addition, you can set and shoot with a different flash mode for each firing group, for up to 5 groups.

● Autoflash Shooting with Two Receiver Groups (p.32)

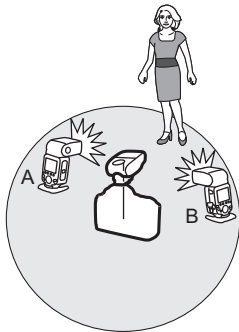

● Autoflash Shooting with Three Receiver Groups (p.33)

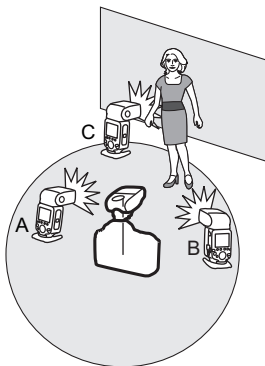

● Shooting with a Different Flash Mode set for Each Group (p.40)

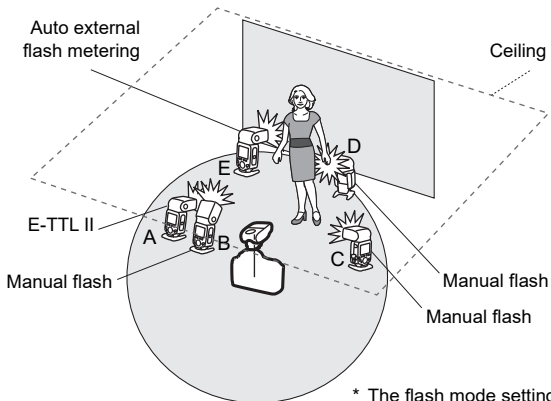

* The flash mode settings are indicated only as an example.

About Restrictions on Functions Depending on the Camera Used

When performing radio transmission wireless flash shooting, restrictions may apply to the flash mode, maximum flash sync speed (referred to below as the “flash sync speed”) and high-speed sync function, depending on the camera that you use.

- **EOS digital cameras released since 2012**

When using the transmitter in combination with a camera such as the EOS-1D X, you can shoot without any restrictions on the flash mode and maximum flash sync speed.

* Although EOS REBEL T100/4000D/3000D, EOS REBEL T7/1500D/2000D, EOS REBEL T6/1300D and EOS REBEL T5/1200D was released since 2012, restrictions on functions are the same as with EOS digital cameras released up to 2011. (See the following explanation for details.) Radio transmission wireless flash shooting using E-TTL autoflash can be performed with EOS REBEL T100/4000D/3000D, EOS REBEL T7/1500D/2000D, EOS REBEL T6/1300D and EOS REBEL T5/1200D.

- **EOS cameras compatible with E-TTL autoflash and released up to 2011**

When using the transmitter with the cameras listed below, **radio transmission wireless shooting with E-TTL autoflash is not available**. Shoot with manual flash (p.35) or stroboscopic flash (p.37).

EOS-1Ds, EOS-1D, EOS-1V, EOS-3, EOS ELAN II(E)/EOS 50(E), EOS REBEL 2000/EOS 300, EOS REBEL G/EOS 500N, EOS 66/EOS Rebel XS N/EOS 3000 N, EOS IX(E), EOS IX Lite/EOS IX 7

Also, when using the transmitter with an EOS digital camera or EOS film camera released up to 2011, the following restrictions apply.

1. **The flash sync speed is 1 increment slower**

Check the flash sync speed ($X = 1/**$ sec.) of your camera, and shoot with a shutter speed up to a maximum of 1 stop slower than the flash sync speed (Example: When $X = 1/250$ sec., radio transmission wireless shooting is possible from $1/125$ sec. to 30 sec.). Also, **high-speed sync shooting is not possible**. When you set the shutter speed 1 increment slower than the flash sync speed, the <Tv> warning icon will disappear.

2. **Group flash is not possible** (p.40).

Wireless Settings

To perform wireless shooting, set the transmitter (sender unit) and flash (receiver unit) with the following procedure.

Sender Unit Setting

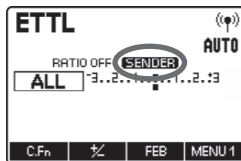

Check that **<SENDER>** is displayed.

- Check that **<SENDER>** is displayed at the position shown in the figure.

Receiver Unit Setting

Set a flash that is compatible with radio transmission wireless flash shooting as the receiver unit.

- For the receiver unit settings, see the flash's instruction manual.

Transmission Channel/Wireless Radio ID Settings

To avoid interference with wireless multiple flash systems using radio transmission that are used by other photographers, or with other devices that use radio waves (wireless), you can change the transmission channel and wireless radio ID. **Set the same channel and ID for both the sender unit and receiver unit.**

 When establishing multiple radio transmission wireless flash systems, interference between flash systems may occur, even if the flashes are set to different channels. Set different radio transmission IDs for each channel (p.21).

● Setting the Sender Unit Transmission Channel / Wireless Radio ID

Use the following procedure to set the sender unit's transmission channel and wireless radio ID. Set the same channel and ID for both the sender unit and receiver unit. For the receiver unit settings, see the flash's instruction manual.

1 Display <MENU 3>.

- Press function button 4 to display <MENU 3>.

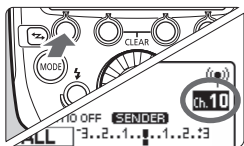

2 Set a channel.

- Press function button 1 <CH>.
- Turn <⊙> to select "AUTO" or a channel from Ch. 1 to 15, and press the <⊙> button.

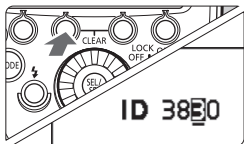

3 Set a wireless radio ID.

- Press function button 2 <ID>.
- Turn <⊙> to select the position (digit) to set, and press the <⊙> button.
- Turn <⊙> to select a number from 0 to 9, and press the <⊙> button.
- Repeat step 3 to set a 4-digit number.
- Press function button 4 <5> to return to the shooting-ready state.

- ▶ When transmission between the sender unit and receiver unit is established, the <LINK> lamp is lit in green.

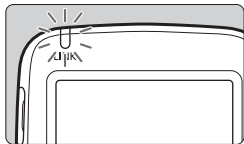

● Scanning the Sender Unit Transmission Channels to Set

You can scan the radio reception status and set the sender unit's transmission channel automatically or manually. When the channel is set to "AUTO", the channel with the best reception signal is automatically set. When setting the channel manually, you can set the transmission channel again while referring to the scan results.

Scanning while "AUTO" is set

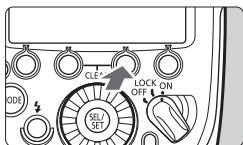

Run the scan.

- Press function button 4 to display < MENU 3 >.
- Press function button 3 < SCAN >.
- ▶ The channel is reset to one with a good reception signal.

Scanning while Ch. 1 to 15 is set

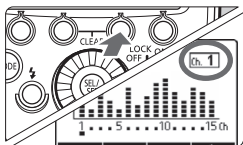

1 Run the scan.

- Press function button 4 to display < MENU 3 >.
- Press function button 3 < SCAN >.
- ▶ The radio reception status is displayed in a graph.
- The higher the peak of the channel in the graph, the better the radio reception signal.

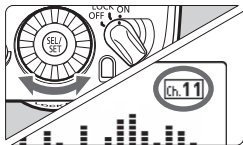

2 Set a channel.

- Turn < [Dial] > to select a channel from Ch. 1 to 15.
- Press the < [Dial] > button to set the channel and return to the shooting-ready state.

About the <LINK> Lamp

The color of the <LINK> lamp changes depending on the transmission status of the sender unit and the receiver unit.

Color	Status	Description	Action
Green	Lit	Transmission OK	–
Red	Lit	Not connected	Check the channel and ID
	Blinking	Too many units	Sender units + receiver units = 16 units or less
		Error	Turn the power off and on again



- If the transmission channels of the sender unit and receiver unit are different, the receiver unit does not fire. Set both to the same number, or set both to “AUTO”.
- If the wireless radio IDs of the sender unit and receiver unit are different, the receiver unit does not fire.

About the Memory Function

You can save the wireless settings and recall the settings later.

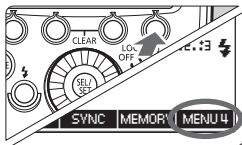

1 Press function button 4.

- Press function button 4 to display <MENU 4>.

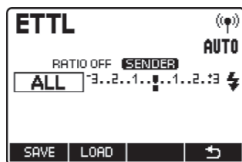

2 Save or load the settings.

- Press function button 3 <MEMORY>.

[Save]

- Press function button 1 <SAVE>.
- ▶ The settings are saved (stored in the memory).

[Load]

- Press function button 2 <LOAD>.
- ▶ The settings that were saved are set.

ETTL: Fully Automatic Wireless Flash Shooting

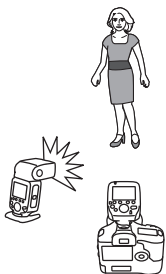

This section describes basic fully automatic wireless shooting when using a transmitter attached to the camera (sender) and a wirelessly controlled flash (receiver).

Autoflash Shooting Using One Receiver Unit

1 Set the flash as the receiver unit.

- For the receiver unit settings, see the flash's instruction manual.
- Set A, B or C as the firing group. The flash will not fire if it is set to D or E.

2 Check the channel and ID.

- If the channels and IDs of the sender unit and receiver unit are different, set them to the same numbers (p.21, 22).

3 Position the camera and the flash.

- Position them within the range shown on page 16.

4 Set the flash mode to <ETTL>.

- Press the <MODE> button on the sender unit and set the flash mode to <ETTL>.
- The receiver unit is set automatically to <ETTL> during shooting via the control from the sender unit.

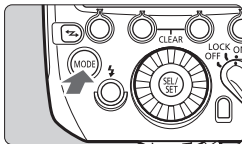

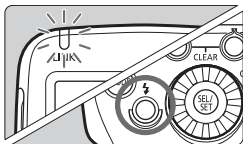

5 Check the transmission status and that the flash is ready.

- Check that the <LINK> lamp is lit in green.
- When the receiver flash is ready, the AF-assist beam emitter blinks at 1-second intervals.
- Check that the <⚡> receiver flash-ready icon is lit on the sender unit's LCD panel.
- When the recycling of all the flash units is completed, the sender unit's charge lamp lights.

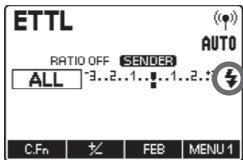

6 Check the operation.

- Press the sender unit's test flash button (charge lamp).
- ▶ The receiver unit flashes. If the receiver unit does not fire, check that it is placed within the operation range.

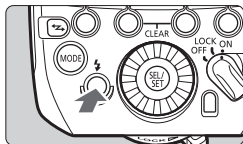

7 Take the picture.

- Set the camera and take the picture, in the same way as with normal flash shooting.
- ▶ If a standard flash exposure was obtained, the flash exposure confirmation lamp lights for 3 sec.

! If the <LINK> lamp is red, radio transmission has not been established. Check again the transmission channels and wireless radio IDs of the sender unit and receiver unit. If you cannot connect with the same settings, turn the power off and on again.

Autoflash Shooting Using Multiple Receiver Units

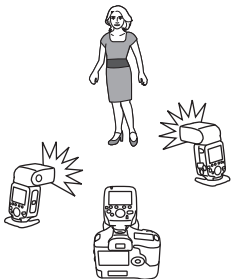

When you need more flash output or you want to perform lighting more easily, you can increase the number of receiver units and fire them as a single flash. To add receiver units, use the same procedure as “Autoflash Shooting Using One Receiver Unit”. Set A, B or C as the firing group. The flash will not fire if it is set to D or E.

When the number of receiver units is increased, automatic control is performed to fire all flashes at the same flash output and ensure that the total flash output results in the standard exposure.



- You can press the depth-of-field preview button on the camera to fire the modeling flash (p.43).
- If the receiver unit's auto power off takes effect, press the sender unit's test flash button (p.13) to turn on the receiver unit. Note that the test flash cannot be fired while the camera's metering timer is operating.
- The autoflash system (E-TTL II/E-TTL) depends on the camera used and is set automatically. Note that <ETTL> is displayed on the LCD panel for both systems.
- You can enable a beep to sound when the charge of all the receiver units is complete (C.Fn-20/p.59).

Using Fully Automatic Wireless Flash

Flash exposure compensation and other settings set on the transmitter (sender unit) will also be automatically set in the flash (receiver unit). You do not need to operate the receiver unit.

Flash Exposure Compensation

In the same way as normal exposure compensation, you can set exposure compensation for flash. The flash exposure compensation amount can be set up to ± 3 stops in 1/3-stop increments.

1 Display **< MENU 1 >**.

- Press function button 4 to display **< MENU 1 >**.

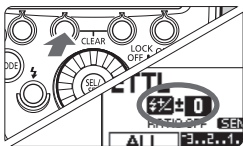

2 Press the **< ± >** button.

- Press function button 2 **< ± >**.
- ▶ **< ± >** is displayed and the flash exposure compensation amount is highlighted.

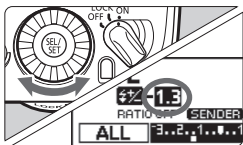

3 Set the flash exposure compensation amount.

- Turn **< ⦿ >** to set the flash exposure compensation amount, and press **< ⦿ >**.
- ▶ The flash exposure compensation amount is set.
- “0.3” indicates 1/3 stops and “0.7” indicates 2/3 stops.
- To cancel flash exposure compensation, return the compensation amount to “ ± 0 ”.



- Generally, set an increased exposure compensation for bright subjects and set a decreased exposure compensation for dark subjects.
- If the camera's exposure compensation is set to 1/2-stop increments, flash exposure compensation will be up to ± 3 stops in 1/2-stop increments.
- When the flash exposure compensation is set on both the transmitter and the camera, the transmitter setting is given priority.
- The flash exposure compensation amount can be set directly with **< ⦿ >** without pressing the button (C.Fn-13/p.59).

FEB

You can take three shots while automatically changing the flash output. This is called FEB (Flash Exposure Bracketing). The settable range is up to ± 3 stops in 1/3-stop increments.

1 Display < MENU 1 >.

- Press function button 4 to display < MENU 1 >.

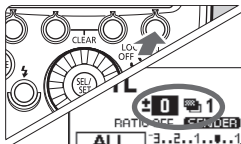

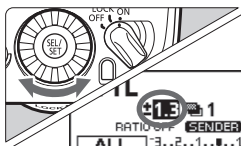

2 Press the < FEB > button.

- Press function button 3 < FEB >.
- ▶ <  > is displayed and the FEB level display is highlighted.



3 Set the FEB level.

- Turn <  > to set the FEB level, and press <  >.
- ▶ The FEB level is set.
- “0.3” indicates 1/3 stops and “0.7” indicates 2/3 stops.
- When used together with flash exposure compensation, FEB shooting is performed based on the flash exposure compensation amount.



- After the three shots are taken, FEB is canceled automatically.
- Before shooting with FEB, it is recommended to set the camera's drive mode to single shooting and check that the flash is recycled.
- You can use FEB together with flash exposure compensation or FE lock.
- If the camera's exposure compensation is set to 1/2-stop increments, flash exposure compensation will be up to ± 3 stops in 1/2-stop increments.
- You can set FEB to remain enabled automatically after shooting the three shots (C.Fn-03/p.58).
- You can change the FEB shooting sequence (C.Fn-04/p.58).

High-speed Sync

With the high-speed sync function, the flash can synchronize with all shutter speeds. This is convenient when you want to use aperture-priority AE for fill-flash portraits of a subject.

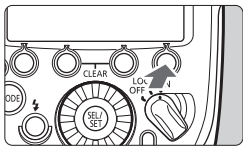

1 Display <MENU 4>.

- Press function button 4 to display <MENU 4>.

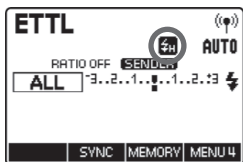

2 Set the sync setting to <H>.

- Press function button <SYNC> to set <H>.
- Check that <H> is lit in the viewfinder.



- When using the transmitter with EOS cameras compatible with E-TTL and released up to 2011 or EOS REBEL T100/4000D/3000D, EOS REBEL T7/1500D/2000D, EOS REBEL T6/1300D and EOS REBEL T5/1200D, high-speed sync is not possible with radio transmission wireless flash shooting (p.19).
- With high-speed sync, the faster the shutter speed, the shorter the effective flash range will be.



- If you set a shutter speed that is equal to or slower than the camera's maximum flash sync speed, <H> will not be displayed in the viewfinder.
- To return to normal flash shooting, press function button 2 <SYNC> to turn off <H>.
- High-speed sync is not available during stroboscopic flash.

▶▶ Second-Curtain Sync

Shooting with a slow shutter speed and second-curtain sync captures the trail of the light sources of a moving subject, such as car lights, in a natural way. The flash fires right before the exposure finishes (shutter closes).

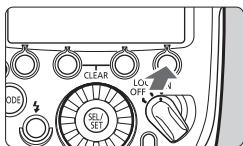

1 Display <MENU 4>.

- Press function button 4 to display <MENU 4>.

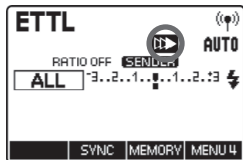

2 Set the sync setting to <▶▶>.

- Press function button <SYNC> to set <▶▶>.



- Check the cameras that support second-curtain sync on the Canon website.
- The second-curtain sync works well when the camera's shooting mode is set to (bulb shooting).
- When the flash mode is set to <ETTL>, the flash fires twice. The first flash is a preflash to determine the flash output. It is not a malfunction.
- To return to normal flash shooting, press function button 2 <SYNC> to turn off <▶▶>.

FEL: FE Lock

FE (Flash Exposure) lock locks the correct flash exposure setting for any part of the scene.

Perform FE lock by operating the camera. For the operations, see the camera and flash's instruction manual.



- If a correct exposure cannot be obtained when FE lock is performed, <⚡> blinks in the viewfinder. Move the receiver unit closer to the subject, open the aperture, and perform FE lock again. You can also increase the ISO speed when using a digital camera.
- If the target subject is too small in the camera's viewfinder, FE lock might not be very effective.

About Sender Units

You can use two or more sender units (sender units + receiver units = maximum of 16 units). By preparing multiple cameras with sender units attached, you can shoot by changing cameras while keeping the same lighting (receiver units).

Note that when using two or more sender units, the color of the <LINK> lamp varies depending on the order in which the power was turned on. The first sender (main sender) is green and the second and subsequent sender (sub-sender) are orange.



If the <LINK> lamp is red, the connection has not been established. After checking the transmission channel and wireless radio ID, turn the power of each sender unit off, and turn it on.

ETTL: Wireless Multiple Flash Shooting with Flash Ratio

Autoflash Shooting with Two Receiver Groups

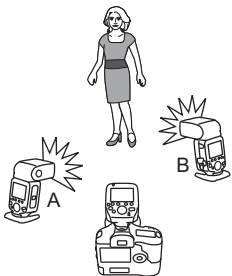

You can divide the receiver units into two firing groups, A and B, and adjust the lighting balance (flash ratio) for shooting. The exposure is controlled automatically so that the total flash output of firing groups A and B results in the standard exposure.

1 Set the firing group of the receiver units.

- Operate and set the receiver units one by one.
- **Set one unit to < A > and set the other to < B >.**
- For the receiver unit settings, see the flash's instruction manual.

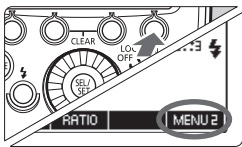

2 Display < MENU 2 >.

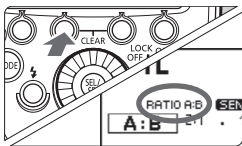

- The operations in steps 2 to 4 are set on the sender unit.
- Press the sender unit's function button 4 to display < MENU 2 >.

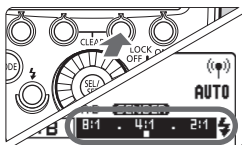

3 Set to < RATIO A:B >.

- Press function button 2 < RATIO > and set to < RATIO A:B >.



- 4 Set the flash ratio.**
- Press function button 3 < Gr >.
 - Press function button 3 < A:B $\frac{1}{2}$ >.
 - Turn <  > to set the flash ratio, and press the <  > button.
 - Press function button 4 <  > to return to the shooting-ready state.

- 5 Take the picture.**
- ▶ The receiver units flash at the set flash ratio.

Autoflash Shooting with Three Receiver Groups

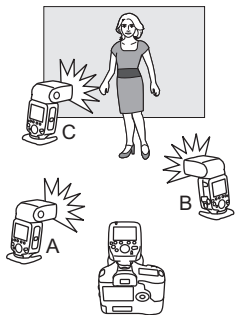



You can add firing group C to firing groups A and B. C is convenient to set lighting so as to eliminate the subject's shadow.

The basic setting method is the same as "Autoflash Shooting with Two Receiver Groups".

- 1 Set a flash as firing group C.**
- For the receiver unit settings, see the flash's instruction manual.
- 2 Set to <RATIO A:B C>.**
- Set the sender unit to <RATIO A:B C> in the same way as steps 2 and 3 on the preceding page.

3 Set flash exposure compensation as required.

- Press function button 3 < **Gr** >, turn <  > and select < **C** >.
- Press function button 3 < **C 1/2** >.
- Turn <  > to set the flash exposure compensation amount, and press the <  > button.
- Press function button 4 < **↶** > to return to the shooting-ready state.

Receiver Group Control

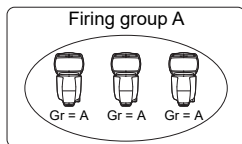

If you need more flash output or wish to perform more sophisticated lighting, you can increase the number of receiver units. Simply set an additional receiver unit to the firing group (A, B or C) whose flash output you want to increase. You can increase the number of receiver units up to 15 units in total.

For example, if you set a firing group with three receiver units to < **A** >, the three units are controlled as a single firing group A with a large flash output.

- To fire the three firing groups A, B and C at the same time, set < **RATIO A:B C** >. With the < **RATIO A:B** > setting, firing group C does not fire.
- If you shoot with firing group C pointing directly toward the main subject, overexposure may result.

- The flash ratio of 8:1 to 1:1 to 1:8 is equivalent to 3:1 to 1:1 to 1:3 (1/2-stop increments) when converted to number of stops.
- The details of the flash ratio settings are as follows.

8:1 ● 4:1 ● 2:1 ● 1:1 ● 1:2 ● 1:4 ● 1:8
 ⋮ ⋮ ⋮ ■ ⋮ ⋮ ⋮
 5.6:1 2.8:1 1.4:1 1:1.4 1:2.8 1:5.6

M: Wireless Multiple Flash Shooting with Manual Flash Output

This describes wireless (multiple flash) shooting using manual flash. You can shoot with a different flash output setting for each receiver unit (firing group). Set all parameters on the sender unit.

1 Set the flash mode to <M>.

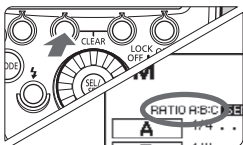

2 Set the number of firing groups.

- While <MENU 1> is displayed, press function button 2 <RATIO> and set the groups to fire.
- The setting changes as follows each time you press the button:
ALL (<RATIO OFF>) →
A/B (<RATIO A:B>) →
A/B/C (<RATIO A:B:C>).

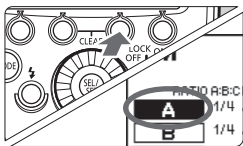

3 Select a firing group.

- Press function button 3 <Gr>, turn <⊙> and select the group for which you want to set the flash output.

4 Set the flash output.

- Press function button 3 <*/>.
- Turn <⊙> to set the flash output, and press the <⊙> button.
- Repeat steps 3 and 4 to set the flash output of all groups.

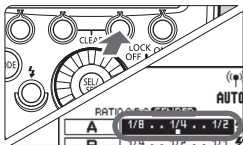

5 Take the picture.

- ▶ Each group fires at the set flash output.



- When ALL <RATIO OFF> is set, set A, B or C as the firing group for the receiver units. The flash will not fire if it is set to D or E.
- To fire multiple receiver units with the same flash output, select ALL <RATIO OFF> in step 2.

How to Set the Firing Output of the Manual Flash with the FE Memory Function

You can set the firing output adjusted in firing mode <ETTL> as the firing output of the firing mode <M>.

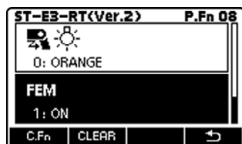

1 Set the FE memory function.

- Set the P.Fn-08 <FEM> setting in the personal functions to 1:ON (p.60).

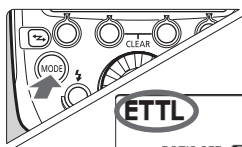

2 Set the flash mode to <ETTL>.

- Press the sender <MODE> button to set <ETTL> as the flash mode.

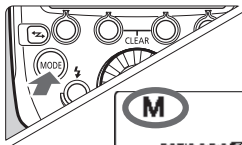

3 Take the picture.

- Press the shutter button fully to shoot.

4 Set the flash mode to <M>.

- Press the sender <MODE> button to set <M> as the flash mode.

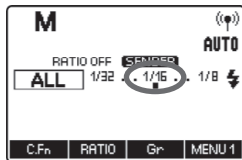

5 Check the flash output.

- When firing the flash with the <ETTL> setting, make sure that charging has been completed for all of the flashes (sender charge lamp lit).
- After shooting with the <ETTL> setting, if you make a change in the ISO sensitivity, aperture value or settings related to the firing output such as the light intensity, zoom, etc., we recommend that you shoot with the <ETTL> setting again.

MULTI: Stroboscopic Flash

Stroboscopic flash is an advanced manual flash shooting method. When using stroboscopic flash with a slow shutter speed, you can shoot multiple successive movements within a single picture, similar to stop-motion pictures.

In stroboscopic flash, set the flash output, number of flashes, and flash frequency (number of flashes per second = Hz). For the maximum number of continuous flashes, see page 39.

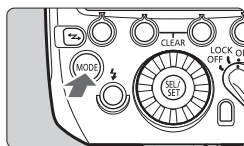

1 Set the flash mode to <MULTI>.

- Press the <MODE> button on the sender unit and set to <MULTI>.

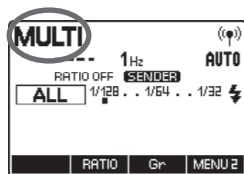

2 Set the firing groups and the flash output.

- Set the number of firing groups and the flash output for each group by referring to the manual flash, see page 35.

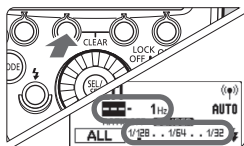

3 Set the flash frequency and the number of flashes.

- While <MENU 1> is displayed, perform the following procedure.
- To set the number of flashes, press function button 2 <MULTI>, turn <SEL/SET> and select <MULTI>.
- To set the flash frequency, press function button 3 <Hz>, turn <SEL/SET> and select <1Hz>.

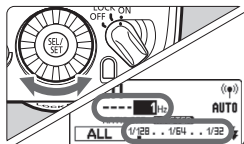

● Calculating the Shutter Speed

In stroboscopic flash, to ensure that the shutter stays open until the end of the continuous flashes, set the camera with a shutter speed calculated with the following equation.

Number of flashes ÷ flash frequency = shutter speed

For example, if the number of flashes is set to 10 (times) and flash frequency to 5 (Hz), set the shutter speed to 2 sec. or longer.



- To avoid degrading and damaging the flash head of the receiver unit due to overheating, do not shoot repeatedly with stroboscopic flash more than 10 times. After shooting 10 times, allow a rest time of at least 15 min.
- If you shoot repeatedly more than 10 times, the receiver unit's safety function may activate and restrict the flash firing. If this happens, allow a rest time of at least 15 min.



- Stroboscopic flash is most effective when combining a highly reflective subject with a dark background.
- Using a tripod and remote switch is recommended.
- Stroboscopic flash shooting is not possible with 1/1 power or 1/2 power flash.
- Stroboscopic flash shooting is also possible when the camera's shooting mode is set to "buLb".
- When the number of flashes is displayed as "---", flashes are fired continuously until the shutter closes or the charge runs out. The maximum number of continuous flashes is shown in the table on the following page.

Maximum Number of Continuous Flashes

Flash Output \ Hz	1	2	3	4	5	6 - 7	8 - 9
1/4	7	6	5	4	4	3	3
1/8	14	14	12	10	8	6	5
1/16	30	30	30	20	20	20	10
1/32	60	60	60	50	50	40	30
1/64	90	90	90	80	80	70	60
1/128	100	100	100	100	100	90	80
1/256	100	100	100	100	100	100	100
1/512	100	100	100	100	100	100	100
1/1024	100	100	100	100	100	100	100
1/2048	100	100	100	100	100	100	100
1/4096	100	100	100	100	100	100	100
1/8192	100	100	100	100	100	100	100

Flash Output \ Hz	10	11	12 - 14	15 - 19	20 - 50	60 - 199	250 - 500
1/4	2	2	2	2	2	2	2
1/8	4	4	4	4	4	4	4
1/16	8	8	8	8	8	8	8
1/32	20	20	20	18	16	12	10
1/64	50	40	40	35	30	20	15
1/128	70	70	60	50	40	40	30
1/256	100	100	100	100	80	80	60
1/512	100	100	100	100	100	100	100
1/1024	100	100	100	100	100	100	100
1/2048	100	100	100	100	100	100	100
1/4096	100	100	100	100	100	100	100
1/8192	100	100	100	100	100	100	100

- When the number of flashes is displayed as "----" (bar display), the maximum number of flashes is as shown in the tables.

1 to 199 Hz

Flash Output	1/4	1/8	1/16	1/32	1/64	1/128
Number of flashes	2	4	8	12	20	40

Flash Output	1/256	1/512	1/1024	1/2048	1/4096	1/8192
Number of flashes	80	100	100	100	100	100

250 to 500 Hz

Flash Output	1/4	1/8	1/16	1/32	1/64	1/128
Number of flashes	2	4	8	10	15	30

Flash Output	1/256	1/512	1/1024	1/2048	1/4096	1/8192
Number of flashes	60	100	100	100	100	100

Gr: Shooting with a Different Flash Mode for Each Group

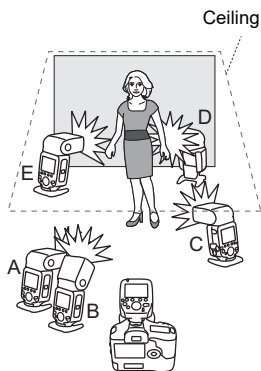

When using an EOS digital camera released since 2012, such as the EOS-1D X (except EOS REBEL T100/4000D/3000D, EOS REBEL T7/1500D/2000D, EOS REBEL T6/1300D and EOS REBEL T5/1200D), you can shoot with a different flash mode set for each firing group, with up to 5 groups (A/B/C/D/E). The flash modes that can be set are ① E-TTL II/E-TTL autoflash, ② Manual flash and ③ Auto external flash metering. When the flash mode is ① or ③, exposure is controlled to result in standard exposure for the main subject as a single group.

This function is for advanced users who are very knowledgeable and experienced in lighting.

ⓘ Wireless flash shooting using the <Gr> flash mode cannot be performed with cameras released up to 2011 or EOS REBEL T100/4000D/3000D, EOS REBEL T7/1500D/2000D, EOS REBEL T6/1300D and EOS REBEL T5/1200D. Shooting with up to 3 groups (A/B/C) is set (p.33).

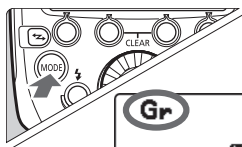

1 Set the flash mode to <Gr>.

- Press the <MODE> button on the sender unit and set the flash mode to <Gr>.

2 Set the firing group on the receiver units.

- Operate and set the receiver units one by one.
- Set a firing group (A/B/C/D/E) for all the receiver units.
- For the receiver unit settings, see the flash's instruction manual.

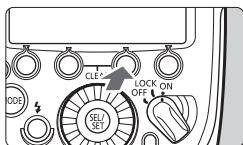

3 Set the flash mode.

- Set the flash mode of each firing group by operating the sender unit.
- While <MENU 1> is displayed, press function button 3 <Gr> and turn <SEL SET> to select the group.
- Press function button 2 <*MODE> and select the flash mode of the selected group from <ETTL>, <M> and <Ext.A>.
- To turn the firing of the selected group off, press function button 1 <ON/OFF> to set it to <OFF>.
- Repeat step 3 to set the flash mode of all groups.

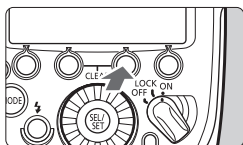
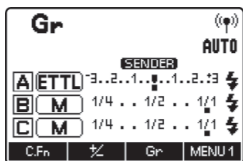

4 Set the flash output or flash exposure compensation amount.

- While a firing group is selected, press function button 3 <*1/2>.
- Turn <SEL SET> to set the flash function corresponding to the flash mode, and press <SEL SET>.
- When using the <M> mode, set the flash output. When using the <ETTL> or <Ext.A> mode, set the flash exposure compensation amount as required.
- If you press function button 2 <1/2> when <MENU 1> is displayed, flash exposure compensation can be set for all the firing groups.
- Repeat step 4 to set the flash function of all groups.

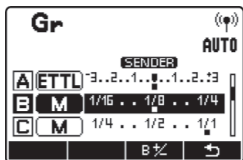

5 Take the picture.

- ▶ Each receiver unit fires in the flash mode that was set for each group.

ⓘ When the flash mode of the firing group is set to <ETTL> or <Ext.A>, exposure is controlled to obtain a standard exposure for the main subject as a single group. If you shoot with multiple firing groups pointing toward the main subject, overexposure may result.

ⓘ The firing groups to be fired do not need to be consecutive; for example, A/C/E can be set.

Clearing Transmitter Settings

You can return the settings for wireless shooting to their default settings.

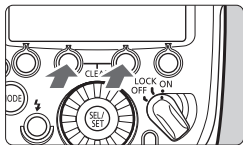

Press function buttons 2 and 3 simultaneously for 2 seconds or longer.

- ▶ The transmitter settings are cleared and the shooting mode returns to <ETTL> flash mode.

ⓘ Even when the settings are cleared, the transmission channel, the wireless radio ID and the C.Fn and P.Fn settings (p.56) are not canceled.

Test Flash from a Receiver Unit

You can fire a test flash from a flash set as a receiver unit. For the operations, see the flash's instruction manual.

ⓘ When two or more units are set to sender, the sender unit with the <LINK> lamp lit in green is the one that fires.

Modeling Flash

When the camera's depth-of-field preview button is pressed, the flash fires continuously for 1 sec. This is called the modeling flash. It enables you to see the shadow effects of the flash on the subject and the lighting balance.

Modeling Flash from a Sender Unit

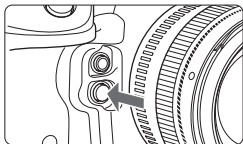

Press the depth-of-field preview button on the camera.

- ▶ The flash fires continuously for 1 sec.

Modeling Flash from a Receiver Unit

With EOS digital cameras released since 2012, you can fire the modeling flash from a flash set as a receiver unit (except with EOS REBEL T100/4000D/3000D, EOS REBEL T7/1500D/2000D, EOS REBEL T6/1300D and EOS REBEL T5/1200D). For the operations, see the flash's instruction manual.

- With cameras released up to 2011 or EOS REBEL T100/4000D/3000D, EOS REBEL T7/1500D/2000D, EOS REBEL T6/1300D and EOS REBEL T5/1200D, the modeling flash cannot be fired from receiver units.
- To avoid degrading and damaging the flash head due to overheating, do not fire the modeling flash more than 10 times continuously. After firing the modeling flash 10 times continuously, allow a rest time of at least 10 min.
- If the modeling flash is fired more than 10 times continuously, the flash's safety function may activate and restrict the flash firing. If this happens, allow a rest time of at least 15 min.
- Modeling flash is not possible when using the transmitter with EOS REBEL 2000/QD or EOS 300/QD.



- When two or more units are set to sender, the sender unit with the <LINK> lamp lit in green is the one that fires.
- You can fire the modeling flash with the test flash button (C.Fn-02/p.58).

Remote Release from a Receiver Unit

You can perform remote release (remote control shooting) from a flash set as a receiver unit. For the operations, see the flash's instruction manual.

When shooting with this function, the "Release Cable SR-N3" (sold separately) may be needed, depending on your camera.

Cameras Compatible with Receiver Unit Remote Release

For EOS digital cameras released since 2012, such as the EOS-1D X, the "Release Cable SR-N3" is not needed.

Cameras Not Compatible with Receiver Unit Remote Release

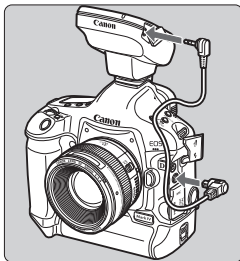

For EOS cameras other than the above that are compatible with E-TTL II/E-TTL autoflash and have an N3 type remote control terminal, the "Release Cable SR-N3" (sold separately) is needed to perform remote release from a receiver unit. As shown in the illustration, use the cable to connect the camera and the transmitter.



- Connect the release cable when the power of the camera and the transmitter is turned off.
- Shooting is not possible when focus cannot be achieved with autofocus. Focusing manually before performing remote release is recommended.
- The "Release Cable SR-N3" (sold separately) is for an N3 type remote control terminal. It cannot be used with cameras equipped with a remote control terminal other than the N3 type.



- Remote release is performed with "Single shooting" regardless of the camera's drive mode setting.
- When there are two or more sender units, remote release is performed using the sender unit with the <LINK> lamp lit in green.

Linked Shooting

Linked shooting is a function that automatically releases the shutter of a receiver unit camera by linking it to a sender unit camera. You can shoot with linked shooting for up to 16 units, including both sender units and receiver units. This is convenient when you want to shoot a subject from multiple angles at the same time.

To shoot with linked shooting, attach a flash that supports radio transmission wireless shooting or the Speedlite Transmitter ST-E3-RT (Ver.2) to the camera.

Note that when using a camera with an N3 type remote control terminal that was released up to 2011 as the “receiver unit camera,” the “Release Cable SR-N3” (sold separately) is needed. For details on attaching the cable, see page 44.

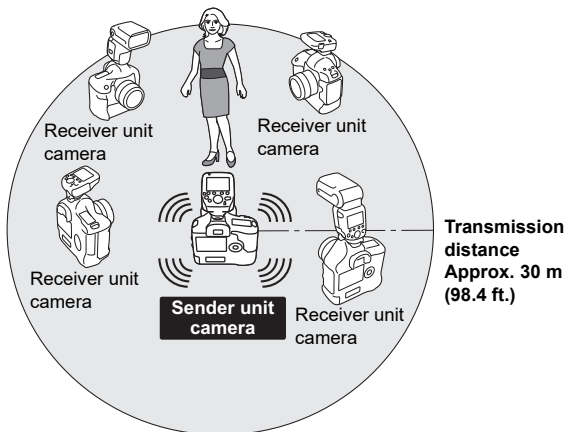

Before performing the operations on the next page, attach a transmitter or Speedlite on all the cameras to be used for linked shooting. For details on the Speedlite settings, see the Speedlite's instruction manual.

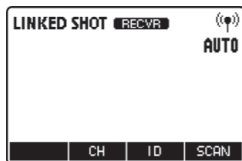

1 Set to linked shooting mode.

- Press the <Z> button continuously until <LINKED SHOT> is displayed on the LCD panel.
- ▶ Linked shooting mode's "Receiver unit" is set.
- Press the <Z> button again to set "Sender unit" of the linked shooting mode.

2 Set the channel and ID.

- Set the channel by pressing function button 2 <CH>, and set the ID by pressing function button 3 <ID>.
- For details on the setting procedure, see pages 20 to 22.

3 Set the camera's shooting functions.

4 Set all the transmitters.

- Repeat steps 1 to 3 and set all the transmitters to "Sender unit" or "Receiver unit" in the linked shooting mode.
- Set the Speedlites used in linked shooting in the same way.
- When pressing the <Z> button to change the setting of a unit from "Receiver unit" to "Sender unit," the other transmitters (or Speedlites) that were set to "Sender unit" until then automatically switch to "Receiver unit".

5 Set up the receiver unit cameras.

- Check that the <LINK> lamp of the receiver unit is lit in green.
- Set up all the receiver unit cameras within approximately 30 m/98.4 ft. of the sender unit camera.

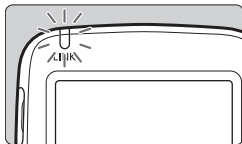

6 Take the picture.

- Check that the <LINK> lamp of the sender unit is lit in green and take the picture.
 - ▶ The receiver unit cameras are released in coordination with the sender unit camera.
 - ▶ After shooting with linked shooting, the <LINK> lamp of the receiver unit is briefly lit in orange.



- Shooting with manual focus is recommended for the receiver unit cameras. If focus cannot be achieved with autofocus, linked shooting is not possible with the corresponding receiver unit camera.
- There is a short time lag between the release of the receiver unit camera and the release timing of the sender unit camera. Perfectly simultaneous shooting is not possible.
- If you fire multiple flash units at the same time during linked shooting, the appropriate exposure may not be obtained or uneven exposure may result.
- When **[Flash firing]** in **[Flash function settings]** is set to **[Disabled]** (p.52), linked shooting cannot be performed.
- When performing linked shooting in the Live View state, set **[Silent LV shoot.]** on the sender camera menu to **[Disabled]**. If **[Mode1]** or **[Mode2]** is set, the receiver unit cameras will not be released.
- The transmission distance may be shorter depending on the conditions such as the positioning of receiver units, the surrounding environment and weather conditions.
- The linked shooting function is the same function as the linked shooting featured by the WFT series of wireless file transmitters. However, linked shooting cannot be performed in combination with the WFT series. Moreover, the release time lag differs from linked shooting performed using the WFT series.



- You can use this function as a sender unit remote control for linked shooting without attaching a Speedlite or transmitter to a camera. When function button 1 < **REL** > on the sender unit is pressed, all the receiver unit cameras are released.
- During linked shooting, the time until auto power off takes effect is 5 min.

3

Setting Transmitter Functions with Camera Operations

This chapter describes how to set the transmitter functions from the camera's menu screen.

 When the camera's shooting mode is set to a fully automatic mode or an Image Zone mode, the operations in this chapter are not available. Set the camera's shooting mode to P/Tv/Av/M/ B (Creative Zone mode).

Transmitter Control from Camera's Menu Screen

When using EOS digital cameras released since 2007, you can set flash functions, transmitter functions or Custom Functions from the camera's menu screen.

For the camera operations, see the camera's instruction manual.

Transmitter Function Setting

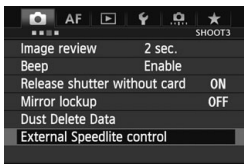

1 Select [External Speedlite control].

- Select [External Speedlite control] or [Flash control].

2 Select [Flash function settings].

- Select [Flash function settings] or [External flash func. setting].
 - ▶ The screen changes to the (external) flash function settings screen.

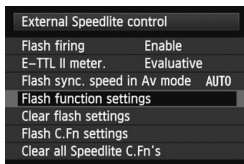

3 Set the function.

- The setting screen varies depending on the camera.
- Select an item and set the function.

Example of EOS-1D X screen

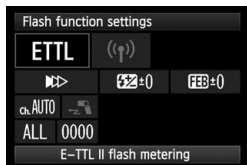

Example of EOS 60D screen

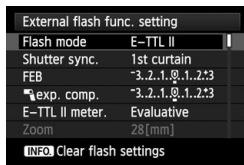

The cameras released from 2007 to 2011 are as follows.
EOS-1Ds Mark III, EOS-1D Mark IV/III, EOS 5D Mark II, EOS 7D/60D/50D/40D, EOS REBEL T3i/600D, EOS REBEL T2i/550D, EOS REBEL T1i/500D, EOS REBEL XSi/450D, EOS REBEL T3/1100D, EOS REBEL XS/1000D

Settings Available in [Flash function settings]

● EOS digital cameras released since 2012

When using the transmitter with cameras such as EOS-1D X, you can set the functions for “Radio transmission wireless shooting” in the [Flash function settings] screen.

* Although EOS REBEL T100/4000D/3000D, EOS REBEL T7/1500D/2000D, EOS REBEL T6/1300D and EOS REBEL T5/1200D was released since 2012, the settable functions with [External flash func. setting] are the same as with EOS digital cameras released from 2007 to 2011. (See the following explanation for details.)

● EOS digital cameras released from 2007 to 2011

When performing “Radio transmission wireless shooting”, set the functions by operating the transmitter.

The settable functions are as follows. The available settings vary depending on the flash mode or wireless function setting.

Function		Reference Page
Flash firing	Enable / Disable	p.52
E-TTL II flash metering	Evaluative / Average	
Flash synchronization speed in Av mode		
Flash mode	E-TTL II (autoflash) / Manual flash / MULTI flash / Individual group control	
Shutter synchronization	1st curtain / High-speed	
Flash exposure compensation		
FEB		
Wireless functions (setting)	Radio transmission wireless	p.53
Clear Speedlite function settings		



- [Flash firing] and [E-TTL II flash metering] are displayed in step 2 or step 3 on the preceding page (depending on the camera).
- When [Flash sync. speed in Av mode] is not displayed, it can be set with the camera's Custom Function.

- **Flash firing**

To perform wireless flash shooting, set to **[Enable]**. When **[Disable]** is set, wireless flash shooting is not available.

- **E-TTL II flash metering**

For normal exposures, set it to **[Evaluative]**. If **[Average]** is set, the flash exposure will be averaged for the entire scene metered by the camera. Flash exposure compensation may be necessary depending on the scene. This setting is for advanced users.

- **Flash synchronization speed in Av mode**

You can set the flash sync speed when performing wireless flash shooting in aperture-priority AE (**Av**) mode.

- **Flash mode**

You can select the flash mode from **[E-TTL II]**, **[Manual flash]**, **[MULTI flash]** and **[Individual group control]** to suit your desired flash shooting.

- **Shutter synchronization**

You can select the flash firing timing/method from **[1st curtain]** and **[High-speed synchronization]**. To perform normal wireless flash shooting, set it to **[1st curtain]**.

- **Flash exposure compensation**

In the same way as normal exposure compensation, you can set exposure compensation for flash. The flash exposure compensation amount can be set up to ± 3 stops in 1/3-stop increments.

- **FEB**

You can take three shots while automatically changing the flash output. The settable range is up to ± 3 stops in 1/3-stop increments.

- **Wireless flash functions (setting)**

Radio transmission wireless flash shooting is set automatically. For details, see Chapter 2.

- **Clear Speedlite (function) settings**

You can return the transmitter settings to their default settings.



- When **[Flash mode]** is set to **[Individual group control]**, you can select **[E-TTL II]**, **[Manual flash]**, **[Auto external flash metering]** or **[Disable]** as the flash mode for each group.
- When flash exposure compensation is set on the transmitter, you cannot set flash exposure compensation in the camera's menu screen. Note that if both are set at the same time, the setting on the transmitter is given priority.

Transmitter Custom Function Settings

The displayed contents vary depending on the camera. If C.Fn-20 and 22 are not displayed, set them by operating the transmitter. For the Custom Functions, see pages 58 to 59.

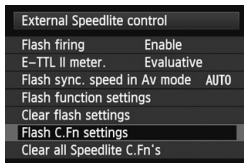

1 Select [Flash C.Fn settings].

- Select [Flash C.Fn settings] or [External flash C.Fn setting].
- ▶ You can now set the Custom Functions of the transmitter.

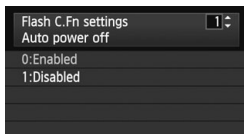

2 Set the Custom Function.

- Select the Custom Function number and set the function.
- To clear all the Custom Function settings, select [Clear all Speedlite C.Fn's] or [Clear ext. flash C.Fn set.] in step 1.

When using a camera released up to 2011 or EOS REBEL T100/4000D/3000D, EOS REBEL T7/1500D/2000D, EOS REBEL T6/1300D and EOS REBEL T5/1200D, the C.Fn-20 and 22 settings are not cleared even if [Clear all Speedlite C.Fn's] is selected. When following the "Clearing All the Custom Functions" operation on page 57, all the Custom Functions are cleared.

You cannot set or clear all Personal Functions (P.Fn/p.60) from the camera's menu screen. Set them by operating the transmitter.

4

Customizing the Transmitter

This chapter describes how to customize the transmitter with the Custom Functions (C.Fn) and Personal Functions (P.Fn).



When the camera's shooting mode is set to a fully automatic mode or an Image Zone mode, the operations in this chapter are not available. Set the camera's shooting mode to **P/Tv/Av/M/ B** (Creative Zone mode).

C.Fn/P.Fn: Setting Custom and Personal Functions

You can customize the transmitter features to suit your shooting preferences with Custom Functions and Personal Functions. Note that the Personal Functions are customizable functions unique to the transmitter.

C.Fn: Custom Functions

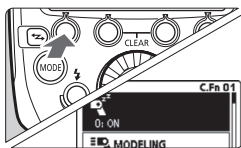

1 Display the Custom Functions screen.



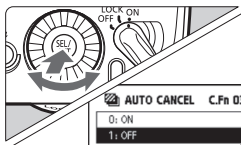

- Press function button 1 < **C.Fn** > continuously until the screen is displayed.
- ▶ The Custom Functions screen is displayed.

2 Select an item to set.

- Turn <  > to select an item (number) to set.



3 Change the setting.

- Press the <  > button.
- ▶ The setting is displayed.
- Turn <  > to select the setting that you want, and press the <  > button.
- Press function button 4 <  > to return to the shooting-ready state.

P.Fn: Personal Functions

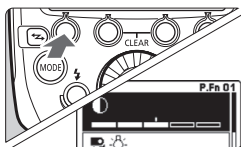











1 Display the Personal Functions screen.

- After performing step 1 in the Custom Functions procedure, press function button 1 < **P.Fn** >.
- ▶ The Personal Functions screen is displayed.

2 Set the function.

- Set the Personal Function in the same way as steps 2 and 3 for the Custom Function.

Custom/Personal Function List

Number		Function	Page
Custom Functions			
C.Fn-01		Auto power off	p.58
C.Fn-02	 MODELING	Modeling flash	
C.Fn-03	 AUTO CANCEL	FEB auto cancel	
C.Fn-04		FEB sequence	
C.Fn-07	 TEST	Test firing with autoflash	p.59
C.Fn-13		Flash exposure metering setting	
C.Fn-20		Beep	
C.Fn-22		LCD panel illumination	
Personal Functions			
P.Fn-01		LCD panel display contrast	p.60
P.Fn-03		LCD panel illumination color: Sender	
P.Fn-04		LCD panel illumination color: Receiver	
P.Fn-08	FEM	FE memory	

Clearing All the Custom/Personal Functions

When function button 2 < CLEAR > and then function button 1 < OK > are pressed on the Custom Function screen, the Custom Functions which have been set are cleared. Similarly, when the same operations are performed on the personal function screen, the personal functions which have been set are cleared.

 When you set the transmitter Custom Function from the camera's menu screen and C.Fn-20 and 22 are not displayed, set them with the operation on page 56.

 You can set and clear all transmitter Custom Functions from the camera's menu screen (p.54).

C.Fn: Setting Custom Functions

C.Fn-01: (Auto power off)

When the transmitter is not operated for 5 min., the power turns off automatically to save energy. You can disable this function.

0: ON (Enabled)

1: OFF (Disabled)

C.Fn-02: MODELING (Modeling flash)

0:  (Enabled (Depth-of-field preview button))

Press the camera's depth-of-field preview button to fire the modeling flash.

1:  (Enabled (Test firing button))

Press the transmitter's test flash button to fire the modeling flash.

2:  (Enabled (with both buttons))

Press the camera's depth-of-field preview button or the transmitter's test flash button to fire the modeling flash.

3: OFF (Disabled)

Disables the modeling flash.

C.Fn-03: AUTO CANCEL (FEB auto cancel)

You can set whether or not to cancel FEB automatically after shooting three shots with FEB.

0: ON (Enabled)

1: OFF (Disabled)

C.Fn-04: (FEB sequence)

You can change the order of the FEB sequence, 0: Standard exposure, -: Decreased exposure (darker) and +: Increased exposure (brighter).

0: 0 → - → +

1: - → 0 → +

C.Fn-07:  TEST (Test firing with autoflash)

You can change the flash output when firing the test flash in E-TTL II/E-TTL autoflash mode.



0: 1/32 (1/32)

1: 1/1 (Full output)

C.Fn-13:  (Flash exposure metering setting)

0:  (Speedlite button and dial)

1:  (Speedlite dial only)

You can perform flash exposure compensation by directly turning <  >, without pressing the <  > button.

C.Fn-20:  (Beep)

You can enable a beep to sound when the receiver units are fully charged.

0: OFF (Disabled)

1: ON (Enabled)

C.Fn-22:  (LCD panel illumination)

When a button or dial is operated, the LCD panel illuminates. You can change this illumination setting.

0: 12sec (On for 12 sec.)

1: OFF (Disable panel illumination)

2: ON (Illumination always on)

P.Fn: Setting Personal Functions

P.Fn-01: (LCD panel display contrast)

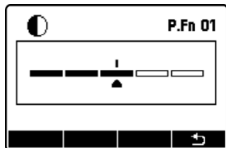

You can adjust the contrast of the LCD panel in 5 levels.

P.Fn-03: (LCD panel illumination color: Sender)

Radio transmission wireless flash shooting, linked shooting: You can select the color of the LCD panel illumination when the transmitter is set as the sender unit.

0: GREEN (Green)

1: ORANGE (Orange)

P.Fn-04: (LCD panel illumination color: Receiver)

Linked shooting: You can select the color of the LCD panel illumination to be used when the transmitter is set as the receiver unit.

0: ORANGE (Orange)

1: GREEN (Green)

P.Fn-08: **FEM** (FE memory)

You can set the firing output adjusted in firing mode **<ETTL>** as the firing output of the firing mode **<M>**.

0: OFF

1: ON

5

Reference

This chapter contains a system map and frequently asked questions.

ST-E3-RT (Ver.2) System

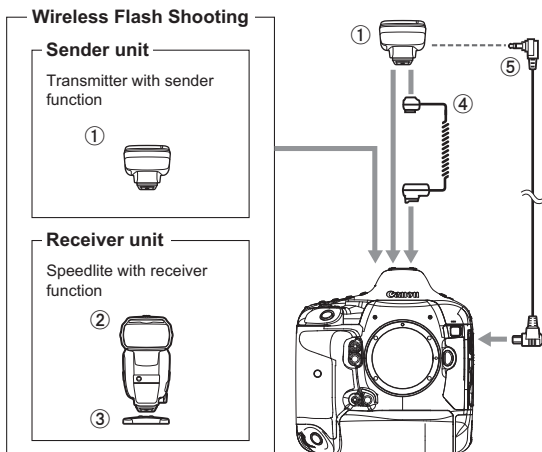

① Speedlite Transmitter ST-E3-RT (Ver.2)

② Speedlite EL-1, 600EXII-RT, 600EX-RT, 430EX III-RT

Speedlite with a receiver function compatible with radio transmission wireless shooting.

③ Mini stand

④ Off-Camera Shoe Cord OC-E3

Enables the ST-E3-RT (Ver.2) to be connected to the camera up to 60 cm / 2 ft. away.

⑤ Release Cable SR-N3

If the transmitter is connected using this cable to an EOS camera which is compatible with E-TTL II/E-TTL autoflash, has an N3 type remote control terminal and was released up to 2011, you can release the shutter from the receiver unit (p.44) or perform linked shooting (p.45).

Troubleshooting Guide

If a problem occurs with the transmitter, first refer to this Troubleshooting Guide. If this Troubleshooting Guide does not resolve the problem, contact your dealer or nearest Canon Service Center.

Power does not turn on.

- Make sure that the batteries are installed in the correct orientation (p.12).
- Insert the mounting foot into the camera's hot shoe all the way, slide the lock lever to the right, and secure the transmitter to the camera (p.13).
- If the electrical contacts of the transmitter and camera are dirty, clean the contacts (p.7).
- The charge lamp lights when the wireless shooting (receiver) is ready.

The power turns off by itself.

- The transmitter's auto power off function has activated. Press the shutter button halfway, or press the test flash button (p.14).

The receiver unit does not fire.

- Check that the receiver unit supports radio transmission wireless flash shooting.
- Set the receiver unit to <((P))> <RECVR> (p.20).
- Set the transmission channels and wireless radio IDs of the sender unit and receiver unit to the same numbers (p.20).
- Check that the receiver unit is within the transmission range of the sender unit (p.16).

The receiver flash does not fire or unexpectedly fires at full output.

- Run the channel scan and set the channel with the best radio reception signal (p.22).
- Position the receiver unit in clear view of the sender unit, without obstacles between them.
- Face the receiver unit's front toward the sender unit.

The picture is underexposed or overexposed.

- If there was a highly reflective object (glass window, etc.) in the picture, use FE lock (p.31).
- If the subject looks very dark or very bright, set flash exposure compensation (p.27).
- When high-speed sync is set, the effective flash range is shorter. Position the receiver unit closer to the subject (p.29).
- When using autoflash shooting with three firing groups A, B and C, do not fire with firing group C pointed toward the main subject (p.34).
- When shooting with a different flash mode setting for each firing group, do not fire with multiple firing groups set to **<ETTL>** or **<Ext.A>** pointed toward the main subject (p.42).

The picture is very blurred.

- When the shooting mode is set to **<Av>** and the scene is dark, slow sync is enabled automatically (the shutter speed becomes slower). Use a tripod, or set the shooting mode to **<P>** or fully automatic mode. Note that you can also set the sync speed in [**Flash sync. speed in Av mode**] (p.51).

<Tv> is displayed.

- Set the shutter speed 1 stop slower than the flash sync speed (p.19).

Cannot release from a receiver unit.

- When an EOS camera which was released up to 2011, has an N3 type remote control terminal and is compatible with E-TTL II/E-TTL autoflash is used to perform remote release from a receiver unit or when it has been set as the receiver unit during linked shooting, the "Release Cable SR-N3" (sold separately) is necessary (p.44, 45, 62).

Specifications

● Type

Type: On-camera Speedlite transmitter
Compatible cameras: EOS series supporting E-TTL II / E-TTL autoflash

● Radio Transmission Wireless Function

Exposure control system: E-TTL II/E-TTL autoflash, manual flash, stroboscopic flash, auto external flash metering*
* Only when the flash mode is set to <Gr>

Frequency: 2405 - 2475 MHz

Modulation system: Primary modulation: OQPSK, secondary modulation: DS-SS

Channel: Auto, Ch. 1 - 15

Wireless radio ID: 0000 - 9999

Receiver unit control: Up to 5 groups (A/B/C/D/E), up to 15 units

Transmission distance: Approx. 30 m / 98.4 ft.
* When there are no obstacles or obstructions between the sender unit and receiver unit, and no radio interference with other devices
* The transmission distance may be shorter depending on the relative positions of the units, surrounding environment and weather conditions.

Flash ratio control: 1:8 - 1:1 - 8:1, 1/2-stop increments

Flash exposure compensation: ±3 stops in 1/3- or 1/2-stop increments

FEB: ±3 stops in 1/3- or 1/2-stop increments (when used with flash exposure compensation)

FE lock: Press the camera's <M-Fn>, <FEL> or <★> button

High-speed sync: Provided
* High-speed sync is possible only with EOS digital cameras released since 2012 (except with EOS REBEL T100/4000D/3000D, EOS REBEL T7/1500D/2000D, EOS REBEL T6/1300D and EOS REBEL T5/1200D).

Manual flash: 1/1 - 1/8192 power (1/3-stop increments)
* 1/1 - 1/8192 power is only supported when using flashes (EL-1) that support microlight power. However, minimal flash output is set at 1/128 when using high-speed sync.

Stroboscopic flash: Provided (1 - 500 Hz)

Receiver flash battery check: On the sender unit's LCD panel, the <⚡> icon lights, the receiver unit's AF-assist beam emitter blinks and the charge lamp lights.

Flash exposure confirmation:	Flash exposure confirmation lamp lights
Modeling flash:	Fired with camera's depth-of-field preview button
Linked shooting:	Provided

● Customizable Functions

Custom Functions:	8
Personal Functions:	4

● Power Source

Power source:	2 AA/LR6 alkaline batteries * AA/LR6 Ni-MH and lithium batteries also usable
Wireless flash shooting time:	Approx. 10 continuous hours * When using AA/LR6 alkaline batteries
Power saving:	Power off after 5 min. of idle operation

● Dimensions and Weight

Dimensions:	Approx. 67.4 (W) x 61.5 (H) x 77.4 (D) mm / 2.7 x 2.4 x 3.0 in. (excluding the dust- and water-resistant adapter)
Weight:	Approx. 110 g / 3.9 oz. (transmitter only, excluding batteries)
Working temperature range:	0 - 45°C / 32 - 113°F
Working humidity:	85 % or less

- All specifications above are based on Canon's testing standards.
- Product specifications and external appearance are subject to change without notice.

Safety Instructions

Be sure to read these instructions in order to operate the product safely. Follow these instructions to prevent injury or harm to the operator of the product or others.



Warnings: Denotes the risk of serious injury or death.

- Use only power sources specified in this instruction manual for use with the product.
- Do not disassemble or modify the product.
- Do not expose the product to strong shocks or vibration.
- Do not touch any exposed internal parts.
- Stop using the product in any case of unusual circumstances such as the presence of smoke or a strange smell.
- Do not use organic solvents such as alcohol, benzene or paint thinner to clean the product.
- Do not get the product wet. Do not insert foreign objects or liquids into the product.
- Do not use the product where flammable gases may be present.

This may cause electric shock, explosion or fire.

- Observe the following instructions when using commercially available batteries or provided battery packs.
 - Use batteries/battery packs only with their specified product.
 - Do not heat batteries or expose them to fire.
 - Do not charge batteries/battery packs using non-authorized battery chargers.
 - Do not expose the terminals to dirt or let them come into contact with metallic pins or other metal objects.
 - Do not use leaking batteries/battery packs.
 - When disposing of batteries/battery packs, insulate the terminals with tape or other means.

This may cause electric shock, explosion or fire.

If a battery/battery pack leaks and the material contacts your skin or clothing, flush the exposed area thoroughly with running water. In case of eye contact, flush thoroughly with copious amounts of clean running water and seek immediate medical assistance.

- Do not allow the product to maintain contact with the same area of skin for extended periods of time during use.

This may result in low-temperature contact burns, including skin redness and blistering, even if the product does not feel hot. The use of a tripod or similar equipment is recommended when using the product in hot places and for people with circulation problems or less sensitive skin.

- Follow any indications to turn off the product in places where its use is forbidden. Not doing so may cause other equipment to malfunction due to the effect of electromagnetic waves and even result in accidents.



Cautions: Follow the cautions below. Otherwise physical injury or property damage may result.

- Do not fire the flash near the eyes.

It may hurt the eyes.

- Flash emits high temperatures when fired. Keep fingers, any other part of your body, and objects away from the flash unit while taking pictures.

This may cause burns or malfunction of the flash.

- Do not leave the product in places exposed to extremely high or low temperatures.

The product may become extremely hot/cold and cause burns or injury when touched.

- Do not touch any parts inside the product.

This may cause injury.

Index

4 sec., 6 sec., 16 sec. timer10

A

Auto external flash metering41

Auto power off.....14, 58

B

Batteries.....12

Beep59

C

C.Fn56, 58

Charge lamp6, 14, 25, 63

Clear All57

Clearing Speedlite settings42, 51

Custom functions (C.Fn).....56, 58

E

E-TTL II (flash metering)52

E-TTL II/E-TTL autoflash16

Ext.A (Auto external flash metering)

.....41

F

FE lock.....31

FEB.....28

FE memory function.....36

Firing group.....32, 33, 35, 36, 37, 40

Flash control50

Flash exposure compensation.....27

Flash exposure confirmation lamp

.....6

Flash exposure level.....8, 28

Flash frequency37

Flash function settings51

Flash mode8, 9, 51, 52

Flash operation range.....16

Flash output35

Flash positions16

Flash ratio

Three groups (A:B C).....33

Two groups (A:B)32

Flash sync. speed52

Flash sync. speed in Av mode52

Fully automatic wireless flash

shooting.....24

H

High-speed sync29

Hot shoe.....13

I

ISO speed31

L

LCD panel8

Density60

Illumination14, 59

Illumination color60

LINK6, 23, 25

Linked shooting9, 45

LOCK14

Lock function14

M

M (manual exposure)35

Manual flash.....35

Maximum number of continuous

flashes39

Memory function.....23

Modeling flash43

MULTI37

P

P.Fn.....56, 60

Personal functions (P.Fn).....56, 60

R

Receiver group control34

Receiver unit setting.....20

Remote release44

S

Scan	22
Second-Curtain Sync	30
Sender unit setting	20
Setting functions	49
Shutter speed.....	19
Shutter sync.	52
Stroboscopic flash.....	37

T

Test flash	13, 25, 42
Transmission channel	20, 21, 22

W

Wireless flash shooting	16
Fully automatic one receiver unit	24
Fully automatic three groups (A:B C)	33
Fully automatic two groups (A:B).....	32
Group firing	40
Manual flash.....	35
Wireless flash shooting time	12
Wireless multiple flash shooting	17, 32, 35
Wireless radio ID.....	20, 21
Wireless settings.....	20

Canon