



imageCLASS X

C1538P

User's Guide

Contents

Setting Up	2
Preparations Required Before Use	3
Preventing Unauthorized Access	4
Setting up Using the Setup Guide	6
Setting the Date/Time	7
Setting up the Network Environment	8
Selecting the Network Connection Method	10
Connecting to a Wired LAN	12
Connecting to a Wireless LAN	14
Setting Up the Connection Using WPS Push Button Mode	16
Setting Up the Connection Using WPS PIN Code Mode	17
Setting Up Connection by Selecting a Wireless Router	18
Setting Up a Connection by Specifying Detailed Settings	19
Checking the SSID and Network Key	21
Setting an IP Address	22
Setting an IPv4 Address	23
Setting an IPv6 Address	25
Setting the IPv4 Address of the Sub Line	27
Adapting to the Network Environment	28
Making Ethernet Settings	29
Setting the Wait Time When Connecting to a Network	30
Making DNS Settings	31
Monitoring and Controlling the Machine with SNMP	34
Setting Static Routing	38
Other Network Settings	40
Configuring System Data Communication	43
Installing Drivers	44
Configuring E-Mail Print Settings	45
Basic Operations	49
Parts and Their Functions	51
Front Side	52
Back Side	55
Interior	56
Multi-Purpose Tray	57
Paper Drawer	58
Control Panel	59
Turning ON the Machine	61
Turning OFF the Machine	62
Loading Paper	63
Basic Paper Loading Method	64
Loading Envelopes	72

Loading Postcards	76
Loading Preprinted Paper	78
Using the Control Panel	80
Basic Screens	81
Items Displayed on the <Home> Screen	83
Basic Operation	85
Entering Characters	88
Logging into the Machine	90
Specifying Paper Size and Type	91
Specifying Paper Size and Type in the Paper Drawer	92
Specifying Paper Size and Type in the Multi-purpose Tray	94
Registering Frequently Used Paper Size and Type for the Multi-purpose Tray	96
Registering Free Size Paper (Custom Size Paper)	98
Automatically Selecting the Appropriate Paper Source for a Specific Function	99
Customizing the Display	100
Customizing the <Home> Screen	101
Switching the Displayed Language	102
Setting Sounds	103
Entering Sleep Mode	104
Printing	107
Printing From a Computer	109
Canceling Printing	112
Checking the Printing Status and History	114
Advanced Functions for Printing	115
Printing Documents Held in the Machine	116
Printing Out Secured Documents	119
Various Printing Methods	121
Directly Printing Files without Opening Them	122
Printing Using a Virtual Printer	124
Printing From Memory Media (Media Print)	126
Printing Received E-mail (E-Mail Print)	127
Printing Using the Microsoft Cloud Service (Universal Print)	128
Configuring the Universal Print User Settings	132
Using Memory Media Such as USB Memory	135
Using Memory Media	136
Linking with Mobile Devices	142
Connecting with Mobile Devices	143
Connecting Directly	144
Utilizing the Machine through Applications	147
Using AirPrint	149
Printing with AirPrint	153

If AirPrint Cannot Be Used	156
Printing with Default Print Service (Android)	157
Managing the Machine	160
Applying a Security Policy to the Machine	162
Using a Password to Protect the Security Policy Settings	163
Configuring the Security Policy Settings	165
Security Policy Setting Items	167
Managing Users	172
Configuring the Personal Authentication Management Settings	174
Registering User Information in the Local Device	177
Importing/Exporting User Data	181
Adding and Editing User Information in a CSV File	184
Registering Server Information	188
Configuring the Authentication Functions	194
Using Personal Authentication to Manage Printing via a Computer	198
Using Other Convenient Personal Authentication Management Functions	199
Setting the Department ID Management	200
Changing the System Manager ID and PIN	201
Configuring the Department ID Management Settings	203
Using Department IDs to Manage Printing via Computer	206
Setting an Authentication/Password Policy	207
Configuring the Network Security Settings	210
Restricting Communication by Using Firewalls	212
Specifying IP Addresses in Firewall Settings	213
Specifying MAC Addresses in Firewall Settings	216
Configuring the Firewall of the Sub Line	218
Setting a Proxy	221
Configuring the Key and Certificate for TLS	223
Generating the Key and Certificate for Network Communication	227
Generating a Key and Certificate Signing Request (CSR)	229
Registering a Key and Certificate for Network Communication	232
Configuring the Expiration Check Method for Received Certificates	235
Retrieving/Updating a Certificate from an SCEP Server	238
Configuring the IPSec Settings	244
Configuring the IEEE 802.1X Authentication Settings	251
Restricting the Machine's Functions	254
Restricting Printing from a Computer	255
Restricting the Use of Memory Media	259
Restricting Use of the Operation Panel	260
Managing the Machine from a Computer (Remote UI)	261
Starting the Remote UI	262
Checking the Status and Logs	266
Turning OFF/Restarting the Machine	269
Managing the Logs	270
Importing/Exporting the Setting Data	273

Importing/Exporting All Settings	275
Updating the Firmware	279
Updating the Firmware (Distribution)	281
Setting Scheduled Updates	284
Displaying Messages from the Administrator	286
Installing System Options	287
Initializing Settings	289
Functions Linked to Cloud Service	291

Settings/Registration 295

Settings/Registration Table	296
Preferences	298
Display Settings	299
Timer/Energy Settings	300
Network	302
External Interface	321
Accessibility	322
Volume Settings	323
Adjustment/Maintenance	324
Maintenance	325
Adjust Image Quality	326
Function Settings	328
Common	329
Printer	331
Custom Settings	332
UFR II	335
PCL	336
PS	338
Imaging	339
PDF	340
XPS	342
Utility	343
Send	344
Receive	345
Access Files	346
Print	347
Management Settings	348
User Management	349
Device Management	350
License/Other	351
Data Management	352
Security Settings	353
Output Report	354
<Preferences>	355
<Display Settings>	356
<Timer/Energy Settings>	358
<Network>	362

<External Interface>	374
<Accessibility>	376
<Volume Settings>	377
<Adjustment/Maintenance>	378
<Maintenance>	379
<Adjust Image Quality>	380
<Function Settings>	384
<Common>	385
<Printer>	388
<Send>	390
<Receive>	391
<Access Files>	392
<Print>	393
<Management Settings>	394
<User Management>	395
<Device Management>	396
<License/Other>	398
<Data Management>	400
<Security Settings>	402
<Output Report>	403

Maintenance 407

Regular Cleaning	409
Cleaning the Exterior	410
Replacing the Toner Cartridge	411
Replacing the Waste Toner Container	415
Replacement Parts	418
Checking the Remaining Amount of Consumables	421
Adjusting Print Quality	422
Adjusting Gradation	423
Automatically Adjusting Color Registration and Color Intensity	424
Adjusting the Print Position	425
Reducing Toner Used When Color Printing	428
Paper Type Management Settings	429
Checking the Number of Pages for Print	435
Printing Reports and Lists	436

Troubleshooting 438

If the Machine Does Not Operate	439
Cannot Print	441
Problems with Printing Results	442
Problems with the Network	445
Problems with Security	449
Other Problems	450

A Message or a Number Starting with "#" (an Error Code) Is Displayed	451
A Message Saying to Contact Your Dealer or Service Representative Is Displayed	452
Countermeasures for Each Message	453
Countermeasures for Each Error Code	477
Clearing Paper Jams	485
Paper Jams inside the Machine or in the Fixing Unit	487
Paper Jams in a Paper Source	491
Implementing Security Measures	497
Various Security Functions	498
Appendix	502
Third Party Software	504
Notice	505
Feature Highlights	507
Productivity	508
Image Quality	509
Manageability	510
Building a Dual Network Environment	511
Office Compatibility	514
Basic Windows Operations	515
System Specifications	519
Printer Functions	520
Management Functions	523
System Environment	527
Network Environment	528
System Options	530
Hardware Specifications	531
Main Unit	532
Available Paper	534
Paper Feeder PF-D	541
Cassette Feeding Unit-AV	542
Options	543
Optional Equipment	544
Paper Feeder PF-D	545
Cassette Feeding Unit-AV	546
Manuals and Their Contents	547
Using User's Guide	548
Screen Layout of User's Guide	549
Viewing User's Guide	552

Setting Up

Setting Up	2
Preparations Required Before Use	3
Preventing Unauthorized Access	4
Setting up Using the Setup Guide	6
Setting the Date/Time	7
Setting up the Network Environment	8
Selecting the Network Connection Method	10
Connecting to a Wired LAN	12
Connecting to a Wireless LAN	14
Setting Up the Connection Using WPS Push Button Mode	16
Setting Up the Connection Using WPS PIN Code Mode	17
Setting Up Connection by Selecting a Wireless Router	18
Setting Up a Connection by Specifying Detailed Settings	19
Checking the SSID and Network Key	21
Setting an IP Address	22
Setting an IPv4 Address	23
Setting an IPv6 Address	25
Setting the IPv4 Address of the Sub Line	27
Adapting to the Network Environment	28
Making Ethernet Settings	29
Setting the Wait Time When Connecting to a Network	30
Making DNS Settings	31
Monitoring and Controlling the Machine with SNMP	34
Setting Static Routing	38
Other Network Settings	40
Configuring System Data Communication	43
Installing Drivers	44
Configuring E-Mail Print Settings	45

Setting Up

7L2J-000

Setting up the usage environment is required before using each function of the machine. First, confirm the processes to complete "setting up" prior to actual setup. ▶ **Preparations Required Before Use(P. 3)**

■ Administrators and General Users

To manage the machine, it is recommended to construct a system in which someone is appointed as an administrator and general users operate the machine under the management of an administrator. Administrators decide the rules for using the machine and operate important setups such as networks and security.

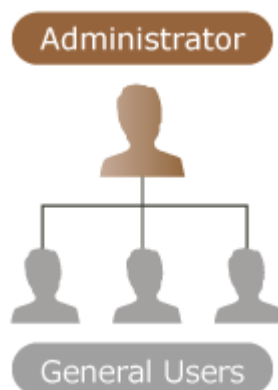

TIPS

Carrying out the initial setup of the machine (Setup Guide)

- You can easily set up to start using the machine, such as setting the date and time and networks, by following the on-screen instructions. ▶ **Setting up Using the Setup Guide(P. 6)**

Preparations Required Before Use

7L2J-001

Set up the machine in order from steps 1 through 4. For details, click a link to display the corresponding pages. To use the machine safely, at the same time, confirm **Preventing Unauthorized Access(P. 4)** .

Step 1

Setting up Using the Setup Guide(P. 6)



Step 2

Setting up the Network Environment(P. 8)

- Set up the network environment not included on the Setup Guide. If you do not start the Setup Guide, start setting up from this procedure.



Step 3

Installing Drivers(P. 44)



Step 4

Configuring E-Mail Print Settings(P. 45)



TIPS

Setting from the Remote UI

- When you complete setup for the network environment, you can set up the machine from Remote UI efficiently. **Starting the Remote UI(P. 262)**

Saving setup time by importing data from other machines

- If you have any other Canon printer/multifunction printer and save (export) its registered setup data to a computer beforehand, it can be immediately used by importing them to the machine. **Importing/Exporting the Setting Data(P. 273)**

Preventing Unauthorized Access

7L2J-002

This section describes the security measures on how to prevent unauthorized access from the external network. This is a must-read for all users and administrators before using this machine, other printers, and multifunction machines connected to the network. In recent years, a printer/multifunction machine connected to the network can offer you a variety of useful functions, such as printing from a computer, operating from a computer using the remote function, and sending scan documents via the Internet. On the other hand, it is essential to take security measures to reduce the security risk for information leakage, as a printer/multifunction machine has become more exposed to threats, such as unauthorized access and theft, when it is connected to the network. This section explains necessary settings you need to specify to prevent unauthorized access before using a printer/multifunction machine connected to the network.

- ▶ **Assigning a Private IP Address(P. 4)**
- ▶ **Using Firewall to Restrict Transmission(P. 5)**
- ▶ **Specifying the TLS Encrypted Communication(P. 5)**
- ▶ **Setting PIN to Manage Information Stored in the Multifunction Machine(P. 5)**

Assigning a Private IP Address

An IP address is a numerical label assigned to each device participating in a computer network. A "global IP address" is used for the communication connecting to the Internet, and a "private IP address" is used for the communication within a local area network, such as a LAN in the company. If a global IP address is assigned, your printer/multifunction machine is open to the public and can be accessed via the Internet. Thus, the risk of information leakage due to unauthorized access from external network increases. On the other hand, if a private IP address is assigned, your printer/multifunction machine is closed to a local area network and can be accessed by only users on your local area network, such as a LAN in the company.

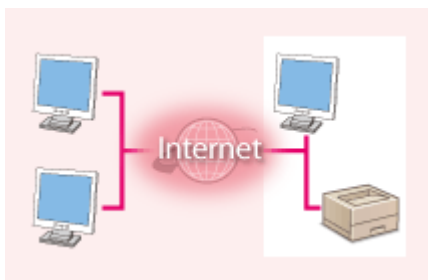

【Global IP address】

Accessible from outside your network

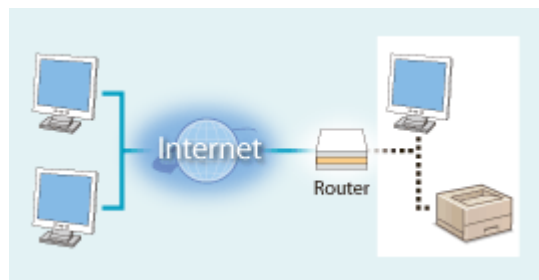

【Private IP address】

Accessible only from within a local area network

Basically, assign a private IP address to your printer/multifunction machine. Make sure to confirm the IP address, assigned to the printer/multifunction machine you are using, is a private IP address or not. A private IP address is found in one of the following ranges.

■ Ranges of Private IP Addresses

- 10.0.0.0 to 10.255.255.255
- 172.16.0.0 to 172.31.255.255
- 192.168.0.0 to 192.168.255.255

For information on how to confirm IP addresses, see ▶ **Setting an IPv4 Address(P. 23)** .

NOTE

- If a global IP address is assigned to a printer/multifunction machine, you can create a network environment to reduce the risk of unauthorized access by installing security software, such as a firewall that prevents

access from the external networks. If you want to assign a global IP address to and use a printer/multifunction machine, contact your network administrator.

Using Firewall to Restrict Transmission

A firewall is a system that prevents unauthorized access from the external networks and protects against attacks/intrusions to a local area network. You can use a firewall on your network environment to block access from the external network that appears to be dangerous, by restricting communication from specified IP address of the external network. The function installed to a Canon printer/multifunction machine enables you to set up the IP address filter. For information on how to set up an IP address filter, see [▶Specifying IP Addresses in Firewall Settings\(P. 213\)](#) .

Specifying the TLS Encrypted Communication

For information on the TLS Encrypted Communication, see [▶Configuring the Network Security Settings\(P. 210\)](#) , and on the procedures to specify, see [▶Configuring the Key and Certificate for TLS\(P. 223\)](#) .

Setting PIN to Manage Information Stored in the Multifunction Machine

If a malicious third party attempts to gain unauthorized access to a printer/multifunction machine, setting PIN to information stored in the machine will reduce the risk of information leakage. Canon printers/multifunction machines enable you to protect various type of information by setting PIN.

Password for each function / PIN code setting

- Personal authentication management using User Authentication [▶Configuring the Personal Authentication Management Settings\(P. 174\)](#)
- PIN code setting for system management contents [▶Changing the System Manager ID and PIN\(P. 201\)](#)

These are examples of preventing unauthorized access. For other details, see [▶Managing the Machine\(P. 160\)](#) and carry out necessary settings according to your environment.

Setting up Using the Setup Guide

7L2J-003

When the machine is turned ON for the first time ([▶Turning ON the Machine\(P. 61\)](#)), the initial setup of the machine begins automatically. You can adjust the basic setup necessary to use the machine. Configure the basic setup in accordance with each screen, or click a link to display the corresponding page and see details.

Step 1 Specify the display language.

Select the display language.

- Select the display language, and select the country/region where the machine will be used if countries/regions are displayed.

Step 2 Set the time zone.

Select the time zone where the machine is used.

Step 3 Specify the date and time.

Specify the date and time of the machine.

Step 4 Set the "Administrator" password for Remote UI authentication.

Set the password used when logging into the Remote UI as the "Administrator" user.

- If you do not want to set a password, select <No> on the confirmation screen and proceed to step 5.
- This machine is set to use the user authentication as the login service. For more information, see [▶Configuring the Personal Authentication Management Settings\(P. 174\)](#) .

Step 5 Set the network connection method.

Specify the method for connecting the machine to a network.

- If you select <Wired LAN>, the Setup Guide finishes and the <Home> screen is displayed.
- For details on wireless LAN connections, see [▶Connecting to a Wireless LAN\(P. 14\)](#) .

■ Starting the Setup Guide later

IMPORTANT

The Setup Guide cannot be started in the following cases.

- If the user authentication or department ID authentication is set.
- If the authentication with a card is performed.



<Set> ▶ <Management Settings> ▶ <License/Other> ▶ <Start Setup Guide> ▶ <Yes>

NOTE

- If the Setup Guide was started after the "Administrator" password for Remote UI authentication was set, step 4 is not displayed and the Setup Guide proceeds to step 5.

Setting the Date/Time

7L2J-004

Set the date and time for the machine. The date and time are used as the reference for the functions specifying the time, therefore, they need to be set accurately.

▶ **Setting the Time Zone(P. 7)**

▶ **Setting the Current Date and Time(P. 7)**

Setting the Time Zone



<Set> ▶ <Preferences> ▶ <Timer/Energy Settings> ▶ <Date/Time Settings> ▶ <Time Zone>

NOTE

What is UTC?

- Coordinated Universal Time (UTC) is the primary time standard by which the world regulates clocks and time. Time differences exist depending on the country or area where the machine is used. The correct UTC time zone setting is required for Internet communications.

Setting the Current Date and Time



<Set> ▶ <Preferences> ▶ <Timer/Energy Settings> ▶ <Date/Time Settings> ▶ <Current Date/Time Settings>

NOTE

- You can change the display format for the time.
▶ **<Time Format>(P. 358)**

Setting up the Network Environment

7L2J-005

To connect the machine to a network, connect the machine to a router using a LAN cable or Wi-Fi and specify a unique IP address in the network. To specify an IP address, there are two methods: automatic setting and manual setting. Select one of the methods that is suitable for your communication environment and devices. The machine adopts not only basic network functions, but also advanced technologies in order to flexibly cope with various environments. Carry out the necessary setup required for your environment.

! IMPORTANT

For safe use

- If you connect the machine to a network without appropriate security measures, there are risks that the machine might receive unauthorized access from third parties. Set up network security to secure important data and information. [▶Configuring the Network Security Settings\(P. 210\)](#)

NOTE

- You can connect the machine to a computer using a USB cable ([▶Parts and Their Functions\(P. 51\)](#)).
- You can establish a wireless direct connection between the machine and mobile devices. [▶Connecting Directly\(P. 144\)](#)

■ Confirm before handling

Follow the procedure below to make a connection to a network.



Confirm first.

- Are a computer and a router properly connected using a LAN cable? For details, see the instruction manual for each device or contact the manufacturers.
- Is setup of the computer network completed? If the setup is not completed, you cannot use the devices on a network even after completing the following steps.

NOTE:

- Depending on your environment, you may need to change the settings of the network communication system (half-duplex/full-duplex) and Ethernet type (1000BASE-T/100BASE-TX/10BASE-T) ([▶Making Ethernet Settings\(P. 29\)](#)). For details, contact the network administrator.
- To confirm the MAC address, see [▶<Network>\(P. 362\)](#) .
- To connect to a network employing IEEE802.1X, see [▶Configuring the IEEE 802.1X Authentication Settings\(P. 251\)](#) .



2



Select a wired LAN or wireless LAN for connection.

▶ **Selecting the Network Connection Method(P. 10)**



3



Connect the machine to a router.

- Is the LAN cable connector plugged into the proper place securely? Insert the connector until it clicks.
- For a wireless LAN connection, check the connection between the machine and the router.

▶ **Connecting to a Wired LAN(P. 12)**

▶ **Connecting to a Wireless LAN(P. 14)**



4



Set an IP address as necessary.

- Normally, an IP address is automatically allocated by DHCP, so this setting is not necessary. If you want to use a specific IP address or change the protocol of the automatic setting of an IP address from DHCP (initial setting) to another, this setting is necessary.

▶ **Setting an IP Address(P. 22)**



5



Confirm that proper connection is completed.

- Start the Remote UI from a computer (▶ **Starting the Remote UI(P. 262)**). If the Remote UI screen is displayed, the connection is completed.

NOTE

When <Sleep Mode Energy Use> is set to <Low>

- Depending on the utility software, communication may fail if the machine is in sleep mode. Press  (Energy Saver) to recover from the Sleep mode before configuring this setting. ▶ **<Sleep Mode Energy Use>(P. 360)**

LINKS

▶ **Adapting to the Network Environment(P. 28)**

Selecting the Network Connection Method

7L2J-006

You can select the method for connecting the machine to computers, etc. The following connection methods are available.

- Wired LAN only
- Wireless LAN only
- Simultaneous wired LAN and wireless LAN
- Simultaneous wired LAN and another wired LAN

When using simultaneous wired LAN and wireless LAN or simultaneous wired LAN and another wired LAN, the line connected from the LAN port of the machine is called the "main line" and the line connected from wireless LAN or another wired LAN is called the "sub line."

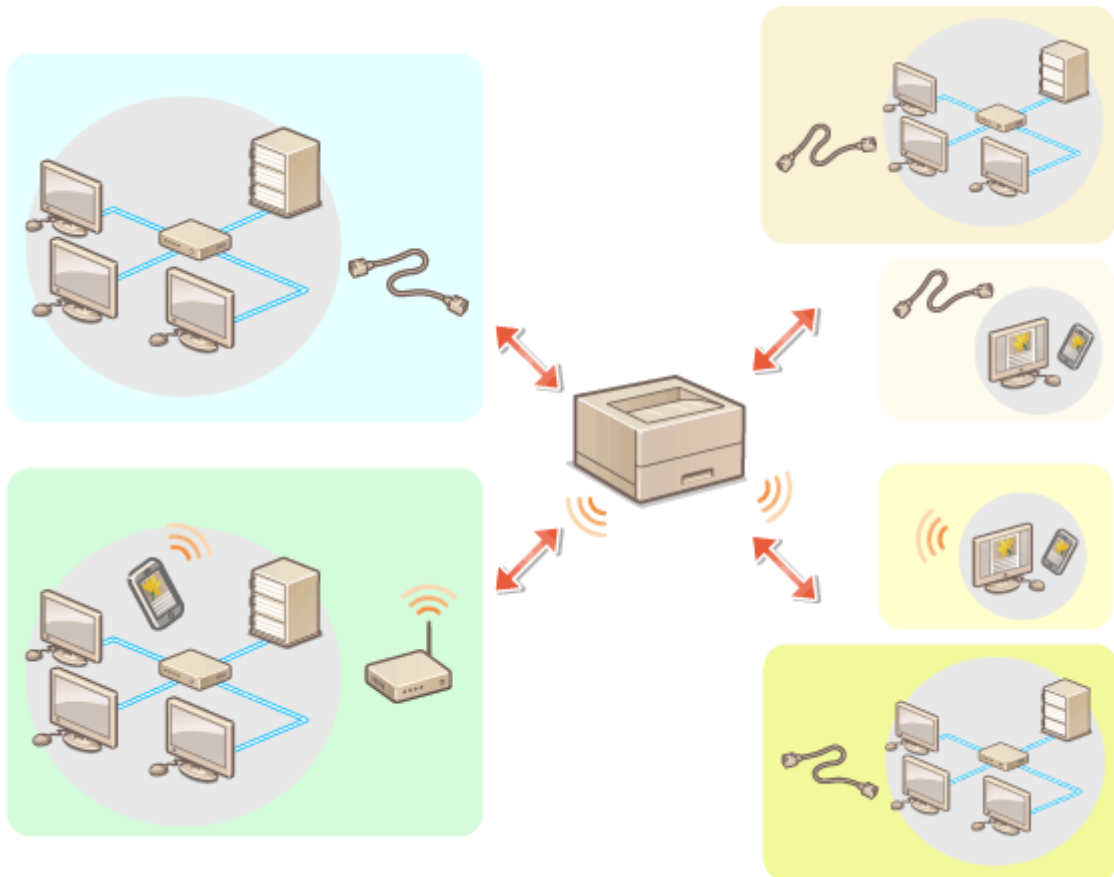

<Set> ▶ <Preferences> ▶ <Network> ▶ <Select Interface> ▶ select the interface

! IMPORTANT

- When using a sub line, see **Feature Highlights(P. 507)** .

If you selected <Wireless LAN> or <Wired LAN + Wireless LAN>

- The settings of <Wireless LAN Settings> are cleared.
- You cannot set wireless LAN as the main line and wired LAN as the sub line.

If you selected <Wired LAN + Wired LAN>

- Set <Sleep Mode Energy Use> to <High>. ▶<Sleep Mode Energy Use>(P. 360)

LINK

- ▶Connecting to a Wired LAN(P. 12)
- ▶Connecting to a Wireless LAN(P. 14)

Connecting to a Wired LAN

7L2J-007

Connect the machine to a computer via a router using a LAN cable.

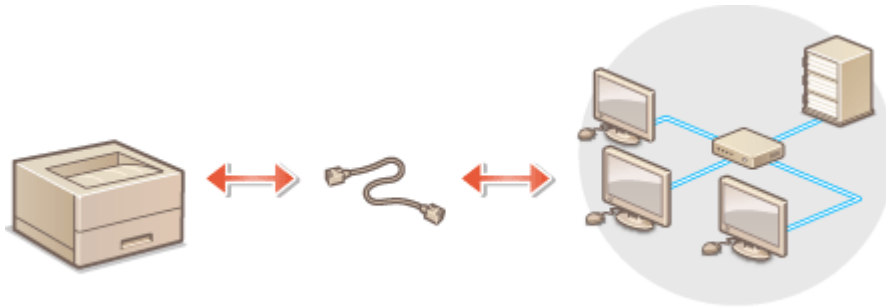

NOTE

- A router and LAN cable are not included with the machine, so please prepare them separately.
- The machine supports 1000BASE-T/100BASE-TX/10BASE-T Ethernet.
- To make a connection using 100BASE-TX/10BASE-T, use a category 5 twisted pair cable. It is recommended to use an enhanced category 5 twisted pair cable to make a connection using 1000BASE-T.
- If devices supporting 1000BASE-T, 100BASE-TX and 10BASE-T are used together, a device (such as a switching hub) supporting all of the Ethernet types you use is necessary. For more information, contact your dealer or service representative.

1 Connect the machine to a router using a LAN cable.

- Push the connector in until it clicks into place.

■ Connecting to a Wired LAN for the Sub Line

When <Wired LAN + Wired LAN> is selected in <Select Interface>, connect the wired LAN for the sub line. ▶ <Select Interface>(P. 370)

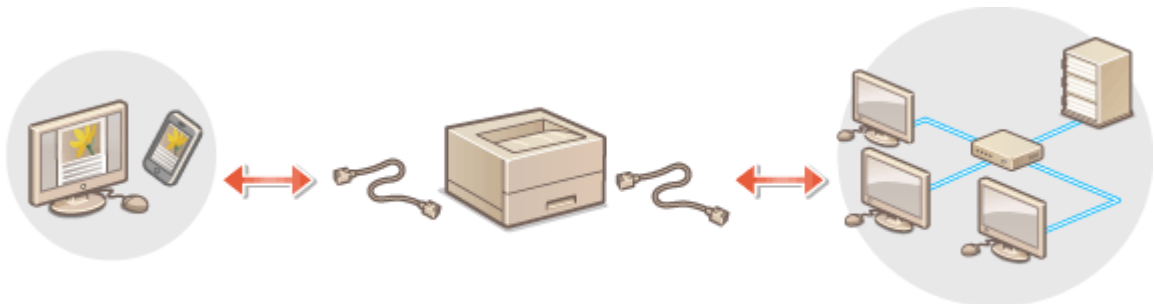

- 1 Connect the USB-LAN adapter to the USB port of the machine (front-right side of the machine). ▶ **Parts and Their Functions(P. 51)**

! IMPORTANT

- Multiple USB-LAN adapters cannot be connected.

NOTE

Setting Up

- For information on the USB-LAN adapters that can be used, contact your dealer or service representative.

Connecting to a Wireless LAN

7L2J-008

Wirelessly connect the machine to a computer or mobile device via a wireless LAN router (access point). If the wireless router is equipped with Wi-Fi Protected Setup (WPS), configuring your network is automatic and easy. If the wireless router does not support with WPS, or if you want to specify authentication and encryption settings in detail, you need to manually set up the connection. Configure connection on the computer or mobile device side in advance.

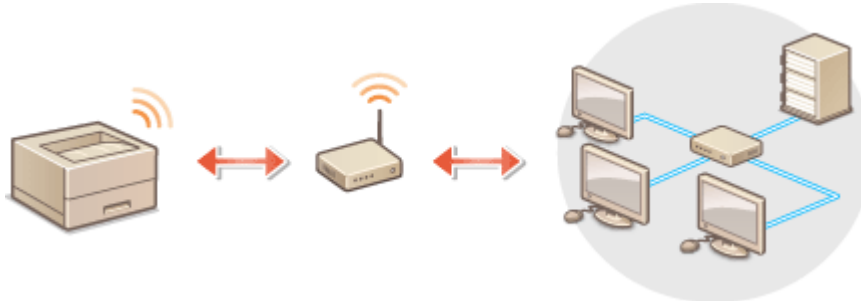

■ Setting Up the Connection Using WPS

If your wireless LAN router supports WPS, two setting modes are available: push button mode and PIN code mode.

- ▶ **Setting Up the Connection Using WPS Push Button Mode(P. 16)**
- ▶ **Setting Up the Connection Using WPS PIN Code Mode(P. 17)**

■ Setting Up the Connection Manually

There are two manual setting methods: manually configure the setting with a wireless LAN router selected, or manually enter all the required information for wireless LAN connection. Regardless of the method, make sure that you have the required setup information, including the SSID and network key.

- ▶ **Setting Up Connection by Selecting a Wireless Router(P. 18)**
- ▶ **Setting Up a Connection by Specifying Detailed Settings(P. 19)**
- ▶ **Checking the SSID and Network Key(P. 21)**

■ Check the settings and information of the wireless LAN

Check the information you set.



<Set> ▶ <Preferences> ▶ <Network> ▶ <Wireless LAN Settings> ▶ <Connection Information>

! IMPORTANT

- Use wireless LAN connection at your own discretion and at your own risk. If the machine is connected to an unsecured network, your personal information might be leaked to a third party because radio waves used in wireless communication can go anywhere nearby, even beyond walls.
- The wireless LAN security that is supported by the machine is listed below. For the wireless security compatibility of your wireless router, see the instruction manuals for your networking devices or contact your manufacturer.

128 (104)/64 (40) bit WEP

WPA-PSK (TKIP/AES-CCMP)

WPA2-PSK (TKIP/AES-CCMP)

WPA-EAP (AES-CCMP)

WPA2-EAP (AES-CCMP)

However, WPA-EAP and WPA2-EAP cannot be used if <Wired LAN + Wireless LAN> is selected in <Select Interface>.

- Depending on the network device, the operation of the wireless LAN router differs. See the instruction manuals for your networking device for help.
- When [Prohibit Use of Weak Encryption] is selected (**▶Setting the Security Strength and Encryption Method(P. 225)**), the machine cannot connect to a wireless LAN router if security settings are not configured or only WEP or TKIP set.

NOTE

- This machine does not come with a wireless router. Have the router ready.
- The wireless router must conform to IEEE 802.11b/g/n and be able to communication in 2.4 GHz bandwidth. For more information, see the instruction manuals for your networking devices or contact your manufacturer.

TIPS

Connecting directly

- You can establish a direct wireless connection between a mobile device and the machine without using a wireless LAN router. **▶Connecting Directly(P. 144)**



Reducing the power consumption

- If you set <Power Save Mode> to <On>, you can regularly set the machine to the power saving mode to match the signal that the wireless LAN router sends. <Wireless LAN Settings> **▶▶<Power Save Mode>(P. 371)**

Setting Up the Connection Using WPS Push Button Mode

7L2J-009

If your wireless router supports the WPS (Wi-Fi Protected Setup) Push Button mode, you can easily set up a connection with the WPS button on the router.



<Set> ► <Preferences> ► <Network> ► <Wireless LAN Settings> ► <WPS Push Button Mode> ►
select <Yes> on the confirmation screen ► press and hold the WPS button on the wireless router

⇒ When the wireless LAN router is detected and the configuration is complete, the screen <Connected.> will be displayed.

NOTE

- Depending on the networking device, you may need to press and hold the WPS button for 2 seconds or longer. See the instruction manuals for your networking device for help.
- If the wireless router is set to use WEP authentication, you may not be able to set up connection using WPS.

Setting Up the Connection Using WPS PIN Code Mode

7L2J-00A

Some WPS (Wi-Fi Protected Setup) routers do not support the Push Button mode. In this case, register the PIN code generated on the machine to the networking device.



Generating a PIN code on the machine



<Set> ▶ <Preferences> ▶ <Network> ▶ <Wireless LAN Settings> ▶ <WPS PIN Code Mode> ▶ select <Yes> on the confirmation screen

⇒ A PIN code is generated.



Registering the PIN code to the wireless router

Register the PIN code within two minutes after the PIN code is generated. For details, see the instruction manual for your networking device.

- 1 Access a wireless router from a computer.**
- 2 Display the screen for entering a WPS PIN code.**
- 3 Register the generated PIN code to the wireless router.**

⇒ When the wireless LAN router is detected and the configuration is complete, the screen <Connected.> will be displayed.

NOTE

- If the wireless router is set to use WEP authentication, you may not be able to set up connection using WPS.

Setting Up Connection by Selecting a Wireless Router

7L2J-00C

You can search the wireless routers available for connection and select one from the display of the machine. If the security standard for your wireless LAN router is WEP or WPA/WPA2-PSK, enter a WEP key or PSK for the network key. Confirm and write down in advance information regarding your SSID, network key, security standard, or authentication/encryption method, etc. [▶Checking the SSID and Network Key\(P. 21\)](#)

NOTE

Security settings

- If the wireless connection is set up by selecting a wireless router, the WEP authentication method is set to <Open System> or the WPA/WPA2-PSK encryption method is set to <Auto> (AES-CCMP or TKIP). If you want to select <Shared Key> for WEP authentication or <AES-CCMP> for WPA/WPA2-PSK encryption, set up the connection in <Enter Manually>. [▶Setting Up a Connection by Specifying Detailed Settings\(P. 19\)](#)
- If the security standard for your wireless LAN router is WPA/WPA2-EAP, the encryption method is set to AES-CCMP. Also, specify the IEEE 802.1X authentication settings for the machine before connecting to the wireless LAN. [▶Configuring the IEEE 802.1X Authentication Settings\(P. 251\)](#)

1 Select <Set> on the <Home> screen. [▶<Home> Screen\(P. 81\)](#)

2 Select <Preferences> ▶ <Network> ▶ <Wireless LAN Settings> ▶ <SSID Settings>.

3 Select <Select Access Point>.

- The machine starts searching for available wireless routers.

4 Select a wireless router, and connect to it.

■If the security setting of your wireless LAN router is WEP or WPA/WPA2-PSK

- 1 Select the wireless LAN router to use.
- 2 Enter the network key.
- 3 Select <Yes> on the confirmation screen.

▢▢▢▢ When the configuration is complete, the screen <Connected.> will be displayed.

■If the security setting of your wireless LAN router is other than WEP or WPA/WPA2-PSK

- 1 Select the wireless LAN router to use ▶ select <Yes> on the confirmation screen.

▢▢▢▢ When the configuration is complete, the screen <Connected.> will be displayed.

Setting Up a Connection by Specifying Detailed Settings

7L2J-00E

If you want to specify the security settings in detail or cannot establish the wireless connection using the other procedures, manually enter all the required information for the wireless LAN connection. Confirm and write down in advance information regarding your SSID, network key, security standard, or authentication/encryption method, etc.

▶Checking the SSID and Network Key(P. 21)

- 1** Select <Set> on the <Home> screen. ▶<Home> Screen(P. 81)
- 2** Select <Preferences> ▶ <Network> ▶ <Wireless LAN Settings> ▶ <SSID Settings>.
- 3** Select <Enter Manually> ▶ enter the SSID that you have checked.
 - Enter the SSID, and select <Apply>.
 - For instructions on how to enter text, see ▶<Entering Characters(P. 88) .
- 4** Specify the security settings in <Security Settings>.

■Using WEP

- 1** Select <WEP>.
- 2** Select an authentication method.
 - To use the WEP key as a password, select <Shared Key>.
 - When <Open System> is selected, an authentication error occurs during connection if the wireless router is using shared key authentication. If this happens, the machine automatically changes the setting to <Shared Key> and retries the connection.
- 3** Select the WEP key that you want to edit.
 - Select <Edit WEP Key> ▶ select any of <WEP Key 1> to <WEP Key 4>.
 - Up to four WEP keys can be registered.
- 4** Enter the network key that you have checked.
 - Enter the network key, and select <Apply>.
- 5** Select the WEP key to use.
 - Select <Select WEP Key> ▶ select the WEP key you have edited.

■Using WPA-PSK or WPA2-PSK

- 1** Select <WPA/WPA2-PSK>.
- 2** Select an encryption method.
 - To set the machine to automatically select AES-CCMP or TKIP to match the setting of the wireless router, press <Auto>.
- 3** Enter the network key that you have checked.
 - Enter the network key, and select <Apply>.

■ **Using WPA-EAP or WPA2-EAP**

- 1 Select <WPA/WPA2-EAP>.
- 2 Select <Yes> on the confirmation screen.

5 Select <Yes> on the confirmation screen.

- ▣ When the wireless LAN router is detected and the configuration is complete, the screen <Connected.> will be displayed.

Checking the SSID and Network Key

7L2J-00F

When manually setting up a wireless LAN router connection, it is necessary to specify the SSID, network key, and security standard, etc., of the wireless LAN router. The SSID and network key may be indicated on these networking devices. Check your devices before setting up the connection. If the security standard for your wireless LAN router is WPA/WPA2-EAP, specify the IEEE 802.1X authentication settings for the machine in advance ([Configuring the IEEE 802.1X Authentication Settings\(P. 251\)](#)). For more information, see the instruction manuals for your networking devices or contact your manufacturer.

SSID	A name given for identifying a specific wireless LAN. Some other terms used for SSID include "access point name" and "network name."
Network Key	A keyword or password used for encrypting data or authenticating a network. Some other terms used for network key include "encryption key," "WEP key," "WPA/WPA2 passphrase," "preshared key (PSK)."
Wireless Security Protocols (Authentication / Encryption)	<ul style="list-style-type: none"> • Security types (WEP/WPA-PSK/WPA2-PSK/WPA-EAP/WPA2-EAP) • Authentication method (Open System/Shared Key/IEEE 802.1X authentication) • Encryption method (TKIP/AES-CCMP)

IMPORTANT

- WPA/WPA2-EAP cannot be used if <Wired LAN + Wireless LAN> is selected in <Select Interface>.

Setting an IP Address

7L2J-00H

To connect the machine to a network, a unique IP address on the network is required. The machine supports two versions of IP addresses: "IPv4" and "IPv6." Set and use them according to your environment. You can use either IPv4 or IPv6. You can also use both of them at the same time.

When a connection method with a main line and sub line is selected in <Select Interface>, specify the IP address of the sub line in <IP Address Settings> in <Sub Line Settings>.

- ▶ **Setting an IPv4 Address(P. 23)**
- ▶ **Setting an IPv6 Address(P. 25)**
- ▶ **Setting the IPv4 Address of the Sub Line(P. 27)**

Setting an IPv4 Address

7L2J-00J

There are two methods to set an IPv4 address: allocating automatically using DHCP and entering manually. Select either of the two according to your environment. Conduct a connection test as necessary.

🔍 **Setting an IPv4 Address(P. 23)**

🔍 **Conducting a Connection Test for an IPv4 Address(P. 24)**

Setting an IPv4 Address

1 Select **<Set>** on the **<Home>** screen. 🔍 **<Home> Screen(P. 81)**

2 Select **<Preferences>** ▶ **<Network>** ▶ **<TCP/IP Settings>** ▶ **<IPv4 Settings>**.

3 Select **<Use IPv4>** ▶ **<On>** to enable IPv4 settings.

4 Select **<IP Address Settings>** and set an IP address.

- You can also set both automatic retrieval and manual retrieval. If you set both and set **<Release Address Last Acquired from DHCP Server When Address Cannot Be Acquired>** to **<Off>**, the manually entered IP address is used when automatic IP address retrieval fails.

■ Automatically assigning an IP address

1 Select **<IP Address Settings>** ▶ **<Auto Acquire>**.

2 Select **<Select Protocol>** ▶ **<DHCP>**.

3 Check that **<Auto IP>** is set to **<On>**.

- If **<Off>** is selected, change the setting to **<On>**.

4 Select **<Apply>**.

NOTE:

- If you press **<Auto IP>**, the available IP address is automatically searched in the network (LAN) and the value for each item is allocated. This function allocates the IP address without using a DHCP server. However, communication outside of the router range is not available.
- In an environment where both **<DHCP>** and **<Auto IP>** cannot be used, if either of the two is selected, useless communication occurs because the machine tries to check if the service is provided on the network.
- IP addresses assigned via DHCP override the address obtained via Auto IP.

■ Setting by manual entry

1 Configure a setting to disable auto-acquisition.

- Select **<Auto Acquire>**, and set both **<Select Protocol>** and **<Auto IP>** to **<Off>**.

- 2 Select <Manually Acquire>.
- 3 Enter the IP address, the subnet mask, and the gateway address.
 - Enter these values in each screen using the numeric keys, and press .

Conducting a Connection Test for an IPv4 Address

When the machine is connected properly, the Remote UI login screen can be displayed from the computer ([▶Starting the Remote UI\(P. 262\)](#)). You can conduct a connection test on the control panel of the machine.

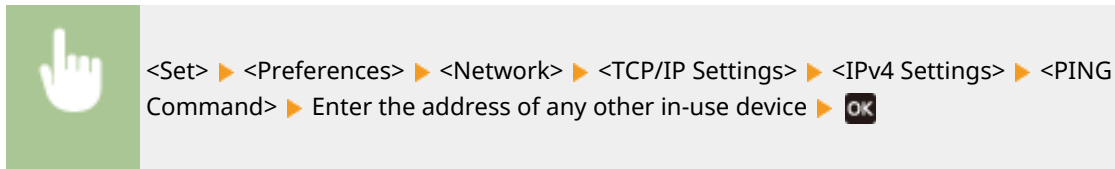

⇒ When the machine is connected correctly, the <Received response from host.> message is displayed.

IMPORTANT

- Even though IP addresses are properly set, if the machine is connected to a switching hub, the machine might not be connected to the network. In this case, delay the timing of the machine's communication start and try to connect again. [▶Setting the Wait Time When Connecting to a Network\(P. 30\)](#)

LINKS

[▶Setting an IPv6 Address\(P. 25\)](#)

Setting an IPv6 Address

7L2J-00K

The following are the types of IPv6 addresses. Register as necessary. Up to four stateless addresses can be registered. Conduct a connection test as necessary.

Type	Explanation
Link local address	Addresses that can be used only in the same link and that are automatically created without setting anything. Cannot be used out of the router range.
Stateless address	Addresses that are created automatically on the basis of the prefix notified by a router and the MAC address of the machine, even in an environment without a DHCP server.
Manual address	Addresses that are manually entered. Prefix length and a default router address are specified.
Stateful address	Addresses that are acquired from the DHCP server.

▶ **Setting an IPv6 Address(P. 25)**

▶ **Conducting a Connection Test for an IPv6 Address(P. 26)**

Setting an IPv6 Address

- 1 Start the Remote UI. ▶Starting the Remote UI(P. 262)**
- 2 Click [Settings/Registration] on the Portal page. ▶Remote UI Screen(P. 263)**
- 3 Click [Network Settings] ▶ [IPv6 Settings].**
- 4 Select [Use IPv6] and configure the required settings.**

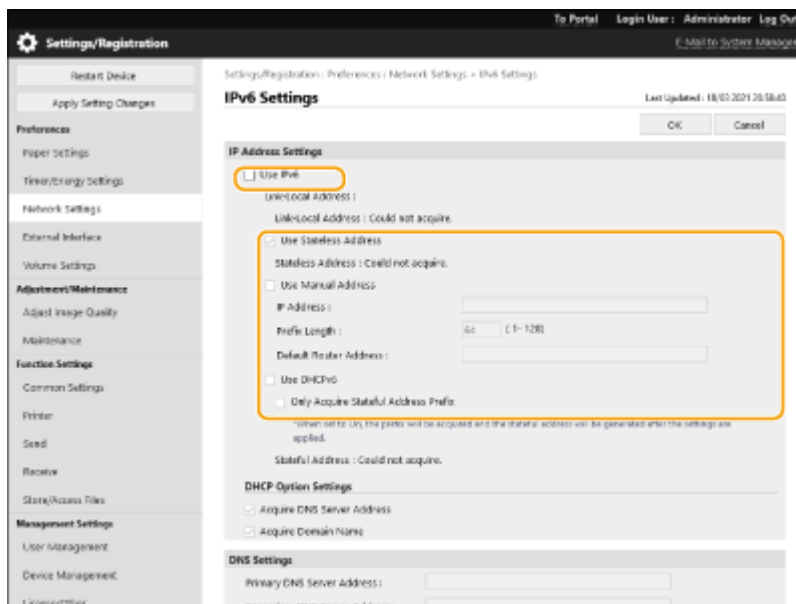

[Use IPv6]

Select the check box to enable IPv6 on the machine. When not using IPv6, deselect the check box.

[Use Stateless Address]

Select the check box when using a stateless address. When not using a stateless address, deselect the check box.

[Use Manual Address]

When you want to manually enter an IPv6 address, select the check box and enter the IP address, prefix length, and default router address in the corresponding text boxes.

The following addresses cannot be used.

- IPv4-compatible addresses (IPv6 addresses in which the upper 96 bits are "0" with an IPv4 address contained in the lower 32 bits)
- IPv4-mapped addresses (IPv6 addresses in which the upper 96 bits are "0:0:0:ffff:" with an IPv4 address contained in the lower 32 bits)

[IP Address]

Enter an IPv6 address. Addresses that start with "ff" (or multicast address) cannot be entered.

[Prefix Length]

Enter a number that indicates how many bits are available for the network address.

[Default Router Address]

Specify the IPv6 address of the default router as necessary. Addresses that start with "ff" (or multicast address) cannot be entered.

[Use DHCPv6]

Select the check box when using a stateful address. When not using DHCPv6, deselect the check box.

[Only Acquire Stateful Address Prefix]

Select this check box to only retrieve the first half of the stateful address from the DHCP server using DHCPv6.

5 Click [OK].

Conducting a Connection Test for an IPv6 Address

When the machine is connected properly, the Remote UI login screen can be displayed from a computer ([▶Starting the Remote UI\(P. 262\)](#)).

IMPORTANT

- Even though IP addresses are properly set, if the machine is connected to a switching hub, the machine might not be connected to the network. In this case, delay the timing of the machine's communication start and try to make a connection again. [▶Setting the Wait Time When Connecting to a Network\(P. 30\)](#)

LINKS

[▶Setting an IPv4 Address\(P. 23\)](#)

Setting the IPv4 Address of the Sub Line

7L2J-00L

Specify the IPv4 address to use for the sub line.

NOTE

- Only IPv4 addresses can be used with the sub line.

1 Select <Set> on the <Home> screen.  <Home> Screen(P. 81)

2 Select <Preferences> ► <Network> ► <Sub Line Settings>.

3 Select <IP Address Settings> and set the IP address of the sub line.

- You can also set both automatic retrieval and manual retrieval. If you set both and set <Release Address Last Acquired from DHCP Server When Address Cannot Be Acquired> to <Off>, the manually entered IP address is used when automatic IP address retrieval fails.

■ Automatically Assigning the IP Address with DHCP

1 Select <IP Address Settings> ► <Auto Acquire>.

2 Select <DHCP>.

NOTE:

- If <DHCP> is selected, communication is performed to check whether network services are being provided, regardless of whether the environment can use DHCP. It is recommended that you deselect this item if you are not using DHCP.

■ Manually Entering the IP Address

1 Configure a setting to disable auto-acquisition.

- Select <Auto Acquire> ► <Off>.

2 Select <Manually Acquire>.

3 Enter the IP address and subnet mask.

- Enter these values in each screen using the numeric keys, and press .

NOTE:

- When connecting to another network via a router, enter the gateway address and also configure <Static Routing Settings>.  **Setting Static Routing(P. 38)**

Adapting to the Network Environment

7L2J-00R

The scale and form of a network varies depending on the purpose and use. The machine adopts various technologies for adapting to as many environments as possible. Consult your network administrator and carry out necessary settings according to your environment.

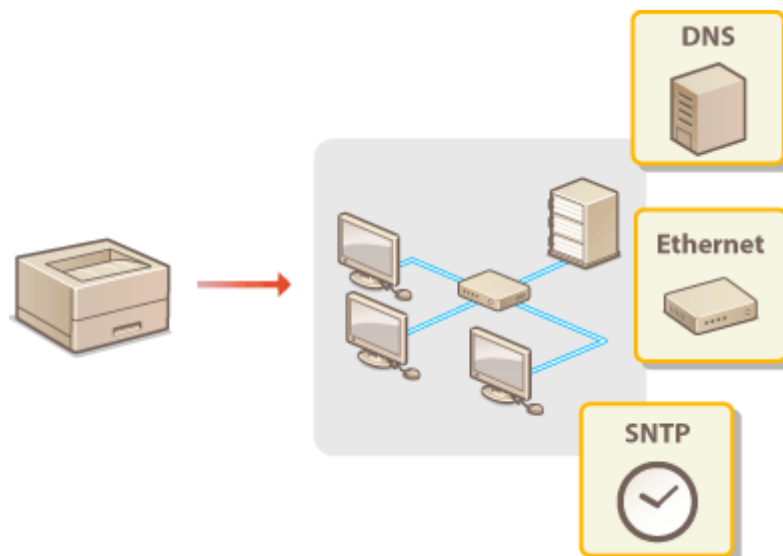

- ▶ Making Ethernet Settings(P. 29)
- ▶ Setting the Wait Time When Connecting to a Network(P. 30)
- ▶ Making DNS Settings(P. 31)
- ▶ Monitoring and Controlling the Machine with SNMP(P. 34)
- ▶ Setting Static Routing(P. 38)
- ▶ Other Network Settings(P. 40)
- ▶ Configuring System Data Communication(P. 43)

Making Ethernet Settings

Ethernet is a standard that stipulates communication methods within a LAN. Normally, the communication system (half-duplex/full-duplex) and Ethernet type (1000BASE-T/100BASE-TX/10BASE-T) can be set automatically. You can set them separately by switching the setting to manual operation. Register the settings as necessary.

<Ethernet Driver Settings> exists for both the main line and sub line. Configure each as required.

1 Select <Set> on the <Home> screen. <Home> Screen(P. 81)

2 Select <Preferences> ▶ <Network> ▶ <Ethernet Driver Settings>.

- To specify the Ethernet settings for the sub line, select <Preferences> ▶ <Network> ▶ <Sub Line Settings> ▶ <Ethernet Driver Settings>.

3 Select whether to configure Ethernet settings automatically or manually.

- Normally, set <Auto Detect> to <On>. The communication system and Ethernet type are detected and automatically configured.

■ Configuring Ethernet settings automatically

- 1 Select <Auto Detect> ▶ <On>.

■ Making Ethernet settings manually

- 1 Configure a setting to disable Auto Detect.
 - Select <Auto Detect> ▶ <Off>.
- 2 Select <Communication Mode> ▶ select the communication mode.

<Half Duplex>

Alternately sends and receives communication data. Select when the machine is connected to a networking device using half duplex.

<Full Duplex>

Simultaneously sends and receives communication data. Use this setting for most environments.

- 3 Select <Ethernet Type> ▶ select the Ethernet type.
 - Select <10BASE-T>, <100BASE-TX>, or <1000BASE-T> in <Ethernet Type>.

LINKS

-  [Setting the Wait Time When Connecting to a Network\(P. 30\)](#)

Setting the Wait Time When Connecting to a Network

7L2J-00U

If you intend to implement network redundancy by connecting several switching hubs, a mechanism is necessary to avoid packet looping. In this case, it is effective to determine the roles of the switching ports, but communication may not be properly transmitted in cases just after changes such as adding a new device to the network. To connect the machine to such a network, set the waiting time which is the time until the communication starts.

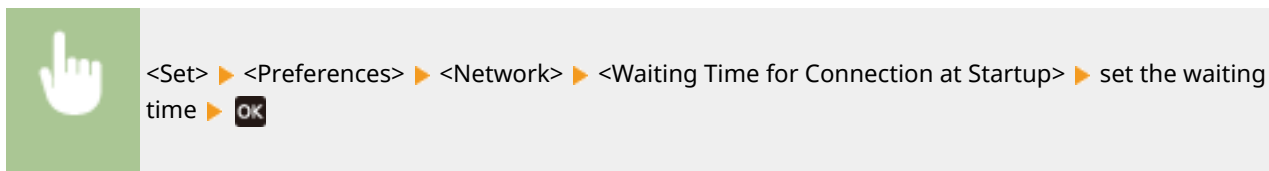

LINKS

▶ **Making Ethernet Settings(P. 29)**

Making DNS Settings

7L2J-00W

DNS (Domain Name System) provides a service for name resolution that associates a host (or domain) name with an IP address. Configure the DNS, mDNS, or DHCP option settings as necessary. Note that the procedures for configuring DNS are different for IPv4 and IPv6. Administrator privileges are required for this operation.

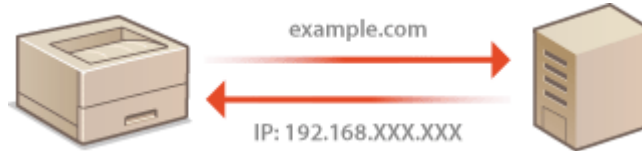

NOTE

- The DHCP optional setting only applies to the main line.

- 1 Start the Remote UI. ▶ Starting the Remote UI(P. 262)
- 2 Click [Settings/Registration] on the Portal page. ▶ Remote UI Screen(P. 263)
- 3 Click [Network Settings].
- 4 Configure DNS settings.

■ Configuring IPv4 DNS

- 1 Click [IPv4 Settings].
- 2 Configure IPv4 DNS settings.

The screenshot shows the 'IPv4 Settings' configuration page. The left sidebar contains a menu with 'Network Settings' selected. The main content area is divided into three sections:

- Section a (DHCP Option Settings):** Contains checkboxes for 'Acquire Host Name', 'Perform DNS Dynamic Update', 'Acquire DNS Server Address', 'Acquire Domain Name', and 'Acquire POP Server Address'. There is also a checkbox for 'Release Address Last Acquired from DHCP Server When Address Cannot be Acquired'.
- Section b (DNS Settings):** Contains input fields for 'Primary DNS Server Address' (192.168.83.2), 'Secondary DNS Server Address' (0.0.0.0), 'Host Name' (CanonC001P), and 'Domain Name' (localdomain). There is a checkbox for 'Perform DNS Dynamic Update'.
- Section c (mDNS Settings):** Contains a checkbox for 'Use mDNS' and an input field for 'mDNS Name' (Canon).

a [DHCP Option Settings]**[Acquire Host Name]**

Select the check box to enable Option 12 to obtain the host name from the DHCP server.

[Perform DNS Dynamic Update]

Select the check box to enable Option 81 to dynamically update the DNS records through the DHCP server.

[Acquire DNS Server Address]

Select the check box to enable Option 6 to obtain a DNS server address from the DHCP server.

[Acquire Domain Name]

Select the check box to enable Option 15 to obtain a domain name from the DHCP server.

[Acquire POP Server Address]

Select the check box to enable Option 70 to obtain a POP server address from the DHCP server.

[Release Address Last Acquired from DHCP Server When Address Cannot Be Acquired]

Deselect the check box to use the manually entered IP address when automatic IP address retrieval fails.

b [DNS Settings]**[Primary DNS Server Address]**

Enter the IP address of a DNS server.

[Secondary DNS Server Address]

Enter the IP address of a secondary DNS server, if any.

[Host Name]

Enter alphanumeric characters for the host name of the machine that is to be registered to the DNS server.

[Domain Name]

Enter alphanumeric characters for the name of the domain the machine belongs to, such as "example.com."

[Perform DNS Dynamic Update]

Select the check box to dynamically update the DNS records whenever the machine's IP address is changed.

c [mDNS Settings]**[Use mDNS]**

Adopted by Bonjour, mDNS (multicast DNS) is a protocol for associating a host name with an IP address without using DNS. Select the check box to enable mDNS and enter the mDNS name in the [mDNS Name] text box.

3 Click [OK].

■ Configuring IPv6 DNS

1 Click [IPv6 Settings].

2 Configure IPv6 DNS settings.

- The [Use IPv6] check box must be selected to configure the settings. **▶ Setting an IPv6 Address(P. 25)**

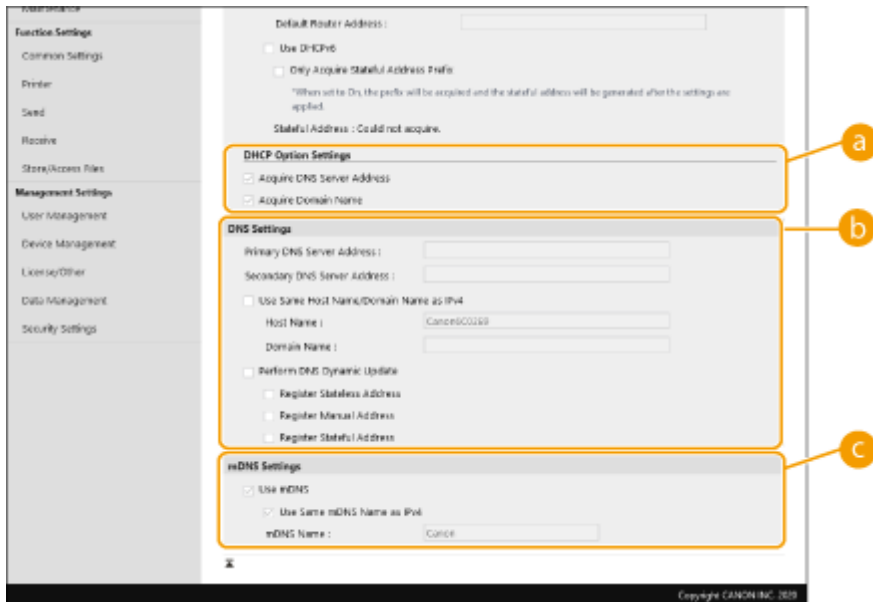

a [DHCP Option Settings]

[Acquire DNS Server Address]

Select the check box to enable Option 23 to obtain a DNS server address from the DHCP server.

[Acquire Domain Name]

Select the check box to enable Option 24 to obtain a domain name from the DHCP server.

b [DNS Settings]

[Primary DNS Server Address]

Enter the IP address of a DNS server. Addresses that start with "ff" (or multicast address) cannot be entered.

[Secondary DNS Server Address]

Enter the IP address of a secondary DNS server, if any. Addresses that start with "ff" (or multicast address) cannot be entered.

[Use Same Host Name/Domain Name as IPv4]

Select the check box to use the same host and domain names as in IPv4.

[Host Name]

Enter alphanumeric characters for the host name of the machine that is to be registered to the DNS server.

[Domain Name]

Enter alphanumeric characters for the name of the domain the machine belongs to, such as "example.com."

[Perform DNS Dynamic Update]

Select the check box to dynamically update the DNS records whenever the machine's IP address is changed. To specify the type(s) of addresses you want to register to the DNS server, select the check box for [Register Manual Address], [Register Stateful Address], or [Register Stateless Address].

c [mDNS Settings]

[Use mDNS]

Adopted by Bonjour, mDNS (multicast DNS) is a protocol for associating a host name with an IP address without using DNS. Select the check box to enable mDNS.

[Use Same mDNS Name as IPv4]

Select the check box to use the same mDNS name as in IPv4. To set a different name, deselect the check box and enter the mDNS name in the [mDNS Name] text box.

3 Click [OK].

Monitoring and Controlling the Machine with SNMP

7L2J-00X

Simple Network Management Protocol (SNMP) is a protocol for monitoring and controlling communication devices in a network by using Management Information Base (MIB). The machine supports SNMPv1 and security-enhanced SNMPv3. You can check the status of the machine from a computer when you print documents or use the Remote UI. You can enable either SNMPv1 or SNMPv3, or both at the same time. Specify the settings for each version to suit your network environment and the purpose of use.

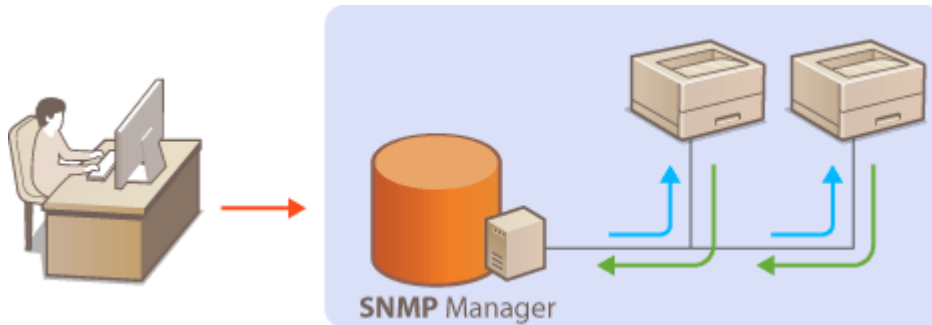

SNMPv1

SNMPv1 uses information called "community" to define the scope of SNMP communication. Because this information is exposed to the network in plain text, your network will be vulnerable to attacks. If you want to ensure network security, disable SNMPv1 and use SNMPv3.

SNMPv3

With SNMPv3, you can implement network device management that is protected by robust security features. Note that TLS must be enabled for the Remote UI before configuring SNMPv3 ([▶Configuring the Key and Certificate for TLS\(P. 223\)](#)).

NOTE

- SNMP management software, when installed on a computer on the network, enables you to configure, monitor, and control the machine remotely from the computer. For more information, see the instruction manuals for your management software.

- 1 Start the Remote UI. [▶Starting the Remote UI\(P. 262\)](#)**
- 2 Click [Settings/Registration] on the Portal page. [▶Remote UI Screen\(P. 263\)](#)**
- 3 Click [Network Settings] ▶ [SNMP Settings].**
- 4 Specify SNMPv1 settings.**
 - If you do not need to change SNMPv1 settings, proceed to the next step.

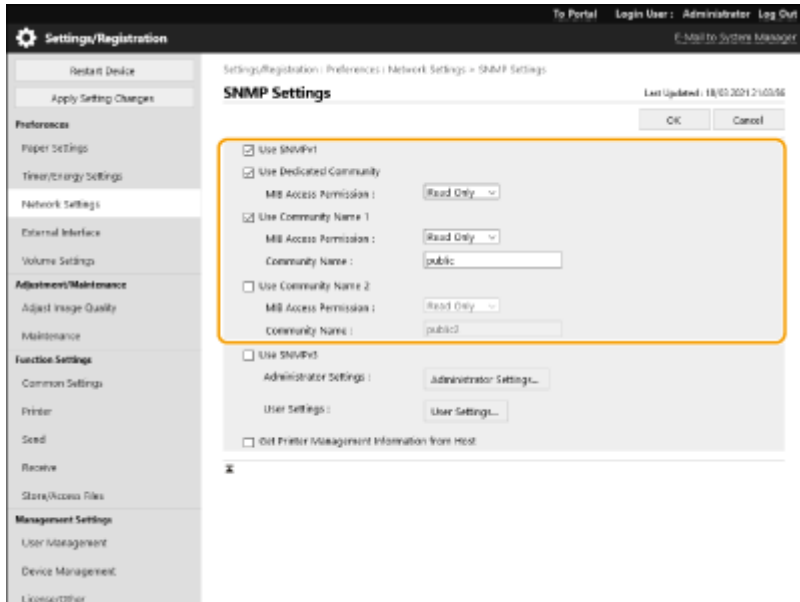

[Use SNMPv1]

Select the check box to enable SNMPv1. You can specify the rest of SNMPv1 settings only when this check box is selected.

[Use Dedicated Community]

The exclusive community is a community (group) prepared for managers using device management software. Select the check box to use Dedicated Community, and specify [MIB Access Permission]. If you do not need to use Dedicated Community, deselect the check box.

[Use Community Name 1]/[Use Community Name 2]

Select the check box to specify a community name. If you do not need to specify a community name, deselect the check box.

[MIB Access Permission]

For each community, select [Read/Write] or [Read Only] for the access privileges to MIB objects.

[Read/Write]	Permits both viewing and changing the values of MIB objects.
[Read Only]	Permits only viewing the values of MIB objects.

[Community Name]

Enter alphanumeric characters for the name of the community.

5 Select [Use SNMPv3] and configure SNMPv3.

- If you do not need to change SNMPv3 settings, proceed to the next step.

- 1 Click [Administrator Settings].

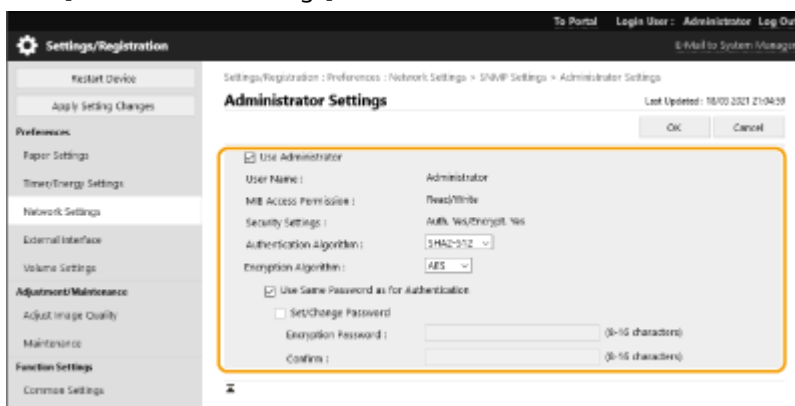

[Use Administrator]

Select the check box to use the Administrator user.

- [Authentication Algorithm] and [Encryption Algorithm] cannot be changed.

[Use Same Password as for Authentication]

Select the check box to use the same password as the password used in user authentication.

- 2 Click [OK].
- 3 Click [User Settings] ► [Register].

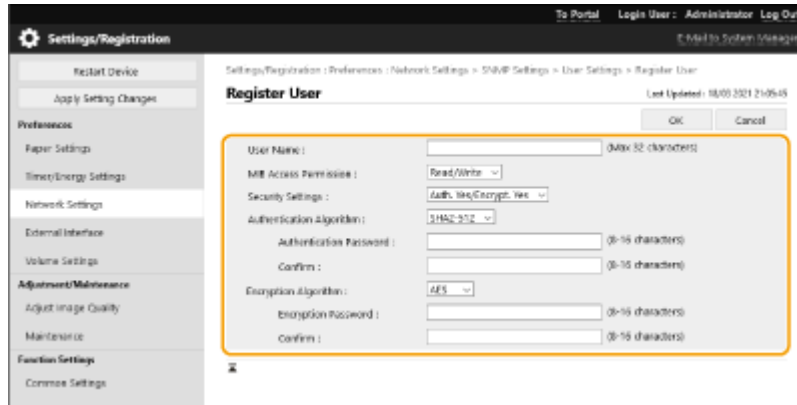

[User Name]

Enter alphanumeric characters for the user name.

[MIB Access Permission]

Select [Read/Write] or [Read Only] for the access privileges to MIB objects.

[Read/Write]	Permits both viewing and changing the values of MIB objects.
[Read Only]	Permits only viewing the values of MIB objects.

[Security Settings]

Select [Auth. Yes/Encrypt. Yes], [Auth. Yes/Encrypt. No], or [Auth. No/Encrypt. No] for the desired combination of authentication and encryption settings.

[Authentication Algorithm]

Select [MD5], [SHA1] or [SHA2] according to your environment. For [SHA2], select from four hash lengths (224 bit, 256 bit, 384 bit, or 512 bit).

[Encryption Algorithm]

If you have selected [Auth. Yes/Encrypt. Yes] in [Security Settings], select the appropriate encryption algorithm for your network environment.

[Authentication Password]/[Encryption Password]

Use alphanumeric characters to enter the password in [Authentication Password] or both [Encryption Password] and [Confirm], depending on the settings in [Security Settings]. Set this for each algorithm (authentication/encryption).

- 4 Click [OK].
- 5 Click [Network Settings] ► [SNMP Settings].

6 Specify Printer Management Information Acquisition Settings.

- With SNMP, the printer management information, such as printing protocols and printer ports, can be monitored and obtained regularly from a computer on the network.

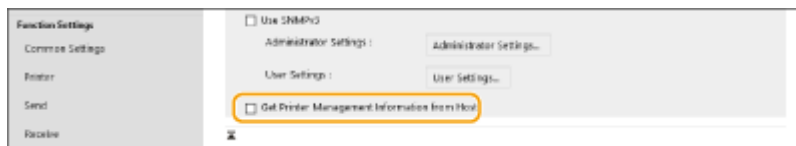

Select the check box to enable monitoring of the printer management information of the machine via SNMP. To disable monitoring of the printer management information, clear the check box.

[Get Printer Management Information from Host]

Select the check box to enable monitoring of the printer management information of the machine via SNMP. To disable monitoring of the printer management information, deselect the check box.

7 Click [OK].

NOTE

Disabling SNMPv1

- If SNMPv1 is disabled, some of the functions of the machine become unavailable, such as obtaining machine information via the printer driver.

Using the control panel

- You can enable or disable the SNMP settings from <Set>. ▶<SNMP Settings>(P. 367)

Enabling Both SNMPv1 and SNMPv3

- If both versions of SNMP are enabled, it is recommended that MIB access permission in SNMPv1 be set to [Read Only]. MIB access permission can be set independently in SNMPv1 and SNMPv3 (and for each user in SNMPv3). Selecting [Read/Write] (full access permission) in SNMPv1 negates the robust security features that characterize SNMPv3 because most of the machine settings can then be controlled with SNMPv1.

LINKS

- ▶<Configuring the Key and Certificate for TLS(P. 223)

Setting Static Routing

7L2J-00Y

You can set static routing to manually specify the network route.

For example, when sending data from a machine connected to other networks via a router with both the main line and sub line, the data can be sent via the gateway of the sub line instead of the gateway of the main line that is normally used.

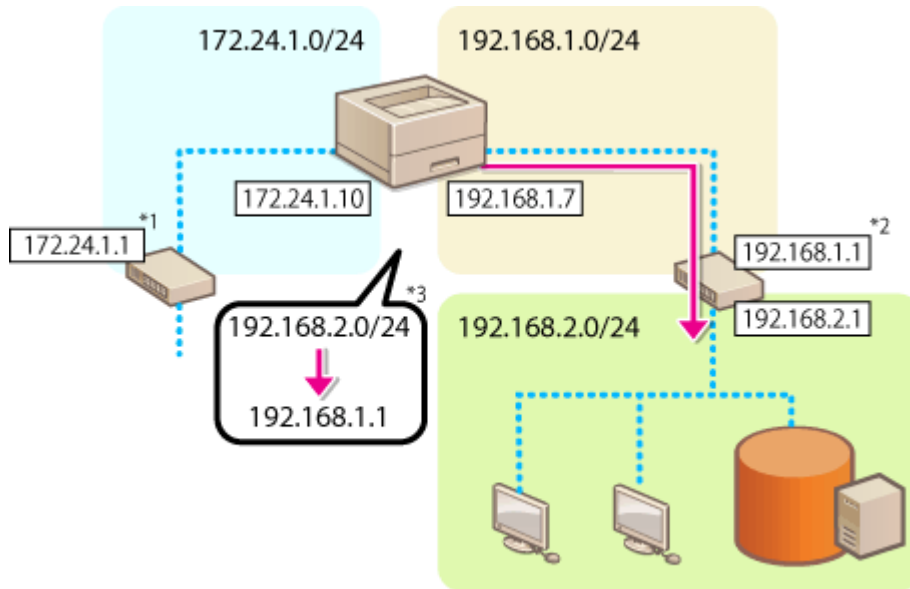

*1 Main line gateway

*2 Sub line gateway

*3 Static routing settings

NOTE

- When connecting to another network via a router, enter the gateway address in [IPv4 Settings]/[Sub Line Settings: Basic Settings] in advance. [▶Setting an IPv4 Address\(P. 23\)](#) [▶Setting the IPv4 Address of the Sub Line\(P. 27\)](#)

- 1** Start the Remote UI. [▶Starting the Remote UI\(P. 262\)](#)
- 2** Click [Settings/Registration] on the Portal page. [▶Remote UI Screen\(P. 263\)](#)
- 3** Click [Network Settings] ▶ [Static Routing Settings].
- 4** Select [Use Static Routing].
- 5** Click [Register] in the line of the static routing information to register.

- [Edit] or [Delete] is displayed for lines that already have information registered.

6 Enter [Destination Address] and [Gateway Address] ► click [OK] ► [OK].

- Press each button and enter the required setting.

NOTE

- The route order is displayed in [Priority] on the static routing settings screen.
- You can register up to 16 devices that can be connected.
- The success/failure of the static routing settings is displayed in [Routing Registration].
- When failure is indicated in [Routing Registration], select the static routing settings that failed and set the address and gateway address again.

Other Network Settings

7L2J-010

Set the following according to your network environment.

- ▶ **Making SNTP Settings(P. 40)**
- ▶ **Monitoring the Machine From Device Management Systems(P. 41)**
- ▶ **Specifying the Dedicated Port Settings(P. 41)**

Making SNTP Settings

Simple Network Time Protocol (SNTP) enables you to adjust the system clock by using the time server on the network. If SNTP is used, the time server is checked at the specified intervals; therefore, the correct time can always be maintained. The time is adjusted based on Coordinated Universal Time (UTC), so specify the time zone setting before configuring SNTP (▶ **Setting the Date/Time(P. 7)**). SNTP settings can be specified via the Remote UI.

NOTE

- The SNTP of the machine supports both NTP (version 3) and SNTP (versions 3 and 4) servers.

- 1 Start the Remote UI. ▶Starting the Remote UI(P. 262)**
- 2 Click [Settings/Registration] on the Portal page. ▶Remote UI Screen(P. 263)**
- 3 Click [Network Settings] ▶ [SNTP Settings].**
- 4 Select [Use SNTP] and specify the required settings.**

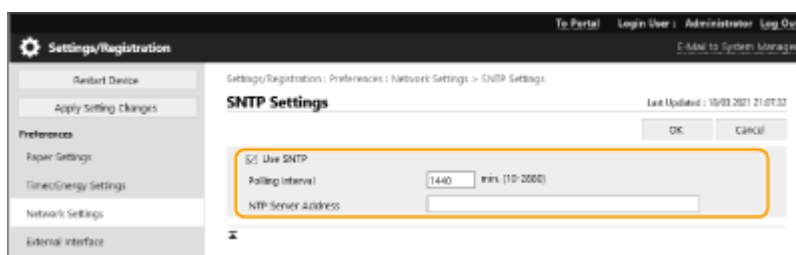

[Use SNTP]

Select the check box to use SNTP for synchronization. If you do not want to use SNTP, deselect the check box.

[Polling Interval]

Specify the interval between one synchronization and the next.

[NTP Server Address]

Enter the IP address of the NTP or the SNTP server. If DNS is available on the network, you can enter a host name (or FQDN) consisting of alphanumeric characters instead (example: ntp.example.com).

- 5 Click [OK].**

Monitoring the Machine From Device Management Systems

When Canon device management software is employed, you can collect/manage various information such as setting information and device failure information on the network through a server.

- 1 Start the Remote UI. ▶ Starting the Remote UI(P. 262)
- 2 Click [Settings/Registration] on the Portal page. ▶ Remote UI Screen(P. 263)
- 3 Click [Network Settings] ▶ [Multicast Discovery Settings].
- 4 Select [Respond to Discovery] and specify the required settings.

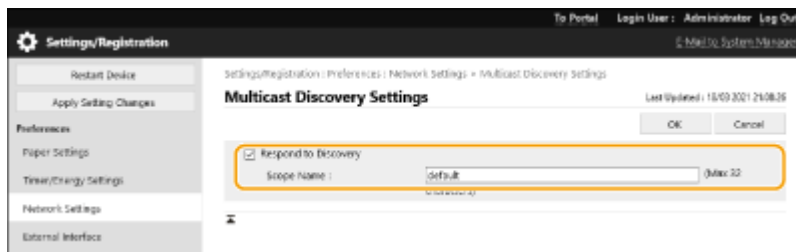

[Respond to Discovery]

Select the check box to set the machine to respond to device management software multicast discovery packets and enable monitoring by device management software.

[Scope Name]

To include the machine into a specific scope, enter alphanumeric characters for the scope name.

- 5 Click [OK].

Specifying the Dedicated Port Settings

You can specify whether to configure/refer to detailed information of the machine from the Canon drivers or utility software

- 1 Start the Remote UI. ▶ Starting the Remote UI(P. 262)
- 2 Click [Settings/Registration] on the Portal page. ▶ Remote UI Screen(P. 263)
- 3 Click [Network Settings] ▶ [Dedicated Port Settings].
- 4 Select [Use Dedicated Port] and set the authentication method.

[Mode 1]

Select the check box when the authentication settings mode cannot be selected in the software being used, such as the driver or device management software.

[Mode 2]

Select the check box when the authentication settings mode can be selected in the software being used, such as the driver or device management software.

5 Click [OK].

NOTE

- Some applications that use the dedicated port may become unable to be used if [Use Dedicated Port] is deselected.
- If you select [Mode 2], communication using the dedicated port uses a secure mode. Accordingly, you may not be able to connect from software such as drivers or device management software.

LINKS

 <Network>(P. 362)

Configuring System Data Communication

7L2J-011

The settings described in this section are required to use the sub line for performing DNS name resolution and data communication via a proxy. Administrator privileges are required to specify these settings.

NOTE

- The DNS server address setting and proxy settings for the sub line can only be used for specific system data communication. They cannot be used for a regular internet connection. When using a DNS server or proxy server for the sub line for applications other than system data communication, register the addresses and port numbers to use with the sub line in the settings of the main line.

- 1 Start the Remote UI.** ▶ **Starting the Remote UI(P. 262)**
- 2 Click [Settings/Registration] on the Portal page.** ▶ **Remote UI Screen(P. 263)**
- 3 Click [Network Settings] ▶ [Settings for System Data Communication].**
- 4 Specify the required settings.**

■Setting the DNS of the sub line

- 1** Enter the IP address of the DNS server in [IPv4 DNS Settings], according to your environment.

■Setting the proxy of the sub line

- 1** Select [Use Proxy].
- 2** Enter the address and port number of the proxy server, according to your environment.
- 3** To use proxy authentication, select [Use Proxy Authentication] and enter the user name and password.

- 5 Click [OK].**

Installing Drivers

7L2J-012

Install the various drivers and associated software on your computer.

1 Make preparations before installation.

- Equip the main unit with optional equipment ( **Optional Equipment(P. 544)**).
- Install the drivers and software to use from the included CD/DVD-ROM or by downloading them from the Canon website for your country/region accessed via the URL indicated below.
(<https://global.canon/en/support/>)

NOTE:

- The latest versions of drivers and software are uploaded to the Canon website when they become available. Download them as needed after checking the operating environment for your machine.
- Some functions of drivers and software may not be available depending on the model of the machine or operating environment.
- Some drivers may not be fully compatible with the operating system you are using. Check the driver compatibility with latest versions of operating systems on the Canon website.

2 Carry out installation of the drivers.

- For details on the installation, see the manuals for the drivers and software you want to use.

IMPORTANT

- If communication via the relevant IP address is not permitted in [Firewall Settings], you cannot install the driver. For more information, see  **Specifying IP Addresses in Firewall Settings(P. 213)** .
- After you have installed the driver, if communication via the IP address of the computer you have installed it on is not permitted in [Firewall Settings], you cannot print from that computer.

Configuring E-Mail Print Settings

7L2J-013

This section describes how to specify the settings for receiving and printing e-mails on this machine. Use a computer to specify the settings for receiving e-mails and the control panel of the machine to specify the settings for printing e-mails. Administrator privileges are required in order to configure these settings.

- 1 Start the Remote UI. ▶ Starting the Remote UI(P. 262)
- 2 Click [Settings/Registration] on the Portal page. ▶ Remote UI Screen(P. 263)
- 3 Click [Send] ▶ [Network Settings - E-Mail Settings].
- 4 Specify the settings for E-Mail Print.

■ When performing E-Mail Print by using SMTP protocol

If e-mails are sent to the machine via SMTP, the machine prints the e-mails immediately after receiving them. Enable this function when you want to forward fax documents from Canon multifunction printers to this machine and print them on the machine.



The screenshot shows the 'Network Settings - E-Mail Settings' page. The 'SMTP RX' checkbox is highlighted with a red box. The page includes the following fields and sections:

- SMTP/POP Settings:**
 - SMTP RX (highlighted)
 - POP RX
 - POP Server: [Text Field]
 - POP Login Name: [Text Field]
 - POP Password: [Text Field]
 - Confirm: [Text Field]
 - POP Interval: [0] Min. (0-99)
- Specify Port Number for POP RX:**
 - POP RX: [113] (1-65535)
- Authentication/Encryption Settings:**
 - Allow TLS (POP)
 - POP Authentication Method: [Normal]
 - Confirm TLS Certificate for POP RX
 - Add CN to Verification Bases
 - Allow TLS (SMTP RX): [Off]

[SMTP RX]

Select the check box to enable E-Mail Print by using the SMTP protocol.

■ When performing E-Mail Print from POP mail server

When the e-mail receiving starts, all e-mails stored in the mailbox of the mail server are printed. If you send e-mails that you want to print to the machine in advance, you can automatically print the e-mails at regular time intervals or print all stored e-mails in an arbitrary timing.

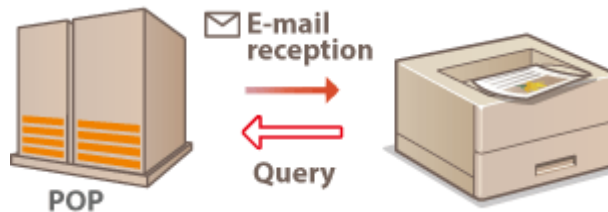

! IMPORTANT:

- We recommend using the mail address exclusively for E-Mail Print because all e-mails received into the machine are deleted from the mail server.

Conditions of use for POP protocol

- The POP mail server must support the UIDL command. For details, contact your network administrator or server administrator.

[POP RX]

Select the check box to enable E-Mail Print from the POP mail server. You can also specify this setting by using <Use POP RX> in the setting menu of the control panel.

[POP Server]

Enter the mail server name or IP address for receiving e-mails.

[POP Login Name]

Enter up to 32 alphanumeric characters for the user name used to connect to the mail server.

[POP Password]/[Confirm]

When setting a password for connecting to the mail server, enter the same password in [POP Password] and [Confirm] using up to 32 alphanumeric characters.

[POP Interval]

Specify the interval for automatically connecting to the mail server in minutes. New e-mails in the mailbox of the mail server are automatically received and printed at the specified time intervals. You can also specify this setting by using <POP Interval> in the setting menu of the control panel.

NOTE:

Preventing E-mails from Being Automatically Received

- Set [POP Interval] to [0]. If you set [0], you must manually receive e-mails.

[POP RX]

Specify the port number of the mail server that receives e-mails.

■ Setting authentication and encryption

The screenshot shows the 'Network Settings - E-Mail Settings' interface. The 'Authentication/Encryption Settings' section is highlighted with a yellow box. It contains the following settings:

- Allow TLS (POP)
- POP Authentication Method: Normal
- Confirm TLS Certificate for POP RX
 - Add CN to Verification Items
- Allow TLS (SMTP RX): Off

[Allow TLS (POP)]

Select the check box to encrypt the communication with the POP server using TLS.

[POP Authentication Method]

Set the authentication method of the POP server. Select [APOP] to encrypt the password when performing authentication or [POP AUTH] to perform user authentication via e-mail reception (POP).

[Confirm TLS Certificate for POP RX]

Select the check box to confirm whether the TLS server certificate is valid when receiving with POP. The machine verifies that the certificate has not expired or been revoked and checks the certificate chain for problems.

[Add CN to Verification Items]

Select the check box to also check the CN (Common Name) when checking the certificate used for POP reception.

[Allow TLS (SMTP RX)]

Select [Always TLS] or [On] to encrypt communication with TLS when receiving e-mail or I-fax using the SMTP server function.

5 Click [OK].

Basic Operations

Basic Operations	49
Parts and Their Functions	51
Front Side	52
Back Side	55
Interior	56
Multi-Purpose Tray	57
Paper Drawer	58
Control Panel	59
Turning ON the Machine	61
Turning OFF the Machine	62
Loading Paper	63
Basic Paper Loading Method	64
Loading Envelopes	72
Loading Postcards	76
Loading Preprinted Paper	78
Using the Control Panel	80
Basic Screens	81
Items Displayed on the <Home> Screen	83
Basic Operation	85
Entering Characters	88
Logging into the Machine	90
Specifying Paper Size and Type	91
Specifying Paper Size and Type in the Paper Drawer	92
Specifying Paper Size and Type in the Multi-purpose Tray	94
Registering Frequently Used Paper Size and Type for the Multi-purpose Tray	96
Registering Free Size Paper (Custom Size Paper)	98
Automatically Selecting the Appropriate Paper Source for a Specific Function	99
Customizing the Display	100
Customizing the <Home> Screen	101
Switching the Displayed Language	102
Setting Sounds	103
Entering Sleep Mode	104

Basic Operations

7L2J-014

This chapter describes basic operations, such as how to use the control panel or how to load the paper, that are frequently performed to use the functions of the machine.

■ Parts and Their Functions

This section describes the exterior and interior parts of the machine and their functions, as well as how to use the keys on the control panel and how to view the display. ▶ **Parts and Their Functions(P. 51)**

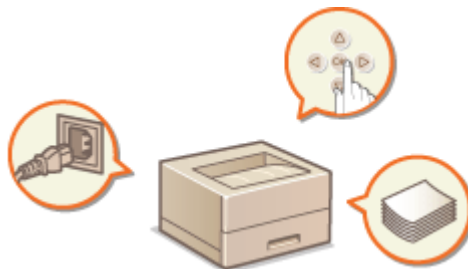

■ Turning ON the Machine

This section describes how to turn the machine ON or OFF. ▶ **Turning ON the Machine(P. 61)**



■ Using the Control Panel

This section describes how to use the keys on the control panel to perform various operations, such as adjusting and checking the settings. ▶ **Using the Control Panel(P. 80)**



■ Logging into the Machine

This section describes how to log in when a login screen is displayed. ▶ **Logging into the Machine(P. 90)**



■ Loading Paper

This section describes how to load the paper into the paper drawer and multi-purpose tray. ▶ **Loading Paper(P. 63)**

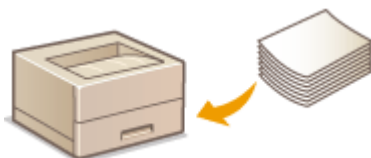

■ Customizing the <Home> Screen

This section describes how to rearrange the displayed items in order to make it easier to use screens shown in the <Home> Screen. ▶ **Customizing the <Home> Screen(P. 101)**



■ Specifying the Sound Settings

This section describes how to adjust the volume of various machine sounds, such as those produced when an error occurs. ▶ **Setting Sounds(P. 103)**



■ Entering Sleep Mode

This section describes how to set sleep mode. ▶ **Entering Sleep Mode(P. 104)**



Parts and Their Functions

7L2J-015

This section describes the parts of the machine (front side and interior) and how they function. This section also describes how to load paper, as well as the names and usage of the keys on the control panel. Read this section for tips on how to use the machine properly.



- ▶ **Front Side(P. 52)**
- ▶ **Back Side(P. 55)**
- ▶ **Interior(P. 56)**
- ▶ **Multi-Purpose Tray(P. 57)**
- ▶ **Paper Drawer(P. 58)**
- ▶ **Control Panel(P. 59)**

Front Side

7L2J-016

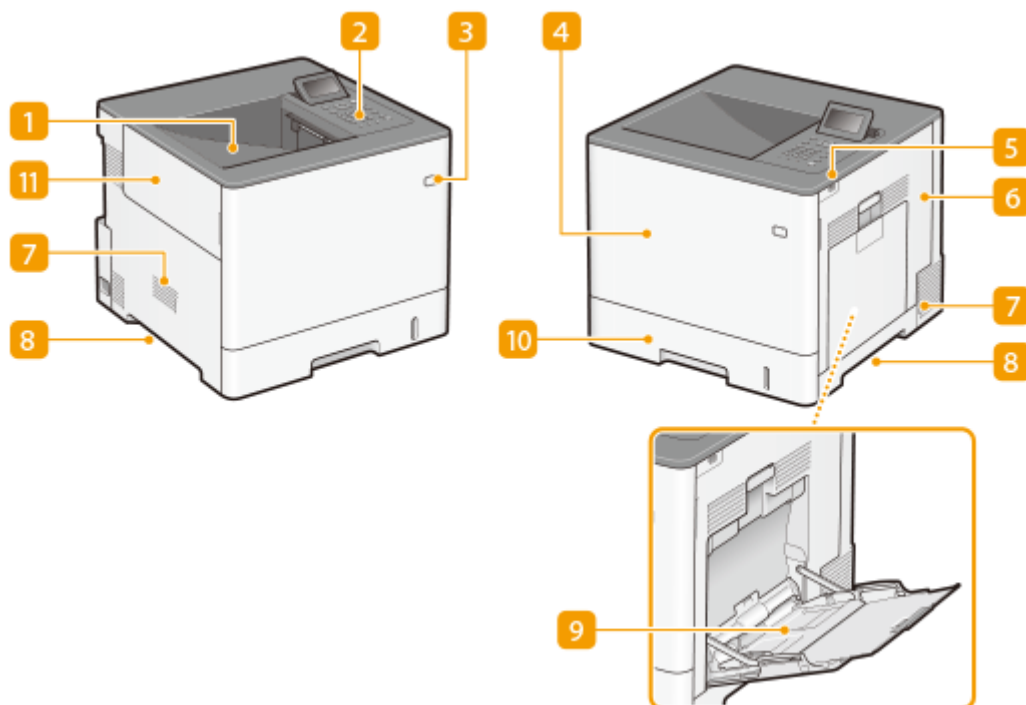

1 Output tray

Printed paper is output to the output tray.

2 Control Panel

The control panel consists of numeric keys, a display, status indicators, etc. You can perform all the operations and specify settings from the control panel.

- ▶ **Control Panel(P. 59)**
- ▶ **Basic Screens(P. 81)**

3 Power switch

Press the power switch to turn ON and turn OFF the machine.

- ▶ **Turning ON the Machine(P. 61)**
- ▶ **Turning OFF the Machine(P. 62)**

4 Front cover

Open the front cover when replacing toner cartridges. ▶ **Replacing the Toner Cartridge(P. 411)**

5 USB memory port (Front-right side of the machine)

You can connect devices such as a USB memory device to the machine. ▶ **Connecting a USB Memory Device(P. 53)**

! IMPORTANT:

- Do not connect an IC card reader to this port. Connect it to the port on the back side of the machine which is for connecting a USB device.

NOTE:

- Some types of memory media may not be able to save data correctly.
- The USB port (front-right side of the machine) supports USB 2.0.

6 Right cover

Open the right cover when clearing paper jams. ▶ **Clearing Paper Jams(P. 485)**

7 Ventilation slot

Air from inside the machine is vented out to cool down the inside of the machine. Note that placing objects in front of the ventilation slots prevents ventilation.

8 Lift handles

Hold the lift handles when carrying the machine.

9 Multi-purpose tray

Load the paper into the multi-purpose tray when you want to temporarily use a type of paper different from that which is loaded in the paper drawer.

- ▶ **Multi-Purpose Tray(P. 57)**
- ▶ **Basic Paper Loading Method(P. 64)**

10 Paper drawer

Load the type of paper you frequently use into the paper drawer.

- ▶ **Paper Drawer(P. 58)**
- ▶ **Basic Paper Loading Method(P. 64)**

11 Left cover

Open the left cover when replacing the waste toner container.

Connecting a USB Memory Device

You can connect a USB memory device to the USB port located on the right side of the machine, and directly print data from the USB memory device.

- ▶ **Using Memory Media(P. 136)**

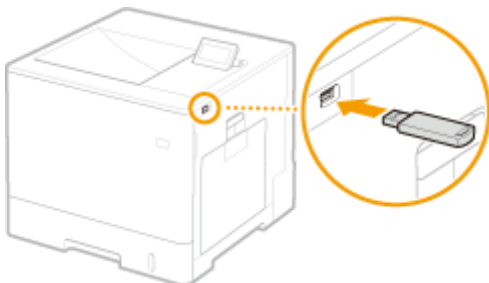
**! IMPORTANT**

- Make sure that the USB memory device is oriented properly when connecting it to the machine. If it is not connected properly, it may cause the USB memory device or machine to malfunction.

- Make sure to follow the proper procedure when removing the USB memory device. **Inserting/Removing Memory Media(P. 136)** Failure to do so may cause the USB memory device or machine to malfunction.
- The machine only supports FAT32/exFAT format USB memory devices.

NOTE

Unsupported devices and usages

- Memory media with security functions
- Memory media that does not meet the USB specification
- Memory card readers connected via USB
- Connecting memory media via an extension cable
- Connecting memory media via a USB hub

Back Side

7L2J-017

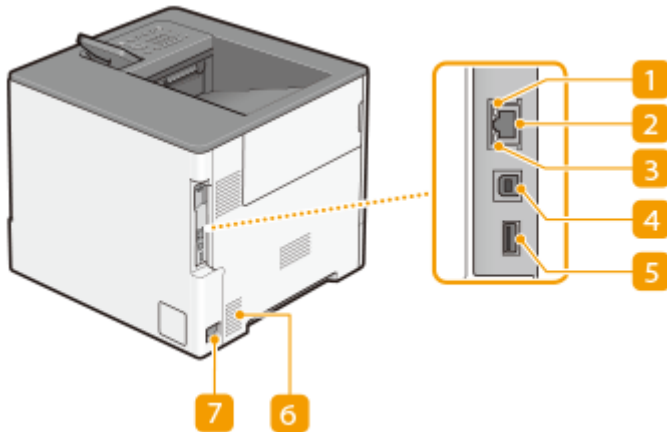

1 ACT indicator

The ACT indicator blinks while data is being sent or received.

2 LAN port

Connect a LAN cable when connecting the machine to a wired LAN router, etc. ▶ **Setting up the Network Environment**(P. 8)

3 LNK indicator

The LNK indicator blinks green when the machine is properly connected to a network.

4 USB port (for computer connection)

Connect a USB cable when connecting the machine and a computer.

NOTE:

- The USB port (for computer connection) supports USB 2.0.

5 USB port (for USB device connection)

You can connect devices such as an IC card reader or an external hard disk to the machine.

NOTE:

- The USB port (for USB device connection) supports USB 2.0.

6 Ventilation slot

Air from inside the machine is vented out to cool down the inside of the machine. Note that placing objects in front of the ventilation slots prevents ventilation.

7 Power socket

Connect the power cord.

Interior

7L2J-018

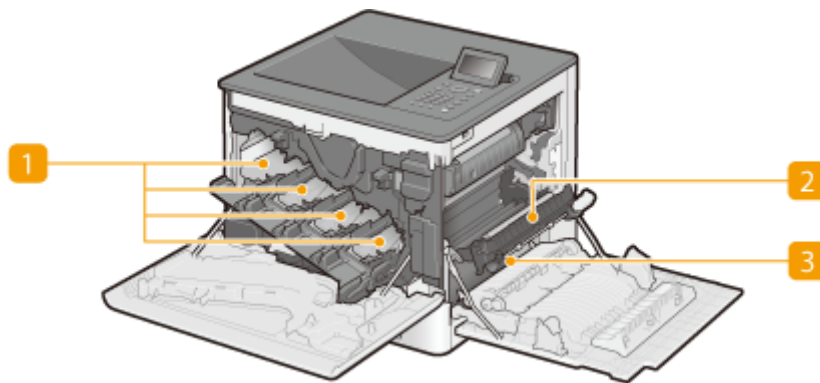

1 Toner Cartridge slots

Load the toner cartridges in these slots: Y (yellow) in the leftmost slot, followed by M (magenta), C (cyan), and K (black). ▶ **Replacing the Toner Cartridge(P. 411)**

2 Transfer unit

If there is a paper jam inside the machine, raise the transport guide to remove the jammed paper. ▶ **Clearing Paper Jams(P. 485)**

3 Transport guide

If paper has jammed inside the machine, lift up the transfer unit and open this guide to remove the jammed paper. ▶ **Clearing Paper Jams(P. 485)**

Multi-Purpose Tray

7L2J-019

Use the multi-purpose tray when you want to print on a type of paper that is not loaded in the paper drawer, such as labels or envelopes.

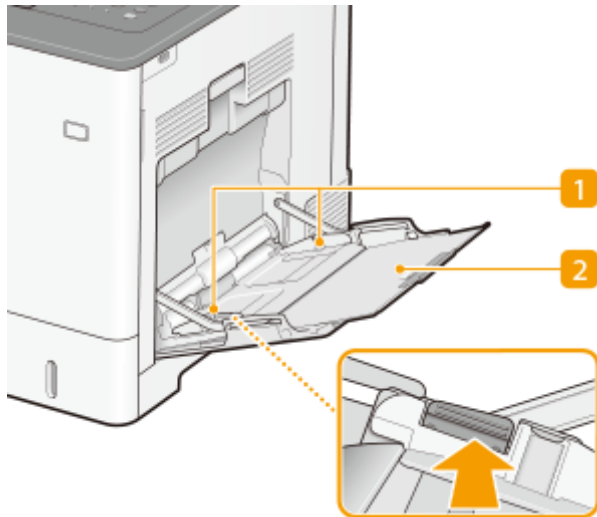

1 Paper guides

Adjust the paper guides to exactly the width of the loaded paper to ensure that paper is fed straight into the machine. Press the lock release lever that is marked with arrow in the illustration to release the lock and slide the paper guides.

2 Paper tray

Pull out the paper tray when loading paper.

LINKS

- ▶ [Loading Paper in the Multi-Purpose Tray\(P. 68\)](#)
- ▶ [Loading Envelopes in the Multi-Purpose Tray\(P. 74\)](#)
- ▶ [Loading Postcards in the Multi-Purpose Tray\(P. 76\)](#)

Paper Drawer

7L2J-01A

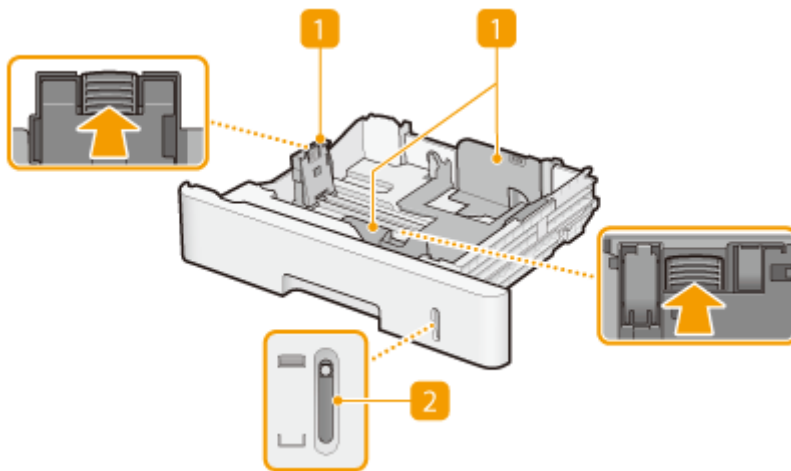

1 Paper guides

Adjust the paper guides to exactly the size of the loaded paper to ensure that paper is fed straight into the machine. Press the lock release levers that are marked with arrows in the illustrations to release the locks and slide the paper guides.

2 Paper level indicator

Indicates the remaining amount of paper. The mark moves downward as the remaining amount of paper decreases.

LINKS

▶ [Loading Paper in the Paper Drawer\(P. 64\)](#)

Control Panel

7L2J-01C

This section describes the names and usage of the keys on the control panel.

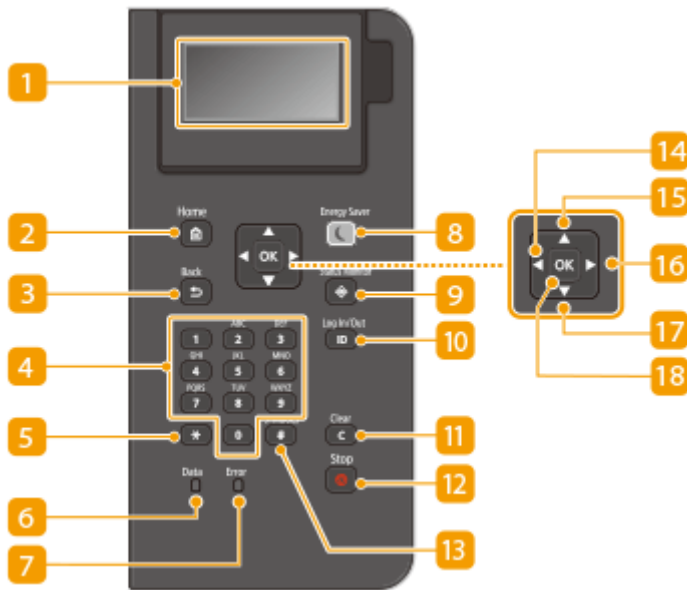

1 Display

You can view the operation and error statuses of this machine, the amount remaining in the toner cartridges, and other conditions. ▶ **Basic Screens(P. 81)**

2 Home key

Press to display the Home screen, which provides access to the setting menu and functions such as Memory Media Print and paper settings. ▶ **Items Displayed on the <Home> Screen(P. 83)**

3 Back key

Press to return to the previous screen. If you press this key when specifying settings, for example, the settings are not applied and the display returns to the previous screen.

4 Numeric keys ([0]-[9] keys)

Press to enter numbers and text. ▶ **Entering Characters(P. 88)**

5 [*] key

Press to switch the type of text that is entered.

6 Data indicator

Blinks while an operation is being performed, such as data transmission or printing. Remains steadily lit when there are documents waiting to be processed.

7 Error indicator

Blinks or lights up when an error such as a paper jam occurs.

IMPORTANT:

- If the Error indicator blinks, follow the instructions that appear on the display.  **Troubleshooting(P. 438)**
- If the Error indicator remains steadily lit, contact your dealer or service representative.

8 Energy Saver key

Press to put the machine into sleep mode. The key lights up green when the machine is in sleep mode. Press the key again to exit sleep mode.  **Entering Sleep Mode(P. 104)**

9 Status Monitor key

Press to check the printing status, to view the usage history, or to view the network settings such as the IP address of the machine. You can also check the status of the machine, such as the remaining amount of paper and the amount remaining in the toner cartridges, or whether any errors occurred.  **<Status Monitor> Screen(P. 81)**

10 [ID] key

Press after entering the ID and PIN to log on when Department ID Management is enabled. After you finish using the machine, press this key again to log off.  **Logging into the Machine(P. 90)**

11 Clear key

Press to delete the entered numbers and text.

12 Stop key

Press to cancel printing and other operations.

13 [#] key

Press to enter symbols such as "@" or "/".

14 [◀] key

When specifying settings, press to return to the previous screen. When entering numbers, press to move the cursor to the left.

15 [▲] key

When specifying settings, press to select the item immediately above the currently selected item. When changing setting values, press to increase a value.

16 [▶] key

When specifying settings, press to proceed to the next screen. When entering numbers, press to move the cursor to the right.

17 [▼] key

When specifying settings, press to select the item immediately below the currently selected item. When changing setting values, press to decrease a value.

18 [OK] key

Press to apply settings or specified details.

Turning ON the Machine

7L2J-01E

This section describes how to turn ON the machine.

1 Make sure that the power plug is firmly inserted into the power outlet.

2 Press the power switch.

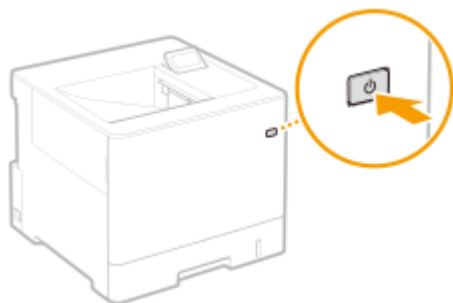

⇒ The startup screen appears on the display.

NOTE

- You can select the screen displayed immediately after the machine is turned ON. ▶<Default Screen After Startup/Restoration>(P. 356)
- The response of the keys on the control panel may not be optimal immediately after the machine is turned ON.
- If the machine is connected to a powered off Mac computer by USB cable, the computer may turn on automatically when this machine does. In this case, disconnect the USB cable from the machine. You may also be able to solve this problem by using a USB hub between the machine and the computer.

LINKS

▶Turning OFF the Machine(P. 62)

Turning OFF the Machine

7L2J-01F

This section describes how to turn OFF the machine.

NOTE

- You can shut down the machine from the Remote UI. ▶ [Turning OFF/Restarting the Machine\(P. 269\)](#)

1 Press the power switch.

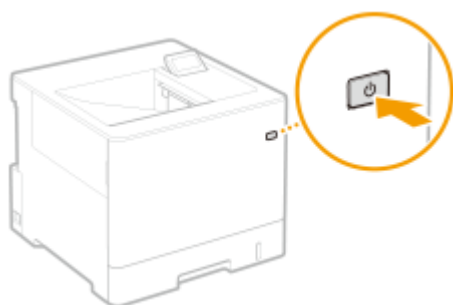

NOTE

- The machine may take some time to completely shut down. Do not remove the power plug until the display and indicators turn OFF.
- To restart the machine, wait for at least 10 seconds after the system is turned off, and then turn the machine back ON. When <Quick Startup Settings for Main Power> is enabled, wait for at least 20 seconds to restart the machine. ▶ [<Quick Startup Settings for Main Power>\(P. 358\)](#)

LINKS

▶ [Turning ON the Machine\(P. 61\)](#)

Loading Paper

7L2J-01H

You can load the paper into the paper drawer or multi-purpose tray. For more information about available paper types and sizes, see [▶Available Paper\(P. 534\)](#) . To obtain the optimum printing results, make sure to correctly specify the size and type of paper that is loaded. [▶Specifying Paper Size and Type\(P. 91\)](#)



- ▶[Basic Paper Loading Method\(P. 64\)](#)
- ▶[Loading Envelopes\(P. 72\)](#)
- ▶[Loading Postcards\(P. 76\)](#)
- ▶[Loading Preprinted Paper\(P. 78\)](#)

IMPORTANT

- Before using any paper, confirm the precautions regarding paper and the correct way to store it. ▶ [Available Paper\(P. 534\)](#)
- Loading paper while stock remains may cause a multiple sheet feed or a paper jam. If there is paper remaining, it is recommended that you wait until all of it has been used before loading more paper.
- Do not load different sizes or types of paper together.

LINKS

- ▶[Registering Free Size Paper \(Custom Size Paper\)\(P. 98\)](#)
- ▶[Paper Feeder PF-D\(P. 545\)](#)
- ▶[Cassette Feeding Unit-AV\(P. 546\)](#)

Basic Paper Loading Method

This section describes the general method for loading paper such as plain or recycled paper. Load frequently used paper types or sizes in the paper drawer. When temporarily using paper that is not loaded in the paper drawer, load it in the multi-purpose tray.

▶ **Loading Paper in the Paper Drawer(P. 64)**

▶ **Loading Paper in the Multi-Purpose Tray(P. 68)**

NOTE

- For the optional Paper Feeder PF-D or Cassette Feeding Unit-AV, follow the procedure of paper drawer to load paper.
- If there are instructions on the paper package about which side of the paper to load, follow those instructions.
- Paper may overlap when it is fed or a paper jam may occur, depending on the cut surface of the paper. Changing the paper orientation and loading it again may reduce the effect of the cut surface.
- If paper runs out and printing is stopped, load a new paper stack. Printing restarts after the new paper stack is loaded.



Loading Paper in the Paper Drawer

▶ **Loading Standard Size Paper(P. 64)**

▶ **Loading a Custom Size Paper(P. 66)**

Paper Orientation

See the table below to load available paper in correct orientation.

Paper	Orientation
A4, B5, A5 (landscape), A6, Legal*, Letter, Statement, Executive, Oficio*, Brazil-Oficio*, Mexico-Oficio*, Government Letter, Government Legal*, Australia Foolscap*, Foolscap/Folio*, 16K, F4A*, Indian-Legal*, Custom (landscape), Free (landscape)	
A5 (portrait), Custom (portrait), Free (portrait)	

* Can be loaded only in the optional Paper Feeder PF-D or Cassette Feeding Unit-AV.

■ Loading Standard Size Paper

To load paper whose size is found in the paper size markings on the paper drawer, use the following procedure. For paper whose size is not found in the paper size markings, see ▶ **Loading a Custom Size Paper(P. 66)** .

1 Pull out the paper drawer until it stops.

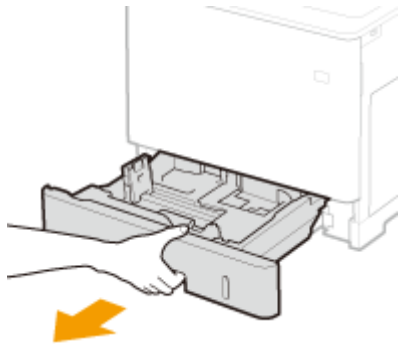

2 Adjust the positions of the paper guides to the paper size you want to use.

- Press the lock release lever (a) to align the projection (b) to the appropriate paper size marking.

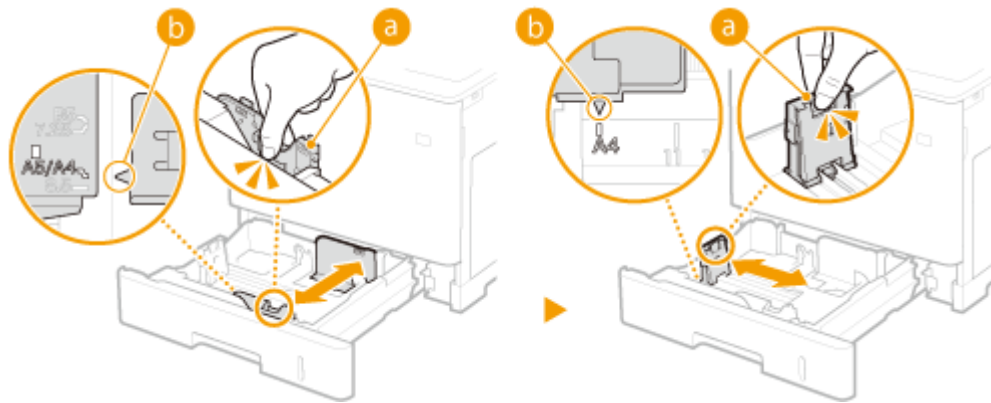

3 Load the paper so that the edge of the paper stack is aligned against the paper guide on the left side of the paper drawer.

- Insert the paper with the print side face up.
- Fan the paper stack well, and tap it on a flat surface to align the edges.

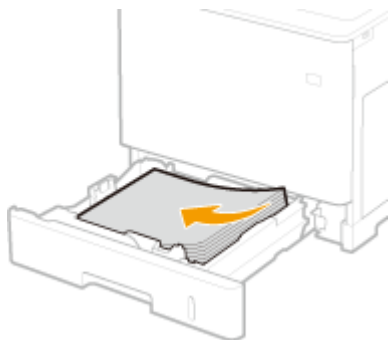

! IMPORTANT:

Do not exceed the load limit line when loading paper

- Make sure that the paper stack does not exceed the load limit line (a). Loading too much paper can cause paper jams.

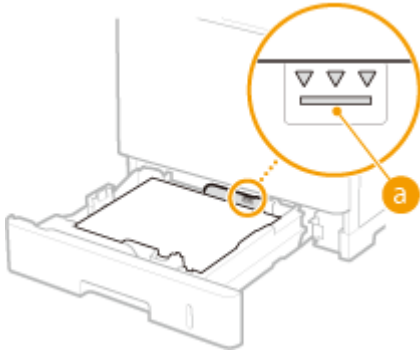
**NOTE:**

- When loading paper with a logo, see **▶Loading Preprinted Paper(P. 78)** .

4 Set the paper drawer.

» Continue to **▶Specifying Paper Size and Type in the Paper Drawer(P. 92)**

! IMPORTANT:**When changing the paper size or type**

- The factory default settings for paper size and type are <A4> and <Free>, respectively. If you load a different size or type of paper into the machine, make sure to change the setting. If you do not change the paper size or type setting, the machine cannot print properly.

TIPS**Printing on the back side of printed paper (2nd Side of 2-Sided Page)**

- You can print on the back side of printed paper. Flatten any curls on the printed paper and insert it into the multi-purpose tray, with the side to print face down (previously printed side face up). Then select the paper type and select <Yes> for <Enable settings for 2nd side of 2-sided page?>.
- Use only the paper printed with this machine.

■ Loading a Custom Size Paper

To load custom size paper or other paper whose size is not found in the paper size markings on the paper drawer, use the following procedure.

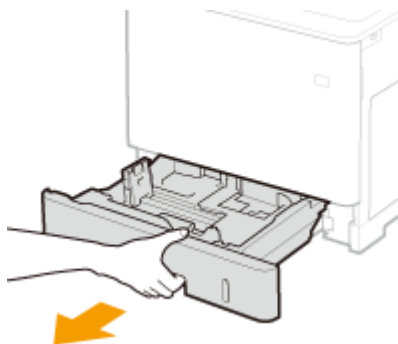
1 Pull out the paper drawer until it stops.

2 Slide the paper guides apart.

- Press the lock release lever to slide the paper guides outward.

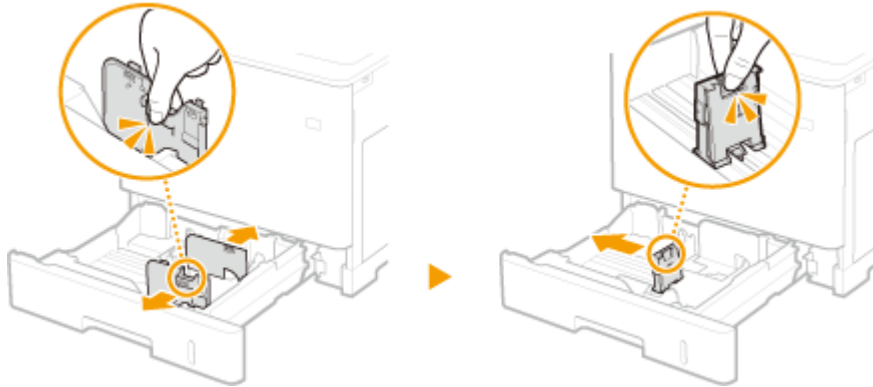

3 Load the paper so that the edge of the paper stack is aligned against the right side of the paper drawer.

- Place the paper stack with the print side face up.
- Fan the paper stack well, and tap it on a flat surface to align the edges.

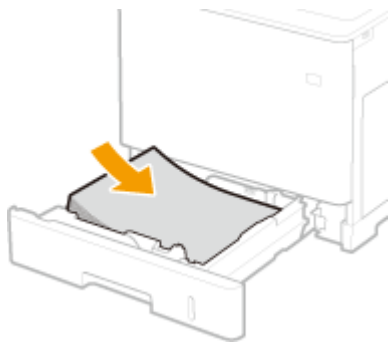

! IMPORTANT:

Do not exceed the load limit line when loading paper

- Make sure that the paper stack does not exceed the load limit line (a). Loading too much paper can cause paper jams.

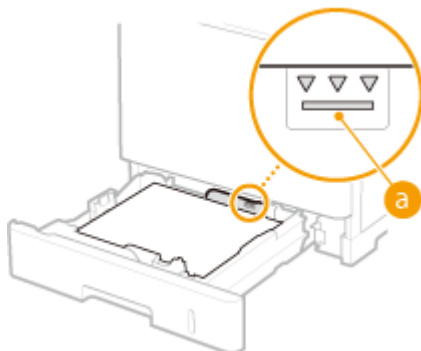

NOTE:

- When loading paper with a logo, see ▶ Loading Preprinted Paper(P. 78) .

4 Align the paper guides against the edges of the paper.

- Press the lock release lever and slide the paper guides inward until they are aligned securely against the edges of the paper.

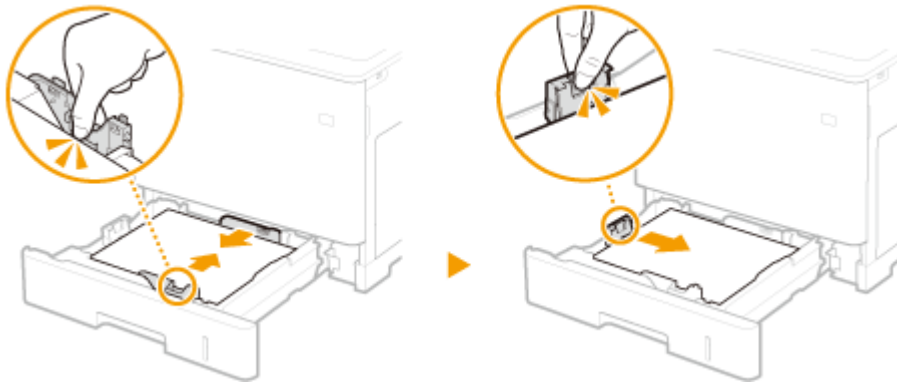

! IMPORTANT:

Align the paper guides securely against the edges of the paper

- Paper guides that are too loose or too tight can cause misfeeds or paper jams.

5 Set the paper drawer.

» Continue to **Specifying Paper Size and Type in the Paper Drawer(P. 92)**

! IMPORTANT:

When changing the paper size or type

- If you load a different size or type of paper into the machine, make sure to change the settings. If you do not change the paper size or type setting, the machine cannot print properly.

TIPS

Printing on the back side of printed paper (2nd Side of 2-Sided Page)

- You can print on the back side of printed paper. Flatten any curls on the printed paper and insert it into the multi-purpose tray, with the side to print face down (previously printed side face up). Then select the paper type and select <Yes> for <Enable settings for 2nd side of 2-sided page?>.
- Use only the paper printed with this machine.

Loading Paper in the Multi-Purpose Tray

Paper Orientation

See the table below to load available paper in correct orientation.

Paper	Orientation
A4, B5, A5 (landscape), A6, Legal, Letter, Statement, Executive, Oficio, Brazil-Oficio, Mexico-Oficio, Government Letter, Government Legal, Australia Foolschap, Foolschap/Folio, 16K, F4A, Indian-Legal, Custom (landscape), Free (landscape), Postcard, Reply Postcard, 4 on 1 Postcard, Envelope	
A5 (portrait), Custom (portrait), Free (portrait)	

1 Open the cover.



2 Pull out the paper tray.



3 Spread the paper guides apart.

- Press the lock release lever to slide the paper guides outward.

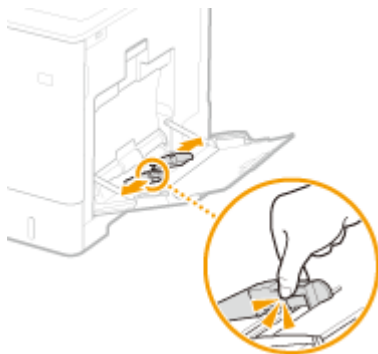

4 Insert the paper into the multi-purpose tray until the paper stops.

- Insert the paper with the print side face down.
- Fan the paper stack well, and tap it on a flat surface to align the edges.



! IMPORTANT:

Do not exceed the load limit guide when loading paper

- Make sure that the paper stack does not exceed the load limit guide (**a**). Loading too much paper can cause paper jams.

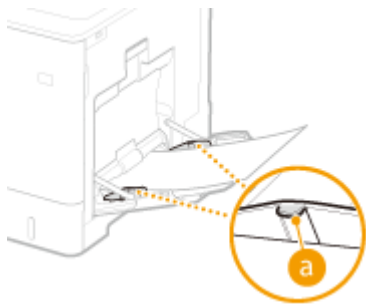
**NOTE:**

- If you use envelopes, postcards or paper with a logo mark, pay attention to the orientation when loading them in the paper source.
 - ▶ **Loading Envelopes(P. 72)**
 - ▶ **Loading Postcards(P. 76)**
 - ▶ **Loading Preprinted Paper(P. 78)**

5 Align the paper guides against the edges of the paper.

- Press the lock release lever and slide the paper guides inward until they are aligned securely against the edges of the paper.

**! IMPORTANT:**

Align the paper guides securely against the edges of the paper

- Paper guides that are too loose or too tight can cause misfeeds or paper jams.

» Continue to ▶ Specifying Paper Size and Type in the Multi-purpose Tray(P. 94)**! IMPORTANT:**

When changing the paper size or type

- If you load a different size or type of paper into the machine, make sure to change the setting. If you do not change the paper size or type setting, the machine cannot print properly.

TIPS**Printing on the back side of printed paper (2nd Side of 2-Sided Page)**

- You can print on the back side of printed paper. Flatten any curls on the printed paper and insert it into the multi-purpose tray, with the side to print face down (previously printed side face up). Then select the paper type and select <Yes> for <Enable settings for 2nd side of 2-sided page?>.
- Use only the paper printed with this machine.

LINKS

▶ **Available Paper(P. 534)**

Loading Envelopes

7L2J-01K

Load envelopes in the paper drawer or multi-purpose tray. When printing on envelopes, to prevent paper jams and wrinkles, make sure to flatten any curls on envelopes before loading them. Also pay attention to the orientation of envelopes and which side is face up.

▶ **Before Loading Envelopes(P. 72)**

▶ **Loading Envelopes in the Multi-Purpose Tray(P. 74)**

NOTE

- This section describes how to load envelopes with the proper orientation, as well as procedures that you need to complete before loading envelopes. For a description of the general procedure for loading envelopes in the multi-purpose tray, see ▶ **Basic Paper Loading Method(P. 64)** .

Before Loading Envelopes

Follow the procedure below to prepare the envelopes before loading.

! IMPORTANT

- Do not use envelopes that have glue attached to their flaps, as the glue may melt due to the heat and pressure of the fixing unit.
- Envelopes may become creased, depending on the type of envelopes or the conditions in which they are stored.
- Streaks may appear where envelopes overlap.

1 Flatten any curls.

- Pick up about five envelopes. Flatten any curls, and loosen the stiff areas in the four corners.

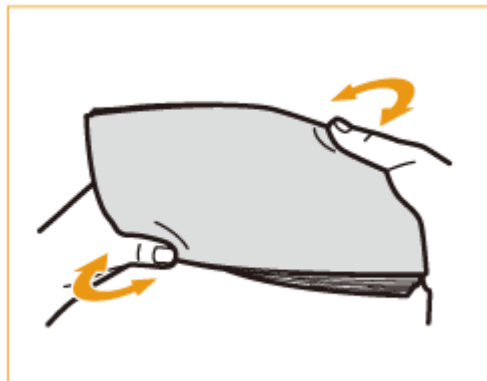

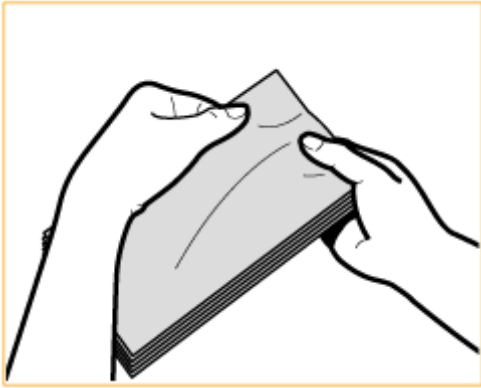

- Repeat this step five times for each set of five envelopes.

2 Smooth the envelopes out, and remove any air inside them.

- Place the envelopes on a flat surface, and move your hands in the direction of the arrows to remove the air inside the envelopes.

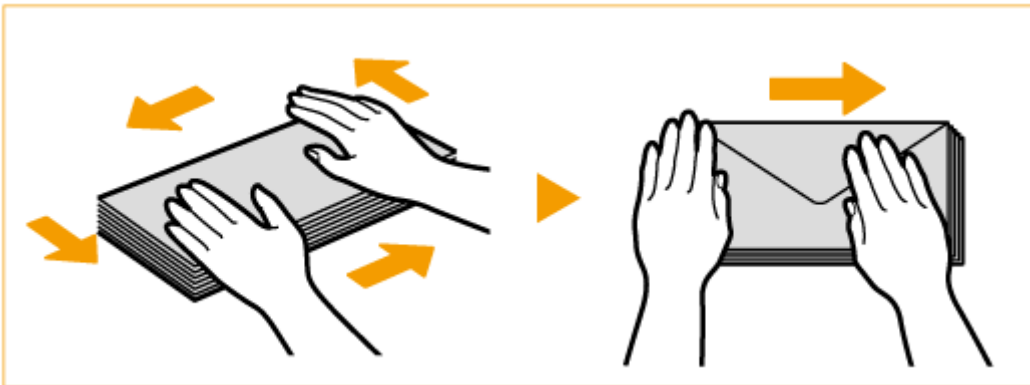

- Repeat this step five times for each set of five envelopes.

3 Press down on the four sides.

- Press down firmly on all four sides. In particular, carefully press down on the side facing the direction in which the envelopes will be fed. Press down firmly so that the flap stays flat.



! IMPORTANT:

- Failure to firmly press down on the flap may result in a paper jam. If this happens, press down firmly on all four sides of each individual envelope.

4 Align the envelopes on a flat surface.

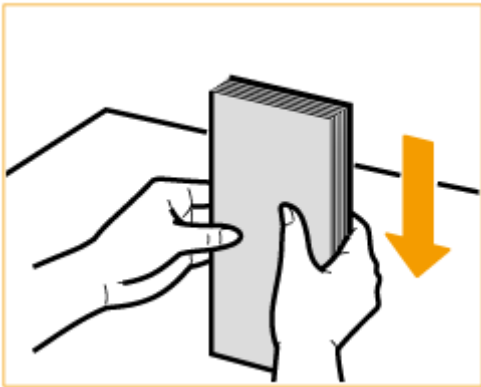

NOTE:

- Check that no envelopes are tucked underneath the flap of the envelope above or below them.

Loading Envelopes in the Multi-Purpose Tray

Load the envelopes as indicated below, with the front side of the envelopes (the side without the glued areas) face down (recommended).

Yougatanaga 3, ISO-5, Monarch, No.10, DL

Close the flaps, and load the envelopes so that their flaps are on the near side.

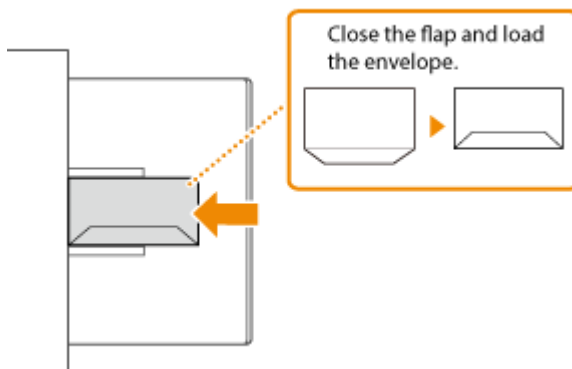

Nagagata 3

Load the envelopes so that their flaps are on the right side.

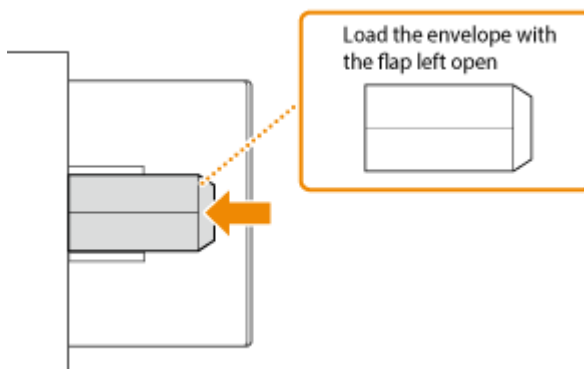

IMPORTANT

- Make sure that the paper stack does not exceed the load limit guide. If the envelopes are not fed properly even if they have been prepared according to the procedures, load the envelopes individually in the multi-purpose tray instead of loading several envelopes together.
- Do not print on the reverse side of the envelopes (the side with the glued areas).

NOTE

- When you print on envelopes, remove them from the output tray 10 at a time.

Loading Postcards

7L2J-01R

Before loading postcards, make some preparations such as flattening any curls on them. Also pay attention to the orientation of postcards and which side is face up.

▶ **Before Loading Postcards(P. 76)**

▶ **Loading Postcards in the Multi-Purpose Tray(P. 76)**

NOTE

- This section describes how to load postcards with the proper orientation, as well as procedures that you need to complete before loading postcards. For a description of the general procedure for loading postcards in the multi-purpose tray, see ▶ **Basic Paper Loading Method(P. 64)** .

Before Loading Postcards

Before loading the postcards, flatten any curls on them. With curls remaining, printouts may be skewed or images may be printed distorted. If the postcards curl downward, a paper jam is more likely to occur.

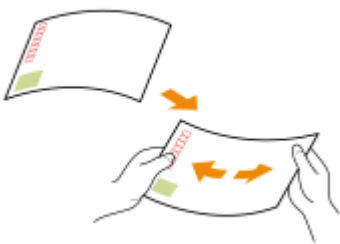

! IMPORTANT

- The inkjet printable postcard cannot be used.

Loading Postcards in the Multi-Purpose Tray

Like the images below, insert the postcard with the print side face down.

Postcard

Insert the postcard with the upper end to the left.

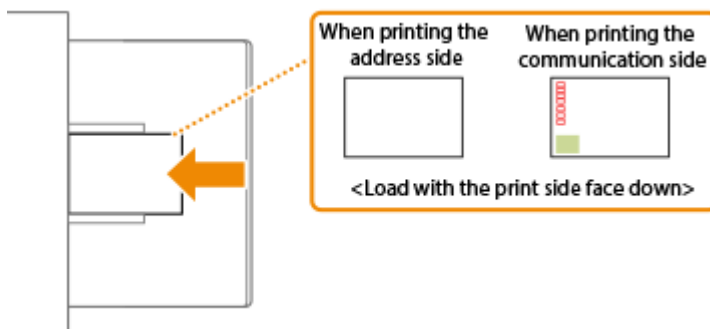

Reply Postcard

Unfold the postcard and insert it with the upper end toward you.

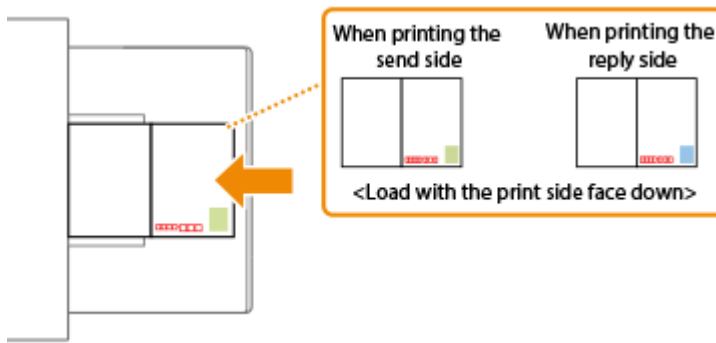

4 on 1 Postcard

Insert the postcard with the upper end to the left.

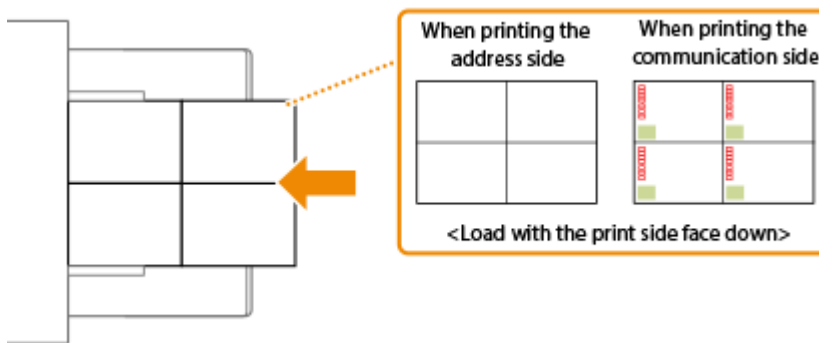

! IMPORTANT

- Do not exceed the load limit guide when loading postcards. If the postcards are not fed properly, even if they have been prepared according to the procedures, load the postcards individually in the multi-purpose tray instead of loading several sheets together.

Loading Preprinted Paper

7L2J-01L

When you load paper that has been preprinted with a logo, pay attention to the orientation of the paper regardless of whether you use the paper drawer or the multi-purpose tray. Load the paper properly so that printing is performed on the same side as the logo.



- ▶ Loading Paper with Logos in the Paper Drawer(P. 78)
- ▶ Loading Paper with Logos in the Multi-Purpose Tray(P. 79)

NOTE

- This section describes how to load preprinted paper with the proper orientation. For a description of the general procedure for loading paper in the paper drawer or multi-purpose tray, see ▶ **Basic Paper Loading Method(P. 64)** .
- Proper manner of loading preprinted paper when <Switch Paper Feed Method> is set to <Print Side Priority>
 - Paper drawer: the logo side face down
 - Paper source other than the paper drawer: the logo side face up

Loading Paper with Logos in the Paper Drawer

The loading method varies depending on whether the orientation of the logo printed paper is portrait or landscape. Load the paper with the logo printed side (the side to print) face up, as shown in the following illustrations.

Portrait orientation paper

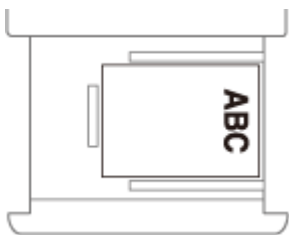

The printing results

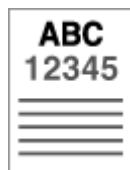

Landscape orientation paper

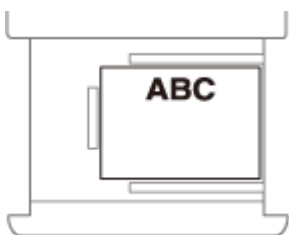

The printing results

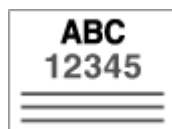

Loading Paper with Logos in the Multi-Purpose Tray

The loading method varies depending on whether the orientation of the logo printed paper is portrait or landscape. Load the paper with the logo printed side (the side to print) face down, as shown in the following illustrations.

Portrait orientation paper

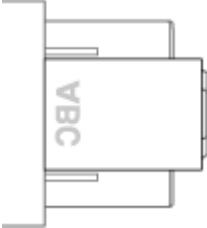

The printing results



Landscape orientation paper



The printing results

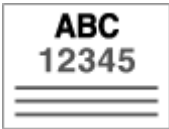

Using the Control Panel

7L2J-01S

You can use the display and keys of the control panel to configure machine settings or operate functions. This section describes basic usage of the display and keys.



- ▶ [Basic Screens\(P. 81\)](#)
- ▶ [Basic Operation\(P. 85\)](#)
- ▶ [Entering Characters\(P. 88\)](#)

Adjust the brightness of the display

If it is hard to see the content of the display, adjust the brightness by operating the control panel.



<Set> ▶ <Preferences> ▶ <Accessibility> ▶ <Backlight Brightness> ▶ adjust the brightness
with ◀ or ▶ ▶ **OK**

LINKS

- ▶ [Control Panel\(P. 59\)](#)

Basic Screens

This section describes the various screens displayed on the display.

<Home> Screen

The <Home> screen is displayed when you press  (Home). The <Home> screen or settings screen appears on the display, allowing you to initiate functions such as <Memory Media> and <Mobile Portal>. You can also use the display to check information such as error messages and the machine's operation status. **▶Items Displayed on the <Home> Screen(P. 83)**

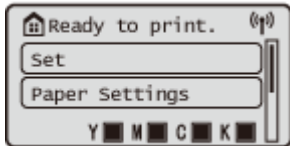

<Menu> Screen

Select <Set> to display the <Menu> screen. Press this button first to make changes for each setting, such as management settings, display settings, and network settings.

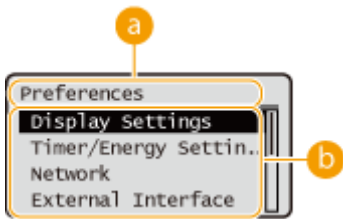

a Current menu level

The screen name of the current level is displayed.

b Setting item list

Setting items that belong to the current menu level are displayed in a list.

NOTE:

- When there is no menu under the lower level, the setting screen is displayed.

<Status Monitor> Screen

When you press  (Status Monitor), the <Status Monitor> screen is displayed. On this screen, you can check the printing status, as well as the remaining amount of toner and paper.

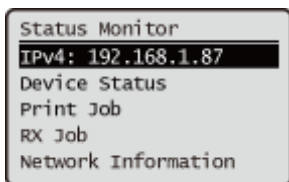

Error Screen

In some cases when an error occurs, instructions on how to respond to the error are displayed. Follow the on-screen instructions to solve the problem. ▶ **Countermeasures for Each Message(P. 453)**

Example: When a paper jam occurs

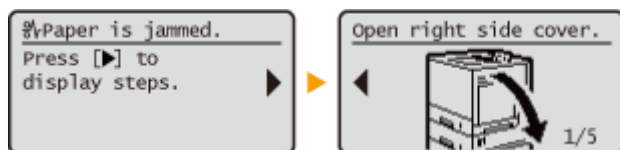

TIPS

- Select <Display Order (Home)> to customize the <Home> screen by rearranging the buttons. ▶ **Customizing the Display(P. 100)**

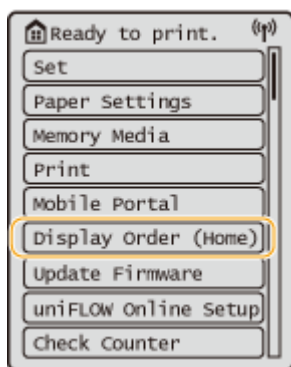

* <Update Firmware> may not be displayed depending on your country or region.

- You can change settings regarding the screen display, such as which screen appears immediately after turning ON the machine, and whether the message appears for remaining paper and toner. ▶ **<Display Settings>(P. 356)**
- You can set the screen to be displayed when a certain amount of time has passed without operation. ▶ **<Function After Auto Reset>(P. 359)**

LINKS

- ▶ **Control Panel(P. 59)**

Items Displayed on the <Home> Screen

7L2J-01W

This section describes the items displayed on the <Home> screen.

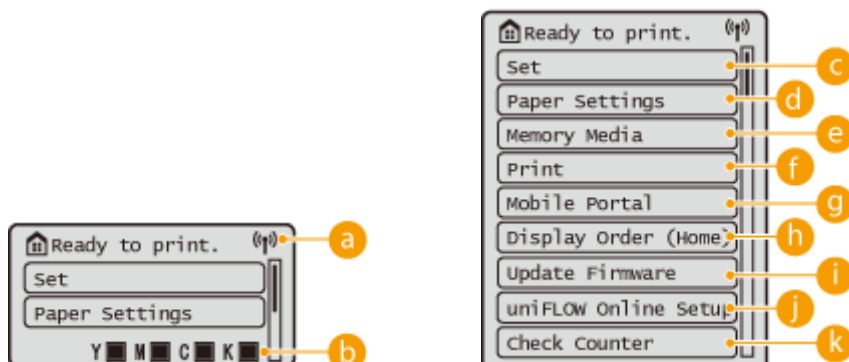

a Wi-Fi icon

This icon is displayed when the machine is connected to wireless LAN.

b Amount remaining in the toner cartridges

The toner levels of the toner cartridges are displayed. They are not displayed when operating the <Home> screen.

c <Set>

<Function Settings>, <Preferences>, and many other machine settings start from this button. [▶Settings/Registration\(P. 295\)](#)

d <Paper Settings>

This button enables you to specify the size and type of paper loaded in the paper drawer and multi-purpose tray. [▶Specifying Paper Size and Type\(P. 91\)](#)

e <Memory Media>

Select this to print files on USB memory. [▶Using Memory Media\(P. 136\)](#)

f <Print>

You can print documents held in the machine and check the status of print jobs.

g <Mobile Portal>

Select this to connect the machine to a mobile device. [▶Linking with Mobile Devices\(P. 142\)](#)

h <Display Order (Home)>

You can change the display order of the buttons on the <Home> screen. [▶Customizing the <Home> Screen\(P. 101\)](#)

i <Update Firmware>

You can update the firmware via the Internet. ▶ **Updating the Firmware(P. 279)**

j <uniFLOW Online Setup>

You can check the usage status of the device and the user by linking to cloud service. For more information, see the Canon website.

k <Check Counter>

You can display the total number of sheets printed in color and black-and-white. ▶ **Checking the Number of Pages for Print(P. 435)**

You can also check the serial number of the machine, the IP address, and other device information such as information on optional equipment.

NOTE

- <Update Firmware> may not be displayed depending on your country or region.

Basic Operation

7L2J-01X

Even though functions and settings are different, the operation methods for buttons displayed on the screen and the procedure to select items are the same. This section describes the operation methods for buttons frequently displayed on the screen as well as how to select items.



Using ▲ / ▼

■ Scrolling the Screen

The scroll bar is displayed on the right side of the screen when not all of the information fits on one screen. If the scroll bar is displayed, use ▲ / ▼ to scroll up or down. The text and background colors of an item are inverted when it is selected.

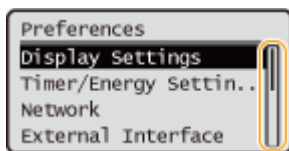

■ Changing Setting Values

Use ▲ / ▼ to enter values. If  is displayed at the upper left of the screen, you can enter values directly using the numeric keys. [▶ Entering Characters \(P. 88\)](#)

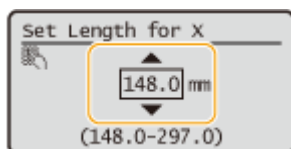

NOTE:

- Values in () displayed below the entry box are the enterable value range.

Using ◀ / ▶

■ Proceeding to the Next Screen/Returning to the Previous Screen

Press ▶ to proceed to the next screen. Press ◀ to return to the previous screen.



NOTE:

- You can also proceed to the next screen by pressing **OK**, and return to the previous screen by pressing **↶** (Back).

■ Changing Setting Values

Use ◀ / ▶ to adjust the slider scale.



■ Moving the Cursor

Use ◀ / ▶ to enter text and values. ▶ **Entering Characters(P. 88)**

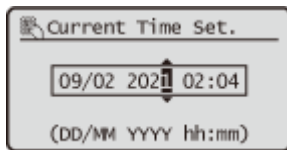

Using **OK**

Press **OK** to apply a setting.

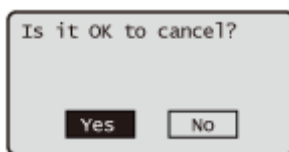

Using the Numeric Keys

Use the numeric keys to enter text and values. ▶ **Entering Characters(P. 88)**

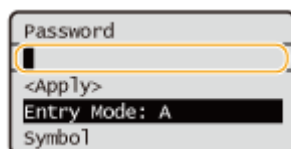

TIPS

- You can change a variety of display-related settings, such as the display language: ▶ **<Display Settings>(P. 356)**

- You can change the screen that is automatically displayed when the machine remains idle for a specified length of time: [▶<Function After Auto Reset>\(P. 359\)](#)
- You can change a variety of accessibility-related settings, such as the scroll speed: [▶<Accessibility>\(P. 376\)](#)

LINKS

- [▶Control Panel\(P. 59\)](#)
- [▶Entering Characters\(P. 88\)](#)

Entering Characters

Use the numeric keys to enter text and values.



Switching the Type of Text

Press ***** to switch the type of text that is entered.

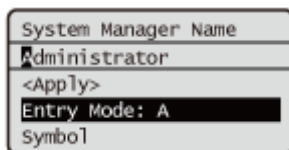

NOTE

- You can also select <Entry Mode> and press **OK** to switch the type of text.

Types of Text That Can Be Entered

Text that can be entered is listed below.

Key	A	a	12
1	@ . - _ /		1
2	ABC	abc	2

3	DEF	def	3
4	GHI	ghi	4
5	JKL	jkl	5
6	MNO	mno	6
7	PQRS	pqrs	7
8	TUV	tuv	8
9	WXYZ	wxyz	9
0	(Not available)		0
#	(space) -. * # ! " ; ; ^ ` _ = / ' ? \$ @ % & + \ ~ () [] { } < >		(Not available)

NOTE

- Press **#** or select <Symbol> and press **OK** when the type of text that is entered is <A> or <a> to display enterable symbols in the screen. Use **▲** / **▼** / **◀** / **▶** to select the symbol you want to enter, and press **OK**.

Deleting Text

One character is deleted each time **C** (Clear) is pressed. Press and hold **C** (Clear) to delete all of the entered text.

Moving the Cursor (Entering a Space)

Press **◀** or **▶** to move the cursor. To enter a space, move the cursor to the end of the text, and press **▶**.

Example of Entering Text and Numbers

Example: "Canon-1"

- Press ***** repeatedly until <A> is selected.
- Press **2** repeatedly until the letter "C" is selected.
- Press ***** repeatedly until <a> is selected.
- Press **2** repeatedly until the letter "a" is selected.
- Press **6** repeatedly until the letter "n" is selected.
- Press **6** repeatedly until the letter "o" is selected.
- Press **6** repeatedly until the letter "n" is selected.
- Press **1** repeatedly until the symbol "-" is selected.
- Press ***** repeatedly until <12> is selected.
- Press **1**.
- Select <Apply> and press **OK**.

Logging into the Machine

7L2J-020

If Department ID Management is enabled or System Manager IDs are enabled, you must log in before using the machine. When the login screen appears, use the procedure below to enter the Department ID and PIN.

NOTE

- If <Auto Reset Time> is set, the user is automatically logged out when no operations are performed for a specified period. [▶<Auto Reset Time>\(P. 359\)](#)

1 Select <Department ID> or <System Manager ID>.

2 Enter the ID and press **OK**.

3 Select <PIN>.

4 Enter the PIN and press **OK**.

5 Press **ID**.

⇒ When login is successful, the machine functions become available.

- Log out after use.

LINKS

- ▶ [Using the Control Panel\(P. 80\)](#)
- ▶ [Customizing the Display\(P. 100\)](#)
- ▶ [Managing Users\(P. 172\)](#)
- ▶ [Starting the Remote UI\(P. 262\)](#)

Specifying Paper Size and Type

7L2J-021

You must specify the paper size and type settings to match the paper that is loaded. Make sure to change the paper settings when you load paper that is different from the previously loaded paper.

- ▶ **Specifying Paper Size and Type in the Paper Drawer(P. 92)**
- ▶ **Specifying Paper Size and Type in the Multi-purpose Tray(P. 94)**
- ▶ **Registering Frequently Used Paper Size and Type for the Multi-purpose Tray(P. 96)**
- ▶ **Registering Free Size Paper (Custom Size Paper)(P. 98)**
- ▶ **Automatically Selecting the Appropriate Paper Source for a Specific Function (P. 99)**

IMPORTANT

- If the setting does not match the size and type of loaded paper, a paper jam or printing error may occur.

NOTE

Batch importing/batch exporting

- <Paper Settings> can only be imported from/exported to the same series machines. ▶ **Importing/Exporting the Setting Data(P. 273)**
- <Paper Settings> is included in [Settings/Registration Basic Information] when batch exporting. ▶ **Importing/Exporting All Settings(P. 275)**

Specifying Paper Size and Type in the Paper Drawer

7L2J-022

1 Load the paper in the paper drawer. Basic Paper Loading Method(P. 64)

When you open the paper drawer, the current paper settings are displayed on the top of the screen.

- If <Confirm When Loading Paper in Drawer> is set to <On>, the screen prompting the user to check the paper settings is displayed when the paper drawer is inserted into the machine.  <Confirm When Loading Paper in Drawer>(P. 356)
- To configure the paper settings later, select <Paper Settings> on the <Home> screen.

2 Check the paper size that is displayed.

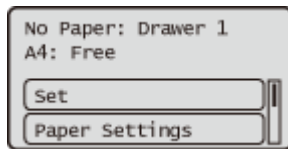

NOTE:

- If the displayed paper size is different from the loaded paper size, the paper may not be loaded properly. Load the paper again.

3 If the displayed paper size/type is different from the loaded paper size/type, select <Paper Settings>, and select the paper source in which paper is loaded.

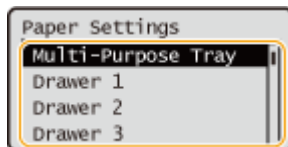

4 Select the paper size .

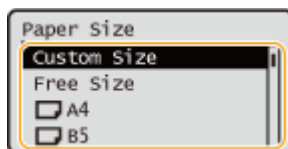

NOTE:

About <Free Size>

- If you frequently need to change the paper to be loaded, set to <Free Size>; this will reduce the number of steps required to change the setting each time. You can also display an error message when the setting in the printer driver is significantly different from the size of the loaded paper.  <Ppr Size Mismatch for Free Size Ppr Src>(P. 388)

■When loading custom size paper

Specify the size of paper loaded in the paper drawer.

- 1 Select <Custom Size>.
- 2 Specify the length of the <X> side and <Y> side.

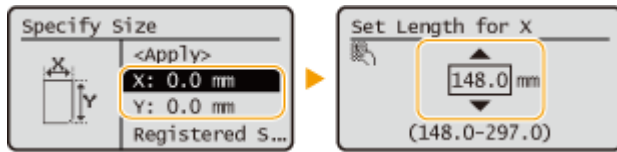

- Select <X> or <Y> to specify the length of each side using the numeric keys or ▲ / ▼ .

NOTE:

- By registering frequently used paper sizes to the <S1> to <S5> buttons, they can be recalled by selecting <Registered Sizes>. **▶Registering Free Size Paper (Custom Size Paper)(P. 98)**

- 3 Select <Apply>.

5 Select the paper type.

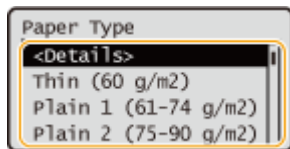

NOTE:

About <Free>

- If you frequently need to change the paper to be loaded, set to <Free>; this will reduce the number of steps required to change the setting each time. However, take note that this setting lets the machine perform printing even if there is mismatch between the paper type setting in the printer driver and the paper type actually loaded in the machine.
- When the paper type setting in the printer driver is [Auto], the machine operates the same way as when the paper type is [Plain 1].
- To check the detailed settings for a paper type, select <Details> ▶ select the paper type to check.

LINKS

- ▶ **Hardware Specifications(P. 531)**

Specifying Paper Size and Type in the Multi-purpose Tray

7L2J-023

! IMPORTANT

- A paper jam or other printing problems may occur if the size and type of paper specified in the printer driver do not match those of the actual paper loaded in the multi-purpose tray.

1 Load the paper in the multi-purpose tray. ▶ Loading Paper in the Multi-Purpose Tray(P. 68)

⇒ The screen for specifying the paper size and type is displayed.

2 Specify the paper size.

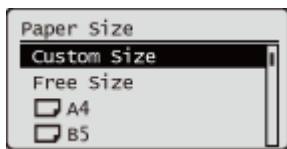

NOTE:

About <Free Size>

- If you frequently need to change the paper to be loaded, set to <Free Size>; this will reduce the number of steps required to change the setting each time. You can also display an error message when the setting in the printer driver is significantly different from the size of the loaded paper. ▶ <Ppr Size Mismatch for Free Size Ppr Src>(P. 388)
- If the displayed paper size is different from the loaded paper size, the paper may not be loaded properly. Load the paper again.

■ When loading standard size paper

Select the paper size from <Paper Size>.

■ When loading custom size paper

- 1 Select <Custom Size>.
- 2 Specify the length of the <X> side and <Y> side.



- Select <X> or <Y> to specify the length of each side using the numeric keys or ▲/▼.

NOTE:

- By registering frequently used paper sizes to the <S1> to <S5> buttons, they can be recalled by selecting <Registered Sizes>. **▶Registering Free Size Paper (Custom Size Paper)(P. 98)**

3 Press <Apply>.

■When loading envelopes

1 Select the type of envelopes.

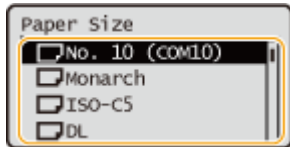

3 Select the paper type.

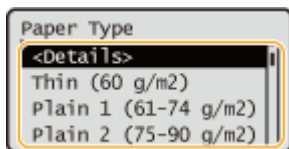

NOTE:

About <Free>

- If you frequently need to change the paper to be loaded, set to <Free>; this will reduce the number of steps required to change the setting each time. However, take note that this setting lets the machine perform printing even if there is mismatch between the paper type setting in the printer driver and the paper type actually loaded in the machine.
- When the paper type setting in the printer driver is [Auto], the machine operates the same way as when the paper type is [Plain 1].
- To check the detailed settings for a paper type, select <Details> ▶ select the paper type to check.

LINKS

▶Hardware Specifications(P. 531)

Registering Frequently Used Paper Size and Type for the Multi-purpose Tray

7L2J-024

You can register default paper settings for the multi-purpose tray. Registering default settings can save yourself the effort of having to specify the settings each time you load the same paper into the multi-purpose tray.

NOTE

- After the default paper setting is registered, the paper setting screen is not displayed when paper is loaded, and the same setting is always used. If you load a different paper size or type without changing the paper settings, the machine may not print properly. To avoid this problem, select <Specify When Loading Paper> in step 3, and then load the paper.

1 Select <Paper Settings> on the <Home> screen.  <Home> Screen(P. 81)

2 Select <Multi-Purpose Tray>.

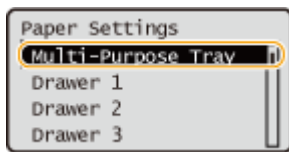

3 Select the paper size.

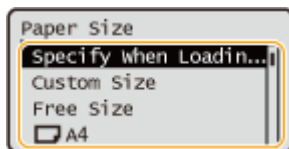

NOTE:

About <Free Size>

- If you frequently need to change the paper to be loaded, set to <Free Size>; this will reduce the number of steps required to change the setting each time. You can also display an error message when the setting in the printer driver is significantly different from the size of the loaded paper.  <Ppr Size Mismatch for Free Size Ppr Src>(P. 388)

When registering standard size paper

1 Select the standard size paper.

■When registering custom size paper

1 Press <Custom Size>.

- 2 Specify the length of the <X> side and <Y> side.



- Select <X> or <Y> to specify the length of each side using the numeric keys or ▲/▼.

NOTE:

- By registering frequently used paper sizes to the <S1> to <S5> buttons, they can be recalled by selecting <Registered Sizes>. **▶Registering Free Size Paper (Custom Size Paper)(P. 98)**

- 3 Select <Apply>.

■When registering envelopes

- 1 Select the type of envelopes.

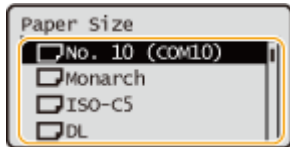

- 4 Select the paper type.

NOTE:

About <Free>

- If you frequently need to change the paper to be loaded, set to <Free>; this will reduce the number of steps required to change the setting each time. However, take note that this setting lets the machine perform printing even if there is mismatch between the paper type setting in the printer driver and the paper type actually loaded in the machine.
- When the paper type setting in the printer driver is [Auto], the machine operates the same way as when the paper type is [Plain 1].
- To check the detailed settings for a paper type, select <Details> ▶ select the paper type to check.

LINKS

- ▶ **Loading Paper in the Multi-Purpose Tray(P. 68)**
- ▶ **Hardware Specifications(P. 531)**

Registering Free Size Paper (Custom Size Paper)

7L2J-025

You can register up to five frequently used free sizes of paper. The paper sizes registered here are displayed on the paper size selection screen for the paper drawer and multi-purpose tray ([▶Specifying Paper Size and Type in the Paper Drawer\(P. 92\)](#) or [▶Specifying Paper Size and Type in the Multi-purpose Tray\(P. 94\)](#)).

1 Select **<Paper Settings>** on the **<Home>** screen. [▶<Home> Screen\(P. 81\)](#)

2 Select **<Register Custom Size>**.

3 Select a button from **<S1>** to **<S5>** ▶ select **<Register>**.

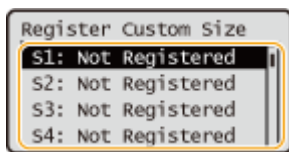

- You can assign an easy to remember name to the button by selecting **<Rename>**.
- If you have selected the registered button, select **<Edit>**.

4 Set the paper size.



- Specify the length of the **<X>** side and **<Y>** side. Select **<X>** or **<Y>** to specify the length of each side using the numeric keys or ▲/▼.

5 Select **<Apply>**.

LINKS

[▶Basic Paper Loading Method\(P. 64\)](#)

Automatically Selecting the Appropriate Paper Source for a Specific Function

7L2J-026

You can enable or disable the automatic paper source selection function for each paper source. If this function is set to <On>, the machine automatically selects a paper source that is loaded with paper of the appropriate size for each print job. Also, when the paper in the selected paper source runs out, this function enables continuous printing by switching from that paper source to another that is loaded with paper of the same size.

NOTE

- Always specify <On> for at least one of the paper sources. If you select <Off> for all the paper sources, then you cannot finish the setting procedure.

1 Select <Set> on the <Home> screen.  <Home> Screen(P. 81)

2 Select <Function Settings> ► <Common> ► <Paper Feed Settings> ► <Paper Source Auto Selection>.

3 Select the function.

- <Other> enables you to make settings for a paper source that is used for outputting reports.

NOTE:

- If you set <Optimal Productivity> to <On>, the machine automatically switches from one paper source to another before the paper in the first paper source runs out.

4 Select <On> for each paper source that you want to be selected automatically.

If you selected <Printer> in step 3

Set whether to put multiple paper sources in a group. If paper source grouping is specified, paper source selection is automatically performed within a group when you print by specifying any paper source belonging to that group. To specify paper source grouping, select <Group Settings> ► set <Use Group> to <On> ► select the paper source ► select a group which you want to put each paper source in ► select <Apply>.

Customizing the Display

7L2J-027

In order to make the <Home> screen easier to use, you can customize it.

Customizing the <Home> Screen

You can rearrange the displayed items and customize the screen to make it easier to select functions.

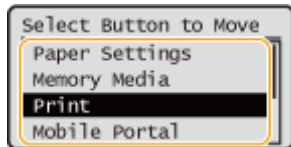

▶ Customizing the <Home> Screen(P. 101)

Changing the Displayed Language

You can change the language displayed on the screen.

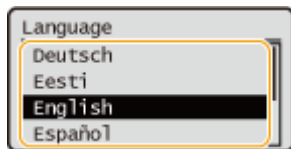

▶ Switching the Displayed Language(P. 102)

LINKS

▶ Using the Control Panel(P. 80)

Customizing the <Home> Screen

You can freely change the display order of items to make the buttons easier to use.

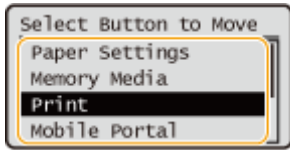

1 Select <Display Order (Home)> on the <Home> screen.  <Home> Screen(P. 81)

2 Use ▲ / ▼ to select the item to be moved, and press .

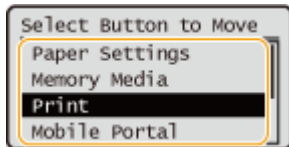

3 Use ▲ / ▼ to move to the target position, and press .

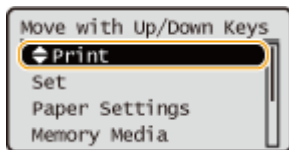

4 When the buttons are rearranged in the way you want, press  (Back).

NOTE:

- Operating this setting requires administrator privileges.

Switching the Displayed Language

7L2J-029

You can change the language displayed on the screen.

- 1** Select <Set> on the <Home> screen. ▶ <Home> Screen(P. 81)
- 2** Select <Preferences> ▶ <Display Settings> ▶ <Language>.
- 3** Select a language from the list.

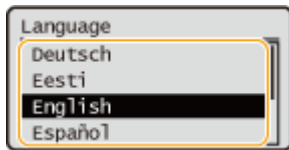

Setting Sounds

The machine produces sounds in a variety of situations, such as when control panel keys are pressed, or when a malfunction occurs. You can specify whether or not set each sound individually.

1 Select <Set> on the <Home> screen. ▶ <Home> Screen(P. 81)

2 Select <Preferences> ▶ <Volume Settings>.

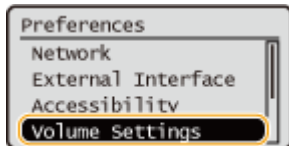

3 Select a setting ▶ select <On> or <Off>.

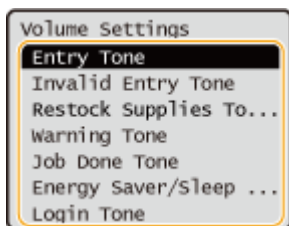

Setting Items	Description
<Entry Tone>	Sound produced each time a key on the control panel is pressed
<Invalid Entry Tone>	Sound produced when an invalid key operation is performed, or when you enter a number outside the valid setting range
<Restock Supplies Tone>	Sound produced when the amount of toner is low
<Warning Tone>	Sound produced when a malfunction such as paper jam or operational error occurs
<Job Done Tone>	Sound produced when an operation such as printing is complete
<Energy Saver/Sleep Tone>	Sound produced when the machine enters sleep mode, or when the machine is turned OFF if you set <Quick Startup Settings for Main Power> to <On>. (Depending on the situations, the machine does not startup quickly and the tone does not sound.)
<Login Tone>	Sound produced when login is successful

Entering Sleep Mode

7L2J-02C

The sleep mode function reduces power consumption by temporarily disabling some internal operations of the machine. If no operations will be performed on the machine for a while, such as during a lunch break, you can save power simply by pressing  (Energy Saver) on the control panel.



NOTE

When in sleep mode

- When the machine enters the sleep mode,  (Energy Saver) lights up yellow green.

Situations in which the machine does not enter the sleep mode

- When the machine is in operation
- When the Data indicator is lit up or blinking
- When the machine is performing an operation such as adjustment or cleaning
- When a paper jam occurs
- When the menu screen is displayed
- If <Energy Saver/Sleep Mode Exit Time Set.> is set to <Off> when an error occurs
- When the SSID/network key screen for Direct Connection is displayed
- When settings are being imported or exported

Exiting Sleep Mode

You can press  (Energy Saver) or any other key on the control panel to exit the sleep mode.

When You Want to Set the Auto Sleep Timer

You can use the <Auto Sleep Time> setting to automatically put the machine into sleep mode. If you want to change the amount of time that elapses before the machine enters auto sleep mode, follow the procedure below.



<Set> ► <Preferences> ► <Timer/Energy Settings> ► <Auto Sleep Time> ► ▲ or ▼ to select the amount of time that elapses before the machine automatically enters the sleep mode.

NOTE

- You can set the time range to automatically enter the sleep mode by the day of the week. ► <Auto Sleep Weekly Timer> (P. 361)

Energy Consumption in the Sleep Mode

You can set the amount of energy that the machine consumes when it is in the sleep mode. Follow the procedure below to set the amount of energy consumed in the sleep mode.



<Set> ► <Preferences> ► <Timer/Energy Settings> ► <Sleep Mode Energy Use> ► select <Low> or <High>.

Changing the Sleep Mode Setting at the Specified Time

You can configure a setting so that the machine is placed into the sleep mode at the specified time. You can also configure a setting so that the sleep mode is released at the specified time.



<Set> ► <Preferences> ► <Timer/Energy Settings> ► <Energy Saver/Sleep Mode Exit Time Set.> ► ▲ or ▼ to select the amount of time that elapses before the machine automatically returns from the sleep mode.

Printing

Printing	107
Printing From a Computer	109
Canceling Printing	112
Checking the Printing Status and History	114
Advanced Functions for Printing	115
Printing Documents Held in the Machine	116
Printing Out Secured Documents	119
Various Printing Methods	121
Directly Printing Files without Opening Them	122
Printing Using a Virtual Printer	124
Printing From Memory Media (Media Print)	126
Printing Received E-mail (E-Mail Print)	127
Printing Using the Microsoft Cloud Service (Universal Print)	128
Configuring the Universal Print User Settings	132

Printing

You can print documents and images prepared on a computer. This section introduces basic procedures and convenient printing functions.

■ Introduction of basic operations

This section describes the basic operation methods when printing from a computer.

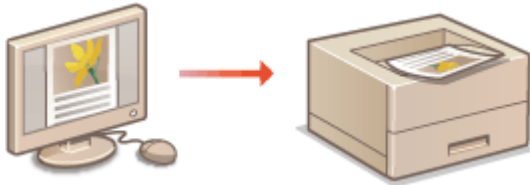

- ▶ **Printing From a Computer(P. 109)**
- ▶ **Canceling Printing(P. 112)**
- ▶ **Checking the Printing Status and History(P. 114)**

■ Advanced functions for printing

This section introduces functions used when you want to print a sample set or edit the document before printing large quantities, avoid to leave or to be copied printed paper, etc.



- ▶ **Printing Documents Held in the Machine(P. 116)**
- ▶ **Printing Out Secured Documents(P. 119)**

■ Printing in various environments

This section introduces printing methods for printing without the printer driver of the machine such as printing without your computer during a business trip, etc.



- ▶ **Directly Printing Files without Opening Them(P. 122)**
- ▶ **Printing Using a Virtual Printer(P. 124)**
- ▶ **Printing From Memory Media (Media Print)(P. 126)**
- ▶ **Printing Received E-mail (E-Mail Print)(P. 127)**
- ▶ **Printing Using the Microsoft Cloud Service (Universal Print) (P. 128)**

TIPS

- You can print photographs, PDF files, etc. from a mobile device such as a smart phone, tablet, etc. For more information, see [▶ Linking with Mobile Devices\(P. 142\)](#) .

Printing From a Computer

7L2J-02F

This section describes basic printing from a computer with the printer driver installed.

- ▶ **Help for Printer Drivers(P. 109)**
- ▶ **Basic Printing Operations(P. 109)**

Help for Printer Drivers

Clicking [Help] (Window) or  (Mac OS) on the printer driver setting screen displays the Help screen. For information that is not in the User's Guide, including about driver features and how to set up those features, see Help.

Basic Printing Operations

This section describes the basic flow when printing from a computer.

- ▶ **In case of Windows(P. 109)**
- ▶ **In case of Mac OS(P. 110)**

Windows

- 1** Open a document and display the print screen.
- 2** Select the machine and click [Preferences] or [Properties].
- 3** Specify the print settings as necessary and click [OK].
 - Switch tabs as necessary to specify the desired print settings.

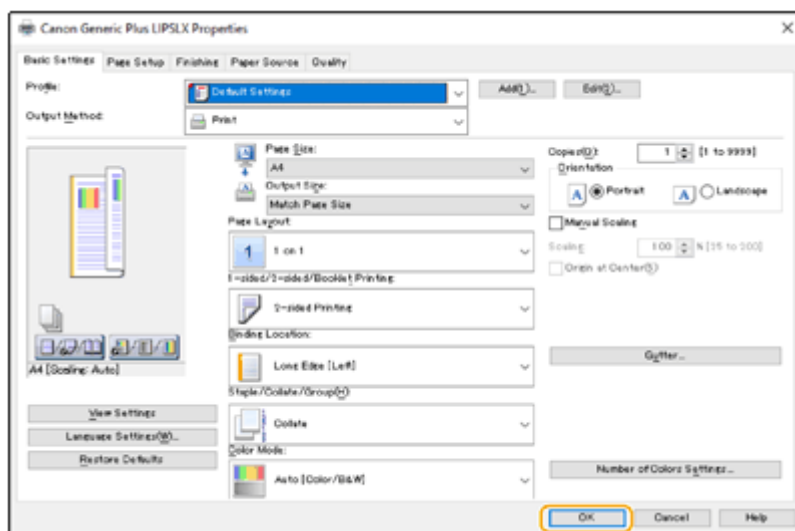

4 Click [Print] or [OK].

⇒ Printing starts.

- If you want to cancel, see [Canceling Printing\(P. 112\)](#) .

Mac OS

1 Open a document and display the print screen.

2 Select the machine.

3 Specify the print settings as necessary.

- After selecting the setting panel from the drop-down list, set for printing on each panel.

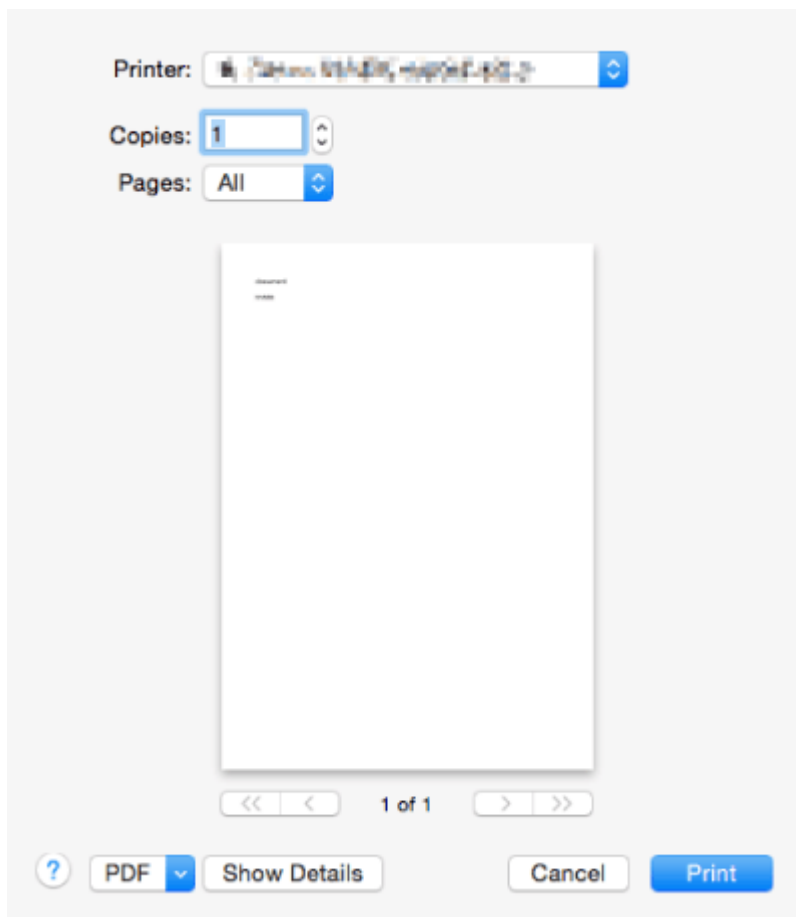

4 Click [Print].

⇒ Printing starts.

- If you want to cancel, see [Canceling Printing\(P. 112\)](#) .

LINKS

▶ **Checking the Printing Status and History(P. 114)**

Canceling Printing

You can cancel printing before it has finished. You can also cancel a print job on the control panel of the machine. ▶
Checking the Printing Status and History(P. 114)

▶In case of Windows(P. 112)

▶In case of Mac OS(P. 113)

Windows

1 Double-click the printer icon on the system tray in the lower-right of the screen.



NOTE:

When the printer icon is not displayed

- Open the printer folder, and click or double-click the icon for the machine.

2 Select the document to cancel and click [Document] ▶ [Cancel].

- If you cannot find the document to cancel, the document is already sent to the machine. In that case, you cannot cancel the printing on the computer.

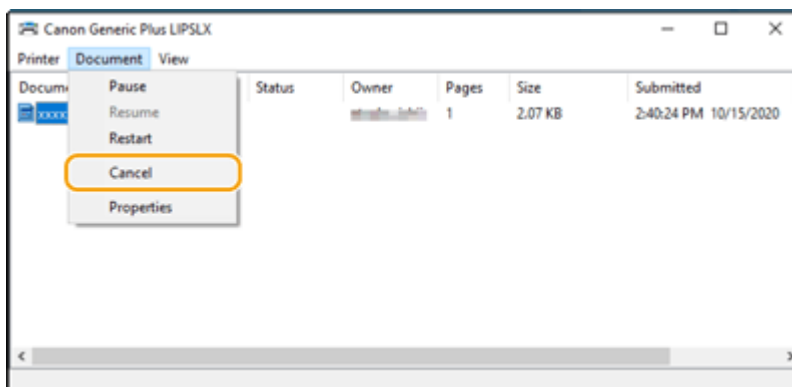

3 Click [Yes].

- ▶▶▶ Printing is canceled.

Mac OS

- 1 Click the printer icon displayed on the Dock.



- 2 Select the document to cancel and click [Delete] or .

⇒ Printing is canceled.

Checking the Printing Status and History

7L2J-02J

You can check the wait status for print jobs and whether or not an error has occurred during printing. Operations such as printing the document ahead of other documents and temporarily suspending or canceling printing are possible as well.

NOTE

- When personal authentication management is used, you can restrict users from performing operations on the jobs of other users on the <Status Monitor> screen. ▶<Restrict Access to Other User Jobs>(P. 396)

1 Press  (Status Monitor).

2 Select <Print Job>.

3 Select the print statuses and logs.

■Checking the status of printing

1 In <Job Status>, select the document to check the status of.

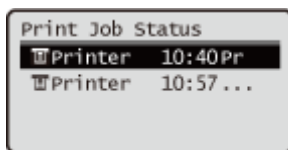

⇒ Display detailed information about the document.

■Checking the printing history

1 In <Job Log>, select an item ▶ select the document to check the history of.

- <OK> is displayed when a document was printed successfully, and <Error> is displayed when a document failed to be printed because it was canceled or there was some error.



⇒ Displays detailed information about the document.

LINKS

▶<Canceling Printing>(P. 112)

Advanced Functions for Printing

7L2J-02K

This section introduces methods for printing with increased security.



▶ **Printing Documents Held in the Machine(P. 116)**



▶ **Printing Out Secured Documents(P. 119)**

Printing Documents Held in the Machine

7L2J-02L



You can temporarily hold print data in the machine and print it from the control panel when required.

You can also set the machine to always hold print data. The Secure Print function can be used even when the Forced Hold setting is disabled.

Restricting Printing from a Computer(P. 255)

! IMPORTANT

- Up to 200 users can use this mode. If a document which is shared with several people is retained in the machine, only the user who sends the job is counted.
- You can store up to 2,000 jobs.
- At least 1 GB is guaranteed for storing retained documents.
- The maximum size of a retained document that can be stored is 2 GB.
- The documents retained in the machine are saved even if the machine is turned OFF.
- Note that documents are automatically deleted after a specified period of time passes. Please consult your administrator regarding the length of this time period.

Forced Hold Settings

- 1 Start the Remote UI.** [Starting the Remote UI\(P. 262\)](#)
- 2 Click [Settings/Registration] on the portal page.** [Remote UI Screen\(P. 263\)](#)
- 3 Click [Printer] ▶ [Print].**
- 4 Select [Force Hold].**
- 5 Configure the other settings as required.**

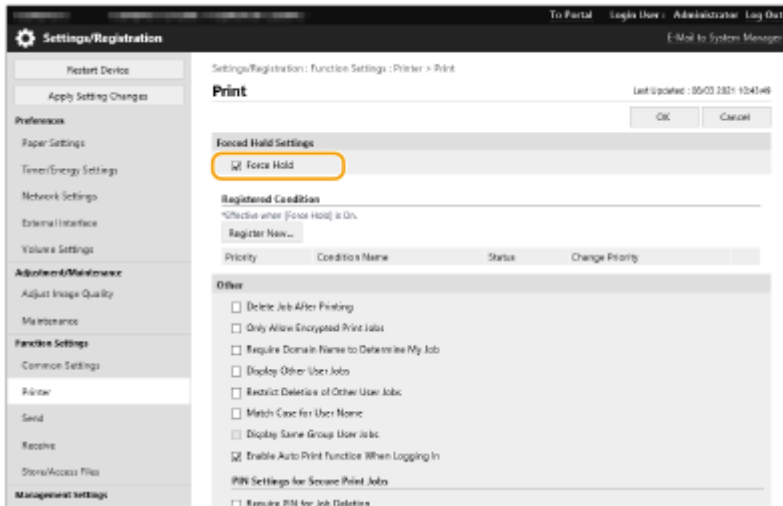

- [Enable Auto Print Function When Logging In] cannot be selected if [Only Allow Encrypted Print Jobs] is selected.

6 Click [OK].

7 Select <Print> on the <Home> screen. ▶<Home> Screen(P. 81)

8 Select <Job Type> and <Print Status> on the <Switch Job List> screen.

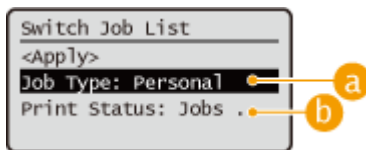

a <Personal>/<Shared>

- <Personal>: Displays the documents sent by the user who is logged in.
- <Shared>: Documents held based on specific conditions according to forced hold settings are displayed. All users can display/print these documents.

b <Jobs to Be Printed>/<Jobs Printed>

When selecting an unprinted document, confirm that <Jobs to Be Printed> is selected.

9 Select <Apply>.

10 On the <Select Job> screen, select the document ▶ press **OK**.

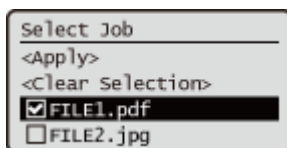

- If a document is not selected, <Select All> is displayed, which enables you to select all the documents in the document list. When documents are selected, <Clear Selection> is displayed enabling you to cancel the entire selection.

11 Select <Apply>

12 Select <Start Printing>.

⇒ Printing starts.

NOTE:

- To cancel printing, select the job to cancel in <Jobs Printed>, and select <Delete Job>. You can also press  (Stop) on the control panel and select the job to cancel from <Print Jobs>.

Automatically Printing Forced Hold Print Jobs after Logging In

When [Enable Auto Print Function When Logging In] is selected in the Remote UI, jobs can be automatically printed when a user logs in.

IMPORTANT

- The following jobs are not automatically printed even if this setting is enabled.
 - <Personal> jobs of other users and <Shared> jobs
 - Printed jobs
 - Encrypted secure printing jobs

NOTE

- When multiple jobs are held, they are printed in the display order of <Date>.
- A maximum of 100 jobs can be printed with a single login operation.

Printing More Safely with Encrypted Secure Print

By using Encrypted Secure Printing, you can send encrypted printing data to a machine from your computer. This enables you to reduce the risk of information leaks when sending printed data, and to print more safely. Use this especially when printing highly confidential documents.

NOTE

- To print the encrypted document, you must enter the password. The password must be the same as the password you set on the printer driver.
- For information on setting items, see "Help" by clicking [Help] on the printer driver setting screen (Windows only).
- Encrypted Secure Print cannot be used with Mac OS.
- To use encrypted secure printing, display the printer folder ► right-click the icon for the machine ► select [Printer properties] ► see the [Help] on the [Encrypted-P] tab. For information on displaying the printer folder, see  **Displaying the Printer Folder(P. 515)** .

Printing Out Secured Documents

7L2J-02R



This section describes how to print a document from an application as a secured document.

Sending a Secured Document from a Computer to the Machine(P. 119)

Sending a Secured Document from a Computer to the Machine

- 1** Open a document in an application and display the print dialog box.
- 2** Select the printer driver for this machine, and click [Preferences] or [Properties].
- 3** Select [Secured Print] in [Output Method].
 - ⇒ The [Information] pop-up screen is displayed. Check the message, and click [Yes] or [No].
- 4** Specify the print settings as necessary, and click [OK].

- Switch the tab according to the settings.

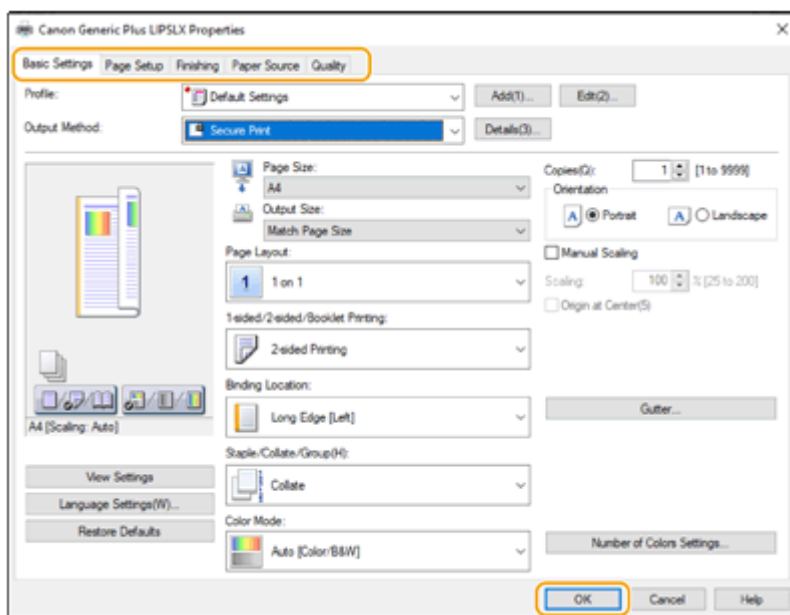

- 5** Click [Print] or [OK].

- ➡ After the secured document is sent to the machine, it is held in the memory of the machine waiting to be printed.

LINKS

- ▶ **Checking the Printing Status and History(P. 114)**

Various Printing Methods

7L2J-02S

This section introduces printing method using the Remote UI, or how to print a file stored in memory media.



▶ Directly Printing Files without Opening Them(P. 122)

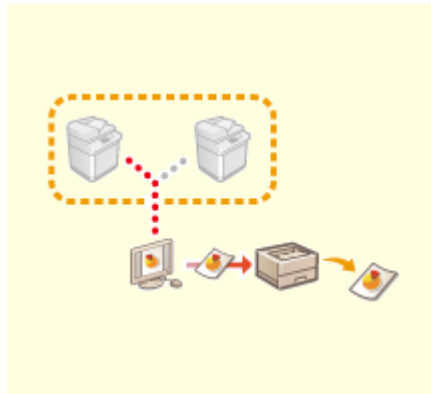

▶ Printing Using a Virtual Printer(P. 124)

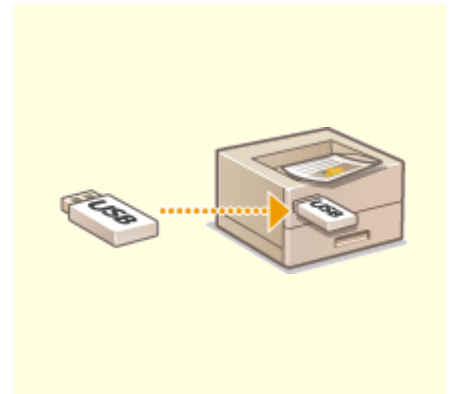

▶ Printing From Memory Media (Media Print)(P. 126)



▶ Printing Received E-mail (E-Mail Print)(P. 127)



▶ Printing Using the Microsoft Cloud Service (Universal Print)(P. 128)

Directly Printing Files without Opening Them

7L2J-02U

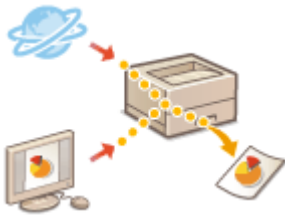

By using remote UI, it is possible to print files saved on a computer or network directly from the machine without using the printer driver. You do not need to open files on the computer for printing.

- 1 Start the Remote UI. ▶ Starting the Remote UI(P. 262)
- 2 Click [Direct Print] on the portal page. ▶ Remote UI Screen(P. 263)
- 3 Select a file format and then a file.

4 Specify the print settings as necessary.

- If a password is set for the PDF file, press [Specify PDF File] ▶ enter the password in [Document Password]. When printing PDF files linked to the policy server, select [Specify PDF File] ▶ enter the policy server user name in [Policy Server User Name] and the policy server password in [Policy Server Password].
- To print the PDF file which is prohibited for printing, or to print PDF files that only allow low-resolution printing in high resolution, enter the master password.
- Depending on the selected paper size, PDF/XPS files may be canceled on printing.

5 Click [Start Printing].

⇒ Printing starts.

IMPORTANT

- Do not click [Start Printing] repeatedly during file transfer. Otherwise, file malfunction may occur and the file may not be transferred.
- Printing may not be performed properly depending on the data.

NOTE

- If printing with Direct Print is not possible or the printing position deviates, opening files from the application and using the printer driver may enable proper printing.

Printing Using a Virtual Printer

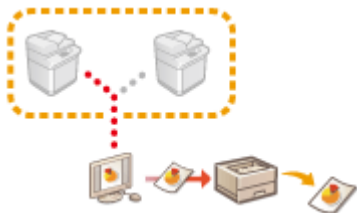

A virtual printer enables you to use LPD printing or FTP printing with the print settings registered as a virtual printer in advance. For example, registering settings such as the paper type, number of copies, and two-sided printing in advance eliminates the need to specify these settings for each job.

▶ **Adding a Virtual Printer(P. 124)**

▶ **Printing with a Virtual Printer(P. 125)**

! IMPORTANT

- For Secure Print and Encrypted Secure Print, the virtual printer is disabled and the job is held in the machine.

NOTE

- Set ▶ **<LPD Print Settings>(P. 364)** to <On> to perform LPD printing.
- Set ▶ **<FTP Print Settings>(P. 364)** to <On> to perform FTP printing.
- The page description language and file format that can be used with a virtual printer is PS and PDF.

Adding a Virtual Printer

- 1 Start the Remote UI. ▶ Starting the Remote UI(P. 262)**
- 2 Click [Settings/Registration] on the portal page. ▶ Remote UI Screen(P. 263)**
- 3 Click [Printer] ▶ [Virtual Printer Management].**
- 4 Click [Add Virtual Printer].**

NOTE

- Operations cannot be performed from multiple browsers at the same time.

- 5 Enter the virtual printer name and specify the required settings.**

Virtual Printer Management > Add Virtual Printer

Add Virtual Printer [Add] [Cancel]

Virtual Printer

Virtual Printer Name: (Max 6 characters)

Settings for Virtual Printer

Select	Item Name	Change Settings
<input type="checkbox"/>	Paper Source	Auto
<input type="checkbox"/>	Paper Type	Auto
<input type="checkbox"/>	Paper Output	Auto
<input type="checkbox"/>	Number of Copies	1 (1-9999)
<input type="checkbox"/>	2-Sided Printing	Off
<input type="checkbox"/>	Select Color	Auto
<input type="checkbox"/>	Print Range	All Pages
<input type="checkbox"/>	First Page	1 (1-9999)

NOTE

- Multiple virtual printers with the same name cannot be registered.
- A maximum of 20 virtual printers can be registered.

6 Click [Add].

NOTE

- You are required to log in to the Remote UI with any of the following privileges to perform this setting. For more information, see the items in [Select Role to Set:] in [▶ Registering User Information in the Local Device\(P. 177\)](#) .
 - Administrator
 - DeviceAdmin
 - NetworkAdmin
- This setting can be imported/exported with models that support batch importing of this setting. [▶ Importing/Exporting the Setting Data\(P. 273\)](#)
- This setting is included in [Settings/Registration Basic Information] when batch exporting. [▶ Importing/Exporting All Settings\(P. 275\)](#)

Printing with a Virtual Printer

For LPD printing

- LPR -S [IP address of the machine] -P [virtual printer name] [file name]
Example: Printing "sample.pdf" with a virtual printer named "001"
lpr -S IP address of the machine -P 001 sample.pdf

For FTP printing

- put [file name] [virtual printer name]
Example: Printing "sample.pdf" with a virtual printer named "001"
> put sample.pdf 001

Printing From Memory Media (Media Print)

7L2J-02X

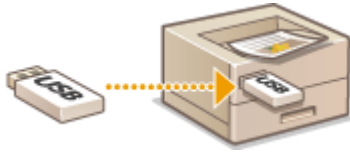

It is possible to print files saved on memory media directly from the machine without using a computer. This is convenient when printing after bringing data back from an outside location or when printing data you have brought with you to a business destination.

NOTE

Using memory media

- For available memory media and information on inserting/removing memory media, see [▶Connecting a USB Memory Device\(P. 53\)](#) .
- For instructions on using memory media, see [▶Using Memory Media\(P. 136\)](#) .
- Depending on the file format, an optional product may be required. [▶System Options\(P. 530\)](#)

Printing Received E-mail (E-Mail Print)



E-Mail Print allows you to print the message and attached TIFF image files of an e-mail received from the POP3 mail server without using a computer. E-mails can be manually received as well as being automatically received at regular intervals. When the SMTP protocol is used, e-mails directly sent to the machine via no mail server are printed.

▶ Manually Receiving E-Mails(P. 127)

NOTE

- Some files are unavailable depending on the file structure.
- For information on the settings for receiving and printing e-mail with the machine, see ▶ **Configuring E-Mail Print Settings(P. 45)** .
- For information on the specification of the e-mail print, see ▶ **Printer Functions(P. 520)** .

■ Outline of E-Mail Print

General

- An e-mail message is printed with e-mail header information.
- If the text in the e-mail body field does not fit in one line, a line break is automatically inserted.

! IMPORTANT

- When the toner cartridge is nearly empty, no e-mails can be received.

Manually Receiving E-Mails

If e-mail printing from the POP3 mail server is enabled, you can manually receive and print e-mails as well. When you want to connect to the mail server before automatically receiving e-mails or the machine is configured to prevent e-mails from being automatically received, follow the procedure below to manually receive the e-mails.

1 Press  (Status Monitor).

2 Select <RX> ▶ <Check E-Mail RX>.

- ⇒ The machine is connected to the mail server. E-Mail Print is started for new e-mails in the mailbox of the mail server if any.

LINKS

- ▶ **Checking the Printing Status and History(P. 114)**
- ▶ **Printing Reports and Lists(P. 436)**

Printing Using the Microsoft Cloud Service (Universal Print)

7L2J-030



Universal Print is a service that enables you to print documents via the Microsoft cloud. Universal Print drivers are included as a standard feature in Windows 10, so there is no need to install printer drivers for each computer. This also eliminates the need for printer servers, thereby enabling cost reductions and reducing the workload on network administrators.

Conditions of Use

To use Universal Print, you must first register as a Microsoft 365 service user and use the Azure Active Directory Service.

NOTE

- Printing Using the Microsoft Cloud Service (Universal Print)
 - For communication using a sub-line

Required Settings

Administrator settings

Use the Remote UI to register this machine in Azure Active Directory. [▶ Registering This Machine in Azure Active Directory\(P. 129\)](#)

User settings

Configure your computer so that Universal Print can be used. [▶ Configuring a Printer Registered in Azure Active Directory on the Computer\(P. 131\)](#)

NOTE

When a proxy server is used

- To use Universal Print via a proxy server, you must also configure the proxy settings on your computer.

Associating Users and Universal Print Jobs

You can associate Universal Print jobs with users authenticated through User Authentication. You can still use Universal Print without configuring these settings. [▶ Configuring the Universal Print User Settings\(P. 132\)](#)

Printing with Universal Print

See the Microsoft website for information on printing with Universal Print.



- In some operating systems, print errors or problems with the print results may occur. See Universal Print Troubleshooting on the Microsoft website for information on the compatibility of your operating system.

Registering This Machine in Azure Active Directory

- 1 Start the Remote UI. ▶Starting the Remote UI(P. 262)**
- 2 Click [Settings/Registration] on the portal page. ▶Remote UI Screen(P. 263)**
- 3 Click [Network Settings] ▶ [Settings for Universal Print].**
- 4 Click [Edit] for [Basic Settings].**
- 5 Select the [Use Universal Print] checkbox and enter the printer name in the [Printer Name] field.**
 - To verify the server certificate sent from the server, select the [Verify Server Certificate] checkbox.
 - To add CN (Common Name) to the items to be verified, select the [Add CN to Verification Items] checkbox.
 - Change the [Application ID], [Azure Active Directory Authentication URL] or [Azure Active Directory Registration URL] settings according to your cloud environment.
- 6 Click [OK].**
- 7 Click [Register] in [Registration Status].**
- 8 Wait a few seconds, and then click ↻ .**

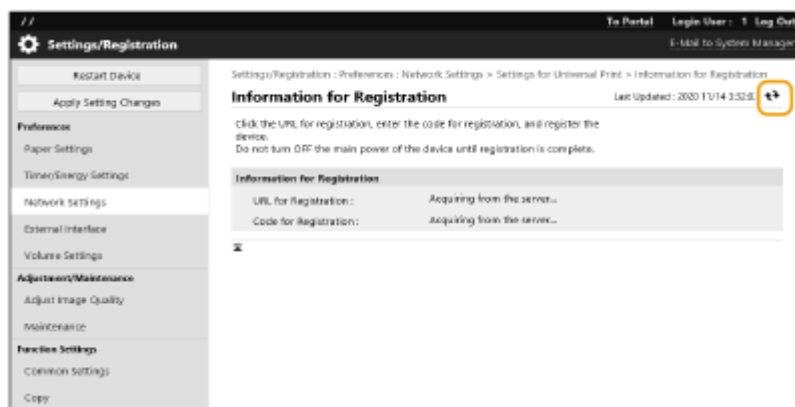

- 9 Click the URL link displayed for [URL for Registration].**

10 Follow the instructions on the screen to register the machine.

11 Wait a few minutes, and then click  in the Remote UI screen.

⇒ Once registration is completed, [Registered] appears in [Registration Status].

12 View the Universal Print management screen of Azure Active Directory in your web browser.

13 Select the registered machine and click [Share Printer].

- To change the name displayed on the computer, enter the new name in [Printer Share Name], and then click [Share Printer].

⇒ [Printer shared.] appears at the top right of the screen.

14 Click [Members], and then click [Add].

15 Select the members and groups who will use the registered printer from the list.

- The selected members and groups will be able to use the printer.

■ To Delete a Registered Printer

1 Start the Remote UI.  Starting the Remote UI(P. 262)

2 Click [Settings/Registration] on the portal page.  Remote UI Screen(P. 263)

3 Click [Network Settings]  [Settings for Universal Print].



4 Click [Registration Status] for [Unregister].

5 Click [OK].

6 View the Azure Active Directory device management screen in your web browser.

7 Select the model to be deleted and click [Delete].

Configuring a Printer Registered in Azure Active Directory on the Computer

- 1** Click  ►  [Settings] ► [Accounts].
- 2** Click [Access work or school] ► [Connect].
- 3** Follow the on-screen instructions to sign in to your Microsoft 365 account.
- 4** Click [Home] ► [Devices].
- 5** Click [Printers & scanners] ► [Add a printer or scanner].
- 6** Select a registered printer from the list.

Configuring the Universal Print User Settings

7L2J-031

Configure these settings if you want to manage users authenticated through User Authentication and their associated Universal Print jobs. Universal Print can still be run without configuring these settings.

- 🔗 **Set by the User(P. 132)**
- 🔗 **Set by the Administrator(P. 132)**
- 🔗 **Set by the Administrator Using a CSV File(P. 133)**

Set by the User

- 1 Start the Remote UI.** 🔗 **Starting the Remote UI(P. 262)**
- 2 Click [Settings/Registration] on the portal page.** 🔗 **Remote UI Screen(P. 263)**
- 3 Click [User Management] ▶ [Authentication Management].**
- 4 Enter [User Name for Universal Print:] in [Information for Universal Print].**
 - In [User Name for Universal Print:], enter the email address or phone number used in the Microsoft 365 account.

Set by the Administrator

- 1 Start the Remote UI.** 🔗 **Starting the Remote UI(P. 262)**
- 2 Click [Settings/Registration] on the portal page.** 🔗 **Remote UI Screen(P. 263)**
- 3 Click [User Management] ▶ [Authentication Management].**
- 4 Click [Edit] for the user to be set.**

NOTE:

If the Universal Print user is not registered

- Click [Add User] and register the user information. When registering the user information, enter the [User Name for Universal Print:] in [Information for Universal Print].

- 5 Enter [User Name for Universal Print:] in [Information for Universal Print].**

- In [User Name for Universal Print:], enter the email address or phone number used in the Microsoft 365 account.

6 Click [Update].

Set by the Administrator Using a CSV File

You can associate User Authentication users with a Microsoft 365 account by editing a CSV file.

1 Start the Remote UI. ▶ Starting the Remote UI(P. 262)

2 Click [Settings/Registration] on the portal page. ▶ Remote UI Screen(P. 263)

3 Click [User Management] ▶ [Authentication Management] ▶ [Settings for Universal Print].

4 Click [Start Exporting].

- If there is no user information that is associated with a Microsoft 365 account, you cannot configure the settings using a CSV file. Click [Add Association...], add the associated user and then click [Start Exporting].

5 Editing the exported CSV file

- Enter a registered user name in "mcp_uid".
- In "azureaccount_name", enter the email address or phone number used in the Microsoft 365 account.

6 Click [Import] and specify the file edited in step 5.

7 Click [Start Importing].

Using Memory Media Such as USB Memory

Using Memory Media Such as USB Memory	135
Using Memory Media	136

Using Memory Media Such as USB Memory

7L2J-032

You can also use the data on a computer not connected to the network via memory media compliant with the USB standard. Preparations are required for using memory media. [▶Using Memory Media\(P. 136\)](#)

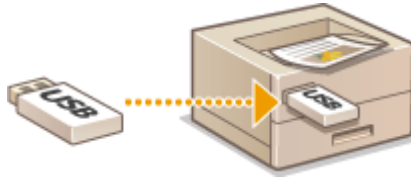

Using Memory Media

7L2J-033

You can directly insert memory media to the machine and use it. Memory media compliant with the USB 2.0 standard is supported. FAT32/exFAT format memory media is supported. The following devices and usage methods are not supported.

- Memory media with security functions
- Memory card readers connected via USB
- USB extension cables or USB hubs

▶ **Preparing to Use Memory Media(P. 136)**

▶ **Inserting/Removing Memory Media(P. 136)**

▶ **Printing Files on Memory Media(P. 137)**

Preparing to Use Memory Media

When using memory media, perform the following preparations in advance.

■ Enabling Memory Media for Printing



<Set> ▶ <Function Settings> ▶ <Access Files> ▶ <Memory Media Settings> ▶ <Use Print Function>
▶ <On>

If memory media is not recognized although it is connected correctly, set <Use AddOn Driver for USB Storage Device> to <Off>. ▶ **<Use AddOn Driver for USB Storage Device>(P. 374)**

NOTE

Displaying the print settings screen when memory media is inserted

- Set <Select Option When Connecting Mem. Media> to <On>. When memory media is inserted, a confirmation screen is displayed and printing can be immediately executed. ▶ **<Select Option When Connecting Mem. Media>(P. 392)**

*To display the print settings screen from memory media, insert the memory media after canceling the Sleep mode. ▶ **<Exiting Sleep Mode>(P. 105)**

Inserting/Removing Memory Media

Inserting memory media incorrectly or in the wrong direction may cause problems with the machine or the memory media.

■ Inserting Memory Media

Insert the USB memory into the USB port on the right side of the machine with the correct orientation.

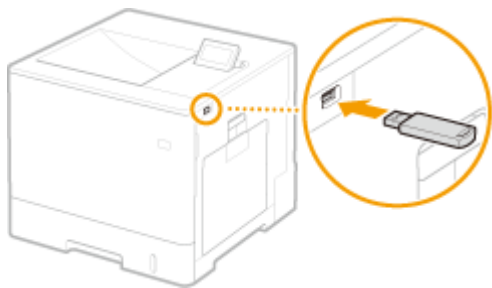

■ Removing Memory Media

Perform one of the following operations to remove the media.

- Select <Remove Memory Media> on the memory media print screen ► <Yes> for <Remove Memory Media>.
- Select  (Status Monitor) ► <Device Status> ► <Remove Memory Media>.

Printing Files on Memory Media

1 Insert the memory media into the USB port of the machine.  **Inserting/Removing Memory Media(P. 136)**

2 Select <Memory Media> on the <Home> screen.  **<Home> Screen(P. 81)**

3 Select <Select File and Print>.

- Select <Select All> to select all the files.
- If there are multiple file types, select <PDF>, <XPS>, or <JPEG/TIFF>.
You can deselect a file by selecting the file again. To deselect all files, select <Clear Selection>.

4 Select <Apply>.

■ When using a print ticket to print an XPS file

When printing a file in the XPS file format, you can print according to the print ticket (print settings) embedded in the file.

1 Select <On> for <Use Print Ticket>.

2 Select <Start Printing>.

►► Printing starts. Remove the memory media when printing is complete.  **Inserting/Removing Memory Media(P. 136)**

5 Specify the print settings as necessary.

Select the item to set.

<Number of Copies>

Specify the number of copies. Enter a quantity using numeric keys, and press **OK**.

<Color Mode>

Select whether to print data in black and white or color.

<Paper>

Select the paper source that contains the paper to use for printing.

NOTE:

- The  icon indicates the multi-purpose tray.
- The number icon indicates the paper drawer position.
- For information on paper sources, see **▶Parts and Their Functions(P. 51)** and **▶Optional Equipment(P. 544)** .

<N on 1>

- <N on 1> cannot be used for JPEG files or TIFF files.

Prints data for multiple pages of image data on the same side of a sheet of paper. You can specify the number of pages to print on one side of a sheet of paper. For example, to print four pages on one side of a sheet of paper, select <4 on 1>.

<2-Sided>

You can make 2-sided printouts. Select the binding position.

<Book Type>

Prints on both sides of paper in such a way that the printed pages are opened horizontally when bound.

**<Calendar Type>**

Prints on both sides of paper in such a way that the printed pages are opened vertically when bound.

**NOTE:**

- <2-Sided> may not be available with some sizes or types of paper. **▶Available Paper(P. 534)**

<Resolution>

Set <1200 dpi> to print more clearly.

<Print Range>

When printing a file with two pages or more, specify the pages to print.

<Print Range (TIFF)>

- <Print Range (TIFF)> cannot be used for PDF files, XPS files, or JPEG files.

When printing a file with two pages or more, specify the pages to print.

<Fit Paper Size>

- <Fit Paper Size> cannot be used for JPEG files or TIFF files.

Set this mode to automatically enlarge/reduce when printing PDF/XPS files.

<Enlarge/Reduce>

- <Enlarge/Reduce> cannot be used for PDF files or XPS files.

Set this mode to automatically enlarge/reduce the image size according to the paper size when printing image files.

<Enlarge Print Area>

Set this mode to narrow the blank borders at each side of the page and enlarge the print area.

<Collate>

- <Collate> cannot be used for JPEG files or TIFF files.

Set this mode to sort when printing PDF/XPS files.

<Image Orientation>

- <Image Orientation> cannot be used for PDF files or XPS files.

Set this mode to automatically detect the aspect ratio of the image file and print it vertically or horizontally as required. You can also manually specify to print vertically or horizontally.

<Print Position>

- <Print Position> cannot be used for PDF files or XPS files.

You can set the print area to the center or the top left when printing an image file.

<Halftones>

Set the printing method for reproducing halftones (the intermediate areas between the light areas and dark areas of an image) with the optimal image quality.

■ **For JPEG files or TIFF files**

<Resolution>

Set this mode to enable fine printing so that the outlines of text data, etc. are clearer. This mode is optimal for printing data containing a lot of text or fine lines.

<Gradation>

Prints images with fine gradation, such as digital camera images, with a smooth finish.

<Error Diffusion>

This mode is suitable for printing data with text and thin lines and the curved lines of CAD data, etc.

NOTE:

- The stability of the texture and fixed toner may be reduced when <Error Diffusion> is used.

■ **For PDF files or XPS files**

<Error Diffusion>

This mode is suitable for printing data with text and thin lines and the curved lines of CAD data, etc.

NOTE:

- This setting is only available when <Resolution> is set to <600 dpi>.
- The stability of the texture and fixed toner may be reduced when <Error Diffusion> is used.

<Resolution/Gradation>

Select a method used to reproduce halftones, if <Error Diffusion> is set to <Off>. This option can be specified for each image type in any one document.

6 Select <Start Printing>.

⇒ The selected file is printed.

- If you want to cancel printing, select <Cancel> ► <Yes>.

7 Correctly remove the memory media. ▶ Inserting/Removing Memory Media(P. 136)

Incorrectly removing the memory media may cause problems with the machine or the memory media.

Linking with Mobile Devices

Linking with Mobile Devices	142
Connecting with Mobile Devices	143
Connecting Directly	144
Utilizing the Machine through Applications	147
Using AirPrint	149
Printing with AirPrint	153
If AirPrint Cannot Be Used	156
Printing with Default Print Service (Android)	157

Linking with Mobile Devices

7L2J-034

Linking the machine with mobile devices such as smartphones and tablets enables you to easily print using applications. In addition, you can operate the machine from mobile devices via remote control to confirm printing status and change the settings of the machine.



- ▶ **Connecting with Mobile Devices(P. 143)**
- ▶ **Utilizing the Machine through Applications(P. 147)**
- ▶ **Using AirPrint(P. 149)**
- ▶ **Printing with Default Print Service (Android)(P. 157)**

IMPORTANT

- Depending on your mobile device, the machine may not operate correctly.

Connecting with Mobile Devices

7L2J-035

There are two methods to connect the mobile devices with the machine, "Connecting via a Wireless LAN Router" and "Direct connection." Select a connection method in accordance with the communication environment and the device you are using.

Perform communication with mobile devices from <Mobile Portal> (**▶<Home> Screen(P. 81)**). You can confirm the information of connected mobile devices, etc., from here.

■ Connecting via a Wireless LAN Router

For information on how to connect a mobile device to your wireless LAN router, see the manuals provided with the devices, or contact the manufacturer.

Connect with the machine using either a wired LAN or wireless LAN router. **▶Setting up the Network Environment(P. 8)**



NOTE

- If you connect a mobile device to the machine via a wireless LAN router, you can confirm the information of the machine on the <Device Name/IP Address> screen by selecting <Mobile Portal> (**▶<Home> Screen(P. 81)**) ▶ <Display Device Name/IP Address>.
- If <Use Direct Connection> is set to <On>, you can confirm the information of the machine on the <Device Name/IP Address> screen by selecting <Mobile Portal> (**▶<Home> Screen(P. 81)**) ▶ LAN Connection ▶ <Display Device Name/IP Address>.

■ Connecting Directly

Directly connect a mobile device to the machine wirelessly without using wireless LAN. It is possible to immediately connect to the machine wirelessly even outside of a wireless LAN environment. **▶Connecting Directly(P. 144)**



Connecting Directly

Even in an environment without a wireless LAN router, you can still directly connect your mobile device to the machine via "Access Point Mode" or "Wi-Fi Direct," which enable connections between the device and the machine without the need to configure complicated settings.



- ▶ **Preparing to Connect Directly(P. 144)**
- ▶ **Connecting Directly (Access Point Mode)(P. 145)**
- ▶ **Connecting Directly (Wi-Fi Direct)(P. 145)**

Preparing to Connect Directly

Establish a connection by using Access Point Mode in the following order.



Check the network settings of the machine.

- Select <Set> ▶ <Preferences> ▶ <Network> ▶ <TCP/IP Settings> ▶ <IPv4 Settings> ▶ set <Use IPv4> to <On>.



Prepare the mobile device.

- Configure the mobile device to enable Wi-Fi connection.



Prepare the machine for connection.

- Select <Set> ▶ <Preferences> ▶ <Network> ▶ <Direct Connection Settings> ▶ set <Use Direct Connection> to <On>.
- Select <Set> ▶ <Preferences> ▶ <Network> ▶ <Direct Connection Settings> ▶ select the type of direct connection to use in <Direct Connection Type>.
- Press <Mobile Portal> (▶<Home> Screen(P. 81)) ▶ <Direct Connection> ▶ <Connect>.
- If <Wireless LAN> or <Wired LAN + Wireless LAN> is selected in <Select Interface>, <Wi-Fi Direct> cannot be used in <Direct Connection Type>. ▶<Select Interface>(P. 370)

NOTE

- For details on using Canon PRINT Business, see the related manuals. (<https://global.canon/gomp/>)

- If the message <Cannot be used with current settings. Contact the system manager.> is displayed on the top of the control panel and Connect cannot be selected, confirm that <Use Direct Connection> is set to <On>. If <Use Direct Connection> is set to <On> but <Connect> cannot be pressed, change the IP address in <Direct Connection IP Address Settings>. ▶<Use Direct Connection>(P. 371) ▶<Direct Connection IP Address Settings>(P. 372)
- When using the Access Point Mode, if the machine is started with <Keep Enabled If SSID/Net. Key Specified> set to <On>, direct connections are possible without selecting <Mobile Portal> ▶<Connect>. ▶<Keep Enabled If SSID/Net. Key Specified>(P. 372)

Connecting Directly (Access Point Mode)

IMPORTANT

- It may take some time for connection between the machine and the mobile device to be established.

■ Connecting Manually

- 1 With the machine as the connection destination, configure the wireless LAN settings on your mobile device, using the SSID and network key information shown on the screen of the machine.**
- 2 After completing the desired operations, select Disconnect.**

Connecting Directly (Wi-Fi Direct)

■ Connecting to the Machine from a Mobile Device

- 1 Start a direct connection on the mobile device.**
 - Open the Wi-Fi Direct screen from the Wi-Fi settings screen of the mobile device, and tap the machine from the list of Wi-Fi Direct devices that have been detected.
 - ⇒ A message indicating that a connection request has been received from the mobile device is displayed on the screen of the machine.
- 2 Select <Yes> on the screen of the machine.**
 - ⇒ A connection between the machine and the mobile device is started.
- 3 After completing the desired operations, select Disconnect.**

■ Connecting to a Mobile Device from the Machine

1 Select the name of the device to directly connect to from the list displayed on the screen, and select Connect.

⇒ A screen for selecting whether to allow a connection to the mobile device is displayed.

2 Tap [Yes] on the screen of the mobile device.

⇒ A connection between the machine and the mobile device is started.

3 After completing the desired operations, select Disconnect.

TIPS

- To check the connected mobile devices, select <Connection Information> on the <Direct Connection> screen.

! IMPORTANT

- While connecting via direct connection, you may not be able to connect to the Internet depending on the mobile device you are using.
- The connection standby status ends if a wireless connection is not performed from the mobile device within five minutes of the device name being displayed.
- If the status without data transmission between a mobile device and the machine continues during communication by direct connection, the communication may end.
- Power saving performance of sleep mode degrades while connecting via direct connection.
- When you finish the desired operation, be sure to terminate the connection between the machine and the mobile device. If they remain connected, power saving performance of sleep mode degrades.
- If you use the direct connection, do not set the IP address manually on the mobile device. Doing so may prevent proper communication after using the direct connection.

Utilizing the Machine through Applications

7L2J-037

Print by using applications from a mobile device connected to the machine. Various applications including those exclusive to Canon are supported. Use properly in accordance with your device, the application, and the situation.

■ Canon PRINT Business

An application for printing, etc. from mobile devices that support iOS/Android. No operations on the machine are necessary to perform printing. For information on supported operating systems, detailed setting methods, and operational procedures, see the Help of the application or the Canon website (<https://global.canon/gomp/>).

IMPORTANT

- Canon PRINT Business can be downloaded free of charge, but the customer is responsible for any fees regarding internet connection.

■ Printing with Canon Print Service

You can easily print from the menu of applications that support the Android print subsystem. For more information on supported operating systems and detailed settings and procedures, see the Canon website (<https://global.canon/gomp/>).

■ Printing with Mopria®

The machine also supports Mopria®. Using Mopria® enables you to print from mobile devices that support Android using common operations and settings, even if manufacturers and models differ. For example, if you are using printers supporting Mopria® made by multiple manufacturers or a printer supporting Mopria® that is located in a place you are visiting, you can print without installing an application exclusive for each manufacturer or model. For more information on supporting models or operation environments, see <http://www.mopria.org>.



Confirming Mopria® settings



Log in to the Remote UI with Administrator privileges ( **Starting the Remote UI(P. 262)**)
 ▶ [Settings/Registration] ▶ [Network Settings] ▶ [Mopria Settings] ▶ select the [Use Mopria] check box ▶ [OK]

■ Printing from Windows Phone (Windows 10 Mobile and Later)

You can perform printing from a Windows Phone without downloading a dedicated application or installing a driver. Make sure that the <Use WSD Printing>, <Use WSD Browsing>, and <Multicast Discovery Settings> are enabled.

▶<WSD Settings>(P. 364)

▶<Multicast Discovery Settings>(P. 365)

Using AirPrint

7L2J-038

This section describes the settings required to use AirPrint and the procedure for printing from Apple devices.



AirPrint Settings

- ▶ **Configuring AirPrint Settings(P. 149)**
- ▶ **Displaying the Screen for AirPrint(P. 151)**

Functions of the AirPrint

- ▶ **Printing with AirPrint(P. 153)**

Troubleshooting

- ▶ **If AirPrint Cannot Be Used(P. 156)**

Configuring AirPrint Settings

You can register information, including the name of the machine and installation location, that is used for identifying the machine. The settings required for using AirPrint can be configured remotely using the Remote UI.

■ Configuring Settings Using the Remote UI

- 1 Start the Remote UI and log on in System Manager Mode. ▶ Starting the Remote UI(P. 262)**
- 2 Click [Settings/Registration].**
 - If you are using a mobile device, such as an iPad, iPhone, or iPod touch, read "click" as "tap" in this section.
- 3 Click [Network Settings] ▶ [AirPrint Settings].**
- 4 Specify the required settings, and click [OK].**

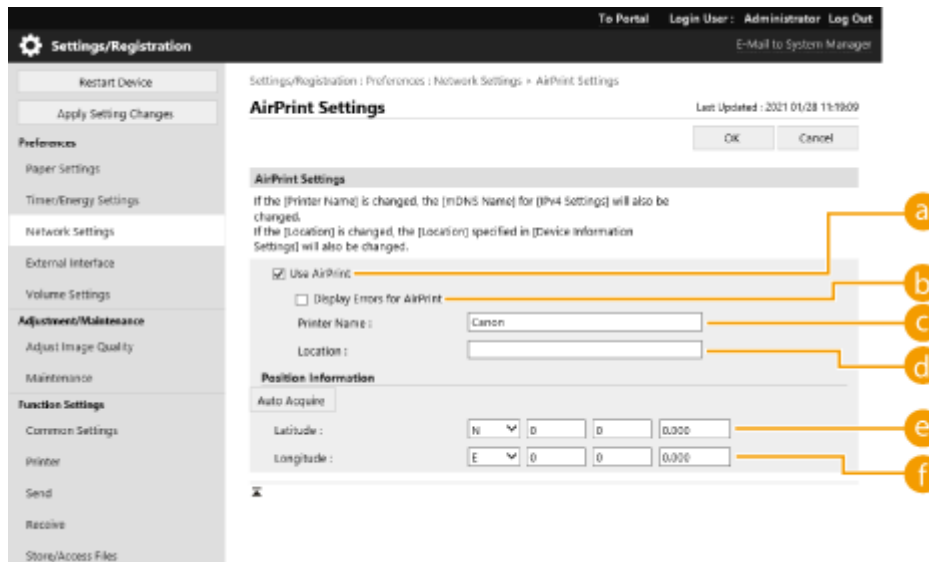

a [Use AirPrint]

Select the check box to enable AirPrint. To disable AirPrint, deselect the check box.

b [Display Errors for AirPrint]

Specify whether to display an error screen on the control panel if printing cannot be performed as expected due to a problem with the print data when printing with AirPrint.

c [Printer Name]

Enter the name of the machine. If an mDNS name has already been registered in [mDNS Settings] ([Network Settings] in [Preferences] (Settings/Registration)), the registered name is displayed.

d [Location]

Enter the location of the machine. If a location has already been registered in [Device Information Settings] ([Device Management] in [Management Settings] (Settings/Registration)), the registered name is displayed.

e [Latitude]

Enter the latitude of the location where the machine is installed.

f [Longitude]

Enter the longitude of the location where the machine is installed.

5 Restart the machine.

- Turn OFF the machine, wait at least 10 seconds, and then turn it ON.

■ Configuring Settings from the Control Panel

1 Select <Set> on the <Home> screen. <Home> Screen(P. 81)

2 Select <Preferences> ▶ <Network> ▶ <Use AirPrint>.

- The Administrator PIN must be entered in order to configure this setting.

3 Select <On> ► <OK>.

IMPORTANT

If you select [Use AirPrint], the following settings in <TCP/IP Settings> are set to <On>.

- Use HTTP
- IPP Print Settings
- Use IPv4 mDNS
- Use IPv6 mDNS

NOTE

- If you change [Printer Name] that you have once specified, you may be unable to print any more from the Mac that has been able to be used for printing so far. This phenomenon occurs because <mDNS Name> ( **Making DNS Settings(P. 31)**) of IPv4 is also changed automatically. In this case, add the machine to the Mac again.
- When AirPrint is in-use, <Use Same mDNS Name as IPv4> is fixed to <On> for the mDNS name of IPv6.
- Entering the printer name makes it easier to identify multiple printers that support AirPrint.

Displaying the Screen for AirPrint

You can display the screen for AirPrint, on which you can not only access the AirPrint Settings but also view information about consumables, such as paper and toner cartridge. Further, you can configure security function settings.

■ Displaying from a Mac

1 Click [System Preferences] in the Dock on the desktop ► [Printers & Scanners].

2 Select the machine, and click [Options & Supplies].

3 Click [Show Printer Webpage].

4 Logging in to the Remote UI

- To change the AirPrint settings, it is necessary to log in as an administrator.

■ Configuring the Screen for AirPrint

If you log in with administrator privileges, you can also change the AirPrint settings from the page for AirPrint.

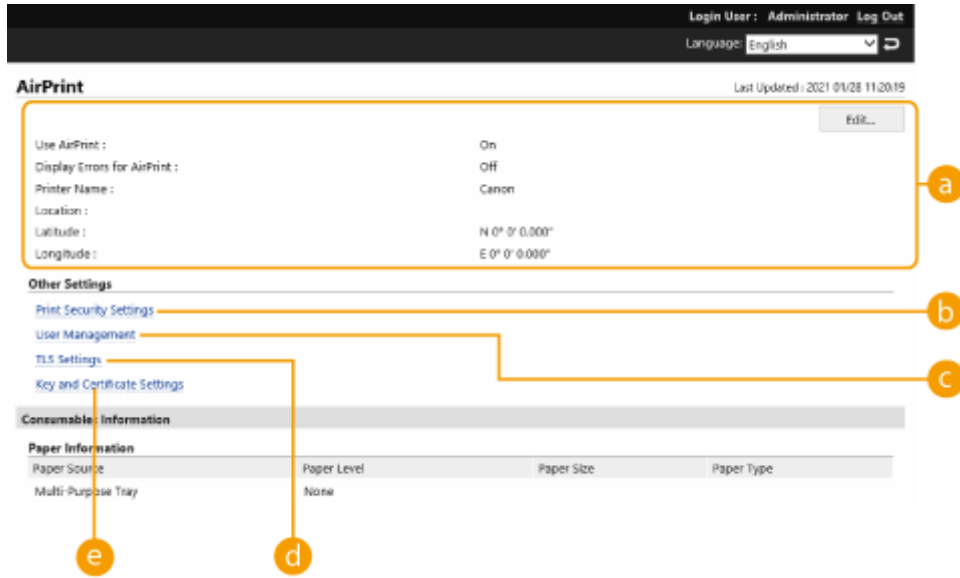

a [AirPrint]

Enables you to check the values entered in the AirPrint settings, such as the name and location of the machine. You can click [Edit] to change the settings.

b [Print Security Settings]

Specify the settings required to print using TLS and authentication.

If <IPP Print Settings> is already set, the existing settings are displayed. The values registered in [Print Security Settings] change according to the values in <IPP Print Settings>.

c [User Management]

You can add/edit users to authenticate. ▶ **Managing Users(P. 172)**

d [TLS Settings]

Enables you to change the key and certificate used for TLS. ▶ **Configuring the Key and Certificate for TLS(P. 223)**

e [Key and Certificate Settings]

Enables you to generate and install a key and certificate, or request a certificate to be issued. ▶ **Configuring the Key and Certificate for TLS(P. 223)**

■ **Checking Consumables and the Device Version**

You can check information regarding the paper sources of the machine, the remaining amount of toner, and the device version.

Trademarks

Apple, Bonjour, iPad, iPhone, iPod touch, Mac, macOS, OS X and Safari are trademarks of Apple Inc., registered in the U.S. and other countries. AirPrint and the AirPrint logo are trademarks of Apple Inc.

iOS is a trademark or registered trademark of Cisco in the U.S. and other countries and is used under license.

Printing with AirPrint

7L2J-039

You can print from an iPad, iPhone, iPod touch, or Mac without using a printer driver.



▶ **Printing from an iPad, iPhone, or iPod touch**(P. 153)

▶ **Printing from a Mac**(P. 154)

System Requirements

One of the following Apple devices is required to print with AirPrint.

- iPad (all models)
- iPhone (3GS or later)
- iPod touch (3rd generation or later)
- Mac (Mac OS X 10.7 or later)*

* OS X 10.9 or later when using a USB connection

Network Environment

One of the following environments is required.

- An environment where an Apple device and the machine are connected to the same LAN
- An environment where an Apple device and the machine are connected directly
- An environment where a Mac is connected to the machine via USB

Printing from an iPad, iPhone, or iPod touch

1 Make sure that the machine is turned ON and connected to the Apple device.

- For how to make sure of this, see ▶ **Setting up the Network Environment**(P. 8) .
- For information on the Direct Connection, see ▶ **Connecting Directly**(P. 144) .

2 From the application on your Apple device, tap  to display the menu options.

3 Tap [Print].

4 Select this machine from [Printer].

➡ The printers connected to the network are displayed here. Select this machine in this step.

! IMPORTANT:

- The screen for selecting the machine in [Printer] is not displayed for applications that do not support AirPrint. In this case, printing cannot be performed.

5 Specify the print settings as necessary.**NOTE:**

- The available settings and paper sizes differ depending on the application you are using.

6 Tap [Print].

⇒ Printing starts.

NOTE:**Checking the print status**

- During printing, press the Home button of the Apple device twice ► tap [Print].

Printing from a Mac

1 Make sure that the machine is turned ON and connected to the Mac.

- For how to make sure of this, see ► [Setting up the Network Environment\(P. 8\)](#) .

2 From your Mac, add the machine in [System Preferences] ► [Printers & Scanners].**3 Open a document in an application and display the print dialog box.**

- How to display the print dialog box differs for each application. For more information, see the instruction manual for the application you are using.

4 Select the machine in the print dialog box.

⇒ The printers added to the Mac are displayed. Select the machine in this step.

5 Specify the print settings as necessary.**NOTE:**

- The available settings and paper sizes differ depending on the application you are using.

6 Click [Print].

⇒ Printing starts.

NOTE

- You can specify whether to display an error screen on the control panel if printing cannot be performed as expected due to a problem with the print data. For details, see [▶<Display Errors for AirPrint>\(P. 370\)](#) .

If AirPrint Cannot Be Used

7L2J-03A

If AirPrint cannot be used, try taking the following solutions.

- Make sure that the machine is turned ON. If the machine is turned ON, first turn it OFF, then wait for at least 10 seconds and then turn it back ON to check if the problem is solved.
- Make sure that no error messages are displayed on the machine.
- Make sure that Apple devices and the machine are connected to the same LAN. If the machine is turned ON, it may take several minutes before the machine is ready for communication.
- Make sure that Bonjour on your Apple device is enabled.
- Make sure that the machine is configured to enable operations from a computer even when no department ID and password are entered.
- For printing, make sure that the paper is loaded in the machine and the machine has sufficient toner levels remaining. **▶ Displaying the Screen for AirPrint(P. 151)**

Printing with Default Print Service (Android)

7L2J-03C

If your Android terminal supports Default Print Service, you can print from the Default Print Service of your Android terminal.

To print with the machine using Default Print Service, it is necessary to enable Mopria®.

Confirming Mopria® settings



Log in to the Remote UI with Administrator privileges (▶ **Starting the Remote UI(P. 262)**)
▶ [Settings/Registration] ▶ [Network Settings] ▶ [Mopria Settings] ▶ select the [Use Mopria] check box ▶ [OK]

NOTE

- In order to use the Canon machine/printer from the Default Print Service of your Android terminal, you must first configure the following settings on your Android terminal.
 - Enable Default Print Service.
 - Disable or uninstall Mopria®.
 - Disable or uninstall Canon Print Service.

Managing the Machine

Managing the Machine	160
Applying a Security Policy to the Machine	162
Using a Password to Protect the Security Policy Settings	163
Configuring the Security Policy Settings	165
Security Policy Setting Items	167
Managing Users	172
Configuring the Personal Authentication Management Settings	174
Registering User Information in the Local Device	177
Importing/Exporting User Data	181
Adding and Editing User Information in a CSV File	184
Registering Server Information	188
Configuring the Authentication Functions	194
Using Personal Authentication to Manage Printing via a Computer	198
Using Other Convenient Personal Authentication Management Functions	199
Setting the Department ID Management	200
Changing the System Manager ID and PIN	201
Configuring the Department ID Management Settings	203
Using Department IDs to Manage Printing via Computer	206
Setting an Authentication/Password Policy	207
Configuring the Network Security Settings	210
Restricting Communication by Using Firewalls	212
Specifying IP Addresses in Firewall Settings	213
Specifying MAC Addresses in Firewall Settings	216
Configuring the Firewall of the Sub Line	218
Setting a Proxy	221
Configuring the Key and Certificate for TLS	223
Generating the Key and Certificate for Network Communication	227
Generating a Key and Certificate Signing Request (CSR)	229
Registering a Key and Certificate for Network Communication	232
Configuring the Expiration Check Method for Received Certificates	235
Retrieving/Updating a Certificate from an SCEP Server	238
Configuring the IPSec Settings	244
Configuring the IEEE 802.1X Authentication Settings	251
Restricting the Machine's Functions	254
Restricting Printing from a Computer	255
Restricting the Use of Memory Media	259

Restricting Use of the Operation Panel	260
Managing the Machine from a Computer (Remote UI)	261
Starting the Remote UI	262
Checking the Status and Logs	266
Turning OFF/Restarting the Machine	269
Managing the Logs	270
Importing/Exporting the Setting Data	273
Importing/Exporting All Settings	275
Updating the Firmware	279
Updating the Firmware (Distribution)	281
Setting Scheduled Updates	284
Displaying Messages from the Administrator	286
Installing System Options	287
Initializing Settings	289
Functions Linked to Cloud Service	291

Managing the Machine

7L2J-03E

To reduce the various risks associated with using this machine, such as the leakage of personal information or unauthorized use by third parties, constant and effective security measures are required. Designate an administrator to handle important machine settings, such as the user management and security settings, to ensure that the machine is used safely.

■ Configuring the Basic Management System

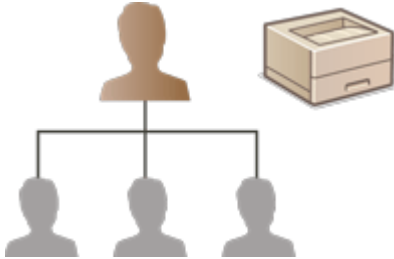

- ▶ Applying a Security Policy to the Machine(P. 162)
- ▶ Managing Users(P. 172)
- ▶ Configuring the Network Security Settings(P. 210)

■ Limiting Risks from Negligence, Operation Errors, and Misuse



- ▶ Restricting the Machine's Functions(P. 254)

■ Ensuring Effective Management

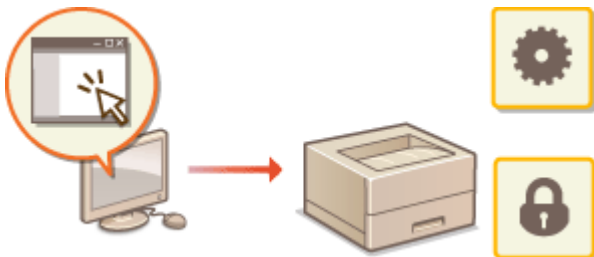

- ▶ Managing the Machine from a Computer (Remote UI)(P. 261)

■ Managing the System Configuration and Settings

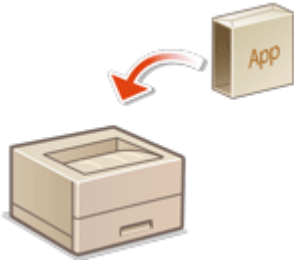

- ▶ **Installing System Options(P. 287)**
- ▶ **Initializing Settings(P. 289)**

Applying a Security Policy to the Machine

7L2J-03F

It is a common practice for organizations to adopt a security policy that defines basic information security objectives and standards, which requires information devices such as computers and printers/multifunctional printers to be operated accordingly. On this machine, multiple settings related to security policy can be managed in batch via the Remote UI, and a dedicated password can be set up so that only the information security administrator is able to modify the settings. Before configuring these settings, make sure that the Remote UI is set up to use TLS. **▶Starting the Remote UI(P. 262)**

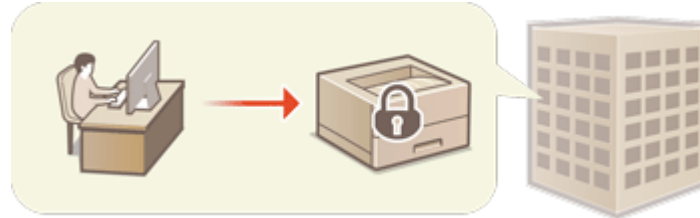

- ▶Using a Password to Protect the Security Policy Settings(P. 163)
- ▶Configuring the Security Policy Settings(P. 165)
- ▶Security Policy Setting Items(P. 167)

! IMPORTANT

- The purpose of the security policy settings is to manage all functions and settings related to information security, and not to actually prevent information leakage itself.

Using a Password to Protect the Security Policy Settings

7L2J-03H

It is recommended that you use a password to protect the machine settings related to security policy. By setting a password, the privilege for modifying the security policy settings can be restricted only to the information security administrators who know the password.

1 Start the Remote UI. ▶Starting the Remote UI(P. 262)

2 Click [Settings/Registration] on the portal page. ▶Remote UI Screen(P. 263)

3 Click [Security Settings] ▶ [Security Policy Settings].

⇒ The [Confirm Security Policy] page is displayed.

4 Click [Password Settings].

5 Enter a password and click [OK].

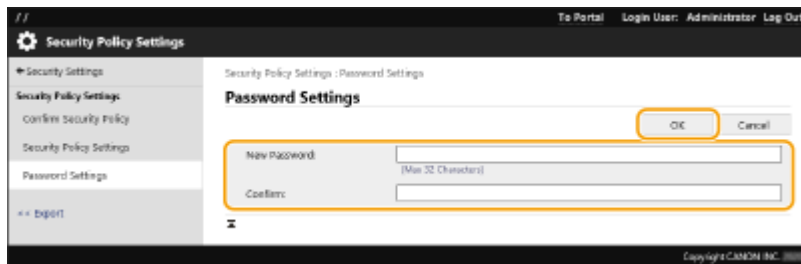

- Use alphanumeric characters or symbols for the password.
- Make sure that the password is entered correctly, and enter the new password again in [Confirm:].

NOTE:

To change the password

- Enter the current password in [Current Password:] and the new password in [New Password:], then enter the new password again in [Confirm:] and click [OK].

To remove the password

- Enter the current password in [Current Password:], and click [OK] without entering any value for [New Password:] or [Confirm:] (leave them blank). If an input character limit has been configured in [Password Settings Policy], a value must be entered for this setting. Cancel the limit before removing the password.

▶Security Policy Setting Items(P. 167)

! IMPORTANT

- Make sure that you do not forget your password. If you forget your password, contact your dealer or service representative.

NOTE

- To set/change the password, it is necessary to log in to the Remote UI with Administrator privileges.
- If a password is set, it will be required for authentication in order to initialize the machine. After authentication is performed and the machine is initialized, the password will be deleted.  **Initializing Settings(P. 289)**

Configuring the Security Policy Settings

7L2J-03J

Machine settings related to information security can be applied and managed in batch. It is recommended that the information security administrator in charge of managing your security policy apply the security policy to the machine in accordance with the policy of your organization. To configure the security policy, log in to the Remote UI with Administrator privileges.

- 1 Start the Remote UI. [▶Starting the Remote UI\(P. 262\)](#)
- 2 Click [Settings/Registration] on the portal page. [▶Remote UI Screen\(P. 263\)](#)
- 3 Click [Security Settings] ▶ [Security Policy Settings].
- 4 Click [Security Policy Settings].

⇒ The setting precautions are displayed. Make sure to read and understand the contents.

NOTE:

- If no password has been configured ([▶Using a Password to Protect the Security Policy Settings\(P. 163\)](#)), read the contents and click [OK] to proceed to step 6.

- 5 Enter the password and click [Log In].
- 6 Configure the necessary items and click [OK].

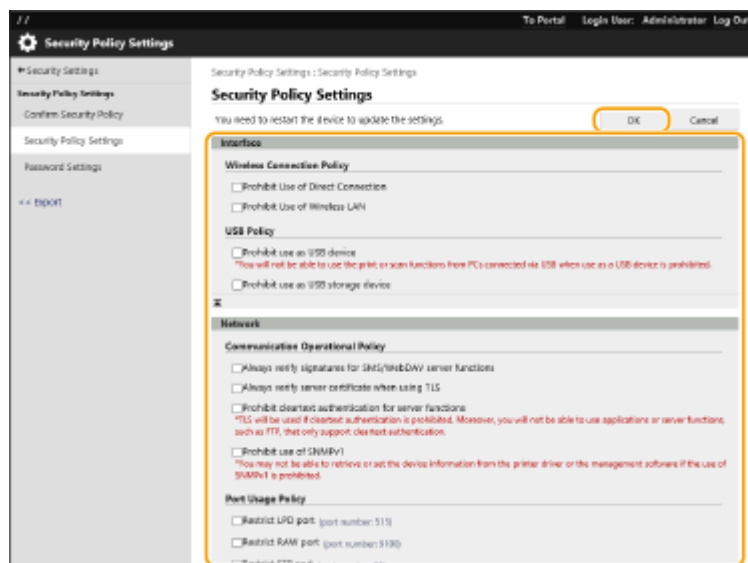

- For information on the settings, see [▶Security Policy Setting Items\(P. 167\)](#) .

! IMPORTANT:

- The settings related to items indicated with a check mark here cannot be changed using <Set> or the Remote UI.

- For any machine settings that were changed when the security policy settings were applied, you cannot simply clear the check box to restore the previously set value. To change the settings, use <Set> or the Remote UI.

7 Click [OK].

NOTE

- If a security policy has been configured, a message indicating that functions and operations are restricted is displayed when the [Settings/Registration] screen is displayed on the control panel or the Remote UI.

■ Applying the Security Policy Settings to Another Device

You can import and export the machine's security policy settings. By applying the same policy to multiple devices*, you can manage all of the devices in your organization using identical settings. ▶ **Importing/Exporting the Setting Data(P. 273)**

* Only Canon devices that are compatible with security policy settings

NOTE

- The security policy settings can only be imported if the security policy setting password on the exporting machine matches that of the importing machine, or if no password has been set for the importing machine. If no password has been set for the importing machine, the password configured for the exporting machine is set to the importing machine.

Security Policy Setting Items

7L2J-03K

The setting items related to the security policy of the machine are described below. Select the check boxes for the items that you want to apply on the setting screen.

■ [Interface]

[Wireless Connection Policy]

Prevent unauthorized access by prohibiting wireless connections.

[Prohibit Use of Direct Connection]	<Use Direct Connection> and <Keep Enabled If SSID/Net. Key Specified> are set to <Off>. It is not possible to access the machine from mobile devices.	<p>▶<Connecting Directly>(P. 144)</p> <p>▶<Network>(P. 362)</p>
[Prohibit Use of Wireless LAN]	If <Select Interface> is set to <Wireless LAN> or <Wired LAN + Wireless LAN>, it changes to <Wired LAN>. Wireless connections can no longer be made via a wireless LAN router or access point.	▶<Select Interface>(P. 370)

[USB Policy]

Prevent unauthorized access and data breaches by prohibiting USB connection.

[Prohibit use as USB device]	<Use as USB Device> is set to <Off>. It is not possible to connect to a computer via USB.	▶<Use as USB Device>(P. 374)
[Prohibit use as USB storage device]	<Use USB Storage Device> is set to <Off>. It is not possible to use USB storage devices.	▶<Use USB Storage Device>(P. 374)

■ [Network]

[Communication Operational Policy]

Increase the security of communications by requiring the verification of signatures and certificates.

Always verify signatures for SMS/ WebDAV server functions]	There are no setting items that the security policy is applied to for the machine.	-
[Always verify server certificate when using TLS]	<p>The following settings are set to <On>, and a check mark is added to <CN>.</p> <ul style="list-style-type: none"> • <Confirm TLS Certificate for POP RX> • <Confirm TLS Certificate Using AddOn App> <p>During TLS communication, verification will be performed for digital certificates with common names.</p>	<p>▶<Confirm TLS Certificate for POP RX>(P. 390)</p> <p>▶<Confirm TLS Certificate Using AddOn App>(P. 398)</p>
[Prohibit cleartext authentication for server functions]	<ul style="list-style-type: none"> • <Use FTP Printing> in <FTP Print Settings> is set to <Off>. • <SMTP RX> in <E-mail Settings> ▶ <Communication Settings> is set to <Always Use TLS>. • [Authentication Method] in [Network Settings] ▶ [Dedicated Port Authentication Method] is set to [Mode 2]. <p>When using the machine as a server, plain text authentication and functions that use plain text authentication are not available.</p>	<p>▶<FTP Print Settings>(P. 364)</p> <p>▶<Communication Settings>(P. 390)</p> <p>▶<Specifying the Dedicated Port Settings>(P. 41)</p>

[Prohibit use of SNMPv1]	In <SNMP Settings>, <Use SNMPv1> is set to <Off>. It is not possible to use SNMPv1 when obtaining device information from the computer.	▶<SNMP Settings>(P. 367)
--------------------------	---	--------------------------

NOTE

- This setting does not apply to communication with IEEE 802.1X networks, even if the check box is selected for [Always verify server certificate when using TLS].
- If [Prohibit cleartext authentication for server functions] is selected and your device management software or driver version is old, it may not be possible to connect to the machine. Ensure that you are using the latest versions.

[Port Usage Policy]

Prevent external breaches by closing unused ports.

[Restrict LPD port (port number: 515)]	<LPD Print Settings> is set to <Off>. It is not possible to perform LPD printing.	▶<LPD Print Settings>(P. 364)
[Restrict RAW port (port number: 9100)]	<RAW Print Settings> is set to <Off>. It is not possible to perform RAW printing.	▶<RAW Print Settings>(P. 364)
[Restrict FTP port (port number: 21)]	In <FTP Print Settings>, <Use FTP Printing> is set to <Off>. It is not possible to perform FTP printing.	▶<FTP Print Settings>(P. 364)
[Restrict WSD port (port number: 3702, 60000)]	In <WSD Settings>, <Use WSD Print> and <Use WSD Browsing> are all set to <Off>. It is not possible to use WSD functions.	▶<WSD Settings>(P. 364)
[Restrict BMLinkS port (port number: 1900)]	There are no setting items that the security policy is applied to for the machine.	-
[Restrict IPP port (port number: 631)]	The <IPP Print Settings> and <Use Mopria> options are all set to <Off>. It is not possible to print using IPP or Mopria™.	▶<IPP Print Settings>(P. 365) ▶<Use Mopria>(P. 369)
[Restrict SMB port (port number: 139, 445)]	There are no setting items that the security policy is applied to for the machine.	-
[Restrict SMTP port (port number: 25)]	[SMTP RX] in [Network Settings - E-Mail Settings] ▶ [SMTP/POP Settings] is deselected and cannot be set. SMTP reception is not possible.	▶Configuring E-Mail Print Settings(P. 45)
[Restrict dedicated port (port number: 9002, 9006, 9007, 9011-9015, 9017-9019, 9022, 9023, 9025, 20317, 47545-47547)]	[Use Dedicated Port] is deselected and cannot be set. It is not possible to use dedicated ports.	▶Specifying the Dedicated Port Settings(P. 41)
[Restrict Remote Operator's Software port (port number: 5900)]	There are no setting items that the security policy is applied to for the machine.	-
[Restrict SIP (IP Fax) port (port number: 5004, 5005, 5060, 5061, 49152)]	There are no setting items that the security policy is applied to for the machine.	-
[Restrict mDNS port (port number: 5353)]	The following settings are set to <Off>. <ul style="list-style-type: none"> • <Use IPv4 mDNS> and <Use IPv6 mDNS> in <mDNS Settings>. • <Use Mopria> 	▶<mDNS Settings>(P. 364) ▶<Use Mopria>(P. 369)

	It is not possible to search the network or perform automatic settings using mDNS. It is also not possible to print using Mopria™.	
[Restrict SLP port (port number: 427)]	In <Multicast Discovery Settings>, <Response> is set to <Off>. It is not possible to search the network or perform automatic settings using SLP.	▶<Multicast Discovery Settings>(P. 365)
[Restrict SNMP port (port number: 161)]	In <SNMP Settings>, the <Use SNMPv1> and <Use SNMPv3> options are set to <Off>. It is not possible to obtain device information from the computer or configure settings using SNMP.	▶<SNMP Settings>(P. 367)

■ [Authentication]

[Authentication Operational Policy]

Prevent unregistered users from performing unauthorized operations by implementing secure user authentication.

[Prohibit guest users to use device]	<Set Administrator PIN> is set to <On>. It becomes [Standard Authentication Mode] if [Guest Authentication Mode] is set for [Authentication Mode:] in [Remote UI Authentication]. In addition, [Guest Authentication Mode] can no longer be selected for [Authentication Mode:] in [Remote UI Authentication]. Unregistered users cannot access settings that require Administrator privileges, and print jobs from computers are canceled.	▶<Set Administrator PIN>(P. 395) ▶Configuring detailed settings for authentication functions(P. 195)
[Force setting of auto logout]	<Auto Reset Time> is enabled. The user is automatically logged out if no operations are performed for a specified period of time. Select [Time Until Logout:] on the Remote UI setting screen.	▶<Auto Reset Time>(P. 359)

[Password Operational Policy]

Impose strict limits for password operations.

[Prohibit caching of password for external servers]	[Prohibit Caching of Authentication Password for Access to External Servers] is selected and [Save authentication information for login users] is deselected. Users will always be required to enter a password when accessing an external server. The authentication information of the login user is no longer retained.	▶Setting a Password Policy(P. 208) ▶Registering Server Information(P. 188)
[Display warning when default password is in use]	[Display Warning When Default Password Is in Use] is selected. A warning message will be displayed whenever the machine's factory default password is used.	▶Setting a Password Policy(P. 208)
[Prohibit use of default password for remote access]	[Allow Use of Default Password for Remote Access] is deselected. It is not possible to use the factory default password when accessing the machine from a computer.	▶Setting a Password Policy(P. 208)

[Password Settings Policy]

Prevent third parties from easily guessing passwords by setting a minimum level of complexity and a period of validity for user authentication passwords.

Managing the Machine

[Set minimum number of characters for password]	[Set Minimum Number of Characters for Password] is deselected. It is not possible to set a password with fewer characters than the number specified for [Minimum Number of Characters].	➤ Setting a Password Policy(P. 208)
[Set password validity period]	[No Expiry for Password] is deselected. [Set Password Validity Period] is selected. Specify the password expiration period in [Validity Period:].	➤ Registering User Information in the Local Device(P. 177) ➤ Setting a Password Policy(P. 208)
[Prohibit use of 3 or more identical consecutive characters]	[Prohibit Use of 3 or More Identical Consecutive Characters] is selected. It is not possible to set a password that includes the same character repeated three or more times consecutively.	➤ Setting a Password Policy(P. 208)
[Force use of at least 1 uppercase character]	[Force Use of at Least 1 Uppercase Character] is selected. Passwords are required to include at least one uppercase alphabetic character.	➤ Setting a Password Policy(P. 208)
[Force use of at least 1 lowercase character]	[Force Use of at Least 1 Lowercase Character] is selected. Passwords are required to include at least one lowercase alphabetic character.	➤ Setting a Password Policy(P. 208)
[Force use of at least 1 digit]	[Force Use of at Least 1 Digit] is selected. Passwords are required to include at least one numeric character.	➤ Setting a Password Policy(P. 208)
[Force use of at least 1 symbol]	[Force Use of at Least 1 Symbol] is selected. Passwords are required to include at least one symbol.	➤ Setting a Password Policy(P. 208)

[Lockout Policy]

Block users from logging in for a specified period of time after a certain number of consecutive invalid login attempts.

[Enable lockout]	[Enable Lockout] in [Authentication Function Settings] is selected. Specify the values for [Lockout Threshold] and [Lockout Period].	➤ Setting a Lockout Policy(P. 207)
------------------	---	---

■ [Key/Certificate]

Protect important data by preventing the use of weak encryption, or by saving encrypted user passwords and keys in a designated hardware component.

[Prohibit use of weak encryption]	[Prohibit Use of Weak Encryption] is selected. It is not possible to use weak encryption. When the check box is selected, [Prohibit use of key/certificate with weak encryption] can be selected.	➤ Setting the Security Strength and Encryption Method(P. 225)
[Prohibit use of key/certificate with weak encryption]	[Prohibit Use of Key/Certificate with Weak Encryption] in [Prohibit Use of Weak Encryption] is selected. It is not possible to use a key or certificate with weak encryption.	➤ Setting the Security Strength and Encryption Method(P. 225)
[Use TPM to store password and key]	There are no setting items that the security policy is applied to for the machine.	-

■ [Log]

You can periodically survey how the machine is used, by requiring logs to be recorded.

[Force recording of audit log]	<p>The following settings are set to <On>.</p> <ul style="list-style-type: none"> • <Display Job Log> • <Save Audit Log> • <Retrieve Network Authentication Log> • <Rtrv Log w/Mngt Sftwr> in <Display Job Log> is set to <Allow>. <p>Audit logs are always recorded.</p>	<p>▶<Display Job Log>(P. 396) ▶<Save Audit Log>(P. 396) ▶<Retrieve Network Authentication Log>(P. 396)</p>
[Force SNTP settings]	<p>In <SNTP Settings>, <Use SNTP> is set to <On>. Time synchronization via SNTP is required. Enter a value for [NTP Server Address] on the Remote UI setting screen.</p>	<p>▶<SNTP Settings>(P. 364)</p>

■ [Job]

[Printing Policy]

Prevent information leakage from occurring when printing.

[Prohibit immediate printing of received jobs]	<p>[Force Hold] is selected. Only [Hold as Shared Job] in [Condition Settings] can be set for [Action]. Printing does not occur immediately, even when printing operations are performed.</p>	<p>▶<Configuring the Forced Hold Printing Settings>(P. 255)</p>
--	---	---

[Sending/Receiving Policy]

Limit the sending operations for destinations, and limit how received data is processed.

[Allow sending only to registered addresses]	There are no setting items that the security policy is applied to for the machine.	-
[Force confirmation of fax number]	There are no setting items that the security policy is applied to for the machine.	-
[Prohibit auto forwarding]	There are no setting items that the security policy is applied to for the machine.	-

■ [Storage]

Delete unnecessary data in the memory of the machine to prevent information leaks.

[Force complete deletion of data]	There are no setting items that the security policy is applied to for the machine.	-
-----------------------------------	--	---

Managing Users

You can ensure a higher level of security and efficiency by utilizing a user authentication application (login service) to manage the users of the machine ([▶Login Service\(P. 172\)](#)). It is recommended that the administrator manage all users in accordance with your operating environment and required security measures. [▶User Management Functions\(P. 172\)](#)

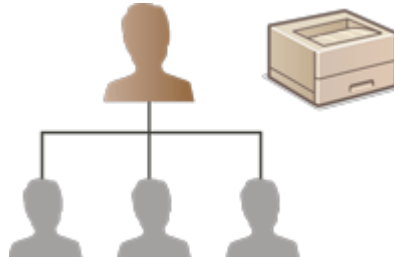

[▶Configuring the Personal Authentication Management Settings\(P. 174\)](#)

[▶Using Other Convenient Personal Authentication Management Functions\(P. 199\)](#)

Login Service

A user authentication application (login service) called "User Authentication" is used as the primary method of managing the users of the machine. With the User Authentication login service, personal authentication can be performed for users based on the user name and password registered for each user. The user information is checked either on the database inside the machine or on an external authentication server. With the ability to precisely define which functions are available to each user, you can personalize machine operations and improve security by limiting access to certain functions. It may also be possible to use Department ID Management to manage groups, depending on the device used for authentication.

User Management Functions

User management can provide the advantages described below. To protect important data and reduce costs, you can limit access to the machine and define the range of operations that are available to users.

Preventing Unauthorized Use by Third Parties

Because machine usage is limited to approved users, information leakage due to unauthorized use by third parties is prevented, even if the machine is located in a busy area that is open to outside parties.

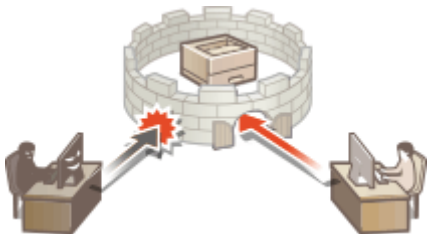

Setting the Privilege Levels

With personal authentication management, you can define the range of available operations by specifying the role (privilege level) for each user. Roles include the "Administrator" role, with full access privileges, and the "GeneralUser" role that cannot use items that require Administrator privileges.



Setting Usage Restrictions

Personal authentication management enables a user with Administrator privileges to manage the range of operations that are available to users.



Managing Groups of Users

Users can be assigned to groups based on Department ID (Department ID Management), enabling you to check the total number of printed pages for each Department ID. You can also set specific limits for each Department ID, such as a maximum of 500 printed pages. This function can help boost cost awareness and provide hints on how to improve your operations.



NOTE

Associating User Accounts with Keychains for Smooth Operations

- When authentication information different from the authentication information used when logging in is required, the authentication information has to be entered once, but does not need to be entered again once authentication is successful. This authentication information is called a keychain. Since keychains are associated with user accounts, authentication information does not need to be entered again, even if the power of the machine is turned OFF.

Associating User Accounts with Department IDs to Restrict the Number of Prints

- User Authentication user accounts can be associated with Department IDs. By specifying print restrictions for Department IDs in advance, you can apply restrictions on the number of prints for each department that a user belongs to. For information on associating user accounts with Department IDs, see [Registering User Information in the Local Device\(P. 177\)](#) . For information on specifying restrictions according to department, see [Configuring the Department ID Management Settings\(P. 203\)](#) .

Configuring the Personal Authentication Management Settings

7L2J-03R

The User Authentication login service performs personal authentication based on the information registered for each user, enabling you to limit the users who can access the machine. User information registration (authentication) can be performed on this machine and on an external server. You can configure the authentication system to use only this machine as the authentication device, or you can additionally specify an Active Directory or LDAP authentication server on the network as an authentication device to utilize the existing user information registered on the server ([▶ Authentication Device\(P. 174\)](#)). For the user login method, you can enter authentication information ([▶ Login Method\(P. 174\)](#)). Before configuring the user authentication settings, decide the authentication device and login method. [▶ Configuring Personal Authentication Management with User Authentication\(P. 175\)](#)



- [▶ Registering User Information in the Local Device\(P. 177\)](#)
- [▶ Importing/Exporting User Data\(P. 181\)](#)
- [▶ Registering Server Information\(P. 188\)](#)
- [▶ Configuring the Authentication Functions\(P. 194\)](#)
- [▶ Using Personal Authentication to Manage Printing via a Computer\(P. 198\)](#)

Authentication Device

The authentication devices described below can be used for personal authentication management. Each type of authentication device requires a different environment and settings. Confirm your system environment before configuring. [▶ System Specifications\(P. 519\)](#)

Local Device (This Machine)

User information is managed on the database inside the machine. User information is registered and edited from the Remote UI. When the local device is configured as a standalone authentication device, Department ID Management can also be performed at the same time. [▶ Registering User Information in the Local Device\(P. 177\)](#)

Active Directory/LDAP Server

In addition to the local device, you can specify an LDAP server or Windows Server with Active Directory installed as the authentication device. One advantage of using this type of device is that the users registered on the server can be added as general users without any changes. To provide administrator privileges to a user, the user must be assigned to a specific administrator group on the Active Directory or LDAP server. To specify the additional authentication device, you must register the information of the server used for authentication. [▶ Registering Server Information\(P. 188\)](#)

Login Method

The user login methods described below are available for personal authentication management.

Keyboard Authentication (Remote UI Only)

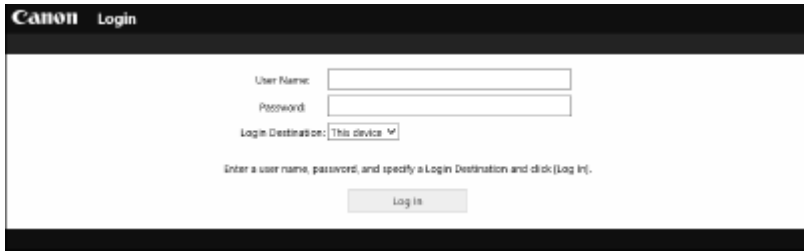

With this method, users log in by entering a user name and password. This method is available regardless of the authentication device that is used.

NOTE

- Users cannot log in from the control panel of the machine with a user name and password.

Configuring Personal Authentication Management with User Authentication

Configure the personal authentication management settings in the order described below.



Check the basic configuration.

- Is the machine properly connected to the computer? ▶ **Setting up the Network Environment(P. 8)**
- If you are using an authentication server, have the DNS settings been configured for the machine?
- If you are using an authentication server, have the date and time been properly set? ▶ **Setting the Date/Time(P. 7)**



Check the login service.

- Log in to the Remote UI with Administrator privileges, click [Settings/Registration] ▶ [User Management] ▶ [Authentication Management] ▶ [Authentication Service Information], and check that the login service is indicated as User Authentication.



Configure the authentication server settings.

- Register user information on the local device and specify the authentication server. ▶ **Registering User Information in the Local Device(P. 177)**
- ▶ **Registering Server Information(P. 188)**



4



Select the user authentication system.

- ▶ **Configuring the Authentication Functions(P. 194)**
- ▶ **Using Personal Authentication to Manage Printing via a Computer(P. 198)**

IMPORTANT

- Make sure to log out after you finish using the Remote UI. If you close the Remote UI without logging out, it may take a long time to log in next time.

Registering User Information in the Local Device

7L2J-03S



To perform personal authentication management, you must first register user information in the database of the machine.

1 Start the Remote UI. ▶ Starting the Remote UI(P. 262)

2 Click [Settings/Registration] on the portal page. ▶ Remote UI Screen(P. 263)

3 Click [User Management] ▶ [Authentication Management].

NOTE:

Disabling "Administrator"

- "Administrator" is registered as the default administrator name (user name). This user cannot be deleted but it can be disabled after adding a user with "Administrator" privileges. If the "Administrator" user is disabled, you cannot change settings that only the "Administrator" user can configure, on the control panel of the machine.

4 Click [Add User].

NOTE:

To edit user information

- Click [Edit] for the user information that you want to edit, make the necessary changes, and click [Update].

To delete user information

- Select the check box for the user information that you want to delete, and click [Delete] ▶ [OK].

5 Enter the necessary information.

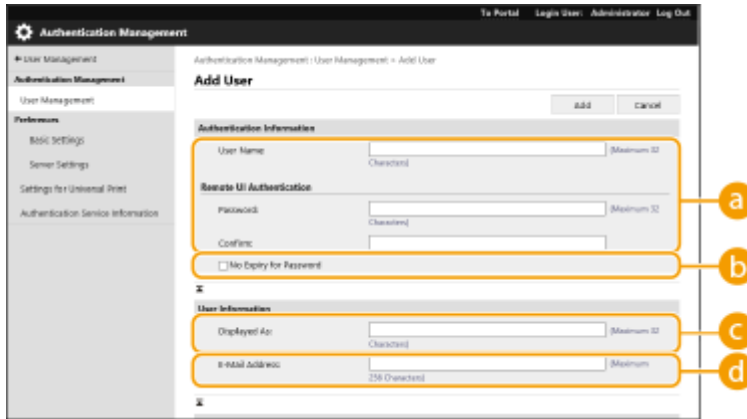

a [User Name:] / [Password:] / [Confirm:]

Enter the user name and password. For confirmation, enter the password again in [Confirm:]. Single-byte or double-byte characters can be used for the user name.

NOTE:

- When a detailed password policy is set, enter a password that complies with the password policy. ▶ **Setting a Password Policy(P. 208)**
- b [No Expiry for Password]**
Select the check box to set the password of the user to register to have no expiration date.
- c [Displayed As:]**
Enter the name of the user. The display name is displayed as the user name for forced hold printing.
- d [E-Mail Address:]**
Enter the e-mail address that the user is using on devices such as computers.

NOTE:

- It is also possible for general users to change their own password.
- Selecting the [Allow e-mail address settings] check box enables general users to specify e-mail addresses.
▶ **Configuring the User Login Methods and Authentication Devices(P. 194)**

6 Specify other required settings.

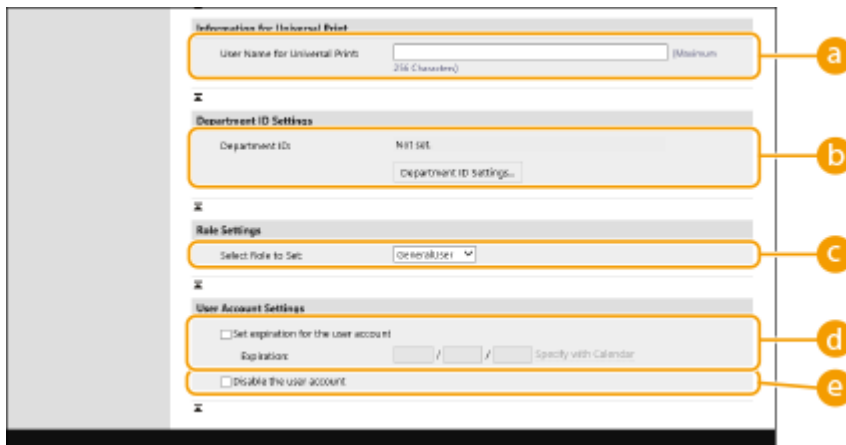

a [User Name for Universal Print:]

If [Settings/Registration] ▶ [Network Settings] ▶ [Settings for Universal Print] is enabled, you can enter the email address or phone number used in the Microsoft 365 account of the user with which Universal Print jobs are associated.

b [Department ID:]

When using Department ID Management, you must click [Department ID Settings...] and select the Department ID from the list to assign to the user. First, register the necessary Department IDs in [Register

New Department...] on the list screen. If the Department ID that you specify here is later deleted, make sure to change this setting. [▶Configuring the Department ID Management Settings\(P. 203\)](#)

c [Select Role to Set:]

The user privileges (roles) listed below can be selected. Also specify the settings here when adding an administrator. The available setting items vary depending on the privileges ([▶Settings/Registration\(P. 295\)](#)).

[Administrator]	Allows all operations as an administrator of the machine.
[GeneralUser]	Allows general user privileges.

d [Set expiration for the user account]

When setting a period of validity for the account, select the check box and enter a value for [Expiration].

e [Disable the user account]

Select the check box to temporarily disable the account.

7 Click [Add].

NOTE

Batch importing/batch exporting

- This setting can be imported/exported with models that support batch importing of this setting. [▶ Importing/Exporting the Setting Data\(P. 273\)](#)
- This setting is included in [Settings/Registration Basic Information] when batch exporting. [▶Importing/Exporting All Settings\(P. 275\)](#)

TIPS

Check for unregistered Department IDs

- If you click [Check Unregistered Department ID...] on the screen displayed in step 4, you can find out Department IDs that are not registered in the machine by checking Department IDs assigned to the users against Department IDs registered in the machine.

Batch settings for Department IDs

- If you click [Batch Settings for Department ID...] on the screen displayed in step 4, you can create new Department IDs and apply settings for all users.
- If the user name is comprised of numbers and is seven digits or fewer, the same number is assigned to the same user as the Department ID. If the password of the same user is registered as a number that is seven digits or fewer, it is also set as the PIN for that Department ID.
- If the user name and password do not meet the above conditions, a Department ID is automatically assigned starting from 0000001, and 0 (none) is set for the PIN.

Registering the Department ID as the User Name

- If you click [Add User Using Department ID...] on the screen in step 4, a new user with the same name as the Department ID is registered. When keyboard authentication is used, authentication can be performed using numeric key entry only.

LINKS

- ▶ **Registering Server Information(P. 188)**
- ▶ **Configuring the Authentication Functions(P. 194)**
- ▶ **Using Personal Authentication to Manage Printing via a Computer(P. 198)**

Importing/Exporting User Data

7L2J-03U

You can save user information stored in the machine to a computer (export), as well as load user information from other machines into the machine you are using (import). This is useful when you want to register multiple users at once.

▶ **Exporting User Data(P. 181)**

▶ **Manually Importing User Data(P. 181)**

NOTE

- For information on editing a CSV file for importing, see ▶ **Adding and Editing User Information in a CSV File(P. 184)** .
- If duplicates of data exist in a CSV file for importing, the version of the data that was read first will be prioritized and registered.
- It is recommended that you export the registered/edited user data to make a backup copy.

Exporting User Data

1 Start the Remote UI. ▶ **Starting the Remote UI(P. 262)**

2 Click [Settings/Registration] on the portal page. ▶ **Remote UI Screen(P. 263)**

3 Click [User Management] ▶ [Authentication Management].

4 Click [Export].

5 Select the file format, and click [Start Export].

- User information created in the file format that can be used with User Authentication is exported. The file extension is ".csv."

6 Follow the instructions on the screen to specify the location to store the file.

⇒ The csv file is stored.

Manually Importing User Data

You can manually specify data for importing and update user information.

1 Start the Remote UI. ▶ **Starting the Remote UI(P. 262)**

2 Click [Settings/Registration] on the portal page. ▶ Remote UI Screen(P. 263)

3 Click [User Management] ▶ [Authentication Management].

4 Click [Import] ▶ [Manual Import Settings...]

5 Specify the required settings.

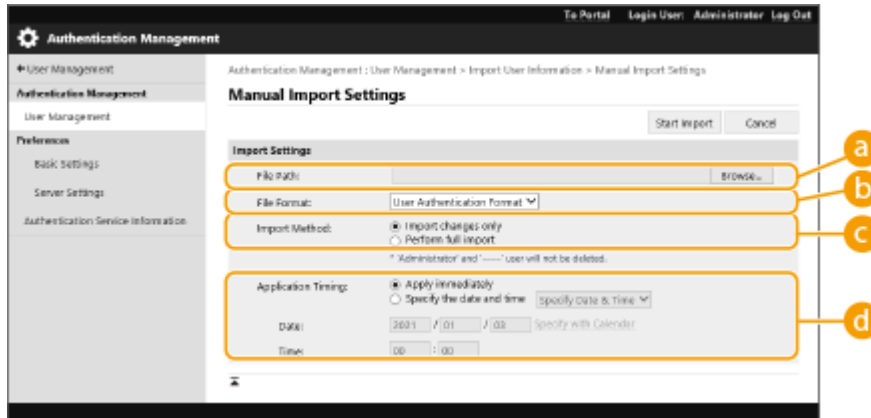

a [File Path:]

Specify the path of the file for importing.

b [File Format:]

Select the file format for importing.

- <User Authentication Format>:

Imports user information created in the file format that can be used with User Authentication. The file extension is "csv."

c [Import Method:]

Select whether to import only updated or added user data, or all user data.

NOTE:

- If you select [Perform full import] and a user with the same user name is already registered, the user information is overwritten.
- When importing information of a user who accesses the Advanced Box with SMB, specify the appropriate value in the "password" column. If you export the data from the machine and import it to the other machine without performing the above operation, authentication may fail. (The value is "*****" when exported.)
- When performing a complete import, any users not listed in the imported files are deleted from the machine. However, "-----" and "Administrator", which are registered by default, will remain even if they are not listed in the imported files.

d [Application Timing:]

Select [Apply immediately] or [Specify the date and time]. If you select [Specify the date and time], enter the desired date and time or the time only.

NOTE:

- If the user information cannot be reflected at the specified time because the machine is turned OFF or is completely in the Sleep mode, the information is reflected when the machine recovers.

6 Click [Start Import]







NOTE:

- If the Department ID (dept_id) and PIN (dept_pin) are written in the imported CSV file, [Check Unregistered Department ID] will be displayed after importing is complete. Perform Department ID registration.

Adding and Editing User Information in a CSV File

7L2J-03W

This section describes the content of each column in a CSV file used for importing or exporting. Refer to this section when editing CSV files. However, if "No" is written in the "Change Required" section for a particular column, do not change the content of that column.

Column Name	Change Required	Valid Characters	Invalid Characters	Compatibility With Remote UI Screen	Notes
uid	Yes	1 to 32 characters	Control characters, single-byte spaces, and the following characters: \\/:*? <>[];,+@"		<ul style="list-style-type: none"> Must be input when importing. "@" may be available depending on a setting. ▶Configuring the User Login Methods and Authentication Devices(P. 194)
password	Yes	0 to 32 characters within the ISO885915 character set	Control characters		<ul style="list-style-type: none"> Output as "*****" (* x 8) when exporting. When updating the password, "*****" will be deleted and overwritten by the new password. However, when importing changes, even if you leave the field unspecified (blank), it will not be overwritten as empty (blank), but will instead retain the existing value. If this item is omitted when importing changes, the existing user will carry over the original password.
cn	Yes	0 to 32 characters	Control characters		N/A
cn;lang-ja;phonetic	Yes	0 to 32 characters	Control characters	See "Notes."	Displayed as "phonetic" if the display language is set to "Japanese."
mail	Yes	Combination of 0 to 256 alphanumeric characters and symbols	Control characters		N/A
dept_id	Yes	A number up to seven digits	Non-single-byte numeric characters		N/A
dept_pin	Yes	A number up to seven digits	Non-single-byte numeric characters		N/A

Managing the Machine

Column Name	Change Required	Valid Characters	Invalid Characters	Compatibility With Remote UI Screen	Notes
roleName	Yes	0 to 32 characters	Control characters, single-byte spaces, and the following characters: \\ / : * ? < > [] ; , = + @ " &		If this item is omitted, or if a name is specified that is not registered in role management, it will be changed to the initial role setting.
accountExpires	Yes	See "Notes."	See "Notes."		YYYYMMDD format. "235959" is automatically added as the time after importing.
accountDisabled	Yes	1 or 0	Any character besides "1" (disable) or "0" (enable)		N/A
createDate	Yes	See "Notes."	See "Notes."	- (N/A)	<ul style="list-style-type: none"> Output in the "YYYYMMDDhhmmssmmm" format when exporting. (The "T" is added in order to prevent corruption of the text.) When importing, input the information in one of the following formats. <ul style="list-style-type: none"> YYYYMMDDhhmmssmmm YYYYMMDDhhmmssmmm YYYYMMDD YYYYMMDD If you omit this item, the date and time of importing is used for the date and time of registration for new users. For existing users, the original registration date and time are carried over.
lastLoginDate	Yes	See "Notes."	See "Notes."	- (N/A)	<ul style="list-style-type: none"> The date and time that the user last logged in are stored. Output in the "YYYYMMDDhhmmssmmm" format when exporting. (The "T" is added in order to prevent corruption of the text.) When importing, input the information in one of the following formats. <ul style="list-style-type: none"> YYYYMMDDhhmmssmmm YYYYMMDDhhmmssmmm YYYYMMDD YYYYMMDD

Managing the Machine

Column Name	Change Required	Valid Characters	Invalid Characters	Compatibility With Remote UI Screen	Notes
					<ul style="list-style-type: none"> Used for determining whether a user has logged in and whether to perform automatic user deletion. If you omit this item, the date and time that the user last logged in are blank for new users. For existing users, date and time that the user last logged in are carried over.
dc	No	0 to 32 characters	Control characters	- (N/A)	Cannot be changed. It will be automatically assigned for the following users. <ul style="list-style-type: none"> Users registered following server authentication
uuid	No	-	-	-	Cannot be changed. Automatically assigned during user registration.
sdl_digest	No	-	-	-	Cannot be changed. Automatically generated when registering/changing password.
uac_advbox_digest1	No	-	-	-	Cannot be changed. Automatically generated when registering/changing password.
uac_advbox_digest2	No	-	-	-	Cannot be changed. Automatically generated when registering/changing password.
pin_digest	No	-	-	-	Cannot be changed. Automatically generated when registering/changing PIN.
server_user_flg	No	-	-	-	Cannot be changed. This is an identification flag for the user registered after completing server authentication.
server_user_gp_key	No	-	-	-	Cannot be changed. This is the group to which the user who is registered after completing server authentication belongs.
server_user_gp_value	No	-	-	-	Cannot be changed. This is the group to which the user who is registered after completing server authentication belongs.
CharSet	-	-	-	-	For UTF8, "CharSet:UTF8" will be written in the column line.

The screenshot shows the 'Add User' form in the Authentication Management interface. The form is divided into several sections, each with a title and a set of input fields or checkboxes. Orange callout boxes labeled 'a' through 'i' point to specific fields:

- a**: User Name field (Maximum 12)
- b**: Password field (Maximum 12)
- c**: Displayed As field (Maximum 12)
- d**: E-Mail Address field (Maximum 12)
- e**: Department ID field (Not set)
- f**: Department ID Settings dropdown
- g**: Select Role to Set dropdown (GeneralUser)
- h**: Set expiration for the user account checkbox and its associated input fields (Expiration: [] / [] / [] Specify with Calendar)
- i**: Disable the user account checkbox

NOTE

- The line at the beginning of the file is the column line.
- Items names may not appear in sequence.
- The encodings supported by CSV files are UTF-8, SJIS, BIG5, GB2312, and Korean.
- Text strings in exported CSV files are surrounded by "[" and "]" if any of the following conditions apply. When editing a CSV file and adding new text strings that meet the following conditions, surround any such text strings with "[" and "]".
 - Numbers starting with "0"
 - Numbers greater than 12 digits
 - Text strings surrounded by "[" and "]"

Registering Server Information

7L2J-03X



To specify an Active Directory or LDAP server as an additional authentication device, you must register the information of the server used for authentication. Conduct a connection test as necessary.

- 1 Start the Remote UI. ▶ Starting the Remote UI(P. 262)
- 2 Click [Settings/Registration] on the portal page. ▶ Remote UI Screen(P. 263)
- 3 Click [User Management] ▶ [Authentication Management].
- 4 Click [Server Settings] ▶ [Edit...].
- 5 Set the authentication server and domain information.

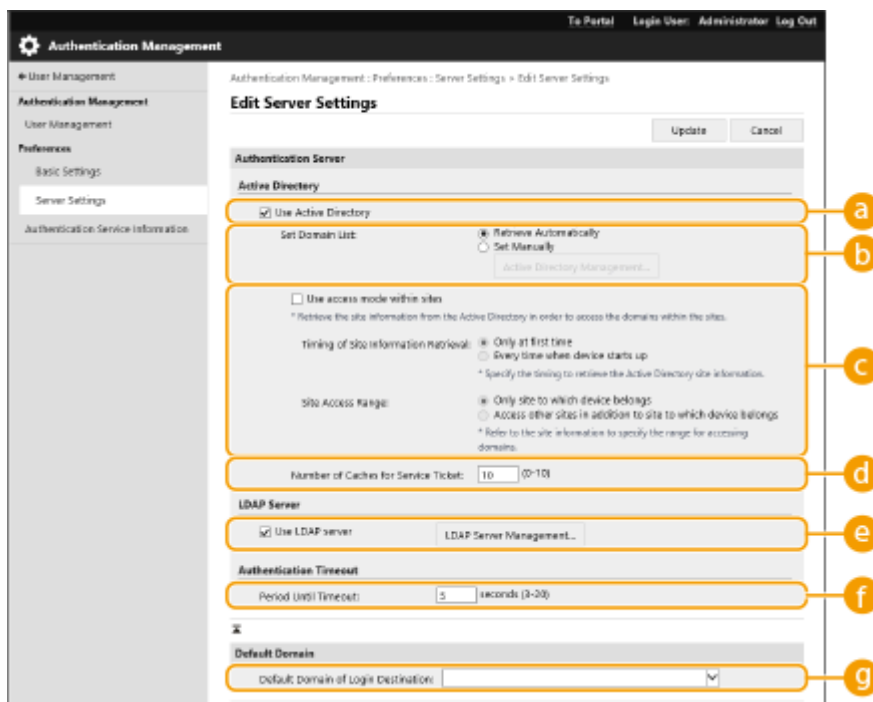

- a [Use Active Directory]
Select the check box when using Active Directory.
- b [Set Domain List:]
Select whether the Active Directory information of the login destination is retrieved automatically or entered manually. To enter it manually, select [Set Manually] and add the domain of the login destination in [Active Directory Management...].

c [Use access mode within sites]

Select the check box if there are multiple Active Directory servers and you want to assign access priority to the Active Directory located in the same site as the machine. Change the settings for [Timing of Site Information Retrieval:] and [Site Access Range:] as necessary.

! IMPORTANT:

- Even when [Only site to which device belongs] in [Site Access Range:] is set, the machine may access sites outside the site it belongs to when performing domain controller access during the startup process. However, access to domain controllers in the same site as the machine is prioritized. As an exception, if domain controllers in the same site cannot be accessed but domain controllers outside the site can be accessed, priority is given to accessing domain controllers outside the site.

d [Number of Caches for Service Ticket:]

Specify the number of service tickets that the machine can hold. A service ticket is an Active Directory function that acts as a record of a previous login, which reduces the amount of time it takes for the same user to log in next time.

e [Use LDAP server]

Select the check box when using an LDAP server.

f [Period Until Timeout:]

Specify the time limit for attempting to connect to the authentication server and the time limit for waiting for a response. When [Save authentication information for login users] is enabled, if you cannot log in within the time limit specified here, login is attempted using the authentication information saved in the cache.

g [Default Domain of Login Destination:]

Specify the domain that has connection priority.

Manually specifying the Active Directory domain

- 1 Select the check box for [Use Active Directory] and select [Set Manually] for [Set Domain List:].
- 2 Click [Active Directory Management...] ► [OK].
- 3 Click [Add Domain...].
- 4 Enter the necessary information.

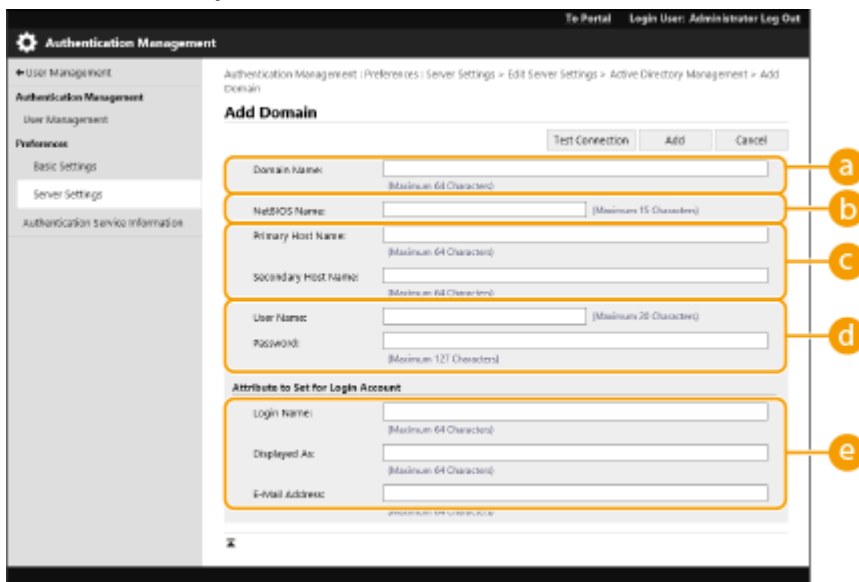

a [Domain Name:]

Enter the domain name of the Active Directory that is the login destination (**Example:** company.domain.com).

b [NetBIOS Name]

Enter the NetBIOS domain name (**Example:** company).

c [Primary Host Name:] / [Secondary Host Name:]

Enter the host name of the Active Directory server (**Example:** ad-server1). When using a secondary server, specify the name in [Secondary Host Name:].

d [User Name:] / [Password:]

Enter the user name and password to use for accessing and searching the Active Directory server.

e [Login Name:] / [Displayed As:] / [E-Mail Address:]

Specify the data fields (attribute names) for the login name, display name, and e-mail address of each user account on the Active Directory server (**Example:** sAMAccountName, cn, mail).

5 Click [Test Connection] to confirm that connection is possible, and then click [Add].

NOTE:

To edit server information

- Click [Edit] for the server information that you want to edit, make the necessary changes, and click [Update].

■ Registering LDAP server information

- 1** Select the check box for [Use LDAP server] and click [LDAP Server Management...] ► [OK].
- 2** Click [Add Server...].
- 3** Enter the LDAP server information.

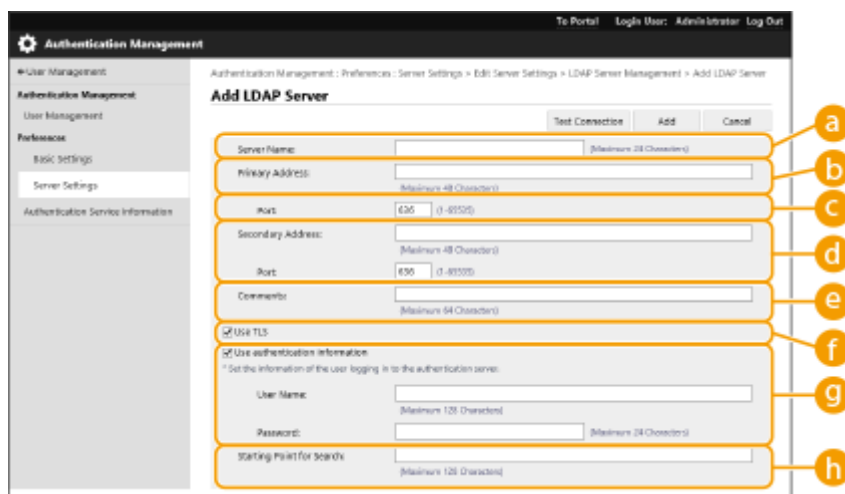

a [Server Name]

Enter the name for the LDAP server. The name "localhost" cannot be used. The server name may not include spaces.

b [Primary Address]

Enter the IP address or host name of the LDAP server (**Example:** ldap.example.com). The loopback address (127.0.0.1) cannot be used.

c [Port:]

Enter the port number used for communicating with the LDAP server. Use the same setting that is configured on the server. If you do not enter a number, it is automatically set to "636" when the check box is selected for [Use TLS], or it is set to "389" when the check box is cleared.

d [Secondary Address:] / [Port:]

When using a secondary server in your environment, enter the IP address and the port number.

e [Comments]

Enter a description or note as necessary.

f [Use TLS]

Select the check box when using TLS encryption for communications with the LDAP server.

g [Use authentication information]

Clear the check box to allow anonymous access to the LDAP server, only if the LDAP server is set to allow anonymous access. When using the user name and password for authentication, select the check box and enter values for [User Name:] and [Password:].

h [Starting Point for Search:]

Specify the location (level) to search for user information when LDAP server authentication is performed.

4 Specify how to set the attribute names and domain name.

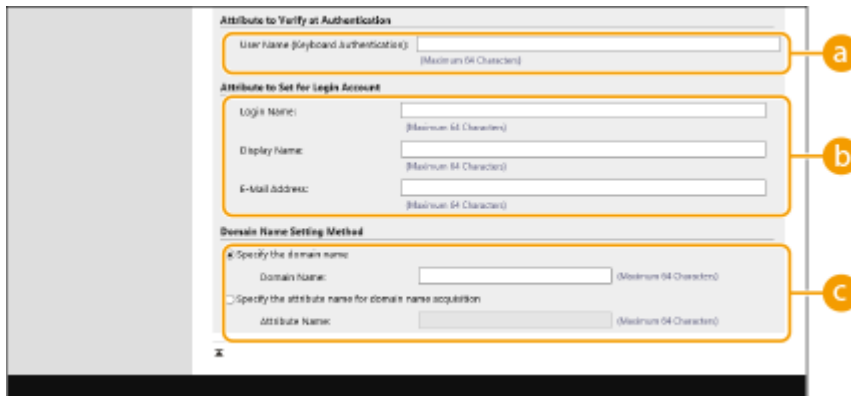

a [User Name (Keyboard Authentication):]

Specify the LDAP data field (attribute name) for the user name on the LDAP server (**Example:** uid).

b [Login Name:] / [Display Name:] / [E-Mail Address:]

Specify the LDAP data fields (attribute names) for the login name, display name, and e-mail address of each user account on the LDAP server (**Example:** uid, cn, mail).

c [Specify the domain name] / [Specify the attribute name for domain name acquisition]

Select how to set the domain name of the login destination. To specify the domain name directly, select [Specify the domain name] and enter the domain name. To specify an LDAP data field (attribute name) from which to acquire the domain name on the LDAP server, select [Specify the attribute name for domain name acquisition] and enter the attribute name (**Example:** dc).

5 Click [Test Connection] to confirm that connection is possible, and then click [Add].

NOTE:

To edit server information

- Click [Edit] for the server information that you want to edit, make the necessary changes, and click [Update].

6 Enter the user information and set the privileges.

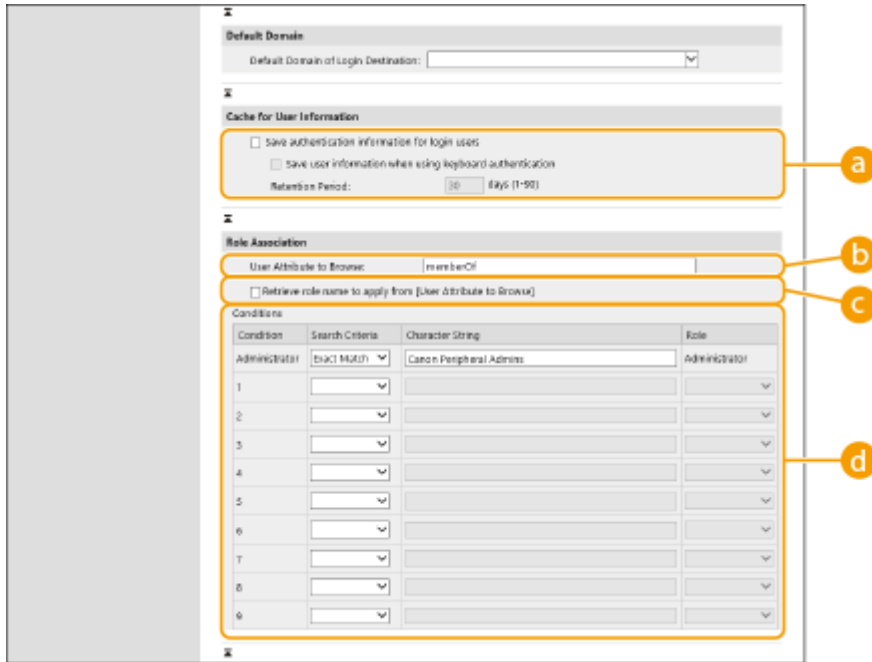

a [Save authentication information for login users]

Select the check box to save the authentication information of users who log in via the control panel. After the settings are configured, the saved authentication information can be used for login, even if the machine is unable to connect to the server. Change the [Retention Period:] setting as necessary.

b [User Attribute to Browse:]

Enter the data field (attribute name) on the referenced server that is used to determine user privileges (roles). Normally, you can use the preset value of "memberOf", which indicates the group that the user belongs to.

c [Retrieve role name to apply from [User Attribute to Browse]]

Select the check box to use the character string registered in the data field on the server specified in [User Attribute to Browse:] for the role name. Before configuring, check the role names that can be selected on the machine, and register them on the server.

d [Conditions]

You can set the conditions that determine user privileges. The conditions below are applied in the order that they are listed.

[Search Criteria]	Select the search criteria for [Character String].
[Character String]	Enter the character string that is registered to the attribute specified in [User Attribute to Browse:]. To set the privileges based on the group that user belongs to, enter the group name.
[Role]	Select the privileges that apply to users who match the criteria.

NOTE:

The [Conditions] settings when using Active Directory servers

- "Canon Peripheral Admins" is set in advance as the Administrator user group. Assign different privileges to the other groups created on the server.

7 Click [Update].

8 Restart the machine. ▶ **Restarting the Machine(P. 269)**

NOTE

DNS Settings

The following settings are required if the port number used for Kerberos on the Active Directory side is changed.

- Information for the Kerberos service of Active Directory must be registered as an SRV record as follows:
 - Service: "_kerberos"
 - Protocol: "_udp"
 - Port number: The port number used by the Kerberos service of the Active Directory domain (zone)
 - Host offering this service: Host name of the domain controller that is actually providing the Kerberos service of the Active Directory domain (zone)

Batch importing/batch exporting

- This setting can be imported/exported with models that support batch importing of this setting. [▶ Importing/Exporting the Setting Data\(P. 273\)](#)
- This setting is included in [Settings/Registration Basic Information] when batch exporting. [▶ Importing/Exporting All Settings\(P. 275\)](#)

LINKS

- ▶ [Registering User Information in the Local Device\(P. 177\)](#)
- ▶ [Configuring the Authentication Functions\(P. 194\)](#)
- ▶ [Using Personal Authentication to Manage Printing via a Computer\(P. 198\)](#)

Configuring the Authentication Functions

7L2J-03Y

You can configure the user login methods, authentication devices, and other authentication functions based on your system environment and needs.

Configuring the User Login Methods and Authentication Devices

Specify the user login methods ([▶Login Method\(P. 174\)](#)) and authentication devices ([▶Authentication Device\(P. 174\)](#)). Note that the authentication devices need to be set up before configuring the settings below.

- ▶[Registering User Information in the Local Device\(P. 177\)](#)
- ▶[Registering Server Information\(P. 188\)](#)

- 1** Start the Remote UI. [▶Starting the Remote UI\(P. 262\)](#)
- 2** Click [Settings/Registration] on the portal page. [▶Remote UI Screen\(P. 263\)](#)
- 3** Click [User Management] ▶ [Authentication Management].
- 4** Click [Basic Settings] ▶ [Edit...].
- 5** Specify the required settings.
 - Select the login methods that you want to use, and specify detailed settings such as authentication device settings.

■ Using keyboard authentication

Configure the settings below when using keyboard authentication.

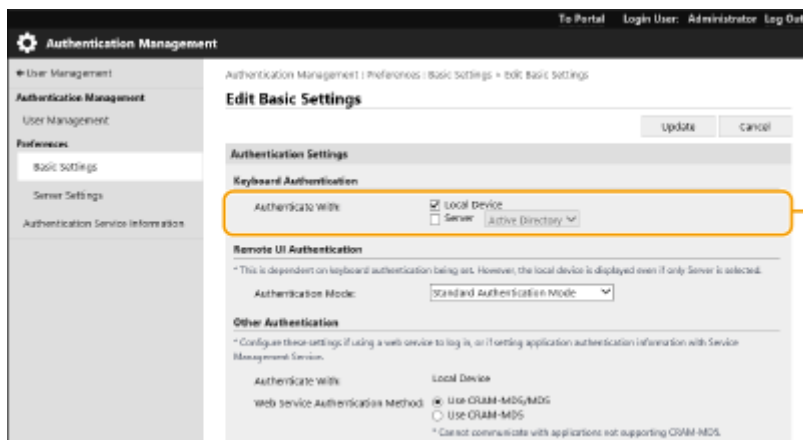

a [Authenticate With:]

Select the user authentication device.

- Select the check box for [Local Device] if you are using the database inside this machine to manage user information.
- When using an external authentication server, select [Server] and specify the type of server.

■ Configuring detailed settings for authentication functions

You can configure detailed settings for the personal authentication functions.

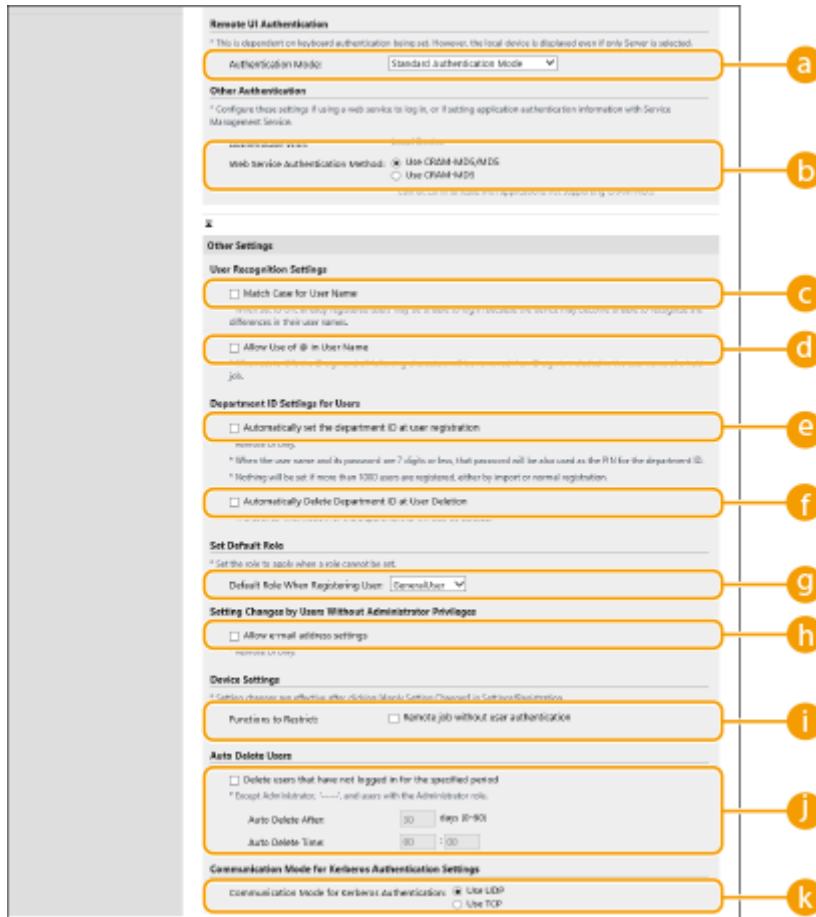

a [Authentication Mode:]

Select the authentication mode to use for Remote UI login. When [Guest Authentication Mode] is selected, unregistered users can also log in by clicking [Log In (Guest)]. Select [Administrator Authentication Mode] to only allow users with Administrator privileges to log in.

b [Web Service Authentication Method:]

Select the local device authentication method to use for communications with Web service applications.

c [Match Case for User Name]

If this function is set, you can set whether user names are case-sensitive.

NOTE:

- It is recommended that this is set together with [Function Settings] ► [Printer] ► [Print] ► [Match Case for User Name]

d [Allow Use of @ in User Name]

Select whether to allow "@" to be used in user names.

e [Automatically set the department ID at user registration]

Select the check box to automatically allocate a Department ID when you register/edit a user via the Remote UI. A new Department ID will not be allocated if one has already been allocated. This setting can only be specified from the Remote UI.

NOTE:

- If the user name is comprised of numbers and is seven digits or fewer, the same number is assigned to the same user as the Department ID. If the password of the same user is registered as a number that is seven digits or fewer, it is also set as the PIN for that Department ID.
- If the user name and password do not meet the above conditions, a Department ID is automatically assigned starting from 0000001, and 0 (none) is set for the PIN.
- In the following cases, the Department ID is not registered automatically.
 - If a user is registered from the control panel of the machine
 - If 1,000 Department IDs are already registered
 - If 1,001 or more users are already registered

f [Automatically Delete Department ID at User Deletion]

If this check box is selected, when a user is deleted, the department ID assigned to the user is automatically deleted. Counter information assigned to the corresponding department ID is also deleted. If multiple users are registered to the department ID, it is not automatically deleted.

g [Default Role When Registering User:]

Select the role to apply to users in situations such as when no privileges are set.

h [Allow e-mail address settings]

Select the check box to enable users without Administrator privileges to specify their own e-mail addresses in their user accounts.

i [Functions to Restrict:]

Select the check boxes for functions that cannot be used when personal authentication management is enabled.

j [Delete users that have not logged in for the specified period]

Select the check box to delete users registered in the local device who have not logged in to the machine for a specified period of time. Make sure to also specify the number of days before automatic deletion and the time it is executed.

NOTE:

- If you set [Auto Delete After:] to [0], all accounts other than the administrator are deleted at the time set in [Auto Delete Time:].
- If the accounts cannot be deleted at the specified time because the machine is turned OFF or is completely in sleep mode, the accounts are deleted the next time that the machine starts.
- If a user has never logged in before, the date and time that the user was registered is displayed as the time that the user last logged in.

k [Communication Mode for Kerberos Authentication:]

Select the communication method used for Kerberos authentication.

6 Click [Update].

7 Restart the machine. ▶ **Restarting the Machine(P. 269)**

NOTE

Batch importing/batch exporting

- This setting can be imported/exported with models that support batch importing of this setting. ▶ **Importing/Exporting the Setting Data(P. 273)**
- This setting is included in [Settings/Registration Basic Information] when batch exporting. ▶ **Importing/Exporting All Settings(P. 275)**

LINKS

- ▶ **Registering User Information in the Local Device(P. 177)**
- ▶ **Registering Server Information(P. 188)**
- ▶ **Using Personal Authentication to Manage Printing via a Computer(P. 198)**

Using Personal Authentication to Manage Printing via a Computer

7L2J-040

You can apply personal authentication management to printing via a computer. This can provide greater security, as the machine does not accept these operations unless the user is identified.



Start the Remote UI ▶ [Settings/Registration] ▶ [User Management] ▶ [Authentication Management] ▶ [Basic Settings] ▶ [Edit...] ▶ [Functions to Restrict:] ▶ select [Remote job without user authentication].

NOTE

Batch importing/batch exporting

- This setting can be imported/exported with models that support batch importing of this setting. [▶ Importing/Exporting the Setting Data\(P. 273\)](#)
- This setting is included in [Settings/Registration Basic Information] when batch exporting. [▶ Importing/Exporting All Settings\(P. 275\)](#)

LINKS

- ▶ [Registering User Information in the Local Device\(P. 177\)](#)
- ▶ [Registering Server Information\(P. 188\)](#)
- ▶ [Configuring the Authentication Functions\(P. 194\)](#)

Using Other Convenient Personal Authentication Management Functions

7L2J-041

Personal authentication management provides a variety of advantages in addition to user authentication. This section describes some of the other convenient functions that use personal authentication to expand the capabilities of printers/multifunctional printers, such as managing user groups.

Department ID Management

Users registered in the machine can be organized into groups such as the departments that they belong to, and managed based on their Department ID. This function lets you check the total number of pages used for each Department ID, or set maximum limits on the number of pages that each department can use for printing, which can help reduce costs. ▶ **Setting the Department ID Management(P. 200)**



Setting the Department ID Management

7L2J-042

Users can be organized into groups such as the departments that they belong to, and managed based on their Department ID. First, create all of the Department IDs that are to be managed, and assign users to each one (▶ **Registering User Information in the Local Device(P. 177)**). After assigning users to Department IDs, enable Department ID Management. To perform the same type of management for printing from a computer, configure the additional required settings. Administrator privileges are required in order to configure these settings.



- ▶ **Changing the System Manager ID and PIN(P. 201)**
- ▶ **Configuring the Department ID Management Settings(P. 203)**
- ▶ **Using Department IDs to Manage Printing via Computer(P. 206)**

NOTE

Batch importing/batch exporting

- This setting can be imported/exported with models that support batch importing of this setting. ▶ **Importing/Exporting the Setting Data(P. 273)**
- This setting is included in [Department ID Management Settings] when batch exporting. ▶ **Importing/Exporting All Settings(P. 275)**

Changing the System Manager ID and PIN

7L2J-043

When Department ID Management is enabled, Department IDs must be set for users before they can log in. The System Manager ID and System Manager PIN are both set to "7654321" by default, but it is recommended to change them for security reasons. Follow the procedure below to change them.

! IMPORTANT

- Make sure that you do not forget the System Manager PIN. If you forget the System Manager PIN, contact your dealer or service representative.

NOTE

- This setting is not a default User Authentication administrator setting. To specify this setting for a user with administrator privileges in User Authentication, set [Select Role to Set:] to "Administrator". **▶ Registering User Information in the Local Device(P. 177)**

- 1 Select <Set> on the <Home> screen. **▶ <Home> Screen(P. 81)**
- 2 Select <Management Settings> ▶ <User Management> ▶ <System Manager Information Settings>.
- 3 Select <System Manager ID and PIN>.
- 4 Set the System Manager ID and System Manager PIN.
 - Set <System Manager ID> ▶ <System Manager PIN>.

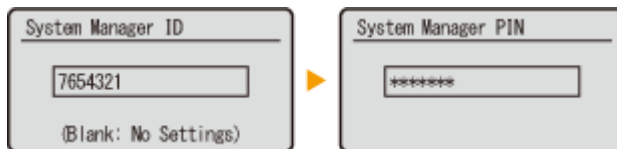

NOTE:

- You cannot register a System Manager ID or PIN consisting only of 0s, such as "00" or "0000000".
- Even if you enter fewer than seven digits, zeros are added to the start of the number, and a seven digit number is set.
- You can also make entering seven digits a requirement for the System Manager ID and System Manager PIN. For more information, contact your dealer or service representative.

■ Setting the administrator information

- 1 Select <System Manager Name>/<E-Mail Address>/<Contact Information>/<Comment>.
- 2 Enter the information and select <Apply>.

- For information on entering text, see [▶Entering Characters\(P. 88\)](#) .

LINKS

[▶Configuring the Department ID Management Settings\(P. 203\)](#)

[▶Registering User Information in the Local Device\(P. 177\)](#)

Configuring the Department ID Management Settings

7L2J-044

You can organize and manage users in groups based on Department ID. Follow the procedure below to configure Department ID Management and enable the machine to count the number of pages used for printing.

▶ **Enabling Department ID Management(P. 203)**

▶ **Registering Department IDs and PINs(P. 204)**

! IMPORTANT

- Make sure that Department IDs have been set for the users registered in the machine. ▶ **Registering User Information in the Local Device(P. 177)**
- Department ID Management is only valid for users who are registered to the local device.
- If you login as a user with Administrator privileges, a System Manager ID and PIN are automatically assigned, and managed as Department ID.

NOTE

- For information on the number of Department IDs that you can register, see ▶ **Management Functions(P. 523)** .

Enabling Department ID Management

- 1 **Start the Remote UI.** ▶ **Starting the Remote UI(P. 262)**
- 2 **Click [Settings/Registration] on the portal page.** ▶ **Remote UI Screen(P. 263)**
- 3 **Click [User Management] ▶ [Department ID Management].**
- 4 **Click [Edit].**
- 5 **Select [Enable Department ID Management].**

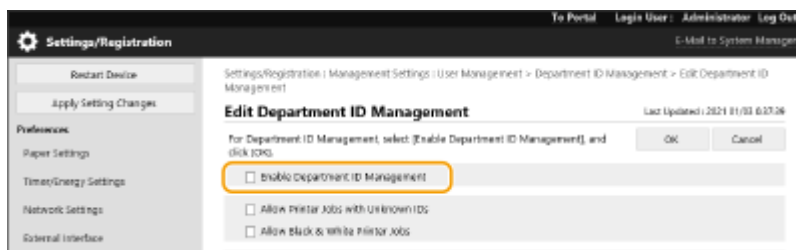

6 Click [OK].

Registering Department IDs and PINs

1 Start the Remote UI. ▶ Starting the Remote UI(P. 262)

2 Click [Settings/Registration] on the portal page. ▶ Remote UI Screen(P. 263)

3 Click [User Management] ▶ [Department ID Management].

4 Click [Register New Department].

NOTE:

To edit Department ID settings

- Click the department ID to edit to display the edit screen.

To delete Department ID settings

- Click [Delete] for the department ID to delete ▶ [OK].

5 Enter the required information, and click [OK].

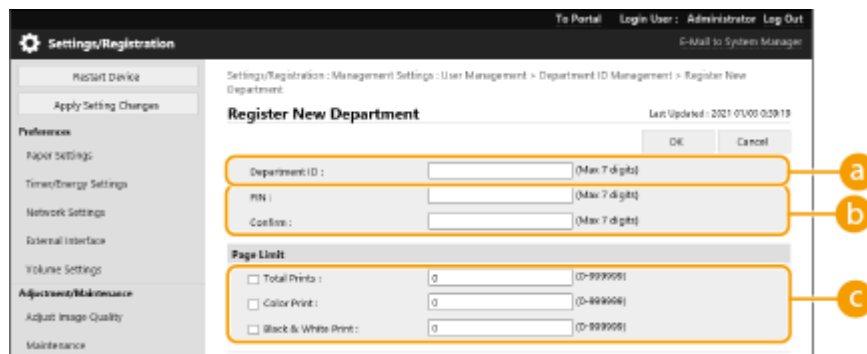

a [Department ID]

Enter a number of 7 digits or less for the Department ID.

b [PIN]

Enter the PIN (seven digits maximum). Enter the PIN again in [Confirm]. If you do not want to set a PIN, leave it blank.

c [Page Limit]

You can restrict the number of pages that a registered department can print. Select the target types and enter the page totals.

NOTE:

- You cannot register a Department ID or PIN consisting only of 0s, such as "00" or "0000000".
- Even if you enter fewer than seven digits, zeros are added to the start of the number, and a seven digit number is set.
- You can also make entering seven digits a requirement for Department IDs and PINs. For more information, contact your dealer or service representative.

- The machine stops printing if any one of the color or black-and-white page limits is reached while printing a document that contains both color and black-and-white areas.

NOTE

To check the page counts

- If you want to check the total number of pages used by each Department ID for printing, check [Department ID Page Totals] on the screen displayed in step 4. The page counts do not include blank pages or sample prints used for checking items such as gradation adjustment.

Logging In Using a Department ID and PIN

- By registering a user with the same name as a department ID, login operations can be performed using a registered department ID and PIN. [▶ Registering User Information in the Local Device\(P. 177\)](#)

LINKS

- ▶ [Using Department IDs to Manage Printing via Computer\(P. 206\)](#)

Using Department IDs to Manage Printing via Computer

7L2J-045

You can use Department ID Management to manage printing operations performed via a computer. Use this function when you would like to improve security or monitor the number of pages that are printed.

- 1 Start the Remote UI. ▶ Starting the Remote UI(P. 262)
- 2 Click [Settings/Registration] on the portal page. ▶ Remote UI Screen(P. 263)
- 3 Click [User Management] ▶ [Department ID Management].
- 4 Click [Edit].
- 5 Deselect the operations to restrict.

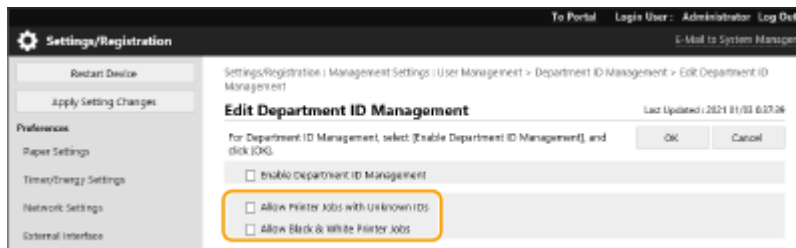

- When deselected, department ID entry is required when executing the corresponding type of job.
- Select this check box to accept print jobs and black-and-white print jobs from printer drivers that do not support Department ID Management.

- 6 Click [OK].

Setting an Authentication/Password Policy

7L2J-046

You can set a policy regarding lockout (the state where users temporarily cannot log into the machine) and password operation/entry.

- ▶ **Setting a Lockout Policy(P. 207)**
- ▶ **Setting a Password Policy(P. 208)**

Setting a Lockout Policy

You can set a policy for temporarily preventing a user that fails user authentication from logging in. However, this policy does not apply to authentication that uses information such as department IDs and PINs.

- 1 Start the Remote UI. ▶Starting the Remote UI(P. 262)**
- 2 Click [Settings/Registration] on the portal page. ▶Remote UI Screen(P. 263)**
- 3 Click [Security Settings] ▶ [Authentication/Password Settings].**
- 4 Click [Edit] in [Authentication Function Settings].**
- 5 Select [Enable Lockout] and configure the detailed settings.**

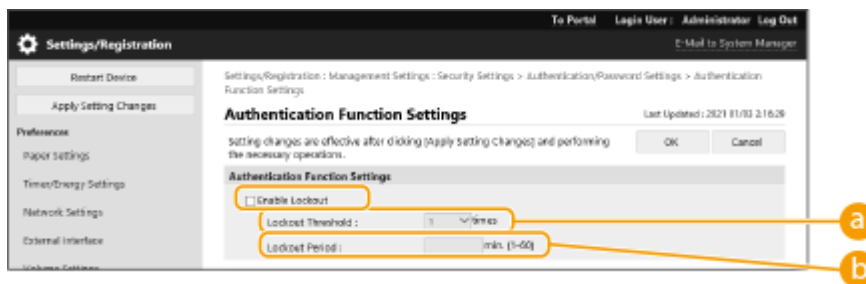

- a [Lockout Threshold]**
Set the login failure count for lockout. The user becomes unable to log in when the set count is reached.
- b [Lockout Period]**
Set the time until the lockout is canceled.

NOTE:

- When logging in to the machine from an operating system such as Windows or an application that uses FTP, IPP, or SNMPv3, lockout may occur before the set count.

- 6 Click [OK].**

NOTE

Batch importing/batch exporting

- This setting can be imported/exported with models that support batch importing of this setting. **▶ Importing/Exporting the Setting Data(P. 273)**
- This setting is included in [Settings/Registration Basic Information] when batch exporting. **▶ Importing/Exporting All Settings(P. 275)**

Setting a Password Policy

- 1 Start the Remote UI. ▶ Starting the Remote UI(P. 262)**
- 2 Click [Settings/Registration] on the portal page. ▶ Remote UI Screen(P. 263)**
- 3 Click [Security Settings] ▶ [Authentication/Password Settings].**
- 4 Click [Edit] in [Authentication Function Settings].**
- 5 Set the password operation and user authentication policy.**

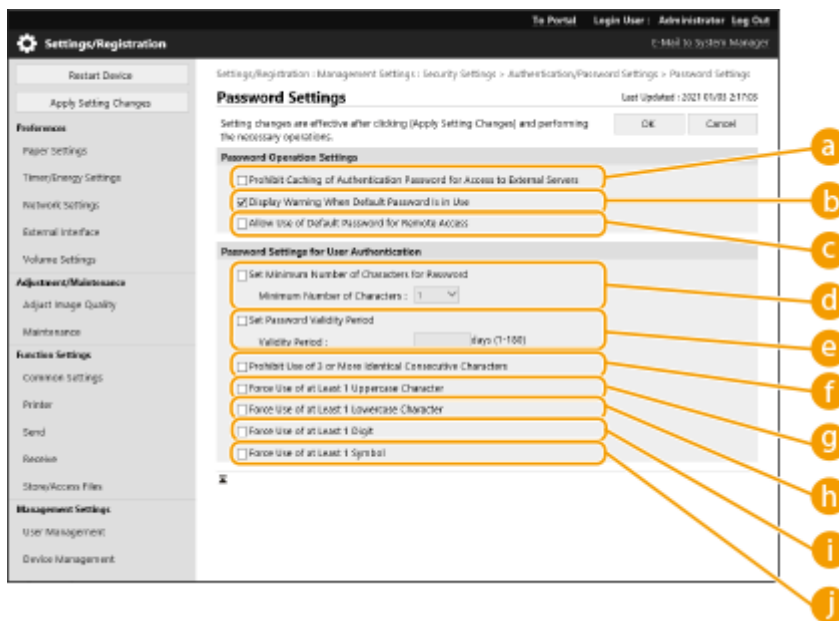

a [Prohibit Caching of Authentication Password for Access to External Servers]

Select this check box to prevent passwords entered during login from being saved in the cache.

b [Display Warning When Default Password Is in Use]

Select this check box to display the screen for changing the password when the Administrator logs in to the machine using the default user name and password.

NOTE:

- If the password has expired, the screen for changing the password appears, regardless of this setting.

c [Allow Use of Default Password for Remote Access]

Select this check box to allow the default password to be used when logging in from the Remote UI.

d [Set Minimum Number of Characters for Password]

You can set the minimum number of characters required when registering a password to prevent the simplification of passwords. When a password length is set, a user cannot be registered with a blank password.

e [Set Password Validity Period]

To periodically prompt users to change their password, select this check box and specify a period in [Validity Period].

f [Prohibit Use of 3 or More Identical Consecutive Characters]

Select this check box to restrict passwords so that the same character cannot be used consecutively three or more times.

g [Force Use of at Least 1 Uppercase Character]

Select this check box to restrict passwords so that only passwords which include at least one uppercase character can be registered.

h [Force Use of at Least 1 Lowercase Character]

Select this check box to restrict passwords so that only passwords which include at least one lowercase character can be registered.

i [Force Use of at Least 1 Digit]

Select this check box to restrict passwords so that only passwords which include at least one number can be registered.

j [Force Use of at Least 1 Symbol]

Select this check box to restrict passwords so that only passwords which include at least one symbol can be registered.

6 Click [OK].

NOTE

- The settings in **d** to **j** do not apply to Department ID Management and PINs. They are valid for passwords that are registered/edited after the restrictions are set. When a password that is already registered exceeds the restrictions for these settings, a screen prompting to change the password is displayed when user authentication is performed.

Batch importing/batch exporting

- This setting can be imported/exported with models that support batch importing of this setting. **▶ Importing/Exporting the Setting Data(P. 273)**
- This setting is included in [Settings/Registration Basic Information] when batch exporting. **▶ Importing/Exporting All Settings(P. 275)**

Configuring the Network Security Settings

7L2J-047

Authorized users may incur unanticipated losses from attacks by malicious third parties, such as sniffing, spoofing, and tampering of data as it flows over a network. To protect your important and valuable information from these attacks, the machine supports the following features to enhance security and secrecy.

Firewall Settings

Unauthorized access by third parties, as well as network attacks and breaches, can be blocked by only allowing communication with devices that have a specific IP address. [Restricting Communication by Using Firewalls\(P. 212\)](#)



Proxy Settings

When the client devices are connected to an external network, communication is established through the proxy server. When the proxy server is used, websites can be browsed more safely, therefore, security can be expected to be enhanced. [Setting a Proxy\(P. 221\)](#)



TLS Encrypted Communication

TLS is a protocol for encryption for data sent over a network and is often used for communication via a Web browser or an e-mail application. TLS encrypted communication enables secure network communication when accessing the machine using the Remote UI. [Configuring the Key and Certificate for TLS\(P. 223\)](#)



IPSec Communication

While TLS only encrypts data used on a specific application, such as a Web browser or an e-mail application, IPSec encrypts the whole (or payloads of) IP packets. This enables IPSec to offer a more versatile security system than TLS. [Configuring the IPSec Settings\(P. 244\)](#)

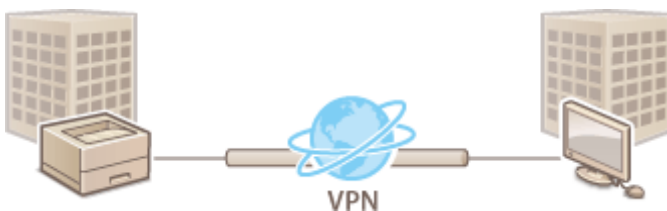

IEEE 802.1X Authentication

If a device tries to connect and start communicating on an 802.1X network, the device must go through user authentication in order to prove that the connection is made by an authorized user. Authentication information is sent to and checked by a RADIUS server, which permits or rejects communication to the network depending on the authentication result. If authentication fails, a LAN switch (or an access point) blocks access from the outside of the network. The machine can connect to an 802.1X network as a client device. **►Configuring the IEEE 802.1X Authentication Settings(P. 251)**

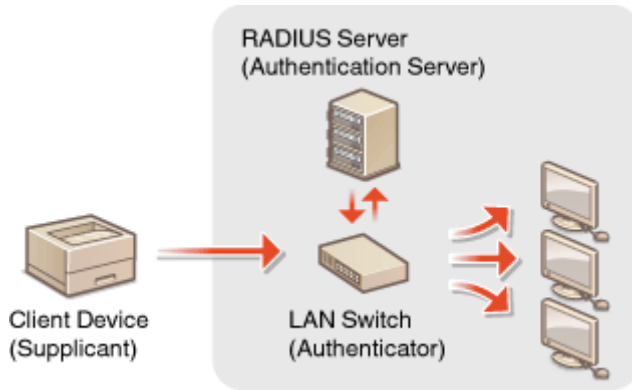

Restricting Communication by Using Firewalls

7L2J-048

By configuring packet filtering to only allow communication with devices that have a specific IP address or MAC address, you can reduce the risk of unauthorized access by outside third parties. Administrator privileges are required in order to configure these settings.



- ▶ **Specifying IP Addresses in Firewall Settings(P. 213)**
- ▶ **Specifying MAC Addresses in Firewall Settings(P. 216)**
- ▶ **Configuring the Firewall of the Sub Line(P. 218)**

Specifying IP Addresses in Firewall Settings

7L2J-049

You can set whether to allow or reject communication with a device that has a specific IP address. After configuring the IP addresses in the firewall settings, you can check the results in the log of blocked communication requests. You can also set whether to allow or reject ICMP communications such as PING commands, etc., after specifying firewall settings.

1 Start the Remote UI. ▶Starting the Remote UI(P. 262)

2 Click [Settings/Registration] on the portal page. ▶Remote UI Screen(P. 263)

3 Click [Network Settings] ▶ [Outbound Filter] or [Inbound Filter] for [IPv4 Address Filter]/[IPv6 Address Filter].

- Select the filter that matches the target IP address. To restrict data sent from the machine to a computer, select [Outbound Filter]. To restrict data received from a computer, select [Inbound Filter].

4 Specify the settings for packet filtering.

- Select the default policy to allow or reject the communication of other devices with the machine, and then specify IP addresses for exceptions.

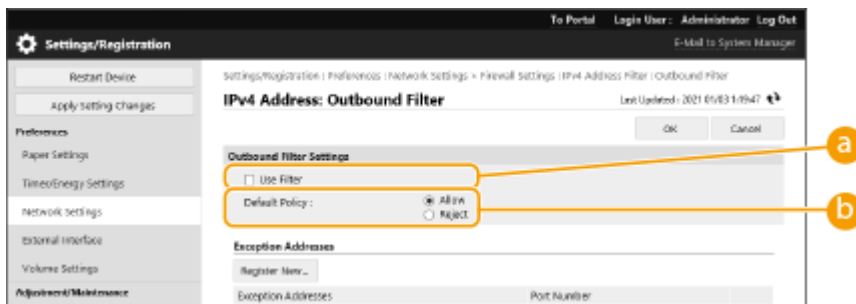

a [Use Filter]

Select the check box to restrict communication. Clear the check box to disable the restriction.

b [Default Policy]

Select the precondition to allow or reject the communication of other devices with the machine.

[Reject]	Select to pass communication packets only when they are sent to or received from devices whose IP addresses are entered in [Exception Addresses]. Communications with other devices are prohibited.
[Allow]	Select to block communication packets when they are sent to or received from devices whose IP addresses are entered in [Exception Addresses]. Communications with other devices are permitted.

5 Click [Register New].

6 Specify exception addresses.

- Enter the IP address (or range of IP addresses) in [Address to Register].

! IMPORTANT:

- If IP addresses are incorrectly entered, you may be unable to access the machine from the Remote UI, in which case you need to set <IPv4 Address Filter> or <IPv6 Address Filter> to <Off>.
 - ▶<Network>(P. 362)

NOTE:

Entry form for IP addresses

	Description	Example
Entering a single address	IPv4: Delimit numbers with periods.	192.168.0.10
	IPv6: Delimit alphanumeric characters with colons.	fe80::10
Specifying a range of addresses	Insert a hyphen between the addresses.	192.168.0.10-192.168.0.20
Specifying a range of addresses with a prefix	Enter the address, followed by a slash and a number indicating the prefix length.	192.168.0.32/27 fe80::1234/64

When [Reject] is selected for an outbound filter

- Outgoing multicast and broadcast packets cannot be filtered.

7 Specify the port number as required.

- The exception address setting only applies to communication received from the specified IP address using the designated port number. Enter the port number, and click [Add]. You can register up to 50 ports per one exception address for both IPv4/IPv6.

8 Click [OK].

NOTE:

Deleting an IP address from exceptions

- Click [Delete] for the exception address to delete.

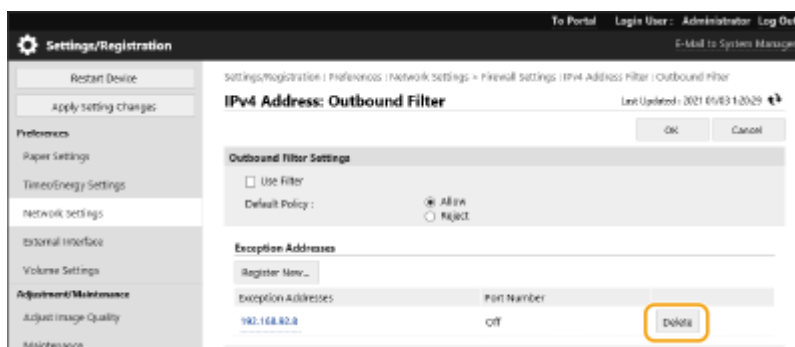

NOTE

Checking the blocked communication requests in the log

- The latest 100 communications blocked by the firewall can be checked in [Settings/Registration] ▶ [Network Settings] ▶ [IP Address Block Log]. The history of blocked communications can be exported from the Remote UI in the CSV format. ▶<Exporting a Log as a File(P. 271)>

- If [Default Policy] is set to [Reject], the history of communication blocked by the firewall is not displayed in [IP Address Block Log].

To allow or reject ICMP sending and receiving



Click [Settings/Registration] ▶ [Network Settings] ▶ [IPv4 Address Filter]/[IPv6 Address Filter] ▶ [ICMP Sending/Receiving Settings] ▶ select or deselect [Always Allow Sending/Receiving Using ICMP].

Using the operation panel

- You can also enable or disable IP address filtering from <Set> in the <Home> screen.
▶<Network>(P. 362)

Batch importing/batch exporting

- This setting can be imported/exported with models that support batch importing of this setting. ▶
Importing/Exporting the Setting Data(P. 273)
- This setting is included in [Settings/Registration Basic Information] when batch exporting. ▶**Importing/Exporting All Settings(P. 275)**

LINKS

- ▶**Specifying MAC Addresses in Firewall Settings(P. 216)**

Specifying MAC Addresses in Firewall Settings

7L2J-04A

You can limit communication to only devices with specified MAC addresses, or block devices with specified MAC addresses but permit other communications.

! IMPORTANT

- This function is unavailable when the machine is connected to a wireless LAN or sub line.

1 Start the Remote UI. ▶ Starting the Remote UI(P. 262)

2 Click [Settings/Registration] on the portal page. ▶ Remote UI Screen(P. 263)

3 Click [Network Settings] ▶ [Outbound Filter] or [Inbound Filter] for [MAC Address Filter].

- To restrict data sent from the machine to a computer, select [Outbound Filter]. To restrict data received from a computer, select [Inbound Filter].

4 Specify the settings for packet filtering.

- Select the precondition (default policy) to allow or reject the communication of other devices with the machine, and then specify MAC addresses for exceptions.

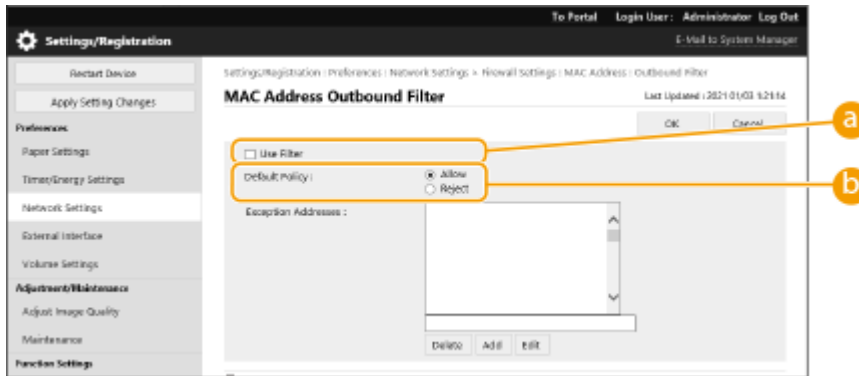

a [Use Filter]

Select the check box to restrict communication. Clear the check box to disable the restriction.

b [Default Policy]

Select the precondition to allow or reject other devices to communicate with the machine.

[Reject]	Select to pass communication packets only when they are sent to or received from devices whose MAC addresses are entered in [Exception Addresses]. Communications with other devices are prohibited.
[Allow]	Select to block communication packets when they are sent to or received from devices whose MAC addresses are entered in [Exception Addresses]. Communications with other devices are permitted.

5 Specify exception addresses.

- Enter the MAC address in the [Address to Register] text box and click [Add].
- You do not need to delimit the address with hyphens or colons.

! IMPORTANT:

- If MAC addresses are incorrectly entered, you may become unable to access the machine from the Remote UI, in which case you need to set <MAC Address Filter> to <Off>. ▶<Network>(P. 362)

NOTE:

When [Reject] is selected for an outbound filter

- Outgoing multicast and broadcast packets cannot be filtered.

6 Click [OK].

NOTE:

Deleting a MAC address from exceptions

- Select a MAC address and click [Delete].

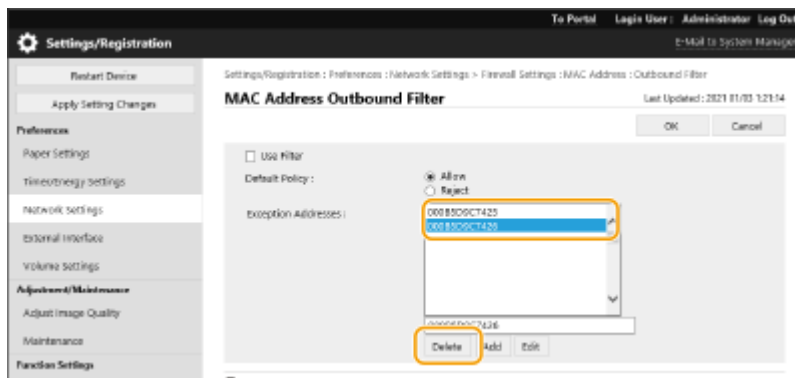

NOTE

Using the operation panel

- You can also enable or disable MAC address filtering from <Set> in the <Home> screen. ▶<Network>(P. 362)

Batch importing/batch exporting

- This setting can be imported/exported with models that support batch importing of this setting. ▶**Importing/Exporting the Setting Data(P. 273)**
- This setting is included in [Settings/Registration Basic Information] when batch exporting. ▶**Importing/Exporting All Settings(P. 275)**

LINKS

- ▶<Specifying IP Addresses in Firewall Settings>(P. 213)

Configuring the Firewall of the Sub Line

7L2J-04C

You can set whether to allow communication only with devices that have the specified IP address for communication with the sub line.

NOTE

- Only IPv4 addresses can be registered for the sub line.
- For information on the exception addresses and exception port numbers that can be used for communication and are registered by default, see [▶Management Functions\(P. 523\)](#) .

1 Start the Remote UI. [▶Starting the Remote UI\(P. 262\)](#)

2 Click [Settings/Registration] on the portal page. [▶Remote UI Screen\(P. 263\)](#)

3 Click [Network Settings] ▶ [Firewall Settings].

- Select the filter that matches the target IP address. To restrict data sent from the machine to a computer, select [IPv4 Address: Outbound Filter]. To restrict data received from a computer, select [IPv4 Address: Inbound Filter].

4 Specify the settings for packet filtering.

- Select the default policy to allow or reject the communication of other devices with the machine, and then specify IP addresses for exceptions.

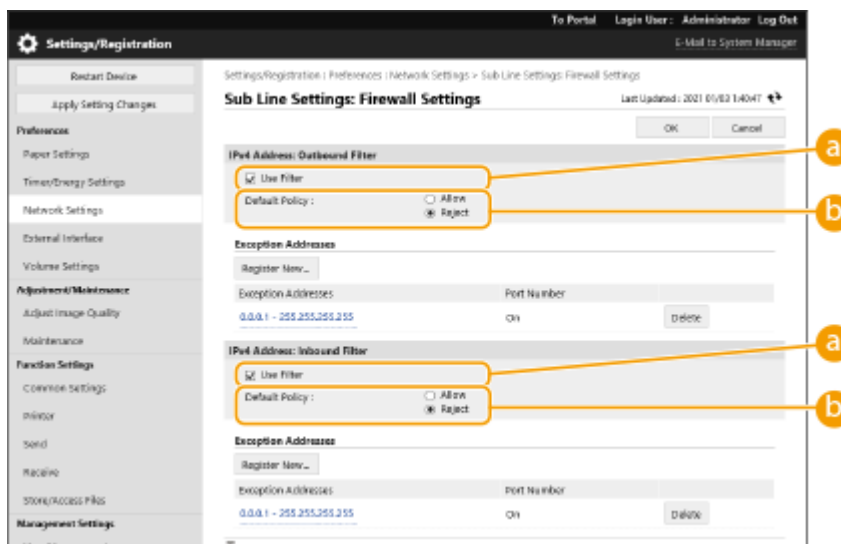

a [Use Filter]

Select the check box to restrict communication. Clear the check box to disable the restriction.

b [Default Policy]

Select the precondition to allow or reject the communication of other devices with the machine.

[Reject]	Select to pass communication packets only when they are sent to or received from devices whose IP addresses are entered in [Exception Addresses]. Communications with other devices are prohibited.
[Allow]	Select to block communication packets when they are sent to or received from devices whose IP addresses are entered in [Exception Addresses]. Communications with other devices are permitted.

5 Click [Register New].

6 Specify exception addresses.

- Enter the IP address (or range of IP addresses) in [Address to Register].

! IMPORTANT:

- If IP addresses are incorrectly entered, you may be unable to access the machine from the Remote UI, in which case you need to set <IPv4 Address Filter> to <Off>.

▶<Network>(P. 362)

NOTE:

Entry form for IP addresses

	Description	Example
Entering a single address	Delimit numbers with periods.	192.168.0.10
Specifying a range of addresses	Insert a hyphen between the addresses.	192.168.0.10-192.168.0.20
Specifying a range of addresses with a prefix	Enter the address, followed by a slash and a number indicating the prefix length.	192.168.0.32/27

When [Reject] is selected for an outbound filter

- Outgoing multicast and broadcast packets cannot be filtered.

7 Specify the port number as required.

- The exception address setting only applies to communication received from the specified IP address using the designated port number. Enter the port number, and click [Add].You can register up to 50 ports per one exception address.

8 Click [OK].

NOTE:

Deleting an IP address from exceptions

- Click [Delete] for the exception address to delete..

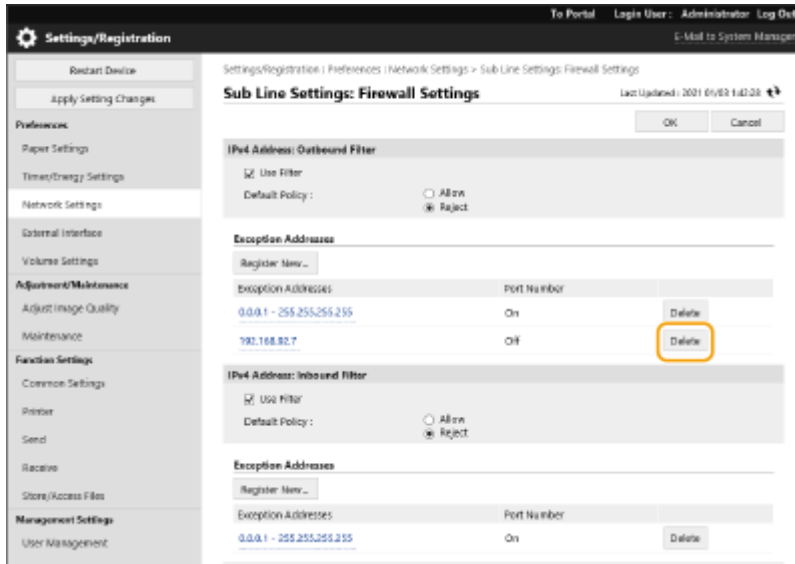

NOTE

Checking the blocked communication requests in the log

- The latest 100 communications blocked by the firewall can be checked in [Settings/Registration] ► [Network Settings] ► [IP Address Block Log]. The history of blocked communications can be exported from the Remote UI in the CSV format. ► **Exporting a Log as a File(P. 271)**
- If [Default Policy] is set to [Reject], the history of communication blocked by the firewall is not displayed in [IP Address Block Log].

Using the operation panel

- You can also enable or disable IP address filtering from <Set> in the <Home> screen. ► **<Network>(P. 362)**

Batch importing/batch exporting

- This setting can be imported/exported with models that support batch importing of this setting. ► **Importing/Exporting the Setting Data(P. 273)**
- This setting is included in [Settings/Registration Basic Information] when batch exporting. ► **Importing/Exporting All Settings(P. 275)**

Setting a Proxy

7L2J-04E

A proxy (or HTTP proxy server) refers to a computer or software that carries out HTTP communication for other devices, especially when communicating with resources outside the network, such as when browsing Web sites. The client devices connect to the outside network through the proxy server, and do not communicate directly to the resources outside. Setting a proxy not only facilitates management of traffic between in-house and outside networks but also blocks unauthorized access and consolidates anti-virus protection for enhanced security. Administrator privileges are required in order to configure these settings.



- 1 Start the Remote UI. ▶ Starting the Remote UI(P. 262)
- 2 Click [Settings/Registration] on the portal page. ▶ Remote UI Screen(P. 263)
- 3 Click [Network Settings] ▶ [Proxy Settings].
- 4 Select the [Use Proxy] check box and specify the required settings.

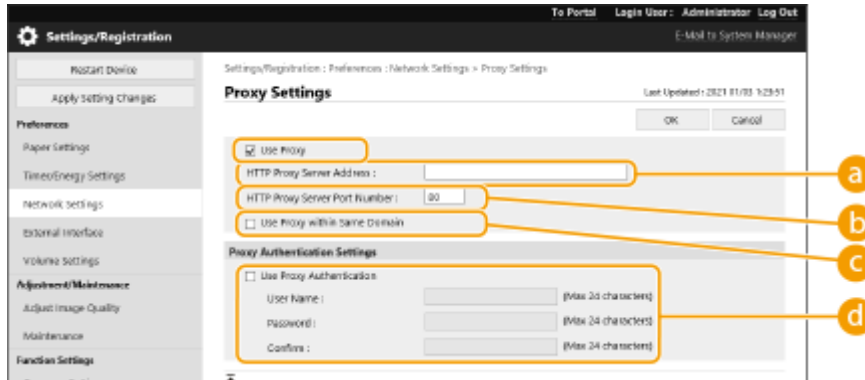

a [HTTP Proxy Server Address]

Enter the address of the proxy server. Specify the IP address or host name depending on the environment.

b [HTTP Proxy Server Port Number]

Change the port number as necessary.

c [Use Proxy within Same Domain]

Select the check box to also use the specified proxy server for communication with devices in the same domain.

NOTE:

- This setting is only displayed for the proxy settings screen of the main line.



d [Use Proxy Authentication]

To use the authentication function of a proxy server, select this check box and enter the user name for authentication in [User Name] and the new password to set in [Password] using alphanumeric characters.

- 5 Click [OK].

NOTE

Batch importing/batch exporting

- This setting can be imported/exported with models that support batch importing of this setting.  **Importing/Exporting the Setting Data(P. 273)**
- This setting is included in [Settings/Registration Basic Information] when batch exporting.  **Importing/Exporting All Settings(P. 275)**

Configuring the Key and Certificate for TLS

7L2J-04F

You can use TLS encrypted communication to prevent sniffing, spoofing, and tampering of data that is exchanged between the machine and other devices such as computers. When configuring the settings for TLS encrypted communication, you must specify a key and certificate (server certificate) to use for encryption. You can use the key and certificate that are preinstalled in the machine, or you can generate your own or acquire them from a certification authority. Administrator privileges are required in order to configure these settings.



▶ [Setting TLS\(P. 223\)](#)

▶ [Setting the Security Strength and Encryption Method\(P. 225\)](#)

NOTE

- If you want to use a key and certificate that you generate yourself, generate the key and certificate before performing the procedure below. ▶ [Generating the Key and Certificate for Network Communication\(P. 227\)](#)
- If you want to use a key and certificate that you acquire from a certification authority (CA), register the key and certificate before performing the procedure below. ▶ [Registering a Key and Certificate\(P. 232\)](#)

Setting TLS

- 1 Start the Remote UI. ▶ [Starting the Remote UI\(P. 262\)](#)
- 2 Click [Settings/Registration] on the portal page. ▶ [Remote UI Screen\(P. 263\)](#)
- 3 Click [Network Settings] ▶ [TLS Settings].
- 4 Click [Key and Certificate].
- 5 Click [Use] for the key and certificate to use for TLS encrypted communication.

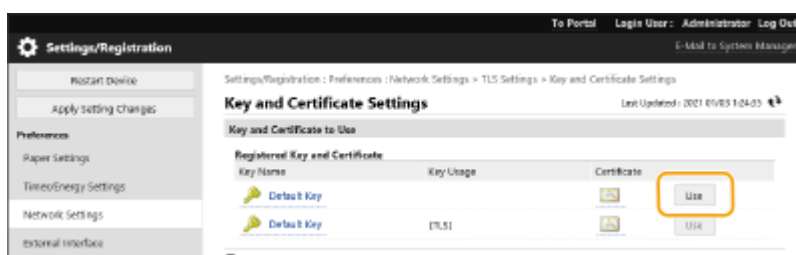

- If you want to use the preinstalled key and certificate, select [Default Key].

6 Click [Network Settings] ► [TLS Settings].

7 Specify [Maximum Version] and [Minimum Version].

8 Select the algorithm to use, and click [OK].

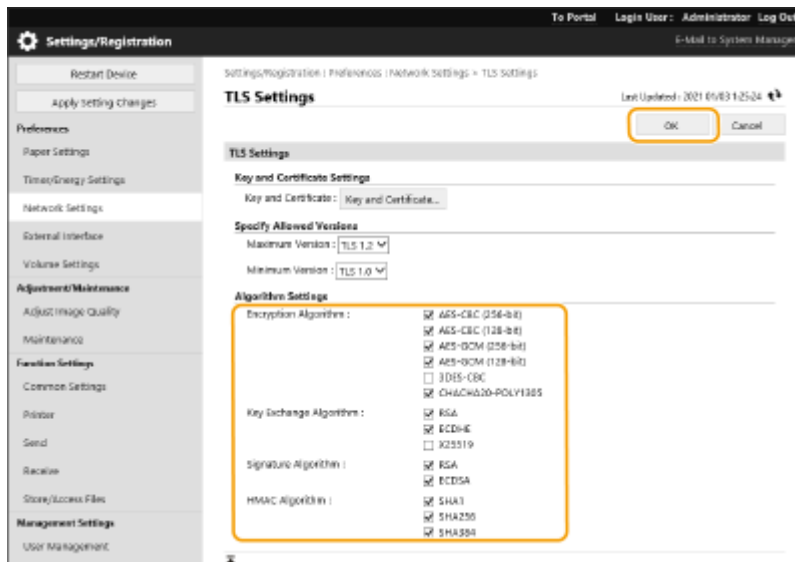

The following combinations of TLS version and algorithm are available.

✓ : Available
 - : Unavailable

Algorithm	TLS Version			
	[TLS 1.3]	[TLS 1.2]	[TLS 1.1]	[TLS 1.0]
[Encryption Algorithm]				
[AES-CBC (256-bit)]	-	✓	✓	✓
[AES-GCM (256-bit)]	✓	✓	-	-
[3DES-CBC]	-	✓	✓	✓
[AES-CBC (128-bit)]	-	✓	✓	✓
[AES-GCM (128-bit)]	✓	✓	-	-
[CHACHA20-POLY1305]	✓	-	-	-
[Key Exchange Algorithm]				
[RSA]	-	✓	✓	✓
[ECDHE]	✓	✓	✓	✓
[X25519]	✓	-	-	-
[Signature Algorithm]				

[RSA]	✓	✓	✓	✓
[ECDSA]	✓	✓	✓	✓
[HMAC Algorithm]				
[SHA1]	-	✓	✓	✓
[SHA256]	✓	✓	-	-
[SHA384]	✓	✓	-	-

NOTE

- [Format Encryption Method to FIPS 140-2] cannot be used when [CHACHA20-POLY1305] or [X25519] is selected.

Starting the Remote UI with TLS

- If you try to start the Remote UI when TLS is enabled, a security alert may be displayed regarding the security certificate. In this case, check that the correct URL is entered in the address field, and then proceed to display the Remote UI screen. [▶ Starting the Remote UI\(P. 262\)](#)

Batch importing/batch exporting

- This setting can be imported/exported with models that support batch importing of this setting. [▶ Importing/Exporting the Setting Data\(P. 273\)](#)
- This setting is included in [Settings/Registration Basic Information] when batch exporting. [▶ Importing/Exporting All Settings\(P. 275\)](#)

Setting the Security Strength and Encryption Method

- 1** Start the Remote UI. [▶ Starting the Remote UI\(P. 262\)](#)
- 2** Click [Settings/Registration] on the portal page. [▶ Remote UI Screen\(P. 263\)](#)
- 3** Click [Security Settings] ▶ [Encryption/Key Settings].
- 4** Click [Edit] in [Encryption Settings].
- 5** Configure the encryption settings and encryption method, and click [OK].

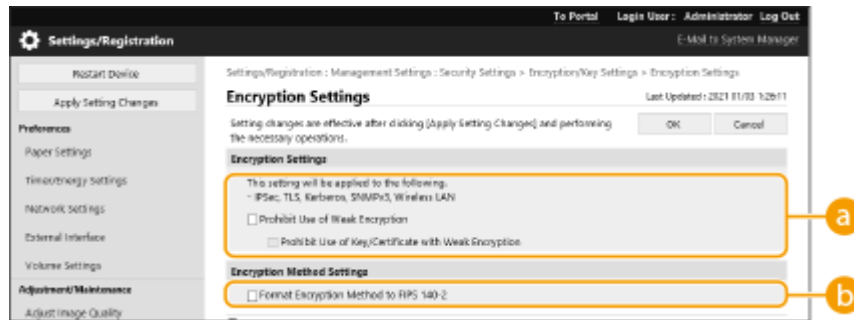

a [Prohibit Use of Weak Encryption]

Select this check box to prohibit the use of weak encryption with a key length of 1024 bits or less. To prohibit the use of keys and certificates that use weak encryption, select [Prohibit Use of Key/Certificate with Weak Encryption].

b [Format Encryption Method to FIPS 140-2]

Select this check box to make functions using encryption comply with FIPS 140-2.

NOTE

- If you select [Format Encryption Method to FIPS 140-2], you can make the TLS communication encryption method comply with the United States government-approved FIPS (Federal Information Processing Standards) 140-2, but the following limitations apply.
 - An error will occur if you specify a certificate for TLS that uses an algorithm not recognized by FIPS (lower than RSA2048bit).
 - A communication error will occur if the communication destination does not support FIPS-recognized encryption algorithms.
 - [CHACHA20-POLY1305] and [X25519] can no longer be used.

Batch importing/batch exporting

- This setting can be imported/exported with models that support batch importing of this setting. [▶ Importing/Exporting the Setting Data\(P. 273\)](#)
- This setting is included in [Settings/Registration Basic Information] when batch exporting. [▶ Importing/Exporting All Settings\(P. 275\)](#)

LINKS

- ▶ [Generating the Key and Certificate for Network Communication\(P. 227\)](#)
- ▶ [Generating a Key and Certificate Signing Request \(CSR\)\(P. 229\)](#)
- ▶ [Registering a Key and Certificate for Network Communication\(P. 232\)](#)
- ▶ [Starting the Remote UI\(P. 262\)](#)
- ▶ [Configuring E-Mail Print Settings\(P. 45\)](#)

Generating the Key and Certificate for Network Communication

7L2J-04H



The machine can generate the key and certificate (server certificate) used for TLS encrypted communication. If you want to start using TLS encrypted communication immediately, it is convenient to use the key and certificate that are preinstalled in the machine. If necessary, have an administrator generate a key and certificate. Note, however, that TLS encrypted communication is not enabled simply by generating a key and certificate. ▶ **Configuring the Key and Certificate for TLS(P. 223)**

NOTE

- If you want to use a server certificate with a CA signature, you can generate the key along with a CSR, instead of the certificate. ▶ **Generating a Key and CSR(P. 229)**

- 1 Start the Remote UI.** ▶ **Starting the Remote UI(P. 262)**
- 2 Click [Settings/Registration] on the portal page.** ▶ **Remote UI Screen(P. 263)**
- 3 Click [Device Management] ▶ [Key and Certificate Settings].**
- 4 Click [Generate Key].**

NOTE:

Deleting a registered key and certificate

- Select the key and certificate to delete → click [Delete] ▶ [OK].
- A key and certificate cannot be deleted if it is currently used for some purpose, such as when "TLS" or "IEEE 802.1X" is displayed under [Key Usage]. In this case, disable the function or replace the other key and certificate before deleting it.

- 5 Click [Network Communication].**
- 6 Specify settings for the key and certificate.**

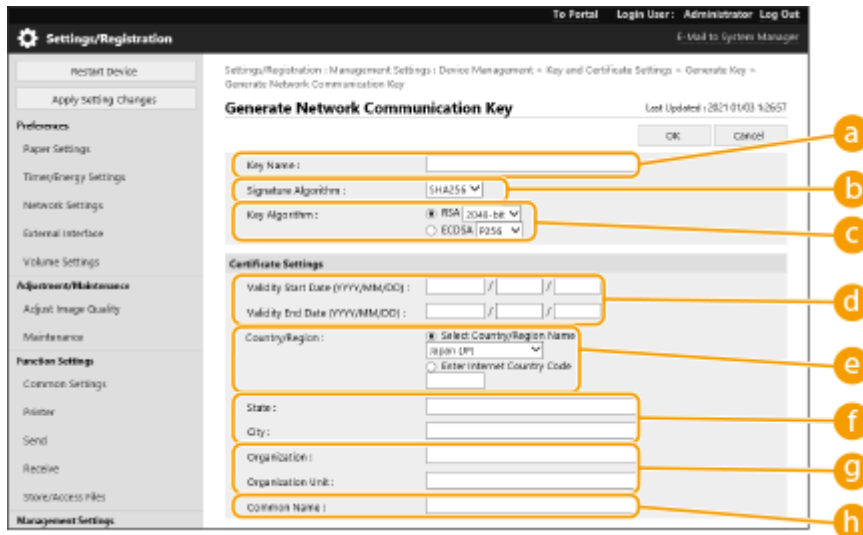

a [Key Name]

Enter alphanumeric characters for naming the key. Set a name that will be easy for you to find later in a list.

b [Signature Algorithm]

Select the hash algorithm to use for the signature. The available hash algorithms vary depending on the key length (▶ **Management Functions(P. 523)**). A key length of 1024 bits or more can support SHA384 and SHA512 hash algorithms.

c [Key Algorithm]

Select [RSA] or [ECDSA] as the key generation algorithm. Select the key length if you selected [RSA] and the key type if you selected [ECDSA]. In both cases, a higher value provides greater security but reduces the communication processing speed.

NOTE:

- If [SHA384] or [SHA512] is selected for [Signature Algorithm], the key length cannot be set to [512-bit] when [RSA] is selected for [Key Algorithm].

d [Validity Start Date (YYYY/MM/DD)]/[Validity End Date (YYYY/MM/DD)]

Enter the start date and end date of the validity period for the certificate. [Validity End Date (YYYY/MM/DD)] cannot be set to a date before the date in [Validity Start Date (YYYY/MM/DD)].

e [Country/Region]

Click the [Select Country/Region] radio button and select the country/region from the drop-down list. You can also click the [Enter Internet Country Code] radio button and enter a country code, such as "US" for the United States.

f [State]/[City]

Enter alphanumeric characters for the location as necessary.

g [Organization]/[Organization Unit]

Enter alphanumeric characters for the organization name as necessary.

h [Common Name]

Enter alphanumeric characters for the common name of the certificate as necessary. "Common Name" is often abbreviated as "CN."

7 Click [OK].

- Generating a key and certificate may take some time.
- After the key and certificate is generated, it is automatically registered to the machine.

LINKS

- ▶ **Registering a Key and Certificate for Network Communication(P. 232)**
- ▶ **Configuring the Key and Certificate for TLS(P. 223)**
- ▶ **Configuring the IPSec Settings(P. 244)**

Generating a Key and Certificate Signing Request (CSR)

7L2J-04J

Certificates generated on this machine do not have a CA signature, which may cause communication errors with some communication peers. To request a certificate with a CA signature, certificate signing request (CSR) data is required. A user who logs in with administrator privileges can generate a CSR.

- ▶ **Generating a Key and CSR(P. 229)**
- ▶ **Registering a Certificate to a Key(P. 230)**

Generating a Key and CSR

You can generate a key and CSR on the machine. You can also display the CSR data on the screen and export it as a file.

- 1 Start the Remote UI. ▶Starting the Remote UI(P. 262)**
- 2 Click [Settings/Registration] on the portal page. ▶Remote UI Screen(P. 263)**
- 3 Click [Device Management] ▶ [Key and Certificate Settings].**
- 4 Click [Generate Key].**
- 5 Click [Key and Certificate Signing Request (CSR)].**
- 6 Configure the necessary items for the key and certificate.**

The screenshot shows the 'Generate Key and Certificate Signing Request (CSR)' form. The form is titled 'Generate Key and Certificate Signing Request (CSR)' and includes the following fields:

- a** Key Name: [Text input field]
- b** Signature Algorithm: [Dropdown menu, currently showing 'SHA256']
- c** Key Algorithm: [Radio buttons, 'RSA (2048-bit)' is selected, 'ECDSA (P256)' is unselected]
- d** Certificate Signing Request (CSR) Settings:
 - Country/Region: [Dropdown menu, currently showing 'Select Country/Region Name']
 - State: [Text input field]
 - City: [Text input field]
 - Organization: [Text input field]
 - Organization Unit: [Text input field]
 - Common Name: [Text input field]

a [Key Name]

Enter a name for the key. Use a name that will be easy to find when displayed in a list.

b [Signature Algorithm]

Select the hash algorithm to use for the signature.

c [Key Algorithm]

Select the key algorithm, and specify the key length if [RSA] is selected, or specify the key type if [ECDSA] is selected.

d [Country/Region]

Select the country code from the list, or enter it directly.

e [State]/[City]

Enter the location.

f [Organization]/[Organization Unit]

Enter the organization name.

g [Common Name]

Enter the IP address or FQDN.

- When performing IPPS printing in a Windows environment, make sure to enter the machine's IP address.
- A DNS server is required in order to enter the FQDN of the machine. Enter the IP address if a DNS server is not used.

7 Click [OK].

⇒ The CSR data is displayed.

- If you want to save the CSR data to a file, click [Store in File] and specify the save location.

NOTE

- The key that generated the CSR is displayed on the key and certificate list screen, but you cannot use it by itself. To use this key, you need to register the certificate that is later issued based on the CSR. ▶ **Registering a Certificate to a Key(P. 230)**

Registering a Certificate to a Key

You can register the certificate that was applied for and issued based on the CSR.

- 1 Start the Remote UI. ▶ Starting the Remote UI(P. 262)**
- 2 Click [Settings/Registration] on the portal page. ▶ Remote UI Screen(P. 263)**
- 3 Click [Device Management] ▶ [Key and Certificate Settings].**
- 4 In the [Certificate] list, click  for the certificate that you want to register.**

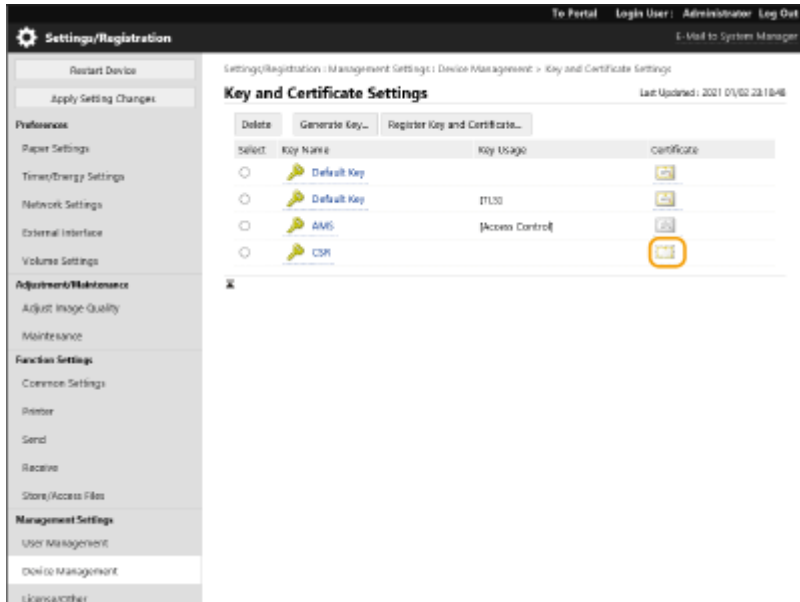

5 Click [Register Certificate].

6 Register the certificate.

- Click [Browse...], specify the file (certificate) to register, and click [Register].

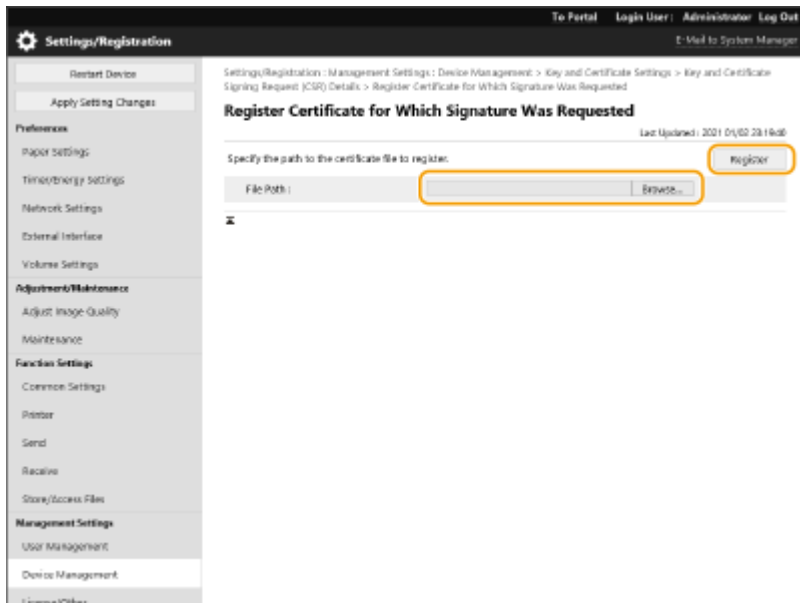

Registering a Key and Certificate for Network Communication

7L2J-04K

You can use the Remote UI to register keys/certificates and CA certificates to the machine from your computer. Designate an administrator to register these items.



▶ **Registering a Key and Certificate(P. 232)**

▶ **Registering a CA Certificate(P. 233)**

NOTE

The communication methods listed below use a key/certificate or CA certificate. If you want to use a registered key and certificate in actual communication, you need to specify the key and certificate in the settings for each communication method. However, an X.509 DER format CA certificate does not need to be specified in the settings for each communication method. You can use it simply by registering it to the machine.

- TLS encrypted communication ▶ **Configuring the Key and Certificate for TLS(P. 223)**
- IPSec ▶ **Configuring the IPSec Settings(P. 244)**
- IEEE 802.1X ▶ **Configuring the IEEE 802.1X Authentication Settings(P. 251)**

Registering a Key and Certificate

Keys and certificates (server certificates) can be registered via the Remote UI. For information on the keys and certificates that can be registered on the machine, see ▶ **Management Functions(P. 523)** .

- 1 Start the Remote UI. ▶ Starting the Remote UI(P. 262)**
- 2 Click [Settings/Registration] on the portal page. ▶ Remote UI Screen(P. 263)**
- 3 Click [Device Management] ▶ [Key and Certificate Settings].**
- 4 Click [Register Key and Certificate].**
- 5 Click [Install].**
- 6 Install the key and certificate.**
 - Click [Browse...], specify the files (key and certificate) to install, and click [Start Installation].

7 Register the key and certificate.

- 1 Select the key and certificate that you want to register, and click [Register].
- 2 Enter the key name and password, and click [OK].

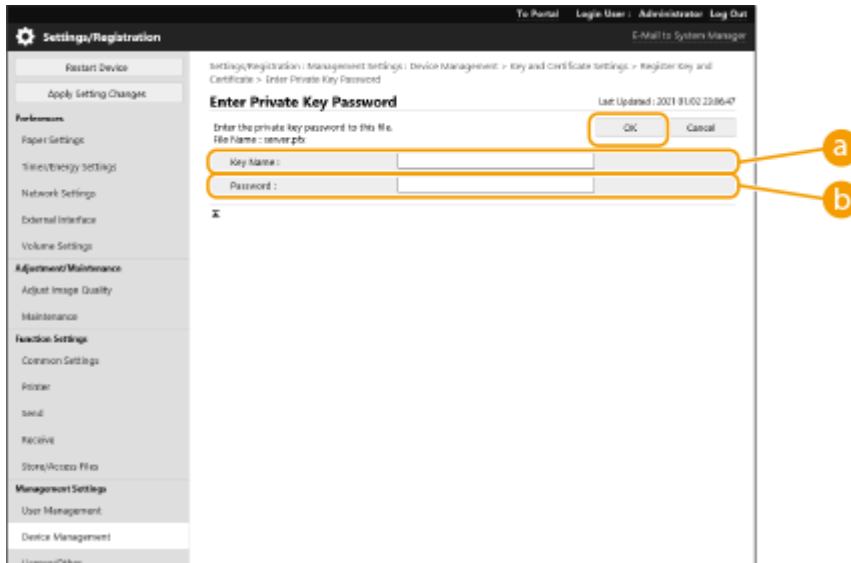

a [Key Name]

Use alphanumeric characters to enter the name of the key that was registered to the machine.



b [Password]

Use alphanumeric characters to enter the password of the private key that is set for the file to register.

NOTE

Managing keys and certificates

You can check the detailed settings or delete keys and certificates on the screen displayed in step 4.

- If  is displayed, the key is corrupted or invalid.
- If  is displayed, the certificate for the key does not exist.
- Click a key name to display detailed information about the certificate. You can also click [Verify Certificate] on this screen to check whether the certificate is valid.
- To delete a key and certificate, select the one that you want to delete, and click [Delete] ► [OK].

Registering a CA Certificate

X.509 DER format CA certificates are preinstalled in the machine. You can register a new CA certificate if it is required by a particular function. For information on the CA certificates that can be registered on the machine, see [▶ Management Functions\(P. 523\)](#) .

1 Start the Remote UI. [▶Starting the Remote UI\(P. 262\)](#)

2 Click [Settings/Registration] on the portal page. ▶ Remote UI Screen(P. 263)

3 Click [Device Management] ▶ [CA Certificate Settings].

4 Click [Register CA Certificate].

5 Click [Install].

6 Install the CA certificate.

- Click [Browse...], specify the file (CA certificate) to install, and click [Start Installation].

7 Register the CA certificate.

- Select the CA certificate that you want to register, and click [Register].

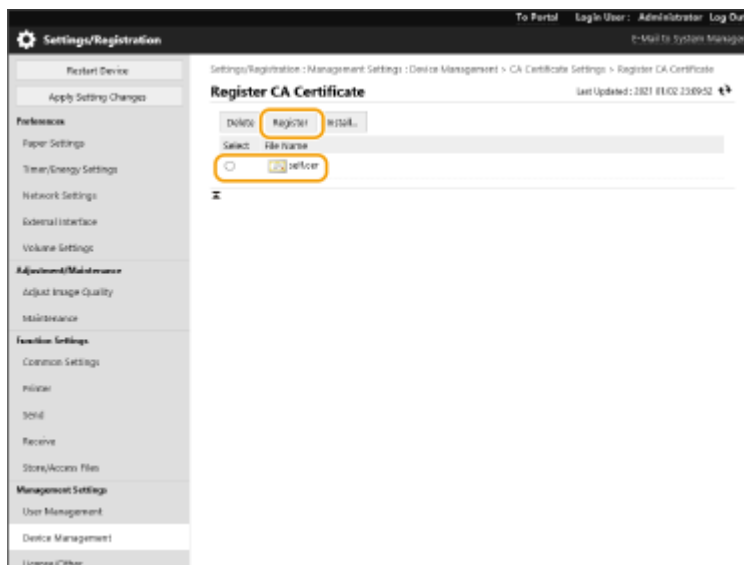

NOTE

Managing CA certificates

You can check the detailed settings or delete CA certificates on the screen displayed in step 4.

- Click  to display detailed information about the CA certificate. You can also click [Verify Certificate] on this screen to check whether the CA certificate is valid.
- To delete a CA certificate, select the one that you want to delete, and click [Delete] ▶ [OK].

Configuring the Expiration Check Method for Received Certificates

7L2J-04L

There are two methods for verifying whether certificates received from the other party in communication are valid: Comparing with the certificate revocation list (CRL) registered in the machine and querying an OCSP (online certificate status protocol) responder (a server that supports OCSP). Set the method for checking the expiration of certificates according to your environment. This registration can only be performed by the administrator.

- ▶ **Registering a Certificate Revocation List (CRL)(P. 235)**
- ▶ **Configuring the Online Certificate Status Protocol (OCSP)(P. 236)**

Registering a Certificate Revocation List (CRL)

You can use the Remote UI to register a certificate revocation list (CRL). For information on the CRLs that can be registered on the machine, see ▶ **Management Functions(P. 523)** .

- 1 Start the Remote UI. ▶Starting the Remote UI(P. 262)**
- 2 Click [Settings/Registration] on the portal page. ▶Remote UI Screen(P. 263)**
- 3 Click [Device Management] ▶ [Certificate Revocation List (CRL) Settings].**
- 4 Click [Register CRL].**
- 5 Register the CRL.**
 - Click [Browse...], specify the file (CRL) to register, and click [Register].

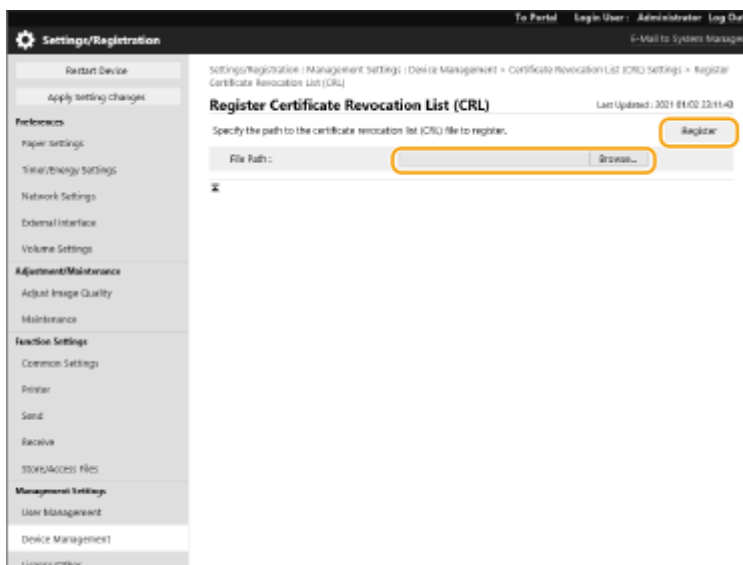

NOTE

Managing CRLs

You can check the detailed settings or delete CRLs on the screen displayed in step 4.

- Click  to display detailed information about it. You can also click [Verify CRL] on this screen to check whether the CRL is valid.
- To delete a CRL, select the one that you want to delete, and click [Delete] ▶ [OK].

Batch importing/batch exporting

- This setting can be imported/exported with models that support batch importing of this setting. ▶ **Importing/Exporting the Setting Data(P. 273)**
- This setting is included in [Certificate/Certificate Revocation List (CRL) Settings] when batch exporting. ▶ **Importing/Exporting All Settings(P. 275)**

Configuring the Online Certificate Status Protocol (OCSP)

You can configure the certificate verification level and the OCSP responder to connect to.

- 1 Start the Remote UI.** ▶ **Starting the Remote UI(P. 262)**
- 2 Click [Settings/Registration] on the portal page.** ▶ **Remote UI Screen(P. 263)**
- 3 Click [Device Management] ▶ [OCSP (Online Certificate Status Protocol) Settings].**
- 4 Select the check box for [Use OCSP (Online Certificate Status Protocol)], and configure the online certificate status protocol (OCSP).**

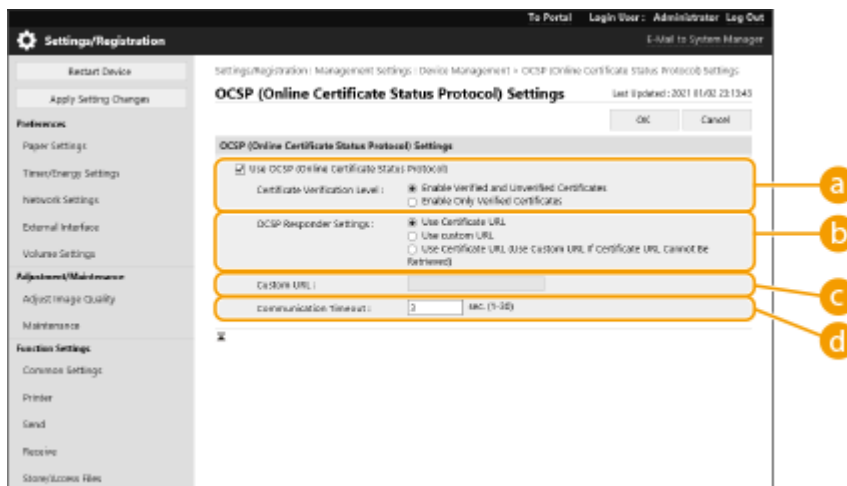

a [Certificate Verification Level]

Set whether to disable certificates in situations such as the following:

- When the machine cannot connect to the OCSP responder
- When a timeout occurs
- When expiration cannot be checked, such as when the result of checking the expiration of a certificate via the OCSP responder is unknown

b [OCSP Responder Settings]

Specify the URL for connecting to the OCSP responder.

c [Custom URL]

When [Use custom URL] or [Use Certificate URL (Use Custom URL If Certificate URL Cannot Be Retrieved)] is selected, enter the URL of the OCSP responder (ASCII code only, maximum 255 characters).

d [Communication Timeout]

Set the time until communication with the OCSP responder times out. The connection is canceled if there is no response from the OCSP responder within the set time.

5 Click [OK].**NOTE****Batch importing/batch exporting**

- This setting can be imported/exported with models that support batch importing of this setting. [▶ Importing/Exporting the Setting Data\(P. 273\)](#)
- This setting is included in [Settings/Registration Basic Information] when batch exporting. [▶ Importing/Exporting All Settings\(P. 275\)](#)

Retrieving/Updating a Certificate from an SCEP Server

7L2J-04R

A request for issuing the certificate required for keys generated with the machine can be sent to an SCEP (Simple Certificate Enrollment Protocol) server that manages certificates. Certificates issued from the SCEP server are automatically registered to the machine. Administrator privileges are required to send a request for issuing a certificate.

- ▶ **Specifying the Communication Settings of the SCEP Server(P. 238)**
- ▶ **Requesting a Certificate to Be Issued(P. 239)**
- ▶ **Requesting a Certificate to Be Issued at the Specified Time(P. 240)**
- ▶ **Checking the Status of Requesting a Certificate to Be Issued(P. 242)**

Specifying the Communication Settings of the SCEP Server

You can specify the settings for communicating with the SCEP server.

- 1 Start the Remote UI. ▶Starting the Remote UI(P. 262)**
- 2 Click [Settings/Registration] on the portal page. ▶Remote UI Screen(P. 263)**
- 3 Click [Device Management] ▶ [Settings for Certificate Issuance Request (SCEP)].**
- 4 Click [Communication Settings].**
- 5 Set the required communication settings.**

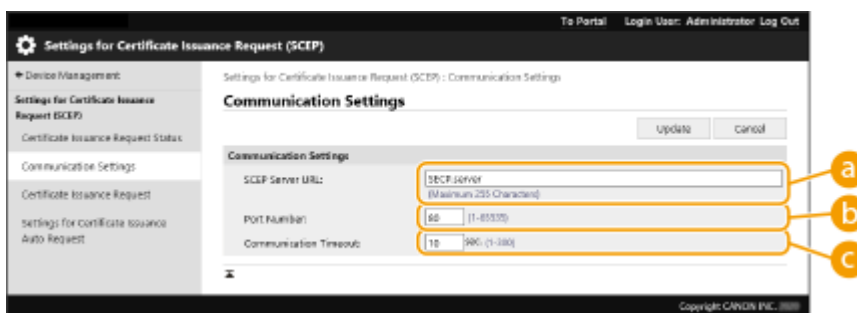

a [SCEP Server URL:]

Specify the URL of the SCEP server to connect to.

b [Port Number:]

Enter the port number to use for communicating with the SCEP server.

c [Communication Timeout:]

Enter the timeout time for communication with the SCEP server. The connection is canceled if there is no response from the SCEP server within the set time.

- 6 Click [Update].**

NOTE

- The settings cannot be updated when [Enable Timer for Certificate Issuance Auto Request] is selected.
 - ▶ **Requesting a Certificate to Be Issued at the Specified Time(P. 240)**
- For information on the supported versions of SCEP, see ▶ **Management Functions(P. 523)** .

Requesting a Certificate to Be Issued

You can manually request a certificate to be issued.

- 1 Start the Remote UI.** ▶ **Starting the Remote UI(P. 262)**
- 2 Click [Settings/Registration] on the portal page.** ▶ **Remote UI Screen(P. 263)**
- 3 Click [Device Management] ▶ [Settings for Certificate Issuance Request (SCEP)].**
- 4 Click [Certificate Issuance Request].**
- 5 Set the items required for requesting a certificate to be issued.**

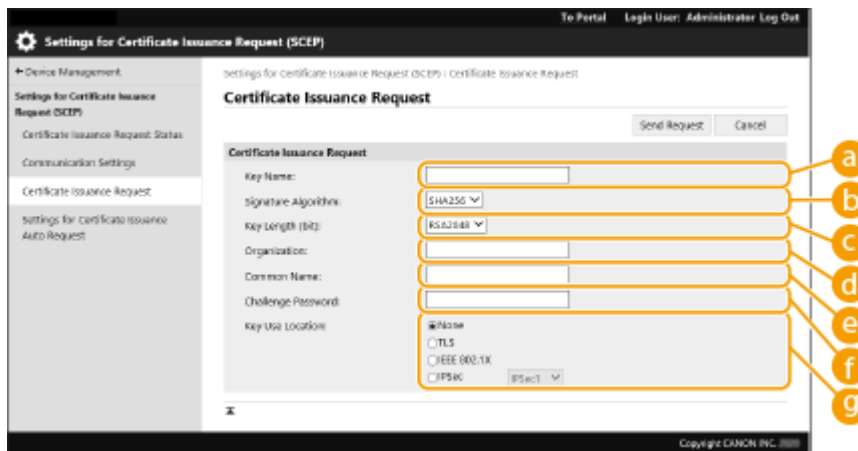

a [Key Name:]

Enter the name for the key. Enter a name that will be easy to find when displayed in a list.

b [Signature Algorithm:]

Select the hash function to use for the signature.

c [Key Length (bit):]

Select the key length.

d [Organization:]

Enter the organization name.

e [Common Name:]

Enter the IP address or FQDN.

- When performing IPPS printing in a Windows environment, make sure to enter the IP address of the machine.
- A DNS server is required to enter the FQDN of the machine. Enter the IP address of the machine if a DNS server is not used.

f [Challenge Password:]

When a password is set on the SCEP server side, enter the challenge password included in the request data (PKCS#9) for requesting a certificate to be issued.

g [Key Use Location:]

Select the destination where the key will be used. When [IPSec] is selected, select the IPSec of the destination from the drop-down list.

NOTE:

- When selecting something other than [None], enable the various functions in advance. If a certificate is successfully obtained with the various functions disabled, the certificate is assigned as the destination, but the various functions are not automatically enabled.

6 Click [Send Request].

7 Click [Restart].

NOTE

- A manual request for issuing a certificate cannot be sent when [Enable Timer for Certificate Issuance Auto Request] is selected. **▶Requesting a Certificate to Be Issued at the Specified Time(P. 240)**
- The information set here is not saved to the storage of the machine.

Requesting a Certificate to Be Issued at the Specified Time

You can set to automatically request a certificate to be issued at a specified time.

- 1 Start the Remote UI. ▶Starting the Remote UI(P. 262)**
- 2 Click [Settings/Registration] on the portal page. ▶Remote UI Screen(P. 263)**
- 3 Click [Device Management] ▶ [Settings for Certificate Issuance Request (SCEP)].**
- 4 Click [Settings for Certificate Issuance Auto Request].**
- 5 Set the items required for requesting a certificate to be issued.**

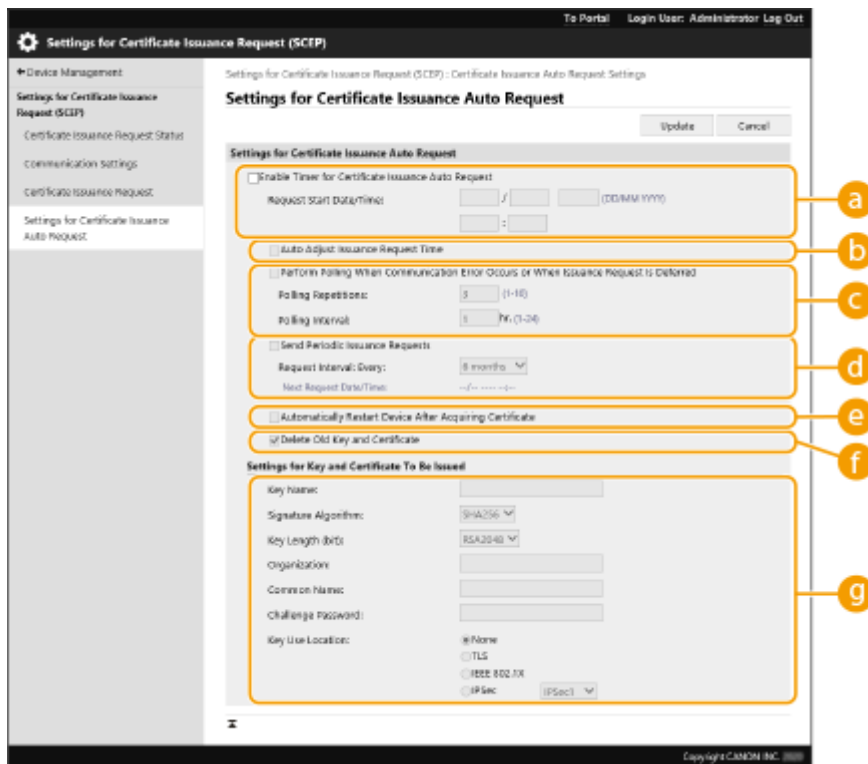

a [Enable Timer for Certificate Issuance Auto Request]

Select this to automatically request a certificate to be issued at a specified time, and specify the start date/time in [Request Start Date/Time:].

b [Auto Adjust Issuance Request Time]

Select this to adjust the time to send the request. This reduces load on the SCEP server when multiple printers/multifunction printers send a request at the same time. The time is randomly adjusted 1 to 600 seconds from the time specified in [Request Start Date/Time:].

c [Perform Polling When Communication Error Occurs or When Issuance Request Is Deferred]

Select this to check the status of the SCEP server when a communication error has occurred or when a certificate issue request is pending. Specify the number of polling times and polling interval.

NOTE:

- In the following cases, polling is not performed and an error occurs.
- When the machine has exceeded the limit of keys and certificates it can hold
- When an error is included in the retrieved response data
- When an error occurs on the SCEP server side

d [Send Periodic Issuance Requests]

Select this to periodically send an automatic request for a certificate to be issued, and specify the interval in [Request Interval: Every:].

When an automatic request for a certificate to be issued is performed successfully, the next date/time to issue a request is displayed in [Next Request Date/Time:].

e [Automatically Restart Device After Acquiring Certificate]

Select this to restart the machine after the certificate is retrieved.

! IMPORTANT:

- The machine is restarted even during batch importing/exporting.

f [Delete Old Key and Certificate]

Select this to overwrite the old key and certificate.

NOTE:

- The key and certificate with the same destination for use are overwritten.
- The default key is not overwritten.

9 [Settings for Key and Certificate To Be Issued]

Enter the information for the key to generate. For information on the settings, see step 5 of **Requesting a Certificate to Be Issued(P. 239)** .

6 Click [Update].

Checking the Status of Requesting a Certificate to Be Issued

The certificate requested and issued based on the CSR is registered in the key.



Start the Remote UI ▶ click [Settings/Registration] ▶ [Device Management] ▶ [Certificate Issuance Request Status].

- The following statuses are displayed in [Status].
 - [To Be Processed]: The next date/time to issue a request is displayed in [Request Date/Time].
 - [Processing...]: Polling is being performed.
 - [Error]: An error such as a communication error or key upper limit exceeded error has occurred.
 - [Successful]: The date/time that the certificate was successfully issued is displayed in [Request Date/Time].
- The information displayed in [Details] in [Error] is indicated below.

[Details]	Cause
Deferred	The pending status was returned from the SCEP server.
Key and Certificate Registration Limit Error	The limit to the number of keys and certificates that can be registered in the machine was reached.
Communication Error (TOP ERROR)	Connection to the SCEP server failed/a communication timeout occurred.
Communication Error (TOP ERROR <HTTP status code>)	An HTTP error occurred.
Communication Error (SCEP ERROR Fail Info 0)	Unrecognized or unsupported algorithm.
Communication Error (SCEP ERROR Fail Info 1)	Integrity check (meaning signature verification of the CMS message) failed.
Communication Error (SCEP ERROR Fail Info 2)	Transaction not permitted or supported.
Communication Error (SCEP ERROR Fail Info 3)	The signingTime attribute from the CMS authenticatedAttributes was not sufficiently close to the system time.
Communication Error (SCEP ERROR Fail Info 4)	No certificate could be identified matching the provided criteria.

NOTE

- History for the last 20 certificates is displayed. When the number of certificates exceeds 20, the oldest information is overwritten.
- This setting can be imported/exported with models that support batch importing of this setting. [▶ Importing/Exporting the Setting Data\(P. 273\)](#)
- When performing batch exporting, this setting is included in [Settings/Registration Basic Information]. [▶ Importing/Exporting All Settings\(P. 275\)](#)

LINKS

- [▶ Configuring the Key and Certificate for TLS\(P. 223\)](#)
- [▶ Configuring the IEEE 802.1X Authentication Settings\(P. 251\)](#)
- [▶ Configuring the IPSec Settings\(P. 244\)](#)

Configuring the IPSec Settings

7L2J-04S

By using IPSec, you can prevent third parties from intercepting or tampering with IP packets transported over the IP network. Because IPSec adds security functions to IP, a basic protocol suite used for the Internet, it can provide security that is independent of applications or network configuration. To perform IPSec communication with this machine, you must configure settings such as the application parameters and the algorithm for authentication and encryption. Administrator privileges are required in order to configure these settings.

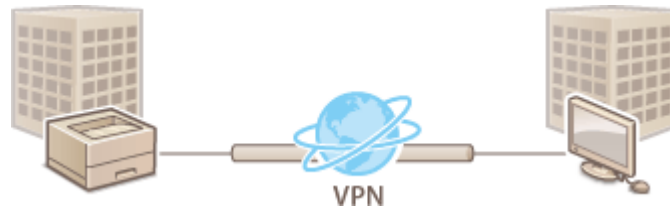

▶ [Enabling IPSec\(P. 245\)](#)

▶ [Registering a Policy\(P. 245\)](#)

! IMPORTANT

Communication mode

- This machine only supports transport mode for IPSec communication. As a result, authentication and encryption is only applied to the data portions of IP packets.

Key exchange protocol

This machine supports Internet Key Exchange version 1 (IKEv1) for exchanging keys based on the Internet Security Association and Key Management Protocol (ISAKMP). For the authentication method, set either the pre-shared key method or the digital signature method.

- When setting the pre-shared key method, you need to decide on a passphrase (pre-shared key) in advance, which is used between the machine and the IPSec communication peer.
- When setting the digital signature method, use a CA certificate and a PKCS#12 format key and certificate to perform mutual authentication between the machine and the IPSec communication peer. For more information on registering new CA certificates or keys/certificates, see ▶ [Registering a Key and Certificate for Network Communication\(P. 232\)](#) . Note that SNTP must be configured for the machine before it uses this method. ▶ [Making SNTP Settings\(P. 40\)](#)

NOTE

- Regardless of the setting of [Format Encryption Method to FIPS 140-2] for IPSec communication, an encryption module which has already obtained FIPS140-2 certification will be used.
- In order to make IPSec communication comply with FIPS 140-2, you must set the key length of both DH and RSA for IPSec communication to 2048-bit or longer in the network environment that the machine belongs to.
- Only the key length for DH can be specified from the machine.
- Take note when configuring your environment, as there are no settings for RSA in the machine.
- You can register up to 10 security policies.

Enabling IPsec

- 1 Start the Remote UI. ▶ Starting the Remote UI(P. 262)
- 2 Click [Settings/Registration] on the portal page. ▶ Remote UI Screen(P. 263)
- 3 Click [Network Settings] ▶ [IPsec Settings].
- 4 Select [Use IPsec], and click [OK].

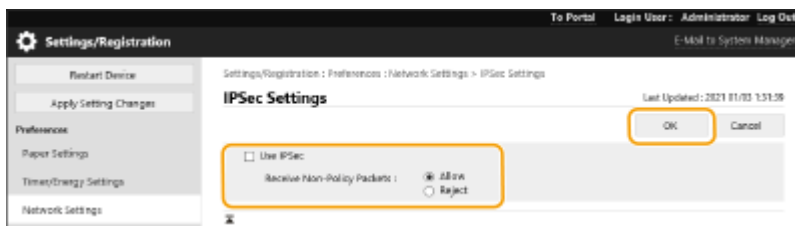

- To only receive packets that correspond to the security policy, select [Reject] for [Receive Non-Policy Packets].

Registering a Policy

- 1 Start the Remote UI. ▶ Starting the Remote UI(P. 262)
- 2 Click [Settings/Registration] on the portal page. ▶ Remote UI Screen(P. 263)
- 3 Click [Network Settings] ▶ [IPsec Policy List].
- 4 Click [Register New IPsec Policy].
- 5 Set a policy.

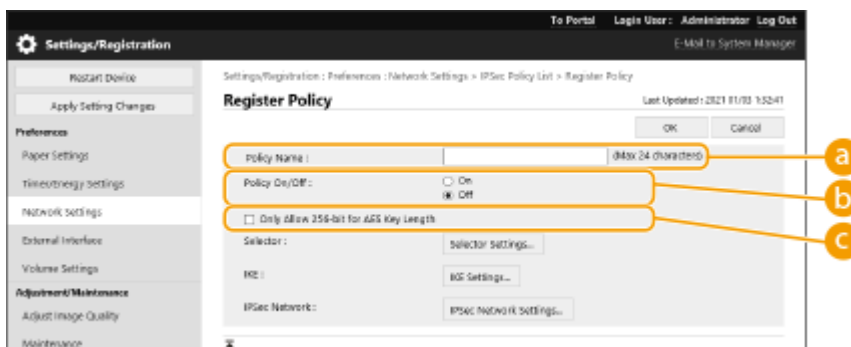

- a [Policy Name]**
Enter a name for identifying the policy.
- b [Policy On/Off]**
Select [On] to enable the registered policy.
- c [Only Allow 256-bit for AES Key Length]**
Select this check box to restrict the key length of the AES encryption method to 256 bit and meet CC authentication standards.

6 Configure the IPsec application parameters.

- 1 Click [Selector Settings].
- 2 Specify the IP address to apply the IPsec policy to.
 - Specify the IP address of this machine in [Local Address], and specify the IP address of the communication peer in [Remote Address].

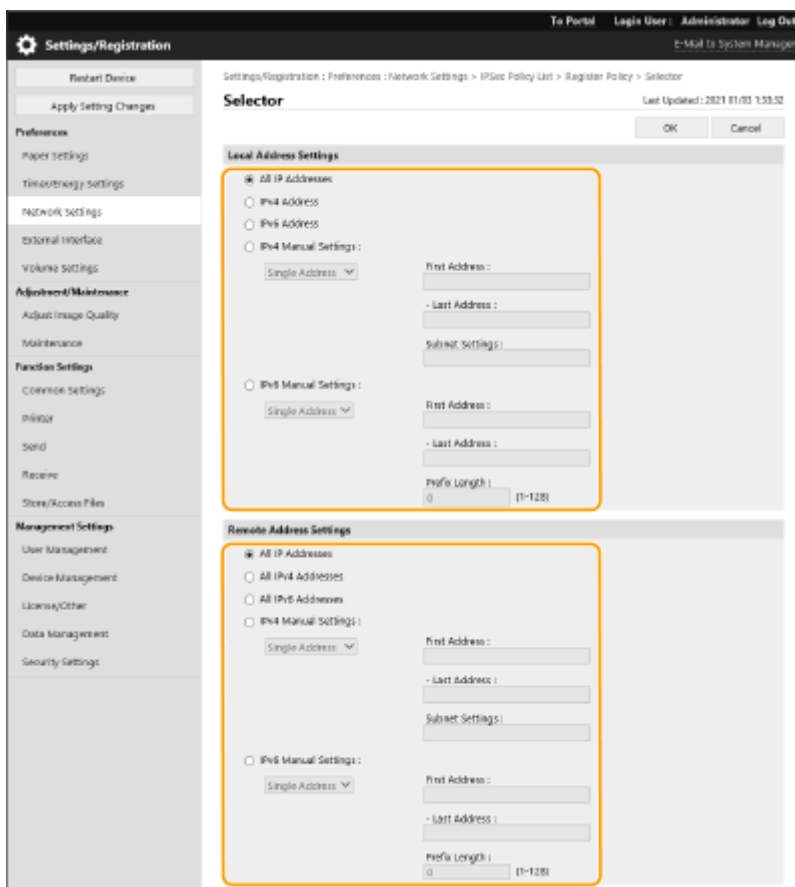

[All IP Addresses]	IPsec is applied to all sent and received IP packets.
[IPv4 Address]	IPsec is applied to IP packets sent to and received from the IPv4 address of this machine.
[IPv6 Address]	IPsec is applied to IP packets sent to and received from the IPv6 address of this machine.
[All IPv4 Addresses]	IPsec is applied to IP packets sent to and received from the IPv4 address of the communication peer.
[All IPv6 Addresses]	IPsec is applied to IP packets sent to and received from the IPv6 address of the communication peer.
[IPv4 Manual Settings]	Specify the IPv4 address to apply IPsec to.

	<ul style="list-style-type: none"> • Select [Single Address] to enter an individual IPv4 address. • Select [Range Address] to specify a range of IPv4 addresses. Enter a separate address for [First Address] and [Last Address]. • Select [Subnet Settings] to specify a range of IPv4 addresses using a subnet mask. Enter separate values for [First Address] and [Subnet Settings].
[IPv6 Manual Settings]	<p>Specify the IPv6 address to apply IPsec to.</p> <ul style="list-style-type: none"> • Select [Single Address] to enter an individual IPv6 address. • Select [Range Address] to specify a range of IPv6 addresses. Enter a separate address for [First Address] and [Last Address]. • Select [Prefix Address] to specify a range of IPv6 addresses using a prefix. Enter separate values for [First Address] and [Prefix Length].

3 Specify the port to apply IPsec to.

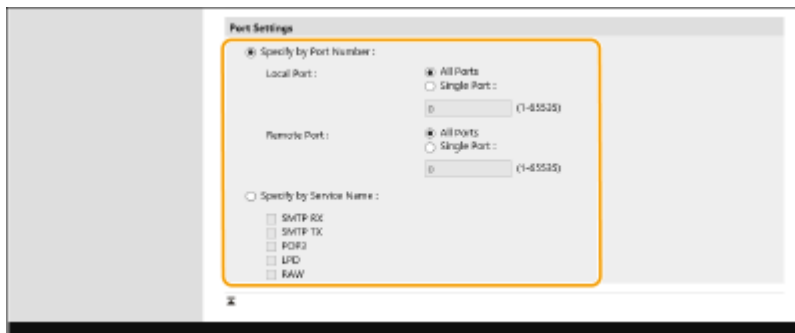

- Select [Specify by Port Number] to use port numbers when specifying the ports that IPsec applies to. Select [All Ports] to apply IPsec to all port numbers. To apply IPsec to a specific port number [Single Port] and enter the port number. Specify the port of this machine in [Local Port], and specify the port of the communication peer in [Remote Port].
- To specify the ports to apply IPsec to by service name, select [Specify by Service Name] and select the services to use.

4 Click [OK].

7 Configure the authentication and encryption settings.

1 Click [IKE Settings].

2 Configure the necessary settings.

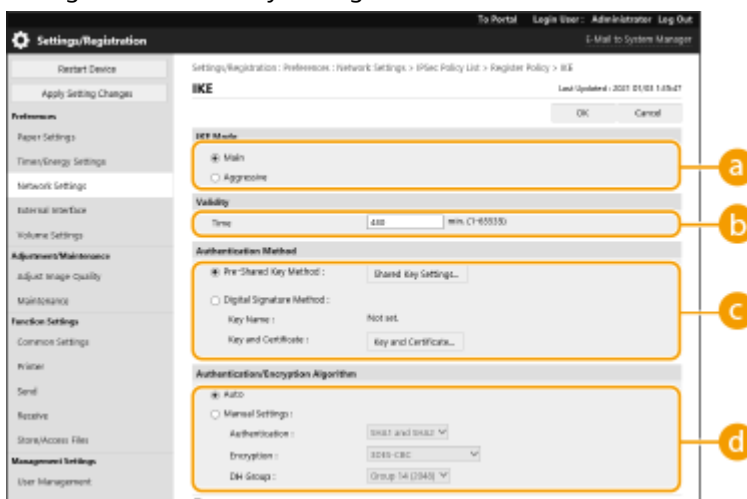

a [IKE Mode]

Select the operation mode for the key exchange protocol. Security is enhanced if you select [Main] because the IKE session itself is encrypted, but the speed of the session is slower than with [Aggressive], which does not encrypt the entire session.

b [Validity]

Set the expiration period of the generated IKE SA.

c [Authentication Method]

Select one of the authentication methods described below.

[Pre-Shared Key Method]	Set the same passphrase (pre-shared key) that is set for the communication peer. Select [Shared Key Settings], enter the character string to use as the shared key, and select [OK].
[Digital Signature Method]	Set the key and certificate to use for mutual authentication with the communication peer. Click [Key and Certificate], and click [Use] for the key to use.

d [Authentication/Encryption Algorithm]

Select either [Auto] or [Manual Settings] to set how to specify the authentication and encryption algorithm for IKE phase 1. If you select [Auto] an algorithm that can be used by both this machine and the communication peer is set automatically. If you want to specify a particular algorithm, select [Manual Settings] and configure the settings below.

[Authentication]	Select the hash algorithm.
[Encryption]	Select the encryption algorithm.
[DH Group]	Select the group for the Diffie-Hellman key exchange method to set the key strength.

3 Click [OK].

NOTE

- When [IKE Mode] is set to [Main] on the [IKE] screen and [Authentication Method] is set to [Pre-Shared Key Method], the following restrictions apply when registering multiple security policies.
 - **Pre-shared key method key:** when specifying multiple remote IP addresses to which a security policy is to be applied, all shared keys for that security policy are identical (this does not apply when a single address is specified).
 - **Priority:** when specifying multiple remote IP addresses to which a security policy is to be applied, the priority of that security policy is below security policies for which a single address is specified.

8 Configure the IPSec communication settings.

- 1** Click [IPSec Network Settings].
- 2** Configure the necessary settings.



a [Validity]

Set the expiration period of the generated IPsec SA. Make sure to set either [Time] or [Size]. If you set both, the setting with the value that is reached first is applied.

b [PFS]

If you select [Use PFS], the secrecy of the encryption key is increased but communication speed is slower. In addition, the Perfect Forward Secrecy (PFS) function must be enabled on the communication peer device.

c [Authentication/Encryption Algorithm]

Select either [Auto] or [Manual Settings] to set how to specify the authentication and encryption algorithm for IKE phase 2. If you select [Auto], the ESP authentication and encryption algorithm is set automatically. If you want to specify a particular authentication method, select [Manual Settings] and select one of the authentication methods below.

[ESP]	Authentication and encryption are both performed. Select the algorithm for [ESP Authentication] and [ESP Encryption]. Select [NULL] if you do not want to set the authentication or encryption algorithm.
[ESP (AES-GCM)]	AES-GCM is used as the ESP algorithm, and authentication and encryption are both performed.
[AH (SHA1)]	Authentication is performed, but data is not encrypted. SHA1 is used as the algorithm.

3 Click [OK] .

9 Click [OK].

10 Enable the registered policies and check the order of priority.

- Policies are applied in the order that they are listed, starting at the top. If you want to change the order of priority, select a policy in the list and click [Raise Priority] or [Lower Priority].

NOTE

Managing IPsec policies

You can edit policies on the screen displayed in step 4.

- To edit the details of a policy, click the policy name in the list.
- To disable a policy, click the policy name in the list ► select [Off] for [Policy On/Off] ► click [OK].
- To delete a policy, select the policy in the list ► click [Delete] ► [OK].

Using the operation panel

- You can also enable or disable IPsec communication from <Set> in the <Home> screen. ▶<IPsec Settings>(P. 366)

Batch importing/batch exporting

- This setting can be imported/exported with models that support batch importing of this setting. ▶
Importing/Exporting the Setting Data(P. 273)
- This setting is included in [Settings/Registration Basic Information] when batch exporting. ▶**Importing/Exporting All Settings(P. 275)**

Configuring the IEEE 802.1X Authentication Settings

7L2J-04U

In a network environment that uses IEEE 802.1X authentication, unauthorized network access is blocked by a LAN switch (authenticator) that only grants access privileges to client devices (supplicants) that are authorized by the authentication server (RADIUS server). To connect this machine to an IEEE 802.1X network, settings such as the authentication method used by the authentication server must be configured on the machine. Administrator privileges are required in order to configure these settings.

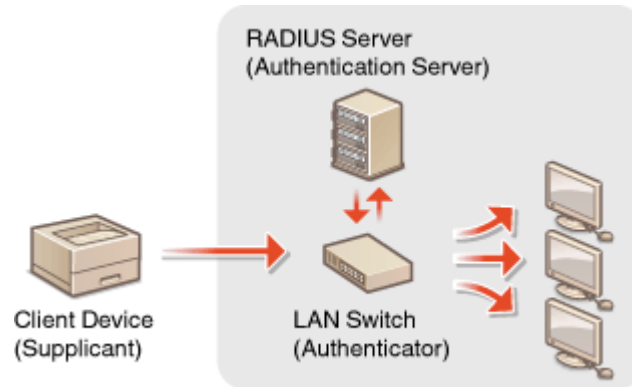

IEEE 802.1X Authentication Method

The machine supports the authentication methods described below. You must register a CA certificate before using any of these authentication methods. [▶Registering a CA Certificate\(P. 233\)](#)

■ EAP-TLS (Extensible Authentication Protocol-Transport Level Security)

The machine and the authentication server authenticate each other by mutually sending certificates. A CA certificate must be registered on the machine to verify the certificate (server certificate) sent from the authentication server. In addition, a PKCS#12 format key and certificate (client certificate) must be specified in this setting, so that the authentication server can authenticate the machine. Register these items before configuring the settings ([▶Registering a Key and Certificate\(P. 232\)](#)). This authentication method cannot be used in combination with the other methods.

■ EAP-TTLS (EAP-Tunneled TLS)

Only the authentication server sends a certificate. A CA certificate must be registered on the machine to verify the certificate (server certificate) sent from the authentication server. In addition, a user name and password need to be specified in these settings, so that the authentication server can authenticate the machine. Microsoft Challenge Handshake Authentication Protocol Version 2 (MS-CHAPv2) or Password Authentication Protocol (PAP) can be selected as the internal authentication protocol to support EAP-TTLS.

■ PEAP (Protected EAP)

Only the authentication server sends a certificate. A CA certificate must be registered on the machine to verify the certificate (server certificate) sent from the authentication server. In addition, a user name and password need to be specified in these settings, so that the authentication server can authenticate the machine. Only MS-CHAPv2 can be selected as the internal authentication protocol to support PEAP.

Setting the IEEE 802.1X Authentication Method

- 1 Start the Remote UI. [▶Starting the Remote UI\(P. 262\)](#)
- 2 Click [Settings/Registration] on the portal page. [▶Remote UI Screen\(P. 263\)](#)

3 Click [Network Settings] ► [IEEE 802.1X Settings].

4 Select [Use IEEE 802.1X] and configure the required settings.

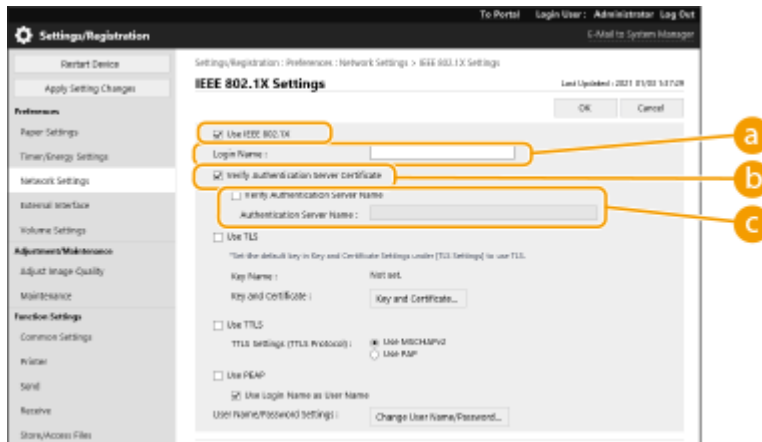

a [Login Name]

Enter the name (EAP Identity) of the login user to receive IEEE 802.1X authentication.

b [Verify Authentication Server Certificate]

Select this check box when verifying server certificates sent from an authentication server.

c [Verify Authentication Server Name]

To verify the common name in the server certificate, select this check box and enter the name of the authentication server where the login user is registered in [Authentication Server Name].

5 Select the authentication method and configure the necessary settings.

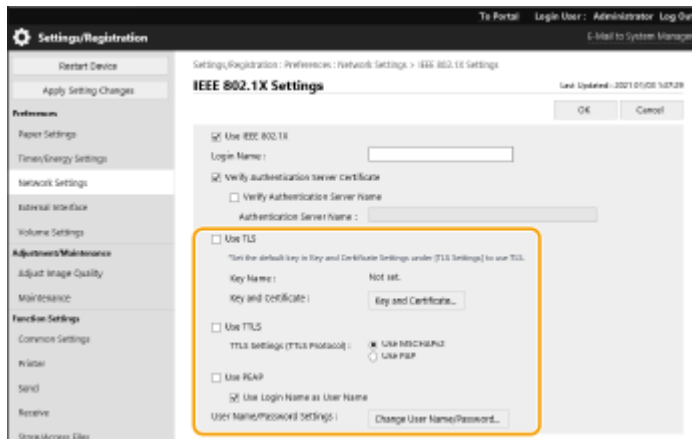

■ Selecting EAP-TLS

1 Select [Use TLS] and click [Key and Certificate].

2 Click [Use] for the key to use in the list.

■ Selecting EAP-TTLS/PEAP

1 Select [Use TTLS] or [Use PEAP].

- To use EAP-TTLS, select [Use MSCHAPv2] or [Use PAP] for [TTLS Settings (TTLS Protocol)].

2 Click [Change User Name/Password].

- To set a user name that differs from the login name for IEEE 802.1X authentication, deselect [Use Login Name as User Name]. To use the same name as the login name for IEEE 802.1X authentication, leave it selected.

3 Enter the user name and password.

- To set or change the password, select this check box and enter the same password in [Password] and [Confirm].

6 Click [OK].

NOTE

Using the operation panel

- You can also enable or disable IEEE 802.1X authentication from <Set> in the <Home> screen. ▶ **<IEEE 802.1X Settings>(P. 368)**

Batch importing/batch exporting

- This setting can be imported/exported with models that support batch importing of this setting. ▶ **Importing/Exporting the Setting Data(P. 273)**
- This setting is included in [Settings/Registration Basic Information] when batch exporting. ▶ **Importing/Exporting All Settings(P. 275)**

Restricting the Machine's Functions

7L2J-04W

You can restrict the use of certain functions that may lead to information leaks or that are subject to misuse. It is also possible to completely disable the use of individual functions.

Restricting Printing from a Computer

You can prohibit all users from printing documents from a computer, or only allow printing if the user is authorized on the machine. You can also configure the machine so that only Encrypted Secure Print documents can be printed. **▶Restricting Printing from a Computer(P. 255)**



Restricting the Use of Memory Media

Although memory media such as USB memory devices provide convenience, they also increase the potential for security risks such as information leakage. You can set access restrictions for memory media based on your security policy. **▶Restricting the Use of Memory Media(P. 259)**



Restricting Use of the Operation Panel

You can restrict use of the functions and keys on the control panel to protect the machine settings from inadvertent changes or operations. **▶Restricting Use of the Operation Panel(P. 260)**

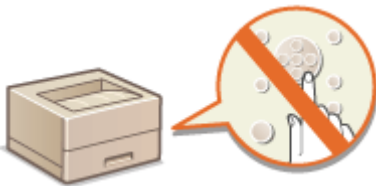

Restricting Printing from a Computer

7L2J-04X

You can restrict printing from a computer ([▶Printing From a Computer\(P. 109\)](#)) so that only specific types of documents can be printed. You can also configure the machine so that documents are not printed until the user is authorized on the machine ([▶Printing Documents Held in the Machine\(P. 116\)](#)). You can also restrict the machine to only print Encrypted Secure Print documents, which can prevent information leakage due to unattended printouts or unprotected print data. Administrator privileges are required in order to configure these settings.

- ▶[Prohibiting Printing from a Computer\(P. 255\)](#)
- ▶[Configuring the Forced Hold Printing Settings\(P. 255\)](#)
- ▶[Setting Other Limitations\(P. 257\)](#)

Prohibiting Printing from a Computer

You can prohibit users from printing documents from a computer.



<Set> ▶ <Function Settings> ▶ <Printer> ▶ <Restrict Printer Jobs> ▶ <On> ▶ Select the restriction exceptions

Configuring the Forced Hold Printing Settings



When printing documents from a computer, you can hold print data in the machine and prevent documents from being printed immediately ([▶Printing Documents Held in the Machine\(P. 116\)](#)). You can configure settings so that printing cannot be performed until the user is authorized on the machine, which ensures greater security and reduces the risk of other people viewing or inadvertently picking up sensitive documents. Administrator privileges are required in order to configure these settings.

- 1** Start the Remote UI. [▶Starting the Remote UI\(P. 262\)](#)
- 2** Click [Settings/Registration] on the portal page. [▶Remote UI Screen\(P. 263\)](#)
- 3** Click [Printer] ▶ [Print].
- 4** Select [Force Hold], set the necessary conditions, and click [OK].

- You can set detailed conditions for holding printer jobs, such as the user or IP address. If no conditions are set, all print jobs are held except for jobs from unidentified users. If no conditions are set and a print job from an unidentified user is received, it is canceled without being held.

■ Setting the conditions for holding documents

- Click [Register New].
- Set the conditions for holding documents, and click [OK].

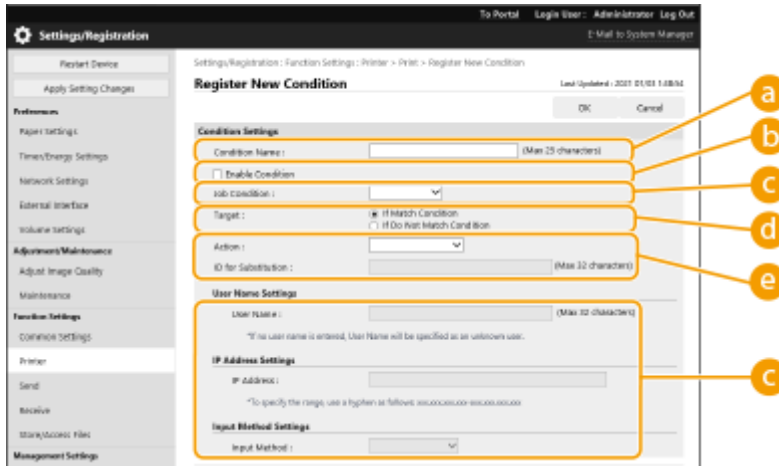

a [Condition Name]

Enter a name for the condition. Use a name that will be easy to identify when displayed in a list.

b [Enable Condition]

Select this check box to enable the condition.

c [Job Condition]

The types of conditions listed below can be selected.

[User Name]	Specify a particular user name as the condition. If this is left blank, print documents for which the user cannot be identified will be targeted.
[IP Address]	Specify a particular IP address as the condition. You can also specify a range of IP addresses.
[Input Method]	Specify a particular printing protocol as the condition.

d [Target]

You can set either a value specified by the operation target, or one not specified.

e [Action]

Select how to handle documents that match the conditions. When [Hold as Shared Job] is selected, you can set [ID for Substitution] to specify the user name output to the log when printing. Select [Cancel] to discard the document.

- Set the order in which to apply the conditions, and select [OK].

- The conditions are applied in the order that they are listed, starting at the top. To change the priority, click [Up] or [Down] in the list.
- To edit the details of a condition, click the condition name in the list.
- To disable a condition, click the condition name in the list ► deselect [Enable Condition].
- To delete a condition, select [Delete] for the condition to delete in the list ► click [OK].

NOTE

Configuring the detailed settings for forced hold printing

- You can configure detailed settings for documents that are held for printing, such as how long to save them and how to display them. ▶<Print>(P. 393)

Batch importing/batch exporting

- This setting can be imported/exported with models that support batch importing of this setting. ▶ **Importing/Exporting the Setting Data(P. 273)**
- This setting is included in [Settings/Registration Basic Information] when batch exporting. ▶ **Importing/Exporting All Settings(P. 275)**

Setting Other Limitations

- 1 Start the Remote UI.** ▶ **Starting the Remote UI(P. 262)**
- 2 Click [Settings/Registration] on the portal page.** ▶ **Remote UI Screen(P. 263)**
- 3 Click [Printer] ▶ [Print].**
- 4 Set the other limitations.**

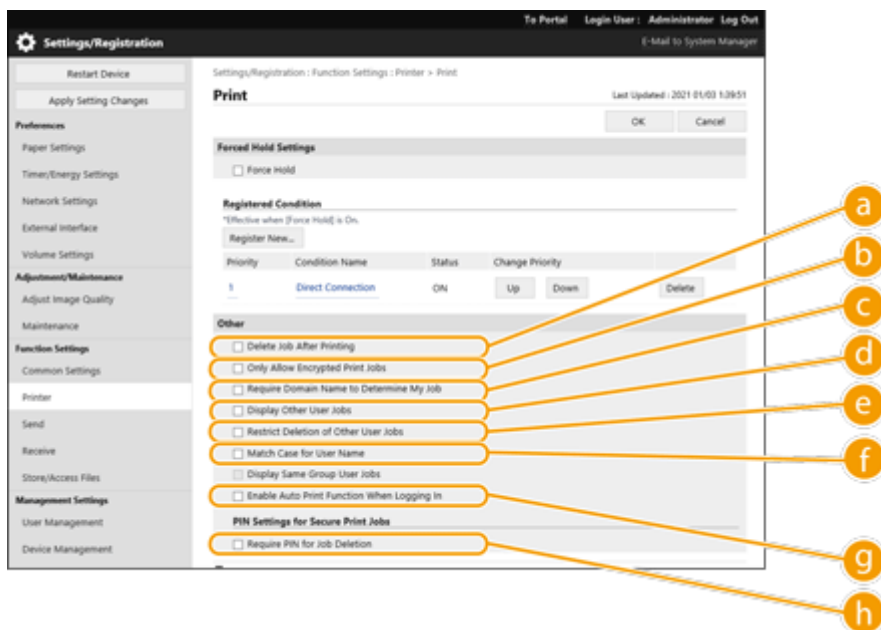

- a [Delete Job After Printing]**
Select this check box to delete jobs after they are printed.
- b [Only Allow Encrypted Print Jobs]**
Select this check box to only receive encrypted secured print jobs from computers.
- c [Require Domain Name to Determine My Job]**
Select this check box to determine the print jobs of login users as "user name + domain name."
- d [Display Other User Jobs]**
Select this check box to display the jobs of users other than the authenticated user.
- e [Restrict Deletion of Other User Jobs]**
- g [PIN Settings for Secure Print Jobs]**
- h [Require PIN for Job Deletion]**

Select this check box to allow jobs of users other than the authenticated user to be deleted when the jobs of users other than the authenticated user are displayed.

f [Match Case for User Name]

Select this check box to make user names case-sensitive.

g [Enable Auto Print Function When Logging In]

Select this check box to allow forced hold print jobs to be automatically printed when each user logs in.

h [Require PIN for Job Deletion]

Select this check box to prompt the user to enter a PIN when deleting a secure print job.

NOTE

Batch importing/batch exporting

- This setting can be imported/exported with models that support batch importing of this setting. [▶ Importing/Exporting the Setting Data\(P. 273\)](#)
- This setting is included in [Settings/Registration Basic Information] when batch exporting. [▶ Importing/Exporting All Settings\(P. 275\)](#)

Restricting the Use of Memory Media

7L2J-04Y

Although memory media such as USB memory devices provide convenience, they can also be a source of information leakage if they are not properly managed. This section describes the procedure for prohibiting the use of memory media to prevent the printing of data saved on memory media. Administrator privileges are required in order to configure these settings.



Select <Set> ▶ <Function Settings> ▶ <Access Files> ▶ <Memory Media Settings> ▶ <Use Print Function> ▶ <Off>.

LINKS

- ▶ **Using Memory Media(P. 136)**
- ▶ **Printing From Memory Media (Media Print)(P. 126)**

Restricting Use of the Operation Panel

7L2J-050

You can restrict use of the functions and keys on the control panel to protect the machine settings from inadvertent changes or operations.

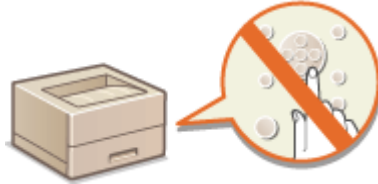

- 1** Start the Remote UI. ▶ [Starting the Remote UI\(P. 262\)](#)
- 2** Click [Settings/Registration] on the portal page. ▶ [Remote UI Screen\(P. 263\)](#)
- 3** Click [Device Management] ▶ [Key Lock/Function Lock Settings].
- 4** Select the keys and functions to lock, and click [OK].

NOTE

Batch importing/batch exporting

- This setting can be imported/exported with models that support batch importing of this setting. ▶ [Importing/Exporting the Setting Data\(P. 273\)](#)
- This setting is included in [Settings/Registration Basic Information] when batch exporting. ▶ [Importing/Exporting All Settings\(P. 275\)](#)

Managing the Machine from a Computer (Remote UI)

7L2J-051

You can remotely operate the machine from your computer's Web browser to perform operations such as checking the printing status or changing the machine settings. This convenient feature enables you to remain at your desk while operating the machine. To perform remote operation, enter the IP address of the machine in your Web browser and open the Remote UI portal page. For more information on the system requirements for the Remote UI, see [▶ System Environment\(P. 527\)](#) .

How to Use the Remote UI

This section describes the Remote UI login procedure and the features of the Remote UI main screen.

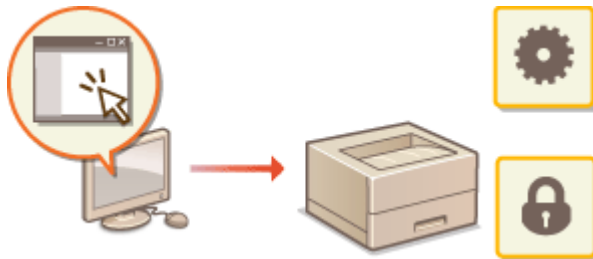

▶ Starting the Remote UI(P. 262)

Checking the Status of Waiting Documents and the Machine

This section describes how to check the status of printed documents, as well as error information and the remaining amount of paper.

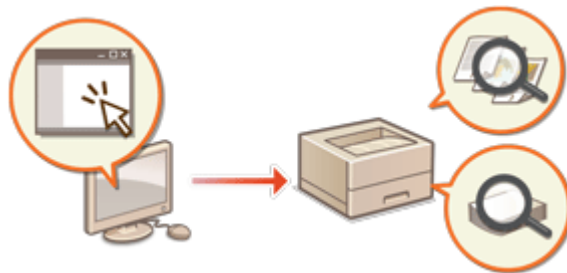

▶ Checking the Status and Logs(P. 266)

Other Functions Available Using the Remote UI

This section describes various other convenient functions that can be performed via computer using the Remote UI, such as backing up the machine settings in case they are needed.

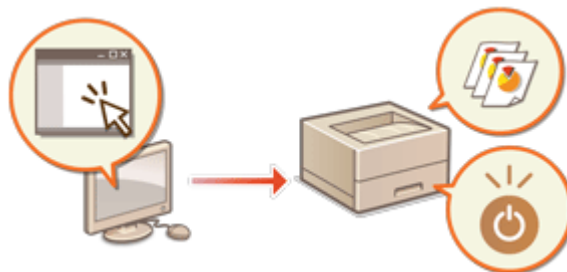

- ▶ Turning OFF/Restarting the Machine(P. 269)
- ▶ Managing the Logs(P. 270)
- ▶ Importing/Exporting the Setting Data(P. 273)
- ▶ Updating the Firmware(P. 279)
- ▶ Updating the Firmware (Distribution)(P. 281)
- ▶ Setting Scheduled Updates(P. 284)
- ▶ Displaying Messages from the Administrator(P. 286)

! IMPORTANT

When using a proxy server

- You cannot access the machine via a proxy server. If a proxy server is used in your environment, configure your Web browser to bypass the proxy server and access the machine directly.

Starting the Remote UI

7L2J-052

To start the Remote UI, enter the IP address of the machine in your Web browser. Check the IP address configured for the machine before performing this operation. [▶Setting an IP Address\(P. 22\)](#)

For security reasons, you cannot log in to the Remote UI using the default password (7654321) for the Administrator user. Log in to the Remote UI after changing the password of the Administrator user from the control panel.



<Set> ▶ <Management Settings> ▶ <User Management> ▶ <Authentication Management> ▶ <Set Administrator Password> ▶ change the password for "Administrator"

! IMPORTANT

- When both the machine and the Active Directory server are set as user authentication devices ([▶Configuring the User Login Methods and Authentication Devices\(P. 194\)](#)), the time setting of the Active Directory server needs to match that of the machine.

NOTE

Using TLS encryption for communication

- When you want to encrypt the Remote UI communication, configure the TLS key and certificate ([▶Configuring the Key and Certificate for TLS\(P. 223\)](#)), go to the <Remote UI Settings> setting ([▶<Remote UI Settings>\(P. 398\)](#)) and set <Use TLS> to <On>, then turn the machine OFF and back ON.

Logging in to the Remote UI using the default password of the Administrator user

- You can also set to allow logging in to the Remote UI using the default password of the Administrator user. [▶Setting a Password Policy\(P. 208\)](#)

[▶Starting the Remote UI\(P. 262\)](#)

[▶Setting the Timeout Time after Logging In to the Remote UI\(P. 263\)](#)

[▶Remote UI Screen\(P. 263\)](#)

Starting the Remote UI

1 Start the Web browser.

2 Enter the IP address of the machine, and press the [ENTER] key on the computer keyboard.



- Enter "http://<IP address of the machine>/" in the address input field.
- When using an IPv6 address, enclose the IP address portion in brackets ([]) (**Example:** http://[fe80:2e9e:fcff:fe4e:dbce]/).

NOTE:

If the Remote UI does not start

- If the login screen is not displayed in step 3 of this procedure, clear the Web browser's cache and enter the IP address again.

If a message related to security is displayed

- A warning message may be displayed if the Remote UI communication is encrypted. If there are no problems with the certificate or TLS settings, you can continue using the Web browser.

3 Log in to the Remote UI.

- Enter a registered user name and password in [User Name] and [Password], select the login destination in [Login Destination], and click [Log In].
- If [Log In (Guest)] is displayed, unregistered users can click this button and log in as general users.

NOTE:

- With some user authentication settings, the Remote UI may skip the login screen and display the main screen (portal page) directly. ▶ **Remote UI Screen(P. 263)**

4 Check that the Remote UI portal page is displayed. ▶ Remote UI Screen(P. 263)

! IMPORTANT

- When using the Remote UI to operate the machine, do not use the Web browser's [Back] button. The page may not change properly if you use the [Back] button.

Setting the Timeout Time after Logging In to the Remote UI

The user is automatically logged out if no operations are performed for a certain period of time after logging in to the Remote UI. You can set the time until the user is logged out.



Start the Remote UI ▶ [Settings/Registration] ▶ [Network Settings] ▶ [Session Settings] ▶ [Timeout After Logging in to Remote UI] ▶ set the timeout time after login ▶ [OK]

Remote UI Screen

The portal page shown below is displayed when you log in to the Remote UI. This section describes the items displayed on the portal page and the basic operations.

! IMPORTANT

- Some display items and functions are only available if you log in with Administrator privileges.

- If multiple users are operating the Remote UI at the same time or the control panel of the machine is being operated at the same time as the Remote UI, the last operation that is performed is effective.

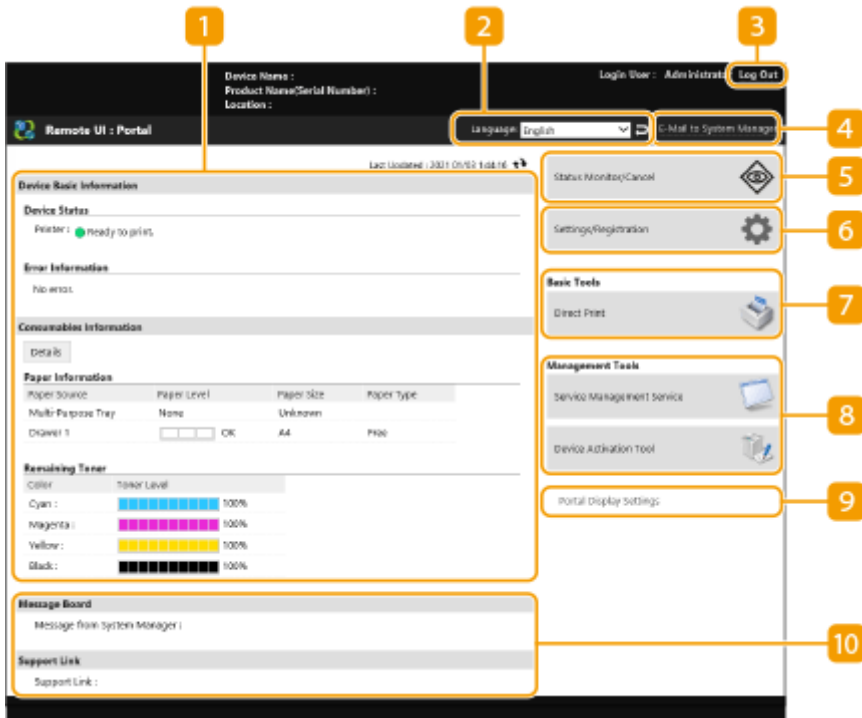

1 Device information

The current machine status is displayed, along with information about errors, consumables, etc.

2 Display language

You can switch the language that is displayed on the Remote UI screen.

3 [Log Out]

Log out from the Remote UI and return to the login page.

4 [E-Mail to System Manager]

Create an e-mail message to send to the administrator. The administrator's e-mail address can be set in [Settings/Registration] ▶ [User Management] ▶ [System Manager/Contact Person Information Settings].

5 [Status Monitor/Cancel]

You can check the status of jobs or cancel processing. You can also check detailed information about the amount of remaining toner and paper, etc. ▶ **Checking the Status and Logs(P. 266)**

6 [Settings/Registration]

You can change the machine settings. You can save the setting details to a computer, or import them from a computer to the machine. ▶ **Importing/Exporting the Setting Data(P. 273)**

NOTE:

- You can use either the control panel or the Remote UI to change most machine settings, but some settings can only be changed using one or the other.

7 [Basic Tools]

You can print documents.

▶ **Directly Printing Files without Opening Them(P. 122)**

8 [Management Tools]

You can manage applications.

9 [Portal Display Settings]

You can change the order in which the [Basic Tools] and [Management Tools] buttons are displayed on the portal page.

10 Messages/support

Messages from the administrator are displayed, along with links to machine support information. ▶
Displaying Messages from the Administrator(P. 286)

NOTE

- To update the current page with the latest information, click  .

LINKS

▶ **Settings/Registration(P. 295)**

Checking the Status and Logs

7L2J-053

You can use the Remote UI to check the status of documents that are waiting to be processed, as well as the logs for documents that have been processed. You can also check the status of the machine, such as error information and the remaining amount of consumables.

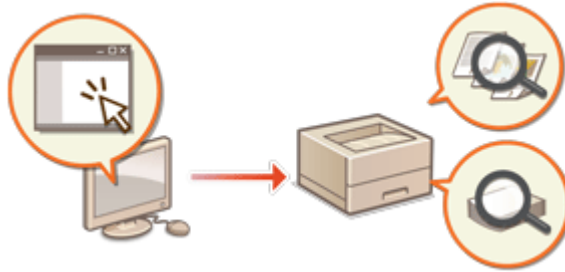

- ▶ **Checking the Status of Prints(P. 266)**
- ▶ **Checking the Job Log(P. 267)**
- ▶ **Checking the Machine Status(P. 267)**

NOTE

- When personal authentication management is used, you can restrict users from performing operations on the jobs of other users on the <Status Monitor> screen. ▶ **<Restrict Access to Other User Jobs>(P. 396)**

Checking the Status of Prints

You can check the status of documents that are waiting to be printed. You can also output a document before the others, or cancel a document.



Start the Remote UI ▶ [Status Monitor/Cancel] ▶ [Job Status] under [Print]

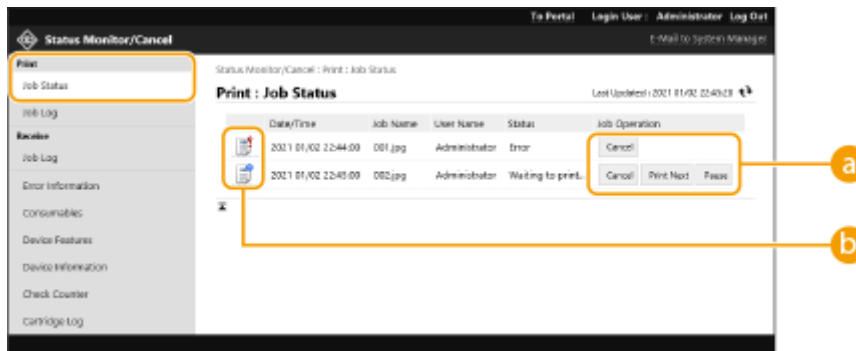

a Operation buttons

- [Cancel]: Printing is canceled. The canceled document is deleted and cannot be recovered.
- [Print Next]: The document is output immediately after the current document is complete.
- [Pause]: You can cancel printing. Click [Resume] to resume printing a document that was paused.

b Document icon

Click the icon to display detailed information about the document.

Checking the Job Log

You can display a log for documents that were printed or received.



Start the Remote UI ▶ [Status Monitor/Cancel] ▶ [Job Log]

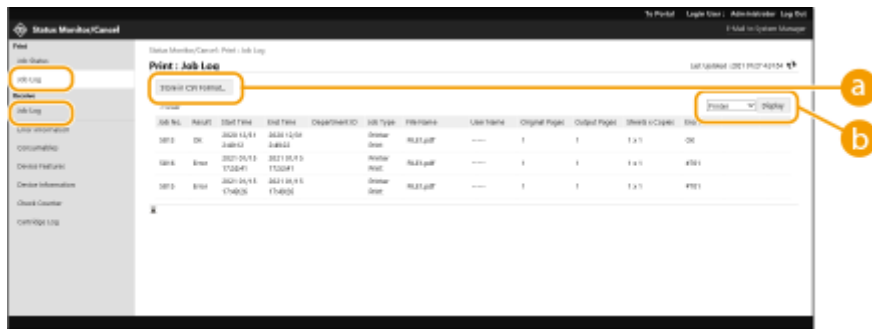

a [Store in CSV Format]

The log data can be exported and saved as a CSV file (*.csv) on the computer.

b Function selection

Select the function that you want to check, and click [Display]. The displayed functions may vary depending on your machine model and optional equipment.

Checking the Machine Status

You can check a variety of information about the machine, such as error information, the amount of remaining paper and toner, information about attached optional equipment, and the total number of pages that have been printed up to now.



Start the Remote UI ▶ [Status Monitor/Cancel] ▶ Select the item that you want to check

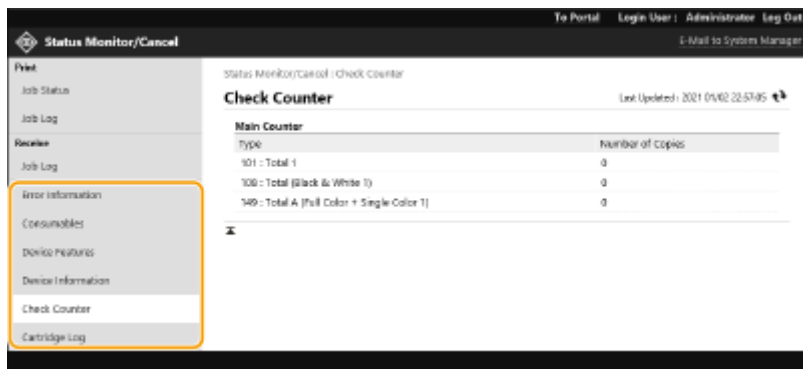

LINKS

▶ **Starting the Remote UI(P. 262)**

Turning OFF/Restarting the Machine

7L2J-054

You can use the Remote UI to shut down or restart the machine.

IMPORTANT

- When the machine is turned OFF or restarted, any documents that are being printed are canceled.

 [Turning OFF the Machine\(P. 269\)](#)

 [Restarting the Machine\(P. 269\)](#)

Turning OFF the Machine



Start the Remote UI ▶ [Settings/Registration] ▶ [Device Management] ▶ [Remote Shutdown] ▶ [Start]

Restarting the Machine



Start the Remote UI ▶ [Settings/Registration] ▶ [Restart Device] ▶ [Perform Restart] ▶ [OK]

LINKS

 [Starting the Remote UI\(P. 262\)](#)

 [Turning ON the Machine\(P. 61\)](#)

 [Turning OFF the Machine\(P. 62\)](#)

Managing the Logs

7L2J-055

You can use the logs to check or analyze how the machine is being used. A variety of information about each operation is recorded in the logs, such as the operation date/time, user name, operation type, function type, and operation result. For more information on the types of logs, see [Management Functions\(P. 523\)](#) . Administrator privileges are required in order to manage the logs.



- ▶ [Starting Log Recording\(P. 270\)](#)
- ▶ [Exporting a Log as a File\(P. 271\)](#)
- ▶ [Deleting the Logs\(P. 271\)](#)
- ▶ [Sending Logs via the Syslog Protocol\(P. 271\)](#)

! IMPORTANT

- If Audit Log Collection is enabled and an error occurs in the memory area managed by this function, initialization is automatically performed and then an error screen appears.
- If you can obtain the audit log from before the error occurred, click [Download Audit Log] to obtain the log, and then click [OK].
- If you cannot obtain the audit log from before the error occurred, click [OK].
- When initialization is completed, Audit Log Collection is resumed, and the automatic initialization process is recorded in the log.

Starting Log Recording

Follow the procedure below to start recording logs.



Start the Remote UI ▶ [Settings/Registration] ▶ [Device Management] ▶ [Export/Clear Audit Log] ▶ [Audit Log Information] ▶ Click [Start] for [Audit Log Collection:]

NOTE

- If Sleep Mode Energy Use is set to [High], logs are not collected when the machine enters the Sleep mode.
- When generating a network connection log or machine management log, click [Device Management] ▶ [Save Audit Log] ▶ select the check box for [Save Audit Log] ▶ click [OK] ▶ [Apply Setting Changes].
- If the power of the machine is turned OFF while collecting logs due to a power outage, etc., collection starts again when the machine restarts, from the log that was being collected before the power turned OFF.

- If you stop log collection while logs are being collected, the logs for the period that log collection was stopped are not collected when log collection is next started.

Exporting a Log as a File

The various logs can be exported and saved to a computer as CSV files, which can be opened using a CSV file editor or a text editor.

IMPORTANT

- When exporting logs as files, use TLS or IPsec.  **Configuring the IPsec Settings(P. 244)**



Start the Remote UI ▶ [Settings/Registration] ▶ [Device Management] ▶ [Export/Clear Audit Log] ▶ [Export Audit Logs] ▶ [Export] ▶ Follow the on-screen instructions to save the file

- If you want to automatically delete all logs after they are exported, select the check box for [Delete logs from device after export] before clicking [Export]. If you then click [Cancel], exporting is canceled and the logs are deleted, even if they were not finished being exported as files.
- Log collection is stopped while the export process is being performed.

Deleting the Logs



You can delete all of the collected logs.



Start the Remote UI ▶ [Settings/Registration] ▶ [Device Management] ▶ [Export/Clear Audit Log] ▶ [Delete Audit Logs] ▶ [Delete] ▶ [Yes]

Sending Logs via the Syslog Protocol

Syslog Information can be sent to an SIEM (security information/event management) system. Linking with an SIEM system enables various information analyzed from realtime alert information to be centrally managed.

- 1 Start the Remote UI.**  **Starting the Remote UI(P. 262)**
- 2 Click [Settings/Registration] on the portal page.**  **Remote UI Screen(P. 263)**
- 3 Click [Device Management] ▶ [Export/Clear Audit Log] ▶ [Syslog Settings].**
- 4 Select [Use Syslog Send], and specify the required settings.**

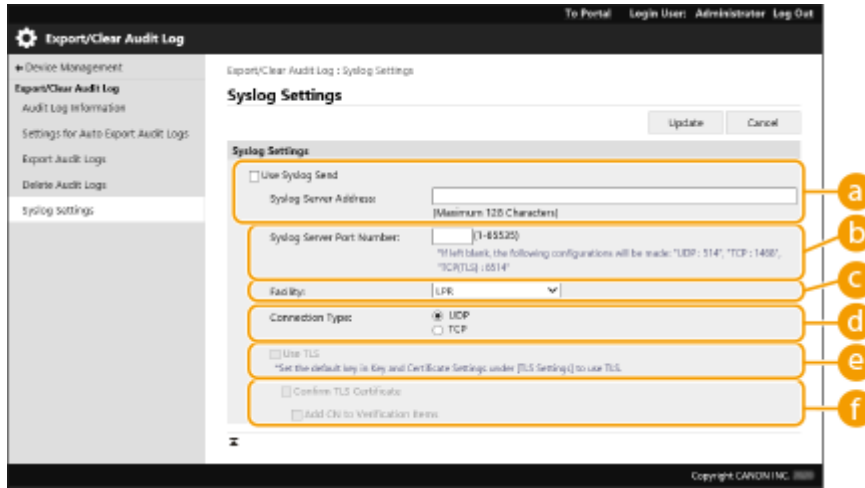

a [Syslog Server Address:]

Specify the address of the Syslog server to connect to. Enter the necessary information, such as IP address and host name, according to your environment.

b [Syslog Server Port Number:]

Enter the port number used by the Syslog server for Syslog communication. If left blank, the port number defined in RFC (UDP: 514, TCP: 1468, TCP (TLS): 6514) is used.

c [Facility:]

Specify the type of log messages to send. Select one of the following: [Local0] to [Local7], [Log Alert], [Log Audit], [Security Messages], or [LPR] defined in RFC.

d [Connection Type:]

Specify the communication type ([UDP]/[TCP]).

e [Use TLS]

Select this to use TLS to encrypt information communicated with the Syslog server.

NOTE:

- When [TCP] is selected in [Connection Type:], you can set to use TLS.

f [Confirm TLS Certificate]/[Add CN to Verification Items]

Set whether to verify the TLS server certificate sent when connecting and its CN (Common Name).

5 Click [Update].

NOTE

- A slight time lag occurs after the error for some audit logs, because Syslog transmission is performed after polling every 30 seconds.
- The supported RFCs are 5424 (Syslog format), 5425 (TLS), and 5426 (UDP).

LINKS

- ▶ **Starting the Remote UI(P. 262)**
- ▶ **Configuring the Key and Certificate for TLS(P. 223)**

Importing/Exporting the Setting Data

7L2J-056

Machine data such as user setting information and various setting values can be exported and saved to a computer. Exported data can also be imported into the machine from a computer. Data exported from the machine can be imported into other Canon printers/multifunction printers, making it easier to configure the settings on a new machine, such as when you purchase a replacement. For more information on the setting items that can be imported, see **Settings/Registration Table(P. 296)** . When importing or exporting, you can specify whether to import or export all of the machine data, or only particular data.



Importing/Exporting All Settings(P. 275)

! IMPORTANT

Designate an administrator to manage operations

- Designate an administrator with Administrator privileges to perform data import/export operations. When data is imported, user settings, network settings, and other data are overwritten, which may prevent some functions from working properly or cause problems with machine operation. Exercise caution when importing data.

Do not turn OFF the machine until importing or exporting is complete

- It may take several minutes for the process to complete. Do not turn OFF the machine before the process is complete. Doing so may result in data loss or cause the machine to malfunction.
- The following functions/processes cannot be carried out while importing/exporting data:
 - Report print jobs
 - Batch Importing/Batch Exporting
 - Update process for the Register/Update Software function
 - Operating from the control panel of the machine
 - Operating from the Remote UI
 - Putting the machine to the sleep mode
- Importing/exporting data cannot be performed while the following functions/processes are being carried out:
 - Report print jobs
 - Batch Importing/Batch Exporting
 - Update process for the Register/Update Software function
 - Processing the shutdown of the machine
 - Displaying error code

Do not import or export in different display languages

- If the display language differs between the exporting machine and the importing machine, the setting values may corrupt, causing malfunction of the machine.

Do not edit exported files.

- Do not open and edit exported XML files, as this may cause the machine to malfunction.

NOTE

When importing to a Canon printer/multifunction printers other than this machine

- Some settings may not be imported.  **Settings/Registration Table(P. 296)**

When using a password to protect the security policy settings

- The security policy settings can only be imported if the security policy setting password on the exporting machine matches that of the importing machine, or if no password has been set for the importing machine. If no password has been set for the importing machine, the password configured for the exporting machine is set to the importing machine.

Importing/Exporting All Settings

7L2J-057

You can export all of the setting data from the machine and save it to a computer, and then import it when configuring the settings on a new machine, such as when you purchase a replacement. If you want to configure the same settings on two or more Canon printers/multifunction printers*, you can simply export all settings from one machine and import them all to the others, eliminating the need to configure each machine separately. To perform these operations, log in to the Remote UI with Administrator privileges.

* Only models that support the import/export of all settings

▶ **Exporting All Settings(P. 275)**

▶ **Importing All Settings(P. 276)**

Exporting All Settings

- 1 Start the Remote UI. ▶ Starting the Remote UI(P. 262)**
- 2 Click [Settings/Registration] on the portal page. ▶ Remote UI Screen(P. 263)**
- 3 Click [Data Management] ▶ [Export].**
- 4 Select the check box for [Select All].**

NOTE:

- Specific items can also be exported. For information on which Settings/Registration items correspond with which items of the batch export function of the Remote UI, see ▶ **Settings/Registration Table(P. 296)** .

- 5 Enter the password in [Encryption Password] ▶ select the security level from [Security Level] ▶ click [Start Exporting] ▶ [OK].**

- The password in [Encryption Password] will be required when importing the exported setting data. Use alphanumeric characters.
- For confirmation, enter the password again in [Confirm].
- To encrypt all the settings data, select [Level 2] in [Security Level].

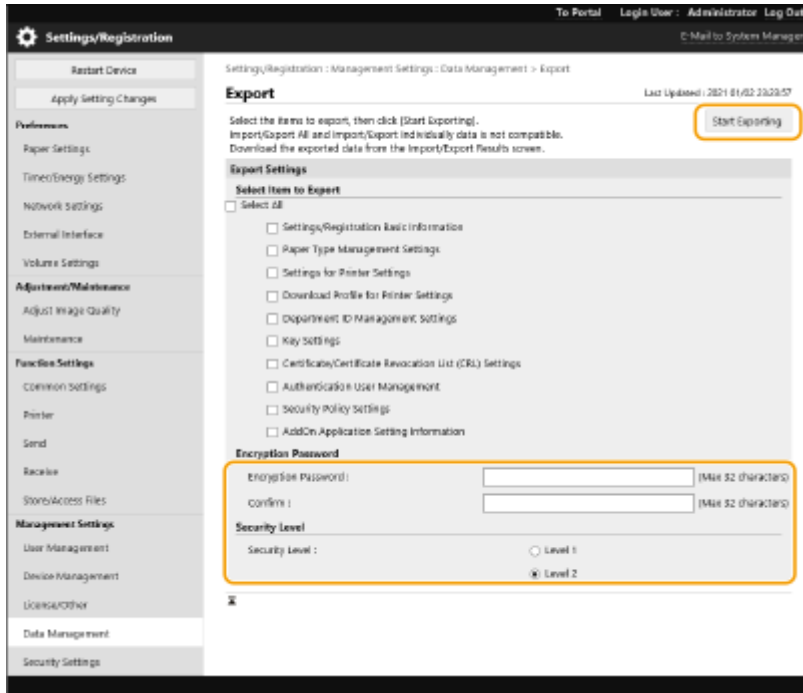

! IMPORTANT:

- It may take some time for the screen to change. Do not click [Start Exporting] more than once.
- When importing settings data to another model that does not support the setting in [Security Level], select [Level 1].

6 Click [Check Status].

- If the [Cannot be used when exporting.] message is displayed, do not use the Remote UI to perform the operations.

7 Click [Start Downloading].

8 Follow the on-screen instructions to specify where to save the data.

NOTE

To export all setting data without using a computer

- You can export all setting data to memory media such as a USB memory device. ▶<Export to USB Memory>(P. 400)

Importing All Settings

You can import all setting data that was exported to a computer. When importing, the previously configured setting values are overwritten. Note, however, that some machine models may not be able to import all setting items. ▶ Settings/Registration Table(P. 296)

! IMPORTANT

Check the System Manager information

- When importing the Department ID Management settings to a different printer/multifunctional printer with Department ID Management enabled, the System Manager information is overwritten, which may prevent you from logging in with the previous System Manager ID and PIN. Before performing this operation, make sure to check the System Manager information that is saved on the exporting machine.

NOTE

When applying security policy settings

- The security policy settings can only be imported if the security policy setting password of the exporting machine matches that of the importing machine, or if no password has been set for the importing machine. If no password has been set for the importing machine, the password configured for the exporting machine is automatically set to the importing machine.

1 Start the Remote UI. ▶Starting the Remote UI(P. 262)

2 Click [Settings/Registration] on the portal page. ▶Remote UI Screen(P. 263)

3 Click [Data Management] ▶ [Import].

4 Click [Browse...], and specify the file to import.

5 Enter the password in [Decryption Password], and click [Start Importing] ▶ [OK].

- In [Decryption Password], enter the same password that was entered when the setting data was exported.
- Select the check box for [Create Import/Export Result Report] if you want to output the import results as a CSV file.

▢▢▢▢ The data of the selected file is imported into the machine.

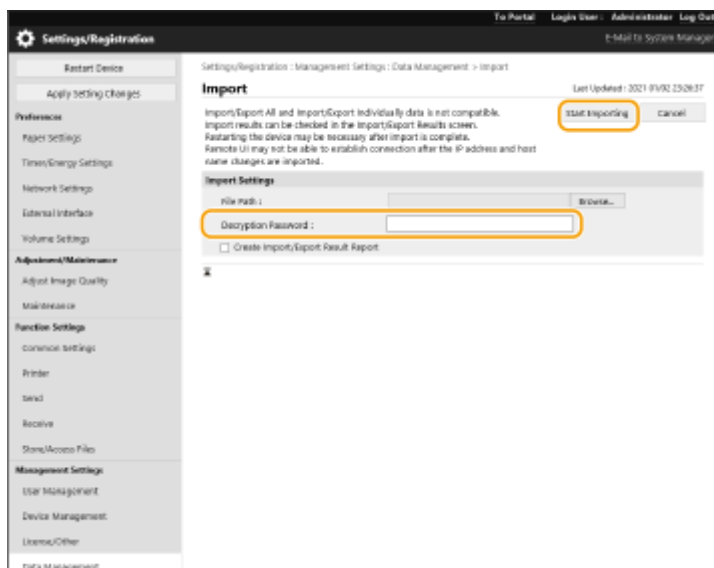

6 Click [OK] ▶ [Check Status].

- The machine may need to be restarted, depending on the imported data. Click [Perform Restart].
- If you select the check box for [Create Import/Export Result Report] in the previous step, click [Settings/Registration] ▶ [Data Management] ▶ [Import/Export Results] ▶ [Create Report] to export the import results.

NOTE

To import all setting data without using a computer

- You can import all setting data from memory media such as a USB memory device. ▶<Import from USB Memory>(P. 400)
- Only one report file is saved. The next time a batch import is executed, the existing report file is deleted.
- Reports are created in the following language.
 - If the display language of the machine is set to Japanese immediately after the import process: Japanese
 - If the display language of the machine is set to something other than Japanese immediately after the import process: English

Updating the Firmware



New firmware is periodically released to add new functions or resolve issues with existing functions. If new firmware is available, follow the procedure below to update it on the machine. Administrator privileges are required in order to update the firmware.

▶ **Checking the Firmware Version(P. 279)**

▶ **Updating the Firmware(P. 280)**

! IMPORTANT

- Do not perform the following operations while updating the firmware. Doing so may cause a critical error.
 - Turn OFF the main power
 - Remove the LAN cable
 - Perform communication (such as printing) with the machine from another computer or application*1
 - Configure the sleep settings of your computer*2

*1 When updating the firmware in a network environment, ensure that other users do not perform operations such as printing.

*2 The firmware may not be updated correctly if the computer enters the sleep mode.

NOTE

Preparing to update the firmware

- Download the latest firmware from the Canon website (<https://global.canon/>).
- Back up the machine data and settings in case the firmware update is not performed properly.

▶ **Importing/Exporting the Setting Data(P. 273)**

Note regarding the update process

- The machine restarts several times.
- The update process is interrupted if jobs remain.
- The screen switches several times during the update process. It may take some time for the screen to switch, but do not close the browser until the update process is complete.

Checking the Firmware Version

Check the firmware version of the machine before updating the firmware and after updating the firmware.

1 Start the Remote UI. ▶Starting the Remote UI(P. 262)

2 Click [Status Monitor/Cancel] on the portal page. ▶ Remote UI Screen(P. 263)

3 Click [Device Information] ▶ [Version Information] ▶ check [Controller].

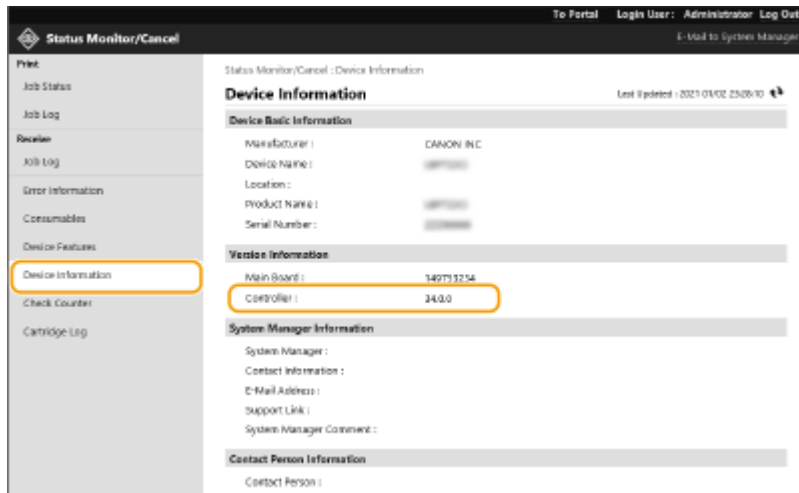

Updating the Firmware

1 Start the Remote UI. ▶ Starting the Remote UI(P. 262)

2 Click [Settings/Registration] on the portal page. ▶ Remote UI Screen(P. 263)

3 Click [License/Other] ▶ [Register/Update Software].

4 Click [Manual Update].

5 Click [Browse...], select the firmware update to use, and click [Update].

⇒ When the <The process has stopped because there are one or more unfinished jobs. Restart the device manually in order to start the process. The browser may be closed.> message appears, turn the machine OFF and back ON. ▶ Turning OFF/Restarting the Machine(P. 269)

TIPS

Updating the Firmware from the Home Screen

- Firmware updates can also be performed from <Update Firmware> on the <Home> screen, depending on the region. Administrator privileges are required for this operation.

Updating the Firmware (Distribution)



If the machine has access to the Internet, you can download the latest firmware for the machine from Canon's distribution server. This might be more flexible and convenient than the other update method ([▶Updating the Firmware\(P. 279\)](#)) because both manual and automatic update options are available, enabling you to download the firmware at a specified time or as soon as the latest version is available. Administrator privileges are required in order to perform these operations.

NOTE

- This feature may not be available depending on your country or region.

Preparing to update the firmware

- Back up the machine data and settings in case the firmware update is not performed properly.
 - ▶[Importing/Exporting the Setting Data\(P. 273\)](#)

1 Start the Remote UI. [▶Starting the Remote UI\(P. 262\)](#)

2 Click [Settings/Registration] on the portal page. [▶Remote UI Screen\(P. 263\)](#)

3 Click [License/Other] ▶ [Register/Update Software].

4 Perform a communication test.

- Test whether you can access the distribution server over the network.

1 Click [Display Logs/Communication Test].

2 Click [Communication Test] ▶ [Yes].

▮▮▮▮ The results of the communication test are displayed.

- If [Could not connect to the distribution server. Check the distribution server and network.] is displayed, check that the LAN cable is connected and the network settings are configured properly. [▶Setting up Using the Setup Guide\(P. 6\)](#)

5 Click [Distributed Update] ▶ [Confirm New Firmware].

6 Configure the necessary settings.

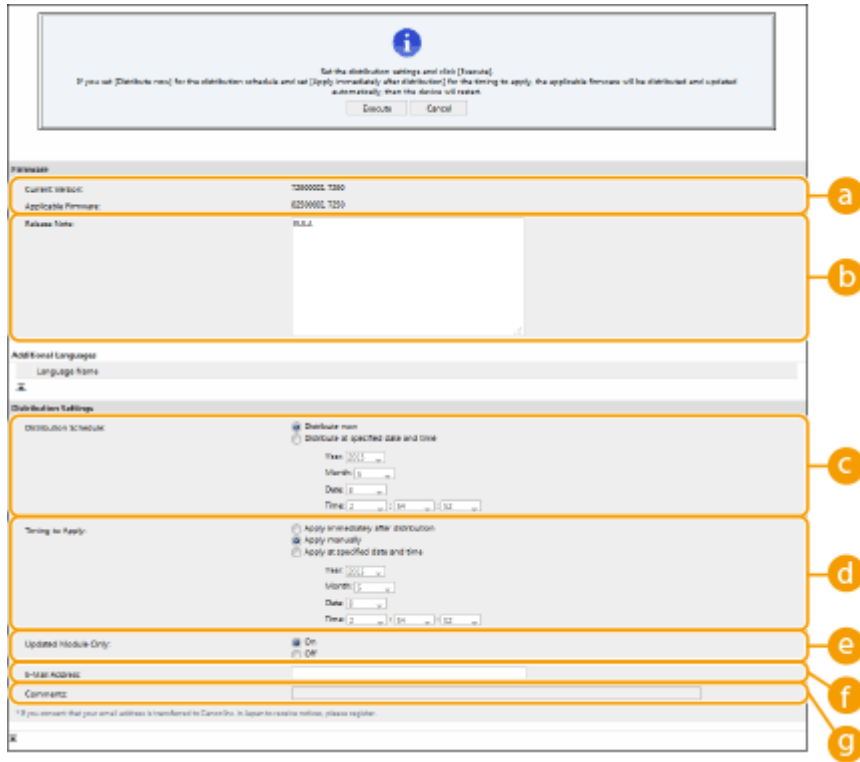

a [Current Version]/[Applicable Firmware]

You can check the current firmware version and new one respectively.

b [Release Note]

Important information is displayed. Make sure to read and understand the contents.

c [Distribution Schedule]

To download the firmware immediately, select [Distribute now]. To automatically download the firmware at a specified date and time, select [Distribute at specified date and time] and specify the date and time in [Year:]/[Month:]/[Day:]/[Time:]. You can schedule a time within a week in advance.

d [Timing to Apply]

To automatically apply the firmware immediately after downloading is complete, select [Apply immediately after distribution]. To automatically apply the firmware at a specified date and time, select [Apply at specified date and time] and specify the date and time in [Year:]/[Month:]/[Day:]/[Time:]. You can also select [Apply manually] to manually apply the firmware.

e [Updated Module Only]

Select [On] to perform an incremental update (download only the difference between the current and new firmware versions). If you want to download the entire firmware, select [Off]. Note that some firmware versions do not support incremental update.

f [E-Mail Address]

Enter your e-mail address. The distribution server sends the update status to the e-mail address entered here.

g [Comments]

Enter a description or note to add to the e-mail. If you are managing multiple printers/multifunction printers, entering a device name makes it easier to identify the status of each device.

7 Click [Execute] ▶ [OK].

- If the license agreement screen is displayed, check the information and click [I Accept].
- If [Apply immediately after distribution] or [Apply at specified date and time] is selected in the previous step, the machine automatically restarts immediately after the firmware is applied. If [Apply manually] is selected, you need to apply the downloaded firmware manually. ▶ **Applying the Downloaded Firmware(P. 283)**

IMPORTANT

- Changing the distributed update settings again may delete the downloaded firmware or cancel the scheduled settings.

NOTE

Canceling the distribution schedule

- On the screen displayed in step 5, click [Delete Scheduled Distribution] ▶ [Yes].

TIPS

Automatically check for new firmware (scheduled update)

- If you click [Scheduled Update Settings] ▶ [Edit...] in step 5, you can set the machine to periodically access the distribution server for new firmware. If new firmware is available, it is downloaded to update the firmware on the machine. ▶ [Setting Scheduled Updates\(P. 284\)](#)

■ Applying the Downloaded Firmware

- 1 Start the Remote UI.** ▶ [Starting the Remote UI\(P. 262\)](#)
- 2 Click [Settings/Registration] on the portal page.** ▶ [Remote UI Screen\(P. 263\)](#)
- 3 Click [License/Other] ▶ [Register/Update Software].**
- 4 Click [Distributed Update] ▶ [Apply Firmware] ▶ [OK].**

- The machine automatically restarts immediately after the firmware is applied.

NOTE:

To delete the firmware

- Click [Delete Firmware] ▶ [OK].

Setting Scheduled Updates

7L2J-05A



You can set the machine to regularly check for new applicable firmware and automatically update the firmware of the machine.

NOTE

- This operation can only be performed by a user with the required privileges.
- If the downloading of the firmware is not complete, or the downloaded firmware has not been applied, you cannot perform a scheduled update.

- 1 Start the Remote UI.** ▶ **Starting the Remote UI(P. 262)**
- 2 Click [Settings/Registration] on the portal page.** ▶ **Remote UI Screen(P. 263)**
- 3 Click [License/Other] ▶ [Register/Update Software].**
- 4 Click [Scheduled Update Settings] ▶ [Edit...].**
- 5 Select the check box for [Enable scheduled update settings], and configure the necessary settings.**

a [Update Schedule]

[Confirm]

Select the cycle ([Biweekly] or [Weekly], a day ([Sun] to [Sat]), and the time). The time is displayed in 24-hour notation. The firmware check may take up to 3 hours to complete from the specified time.

[Apply at]

Select the time to apply downloaded firmware.

b [E-Mail]

Enter the e-mail address of the administrator. You can receive e-mails regarding the update status that is sent from the distribution server.

[Comments]

Enter the comment that will automatically be added to the e-mail. If the model name is entered, you can identify which device status the e-mail is about.

NOTE

- If previously downloaded firmware has not been applied by scheduled update, the next scheduled update is not performed.
- If Scheduled Update is set, a firmware update is applied at the specified time after the new firmware is downloaded from the distribution server. After application is complete, the machine automatically restarts.

6 Click [Set].

Displaying Messages from the Administrator

7L2J-05C



You can display messages to users on the portal page of the Remote UI. Administrator privileges are required in order to configure these settings.

- 1 Start the Remote UI. ▶ Starting the Remote UI(P. 262)
- 2 Click [Settings/Registration] on the portal page. ▶ Remote UI Screen(P. 263)
- 3 Click [License/Other] ▶ [Message Board/Support Link].
- 4 Enter the message, and click [OK].

The screenshot shows the 'Message Board/Support Link' configuration page. The left sidebar contains a navigation menu with categories like 'Remote Device', 'Preference', 'Adjustment/Maintenance', 'Function Settings', and 'Management Settings'. The main content area is titled 'Message Board/Support Link' and includes a 'Message Board' section with a text input field (callout 'a'), a 'Remote UI' section with a 'Display on Portal' checkbox (callout 'b'), and a 'Support Link' section with a 'URL' input field (callout 'c'). The page also shows 'OK' and 'Cancel' buttons and a 'Last Updated' timestamp.

a [Message]

Enter the content of the message. Use this setting for displaying operational tips and other low-priority messages.

b [Remote UI]

Select this check box to display the message on the portal page of the Remote UI.

c [Support Link]

Enter the link to support information for the machine to display on the portal page of the Remote UI.

Installing System Options

7L2J-05E

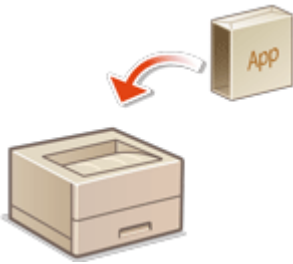

When using system options, you may need to log in with Administrator privileges to register licenses. To register a license, you will need the number that is printed on the license access number certificate. Make sure you have it with you before you start. You can perform license registration even if the machine is not connected to the network.

1 Perform a communication test.

- Test whether you can register the license over the network.

1 Start the Remote UI. [▶Starting the Remote UI\(P. 262\)](#)

2 Click [Settings/Registration] on the portal page. [▶Remote UI Screen\(P. 263\)](#)

3 Click [License/Other] ▶ [Register/Update Software] ▶ [Display Logs/Communication Test].

4 Click [Communication Test].

⇒ The [Are you sure you want to execute the communication test?] message is displayed.

5 Click [Yes].

⇒ The results of the communication test are displayed.

- If [Connect Failed] is displayed, check that the LAN cable is connected and the network settings are configured properly. [▶Setting up Using the Setup Guide\(P. 6\)](#)
- If you cannot connect to the network, register the license offline. [▶When Registration Cannot Be Performed over the Network\(P. 288\)](#)

2 Click [Distributed Installation].

3 Enter the license access number.

4 Confirm the number, and click [Next >].

5 Select the function to install, and click [Start].

- If the license agreement screen is displayed, check the information and click [I Accept].

6 Click [To Distributed Installation].

■ When Registration Cannot Be Performed over the Network

If for some reason the machine is unable to connect to the network, register the license offline. First obtain a license key using a computer connected to the network, then register it by entering it into the machine. To obtain a license key, you will need the number that is printed on the license access number certificate, along with the serial number of the machine.

- 1 Access the license issuing website (<http://www.canon.com/lms/license/>) and obtain the license key.**
 - Follow the on-screen instructions and enter the license access number and serial number to obtain the license key.
- 2 Select <Set> on the <Home> screen.**
- 3 Select <Management Settings> ▶ <License/Other> ▶ <Register License>.**
- 4 Enter the license key.**
- 5 Select <Start>.**

NOTE

Confirming the serial number

- It is displayed in <Check Counter> ▶ <Check Device Configuration>. It can also be confirmed from the Remote UI portal page.

Initializing Settings

7L2J-05F



You can initialize the settings to the factory default values. Administrator privileges are required in order to perform initialization.

- ▶ **Initializing the Network Settings(P. 289)**
- ▶ **Initializing the Panel Settings(P. 289)**
- ▶ **Initializing All Data/Settings(P. 290)**

! IMPORTANT

- Before initializing, make sure that there are no documents being processed or waiting to be processed. These documents will be deleted when initialization is performed.
- Do not turn OFF the machine during initialization. Doing so may lead to defects in the memory of the machine.
- Initialization may take 30 minutes or more to complete. The machine cannot be used during the initialization process.

NOTE

Before performing initialization

Back up your important data or export it as a file.

- Machine setting information ▶ **Importing/Exporting the Setting Data(P. 273)**
- User authentication information registered in the local device for personal authentication management ▶ **Registering User Information in the Local Device(P. 177)**

When using a password to protect the security policy settings

- Password entry is required to execute <Initialize All Set. without Network Set.> or <Initialize All Data/Settings>. ▶ **Using a Password to Protect the Security Policy Settings(P. 163)**

Initializing the Network Settings

You can initialize the network settings to the factory default values.



<Set> ▶ <Management Settings> ▶ <Data Management> ▶ <Initialize Network Settings> ▶ <Yes>

Initializing the Panel Settings

You can initialize the various settings to the factory default values.



<Set> ▶ <Management Settings> ▶ <Data Management> ▶ <Initialize All Set. without Network Set.> ▶ <Yes>

NOTE

- The network settings are not initialized.

Initializing All Data/Settings

You can restore all of the machine settings to the factory default values.



<Set> ▶ <Management Settings> ▶ <Data Management> ▶ <Initialize All Data/Settings> ▶ <Yes>.

NOTE

- Although the job log information can be deleted by initializing all data/settings, the result of printing the Initialize All Data/Settings Report is recorded in the print log. ▶ **Checking the Printing Status and History(P. 114)**

TIPS

- It is also possible to individually select some machine settings and restore their factory default values. ▶ **Settings/Registration(P. 295)**

Functions Linked to Cloud Service

7L2J-05H

You can check the usage status of the device and the user by linking to cloud service, depending on the model of the machine you are using.

uniFLOW Online Express(P. 291)

uniFLOW Online Express

By creating "tenants" in the cloud, and registering the user information and devices, you can use the following functions without building a server.

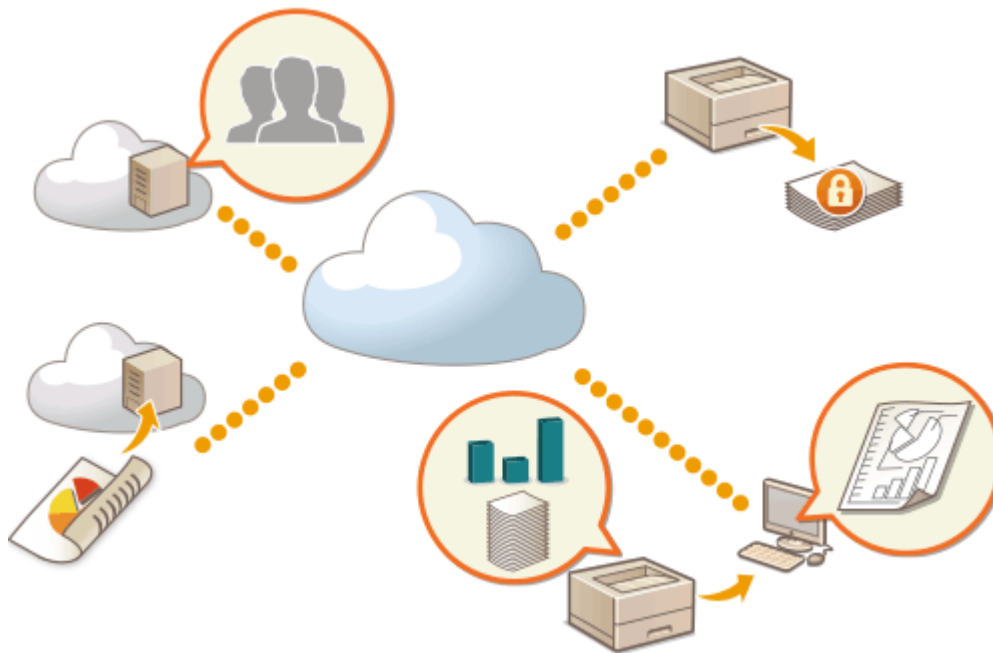

NOTE

- For instructions on creating and accessing a tenant, contact your dealer or service representative.
- For details on uniFLOW Online Express, see " **First Steps Guide** ".

■ "Accounting and Reporting Function" That Enables Checking Logs and Costs

This function calculates the usage of devices registered/connected to the same tenant on uniFLOW Online Express, and then creates a report. You can also check the usage log of each user, and create cost tables for each printed page so that you can calculate/check the cost for each device.

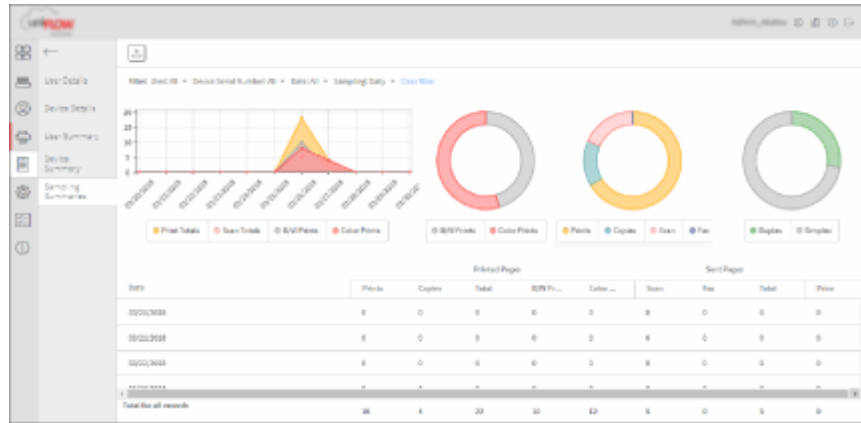

Main Specifications

Accounting and Reporting Function

Report type	
	<ul style="list-style-type: none"> • Usage log of each user • Usage log of each device • Print logs of all users • Print logs of all devices (all periods) • Print logs of all devices (specified period)

Settings/Registration

Settings/Registration	295
Settings/Registration Table	296
Preferences	298
Display Settings	299
Timer/Energy Settings	300
Network	302
External Interface	321
Accessibility	322
Volume Settings	323
Adjustment/Maintenance	324
Maintenance	325
Adjust Image Quality	326
Function Settings	328
Common	329
Printer	331
Custom Settings	332
UFR II	335
PCL	336
PS	338
Imaging	339
PDF	340
XPS	342
Utility	343
Send	344
Receive	345
Access Files	346
Print	347
Management Settings	348
User Management	349
Device Management	350
License/Other	351
Data Management	352
Security Settings	353
Output Report	354
<Preferences>	355
<Display Settings>	356
<Timer/Energy Settings>	358

<Network>	362
<External Interface>	374
<Accessibility>	376
<Volume Settings>	377
<Adjustment/Maintenance>	378
<Maintenance>	379
<Adjust Image Quality>	380
<Function Settings>	384
<Common>	385
<Printer>	388
<Send>	390
<Receive>	391
<Access Files>	392
<Print>	393
<Management Settings>	394
<User Management>	395
<Device Management>	396
<License/Other>	398
<Data Management>	400
<Security Settings>	402
<Output Report>	403

Settings/Registration

7L2J-05J

You can customize the machine based on your environment and needs by configuring settings described in this chapter. The Settings/Registration screen is displayed by selecting <Set> on the <Home> screen.

This section describes what each item in the setting menu can configure.

NOTE

- Some of the settings may not be displayed depending on the configuration of optional equipment installed on the machine.
- Some changes may not be reflected immediately, depending on the settings. In this case, it is necessary to perform one of the following.
 - Select <Yes> on the screen confirming whether you want to make changes.
 - Select <Apply Set. Changes> on the <Home> screen.
 - Restart the machine.

Settings/Registration Table

The following settings can be selected or stored on the Settings/Registration screen:

- ▶ Preferences(P. 298)
- ▶ Adjustment/Maintenance(P. 324)
- ▶ Function Settings(P. 328)
- ▶ Management Settings(P. 348)
- ▶ Output Report(P. 354)

NOTE

- Some of the settings may not be displayed depending on the configuration of optional equipment installed on the machine.
- Some changes may not be reflected immediately, depending on the settings. In this case, it is necessary to perform one of the following.
 - Select <Yes> on the screen confirming whether you want to make changes.
 - Select <Apply Set. Changes> on the <Home> screen.
 - Restart the machine.
- The settings that can be specified differ between administrators and general users, and vary depending on restrictions imposed by the administrator.

■ Description of the Settings

Describes the functions of each setting item on Settings/Registration. The settings that can be operated vary depending on the user authority and the machine you use. Setting items and values are written under Setting Description. The factory defaults are written in **bold red characters**.

■ "Can be set in Remote UI"

The "Can be set in Remote UI" item is written for each item in the Settings/Registration table. "Yes" or "No" indicates if the settings can/cannot be set in the Remote UI.

■ Import All Function

The "Import All Function" item is written in the Settings/Registration table. Depending on whether a setting item can be batch imported, "A", "B", "C", or "No" is written. "A", "B", and "C" refer to the following cases.

Case A

Importing all to your machine

Restoring the settings information to your machine for backups.

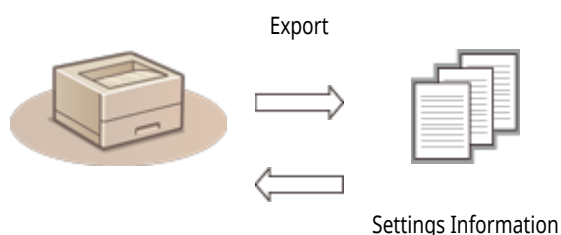

Import

Case B

Importing all to the same model machine

Applies to machines of the same series as this machine.



Case C

Importing all to the different model machine

Applies to models that support batch importing.



■ **Name of Item When Exporting with the Remote UI**

This section indicates which Settings/Registration items correspond with which items of the batch export function of the Remote UI. "-" is indicated for items that are not imported/exported. ▶ **Importing/Exporting All Settings(P. 275)**
 The items that can be selected for the batch export function of the Remote UI are indicated below.

Items That Can Be Selected with the Batch Export Function
Settings/Registration Basic Information
Paper Type Management Settings
Settings for Printer Settings
Download Profile for Printer Settings
Department ID Management Settings
Key Settings
Certificate/Certificate Revocation List (CRL) Settings
Authentication User Management
Security Policy Settings
AddOn Application Setting Information

Preferences

7L2J-05L

- ▶ [Display Settings\(P. 299\)](#)
- ▶ [Timer/Energy Settings\(P. 300\)](#)
- ▶ [Network\(P. 302\)](#)
- ▶ [External Interface\(P. 321\)](#)
- ▶ [Accessibility\(P. 322\)](#)
- ▶ [Volume Settings\(P. 323\)](#)

NOTE

- Some items can be set using the Remote UI. Use the control panel of the device to set items which cannot be set using the Remote UI.
- The names may be different on the Remote UI.

Display Settings

7L2J-05R

NOTE

- For information on the items ("A", "B", "C", and "No") in the "Import All Function" column, see [▶ Import All Function\(P. 296\)](#) .

Item	Setting Description	Can be set in Remote UI	Import All Function	Name of Item When Exporting with the Remote UI
<Button Display Order on Home Screen>	<Select Button to Move> <Set>, <Paper Settings>, <Memory Media>, <Print>, <Mobile Portal>, <Display Order (Home)>, <Update Firmware>*1, <uniFLOW Online Setup>	No	C	Settings/Registration Basic Information
<Default Screen After Startup/Restoration>	<Home>, <Memory Media Print>, <Print>, <Status Monitor>, <Update Firmware>*1, <uniFLOW Online Setup>	No	C	Settings/Registration Basic Information
<Language>	<Bahasa Melayu>, <Català>, <Čeština>, <Dansk>, <Deutsch>, <Esti>, <English>, <Español>, <Euskara>, <Français>, <Hrvatski>, <Italiano>, <Latviešu>, <Lietuvių>, <Magyar>, <Nederlands>, <Norsk>, <Polski>, <Português>, <Română>, <Slovenčina>, <Slovenščina>, <Suomi>, <Svenska>, <Tiếng Việt Nam>, <Türkçe>, <Ελληνικά>, <Български>, <Русский>, <Українська>, <العربية>, <ภาษาไทย>, <日本語>, <中文 (繁體)>, <中文 (简体)>, <한국어>	No	C	Settings/Registration Basic Information
<Millimeter/Inch Entry Switch>	<Millimeter>, <Inch>	No	C	Settings/Registration Basic Information
<Confirm When Loading Paper in Drawer>	<Off>, <On>	No	C	Settings/Registration Basic Information
<IP Address Display Settings>	<Off>, <On>	No	C	Settings/Registration Basic Information
<Display Mobile Portal>	<Off>, <On>	No	C	Settings/Registration Basic Information

*1 Indicates items that may not be displayed, depending on the region.

Timer/Energy Settings

7L2J-05S

NOTE

- For information on the items ("A", "B", "C", and "No") in the "Import All Function" column, see [▶ Import All Function\(P. 296\)](#) .

Item	Setting Description	Can be set in Remote UI	Import All Function	Name of Item When Exporting with the Remote UI
<Date/Time Settings>	<Current Date/Time Settings>: Date and Time Setting (12-digit number)	Yes	No	Settings/Registration Basic Information
	<Daylight Saving Time Settings>: <On>, <Off>	Yes	C	Settings/Registration Basic Information
	<Start> (<Month>/<Day>/<Time> (0 to 23)), <End> (<Month>/<Day>/<Time> (0 to 23))	Yes	C	Settings/Registration Basic Information
	<Time Zone>: UTC-12:00 to UTC+08:00 *1 to UTC+14:00	Yes	C	Settings/Registration Basic Information
<Time Format>	< 24 Hour >, <12 Hour>	Yes	C	Settings/Registration Basic Information
<Quick Startup Settings for Main Power>	<Off>, <On>	Yes	C	Settings/Registration Basic Information
<Auto Reset Time>	0 min=Off, 10 to 50 seconds in 10 second increments, 1 to 2 to 9 minutes in one minute increments	Yes	C	Settings/Registration Basic Information
<Restrict Auto Reset Time>	<Off>, <On>	Yes	C	Settings/Registration Basic Information
<Function After Auto Reset>	< Default Function >, <Selected Function>	Yes	C	Settings/Registration Basic Information
<Auto Shutdown Time>	0 hr=Off , 1 to 8 hours in one hour increments	Yes	C	Settings/Registration Basic Information
<Auto Shutdown Weekly Timer>	<Sunday> to <Saturday>, 00:00 to 23:59, in one minute increments	Yes	C	Settings/Registration Basic Information
<Allow Sleep Mode During Error>	<Off>, <On>	Yes	C	Settings/Registration Basic Information
<Auto Sleep Time>	10 secs, 1 min , 2 mins, 10 mins, 15 mins, 20 mins, 30 mins, 40 mins, 50 mins, 1 hr, 90 mins, 2 hrs	Yes	C	Settings/Registration Basic Information
<Sleep Mode Energy Use>	< Low >, <High>	Yes	C	Settings/Registration Basic Information
<Auto Sleep Weekly Timer>	<Sunday> to <Saturday>, 00:00 to 23:59, in one minute increments	Yes	C	Settings/Registration Basic Information

Settings/Registration

<Time Settings for Auto Adjust Gradation>	<Sunday> to <Saturday>, 00:00 to 23:59, in one minute increments	Yes	C	Settings/Registration Basic Information
<Energy Saver/Sleep Mode Exit Time Set.>	00:00 to 23:59, in one minute increments	Yes	C	Settings/Registration Basic Information

*1 Indicates items with default setting that may differ depending on the region.

Network

7L2J-05U

NOTE

- For information on the items ("A", "B", "C", and "No") in the "Import All Function" column, see [▶Import All Function\(P. 296\)](#) .

- <Output Report> *1

Item	Setting Description	Can be set in Remote UI	Import All Function	Name of Item When Exporting with the Remote UI
<Output Report>	<Print>	Yes	No	-

*1 This setting can only be specified from the Remote UI.

- <Confirm Network Connection>

Item	Setting Description	Can be set in Remote UI	Import All Function	Name of Item When Exporting with the Remote UI
<Confirm Network Connection >	<Off>, <On>	No	C	Settings/Registration Basic Information

- <TCP/IP Settings>: <IPv4 Settings>

Item	Setting Description	Can be set in Remote UI	Import All Function	Name of Item When Exporting with the Remote UI
<Use IPv4>	<Off>, <On>	Yes	C	Settings/Registration Basic Information
<IP Address Settings>	<Auto Acquire> <Select Protocol>: <Off>, <DHCP> <Auto IP>: <Off>, <On> <ul style="list-style-type: none"> When <On> is selected: <IP Address>*1: <0.0.0.0> <Subnet Mask>*1: <0.0.0.0> <Gateway Address>*1: <0.0.0.0> 	Yes	C	Settings/Registration Basic Information
	<Manually Acquire> <IP Address>: Enter the IP address.	Yes	C	Settings/Registration Basic Information
	<Check Settings> <IP Address>: Display only <Subnet Mask>: Display only <Gateway Address>: Display only	Yes	C*2	Settings/Registration Basic Information
<DHCP Option Settings>	<Acquire Host Name>: <Off>, <On>	Yes	C	Settings/Registration Basic Information
	<DNS Dynamic Update>: <Off>, <On>	Yes	C	Settings/Registration Basic Information

Settings/Registration

	<Acquire DNS Server Address>: <Off>, <On>	Yes	C	Settings/Registration Basic Information
	<Acquire Domain Name>: <Off>, <On>	Yes	C	Settings/Registration Basic Information
	<Acquire POP Server Address>: <Off>, <On>	Yes	C	Settings/Registration Basic Information
	<Release Address Last Acquired from DHCP Server When Address Cannot Be Acquired>*1: <Off>, <On>	Yes	C	Settings/Registration Basic Information
<DNS Settings>*1	<Host Name>: Canon ***** ("*****" represents the last six digits of a MAC address.)	Yes	A	Settings/Registration Basic Information
	<Domain Name>: Enter the domain name.	Yes	A	Settings/Registration Basic Information
	<Perform DNS Dynamic Update>: <Off>, <On>	Yes	C	Settings/Registration Basic Information
<PING Command>	<IPv4 Address>: <0.0.0.0>	No	No	-

*1 This setting can only be specified from the Remote UI.

*2 <IP Address> is categorized as "A".

- <TCP/IP Settings>: <IPv6 Settings>

Item	Setting Description	Can be set in Remote UI	Import All Function	Name of Item When Exporting with the Remote UI
<Use IPv6>	<Off>, <On>	Yes	C	Settings/Registration Basic Information
	<Use Stateless Address>*1: <Off>, <On>	Yes	C	Settings/Registration Basic Information
	<Use Manual Address>*1: <Off>, <On>	Yes	A	Settings/Registration Basic Information
	<IP Address>*1 (IPv6 Address (39 characters maximum))	Yes	A	Settings/Registration Basic Information
	<Prefix Length>*1: 1 to 64 to 128	Yes	A	Settings/Registration Basic Information
	<Default Router Address>*1 (39 characters maximum)	Yes	A	Settings/Registration Basic Information
	<Use DHCPv6>*1: <Off>, <On>	Yes	C	Settings/Registration Basic Information
<Only Retrieve Stateful Address Prefix>*1	<Off>, <On>	Yes	C	Settings/Registration Basic Information
<DHCP Option Settings>	<Acquire DNS Server Address>: <Off>, <On>	Yes	C	Settings/Registration Basic Information
	<Acquire Domain Name>: <Off>, <On>	Yes	C	Settings/Registration Basic Information

Settings/Registration

<DNS Settings>*1	<Primary DNS Server Address>	Yes	C	Settings/Registration Basic Information
	<Secondary DNS Server Address>	Yes	C	Settings/Registration Basic Information
	<Use Same Host Name/Domain Name as IPv4>: <Off>, <On>	Yes	A	Settings/Registration Basic Information
	<Host Name>: Canon ***** ("*****" represents the last six digits of a MAC address.)	Yes	A	Settings/Registration Basic Information
	<Domain Name>: Enter the domain name.	Yes	A	Settings/Registration Basic Information
	<Perform DNS Dynamic Update>: <Off>, <On> <ul style="list-style-type: none"> • When <On> is selected: <Register Stateless Address>: <Off>, <On> <Register Manual Address>: <Off>, <On> <Register Stateful Address>: <Off>, <On> 	Yes	C	Settings/Registration Basic Information

*1 This setting can only be specified from the Remote UI.

• <TCP/IP Settings>: <DNS Settings>

Item	Setting Description	Can be set in Remote UI	Import All Function	Name of Item When Exporting with the Remote UI
<DNS Server Address Settings >	<Primary DNS Server>: Enter the IP address.	Yes	C	Settings/Registration Basic Information
	<Secondary DNS Server>: Enter the IP address.	Yes	C	Settings/Registration Basic Information
<mDNS Settings>	<Use IPv4 mDNS>: <Off>, <On>	Yes	C	Settings/Registration Basic Information
	<ul style="list-style-type: none"> • When <On> is selected: <mDNS Name> (63 characters maximum) 	Yes	C	Settings/Registration Basic Information
	<Use IPv6 mDNS>: <Off>, <On>	Yes	C	Settings/Registration Basic Information
	<ul style="list-style-type: none"> • When <On> is selected: <Use Same mDNS Name as IPv4>: <Off>, <On> 	Yes	C	Settings/Registration Basic Information
	<ul style="list-style-type: none"> • When <Off> is selected: <mDNS Name> (63 characters maximum) 	Yes	C	Settings/Registration Basic Information

• <TCP/IP Settings>

Item	Setting Description	Can be set in Remote UI	Import All Function	Name of Item When Exporting with the Remote UI
<LPD Print Settings>	<Off>, <On>	Yes	C	Settings/Registration Basic Information

Settings/Registration

	<ul style="list-style-type: none"> When <On> is selected: <Output LPD Banner Page>: <Off> , <On>	Yes	C	Settings/Registration Basic Information
	<RX Timeout>*1: 1 to 5 to 60 (min.)	Yes	C	Settings/Registration Basic Information
<RAW Print Settings>	<Off>, <On>	Yes	C	Settings/Registration Basic Information
	<ul style="list-style-type: none"> When <On> is selected: <Bidirectional Comm.>: <Off> , <On>	Yes	C	Settings/Registration Basic Information
	<RX Timeout>*1: 1 to 5 to 60 (min.)	Yes	C	Settings/Registration Basic Information
<SNTP Settings>	<Use SNTP>: <Off> , <On>	Yes	C	Settings/Registration Basic Information
	<Polling Interval>*1: 10 to 1440 to 2880 min.	Yes	C	Settings/Registration Basic Information
	<NTP Server Address>*1: (IP Address or Host Name)	Yes	C	Settings/Registration Basic Information
<FTP Print Settings>	<Use FTP Printing>: <Off> , <On>	Yes	C	Settings/Registration Basic Information
	<User Name>: guest	Yes	C	Settings/Registration Basic Information
	<Password>: 7654321	Yes	C	Settings/Registration Basic Information
<Use UTF-8 to Display FTP Print Job Name>	<Off> , <On>	Yes	C	Settings/Registration Basic Information
<WSD Settings>	<Use WSD Print>: <Off>, <On>	Yes	C	Settings/Registration Basic Information
	<Use WSD Browsing>: <Off>, <On>	Yes	C	Settings/Registration Basic Information
<IPP Print Settings>	<Off>, <On>	Yes	C	Settings/Registration Basic Information
	<ul style="list-style-type: none"> When <On> is selected: <Allow When Using TLS>: <Off> , <On>	Yes	C	Settings/Registration Basic Information
	<Use Authentication>: <Off> , <On>	Yes	C	Settings/Registration Basic Information
<Multicast Discovery Settings>	<Response>: <Off>, <On>	Yes	C	Settings/Registration Basic Information
	<Scope Name>	Yes	C	Settings/Registration Basic Information
<Sleep Mode Notification Settings>*1	<Notify>: <Off> , <On>	Yes	C	Settings/Registration Basic Information
	<Port Number>: 1 to 11427 to 65535	Yes	C	Settings/Registration Basic Information

Settings/Registration

	<Number of Routers to Traverse>: 0 to 3 to 254	Yes	C	Settings/Registration Basic Information
	<Notification Interval>: 60 to 600 to 65535 sec.	Yes	C	Settings/Registration Basic Information
<Use HTTP>	<Off>, < On >	Yes	C	Settings/Registration Basic Information
<TLS Settings>*1				
<Key and Certificate>	<Use>	Yes	No	-
	<Certificate Details> (<Version>, <Serial Number>, <Signature Algorithm>, <Issued To>, <Validity Start Date>, <Validity End Date>, <Issuer>, <Public Key>, <Certificate Thumbprint>, <Issued To (Alternate Name)>, <Verify Certificate>)	Yes	No	-
	<Key Usage> (Displays what the key pair is being used for)	Yes	No	-
<Specify Allowed Versions>	<Maximum Version>: <TLS 1.0>, <TLS 1.1>, < TLS 1.2 >, <TLS 1.3>	Yes	C	Settings/Registration Basic Information
	<Minimum Version>: < TLS 1.0 >, <TLS 1.1>, <TLS 1.2>, <TLS 1.3>	Yes	C	Settings/Registration Basic Information
<Algorithm Settings>	<ul style="list-style-type: none"> Encryption Algorithm <AES-CBC (256-bit)>: <Off>, < On > <AES-CBC (128-bit)>: <Off>, < On > <AES-GCM (256-bit)>: <Off>, < On > <AES-GCM (128-bit)>: <Off>, < On > <3DES-CBC>: < Off >, <On> <CHACHA20-POLY1305>: <Off>, < On >	Yes	C	Settings/Registration Basic Information
	<ul style="list-style-type: none"> Key Exchange Algorithm <RSA>: <Off>, < On > <ECDHE>: <Off>, < On > <X25519>: < Off >, <On>	Yes	C	Settings/Registration Basic Information
	<ul style="list-style-type: none"> Signature Algorithm <RSA>: <Off>, < On > <ECDSA>: <Off>, < On >	Yes	C	Settings/Registration Basic Information
	<ul style="list-style-type: none"> HMAC Algorithm <SHA1>: <Off>, < On > <SHA256>: <Off>, < On > <SHA384>: <Off>, < On >	Yes	C	Settings/Registration Basic Information
<Proxy Settings>	<Use Proxy>: < Off >, <On>	Yes	C	Settings/Registration Basic Information
	<Server Address> (IP Address or FQDN)	Yes	C	Settings/Registration Basic Information
	<Port Number>: 1 to 80 to 65535	Yes	C	Settings/Registration Basic Information
	<Use Proxy within Same Domain>: < Off >, <On>	Yes	C	Settings/Registration Basic Information

Settings/Registration

	<Authentication Set.>: <Use Proxy Authentication>(<Off>, <On>), <User Name> (24 characters maximum), <Password> (24 characters maximum), <Confirm> (24 characters maximum)	Yes	C	Settings/Registration Basic Information
<Confirm Auth Info When in Auth Mngt Mode>	<Off>, <On>	Yes	C	Settings/Registration Basic Information

*1 This setting can only be specified from the Remote UI.

- <TCP/IP Settings>: <IPSec Settings>

Item	Setting Description	Can be set in Remote UI	Import All Function	Name of Item When Exporting with the Remote UI
<Use IPSec>	<Off>, <On>	Yes	C	Settings/Registration Basic Information
<Receive Non-Policy Packets>*1	<Allow>, <Reject>	Yes	C	Settings/Registration Basic Information

*1 This setting can only be specified from the Remote UI.

- <TCP/IP Settings>: <IPSec Settings>: <IPSec Policy List>*1

Item	Setting Description	Can be set in Remote UI	Import All Function	Name of Item When Exporting with the Remote UI
<IPSec Policy List>	<Register New IPSec Policy>, <Delete>, <Raise Priority>, <Lower Priority>	Yes	C	Settings/Registration Basic Information
<Register Policy>	<Policy Name> (24 characters maximum), <Policy On/Off> (<Off>, <On>), <Only Allow 256-bit for AES Key Length> (<Off>, <On>), <Selector Settings>, <IKE Settings>, <IPSec Network Settings>	Yes	C	Settings/Registration Basic Information
<Selector>	<Local Address Settings> (<All IP Addresses>, <IPv4 Address>, <IPv6 Address>, <IPv4 Manual Settings>, <IPv6 Manual Settings>)	Yes	C	Settings/Registration Basic Information
	<ul style="list-style-type: none"> • <IPv4 Manual Settings> (<Single Address>(<First Address>), <Range Address>(<First Address>, <Last Address>), <Subnet Settings>(<First Address>, <Subnet Settings>)) 	Yes	C	Settings/Registration Basic Information
	<ul style="list-style-type: none"> • <IPv6 Manual Settings> (<Single Address>(<First Address>), <Range Address> (<First Address>, <Last Address>), <Prefix Address> (<First Address>, <Prefix Length>)) 	Yes	C	Settings/Registration Basic Information
	<ul style="list-style-type: none"> • <Prefix Length> (1 to 64 to 128) 	Yes	C	Settings/Registration Basic Information
	<Remote Address Settings>(<All IP Addresses>, <All IPv4 Addresses>, <All IPv6 Addresses>, <IPv4 Manual Settings>, <IPv6 Manual Settings>)	Yes	C	Settings/Registration Basic Information
	<ul style="list-style-type: none"> • <IPv4 Manual Settings>(<Single Address>(<First Address>), <Range Address>(<First Address>, <Last Address>), <Subnet Settings>(<First Address>, <Subnet Settings>)) 	Yes	C	Settings/Registration Basic Information

Settings/Registration

	<ul style="list-style-type: none"> <IPv6 Manual Settings> (<Single Address>(<First Address>), <Range Address> (<First Address>, <Last Address>), <Prefix Address> (<First Address>, <Prefix Length>)) 	Yes	C	Settings/Registration Basic Information
	<ul style="list-style-type: none"> <Prefix Length> (1 to 64 to 128) 	Yes	C	Settings/Registration Basic Information
	<Port Settings> (< Specify by Port Number >, <Specify by Service Name>)	Yes	C	Settings/Registration Basic Information
	<ul style="list-style-type: none"> <Specify by Port Number>(<Local Port>(<All Ports>, <Single Port>), <Remote Port>(<All Ports>, <Single Port>)) 	Yes	C	Settings/Registration Basic Information
	<ul style="list-style-type: none"> <Single Port> (1 to 65535) 	Yes	C	Settings/Registration Basic Information
	<ul style="list-style-type: none"> <Specify by Service Name> <SMTP RX>: <Off>, <On> <SMTP TX>: <Off>, <On> <POP3>: <Off>, <On> <LPD>: <Off>, <On> <RAW>: <Off>, <On> 	Yes	C	Settings/Registration Basic Information
<IKE>	<IKE Mode>: < Main >, <Aggressive>	Yes	C	Settings/Registration Basic Information
	<Validity>: 1 to 480 to 65535 min.	Yes	C	Settings/Registration Basic Information
	<Authentication Method>: < Pre-Shared Key Method > (<Shared Key Settings>), <Digital Signature Method> (<Key and Certificate>)	Yes	C	Settings/Registration Basic Information
	<ul style="list-style-type: none"> <Key and Certificate>: <Use> 	Yes	C	Settings/Registration Basic Information
	<ul style="list-style-type: none"> <Key and Certificate>: <Certificate Details>(<Version>, <Serial Number>, <Signature Algorithm>, <Issued To>, <Validity Start Date>, <Validity End Date>, <Issuer>, <Public Key>, <Certificate Thumbprint>, <Issued To (Alternate Name)>, <Verify Certificate>) 	Yes	C	Settings/Registration Basic Information
	<ul style="list-style-type: none"> <Key and Certificate>: <Key Usage>(Displays what the key pair is being used for) 	Yes	C	Settings/Registration Basic Information
	<Authentication/Encryption Algorithm> (< Auto >, <Manual Settings>)	Yes	C	Settings/Registration Basic Information
	<Authentication/Encryption Algorithm>: <Manual Settings> <ul style="list-style-type: none"> <Authentication> <SHA1>, <SHA2>, <SHA1 and SHA2> 	Yes	C	Settings/Registration Basic Information
	<ul style="list-style-type: none"> <Encryption> <3DES-CBC>, <AES-CBC>, <3DES-CBC and AES-CBC> 	Yes	C	Settings/Registration Basic Information
<ul style="list-style-type: none"> <DH Group> <Group 14 (2048)>, <ECDH-P256>, <ECDH-P384> 	Yes	C	Settings/Registration Basic Information	
<IPSec Network>	<Validity>	Yes	C	Settings/Registration Basic Information

Settings/Registration

	<Time>: <Off>, <On>			
	<ul style="list-style-type: none"> <On>: (1 to 480 to 65535min.) 	Yes	C	Settings/Registration Basic Information
	<Validity> <Size>: <Off>, <On>	Yes	C	Settings/Registration Basic Information
	<ul style="list-style-type: none"> <On>: (0 to 1 to 65535 MB) 	Yes	C	Settings/Registration Basic Information
	<Use PFS>: <Off>, <On>	Yes	C	Settings/Registration Basic Information
	<Authentication/Encryption Algorithm>: <Auto>, <Manual Settings>	Yes	C	Settings/Registration Basic Information
	<Authentication/Encryption Algorithm>: <Manual Settings> (<ESP>, <ESP (AES-GCM)>, <AH (SHA1)>)	Yes	C	Settings/Registration Basic Information
	<ESP> Settings: <ESP Authentication>: <SHA1>, <NULL> <ESP Encryption>: <3DES-CBC>, <AES-CBC>, <3DES-CBC and AES-CBC>, <NULL>	Yes	C	Settings/Registration Basic Information
	<ESP (AES-GCM)> Settings: None	Yes	C	Settings/Registration Basic Information
	<AH (SHA1)> Settings: None	Yes	C	Settings/Registration Basic Information
	<Connection Mode>: <Transport> (display only)	Yes	C	Settings/Registration Basic Information

*1 This setting can only be specified from the Remote UI.

• <TCP/IP Settings>

Item	Setting Description	Can be set in Remote UI	Import All Function	Name of Item When Exporting with the Remote UI
<TCP/IP Option Settings>*1	<Use Window Scale Option>: <Off>, <On>	Yes	C	Settings/Registration Basic Information
	<MTU Size>: 600 to 1500 bytes (600-1500)	Yes	C	Settings/Registration Basic Information

*1 This setting can only be specified from the Remote UI.

• <SNMP Settings>

Item	Setting Description	Can be set in Remote UI	Import All Function	Name of Item When Exporting with the Remote UI
<Use SNMPv1>	<Off>, <On>	Yes	C	Settings/Registration Basic Information
<Use Dedicated Community>*1	<Use Dedicated Community>: <Off>, <On>	Yes	C	Settings/Registration Basic Information

Settings/Registration

	<MIB Access Permission>: <Read/Write>, <Read Only>	Yes	C	Settings/Registration Basic Information
<Use Community Name 1>*1	<Use Community Name 1>: <Off>, <On>	Yes	C	Settings/Registration Basic Information
	<MIB Access Permission>: <Read/Write>, <Read Only>	Yes	C	Settings/Registration Basic Information
	<Community Name>: public	Yes	C	Settings/Registration Basic Information
<Use Community Name 2>*1	<Use Community Name 2>: <Off>, <On>	Yes	C	Settings/Registration Basic Information
	<MIB Access Permission>: <Read/Write>, <Read Only>	Yes	C	Settings/Registration Basic Information
	<Community Name>: public2	Yes	C	Settings/Registration Basic Information
<Use SNMPv3>	<Off>, <On>	Yes	C	Settings/Registration Basic Information
<Administrator Settings>*1	<Use Administrator>: <Off>, <On> <User Name>: Display only <MIB Access Permission>: Display only <Security Settings>: Display only <Authentication Algorithm>: Display only <Encryption Algorithm>: Display only	Yes	C	Settings/Registration Basic Information
	<Use Same Password as for Authentication>: <Off>, <On>	Yes	C	Settings/Registration Basic Information
	<Set/Change Password>: <Off>, <On> <Encryption Password>: Enter the password. <Confirm>: Enter the password.	Yes	C	Settings/Registration Basic Information
<User Settings>*1	<User On/Off>: <Enable>, <Disable>	Yes	C	Settings/Registration Basic Information
	<Register> (<User Name>, <MIB Access Permission> (<Read/Write>, <Read Only>), <Security Settings> (<Auth. Yes/Encrypt. Yes>, <Auth. Yes/Encrypt. No>, <Auth. No/Encrypt. No>), <Authentication Algorithm> (<MD5>, <SHA1>, <SHA2-224>, <SHA2-256>, <SHA2-384>, <SHA2-512>), <Authentication Password>, <Encryption Algorithm> (<DES>, <AES>), <Encryption Password>)	Yes	C	Settings/Registration Basic Information
	<Details/Edit> (<User Name>, <MIB Access Permission> (<Read/Write>, <Read Only>), <Security Settings> (<Auth. Yes/Encrypt. Yes>, <Auth. Yes/Encrypt. No>, <Auth. No/Encrypt. No>), <Authentication Algorithm> (<MD5>, <SHA1>, <SHA2-224>, <SHA2-256>, <SHA2-384>, <SHA2-512>), <Authentication Password>, <Encryption Algorithm> (<DES>, <AES>), <Encryption Password>)	Yes	C	Settings/Registration Basic Information
	<Delete>	Yes	No	-

Settings/Registration

<Get Printer Management Information from Host>*1	<Off>, <On>	Yes	C	Settings/Registration Basic Information
--	-------------	-----	---	---

*1 This setting can only be specified from the Remote UI.

- <Format Host Resources MIB to RFC2790>

Item	Setting Description	Can be set in Remote UI	Import All Function	Name of Item When Exporting with the Remote UI
<Format Host Resources MIB to RFC2790>	<Off>, <On>	No	C	Settings/Registration Basic Information

- <Dedicated Port Settings>*1

Item	Setting Description	Can be set in Remote UI	Import All Function	Name of Item When Exporting with the Remote UI
<Dedicated Port Settings>	<Off>, <On>	Yes	C	Settings/Registration Basic Information
<Dedicated Port Authentication Method>	<Mode 1>, <Mode 2>	Yes	C	Settings/Registration Basic Information

*1 This setting can only be specified from the Remote UI.

- <Use Spool Function>

Item	Setting Description	Can be set in Remote UI	Import All Function	Name of Item When Exporting with the Remote UI
<Use Spool Function>	<Off>, <On>	Yes	C	Settings/Registration Basic Information

- <Receive in Parallel>

Item	Setting Description	Can be set in Remote UI	Import All Function	Name of Item When Exporting with the Remote UI
<Receive in Parallel>	<Off>, <On>	Yes	C	Settings/Registration Basic Information

- <Waiting Time for Connection at Startup>

Item	Setting Description	Can be set in Remote UI	Import All Function	Name of Item When Exporting with the Remote UI
<Waiting Time for Connection at Startup>	0 to 300 sec.	Yes	C	Settings/Registration Basic Information

- <Ethernet Driver Settings>

Item	Setting Description	Can be set in Remote UI	Import All Function	Name of Item When Exporting with the Remote UI
<Ethernet Driver Settings>	<Auto Detect>: <Off>, <On>	Yes	C	Settings/Registration Basic Information
	<ul style="list-style-type: none"> • <Communication Mode>: <Half Duplex>, <Full Duplex> 	Yes	C	Settings/Registration Basic Information

Settings/Registration

	<ul style="list-style-type: none"> <Ethernet Type>: <10BASE-T>, <100BASE-TX>, <1000BASE-T> 	Yes	C	Settings/Registration Basic Information
	<Current Transmission Speed>: Display Only	Yes	No	-
	<MAC Address>: Display only	Yes	No	-

• <IEEE 802.1X Settings>

Item	Setting Description	Can be set in Remote UI	Import All Function	Name of Item When Exporting with the Remote UI
<Use IEEE 802.1X>	<Off>, <On>	Yes	C	Settings/Registration Basic Information
<Login Name> *1	Login Name	Yes	C	Settings/Registration Basic Information
<Verify Authentication Server Certificate> *1	<Off>, <On>	Yes	C	Settings/Registration Basic Information
<Verify Authentication Server Name> *1	<Off>, <On>	Yes	C	Settings/Registration Basic Information
<Authentication Server Name> *1	Authentication Server Name	Yes	C	Settings/Registration Basic Information
<Use TLS> *1	<Off>, <On>	Yes	C	Settings/Registration Basic Information
<Key and Certificate> *1	<Use>	Yes	No	-
	<Certificate Details> (<Version>, <Serial Number>, <Signature Algorithm>, <Issued To>, <Validity Start Date>, <Validity End Date>, <Issuer>, <Public Key>, <Certificate Thumbprint>, <Issued To (Alternate Name)>, <Verify Certificate>)	Yes	No	-
	<Key Usage> (Key and Certificate)	Yes	No	-
<Use TTLS> *1	<Off>, <On>	Yes	C	Settings/Registration Basic Information
	<ul style="list-style-type: none"> <TTLS Settings (TTLS Protocol)>: <Use MSCHAPv2>, <Use PAP> 	Yes	C	Settings/Registration Basic Information
<Use PEAP> *1	<Off>, <On>	Yes	C	Settings/Registration Basic Information
<Use Login Name as User Name> *1	<Off>, <On>	Yes	C	Settings/Registration Basic Information
<User Name> *1	Name of the user to be authenticated with IEEE802.1X authentication	Yes	C	Settings/Registration Basic Information
<Password> *1	Password of the user to be authenticated with IEEE802.1X authentication	Yes	C	Settings/Registration Basic Information

*1 This setting can only be specified from the Remote UI.

- <Firewall Settings>: <IPv4 Address Filter>

Item	Setting Description	Can be set in Remote UI	Import All Function	Name of Item When Exporting with the Remote UI
<Outbound Filter>	<Use Filter>: <Off>, <On>	Yes	C	Settings/Registration Basic Information
	<Default Policy>*1: <Allow>, <Reject>	Yes	C	Settings/Registration Basic Information
	<Exception Addresses>*1: <Register New> (Up to 16 IPv4 addresses), <Delete>	Yes	C	Settings/Registration Basic Information
	<ul style="list-style-type: none"> • <Address to Register>*1 	Yes	C	Settings/Registration Basic Information
	<ul style="list-style-type: none"> • <Specify Port Number>*1: <Off>, <On> 	Yes	C	Settings/Registration Basic Information
	<ul style="list-style-type: none"> • <Port Number>*1: Enter the port number. <Delete>, <Add> 	Yes	C	Settings/Registration Basic Information
<Inbound Filter>	<Use Filter>: <Off>, <On>	Yes	C	Settings/Registration Basic Information
	<Default Policy>*1: <Allow>, <Reject>	Yes	C	Settings/Registration Basic Information
	<Exception Addresses>*1: <Register New> (Up to 16 IPv4 addresses), <Delete>	Yes	C	Settings/Registration Basic Information
	<ul style="list-style-type: none"> • <Address to Register>*1 	Yes	C	Settings/Registration Basic Information
	<ul style="list-style-type: none"> • <Specify Port Number>*1: <Off>, <On> 	Yes	C	Settings/Registration Basic Information
	<ul style="list-style-type: none"> • <Port Number>*1: Enter the port number. <Delete>, <Add> 	Yes	C	Settings/Registration Basic Information
<IPv4 Address ICMP Settings>*1	<Always Allow Sending/Receiving Using ICMP>: <Off>, <On>	Yes	C	Settings/Registration Basic Information

*1 This setting can only be specified from the Remote UI.

- <Firewall Settings>: <IPv6 Address Filter>

Item	Setting Description	Can be set in Remote UI	Import All Function	Name of Item When Exporting with the Remote UI
<Outbound Filter>	<Use Filter>: <Off>, <On>	Yes	C	Settings/Registration Basic Information
	<Default Policy>*1: <Allow>, <Reject>	Yes	C	Settings/Registration Basic Information
	<Exception Addresses>*1: <Register New> (Up to 16 IPv4 addresses), <Delete>	Yes	C	Settings/Registration Basic Information

Settings/Registration

	<ul style="list-style-type: none"> • <Address to Register>*1 	Yes	C	Settings/Registration Basic Information
	<ul style="list-style-type: none"> • <Specify Port Number>*1: <Off>, <On> 	Yes	C	Settings/Registration Basic Information
	<ul style="list-style-type: none"> • <Port Number>*1: Enter the port number. <Delete>, <Add> 	Yes	C	Settings/Registration Basic Information
<Inbound Filter>	<Use Filter>: <Off>, <On>	Yes	C	Settings/Registration Basic Information
	<Default Policy>*1: <Allow>, <Reject>	Yes	C	Settings/Registration Basic Information
	<Exception Addresses>*1: <Register New> (Up to 16 IPv4 addresses), <Delete>	Yes	C	Settings/Registration Basic Information
	<ul style="list-style-type: none"> • <Address to Register>*1 	Yes	C	Settings/Registration Basic Information
	<ul style="list-style-type: none"> • <Specify Port Number>*1: <Off>, <On> 	Yes	C	Settings/Registration Basic Information
	<ul style="list-style-type: none"> • <Port Number>*1: Enter the port number. <Delete>, <Add> 	Yes	C	Settings/Registration Basic Information
<IPv6 Address ICMP Settings>*1	<Always Allow Sending/Receiving Using ICMP>: <Off>, <On>	Yes	C	Settings/Registration Basic Information

*1 This setting can only be specified from the Remote UI.

- <Firewall Settings>: <MAC Address Filter>

Item	Setting Description	Can be set in Remote UI	Import All Function	Name of Item When Exporting with the Remote UI
<Outbound Filter>	<Use Filter>: <Off>, <On>	Yes	C	Settings/Registration Basic Information
	<Default Policy>*1: <Allow>, <Reject>	Yes	C	Settings/Registration Basic Information
	<Exception Addresses>*1: <Add> (Up to 100 Mac addresses), <Edit>, <Delete>	Yes	C	Settings/Registration Basic Information
<Inbound Filter>	<Use Filter>: <Off>, <On>	Yes	C	Settings/Registration Basic Information
	<Default Policy>*1: <Allow>, <Reject>	Yes	C	Settings/Registration Basic Information
	<Exception Addresses>*1: <Add> (Up to 100 Mac addresses), <Edit>, <Delete>	Yes	C	Settings/Registration Basic Information

*1 This setting can only be specified from the Remote UI.

- <Firewall Settings>: <IP Address Block Log>*1

Settings/Registration

Item	Setting Description	Can be set in Remote UI	Import All Function	Name of Item When Exporting with the Remote UI
<IP Address Block Log>	<Date/Time>, <Type>, <IP Address>, <Port Number>, <Result>	Yes	No	-

*1 This setting can only be specified from the Remote UI.

● <Use Mopria>

Item	Setting Description	Can be set in Remote UI	Import All Function	Name of Item When Exporting with the Remote UI
<Use Mopria>	<Off>, <On>	Yes	C	Settings/Registration Basic Information

● <Use AirPrint>

Item	Setting Description	Can be set in Remote UI	Import All Function	Name of Item When Exporting with the Remote UI
<Use AirPrint>	<Off>, <On> <ul style="list-style-type: none"> When <On> is selected: <Printer Name>*1: Enter the Printer Name <Location>*1: Enter the Location 	Yes	C	Settings/Registration Basic Information

*1 This setting can only be specified from the Remote UI.

● <Display Errors for AirPrint>

Item	Setting Description	Can be set in Remote UI	Import All Function	Name of Item When Exporting with the Remote UI
<Display Errors for AirPrint>	<Off>, <On>	Yes	C	Settings/Registration Basic Information

● <Position Information>*1

Item	Setting Description	Can be set in Remote UI	Import All Function	Name of Item When Exporting with the Remote UI
<Position Information>	<Auto Acquire>	Yes	No	-
	<Latitude>: Specify the latitude.	Yes	No	-
	<Longitude>: Specify the longitude.	Yes	No	-

*1 This setting can only be specified from the Remote UI.

● <Settings for Universal Print>*1

Item	Setting Description	Can be set in Remote UI	Import All Function	Name of Item When Exporting with the Remote UI

Settings/Registration

<Basic Settings>				
<Use Universal Print>	<Off>, <On>	Yes	C	Settings/Registration Basic Information
<Verify Server Certificate>	<Off>, <On>	Yes	C	Settings/Registration Basic Information
<Add CN to Verification Items>	<Off>, <On>	Yes	C	Settings/Registration Basic Information
<Printer Name>	OIP_PRINTER	Yes	A	Settings/Registration Basic Information
<Application ID>	f9fc375cc7ba-4e5c-b213-23affd792cc1	Yes	C	Settings/Registration Basic Information
<Azure Active Directory Authentication URL>	https://login.microsoftonline.com/organizations/oauth2/v2.0	Yes	C	Settings/Registration Basic Information
<Azure Active Directory Registration URL>	https://register.print.microsoft.com/api/v1.0/register	Yes	C	Settings/Registration Basic Information
<Registration Status>	<URL for Registration> <Code for Registration>	Yes	-	Settings/Registration Basic Information

*1 This setting can only be specified from the Remote UI.

- <Select Interface>

Item	Setting Description	Can be set in Remote UI	Import All Function	Name of Item When Exporting with the Remote UI
<Select Interface>	<Wired LAN>, <Wireless LAN>, <Wired LAN + Wired LAN>, <Wired LAN + Wireless LAN>	No	C	Settings/Registration Basic Information

- <Wireless LAN>: <Wireless LAN Settings>

Item	Setting Description	Can be set in Remote UI	Import All Function	Name of Item When Exporting with the Remote UI
<WPS Push Button Mode>				
<WPS PIN Code Mode>				
<SSID Settings>	<Select Access Point>: Select from the list.	No	No	-
	WEP authentication: (<WEP Key (5-26 Char.)>): Enter the WEP key	No	No	-
	WPA/WPA2-PSK encryption: (<PSK (8-64 Char.)>): Enter the WPA/WPA2-PSK Passphrase	No	No	-
	<Enter Manually>: Enter SSID	No	No	-
	<Security Settings>: <None>, <WEP>, <WPA/WPA2-PSK>, <WPA/WPA2-EAP>	No	No	-
	● <Security Settings> (<WEP>)	No	No	-

Settings/Registration

	<IEEE 802.1X Settings> (<Open System>, <Shared Key>), <WEP Key 1>, <WEP Key 2>, <WEP Key 3>, <WEP Key 4> <ul style="list-style-type: none"> • <Security Settings> (<WPA/WPA2-PSK>) <Encryption Method> (<Auto>, <AES-CCMP>)			
<Power Save Mode>	<Off>, <On>	No	No	-
<Connection Information>	<MAC Address>: Display Only <Wireless LAN Status>: Display Only <Latest Error Information>: Display Only <Channel>: Display Only <SSID Settings>: Display Only <Security Settings>: Display Only <Power Save Mode>: Display Only	Yes	No	-

• <Direct Connection Settings>

Item	Setting Description	Can be set in Remote UI	Import All Function	Name of Item When Exporting with the Remote UI
<Use Direct Connection>	<Off>, <On>	Yes	C	Settings/Registration Basic Information
<Direct Connection Type>	<Access Point Mode>, <Wi-Fi Direct>	Yes	C	Settings/Registration Basic Information
<Device Name for Wi-Fi Direct>	<Dev Name(Wi-Fi Direct)>: Device Name	Yes	No	Settings/Registration Basic Information
<Time Until Direct Connection Termination>	0 = None, 1 to 30 to 60 min.	Yes	C	Settings/Registration Basic Information
<Access Point Mode Settings>	<Use Personal SSID and Network Key>*1: <Off>, <On>	Yes	C	Settings/Registration Basic Information
	<Use Custom SSID>: <Off>, <On>	Yes	C	Settings/Registration Basic Information
	<ul style="list-style-type: none"> • When <On> is selected: <SSID>: Enter SSID 	Yes	C	Settings/Registration Basic Information
	<Use Custom Network Key>: <Off>, <On>	Yes	C	Settings/Registration Basic Information
	<ul style="list-style-type: none"> • When <On> is selected: <Network Key>: Enter the network key 	Yes	C	Settings/Registration Basic Information
<Keep Enabled If SSID/Net. Key Specified>	<Off>, <On>	Yes	C	Settings/Registration Basic Information
<Direct Connection IP Address Settings>	192.168.22.1	Yes	C	Settings/Registration Basic Information

*1 This setting can only be specified from the Remote UI.

• <Session Settings>*1

Item	Setting Description	Can be set in Remote UI	Import All Function	Name of Item When Exporting with the Remote UI
------	---------------------	-------------------------	---------------------	--

Settings/Registration

<Timeout After Logging in to Remote UI>	15 to 150 min.	Yes	C	Settings/Registration Basic Information
---	----------------	-----	---	---

*1 This setting can only be specified from the Remote UI.

● <Sub Line Settings>

Item	Setting Description	Can be set in Remote UI	Import All Function	Name of Item When Exporting with the Remote UI
<IP Address Settings>	<Auto Acquire>: <DHCP>, <Off>	No	C	Settings/Registration Basic Information
	<Manually Acquire> <IP Address>: <0.0.0.0> <Subnet Mask>: <0.0.0.0> <Gateway Address>: <0.0.0.0>	No	A	Settings/Registration Basic Information
	<Check Settings>: Display only	No	A	-
<Priority Line for Comm w/Mobile Devices>	<Main Line>, <Sub Line>	No	C	Settings/Registration Basic Information
<Ethernet Driver Settings>	<Auto Detect>: <Off>, <On>	Yes	C	Settings/Registration Basic Information
	● <Communication Mode>: <Half Duplex>, <Full Duplex>	Yes	C	Settings/Registration Basic Information
	● <Ethernet Type>: <10BASE-T>, <100BASE-TX>, <1000BASE-T>	Yes	C	Settings/Registration Basic Information
	<Current Transmission Speed>: Display only	Yes	C	Settings/Registration Basic Information
	<MAC Address>: Display only	Yes	C	Settings/Registration Basic Information

● <Sub Line Settings>: <Firewall Settings>: <IPv4 Address Filter>

Item	Setting Description	Can be set in Remote UI	Import All Function	Name of Item When Exporting with the Remote UI
<Outbound Filter>	<Use Filter>: <Off>, <On>	Yes	C	Settings/Registration Basic Information
	<Default Policy>*1: <Allow>, <Reject>	Yes	C	Settings/Registration Basic Information
	<Exception Addresses>*1: <Register New> (Up to 16 IPv4 addresses), <Delete>	Yes	C	Settings/Registration Basic Information
	● <Address to Register>*1	Yes	C	Settings/Registration Basic Information
	● <Specify Port Number>*1: <Off>, <On>	Yes	C	Settings/Registration Basic Information
	● <Port Number>*1: Enter the port number. <Delete>, <Add>	Yes	C	Settings/Registration Basic Information

Settings/Registration

<Inbound Filter>	<Use Filter>: <Off>, <On>	Yes	C	Settings/Registration Basic Information
	<Default Policy>*1: <Allow>, <Reject>	Yes	C	Settings/Registration Basic Information
	<Exception Addresses>*1: <Register New> (Up to 16 IPv4 addresses), <Delete>	Yes	C	Settings/Registration Basic Information
	<ul style="list-style-type: none"> • <Address to Register>*1 	Yes	C	Settings/Registration Basic Information
	<ul style="list-style-type: none"> • <Specify Port Number>*1: <Off>, <On> 	Yes	C	Settings/Registration Basic Information
	<ul style="list-style-type: none"> • <Port Number>*1: Enter the port number. <Delete>, <Add> 	Yes	C	Settings/Registration Basic Information

*1 This setting can only be specified from the Remote UI.

• <Sub Line Settings>: <Settings for System Data Communication>

Item	Setting Description	Can be set in Remote UI	Import All Function	Name of Item When Exporting with the Remote UI
<DNS Server Address Settings>	<Primary DNS Server>	Yes	C	Settings/Registration Basic Information
	<Secondary DNS Server>	Yes	C	Settings/Registration Basic Information
<Proxy Settings>	<Use Proxy>: <Off>, <On>	Yes	C	Settings/Registration Basic Information
	<Server Address> (IP Address or FQDN)	Yes	C	Settings/Registration Basic Information
	<Port Number>: 1 to 80 to 65535	Yes	C	Settings/Registration Basic Information
<Authentication Set.>	<Use Proxy Auth.>: <Off>, <On>	Yes	C	Settings/Registration Basic Information
	<User Name> (24 characters maximum)	Yes	C	Settings/Registration Basic Information
	<Password> (24 characters maximum) <Confirm> (24 characters maximum)	Yes	C	Settings/Registration Basic Information

• <Static Routing Settings>

Item	Setting Description	Can be set in Remote UI	Import All Function	Name of Item When Exporting with the Remote UI
<Static Routing Settings>	<Use Static Routing>: <Off>, <On>	No	C	Settings/Registration Basic Information
	<Register>, <Delete>*1	No	No	-
	<ul style="list-style-type: none"> • <Register> 	No	C	Settings/Registration Basic Information

Settings/Registration

	<Address>(<0.0.0.0>), <Prefix Length>(1 to 32), <Gateway Address>(<0.0.0.0>)			
--	--	--	--	--

*1 This setting can only be specified from the Remote UI.

External Interface

7L2J-05W

NOTE

- For information on the items ("A", "B", "C", and "No") in the "Import All Function" column, see [▶ Import All Function\(P. 296\)](#) .

Item	Setting Description	Can be set in Remote UI	Import All Function	Name of Item When Exporting with the Remote UI
<USB Settings>				
<Use as USB Device>	<Off>, <On>	Yes	C	Settings/Registration Basic Information
<Use AddOn Driver for USB Storage Device>	<Off>, <On>	Yes	C	Settings/Registration Basic Information
<Use USB Storage Device>	<Off>, <On>	Yes	C	Settings/Registration Basic Information
<Restrict Auto Install of Printer Driver>	<Off>, <On>	Yes	C	Settings/Registration Basic Information

Accessibility

7L2J-05X

NOTE

- For information on the items ("A", "B", "C", and "No") in the "Import All Function" column, see [▶Import All Function\(P. 296\)](#) .

Item	Setting Description	Can be set in Remote UI	Import All Function	Name of Item When Exporting with the Remote UI
<Invert Screen Colors>	<Off>, <On>	No	C	Settings/Registration Basic Information
<Contrast>	-3 to 0 to +3 (7 levels)	No	C	Settings/Registration Basic Information
<Backlight Brightness>	0-4	No	C	Settings/Registration Basic Information
<Message Display Time>	1 to 2 to 5 seconds	No	C	Settings/Registration Basic Information
<Scrolling Speed>	<Slow>, < Standard >, <Fast>	No	C	Settings/Registration Basic Information

Volume Settings

7L2J-05Y

NOTE

- For information on the items ("A", "B", "C", and "No") in the "Import All Function" column, see [▶ Import All Function\(P. 296\)](#) .

Item	Setting Description	Can be set in Remote UI	Import All Function	Name of Item When Exporting with the Remote UI
<Entry Tone>	<Off>, <On>	Yes	C	Settings/Registration Basic Information
<Invalid Entry Tone>	<Off>, <On>	Yes	C	Settings/Registration Basic Information
<Restock Supplies Tone>	<Off>, <On> ,	Yes	C	Settings/Registration Basic Information
<Warning Tone>	<Off>, <On>	Yes	C	Settings/Registration Basic Information
<Job Done Tone>	<Off>, <On>	Yes	C	Settings/Registration Basic Information
<Energy Saver/Sleep Tone>	<Off>, <On>	Yes	C	Settings/Registration Basic Information
<Login Tone>	<Off>, <On>	Yes	C	Settings/Registration Basic Information

Adjustment/Maintenance

7L2J-060

- ▶ Maintenance(P. 325)
- ▶ Adjust Image Quality(P. 326)

Maintenance

7L2J-061

NOTE

- For information on the items ("A", "B", "C", and "No") in the "Import All Function" column, see [▶ Import All Function\(P. 296\)](#) .

Item	Setting Description	Can be set in Remote UI	Import All Function	Name of Item When Exporting with the Remote UI
<Clean Pressure Roller for Fixing>	-	No	No	-
<Low Toner Consumption Printing Mode>	<Off>, <On>	No	B	Settings/Registration Basic Information
<Control Detected Condensation>	<Off>, <On>	Yes	C	Settings/Registration Basic Information

Adjust Image Quality

7L2J-062

NOTE

- For information on the items ("A", "B", "C", and "No") in the "Import All Function" column, see [▶ Import All Function\(P. 296\)](#) .

Item	Setting Description	Can be set in Remote UI	Import All Function	Name of Item When Exporting with the Remote UI
<Full Calibration>	-	Yes	No	-
<Settings for Auto Full Calibration>	<Timing for Auto Full Calib. at Startup> : <After Printing First Job> , <When Turning Main Power ON>	Yes	A	Settings/Registration Basic Information
	<Frequency for Auto Full Calibration> : <Normal> , <High>	Yes	B	Settings/Registration Basic Information
<Adjust Print Position>				
<Sample Print>	<Yes>, <No>	No	No	-
<Multi-Purpose Tray>	<Adj. Vertically (1-Sd/2nd Sd for 2-Sd)>, <Adj. Horizontally (1-Sd/2nd Sd for 2-Sd)>, <Adj. Horizontally (1st Side for 2-Sided)>	Yes	No	-
<Drawer 1>	<Adj. Vertically (1-Sd/2nd Sd for 2-Sd)>, <Adj. Horizontally (1-Sd/2nd Sd for 2-Sd)>, <Adj. Horizontally (1st Side for 2-Sided)>	Yes	No	-
<Drawer 2>*	<Adj. Vertically (1-Sd/2nd Sd for 2-Sd)>, <Adj. Horizontally (1-Sd/2nd Sd for 2-Sd)>, <Adj. Horizontally (1st Side for 2-Sided)>	Yes	No	-
<Drawer 3>*	<Adj. Vertically (1-Sd/2nd Sd for 2-Sd)>, <Adj. Horizontally (1-Sd/2nd Sd for 2-Sd)>, <Adj. Horizontally (1st Side for 2-Sided)>	Yes	No	-
<Drawer 4>*	<Adj. Vertically (1-Sd/2nd Sd for 2-Sd)>, <Adj. Horizontally (1-Sd/2nd Sd for 2-Sd)>, <Adj. Horizontally (1st Side for 2-Sided)>	Yes	No	-
<Common>	<Adj. Vertically (1st Side for 2-Sided)>	Yes	No	-
<Adjust Toner Volume Used for Color Print>	<Off> , <Level 1>, <Level 2>	No	A	Settings/Registration Basic Information
<Special Processing>				
<Waterdrop Pattern Prevention Mode>	<Off> , <On>	Yes	B	Settings/Registration Basic Information
<Adjust Fixing Temperature>	<Low>, <Standard> , <High 1>, <High 2>	Yes	B	Settings/Registration Basic Information
<Curl Prevention Mode>	<Mode 1>: < Off > , < On > <Mode 2>: <Off> , <On>	Yes	B	Settings/Registration Basic Information

Settings/Registration

<Paper Slipping Prevention Mode>	<Off>, <Mode 1>, <Mode 2>	Yes	B	Settings/Registration Basic Information
<Auto Clean Secondary Transfer Roller>	<Off>, <On>	Yes	B	Settings/Registration Basic Information
<White Streak Prevention Mode>	<Off>, <On>	Yes	B	Settings/Registration Basic Information
<Correct Fixing When Using Plain Paper>	<Off>, <On>	Yes	B	Settings/Registration Basic Information
<Corr. Tail End Fix. When Using Plain Ppr>	<Off>, <On>	Yes	B	Settings/Registration Basic Information
<Plain Paper Fill Area Image Adjust. Mode>	<Off>, <On>	Yes	B	Settings/Registration Basic Information
<Heavy Paper Fill Area Image Adjust. Mode>	<Off>, <On>	Yes	B	Settings/Registration Basic Information
<Envelope Sealing Prevention Mode>	<Off>, <On>	Yes	B	Settings/Registration Basic Information

* Indicates items that appear only when the appropriate optional product is available for use or the appropriate setting is specified.

Function Settings

7L2J-063

- ▶ Common(P. 329)
- ▶ Printer(P. 331)
- ▶ Send(P. 344)
- ▶ Receive(P. 345)
- ▶ Access Files(P. 346)
- ▶ Print(P. 347)

Common

7L2J-064

NOTE

- For information on the items ("A", "B", "C", and "No") in the "Import All Function" column, see [▶ Import All Function\(P. 296\)](#) .

Item	Setting Description	Can be set in Remote UI	Import All Function	Name of Item When Exporting with the Remote UI
<Paper Feed Settings>				
<Paper Source Auto Selection>	<Printer>: <ul style="list-style-type: none"> <Multi-Purpose Tray>: <Off>, <On> Other: <Off>, <On> <Group Settings>: <Off>, <On> <Use Group>: <Off>, <On> 	Yes	B	Settings/Registration Basic Information
	<Access Stored Files>: <ul style="list-style-type: none"> <Multi-Purpose Tray>: <Off>, <On> Other: <Off>, <On> 	Yes	B	Settings/Registration Basic Information
	<Receive>: <ul style="list-style-type: none"> <Multi-Purpose Tray>: <Off>, <On> Other: <Off>, <On> 	Yes	B	Settings/Registration Basic Information
	<Other>: <ul style="list-style-type: none"> <Multi-Purpose Tray>: <Off>, <On> Other: <Off>, <On> 	Yes	B	Settings/Registration Basic Information
	<Optimal Productivity>: <ul style="list-style-type: none"> <Off>, <On> 	Yes	B	Settings/Registration Basic Information
<Switch Paper Feed Method>	<Multi-Purpose Tray> and Other: <Speed Priority>, <Print Side Priority>	Yes	B	Settings/Registration Basic Information
<Suspended Job Timeout>	<Off>, <On>	Yes	C	Settings/Registration Basic Information
	0 to 5 to 999 min.	Yes	C	Settings/Registration Basic Information
<Paper Output Settings>				
<Job Separator Between Jobs>	<Off>, <On>	Yes	C	Settings/Registration Basic Information
<Job Separator Between Copies>	<Off>, <On>	Yes	C	Settings/Registration Basic Information
	<Number of Copies> (1 to 10 to 9999)	Yes	C	Settings/Registration Basic Information
<Print Settings>				

Settings/Registration

<Print Priority>	<ul style="list-style-type: none"> • <Printer>: <1>, <2>, <3> • <Access Stored File>: <1>, <2>, <3> • <Other>: <1>, <2>, <3> 	Yes	C	Settings/Registration Basic Information
<Chrom. Color Conv. for Two Colors Print>	<All Chromatic Colors>, <Similar Chromatic Colors>	Yes	C	Settings/Registration Basic Information
<Auto Delete Suspended Jobs>	<Off>, <On>	Yes	C	Settings/Registration Basic Information
	0 to 5 to 999 min.	Yes	C	Settings/Registration Basic Information

Printer

7L2J-065

NOTE

- For information on the items ("A", "B", "C", and "No") in the "Import All Function" column, see [▶Import All Function\(P. 296\)](#) .

Item	Setting Description	Can be set in Remote UI	Import All Function	Name of Item When Exporting with the Remote UI
<Printer Settings>				
<Custom Settings>	▶ Custom Settings(P. 332)	-	-	-
<UFR II>	▶ UFR II(P. 335)	-	-	-
<PCL>	▶ PCL(P. 336)	-	-	-
<PS>	▶ PS(P. 338)	-	-	-
<Imaging>	▶ Imaging(P. 339)	-	-	-
<PDF>	▶ PDF(P. 340)	-	-	-
<XPS>	▶ XPS(P. 342)	-	-	-
<Utility>	▶ Utility(P. 343)	-	-	-
<Restrict Printer Jobs>	<On>, <Off>	Yes	C	Settings for Printer Settings
	When <On> is selected: <ul style="list-style-type: none"> <Select Jobs to Allow>: <Reserved Jobs> 	Yes	C	Settings for Printer Settings
<Switch Paper Source Auto Selection Mode>	< Short Edge Feed Paper Priority >, < Long Edge Feed Paper Priority >	Yes	C	Settings/Registration Basic Information
<Feed from MP Tray When No Paper Source>	<Off>, <On>	Yes	C	Settings/Registration Basic Information
<MP Tray Priority for Ppr Src Auto Select>	<Off>, <On>	Yes	C	Settings/Registration Basic Information
<PDL Selection (Plug and Play)>	<UFR II>, <PCL6>, <PS3>, <UFR II (V4)>, <PCL6 (V4)>	Yes	C	Settings for Printer Settings
<Ppr Size Mismatch for Free Size Ppr Src>	<Off>, <On>	Yes	C	Settings/Registration Basic Information
<Vertical Printing Priority for Free Size>	<Off>, <On>	Yes	C	Settings/Registration Basic Information
<PS Password Settings>	<SystemParams Password>, <StartJob Password>	Yes	C	Settings for Printer Settings
<Paper Feed Mode When Using PCL Emulation>	<Mode 0>, <Mode 1>, <Mode 2>	Yes	C	Settings/Registration Basic Information

Custom Settings

7L2J-066

NOTE

- For information on the items ("A", "B", "C", and "No") in the "Import All Function" column, see [Import All Function\(P. 296\)](#) .

Item	Setting Description	Can be set in Remote UI	Import All Function	Name of Item When Exporting with the Remote UI
<Copies>	1 to 9999	Yes	C	Settings for Printer Settings
<2-Sided Printing>	<On>, <Off>	Yes	C	Settings for Printer Settings
<Paper Feed>				
<Default Paper Feed Source>	<Auto>, <MP Tray>, <Drawer 1>, <Drawer 2>, <Drawer 3>	Yes	B	Settings for Printer Settings
<Default Paper Size>	<Letter>, <Legal>, <A4>, <A5>, <B5>, <A6>, <16K>, <Executive>, <Statement>, <Env. NAGAGATA 3>, <Env. YOGATANAGA3>, <Env. No. 10>, <Envelope ISO-C5>, <Envelope DL>, <Envelope Monarch>, <FOOLSCAP/FOLIO>, <FOOLSCAP (Australia)>, <LETTER (Government)>, <LEGAL (Government)>, <OFICIO>, <OFICIO (Brazil)>, <OFICIO (Mexico)>, <F4A>, <LEGAL (India)>	Yes	B	Settings for Printer Settings
<Default Paper Type>	<Thin>, <Plain 1>, <Plain 2>, <Plain 3>, <Heavy 1>, <Heavy 2>, <Heavy 3>, <Heavy 4>, <Heavy 5>, <Color>, <Recycled 1>, <Recycled 2>, <Labels>, <Letterhead 1>, <Letterhead 2>, <Letterhead 3>, <Letterhead 4>, <Letterhead 5>, <Letterhead 6>, <Letterhead 7>, <Bond 1>, <Bond 2>, <Envelope>	Yes	B	Settings for Printer Settings
<Paper Size Override>	<On>, <Off>	Yes	C	Settings for Printer Settings
<2nd Side of MP Tray 2-Sided Page>	<On>, <Off>	Yes	C	Settings for Printer Settings
<Paper Output>				
<Finishing>	<Finishing>:<Off>, <Collate>, <Group>	Yes	C	Settings for Printer Settings
<Print Quality>				
<Density>*1	<Cyan>: -8 to +8; 0 <Magenta>: -8 to +8; 0 <Yellow>: -8 to +8; 0 <Black>: -8 to +8; 0	Yes	C	Settings for Printer Settings
<Density (Fine Adjust)>*1	<Cyan>: <High>: -8 to +8; 0 <Medium>: -8 to +8; 0	Yes	C	Settings for Printer Settings

Settings/Registration

	<p><Low>: -8 to +8; 0 <Magenta>: <High>: -8 to +8; 0 <Medium>: -8 to +8; 0 <Low>: -8 to +8; 0 <Yellow>: <High>: -8 to +8; 0 <Medium>: -8 to +8; 0 <Low>: -8 to +8; 0 <Black>: <High>: -8 to +8; 0 <Medium>: -8 to +8; 0 <Low>: -8 to +8; 0</p>			
<Toner Save>	<On>, <Off>	Yes	C	Settings for Printer Settings
<Gradation>	<Standard>, <High 1>, <High 2>	Yes	B	Settings for Printer Settings
<Resolution>	<1200 dpi>, <600 dpi>	Yes	B	Settings for Printer Settings
<Sharpness (Photo)>	-1 to +3; 0	Yes	C	Settings for Printer Settings
<Special Smoothing Mode>	<Mode 1>, <Mode 2>, <Mode 3>, <Mode 4>, <Mode 5>, <Mode 6>	Yes	B	Settings for Printer Settings
<Toner Volume Correction>	<Normal>, <Grad. Priority>, <Text Priority>	Yes	C	Settings for Printer Settings
<Line Control>	<Res. Priority>, <Grad. Priority>	Yes	C	Settings for Printer Settings
<Width Adjustment>	<Width Adjustment>: <On>, <Off> <Target for Width Adjust.*1>: <Text>, <Line>, <Text and Line>, <All>	Yes	B	Settings for Printer Settings
<Advanced Smoothing>	<Advanced Smoothing>: <Off>, <Level 1>, <Level 2> <Apply to Graphics>: <On>, <Off> <Apply to Text>: <On>, <Off>	Yes	C	Settings for Printer Settings
<Gradation Smoothing>	<Gradation Smoothing>: <Off>, <Level 1>, <Level 2> <Apply to Graphics>: <On>, <Off> <Apply to Images>: <On>, <Off>	Yes	C	Settings for Printer Settings
<Enhance Text for B&W Print>	<On>, <Off>	Yes	C	Settings for Printer Settings
<Layout>				
<Binding Location>	<Long Edge>, <Short Edge>	Yes	C	Settings for Printer Settings
<Gutter>	-50.0 mm to +50.0 mm; 00.0 mm	Yes	C	Settings for Printer Settings
<Offset Short Edge (Front)>	-50.0 mm to +50.0 mm; 00.0 mm	Yes	C	Settings for Printer Settings
<Offset Long Edge (Front)>	-50.0 mm to +50.0 mm; 00.0 mm	Yes	C	Settings for Printer Settings

Settings/Registration

<Offset Short Edge (Back)>	-50.0 mm to +50.0 mm; 00.0 mm	Yes	C	Settings for Printer Settings
<Offset Long Edge (Back)>	-50.0 mm to +50.0 mm; 00.0 mm	Yes	C	Settings for Printer Settings
<Auto Error Skip>	<On>, < Off >	Yes	C	Settings for Printer Settings
<Timeout>	<Timeout>: < On >, <Off> <Timeout>: 5 seconds to 300 seconds; 15 seconds	Yes	C	Settings for Printer Settings
<Personality>*1	< Auto >, <PS>, <PCL>, <Imaging>, <PDF>, <XPS>	Yes	C	Settings for Printer Settings
<Mode Priority>*1	< None >, <PS>, <PCL>, <PDF>, <XPS>	Yes	C	Settings for Printer Settings
<Auto Select>*1	<PS>: < On >, <Off> <PCL>: < On >, <Off> <XPS>: < On >, <Off> <Imaging>: < On >, <Off> <PDF>: < On >, <Off>	Yes	C	Settings for Printer Settings
<Color Mode>	< Auto (Color/B&W) >, <Black & White>	Yes	C	Settings for Printer Settings
<Compressed Image Output>	< Output >, <Display Error>	Yes	C	Settings for Printer Settings
<Initialize>	<Yes>, <No>	No	No	-

*1 Indicates items that appear only when the appropriate optional product is available for use or the appropriate setting is specified.

NOTE

- For information on the items ("A", "B", "C", and "No") in the "Import All Function" column, see [▶ Import All Function\(P. 296\)](#) .

Item	Setting Description	Can be set in Remote UI	Import All Function	Name of Item When Exporting with the Remote UI
<Halftones>	<Err Diffusion(600dpi Only)>:<On>, <Off>	Yes	B	Settings for Printer Settings
	<Text>: <Resolution>, <Gradation>			
	<Graphics>: <Resolution>, <Gradation>			
	<Image>: <Resolution>, <Gradation>			
<Matching Method>	<General>, <Perceptual>, <Colorimetric>, <Vivid Photo>, <Download Profile>	Yes	C	Settings for Printer Settings
<Gray Compensation>	<Text>: <On>, <Off>	Yes	B	Settings for Printer Settings
	<Graphics>: <On>, <Off>			
	<Image>: <On>, <Off>			
<Paper Save>	<On>, <Off>	Yes	C	Settings for Printer Settings

NOTE

- For information on the items ("A", "B", "C", and "No") in the "Import All Function" column, see [▶ Import All Function\(P. 296\)](#) .

Item	Setting Description	Can be set in Remote UI	Import All Function	Name of Item When Exporting with the Remote UI
<Paper Save>	<On>, <Off>	Yes	C	Settings for Printer Settings
<Orientation>	<Portrait>, <Landscape>	Yes	C	Settings for Printer Settings
	<Internal>, <Soft/External>	No	C	Settings for Printer Settings
	0 to 104; 0 (If the Font Source setting is Internal.) 1 to 999; 1 (If the Font Source setting is Soft/External.)	Yes	C	Settings for Printer Settings
<Point Size>*1	4.00 to 999.75 <point>; 12.00 <point>	Yes	C	Settings for Printer Settings
<Pitch>*1	0.44 to 99.99 <dpi>; 10.00 <dpi>	Yes	C	Settings for Printer Settings
<Form Lines>	5 to 128 <lines>; 64 <lines>	Yes	C	Settings for Printer Settings
<Character Code>	<ARABIC8>, <DESKTOP>, <GREEK8>, <HEBREW7>, <HEBREW8>, <ISO4>, <ISO6>, <ISO11>, <ISO15>, <ISO17>, <ISO21>, <ISO60>, <ISO69>, <ISOCYR>, <ISOGRK>, <ISOHEB>, <ISOL1>, <ISOL2>, <ISOL5>, <ISOL6>, <ISOL9>, <LEGAL>, <MATH8>, <MCTEXT>, <MSPUBL>, <PC8>, <PC8DN>, <PC8GRK>, <PC8TK>, <PC775>, <PC850>, <PC851>, <PC852>, <PC858>, <PC862>, <PC864>, <PC866>, <PC1004>, <PIFONT>, <PSMATH>, <PSTEXT>, <ROMAN8>, <ROMAN9>, <VNINTL>, <VNMATH>, <VNUS>, <WIN30>, <WINARB>, <WINBALT>, <WINCYR>, <WINGRK>, <WINL1>, <WINL2>, <WINL5>	Yes	C	Settings for Printer Settings
<Custom Paper>	<On>, <Off>	Yes	C	Settings for Printer Settings
<Unit of Measure>*1	<Millimeters>, <inches>	Yes	C	Settings for Printer Settings
<X dimension>*1	127.0 mm to 355.6 mm; 355.6 mm	Yes	B	Settings for Printer Settings
<Y dimension>*1	76.2 mm to 216.0 mm; 216.0 mm	Yes	B	Settings for Printer Settings
<Append CR to LF>	<Yes>, <No>	Yes	C	Settings for Printer Settings
<Enlarge A4 Print Width>	<On>, <Off>	Yes	C	Settings for Printer Settings
<Halftones>	<Err Diffusion(600dpi Only) >: <On>, <Off>	Yes	B	Settings for Printer Settings
	<Text>: <Resolution>, <Gradation>			
	<Graphics>: <Resolution>, <Gradation>			
	<Image>: <Resolution>, <Gradation>			

Settings/Registration

<Matching Method>	<General>, <Perceptual>, <Colorimetric>, <Vivid Photo>, <Download Profile>	Yes	C	Settings for Printer Settings
<Gray Compensation>	<Text>: <On>, <Off>	Yes	B	Settings for Printer Settings
	<Graphics>: <On>, <Off>			
	<Image>: <On>, <Off>			
<BarDIMM>	<Enable>, <Disable>	Yes	C	Settings for Printer Settings
<FreeScape>*1	<Off>, <->, <">, <#>, <\$>, </>, <\>, <?>, <{>, <}>, < >	Yes	C	Settings for Printer Settings

*1 Indicates items that appear only when the appropriate optional product is available for use or the appropriate setting is specified.

NOTE

- For information on the items ("A", "B", "C", and "No") in the "Import All Function" column, see [▶ Import All Function\(P. 296\)](#) .

Item	Setting Description	Can be set in Remote UI	Import All Function	Name of Item When Exporting with the Remote UI
<Paper Save>	<On>, <Off>	Yes	C	Settings for Printer Settings
<Job Timeout>	0 to 3600 seconds; 0 second	Yes	C	Settings for Printer Settings
<Print PS Errors>	<On>, <Off>	Yes	C	Settings for Printer Settings
<Line Refinement>	<On>, <On (Slim)>, <Off>	Yes	C	Settings for Printer Settings
<Pure Black Text>	<On>, <Off>	Yes	C	Settings for Printer Settings
<Black Overprint>*1	<On>, <Off>	Yes	C	Settings for Printer Settings
<RGB Source Profile>	<sRGB>, <Gamma 1.5>, <Gamma 1.8>, <Gamma 2.4>, <None>, <Download Profile>	Yes	No	-
<CMYK Simulation Profile>	<JapanColor(Canon)>, <US Web Ctd(Canon)>, <Euro Standard>, <None>, <Download Profile>	Yes	No	-
<Use Grayscale Profile>	<On>, <Off>	Yes	No	-
<Output Profile>	<Text>: <Normal>, <Photo>, <TR Normal>, <TR Photo>, <Download Profile> <Graphics>: <Normal>, <Photo>, <TR Normal>, <TR Photo>, <Download Profile> <Image>: <Normal>, <Photo>, <TR Normal>, <TR Photo>, <Download Profile>	Yes	No	-
<Matching Method>	<Perceptual>, <Saturation>, <Colorimetric>	Yes	C	Settings for Printer Settings
<Halftones>	<Err Diffusion(600dpi Only)>: <On>, <Off>	Yes	B	Settings for Printer Settings
	<Text>: <Resolution>, <Gradation>			
	<Graphics>: <Resolution>, <Gradation>			
	<Image>: <Resolution>, <Gradation>			
<Brightness>*1	85% to 115%; 100%	Yes	C	Settings for Printer Settings
<Composite Overprint>	<On>, <Off>	Yes	C	Settings for Printer Settings
<Grayscale Conversion>*1	<sRGB>, <NTSC>, <Uniform RGB>	Yes	C	Settings for Printer Settings

*1 Indicates items that appear only when the appropriate optional product is available for use or the appropriate setting is specified.

Imaging

7L2J-06A

NOTE

- For information on the items ("A", "B", "C", and "No") in the "Import All Function" column, see [▶ Import All Function\(P. 296\)](#) .

Item	Setting Description	Can be set in Remote UI	Import All Function	Name of Item When Exporting with the Remote UI
<Image Orientation>	<Auto>, <Vertical>, <Horizontal>	Yes	C	Settings for Printer Settings
<Zoom>	<Off>, <Auto>	Yes	C	Settings for Printer Settings
<Print Position>	<Auto>, <Center>, <Top Left>	Yes	C	Settings for Printer Settings
<Show Warnings>	<On>, <Off>	Yes	C	Settings for Printer Settings
<Enlarge Print Area>	<On>, <Off>	Yes	C	Settings for Printer Settings
<Matching Method>	<General>, <Perceptual>, <Colorimetric>, <Vivid Photo>, <Download Profile>	Yes	C	Settings for Printer Settings
<Photo Correct.(Color Only)>				
<Photo Optimizer PRO>	<On>, <Off>	Yes	C	Settings for Printer Settings
<Red-Eye Correction>	<Red-Eye Correction>: <On>, <Off>	Yes	C	Settings for Printer Settings
	<Red-Eye Correction Level>: <Weak>, <Standard>, 			
<Face Brightener>	<Face Brightener>: <On>, <Off>	Yes	C	Settings for Printer Settings
	<Face Brightener Level>: <Weak>, <Standard>, 			
<Halftones>	<Resolution>, <Gradation>, <Error Diffusion>	Yes	B	Settings for Printer Settings
<Gray Compensation>	<On>, <Off>	Yes	B	Settings for Printer Settings
<Grayscale Conversion>*1	<sRGB>, <NTSC>, <Uniform RGB>	Yes	C	Settings for Printer Settings

*1 Indicates items that appear only when the appropriate optional product is available for use or the appropriate setting is specified.

NOTE

- For information on the items ("A", "B", "C", and "No") in the "Import All Function" column, see [▶ Import All Function\(P. 296\)](#) .

Item	Setting Description	Can be set in Remote UI	Import All Function	Name of Item When Exporting with the Remote UI
<Paper Save>	<On>, <Off>	Yes	C	Settings for Printer Settings
<Enlarge/Reduce to Fit Size>	<On>, <Off>	Yes	C	Settings for Printer Settings
<Enlarge Print Area>	<On>, <Off>	Yes	C	Settings for Printer Settings
<N on 1>	<Off>, <2 on 1>, <4 on 1>, <6 on 1>, <8 on 1>, <9 on 1>, <16 on 1>	Yes	C	Settings for Printer Settings
<Comment Print>	<Off>, <Auto>	Yes	C	Settings for Printer Settings
<Line Refinement>	<On>, <On (Slim)>, <Off>	Yes	C	Settings for Printer Settings
<Pure Black Text>	<On>, <Off>	Yes	C	Settings for Printer Settings
<Black Overprint>*1	<On>, <Off>	Yes	C	Settings for Printer Settings
<RGB Source Profile>	<sRGB>, <Gamma 1.5>, <Gamma 1.8>, <Gamma 2.4>, <None>, <Download Profile>	Yes	No	-
<CMYK Simulation Profile>	<JapanColor(Canon)>, <US Web Ctd(Canon)>, <Euro Standard>, <None>, <Download Profile>	Yes	No	-
<Use Grayscale Profile>	<On>, <Off>	Yes	No	-
<Output Profile>	<Text>: <Normal>, <Photo>, <TR Normal>, <TR Photo>, <Download Profile> <Graphics>: <Normal>, <Photo>, <TR Normal>, <TR Photo>, <Download Profile> <Image>: <Normal>, <Photo>, <TR Normal>, <TR Photo>, <Download Profile>	Yes	No	-
<Matching Method>	<Perceptual>, <Saturation>, <Colorimetric>	Yes	C	Settings for Printer Settings
<Halftones>	<Err Diffusion(600dpi Only)>: <On>, <Off>	Yes	B	Settings for Printer Settings
	<Text>: <Resolution>, <Gradation>			
	<Graphics>: <Resolution>, <Gradation>			
	<Image>: <Resolution>, <Gradation>			
<Brightness>*1	85% to 115%; 100%	Yes	C	Settings for Printer Settings
<Composite Overprint>	<On>, <Off>	Yes	C	Settings for Printer Settings
<Grayscale Conversion>*1	<sRGB>, <NTSC>, <Uniform RGB>	Yes	C	Settings for Printer Settings

*1 Indicates items that appear only when the appropriate optional product is available for use or the appropriate setting is specified.

NOTE

- For information on the items ("A", "B", "C", and "No") in the "Import All Function" column, see [▶ Import All Function\(P. 296\)](#) .

Item	Setting Description	Can be set in Remote UI	Import All Function	Name of Item When Exporting with the Remote UI
<Paper Save>	<On>, <Off>	Yes	C	Settings for Printer Settings
<Matching Method>	<General>, <Perceptual>, <Colorimetric>, <Vivid Photo>, <Download Profile>	Yes	C	Settings for Printer Settings
<Photo Correct. (Color Only)>				
<Photo Optimizer PRO>	<On>, <Off>	Yes	C	Settings for Printer Settings
<Red-Eye Correction>	<Red-Eye Correction>: <On>, <Off>	Yes	C	Settings for Printer Settings
	<Red-Eye Correction Level>*1: <Weak>, <Standard>, 			
<Face Brightener>	<Face Brightener>: <On>, <Off>	Yes	C	Settings for Printer Settings
	<Face Brightener Level>*1: <Weak>, <Standard>, 			
<Halftones>	<Err Diffusion(600dpi Only)>: <On>, <Off>	Yes	B	Settings for Printer Settings
	<Text>: <Gradation>, <Resolution>			
	<Graphics>: <Gradation>, <Resolution>			
	<Image>: <Gradation>, <Resolution>			
<Gray Compensation>	<Text>: <On>, <Off>	Yes	B	Settings for Printer Settings
	<Graphics>: <On>, <Off>			
	<Image>: <On>, <Off>			
<Grayscale Conversion>*1	<Text>: <sRGB>, <NTSC>, <Uniform RGB>	Yes	C	Settings for Printer Settings
	<Graphics>: <sRGB>, <NTSC>, <Uniform RGB>			
	<Image>: <sRGB>, <NTSC>, <Uniform RGB>			

*1 Indicates items that appear only when the appropriate optional product is available for use or the appropriate setting is specified.

NOTE

- For information on the items ("A", "B", "C", and "No") in the "Import All Function" column, see [▶ Import All Function\(P. 296\)](#) .

Item	Setting Description	Can be set in Remote UI	Import All Function	Name of Item When Exporting with the Remote UI
<Initialize PCL Storage>	<Yes>, <No>	No	No	-
<Initialize PS Storage>	<Yes>, <No>	No	No	-
<Reset Printer>	<Yes>, <No>	No	No	-

NOTE

- For information on the items ("A", "B", "C", and "No") in the "Import All Function" column, see [▶ Import All Function\(P. 296\)](#) .

Item	Setting Description	Can be set in Remote UI	Import All Function	Name of Item When Exporting with the Remote UI
<E-mail Settings>				
<Communication Settings>				
<Basic Settings>	<Use POP RX>: <Off>, <On>	Yes	C	Settings/Registration Basic Information
<POP Server Settings>	<POP Interval>: 0 to 99 minutes	Yes	C	Settings/Registration Basic Information
<Allow TLS>	<SMTP RX>: <Off>, <On>, <Always Use TLS>	Yes	C	Settings/Registration Basic Information
	<POP>: <Off>, <On>	Yes	C	Settings/Registration Basic Information
<Authentication Settings>	<POP Authentication Method>: <Standard>, <APOP>, <POP AUTH>	Yes	C	Settings/Registration Basic Information
<Confirm TLS Certificate for POP RX>	<Off>, <On>	Yes	C	Settings/Registration Basic Information
	When <On> is selected: <CN>: Off, On			

Receive

7L2J-06J

NOTE

- For information on the items ("A", "B", "C", and "No") in the "Import All Function" column, see [▶ Import All Function\(P. 296\)](#) .

Item	Setting Description	Can be set in Remote UI	Import All Function	Name of Item When Exporting with the Remote UI
<Common Settings>				
<Print on Both Sides>	<Off>, <On>	Yes	C	Settings/Registration Basic Information
<Reduce RX Size>	<Off>, <On>	Yes	C	Settings/Registration Basic Information
	<ul style="list-style-type: none"> <Reduction Mode>: <Auto>, <Fixed> 			
	<ul style="list-style-type: none"> <Reduction Ratio>: 75 to 90% to 97% 			
	<ul style="list-style-type: none"> <Reduction Direction>: <Vert. & Horiz.>, <Vertical Only> 			
<RX Page Footer>	<On>, <Off>	Yes	C	Settings/Registration Basic Information

Access Files

7L2J-06K

NOTE

- For information on the items ("A", "B", "C", and "No") in the "Import All Function" column, see [▶ Import All Function\(P. 296\)](#) .

Item	Setting Description	Can be set in Remote UI	Import All Function	Name of Item When Exporting with the Remote UI
<Common Settings>				
<Access Stored Files Settings>				
<Change Default Set. (Memory Media Print)>	<Paper>:<Multi-Purpose Tray>, <Drawer 1>, <Drawer 2>	No	C	Favorite Settings
	<Number of Copies>:<1>-<9999>	No	C	Favorite Settings
	<Color Mode>:<Color>, <Black & White>	No	C	Favorite Settings
	<2-Sided>:<Off>, <Book Type>, <Calendar Type>	No	C	Favorite Settings
	<Resolution>:<600 dpi>, <1200 dpi>	No	C	Favorite Settings
	<Enlarge Print Area>:<Off>, <On>	No	C	Favorite Settings
	<Set PDF/XPS Details> <N on 1>: <Off>, <2 on 1>, <4 on 1>, <6 on 1>, <8 on 1>, <9 on 1>, <16 on 1> <Print Range>: <All Pages>, <Specified Pages> <Fit Paper Size>: <Off>, <On> <Collate>: <Off>, <On> <Halftones>: <Error Diffusion> (<Off>, <On>), <Resolution/Gradation> (<Text>(<Resolution>,<Gradation>), <Graphic Mode> (<Resolution>, <Gradation>), <Image>(<Resolution>, <Gradation>))	No	C	Favorite Settings
<Set JPEG/TIFF Details> <Print Range>: <All Pages>, <Specified Pages> <Enlarge/Reduce>: <Off>, <Auto> <Image Orientation>: <Auto>, <Always Portrait>, <Always Landscape> <Print Position>: <Auto>, <Always Center>, <Always Top Left> <Halftones>: <Resolution>, <Gradation>, <Error Diffusion>	No	C	Favorite Settings	
<Memory Media Settings>				
<Use Print Function>	<Use Print Function>: <Off>, <On>	Yes	C	Settings/ Registration Basic Information
<Select Option When Connecting Mem. Media>	<Off>, <On>	No	C	Settings/ Registration Basic Information

NOTE

- For information on the items ("A", "B", "C", and "No") in the "Import All Function" column, see [▶ Import All Function\(P. 296\)](#) .

Item	Setting Description	Can be set in Remote UI	Import All Function	Name of Item When Exporting with the Remote UI
<Job Storage Period>	10, 20, 30 min., 1, 2, 3, 6, 12 hr., 1, 2, 3 days	No	C	Settings/Registration Basic Information
<Job List Display Settings>	<Personal>: <On>, <Off> <Shared>: <On>, <Off>	No	C	Settings/Registration Basic Information

Management Settings

7L2J-06R

- ▶ **User Management(P. 349)**
- ▶ **Device Management(P. 350)**
- ▶ **License/Other(P. 351)**
- ▶ **Data Management(P. 352)**
- ▶ **Security Settings(P. 353)**

User Management

7L2J-06S

NOTE

- For information on the items ("A", "B", "C", and "No") in the "Import All Function" column, see [▶ Import All Function\(P. 296\)](#) .

Item	Setting Description	Can be set in Remote UI	Import All Function	Name of Item When Exporting with the Remote UI
<Authentication Management>				
<Set Administrator Password>	(32 characters maximum)	Yes	C	Authentication User Management
<Set Administrator PIN>	<Off>, <On>	Yes	C	Settings/Registration Basic Information
	When <On> is selected: PIN Entry (7 digits maximum)			
<System Manager Information Settings>	<System Manager ID and PIN>, <System Manager Name>, <E-Mail Address>, <Contact Information>, <Comment>	Yes	C	Department ID Management Settings
	When <System Manager ID and PIN> is selected: <System Manager ID>: 7654321 (Seven digits maximum) <System Manager PIN>: 7654321 (Seven digits maximum)			
<Department ID Management>	<Off>, <On>	Yes	C	Department ID Management Settings

Device Management

7L2J-06U

NOTE

- For information on the items ("A", "B", "C", and "No") in the "Import All Function" column, see [▶ Import All Function\(P. 296\)](#) .

Item	Setting Description	Can be set in Remote UI	Import All Function	Name of Item When Exporting with the Remote UI
<Device Information Settings>	<Device Name>	Yes	A	Settings/Registration Basic Information
	<Location>	Yes	A	Settings/Registration Basic Information
<Display Job Status Before Authentication>	<Off>, <On>	Yes	C	Settings/Registration Basic Information
<Restrict Access to Other User Jobs>	<Print>: <Off>, <On> <Receive>: <Off>, <On>	Yes	C	Settings/Registration Basic Information
<Display Job Log>	<Off>, <On>	Yes	C	Settings/Registration Basic Information
	When <Off> is selected: <ul style="list-style-type: none"> <Rtrv Log w/Mngt Sftwr>: <Do Not Allow>, <Allow> 	Yes	C	Settings/Registration Basic Information
<Save Audit Log>	<Off>, <On>	Yes	C	Settings/Registration Basic Information
<Retrieve Network Authentication Log>	<Off>, <On>	Yes	C	Settings/Registration Basic Information
<Restrict Service Representative Access>	<Off>, <Off (Auth. Needed)>, <On>	Yes	C	Settings/Registration Basic Information
<Prohibit Initialization of Admin. Pswrd.>	<Off>, <On>	No	No	-
<Restrict Special Mode Operations>	<Off>, <On>	No	C	Settings/Registration Basic Information

License/Other

7L2J-06W

NOTE

- For information on the items ("A", "B", "C", and "No") in the "Import All Function" column, see [▶ Import All Function\(P. 296\)](#) .

Item	Setting Description	Can be set in Remote UI	Import All Function	Name of Item When Exporting with the Remote UI
<Register License>	24 characters maximum	No	No	-
<AddOn Settings>				
<Use TLS>	<Off>, <On>	Yes	C	Settings/Registration Basic Information
<Confirm TLS Certificate Using AddOn App>	<Off>, <On>	Yes	C	Settings/Registration Basic Information
	When <On> is selected: <ul style="list-style-type: none"> <Add Items to Verify>: <CN>: Off, On 	Yes	C	Settings/Registration Basic Information
<Use DNS Caching>	<On (Unlimited Use)>, <On (Specify Period)>, <Off>	Yes	C	Settings/Registration Basic Information
	When <On (Specify Period)> is selected: <ul style="list-style-type: none"> <Expires>: 1 to 60 to 120 sec. 	Yes	C	Settings/Registration Basic Information
<Use Proxy Settings of This Device>	<Off>, <On>	Yes	C	Settings/Registration Basic Information
<Add X-FRAME-OPTIONS to HTTP Header>	<Off>, <On>	Yes	C	Settings/Registration Basic Information
<Remote UI Settings>				
<Enable Remote UI>	<Off>, <On>	No	C	Settings/Registration Basic Information
<Use TLS>	<Off>, <On>	Yes	C	Settings/Registration Basic Information
<Register/Update Software>	<Software Management Settings>	Yes	No	-
<Start Setup Guide>	<Yes>, <No>	No	No	-

Data Management

7L2J-06X

NOTE

- For information on the items ("A", "B", "C", and "No") in the "Import All Function" column, see [▶Import All Function\(P. 296\)](#) .

Item	Setting Description	Can be set in Remote UI	Import All Function	Name of Item When Exporting with the Remote UI
<Import/Export>				
<Import from USB Memory>	<Yes>, <No> <Password>	No	No	-
<Export to USB Memory>	<Password>	No	No	-
<Restrict Import/Export from Web Service>	<Off>, <On>	Yes	C	Settings/Registration Basic Information
<Initialize Network Settings>	<Yes>, <No>	No	No	-
<Initialize All Set. without Network Set.>	<Yes>, <No>	No	No	-
<Initialize All Data/Settings>	<Yes>, <No>	No	No	-

Security Settings

7L2J-06Y

NOTE

- For information on the items ("A", "B", "C", and "No") in the "Import All Function" column, see [▶ Import All Function\(P. 296\)](#) .

Item	Setting Description	Can be set in Remote UI	Import All Function	Name of Item When Exporting with the Remote UI
<System Verification Settings>				
<Verify System at Startup>	<Off>, <On>	Yes	C	Settings/Registration Basic Information
<McAfee Embedded Control>	<Off>, <On>	Yes	C	Settings/Registration Basic Information

Output Report

7L2J-070

NOTE

- For information on the items ("A", "B", "C", and "No") in the "Import All Function" column, see [▶ Import All Function\(P. 296\)](#) .

Item	Setting Description	Can be set in Remote UI	Import All Function	Name of Item When Exporting with the Remote UI
<Default Settings for Output Report>				
<2-Sided Printing>	<Off>, <On>	Yes	C	Settings/Registration Basic Information
<Print List>				
<Consumables Status Report>	<Yes>, <No>	Yes	No	-
<User Data List>	<Yes>, <No>	Yes	No	-
<Network User Data List>	<Yes>, <No>	Yes	No	-
<Communication Management Report>	<Yes>, <No>	Yes	No	-
<Page Count List>	<All>: <Yes>, <No> <Black & White Only>: <Yes>, <No> <Color Only>: <Yes>, <No>	Yes	No	-
<Counter Report>	<Yes>, <No>	Yes	No	-
<Print Log List>	<Printer>: <Yes>, <No> <Received Job Print>: <Yes>, <No> <Report Print>: <Yes>, <No>	Yes	No	-
<IPSec Policy List>	<Yes>, <No>	Yes	No	-
<AddOn System Information>	<Yes>, <No>	Yes	No	-
<Import Result Report>	<Yes>, <No>	Yes	No	-
<Toner Cartridge Log Report>	<Yes>, <No>	Yes	No	-
<PCL>	<Configuration Page>: <Yes>, <No> : <Yes>, <No>	Yes	No	-
<PS>	<Configuration Page>: <Yes>, <No> : <Yes>, <No>	Yes	No	-

<Preferences>

7L2J-071

Item	Description
▶<Display Settings>(P. 356)	This section describes the display settings.
▶<Timer/Energy Settings>(P. 358)	This section describes the timer settings and energy settings.
▶<Network>(P. 362)	This section describes the network settings.
▶<External Interface>(P. 374)	This section describes the USB settings.
▶<Accessibility>(P. 376)	This section describes settings for improving accessibility, such as inverting the screen colors and setting the message display time.
▶<Volume Settings>(P. 377)	This section describes the sound volume settings.

<Display Settings>

7L2J-072

This section describes the display settings.

<Button Display Order on Home Screen>

<Set> ► <Preferences> ► <Display Settings>

You can rearrange the order in which the buttons appear on the <Home> screen. **►Customizing the <Home> Screen(P. 101)**

<Default Screen After Startup/Restoration>

<Set> ► <Preferences> ► <Display Settings>

You can set the default screen displayed at startup/restoration.

<Language>

<Set> ► <Preferences> ► <Display Settings>

You can select the language displayed on the display.

NOTE

- Some messages may not be displayed properly in the selected language. In this case, restart the machine. Some messages may not change even after the machine is restarted.

<Millimeter/Inch Entry Switch>

<Set> ► <Preferences> ► <Display Settings>

You can set whether to enter numeric values in millimeters or inches on the various numeric entry screens.

<Confirm When Loading Paper in Drawer>

<Set> ► <Preferences> ► <Display Settings>

You can set whether to display a screen prompting the user to check the paper settings when the paper drawer is inserted into the machine.

NOTE

- The screen prompting the user to check the paper settings is not displayed in the following cases.
 - When paper is loaded because it has run out during a job
 - When a paper jam is removed
 - When a screen for executing, canceling, or confirming jobs is displayed
 - When the paper is set in <Paper Settings> on the <Home> screen

<IP Address Display Settings>

<Set> ► <Preferences> ► <Display Settings>

You can set whether to display the IP address on the <Status Monitor> screen.

NOTE

- This setting is only valid when <Use IPv4> is set to <On>.

<Display Mobile Portal>

<Set> ▶ <Preferences> ▶ <Display Settings>

You can set whether to display <Mobile Portal> on the <Home> screen.

<Timer/Energy Settings>

7L2J-073

This section describes the timer settings and energy settings.

<Date/Time Settings>

<Set> ▶ <Preferences> ▶ <Timer/Energy Settings>

Setting the current date and time is very important. For instructions on how to configure the setting, see [▶ Setting the Date/Time\(P. 7\)](#) .

<Time Format>

<Set> ▶ <Preferences> ▶ <Timer/Energy Settings>

You can set whether to display the time in 24-hour notation or 12-hour notation.

NOTE

- You can also specify to automatically synchronize the date and time with a server on the network using SNTP. [▶ Making SNTP Settings\(P. 40\)](#)

<Quick Startup Settings for Main Power>

<Set> ▶ <Preferences> ▶ <Timer/Energy Settings>

If you set this function to <On>, you can reduce the time it takes until you can perform operations on the screen after the power is turned ON.

NOTE

- When this function is enabled
 - Standby power is consumed even when the power is turned OFF.
 - A tone sounds when the machine is turned ON, or when the machine is turned OFF if you set <Energy Saver/Sleep Tone> to <On>. (However, the machine may not be able to start up quickly and the tone may not sound, depending on the status of the machine.)
- Even if this function is set to <On>, the machine does not startup quickly in the following situations:
 - When any of the network settings below are set to 'On'
 - Wi-Fi
 - When turning ON the main power of the machine after turning OFF the main power in any of the conditions below
 - More than 110 hours have elapsed after quick startup
 - Operating jobs
 - Jobs are reserved
 - Backing up data
 - Accessing to the machine via network
 - After specifying settings which require restarting the machine
 - Error is occurred
 - Using the Limited Functions mode

- The power cord is disconnected after turning OFF the main power
- AddOn applications which do not support quick startup are installed on the machine
- When turning ON the main power of the machine in 20 seconds after turning OFF the main power
- When turning ON the main power of the machine after eight hours have passed since the machine was turned OFF
- When turning ON the main power of the machine after turning OFF the main power from the Remote UI

<Auto Reset Time>

<Set> ► <Preferences> ► <Timer/Energy Settings>

You can specify the time period in which you are logged out and the display returns to the default setting automatically.

NOTE

- If the login service is being used, the machine automatically logs out the user when the Auto Reset Time elapses.
- The screen displayed after the Auto Reset initiates differs depending on the following settings.
 - Setting 1: The settings in <Function After Auto Reset>
 - When <Default Function> is set, the screen specified in <Default Screen After Startup/Restoration> (Setting 2) is displayed.
 - When <Selected Function> is set, the function before the Auto Reset initiates is displayed. (The specified settings and entered values for each function will be cleared.) However, the <Selected Function> settings may not be correctly reflected, and the screen specified in <Default Screen After Startup/Restoration> may be displayed.
 - Setting 2: The settings in <Default Screen After Startup/Restoration>

<Restrict Auto Reset Time>

<Set> ► <Preferences> ► <Timer/Energy Settings>

If you set this function to <On>, general users become unable to set <Auto Reset Time> and <Function After Auto Reset>.

<Function After Auto Reset>

<Set> ► <Preferences> ► <Timer/Energy Settings>

You can set whether the default screen set for <Default Screen After Startup/Restoration> in <Display Settings> or the immediately previous screen is displayed at startup after the Auto Reset initiates.

<Auto Shutdown Time>

<Set> ► <Preferences> ► <Timer/Energy Settings>

With the Auto Shutdown, if the display of the machine is idle for a certain period of time after it has entered the Sleep mode, the machine automatically shuts down.



- Even when operating the machine from the Remote UI, the machine automatically shuts down if the control panel of the machine is idle for a certain period of time. A malfunction may occur particularly if the machine automatically shuts down while importing. Set <Auto Shutdown Time> to <0> when importing data.

NOTE

- The Auto Shutdown may not be performed, depending on the usage conditions of the machine.

<Auto Shutdown Weekly Timer>

<Set> ▶ <Preferences> ▶ <Timer/Energy Settings>

You can set the time that the machine automatically shuts down each day of the week. If you use this function, you do not have to shut down the machine manually every day.

NOTE

- If both <Auto Shutdown Time> and <Auto Shutdown Weekly Timer> are set, priority is given to <Auto Shutdown Time>.

<Allow Sleep Mode During Error>

<Set> ▶ <Preferences> ▶ <Timer/Energy Settings>

You can set whether the machine enters the Auto Sleep mode when an error has occurred.

NOTE

- Disable this setting to prevent the machine from entering the Sleep mode.

<Auto Sleep Time>

<Set> ▶ <Preferences> ▶ <Timer/Energy Settings>

You can set the time until the machine automatically enters the Sleep mode if no operations are performed.

NOTE

- It is recommended that the default value is used for this setting.

<Sleep Mode Energy Use>

<Set> ▶ <Preferences> ▶ <Timer/Energy Settings>

You can set the amount of energy that the machine consumes when it is in the Sleep mode.

IMPORTANT

- If the machine is connected to a computer using a USB cable, depending on the timing for entering the sleep mode, the machine may be unable to receive data correctly. Reactivate the machine from the sleep mode, then execute the job again.
- The energy consumption level may be the same as when <High> is set even when <Low> is set, depending on the status of the machine.

NOTE

- If the energy consumption level is set to <Low>, communication failure may occur, depending on the network utility software you are using. To avoid this, press the Energy Saver key to cancel the Sleep mode before using the machine.

<Auto Sleep Weekly Timer>

<Set> ► <Preferences> ► <Timer/Energy Settings>

You can set the time that the machine automatically enters the Sleep mode each day of the week.

NOTE

- If you set both the <Auto Sleep Time> and <Auto Sleep Weekly Timer>, the <Auto Sleep Time> setting is given priority.

<Time Settings for Auto Adjust Gradation>

<Set> ► <Preferences> ► <Timer/Energy Settings>

You can automatically perform the automatic gradation adjustment at a set time every day.

<Energy Saver/Sleep Mode Exit Time Set.>

<Set> ► <Preferences> ► <Timer/Energy Settings>

You can set the time for recovering from the Sleep mode.

<Network>

This section describes the network settings.

<Output Report>

<Set> ▶ <Preferences> ▶ <Network>

You can print the settings in <Network>. [▶<Output Report>\(P. 403\)](#)

NOTE

- This setting can only be specified from the Remote UI.

<Confirm Network Connection>

<Set> ▶ <Preferences> ▶ <Network>

If this setting is set to <On>, you can change network settings. If errors related to network connections occur, an error message appears on the screen of the machine.

<Use IPv4>

<Set> ▶ <Preferences> ▶ <Network> ▶ <TCP/IP Settings> ▶ <IPv4 Settings>

Set whether to use IPv4. [▶Setting an IPv4 Address\(P. 23\)](#)

<IP Address Settings>

<Set> ▶ <Preferences> ▶ <Network> ▶ <TCP/IP Settings> ▶ <IPv4 Settings>

Specify the IPv4 address. [▶Setting an IPv4 Address\(P. 23\)](#)

<DHCP Option Settings>

<Set> ▶ <Preferences> ▶ <Network> ▶ <TCP/IP Settings> ▶ <IPv4 Settings>

Specify the optional settings for DHCP. [▶Making DNS Settings\(P. 31\)](#)

<Perform DNS Dynamic Update>

<Set> ▶ <Preferences> ▶ <Network> ▶ <IPv4 Settings> / <IPv6 Settings>

Specify whether to perform the automatic update when the mapping between the host name and IP address is changed on an environment such as DHCP. [▶Making DNS Settings\(P. 31\)](#)

NOTE

- This setting can only be specified from the Remote UI.

<PING Command>

<Set> ▶ <Preferences> ▶ <Network> ▶ <TCP/IP Settings> ▶ <IPv4 Settings>

Tests whether the IPv4 address is set correctly. [▶Conducting a Connection Test for an IPv4 Address\(P. 24\)](#)

<Use IPv6>

<Set> ► <Preferences> ► <Network> ► <TCP/IP Settings> ► <IPv6 Settings>

Specify whether to use IPv6. [▶Setting an IPv6 Address\(P. 25\)](#)

<Use Stateless Address>

<Set> ► <Preferences> ► <Network> ► <IPv6 Settings>

Specify whether to use the IPv6 stateless address. [▶Setting an IPv6 Address\(P. 25\)](#)

NOTE

- This setting can only be specified from the Remote UI.

<Use Manual Address>

<Set> ► <Preferences> ► <Network> ► <IPv6 Settings>

Specify the IPv6 address manually. [▶Setting an IPv6 Address\(P. 25\)](#)

NOTE

- This setting can only be specified from the Remote UI.

<Use DHCPv6>

<Set> ► <Preferences> ► <Network> ► <IPv6 Settings>

Specify whether to obtain the IPv6 address from the DHCP server. [▶Setting an IPv6 Address\(P. 25\)](#)

NOTE

- This setting can only be specified from the Remote UI.

<Only Retrieve Stateful Address Prefix>

<Set> ► <Preferences> ► <Network> ► <TCP/IP Settings> ► <IPv6 Settings>

Specify whether to obtain only the former half of the stateful address from the DHCP server by using DHCPv6.

<DHCP Option Settings>

<Set> ► <Preferences> ► <Network> ► <TCP/IP Settings> ► <IPv6 Settings>

Specify the optional settings for DHCP. [▶Making DNS Settings\(P. 31\)](#)

<DNS Server Address Settings>

<Set> ► <Preferences> ► <Network> ► <TCP/IP Settings> ► <DNS Settings>

Specify the DNS server address settings. [▶Making DNS Settings\(P. 31\)](#)

<mDNS Settings>

<Set> ▶ <Preferences> ▶ <Network> ▶ <TCP/IP Settings> ▶ <DNS Settings>

Specify settings for using the DNS function on a system that does not have a DNS server. **▶ Making DNS Settings(P. 31)**

<LPD Print Settings>

<Set> ▶ <Preferences> ▶ <Network> ▶ <TCP/IP Settings>

Specify settings for LPD printing. To use LPD printing, select <On> and set the time until the job is automatically canceled when the print data cannot be received due to a communication error, etc.

NOTE

- Banner pages are set to be output by print job. Even if <Output LPD Banner Page> is set to <On>, banner pages are not output for print jobs that are set to not output a banner page.

<RAW Print Settings>

<Set> ▶ <Preferences> ▶ <Network> ▶ <TCP/IP Settings>

Specify settings for RAW printing. To use RAW printing, select <On> and set whether to use bidirectional communication and the time until the job is automatically canceled when the print data cannot be received due to a communication error, etc.

<SNTP Settings>

<Set> ▶ <Preferences> ▶ <Network> ▶ <TCP/IP Settings>

Specify settings for Simple Network Time Protocol (SNTP). **▶ Making SNTP Settings(P. 40)**

<FTP Print Settings>

<Set> ▶ <Preferences> ▶ <Network> ▶ <TCP/IP Settings>

Specify settings for FTP printing. To use FTP printing, select <On>, and set <User Name> and <Password> as necessary.

<Use UTF-8 to Display FTP Print Job Name>

<Set> ▶ <Preferences> ▶ <Network> ▶ <TCP/IP Settings>

Specify whether to use UTF-8 for displaying file names when you perform FTP print.

<WSD Settings>

<Set> ▶ <Preferences> ▶ <Network> ▶ <TCP/IP Settings>

Specify the WSD settings. To use WSD (Web Service on Devices) for the print application, set <Use WSD Printing> to <On>. To use WSD to retrieve the information for the machine, set <Use WSD Browsing> to <On>.

NOTE

- If you set <Use WSD Printing> to <On>, <Use WSD Browsing> and <Use HTTP> are also set to <On>.

<IPP Print Settings>

<Set> ► <Preferences> ► <Network> ► <TCP/IP Settings>

Specify settings for IPP printing. To use IPP printing, select <On> and set whether to only allow communication data encrypted with TLS (IPP printing) and whether to use IPP authentication.

NOTE

- If you set this to <On>, <Use HTTP> is also set to <On>.
- To perform IPPS printing, a key pair to use is required. You can use a preinstalled key pair or an original key pair generated by the machine as the key to use. For information on the key to use and the method for generating an original key pair, see [▶Generating the Key and Certificate for Network Communication\(P. 227\)](#) or [▶Registering a Key and Certificate for Network Communication\(P. 232\)](#) . If you select <RSA> for <Key Algorithm> when generating the key to use for network communication, set a key length of <1024-bit> or longer. IPPS printing may not be able to be performed correctly if a key length of <512-bit> is set, depending on the operating system you are using.
- To use the IPP authentication function by setting <Use Authentication> to <On>, the user information of the machine is used as the user and password for IPP authentication. Make sure to register the user information in advance when using the IPP authentication function. [▶Registering User Information in the Local Device\(P. 177\)](#)

<Multicast Discovery Settings>

<Set> ► <Preferences> ► <Network> ► <TCP/IP Settings>

Specify the multicast discovery settings. [▶Monitoring the Machine From Device Management Systems\(P. 41\)](#)

<Sleep Mode Notification Settings>

<Set> ► <Preferences> ► <Network> ► <TCP/IP Settings>

Specify settings for multicast sending of the Sleep mode notifications on the network.

NOTE

- This setting can only be specified from the Remote UI.

<Use HTTP>

<Set> ► <Preferences> ► <Network> ► <TCP/IP Settings>

Enable or disable HTTP setting.

IMPORTANT

- By specifying this setting as <On>, you can open a necessary port. However, it is recommended that you specify it as <Off>, if a port is not used. If you leave the port open, an unauthorized user may access the machine.

NOTE

If you set this to <Off>, the following settings are also set to <Off>.

- <Remote UI Settings>
- <IPP Print Settings>
- <Use WSD Printing> in <WSD Settings>
- <Use WebDAV Server>

<TLS Settings>

<Set> ▶ <Preferences> ▶ <Network> ▶ <TCP/IP Settings>

You can set a key pair, TLS version, and encryption algorithm to use after confirming that a machine uses TLS encrypted communication. ▶ **Configuring the Key and Certificate for TLS(P. 223)**

NOTE

- This setting can only be specified from the Remote UI.

<Proxy Settings>

<Set> ▶ <Preferences> ▶ <Network> ▶ <TCP/IP Settings>

Specify settings for the proxy. ▶ **Setting a Proxy(P. 221)**

<Confirm Auth Info When in Auth Mngt Mode>

<Set> ▶ <Preferences> ▶ <Network> ▶ <TCP/IP Settings>

Specify whether the machine checks authentication information when you print using the V4 printer driver.

NOTE

- If there is no key to use for TLS communication or it is corrupted, this setting is disabled. ▶ **Configuring the Key and Certificate for TLS(P. 223)**

<IPSec Settings>

<Set> ▶ <Preferences> ▶ <Network> ▶ <TCP/IP Settings>

Specify the IPSec settings. ▶ **Configuring the IPSec Settings(P. 244)**

<IPSec Policy List>

<Set> ▶ <Preferences> ▶ <Network>

You can register IPSec policies and set priorities.

NOTE

- This setting can only be specified from the Remote UI.

<TCP/IP Option Settings>

<Set> ► <Preferences> ► <Network> ► <TCP/IP Settings>

Specify the TCP option window scale and MTU size.

NOTE

- This setting can only be specified from the Remote UI.

<SNMP Settings>

<Set> ► <Preferences> ► <Network>

Specify the SNMP settings. **Monitoring and Controlling the Machine with SNMP(P. 34)**

<Format Host Resources MIB to RFC2790>

<Set> ► <Preferences> ► <Network>

Specify whether the host resources MIB is compliant with the specifications of RFC2790.

<Dedicated Port Settings>

<Set> ► <Preferences> ► <Network>

Specify whether to configure/refer to detailed information of the machine from the Canon drivers or utility software.

NOTE

- If the setting is set to <Off>, some application that uses dedicated port may not be used.
- This setting can only be specified from the Remote UI.

<Dedicated Port Authentication Method>

<Set> ► <Preferences> ► <Network>

Specify the authentication method for the dedicated port.

NOTE

- If the setting is set to <Mode 2>, communication using a dedicated port uses a secure mode. Accordingly, you may not be able to connect from device management software or drivers, etc.
- This setting can only be specified from the Remote UI.

<Use Spool Function>

<Set> ► <Preferences> ► <Network>

Specify whether to spool print jobs that are sent to the machine in the storage device of the machine.

<Receive in Parallel>

<Set> ▶ <Preferences> ▶ <Network>

Specify whether to efficiently process the data when multiple print jobs are sent to the machine. If this is set to <Off>, the data is printed in the order of reception, but the print speed may be slower.

<Waiting Time for Connection at Startup>

<Set> ▶ <Preferences> ▶ <Network>

Specify the waiting time for connecting to a network from when the machine starts. [▶Setting the Wait Time When Connecting to a Network\(P. 30\)](#)

<Ethernet Driver Settings>

<Set> ▶ <Preferences> ▶ <Network>

Specify the Ethernet driver settings. [▶Making Ethernet Settings\(P. 29\)](#)

<IEEE 802.1X Settings>

<Set> ▶ <Preferences> ▶ <Network>

Specify the settings for IEEE 802.1X. [▶Configuring the IEEE 802.1X Authentication Settings\(P. 251\)](#)

IMPORTANT

- If you set <IEEE 802.1X Settings> to <On>, the machine will not completely enter the Sleep mode.

<Outbound Filter>

<Set> ▶ <Preferences> ▶ <Network> ▶ <Firewall Settings> ▶ <IPv4 Address Filter>

Specify the outbound filter. [▶Specifying IP Addresses in Firewall Settings\(P. 213\)](#)

<Inbound Filter>

<Set> ▶ <Preferences> ▶ <Network> ▶ <Firewall Settings> ▶ <IPv4 Address Filter>

Specify the inbound filter. [▶Specifying IP Addresses in Firewall Settings\(P. 213\)](#)

<Always Allow Sending/Receiving Using ICMP>

<Set> ▶ <Preferences> ▶ <Network> ▶ <Firewall Settings> ▶ <IPv4 Address Filter> ▶ <IPv4 Address ICMP Settings>

Specify whether to always allow ICMP communication.

NOTE

- This setting can only be specified from the Remote UI.

<Outbound Filter>

<Set> ▶ <Preferences> ▶ <Network> ▶ <Firewall Settings> ▶ <IPv6 Address Filter>

Specify the outbound filter. [▶Specifying IP Addresses in Firewall Settings\(P. 213\)](#)

<Inbound Filter>

<Set> ► <Preferences> ► <Network> ► <Firewall Settings> ► <IPv6 Address Filter>

Specify the inbound filter. [►Specifying IP Addresses in Firewall Settings\(P. 213\)](#)

<Always Allow Sending/Receiving Using ICMP>

<Set> ► <Preferences> ► <Network> ► <Firewall Settings> ► <IPv6 Address Filter> ► <IPv6 Address ICMP Settings>

Specify whether to always allow ICMPv6 communication.

NOTE

- This setting can only be specified from the Remote UI.

<Outbound Filter>

<Set> ► <Preferences> ► <Network> ► <Firewall Settings> ► <MAC Address Filter>

Specify the outbound filter. [►Specifying MAC Addresses in Firewall Settings\(P. 216\)](#)

<Inbound Filter>

<Set> ► <Preferences> ► <Network> ► <Firewall Settings> ► <MAC Address Filter>

Specify the inbound filter. [►Specifying MAC Addresses in Firewall Settings\(P. 216\)](#)

<IP Address Block Log>

<Set> ► <Preferences> ► <Network> ► <Firewall Settings>

Displays the log for blocking with an IP address filter. [►Specifying IP Addresses in Firewall Settings\(P. 213\)](#)

NOTE

- This setting can only be specified from the Remote UI.

<Session Settings>

<Set> ► <Preferences> ► <Network>

Specify the timeout time after logging in to the Remote UI.

NOTE

- This setting can only be specified from the Remote UI.

<Use Mopria>

<Set> ► <Preferences> ► <Network>

Specify whether to print data directly from mobile devices that support Mopria®, such as smartphones and tablets. **▶ Utilizing the Machine through Applications(P. 147)**

<Use AirPrint>

<Set> ▶ <Preferences> ▶ <Network>

Specify whether to print directly from an iPhone, iPad, iPod Touch, or Mac that supports AirPrint. **▶ Using AirPrint(P. 149)**

<Display Errors for AirPrint>

<Set> ▶ <Preferences> ▶ <Network>

Specify whether to display an error screen on the control panel if printing cannot be performed as expected due to a problem with the print data when printing with AirPrint.

If this is set to <On>, an error screen is displayed on the control panel. Cancel the job after checking the error screen. If this is set to <Off>, an error screen is not displayed on the control panel but the job remains in the job history with <Error> indicated.

<Position Information>

<Set> ▶ <Preferences> ▶ <Network>

Specify the device position information settings. **▶ Using AirPrint(P. 149)**

NOTE

- This setting can only be specified from the Remote UI.

<Settings for Universal Print>

<Set> ▶ <Preferences> ▶ <Network>

Specify the Universal Print settings. **▶ Printing Using the Microsoft Cloud Service (Universal Print)(P. 128)**

NOTE

- This setting can only be specified from the Remote UI.

<Select Interface>

<Set> ▶ <Preferences> ▶ <Network>

Select whether to use a wired LAN or wireless LAN by itself, a wired LAN and wireless LAN simultaneously, or a wired LAN and another wired LAN simultaneously. **▶ Selecting the Network Connection Method(P. 10)**

<Wireless LAN Settings>

<Set> ▶ <Preferences> ▶ <Network> ▶ <Wireless LAN>

Specify the wireless LAN settings. **▶ Connecting to a Wireless LAN(P. 14)**

<Wireless LAN Information>

<Set> ▶ <Preferences> ▶ <Network> ▶ <Wireless LAN>

Displays the setting information of wireless LAN. **▶Check the settings and information of the wireless LAN(P. 14)**

<Power Save Mode>

<Set> ▶ <Preferences> ▶ <Network> ▶ <Wireless LAN>

Specify whether to set the machine to the power save mode periodically, according to the signals sent by a wireless LAN router. **▶Connecting to a Wireless LAN(P. 14)**

<Use Direct Connection>

<Set> ▶ <Preferences> ▶ <Network> ▶ <Direct Connection Settings>

Specify whether to use direct connection. **▶Connecting Directly(P. 144)**

<Direct Connection Type>

<Set> ▶ <Preferences> ▶ <Network> ▶ <Direct Connection Settings>

Select the type of direct connection. **▶Connecting Directly(P. 144)**

NOTE

- If Wi-Fi Direct is selected, only one mobile device can connect.

<Device Name for Wi-Fi Direct>

<Set> ▶ <Preferences> ▶ <Network> ▶ <Direct Connection Settings>

Specify the device name to use for direct connections (Wi-Fi Direct).

IMPORTANT

- "-XY_Canon10" (where XY are random letters) is automatically appended to the device name for Wi-Fi Direct, unless the device name is 22 characters or more, in which case "-XY_Canon10" is not appended.

<Time Until Direct Connection Termination>

<Set> ▶ <Preferences> ▶ <Network> ▶ <Direct Connection Settings>

Specify the time before communication is automatically terminated when there is a prolonged period of no data transmission/reception while communicating using direct connection.

NOTE

- This setting is disabled if <Keep Enabled If SSID/Net. Key Specified> is set to <On>.

<Access Point Mode Settings>

<Set> ▶ <Preferences> ▶ <Network> ▶ <Direct Connection Settings>

Specify the settings for access point mode.

NOTE

When <Use Personal SSID and Network Key> is set to <On>

- Information on the user and SSID/network key when logging in is associated and stored in the machine. Only one mobile device can be connected.

When <Use Personal SSID and Network Key> is set to <Off>

- If both <Use Custom SSID> and <Use Custom Network Key> are set to <On>, multiple mobile devices can be connected at the same time. A maximum of five devices can be connected at the same time.
- If either or both <Use Custom SSID> and <Use Custom Network Key> are set to <Off>, a random SSID or network key is used to connect each time. Only one mobile device can be connected.

<Keep Enabled If SSID/Net. Key Specified>

<Set> ► <Preferences> ► <Network> ► <Direct Connection Settings>

If <Specify SSID to Use> and <Specify Network Key to Use> are enabled in <Access Point Mode Settings>, direct connections can be made without pressing <Enable> in <Direct Connection> in <Mobile Portal>.

NOTE

- The machine can connect with multiple mobile devices at the same time. A maximum of five devices can be connected at the same time.
- If this is set to <On>, the <Time Until Direct Connection Session Is Terminated> setting is disabled.
- If this is set to <On>, the machine will not enter the Sleep mode completely.

<Direct Connection IP Address Settings>

<Set> ► <Preferences> ► <Network> ► <Direct Connection Settings>

Specify the IP address to distribute to mobile devices connecting using direct connection.

NOTE

- The IP address distributed to mobile devices may be up to nine numbers greater than the value of the specified IP address.

<Use Personal SSID and Network Key>

<Set> ► <Preferences> ► <Network> ► <Direct Connection Settings>

Specify an SSID and network key for each user when logging in and connecting using a direct connection. To set an SSID, set <Use Custom SSID> to <On>, and enter the SSID. To set a network key, set <Use Custom Network Key> to <On>, and enter the network key.

NOTE

- This setting can only be specified from the Remote UI.

<IP Address Settings>

<Set> ▶ <Preferences> ▶ <Network> ▶ <Sub Line Settings>

Specify the IPv4 address to use with a wireless LAN (sub line) when using both a wired LAN and wireless LAN at the same time.

<Priority Line for Comm w/Mobile Devices>

<Set> ▶ <Preferences> ▶ <Network> ▶ <Sub Line Settings>

Select the line to connect mobile devices to when using both a wired LAN (main line) and wireless LAN (sub line) at the same time.

<Ethernet Driver Settings>

<Set> ▶ <Preferences> ▶ <Network> ▶ <Sub Line Settings>

Specify the Ethernet driver settings for the sub line. [▶ Making Ethernet Settings\(P. 29\)](#)

<Outbound Filter>

<Set> ▶ <Preferences> ▶ <Network> ▶ <Sub Line Settings> ▶ <Firewall Settings> ▶ <IPv4 Address Filter>

Specify the transmission filter in the sub line settings. [▶ Configuring the Firewall of the Sub Line\(P. 218\)](#)

<Inbound Filter>

<Set> ▶ <Preferences> ▶ <Network> ▶ <Sub Line Settings> ▶ <Firewall Settings> ▶ <IPv4 Address Filter>

Specify the reception filter in the sub line settings. [▶ Configuring the Firewall of the Sub Line\(P. 218\)](#)

<DNS Server Address Settings>

<Set> ▶ <Preferences> ▶ <Network> ▶ <Sub Line Settings> ▶ <Settings for System Data Communication>

Specify the DNS server address settings for the sub line. [▶ Making DNS Settings\(P. 31\)](#)

<Proxy Settings>

<Set> ▶ <Preferences> ▶ <Network> ▶ <Sub Line Settings> ▶ <Settings for System Data Communication>

Specify the proxy settings for the sub line. [▶ Setting a Proxy\(P. 221\)](#)

<Static Routing Settings>

<Set> ▶ <Preferences> ▶ <Network>

Specify the static routing settings for IPv4 addresses. [▶ Setting Static Routing\(P. 38\)](#)

<External Interface>

This section describes the USB settings.

<Use as USB Device>

<Set> ► <Preferences> ► <External Interface> ► <USB Settings>

You can set whether to use the machine as a USB device.

NOTE

- If this is set to <Off>, print jobs from a computer connected via USB cable cannot be performed.
- Changes in settings are effective after performing <Apply Set. Changes> on the <Home> screen.

<Use AddOn Driver for USB Storage Device>

<Set> ► <Preferences> ► <External Interface> ► <USB Settings>

You can set whether to use the AddOn driver for USB external storage.

IMPORTANT

- Depending on the type of AddOn application that uses USB external memory device, you may need to set this to <On>. To check whether you need to set this to <On>, see the manual for the AddOn application you are using, or contact your dealer or service representative.

NOTE

- Changes in settings are effective after performing <Apply Set. Changes> on the <Home> screen.

<Use USB Storage Device>

<Set> ► <Preferences> ► <External Interface> ► <USB Settings>

You can set whether to allow the use of USB external storage devices.

NOTE

- Changes in settings are effective after performing <Apply Set. Changes> on the <Home> screen.

<Restrict Auto Install of Printer Driver>

<Set> ► <Preferences> ► <External Interface> ► <USB Settings>

This enables you to prevent a new printer driver from being installed when switching machines with multiple machines connected via USB.

 **IMPORTANT**

- Set this to <Off> when using a USB hub to connect multiple machines.

NOTE

- Changes in settings are effective after performing <Apply Set. Changes> on the <Home> screen.

<Accessibility>

7L2J-076

This section describes settings for improving accessibility, such as inverting the screen colors and setting the message display time.

<Invert Screen Colors>

<Set> ► <Preferences> ► <Accessibility>

You can invert the screen colors of the display. If you find it hard to view the display even after adjusting <Backlight Brightness>, try specifying this setting.

<Contrast>

<Set> ► <Preferences> ► <Accessibility>

You can adjust the contrast (the difference between the light and dark parts) of the display to suit the installation location of the machine.

<Backlight Brightness>

<Set> ► <Preferences> ► <Accessibility>

You can adjust the brightness of the display to suit the installation location of the machine.

<Message Display Time>

<Set> ► <Preferences> ► <Accessibility>

You can specify the interval in seconds at which two different messages are alternately displayed.

<Scrolling Speed>

<Set> ► <Preferences> ► <Accessibility>

You can adjust the scrolling speed of the screen by selecting from three levels.

<Volume Settings>

7L2J-077

All the settings used to generate the confirmation sound of a key being pressed, the sound indicating completion of the printing process, and other sounds, are listed with descriptions.

NOTE

- For information about the setting procedures, see [▶Setting Sounds\(P. 103\)](#) .

<Entry Tone>

<Set> ▶ <Preferences> ▶ <Volume Settings>

You can set whether to produce a sound when a key on the control panel has been pressed.

<Invalid Entry Tone>

<Set> ▶ <Preferences> ▶ <Volume Settings>

You can set whether to produce a sound when an invalid key operation has been performed, for example, when an invalid numeric value has been entered.

<Restock Supplies Tone>

<Set> ▶ <Preferences> ▶ <Volume Settings>

You can set whether to produce a sound that indicates the end of toner cartridge lifetime is approaching.

<Warning Tone>

<Set> ▶ <Preferences> ▶ <Volume Settings>

You can set whether to produce a sound telling that a trouble has occurred on the machine, such as a paper jam, incorrect operation, or press of an inoperable key.

<Job Done Tone>

<Set> ▶ <Preferences> ▶ <Volume Settings>

You can set whether to produce a sound when printing has been completed.

<Energy Saver/Sleep Tone>

<Set> ▶ <Preferences> ▶ <Volume Settings>

You can set whether to produce a sound when the machine enters or exits the sleep mode.

<Login Tone>

<Set> ▶ <Preferences> ▶ <Volume Settings>

You can set whether to produce a sound when login is successful.

<Adjustment/Maintenance>

7L2J-078

Item	Description
▶<Maintenance>(P. 379)	This section describes how to use the auto cleaning function for the main unit.
▶<Adjust Image Quality>(P. 380)	This section describes how to adjust image quality for printing.

<Maintenance>

This section describes how to use the auto cleaning function for the main unit.

<Clean Pressure Roller for Fixing>

<Set> ► <Adjustment/Maintenance> ► <Maintenance>

If printed paper is dirty, execute <Clean Pressure Roller for Fixing>.

<Low Toner Consumption Printing Mode>

<Set> ► <Adjustment/Maintenance> ► <Maintenance>

If you do not expect to use much yellow toner, set this to <On> before installing the yellow toner cartridge.

NOTE

- If you set this to <On>, the print speed may be slower.

<Control Detected Condensation>

<Set> ► <Adjustment/Maintenance> ► <Maintenance>

Set whether to start the process to remove condensation when condensation is detected inside the machine. If you set this mode to <On>, the process to remove condensation is automatically performed.

IMPORTANT

- During the process to remove condensation, printing may not be performed correctly resulting in the paper being blank.
- To maintain the effect of the process to remove condensation going when this mode is set to <On>, it is necessary to keep the machine's power ON.

NOTE

- If you select <On> and press <OK>, a screen asking whether to immediately perform the process to remove condensation is displayed. If you want to immediately start the process to remove condensation, press <Yes>.

<Adjust Image Quality>

7L2J-079

This section describes how to adjust image quality for printing.

<Full Calibration>

<Set> ▶ <Adjustment/Maintenance> ▶ <Adjust Image Quality>

The machine performs calibration for correctly reproducing the colors of originals.

<Settings for Auto Full Calibration>

<Set> ▶ <Adjustment/Maintenance> ▶ <Adjust Image Quality>

The machine performs automatic adjustment (calibration) in order to prevent color misregistration and ensure that the original color intensity is correctly reproduced. You can set the timing and frequency for performing calibration. ▶ **Automatically Adjusting Color Registration and Color Intensity(P. 424)**

<Adjust Print Position>

<Set> ▶ <Adjustment/Maintenance> ▶ <Adjust Image Quality>

You can adjust the print position when printing is lopsided or protruding from the print range. ▶ **Adjusting the Print Position(P. 425)**

<Adjust Toner Volume Used for Color Print>

<Set> ▶ <Adjustment/Maintenance> ▶ <Adjust Image Quality>

By adjusting the amount of toner used when color printing, you may be able to reduce problems such as streaks and irregularities. ▶ **Reducing Toner Used When Color Printing(P. 428)**

<Waterdrop Pattern Prevention Mode>

<Set> ▶ <Adjustment/Maintenance> ▶ <Adjust Image Quality> ▶ <Special Processing>

You can set <Waterdrop Pattern Prevention Mode> for when a splattered image, white patches, streaks, etc. appear on the halftone images of twosided print jobs. Immediately after you turn ON the machine in a low temperature environment, if the halftone reproduction of the printout becomes significantly different from the original document, set this mode to <On>.

NOTE

- If you set <Waterdrop Pattern Prevention Mode>, the printing speed for the first sheet becomes slower.

<Adjust Fixing Temperature>

<Set> ▶ <Adjustment/Maintenance> ▶ <Adjust Image Quality> ▶ <Special Processing>

You can reduce image quality problems that occur due to an inappropriate fixing unit temperature by adjusting the fixing temperature.

NOTE

- Set this in the following cases. The print results may be improved.
 - <Low>: Set this when the same unintended image is repeated, as indicated below.



- <High 1>: Set this when the toner of the printed images peels off.
- <High 2>: Set this when the improvements of <High 1> are insufficient.
- Set <Standard> to not use either setting.
- The printing speed is slower when <High 2> is set.
- Toner peeling may be able to be improved without changing this setting, by changing the paper type and usage environment.

<Curl Prevention Mode>

<Set> ► <Adjustment/Maintenance> ► <Adjust Image Quality> ► <Special Processing>

You can set <Curl Prevention Mode> to reduce curling on the end of paper due to the heat and pressure of the fixing unit during printing.

NOTE

- If this setting is set to <On>, it may affect the printing quality.
- If setting <Mode 1> to <On> does not reduce curling, set <Mode 2> to <On>. If setting both <Mode 1> and <Mode 2> does not reduce curling, set <Mode 1> and <Mode 2> to <Off> and set <Switch Paper Feed Method> to <Print Side Priority>.

<Paper Slipping Prevention Mode>

<Set> ► <Adjustment/Maintenance> ► <Adjust Image Quality> ► <Special Processing>

Paper may not be fed correctly when printing or print quality may be reduced, depending on the usage environment.

NOTE

- <Mode 1> : Set this when printing documents with large amounts of images or text on each page. However, the print speed will be slower.
- <Mode 2> : Set this when printing documents with small amounts of images or text on each page. The print speed will not be reduced as much as <Mode 1>.
- <Off>: Set this when you do not want the print speed to be reduced. However, the print quality will not be improved.

<Auto Clean Secondary Transfer Roller>

<Set> ► <Adjustment/Maintenance> ► <Adjust Image Quality> ► <Special Processing>

The secondary transfer roller is cleaned after executing a print job with free size specified. Set this when the back side of the paper is dirty.

<White Streak Prevention Mode>

<Set> ▶ <Adjustment/Maintenance> ▶ <Adjust Image Quality> ▶ <Special Processing>

White streaks may appear in the printed image. This setting may improve this problem.

NOTE

- When set to <On>, the print density will be lighter.

<Correct Fixing When Using Plain Paper>

<Set> ▶ <Adjustment/Maintenance> ▶ <Adjust Image Quality> ▶ <Special Processing>

Smudges may appear in the printed image, depending on the paper type and usage environment. This setting may improve this problem.

NOTE

- When set to <On>, the print speed will be slower.

<Corr. Tail End Fix. When Using Plain Ppr>

<Set> ▶ <Adjustment/Maintenance> ▶ <Adjust Image Quality> ▶ <Special Processing>

Colors may become darker at the tail end of printed images because toner is insufficiently fixed. This setting may improve this problem.

NOTE

- When set to <On>, the print speed will be slower.

<Plain Paper Fill Area Image Adjust. Mode>

<Set> ▶ <Adjustment/Maintenance> ▶ <Adjust Image Quality> ▶ <Special Processing>

The finish quality may be able to be improved by enabling this setting when using plain paper with a smooth surface.

NOTE

- If you set this setting to <On> when using plain paper without a smooth surface, fixing problems may occur.

<Heavy Paper Fill Area Image Adjust. Mode>

<Set> ▶ <Adjustment/Maintenance> ▶ <Adjust Image Quality> ▶ <Special Processing>

The finish quality may be able to be improved by enabling this setting when using heavy paper without a smooth surface.

NOTE

- If you set this setting to <On> when using paper with a smooth surface, fixing problems may occur.

<Envelope Sealing Prevention Mode>

<Set> ▶ <Adjustment/Maintenance> ▶ <Adjust Image Quality> ▶ <Special Processing>

You can set <Envelope Sealing Prevention Mode> to prevent the glue on envelope flaps from melting and sealing due to the heat and pressure of the fixing unit during envelope printing.

NOTE

- This setting is only enabled during envelope printing.
- If this setting is set to <On>, the quality of the image may be adversely affected.

<Function Settings>

7L2J-07C

This section describes the settings for functions.

NOTE

- Some settings can only be set by the Administrator.
- Some of the settings may not be displayed depending on the configuration of optional equipment installed on the machine.

Item	Description
▶<Common>(P. 385)	This section describes settings for functions such as Paper Feed Settings, Paper Output Settings, and Print Settings.
▶<Printer>(P. 388)	This section describes how to specify printer settings.
▶<Send>(P. 390)	This section describes how to specify E-mail settings.
▶<Receive>(P. 391)	This section describes how to specify receive settings.
▶<Access Files>(P. 392)	This section describes the settings for printing stored files.
▶<Print>(P. 393)	This section describes the print settings.

<Common>

7L2J-07E

This section describes settings for functions such as Paper Feed Settings, Paper Output Settings, and Print Settings.

NOTE

- Some of the settings may not be displayed depending on the configuration of optional equipment installed on the machine.

<Paper Source Auto Selection>

<Set> ▶ <Function Settings> ▶ <Common> ▶ <Paper Feed Settings>

You can configure the paper source that will be used when printing with <Select Paper> set to <Auto>. This setting also functions when the paper in the current paper source runs out during printing.  **Automatically Selecting the Appropriate Paper Source for a Specific Function (P. 99)**

<Switch Paper Feed Method>



<Set> ▶ <Function Settings> ▶ <Common> ▶ <Paper Feed Settings>

When regularly using paper with logos such as letterheads, while printing in both one-sided and two-sided, you can set this setting to <Print Side Priority> to print the first page on the front side for both one-sided and two-sided, without having to change the paper orientation.  **Loading Preprinted Paper(P. 78)**

IMPORTANT

- The settings for Automatic Paper Selection and Auto Drawer Switching are disabled for paper sources with <Print Side Priority> set. The print speed is also slower when performing one-sided printing.

NOTE

- <Print Side Priority> is only enabled when paper that can be printed on both sides is set ( **Paper Available for Two-Sided Printing(P. 539)**).
- For instructions on loading paper, see  **Loading Preprinted Paper(P. 78)** .

<Suspended Job Timeout>

<Set> ▶ <Function Settings> ▶ <Common> ▶ <Paper Feed Settings>

If this setting is set to <On> and a job is suspended due to a lack of paper, etc., the machine automatically prints the next job after the specified time period.

NOTE

- If a job is suspended because paper has run out during the job, the next job is not processed even after the designated suspension time elapses.
- To automatically delete suspended jobs, see  **<Auto Delete Suspended Jobs>(P. 387)** .

<Job Separator Between Jobs>

<Set> ► <Function Settings> ► <Common> ► <Paper Output Settings>

This enables you to insert the specified paper at the start of each job when multiple jobs are printed consecutively.

<Job Separator Between Copies>

<Set> ► <Function Settings> ► <Common> ► <Paper Output Settings>

This enables you to insert the specified paper each number of copy sets to divide the sets. If you set this, paper is inserted when printing with Collate (Page Order).

IMPORTANT

- If you are using the Group (Same Pages) mode, you cannot insert job separation sheets between copy sets.

<Print Priority>

<Set> ► <Function Settings> ► <Common> ► <Print Settings>

A job that has a higher set priority can be set to print after the job currently being processed is complete.

NOTE

- If the same printing priority has been specified for multiple functions, printing starts with the first processed print job.
- Priority printing does not take place until the current job is complete. However, if the current job is paused, the printing of another job may start, depending on its settings.

<Chrom. Color Conv. for Two Colors Print>

<Set> ► <Function Settings> ► <Common> ► <Print Settings>



You can select the specified color to use when printing using the two-color mode, which prints in black and a specified color. The two-color mode can be set for printing. This setting is reflected in the two-color mode for printing.

- All Chromatic Colors: When specifying the color to use for all chromatic colors other than black in the image data.
- Approximate Colors Only: When using the color for only the specified color (or approximate color) and using black for all other chromatic colors in the image data.

■ Example Replaced Colors and Settings

When the two-color mode is specified for image data including the following colors, the colors are replaced as indicated below.

- Colors included in the original image data: Red, orange, blue, black
- Red specified for the two-color mode

Image data	"All Chromatic Colors"	"Approximate Colors Only"
		
Red	Red	Red
Orange	Red	Red
Blue	Red	Black
Black	Black	Black

<Auto Delete Suspended Jobs>

<Set> ► <Function Settings> ► <Common> ► <Print Settings>

If this setting is set to <On> and a job is suspended due to a paper jam, etc., the machine automatically deletes the job after the specified time period.

NOTE

- To retain a suspended job without automatically deleting it, see ► <Suspended Job Timeout>(P. 385) .

<Printer>

7L2J-07F

This section describes the printer settings.

<Printer Settings>

<Set> ► <Function Settings> ► <Printer>

Specify the printer settings.

For more information, see *Setting the Machine (PS/PCL/UFR II Printer)*.

<Restrict Printer Jobs>

<Set> ► <Function Settings> ► <Printer>

If this setting is set to <On>, you can restrict jobs from the printer driver.

<Switch Paper Source Auto Selection Mode>

<Set> ► <Function Settings> ► <Printer>

You can select which paper to prioritize when both horizontal paper and vertical paper are loaded and set as the target for automatic paper selection.

<Feed from MP Tray When No Paper Source>

<Set> ► <Function Settings> ► <Printer>

If this setting is set to <On>, you can display a message prompting the user to load paper in the multi-purpose tray when the paper specified with automatic paper selection is not found.

<MP Tray Priority for Ppr Src Auto Select>

<Set> ► <Function Settings> ► <Printer>

If this setting is set to <On>, printing on the paper loaded in the multi-purpose tray is prioritized.

<PDL Selection (Plug and Play)>

<Set> ► <Function Settings> ► <Printer>

Select default Page Description Language (PDL).

<Ppr Size Mismatch for Free Size Ppr Src>

<Set> ► <Function Settings> ► <Printer>

When printing on free size paper, the machine detects whether the size of the loaded paper matches the print settings.

<Vertical Printing Priority for Free Size>

<Set> ► <Function Settings> ► <Printer>

You can set the orientation for printing on free size paper.

<PS Password Settings>

<Set> ► <Function Settings> ► <Printer>

You can specify the password that restricts the use of the control command prepared by the PS printer.

NOTE

- <SystemParams Password> is a password that allows changes to the system parameter, and <StartJob Password> is a password that allows startjob, exitserver operator to perform. For more information, check PostScript language specifications.

<Paper Feed Mode When Using PCL Emulation>

<Set> ► <Function Settings> ► <Printer>

You can set the paper source used for the PCL5 PaperSource command.

NOTE

- For details on each setting, see Setting the Machine (PS/PCL/UFR II Printer).

<Send>

7L2J-07H

This section describes how to specify the e-mail print settings.

<Communication Settings>

<Set> ▶ <Function Settings> ▶ <Send> ▶ <E-mail Settings>

You can configure the settings for using the e-mail print function. Other settings related to e-mail printing, such as the settings for a mail server, must be configured from the Remote UI. [▶Configuring E-Mail Print Settings\(P. 45\)](#)

IMPORTANT

- If you set shorter than 10 minutes (excluding '0 min') for <POP Interval>, the machine will not completely enter the Sleep mode.

<Confirm TLS Certificate for POP RX>

<Set> ▶ <Function Settings> ▶ <Send> ▶ <E-mail Settings>

You can check whether the TLS server certificate is valid when receiving with POP. You can verify the validity of the certificate and reliability of the certificate chain, as well as confirm the CN (Common Name).

IMPORTANT

- If you do not verify the certificate, TLS communication is performed, even with an invalid certificate.

NOTE

- If there is a problem with the certificate, POP receiving will fail.

<Receive>

This section describes how to specify receive settings.

<Print on Both Sides>

<Set> ▶ <Function Settings> ▶ <Receive> ▶ <Common Settings>

You can select whether to print received documents on both sides of paper.

<Reduce RX Size>

<Set> ▶ <Function Settings> ▶ <Receive> ▶ <Common Settings>

You can select whether to reduce received documents so that the whole document is printed within the printable area of the paper.

NOTE

- If this setting is set to <Off>, the image size of the received file is not reduced to fit the size of the paper. If the size of the image exceeds the printable area, the image is divided into equal sections and printed onto separate sheets of paper.
- If you select <Auto> in <Reduction Mode>, the image size is automatically reduced by a suitable reduction ratio. This ratio can range from the value set for <Reduction Ratio>, up to 100% of the received document size.

<RX Page Footer>

<Set> ▶ <Function Settings> ▶ <Receive> ▶ <Common Settings>

You can select whether to print information, such as reception time and page number, at the bottom of received documents.

NOTE

- When an e-mail without a body is received, the From information and Subject information (up to 24 characters for each) is printed at the top of the first page of the attachment file.

<Access Files>

7L2J-07K

This section describes the settings for printing stored files.

<Change Default Set. (Memory Media Print)>

<Set> ▶ <Function Settings> ▶ <Access Files> ▶ <Common Settings> ▶ <Access Stored Files Settings>

You can change the settings registered as default for the <Access Stored Files> function.

<Use Print Function>

<Set> ▶ <Function Settings> ▶ <Access Files> ▶ <Memory Media Settings>

Specifying this setting enables you to print files in memory media. **▶ Restricting the Use of Memory Media(P. 259)**

<Select Option When Connecting Mem. Media>

<Set> ▶ <Function Settings> ▶ <Access Files> ▶ <Memory Media Settings>

You can set whether to display the print settings screen when memory media is connected. **▶ Connecting a USB Memory Device(P. 53)**

<Print>

7L2J-07L

This section describes the print settings.

<Job Storage Period>

<Set> ► <Function Settings> ► <Print>

Specify the time period for storing jobs.

<Job List Display Settings>

<Set> ► <Function Settings> ► <Print>

Specify the job types to be included in the job list, and the job type to be selected by default.

<Management Settings>

7L2J-07R

You can configure the settings related to management of users, devices, and data, etc., for secure and efficient use of the machine.

Item	Description
▶<User Management>(P. 395)	You can configure the settings for managing users of the machine.
▶<Device Management>(P. 396)	You can manage information about the hardware and operations, as well as various data required when using the machine functions.
▶<License/Other>(P. 398)	You can register licenses and configure the settings related to the software and system options available for the machine.
▶<Data Management>(P. 400)	You can configure settings for utilizing data such as the machine settings information and initializing data.
▶<Security Settings>(P. 402)	You can configure settings related to system modification.

<User Management>

7L2J-07S

You can configure the settings for managing users of the machine with a user authentication application.

<Set Administrator Password>

<Set> ▶ <Management Settings> ▶ <User Management> ▶ <Authentication Management>

You can change the password used by the Administrator for logging into the Remote UI. When changing the password again, it can only be specified from the Remote UI.

<Set Administrator PIN>

<Set> ▶ <Management Settings> ▶ <User Management> ▶ <Authentication Management>

You can set whether to enter the PIN to display settings that require Administrator privileges.

<System Manager Information Settings>

<Set> ▶ <Management Settings> ▶ <User Management>

Set the System Manager information for the machine. ▶ **Changing the System Manager ID and PIN(P. 201)**

<Department ID Management>

<Set> ▶ <Management Settings> ▶ <User Management>

Select whether to manage users in groups by assigning users to Department IDs. ▶ **Configuring the Department ID Management Settings(P. 203)**

NOTE

- You can only select whether to use Department ID Management here. The Remote UI must be used to register department IDs or check the usage status of each department ID.

<Device Management>

You can specify settings related to the management of the device and optional products.

<Device Information Settings>

<Set> ► <Management Settings> ► <Device Management>

Enter the name and the installation location to identify the machine.

<Display Job Status Before Authentication>

<Set> ► <Management Settings> ► <Device Management>

Select whether to restrict access to the <Status Monitor> screen when using a login service.

<Restrict Access to Other User Jobs>

<Set> ► <Management Settings> ► <Device Management>

Select whether to restrict users from performing operations on the jobs of other users on the <Status Monitor> screen when User Authentication is used.

<Display Job Log>

<Set> ► <Management Settings> ► <Device Management>

Select whether to display job logs on the <Status Monitor> screen. You can also select whether to allow device management software to retrieve job logs from the machine. ► **Basic Screens(P. 81)**

<Save Audit Log>

<Set> ► <Management Settings> ► <Device Management>

Select whether to start log recording. For information on the types of logs, see ► **Management Functions(P. 523)** .

► **Starting Log Recording(P. 270)**

<Retrieve Network Authentication Log>

<Set> ► <Management Settings> ► <Device Management>

Select whether to start log recording for authentication performed when the machine is accessed via the network, such as when printing from a computer.

<Restrict Service Representative Access>

<Set> ► <Management Settings> ► <Device Management>

You can set the machine to restrict changes in user information or security-related settings when the machine is inspected or repaired by your dealer or service representative.

NOTE

- Even when this is not set to <On>, you can check the audit log for past operations if the service representative has changed user information or security-related settings.

<Prohibit Initialization of Admin. Pswrd.>

<Set> ► <Management Settings> ► <Device Management>

Set whether to restrict the operation of <Initialize Administrator Password> in <Check Counter>.

<Restrict Special Mode Operations>

<Set> ► <Management Settings> ► <Device Management>

Select whether to restrict use of Special Mode, which is provided for the purpose of maintenance by service representatives.

<License/Other>

You can register licenses and configure the settings related to the software and system options available for the machine.

<Register License>

<Set> ► <Management Settings> ► <License/Other>

Enter the license key for a system option that can be used on the machine. [▶ Installing System Options\(P. 287\)](#)

<Use TLS>

<Set> ► <Management Settings> ► <License/Other> ► <AddOn Settings>

Select whether to use TLS communication when an AddOn application is used by accessing the machine via a Web browser.

NOTE

- You need to configure the key and certificate before setting this setting to <On>. [▶ Configuring the Key and Certificate for TLS\(P. 223\)](#)
- Changes made for this setting are also applied to <Use TLS> in [▶ <Remote UI Settings>\(P. 398\)](#) .

<Confirm TLS Certificate Using AddOn App>

<Set> ► <Management Settings> ► <License/Other> ► <AddOn Settings>

Select whether to verify TLS server certificates and their common names (CN) when TLS communication is used for an AddOn application.

<Use DNS Caching>

<Set> ► <Management Settings> ► <License/Other> ► <AddOn Settings>

Select whether to save DNS information from successful searches via an AddOn application to memory. You can also set an expiration date if you choose to save information temporarily.

<Use Proxy Settings of This Device>

<Set> ► <Management Settings> ► <License/Other> ► <AddOn Settings>

Select whether to use the proxy settings of the machine with AddOn applications. [▶ Setting a Proxy\(P. 221\)](#)

<Add X-FRAME-OPTIONS to HTTP Header>

<Set> ► <Management Settings> ► <License/Other> ► <AddOn Settings>

When the HTTP server returns a response, it appends X-FRAME-OPTIONS to the header to prevent contents created by other servers from overlapping.

<Remote UI Settings>

<Set> ► <Management Settings> ► <License/Other>

Select whether to use the Remote UI to operate the machine and change settings.

<Register/Update Software>

<Set> ▶ <Management Settings> ▶ <License/Other>

You can install system options/AddOn applications in the machine. ▶ **Installing System Options(P. 287)**

<Start Setup Guide>

<Set> ▶ <Management Settings> ▶ <License/Other>

You can follow the wizard instructions to configure the machine's initial settings. ▶ **Setting up Using the Setup Guide(P. 6)**

<Data Management>

You can configure settings for utilizing data such as the machine settings information and initializing data.

<Import from USB Memory>

<Set> ▶ <Management Settings> ▶ <Data Management> ▶ <Import/Export>

You can import all the settings information from a USB memory device.

NOTE

- If USB memory is already connected to the machine, that USB memory will be recognized as the media to use for importing, even if you connect new USB memory. Select <Remove Memory Media>, remove the connected USB memory, and then connect the desired USB memory.

<Export to USB Memory>

<Set> ▶ <Management Settings> ▶ <Data Management> ▶ <Import/Export>

You can export all the settings information into a USB memory device.

NOTE

- You cannot select which settings to export when exporting to USB memory. All settings are batch exported.
- If USB memory is already connected to the machine, that USB memory will be recognized as the media to use for exporting, even if you connect new USB memory. Select <Remove Memory Media>, remove the connected USB memory, and then connect the desired USB memory.

<Restrict Import/Export from Web Service>

<Set> ▶ <Management Settings> ▶ <Data Management> ▶ <Import/Export>

Select whether to restrict import and export operations with Web applications other than the Remote UI.

<Initialize Network Settings>

<Set> ▶ <Management Settings> ▶ <Data Management>

You can restore all of the network settings to the factory default values. [▶ Initializing Settings\(P. 289\)](#)

<Initialize All Set. without Network Set.>

<Set> ▶ <Management Settings> ▶ <Data Management>

You can restore all of the machine settings to the factory default values. [▶ Initializing Settings\(P. 289\)](#)

NOTE

- <Network> is not initialized.

<Initialize All Data/Settings>

<Set> ▶ <Management Settings> ▶ <Data Management>

Select to restore all of the machine settings to the factory default values and completely erase the data stored in the machine. It is not normally necessary to use this setting, but it is useful to erase personal or confidential information when disposing of the machine. ▶ **Initializing Settings(P. 289)**

<Security Settings>

You can configure settings related to system modification.

<Verify System at Startup>

<Set> ► <Management Settings> ► <Security Settings> ► <System Verification Settings>

You can set the machine to verify the integrity of the firmware and applications installed in the machine during startup.

IMPORTANT

- This function restarts the machine not only when the setting is changed from <Off> to <On> but also when <Apply> is selected without changing the setting from <On>. To avoid restarting the machine without changing the setting from <On>, select <No> on the confirmation screen and then navigate from the screen for this function.

NOTE

- When this function is set to <On>, startup takes longer than when it is set to <Off> because system verification is performed.
- The following events and results are recorded to the device management log. [▶ Managing the Logs\(P. 270\)](#)

Event	Result
Firmware verification	Success
Verification of the applications installed in the machine	Failure

- If an error code is displayed on the screen when the machine is started with this setting set to <On>, contact your dealer or service representative.

<McAfee Embedded Control>

<Set> ► <Management Settings> ► <Security Settings> ► <System Verification Settings>

When the machine is operating, the McAfee Embedded Control function is used to prevent unauthorized program modification and the execution of unauthorized programs, for improved system reliability.

NOTE

- To set this function to <On>, it is necessary to set <Verify System at Startup> to <On> in advance.
- When this function is set to <On>, startup takes longer than when it is set to <Off>.

<Output Report>

This section describes settings regarding report output.

<2-Sided Printing>

<Set> ▶ <Output Report> ▶ <Default Settings for Output Report>

You can output reports such as the print history and settings list with two-sided printing.

<Consumables Status Report>

<Set> ▶ <Output Report> ▶ <Print List>

You can print a report to check the status of the consumables in the machine.

<User Data List>

<Set> ▶ <Output Report> ▶ <Print List>

You can check the settings of the machine and their current values in a list. Information such as the firmware version and registered paper sizes and types are also printed.

NOTE

- Network settings are not printed to the user data list.

<Network User Data List>

<Set> ▶ <Output Report> ▶ <Print List>

You can check the network settings of the machine and their current values in a list. Information regarding security, such as the address filter and IPsec settings, are also printed.

NOTE

- Items that have been changed from their default settings are printed with an asterisk (*) next to them.
- The following items are automatically generated from unique information of the machine by default and when the settings are initialized, and have an asterisk (*) next to them.
 - IPv4 Host Name
 - IPv6 Host Name
 - mDNS Name (mDNS Settings)
 - Current Transmission Speed (Ethernet Driver Settings)

<Communication Management Report>

<Set> ▶ <Output Report> ▶ <Print List>

You can print a report to check the history of the e-mail received with the machine, including the subject and reception date/time.

<Page Count List>

<Set> ► <Output Report> ► <Print List>

You can print a report to check the print count* for each user (department ID) in Department ID Management. You can also manually specify to only count black-and-white or color printing.

* In this report, the numbers are based on printed sides of the page. For example, the count is 1 if you print on one side of a page, and the count is 2 if you print on both sides of the page.

NOTE

- Department ID Management must be set in order to calculate the Page Count List for each Department ID. Setting the Department ID Management
- With the Remote UI Page Count List, you can check how many pages have been printed by individual user names linked to a Department ID. To display the list, **Starting the Remote UI(P. 262)** ► click [Settings/Registration] ► [User Management] ► [Department ID Management]. However, note that user names will not be displayed if multiple users are allocated to the same Department ID, or if you are using DepartmentID Authentication as the login service.
- The Page Count List can also be saved as a CSV file using the Remote UI. **Starting the Remote UI(P. 262)** ► click [Settings/Registration] ► [User Management] ► [Department ID Management] ► [Store in CSV Format].

<Counter Report>

<Set> ► <Output Report> ► <Print List>

You can print a report to check the total number of all printed pages.

<Print Log List>

<Set> ► <Output Report> ► <Print List>

The following print history can be checked in a report.

- History of documents printed from a computer
- History of e-mail received and printed
- History of printing setting lists and reports

<IPSec Policy List>

<Set> ► <Output Report> ► <Print List>

You can check a list of the settings for the IPSec policies registered in the machine.

<AddOn System Information>

<Set> ► <Output Report> ► <Print List>

You can check a list of the information for the applications installed in the machine and some system application information.

<Import Result Report>

<Set> ► <Output Report> ► <Print List>

You can check the results of importing in a report.

<Toner Cartridge Log Report>

<Set> ▶ <Output Report> ▶ <Print List>

You can check the usage history of toner cartridges in a report.

<PCL>

<Set> ▶ <Output Report> ▶ <Print List>

You can check the PCL settings of the machine, their current values, and available fonts in a list.

<PS>

<Set> ▶ <Output Report> ▶ <Print List>

You can check the PS settings of the machine, their current values, and available fonts in a list.

Maintenance

Maintenance	407
Regular Cleaning	409
Cleaning the Exterior	410
Replacing the Toner Cartridge	411
Replacing the Waste Toner Container	415
Replacement Parts	418
Checking the Remaining Amount of Consumables	421
Adjusting Print Quality	422
Adjusting Gradation	423
Automatically Adjusting Color Registration and Color Intensity	424
Adjusting the Print Position	425
Reducing Toner Used When Color Printing	428
Paper Type Management Settings	429
Checking the Number of Pages for Print	435
Printing Reports and Lists	436

Maintenance

7L2J-081

This section describes the maintenance and management of the machine, such as regular cleaning and the replacement of consumables. It also describes the maintenance service provided by Canon. For information on precautions to take during maintenance, see the Important Safety Instructions.

! IMPORTANT

- The minimum holding period for performance parts for repairs and toner cartridges is seven (7) years after production of the machine model is discontinued.

■ Basic Cleaning



▶ Regular Cleaning(P. 409)

■ Replacing Consumables

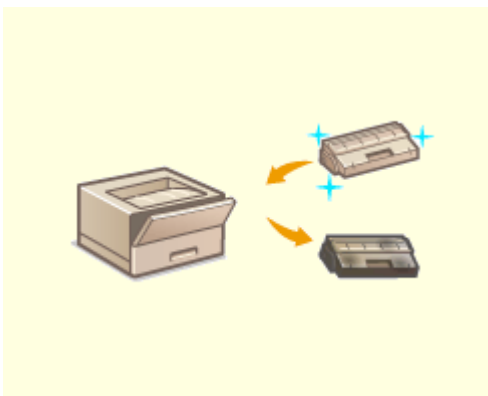

▶ Replacing the Toner Cartridge(P. 411)

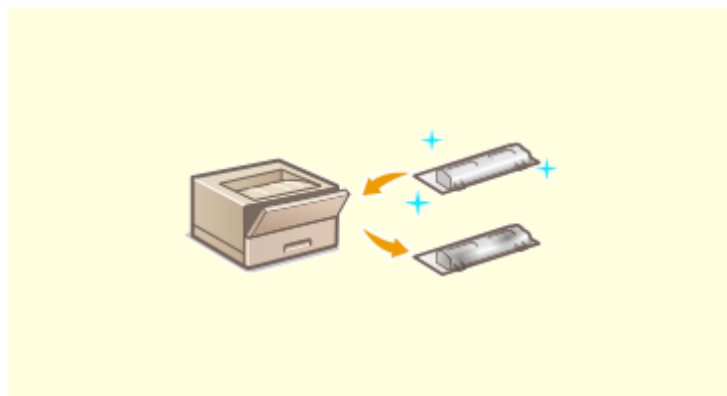

▶ Replacing the Waste Toner Container(P. 415)

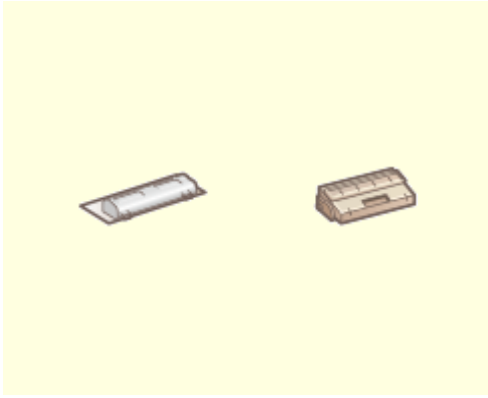

▶ Replacement Parts(P. 418)



▶ Checking the Remaining Amount of Consumables(P. 421)

■ Other Maintenance and Adjustment

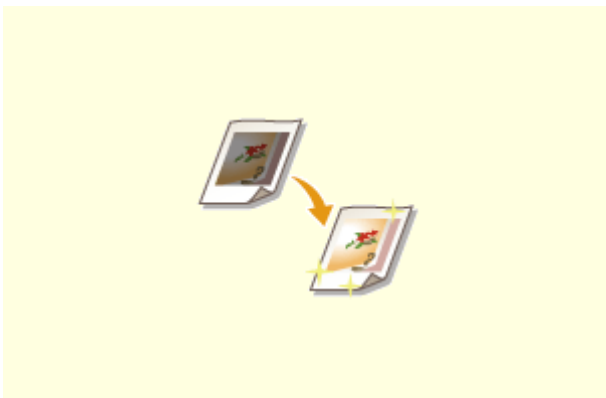

▶ Adjusting Print Quality(P. 422)



▶ Printing Reports and Lists(P. 436)



▶ Checking the Number of Pages for Print(P. 435)

Regular Cleaning

7L2J-082

It is recommended that you periodically clean the machine to prevent loss of print quality and enable you to use the machine comfortably and safely.

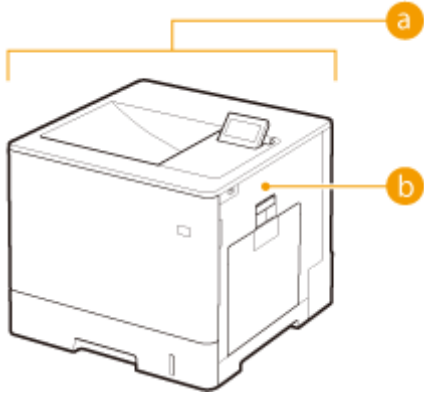

a Exterior ▶ **Cleaning the Exterior(P. 410)**

b Pressure roller for fixing ▶ **<Clean Pressure Roller for Fixing>(P. 379)**

Cleaning the Exterior

7L2J-083

Periodically wipe the surface of the machine to keep it clean.

1 Turn the power OFF, and remove the power plug from the power outlet.

▶Turning OFF the Machine(P. 62)

! IMPORTANT:

- Check the operation status of the machine before turning the power OFF. You can turn the power OFF even if the machine is executing an operation, but this may cause the operation to be interrupted or data to become damaged.

2 Wipe the surface of the machine.

- Wet a soft cloth with water or diluted mild detergent, wring the cloth out well, and wipe the machine.



- Wait until the moisture has completely dried before proceeding to the next step.

3 Insert the power plug into the power outlet, and turn the power ON.

▶Turning ON the Machine(P. 61)

Replacing the Toner Cartridge

7L2J-084

When toner starts running low or has run out, a message is displayed prompting you to prepare a new toner cartridge or perform toner cartridge replacement. Prepare a new toner cartridge or perform toner cartridge replacement according to the displayed message.

- ▶ **Cautions When Replacing the Toner Cartridge(P. 411)**
- ▶ **Procedure for Replacing the Toner Cartridge(P. 412)**

Cautions When Replacing the Toner Cartridge

CAUTION

- Do not touch the contacts (a) inside the machine. Doing so may result in damage to the machine.

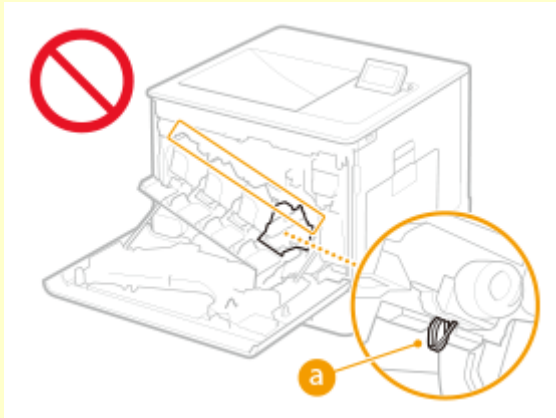

IMPORTANT

- Do not replace toner cartridges until the message prompting you to do so appears.
- Be sure to hold the toner cartridge using the handle.

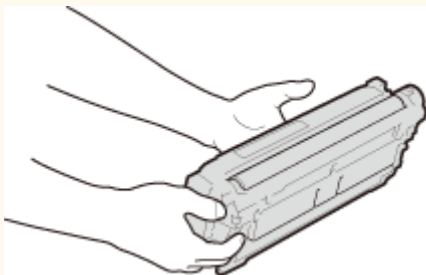

- To avoid scratching the surface (a) of the drum inside the machine or exposing it to light. Do not touch the electrical contacts (b) or the toner cartridge memory (c).

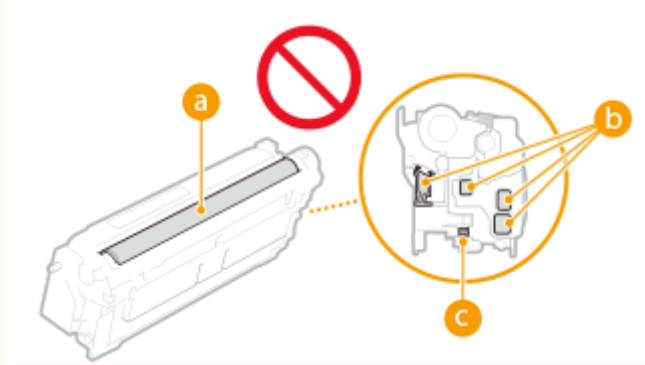

NOTE

- For details about each message, see [▶Countermeasures for Each Message\(P. 453\)](#) .
- For information on the product numbers for toner cartridges, see [▶Consumables\(P. 418\)](#) .
- You can check the current amount of toner remaining. [▶Checking the Remaining Amount of Consumables\(P. 421\)](#)

Procedure for Replacing the Toner Cartridge

When replacing toner cartridges, follow the instructions shown in the video along with those written below.

1 Open the front cover.

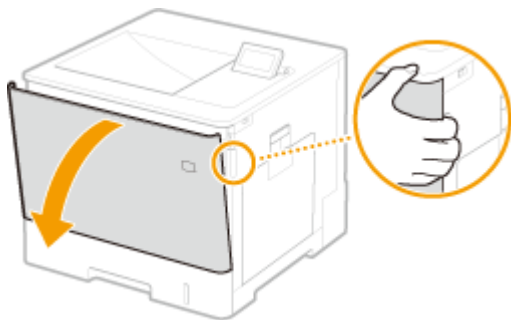

2 Pull out the toner cartridge.

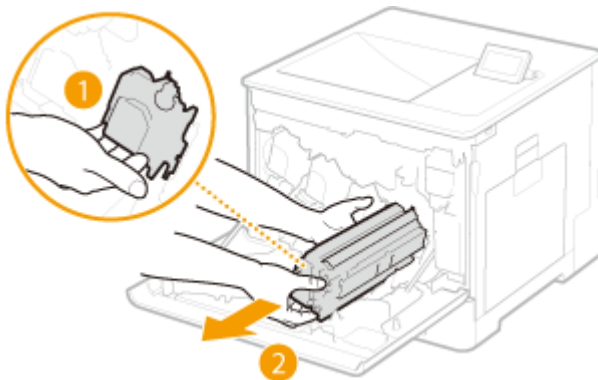

3 Remove the replacement toner cartridge from the protective case.

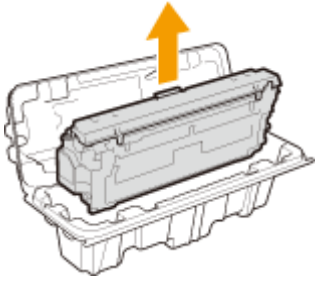

4 Shake the toner cartridge five or six times as shown below to evenly distribute the toner inside the cartridge, and then place it on a flat surface.

- De not remove the drum protective cover (a) in this step.

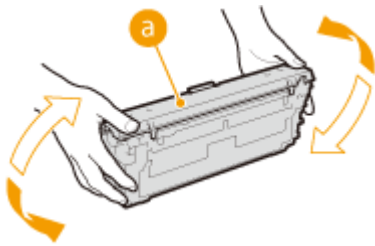

5 Remove the drum protective cover.

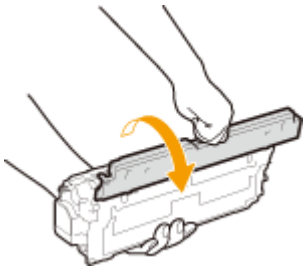

6 Install the toner cartridge.

- Align the toner cartridge with the toner cartridge guide (a) and push it into the slot until it stops.

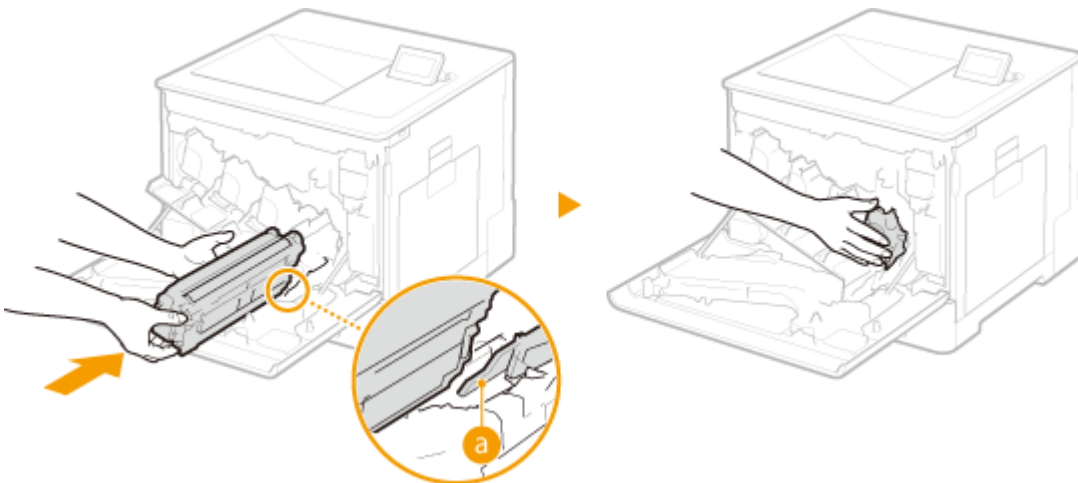

! IMPORTANT:

- Be careful that the drum portion does not get hit against the mouth of the slot.
- Place the toner cartridge into the slot marked with the appropriate color label (b).

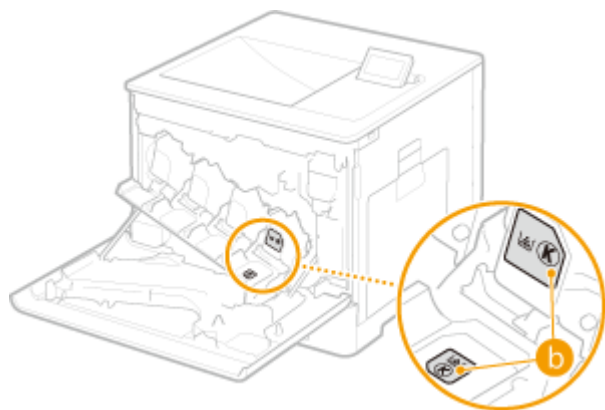

7 Close the front cover.

Replacing the Waste Toner Container

7L2J-085

When the waste toner container is almost full or completely full, a message is displayed prompting you to prepare a new waste toner container or perform waste toner container replacement. Prepare a new waste toner container or perform waste toner container replacement according to the displayed message.

- ▶ **Cautions When Replacing the Waste Toner Container(P. 415)**
- ▶ **Procedure for Replacing the Waste Toner Container(P. 415)**

Cautions When Replacing the Waste Toner Container

CAUTION

- Do not touch the contacts (a) inside the machine. Doing so may result in damage to the machine.

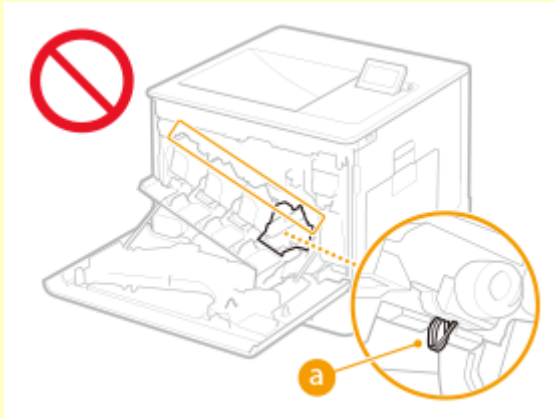

IMPORTANT

- Do not replace the waste toner container before the message prompting you to replace it appears on the display.

NOTE

- The waste toner container is a container for collecting unused toner that remains when printing.
- For details about each message, see ▶ **Countermeasures for Each Message(P. 453)** .
- For information on the model number of the waste toner container, see ▶ **Consumables(P. 418)** .
- You can check the current amount of space remaining in the waste toner container.
▶ **Checking the Remaining Amount of Consumables(P. 421)**

Procedure for Replacing the Waste Toner Container

When replacing the waste toner container, the procedure is also displayed on the screen. Check the information displayed on the screen in addition to the following procedure.

1 Open the front cover.

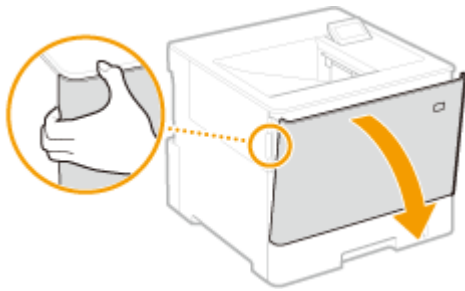

2 Open the left cover.

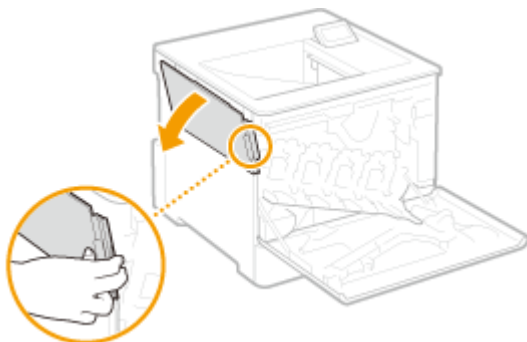

3 Remove the waste toner container together with the left cover.

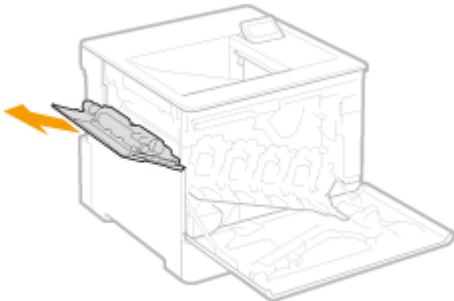

! IMPORTANT:

- Be careful not to tilt the container. Tilting the waste toner container will result in spilling of collected toner.

4 Remove the waste toner container from the protective case.

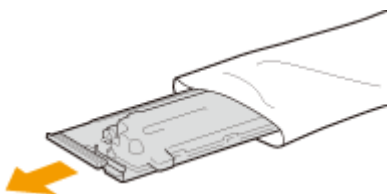

! IMPORTANT:

- Do not disassemble or modify the waste toner container.

5 Install the new waste toner container and close the left cover.

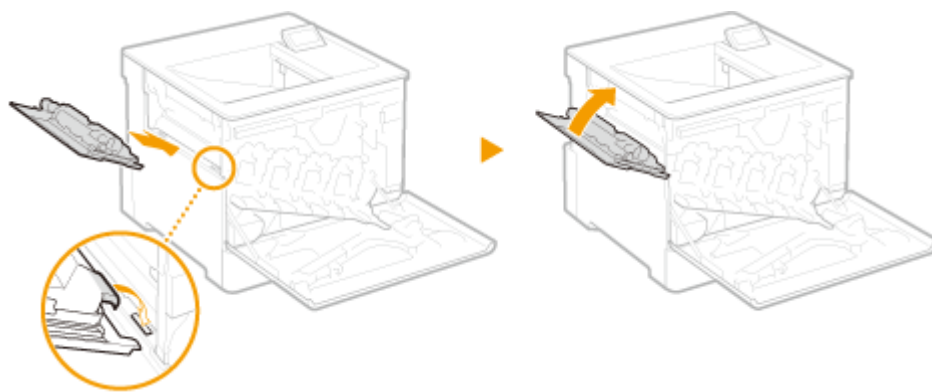

6 Close the front cover.

Replacement Parts

7L2J-086

This section describes the replacement parts (consumables/consumable parts) used by the machine. Follow the precautions when handling and storing the replacement parts.

For optimum print quality, using Canon genuine Toner, Cartridge and Parts is recommended.



▶ **Consumables(P. 418)**

▶ **Consumable Parts(P. 419)**

NOTE

- Depending on the installation environment, printing paper size, or document type, you may need to replace consumables before the end of the estimated lifetime.
- To maintain print quality, the machine performs automatic calibration in accordance with changes in the environmental conditions. The machine may also perform automatic calibration when it is turned ON or recovers from sleep mode. Calibration uses the toner, and accordingly it may result in a decrease of lifetime of the toner cartridges.
- The color toner cartridges are used even in black and white printing. Therefore, much use of black and white printing may also result in decrease in the remaining number of printable pages for each color.
- You can check the current amount of replacement parts remaining.
 - ▶ **Checking the Remaining Amount of Consumables(P. 421)**

Consumables

■ Toner Cartridge for Replacement

Model name	Genuine Canon toner	Weight
imageCLASS X C1538P	<ul style="list-style-type: none"> • Canon Toner T10 Black • Canon Toner T10 Cyan • Canon Toner T10 Magenta • Canon Toner T10 Yellow 	<ul style="list-style-type: none"> • Black: Approx. 1.0 kg • Cyan, Magenta, Yellow: Approx. 0.9 kg

CAUTION

Storing toner cartridges in an improper location or environment may cause problems such as data loss.

- Store toner cartridges in the following conditions:
 - Storage temperature range: 0 to 35°C
 - Storage humidity range: 35% to 85% RH (relative humidity, condensation-free)*

CAUTION

*Even within the approved storage humidity range, water droplets (condensation) may develop inside the toner cartridge if the temperatures inside and outside the toner cartridge differ. Condensation will adversely affect the print quality.

- Store unopened until immediately prior to use.
- Do not store toner cartridges upright or upside down.
- Do not store toner cartridges in the following locations:
 - Locations exposed to open flames
 - Locations exposed to direct sunlight or bright light for five minutes or more
 - Locations exposed to excessively salty air
 - Locations heavily exposed to corrosive gases (e.g. aerosol sprays or ammonia)
 - Very hot and/or humid locations
 - Locations subject to dramatic changes in temperature and humidity likely to cause condensation
 - Very dusty locations
 - Locations within the reach of children
- Store the packaging material safely for future use. It will be needed for situations such as storing the machine with the toner cartridges removed.
- Canon reserves the right to reposition, reshape, add or remove packaging material without notice.

IMPORTANT

Be careful of counterfeit toners

- Please be aware that there are counterfeit Canon toners in the marketplace. Use of counterfeit toner may result in poor print quality or machine performance. Canon is not responsible for any malfunction, accident or damage caused by the use of counterfeit toner.
For more information, see global.canon/ctc.

NOTE

- For information on the collection of used toner cartridges, see the [▶Notice\(P. 505\)](#) .

Consumable Parts

■ Waste Toner Container

Make sure to use the dedicated waste toner container for this machine.

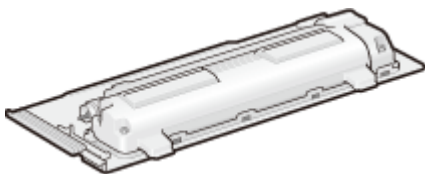

- Waste Toner Box WT-B1

The average number of pages that can be printed per waste toner container is 54,000 sheets (paper size assumed to be A4 or Letter).

NOTE

- When replacing the waste toner container [▶ Replacing the Waste Toner Container\(P. 415\)](#)

Checking the Remaining Amount of Consumables

7L2J-087

Perform the procedures below to check the remaining amount of consumables. In particular, check whether you need to prepare a new toner cartridge before printing a large quantity of documents.



 (Status Monitor) ▶ < Device Status > ▶ < Consumables Information >

TIPS

- You can check the remaining amount of consumables from the Remote UI. [▶Checking the Machine Status\(P. 267\)](#)

LINKS

- ▶[Replacing the Toner Cartridge\(P. 411\)](#)
- ▶[Replacing the Waste Toner Container\(P. 415\)](#)
- ▶[Countermeasures for Each Message\(P. 453\)](#)

Adjusting Print Quality

7L2J-088

Adjust the settings below if printing results are not satisfactory.

■ Gradation Adjustment

If color gradation reproducibility has become so poor that the printed gradation differs markedly from the print data, make adjustments to improve color gradation reproducibility.

▶ **Adjusting Gradation(P. 423)**

■ Automatically Adjusting Color Registration and Color Intensity

Automatic adjustment (calibration) is performed in order to prevent color misregistration and ensure that the original color intensity is correctly reproduced.

▶ **Automatically Adjusting Color Registration and Color Intensity(P. 424)**

■ Print Position Adjustment

You can adjust the print position when printing is lopsided or protruding from the print range.

▶ **Adjusting the Print Position(P. 425)**

■ Toner Amount Reduction

You can prevent excessive toner from being fixed onto paper to reduce print failure such as poor toner fixing or bleed-through.

▶ **Reducing Toner Used When Color Printing(P. 428)**

Adjusting Gradation

7L2J-089

If the gradation of the printing result is significantly different from the original document when you print an image, you can perform adjustment (calibration) to correct the gradation.

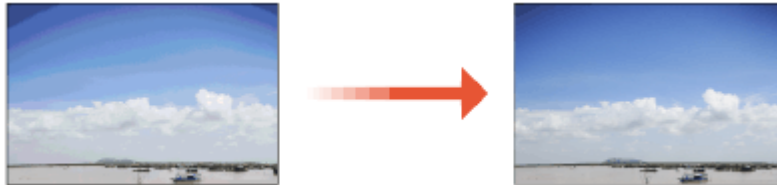

! IMPORTANT

- Frequently performing calibration may affect the life of the toner cartridge.
- Performing calibration when the toner level is low may adversely affect the color balance. If this symptom occurs, it is recommended that you replace the toner cartridge that is low. ▶ **Checking the Remaining Amount of Consumables(P. 421)**

NOTE

- Automatic calibration is performed according to changes in the status and environment of the machine.

1 Select <Set> ▶ <Adjustment/Maintenance> ▶ <Adjust Image Quality> ▶ <Full Calibration>.

2 Press **OK**.

Automatically Adjusting Color Registration and Color Intensity

7L2J-08A

The machine performs automatic adjustment (calibration) in order to prevent color misregistration and ensure that the original color intensity is correctly reproduced. You can set the timing and frequency for performing calibration.

Color misregistration is the phenomenon that occurs when the print position shifts slightly for each color and results in a blurry print result that is out of focus.

Image with color misregistration Image without color misregistration

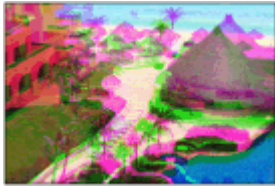

Color intensity refers to the intensity of colors such as red, yellow, green, blue, and purple.

Color intensity not reproduced



Original



Color intensity reproduced



! IMPORTANT

- Frequently performing calibration may affect the life of the toner cartridge.
- Performing calibration when the toner level is low may adversely affect the color balance. If this symptom occurs, it is recommended that you replace the toner cartridge that is low. **▶Checking the Remaining Amount of Consumables(P. 421)**

NOTE

- Automatic calibration is performed according to changes in the status and environment of the machine.

1 Select **<Set>** ▶ **<Adjustment/Maintenance>** ▶ **<Adjust Image Quality>** ▶ **<Settings for Auto Full Calibration>**.

2 Set **<Timing for Auto Full Calib. at Startup>** and **<Frequency for Auto Full Calibration>**.

Timing for Auto Full Calib. at Startup

Select the timing for automatically performing calibration after the power is turned ON.

Frequency for Auto Full Calibration

Set the frequency for automatically performing calibration. Set this item to **<High>** if color misregistration often occurs.

Adjusting the Print Position

7L2J-08C

You can adjust the print position when printing is lopsided or protruding from the print range. The print position can be adjusted for each paper source.

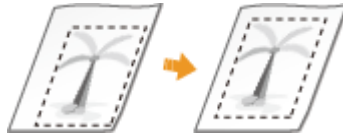

NOTE

- Ensure that the following are set correctly before performing print position adjustment.
 - Setting the paper source to adjust (**Custom Settings(P. 332)** ▶ <Paper Feed> ▶ <Default Paper Feed Source>)
 - Setting the print mode (1-Sided/2-Sided) to adjust (**Custom Settings(P. 332)** ▶ <2-Sided Printing>)
 - Setting the paper type to feed **Specifying Paper Size and Type(P. 91)**
- When performing print position adjustment, set the correct paper type for the paper source, rather than selecting <Free>.

Step 1: Printing the Current Print Position(P. 425)

Step 2: Confirming the Direction and Distance for Adjustment(P. 425)

Step 3: Adjusting the Print Position for Each Paper Source(P. 426)

Step 1: Printing the Current Print Position

You can print a sample print to confirm the direction and distance for adjustment.

- 1** Select <Set> on the <Home> screen. **Home> Screen(P. 81)**
- 2** Select <Adjustment/Maintenance> ▶ <Adjust Image Quality> ▶ <Adjust Print Position>.
- 3** Select <Print Sample> ▶ <Yes>, and press **OK**.

⇒ A sample print is output.

Step 2: Confirming the Direction and Distance for Adjustment

Marks for confirming the print position are printed on the sample print. The position of these marks determines the direction and distance for adjustment. Normally, all marks are printed on the edge of the paper.

Viewing the Sample Print

The lead edge of the output paper is the top edge of the sample print. Remember which edge is the top edge when picking up the paper.

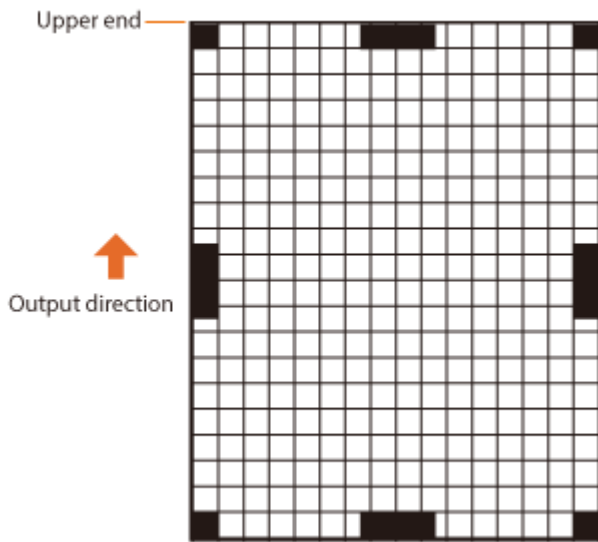

- The size of the marks for confirming the print position is indicated below.

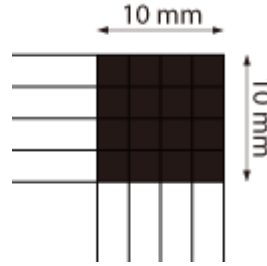

When the Print Position Is Lopsided

Print position adjustment is required when the marks for confirming the print position are lopsided. The direction of the print position can be specified using a positive value (+) or negative value (-), and the distance can be specified in millimeters. To perform vertical adjustment, set a negative value (-) to move the print position up or a positive value (+) to move the print position down. To perform horizontal adjustment, set a negative value (-) to move the print position left or a positive value (+) to move the print position right.

Vertical direction

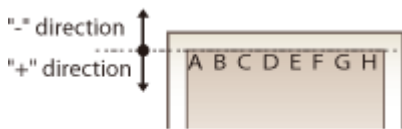

Horizontal direction

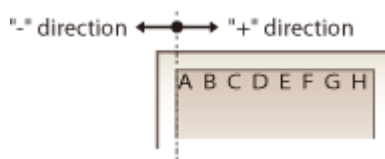

In the following example, because it is necessary to shift the print position 3.5 mm up and 1.5 mm to the right, specify -3.5 mm in the vertical direction and +1.5 mm in the horizontal direction.

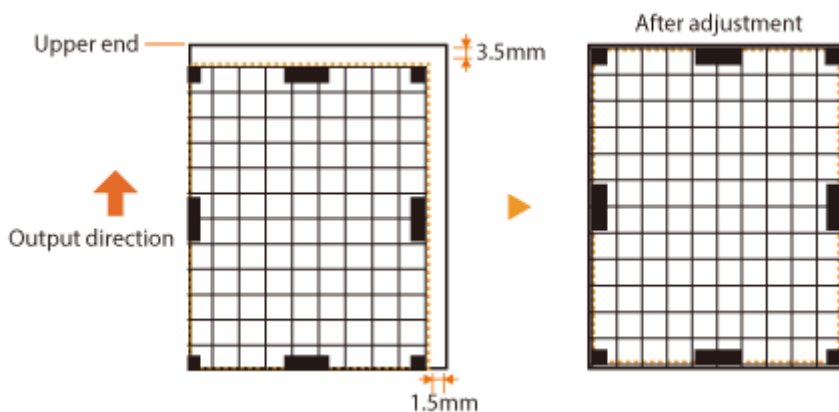

Step 3: Adjusting the Print Position for Each Paper Source

Adjust the print position after confirming the direction and distance for adjustment. The print position can be adjusted in the range -3.5 mm to +3.5 mm in both the horizontal and vertical directions, in 0.1 mm increments.

- 1 Select <Set> on the <Home> screen. ◀<Home> Screen(P. 81)

2 Select <Adjustment/Maintenance> ▶ <Adjust Image Quality> ▶ <Adjust Print Position>.

3 Select the paper source to adjust or <Common> to adjust all paper sources.

NOTE:

Print position adjustment in the vertical direction for 2-sided printing

- The print position for the first page (front side) of two-sided printing can be adjusted with <Common>. The print position for the second page (back side) can be adjusted with the setting for each paper source.

■ Example of print position adjustment

First page (front side)	Setting value for <Common> ▶ <Adj. Vertically (1st Side for 2-Sided)>
Second page (back side)	Setting value for each paper source ▶ <Adj. Vertically (1-Sd/2nd Sd for 2-Sd)>

4 Select the direction to adjust and the combination of one-sided/two-sided printing, and press **OK**.

5 Set the adjustment value, and press **OK**.

- Enter the value based on the print result of the sample print using ▲/▼.
- For <Adj. Vertically (1st Side for 2-Sided)>, the print position of all paper sources is adjusted with the entered value.
- Repeat steps 3 to 5 to adjust the other positions and paper sources.

6 Output a sample print, and check whether adjustment has been performed correctly. ▶Step 1: Printing the Current Print Position(P. 425)

Reducing Toner Used When Color Printing

7L2J-08E

Fixing of excessive toner onto paper may cause color print failures such as generation of afterimages of highly dense characters or lines. Reducing the amount of toner to be fixed may improve this failure.



NOTE

- This function may improve the following failures.
 - Toner scattering around deep color areas of printed images
 - Poor toner fixing in a low-temperature environment
 - Darkening of images printed on transparencies at the time of projection
- Use of this function may give an adverse effect on color printing quality.

1 Select <Set> ▶ <Adjustment/Maintenance> ▶ <Adjust Image Quality> ▶ <Adjust Toner Volume Used for Color Print>.

2 Select the toner volume setting and press **OK**.

- <Off> prints with the standard toner volume.
- <Level 1> prints deep color areas with a bit smaller toner volume than the standard volume.
- <Level 2> generally prints with a reduced toner volume.

Paper Type Management Settings

7L2J-08F

You can register and edit detailed information of frequently used paper types as the [Custom Type].

To register a new paper type, first duplicate the paper type that resembles the new type in order to copy all of the internal operational parameters. This procedure copies the suitable settings to the new paper type from the registered custom paper easily.

You can also improve printing quality and paper feeding trouble by editing the custom paper, depending on the characteristics.

NOTE

- It is necessary to log in as an administrator to register custom paper types or change the settings of registered custom paper types. [▶Logging into the Machine\(P. 90\)](#)
- When you register the custom paper type, you cannot specify the paper source. For more information on registering the paper source, see [▶Specifying Paper Size and Type in the Paper Drawer\(P. 92\)](#) .
- You can import/export the registered custom paper type information, and share it with another Canon machine. [▶Importing/Exporting All Settings\(P. 275\)](#)

[▶Registering frequently used paper types\(P. 429\)](#)

[▶Items that can be specified\(P. 431\)](#)

Registering frequently used paper types

- 1** Start the Remote UI. [▶Starting the Remote UI\(P. 262\)](#)
- 2** Click [Settings/Registration] on the Portal page. [▶Remote UI Screen\(P. 263\)](#)
- 3** Click [Paper Settings] ▶ [Paper Type Management Settings].
- 4** Select the paper type to edit.

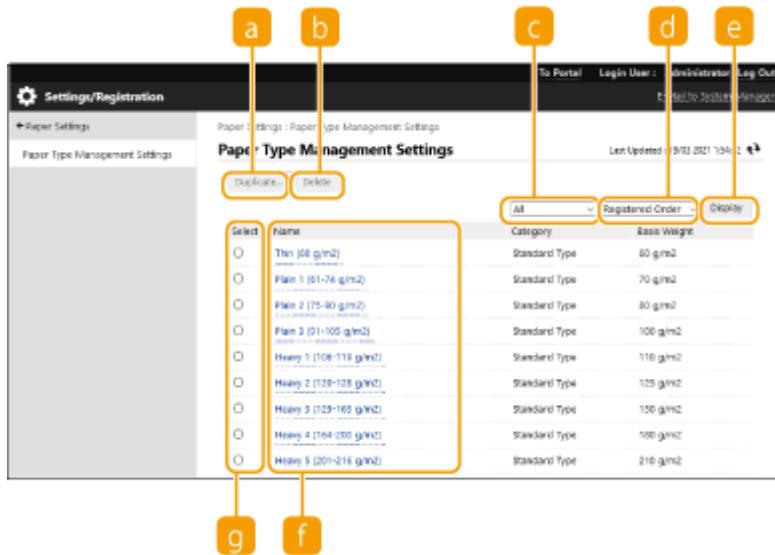

a [Duplicate]

Duplicates the paper type selected in [Select] as a custom paper type.

b [Delete]

Deletes the paper type selected in [Select].

! IMPORTANT:

- Only paper types with [Custom Type] displayed for [Category] can be deleted.

c Paper type drop-down list

Enables you to select the paper type to display.

d Sort List By

Enables you to change the display order of the list.

e [Display]

Switches the list display to the items selected in **c** and **d**.

f [Name]

Displays [Paper Details] when you click the paper type displayed in [Name]. If you select a custom paper type, you can edit it.

g [Select]

Select a paper type to duplicate or delete.

5 Select [Edit] and configure the various settings.

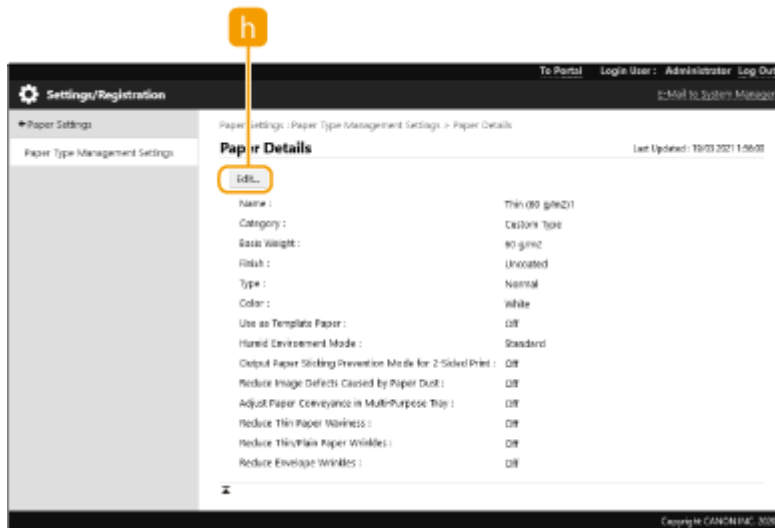

h [Edit]

Appears on the [Paper Details] screen for the custom paper type and enables you to change the settings for the selected item.

! IMPORTANT:

- Only paper types with [Custom Type] displayed for [Category] can be edited.

6 Click [OK] .

Items that can be specified

The following items can be specified.

■ [Name]

You can change the name of the custom paper type.

NOTE

- When you register the settings for the custom paper type, make sure to change its name. You cannot change the settings of the default paper types registered in the machine.

■ [Basis Weight]

You can change the basis weight of the custom paper type.

! IMPORTANT

- If you enter a value that is different from the actual weight of the set paper, paper jams may occur, and the quality of the image may be adversely affected.

■ [Finish]

You can change the Finish setting of Custom Type you have registered.

IMPORTANT

- If you select a finishing type which is different from that of the loaded paper, paper jams may occur, and the quality of the image may be adversely affected.

■ [Type]

You can change the Type setting of Custom Type you have registered.

IMPORTANT

- If you select a paper type which is different from that of the loaded paper, paper jams may occur, and the quality of the image may be adversely affected.

■ [Color]

You can change the color of the custom paper type.

IMPORTANT

- If you select a color which is different from that of the loaded paper, paper jams may occur, and the quality of the image may be adversely affected.

■ [Use as Template Paper]

You can select [Use as Template Paper] to use preprinted paper (paper which has logos already printed on it), such as a letterhead.

NOTE

- Methods for loading paper if [Use as Template Paper] is selected:
 - Paper source other than the multi-purpose tray: the side with a logo facing down
 - Multi-purpose tray: the side with a logo facing up

■ [Humid Environment Mode]

Print problems may occur due to humidity in the environment of the machine. This setting may improve this problem.

NOTE

- Set this in the following cases. The print results may be improved.
 - [High Humidity]: Set this if the print density is light or irregular when using the machine in a high humidity environment.

- [Low Humidity 1]: Set this if images and text are blurred when using the machine in a low humidity environment.
- [Low Humidity 2]: Set this if images show toner scattering or shaded parts of the image have white patches (areas left white) when using the machine in a low humidity environment.
- Set [Standard] to not use either setting.

■ [Output Paper Sticking Prevention Mode for 2-Sided Print]

Paper may get stuck together when performing two-sided printing, depending on the image density of the print data. This setting may improve this problem.

NOTE

- [Mode 2] is better at preventing pages from being stuck together than [Mode 1], but the print speed becomes slower when performing two-sided printing.

■ [Reduce Image Defects Caused by Paper Dust]

Using paper with a large amount of paper dust may cause images to be printed faintly or with streaks. This setting may improve this problem.

NOTE

- When selected, the print speed may be slower.

■ [Adjust Paper Conveyance in Multi-Purpose Tray]

Corrects paper feeding problems that occur due to a low paper feeding speed when feeding from the multi-purpose tray.

NOTE

- When selected, the print speed may be slower.

■ [Reduce Thin Paper Waviness]

This setting may improve wrinkling or curling when printing on thin paper.

NOTE

- When selected, printing may be faint.

■ [Reduce Thin/Plain Paper Wrinkles]

Wrinkling may occur when printing on Thin, Plain 1, Plain 2, or Plain 3. This setting may improve this problem.

NOTE

- When selected, the print speed may be slower.

■ [Reduce Envelope Wrinkles]

Wrinkling may occur when printing on envelopes. This setting may improve this problem.

NOTE

- When selected, printing may be faint.

Checking the Number of Pages for Print

7L2J-08H

You can check separate totals for the number of pages used for color printouts and black and white printouts. The number of printouts includes printouts of the memory media print and the list as well as printouts of data from computers.

1 Select **<Check Counter>** on the **<Home>** screen. ▶ **<Home> Screen(P. 81)**

2 Select **<Counter Information>**.

3 Check the total number of printed pages.

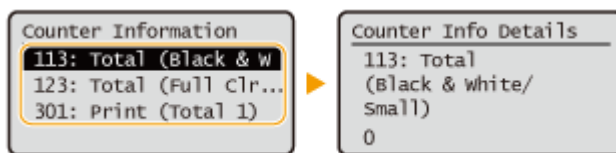

<113: Total (Black & White/Small)>

Displays the total number of black-and-white pages printed.

<123: Total (Full Clr + Single Clr/Small)>

Displays the total number of color pages printed.

<301: Print (Total 1)>

Displays the total number of pages printed.

NOTE

- Press **<Monitoring Service>** ▶ **<Communication Test>** to check communication with the remote monitoring server. When this function is executed, information on the machine is periodically sent to the remote monitoring server. It is necessary to enable communication between the machine and the server providing the service in order to use this function.
- You can print a list that shows the number of pages used for printing.
 - ▶ **Output Report(P. 354)** ▶ **<Counter Report>**
- For information on the count conditions, contact your dealer or service representative.

Printing Reports and Lists

7L2J-08J

You can print reports and lists of several types of information, such as consumable status, print history, and settings.

For more information on the reports and lists, see [▶<Output Report>\(P. 403\)](#) .

Troubleshooting

Troubleshooting	438
If the Machine Does Not Operate	439
Cannot Print	441
Problems with Printing Results	442
Problems with the Network	445
Problems with Security	449
Other Problems	450
A Message or a Number Starting with "#" (an Error Code) Is Displayed	451
A Message Saying to Contact Your Dealer or Service Representative Is Displayed	452
Countermeasures for Each Message	453
Countermeasures for Each Error Code	477
Clearing Paper Jams	485
Paper Jams inside the Machine or in the Fixing Unit	487
Paper Jams in a Paper Source	491

Troubleshooting

7L2J-08K

If a problem occurs while you are using the machine, check the following items first. If the problem cannot be solved or an inspection is required, contact your dealer or service representative.

■ What kind of problem do you have?



▶ If the Machine Does Not Operate(P. 439)



▶ Cannot Print(P. 441)



▶ Problems with Printing Results(P. 442)



▶ Problems with the Network(P. 445)



▶ A Message or a Number Starting with "#" (an Error Code) Is Displayed(P. 451)



▶ Problems with Security(P. 449)



▶ Other Problems(P. 450)



▶ Clearing Paper Jams(P. 485)

If the Machine Does Not Operate

7L2J-08L

If a problem occurs while you are using the machine, check the following before contacting your dealer or service representative.

- ▶ **Check This First(P. 439)**
- ▶ **If the machine does not respond to computer operations(P. 439)**
- ▶ **When the authentication screen (login screen) is displayed(P. 440)**

Check This First

→ Is a message displayed on the screen?

- A message is displayed on the screen when an error or a problem occurs while operating the machine.
 - ▶ **A Message or a Number Starting with "#" (an Error Code) Is Displayed(P. 451)**

→ Is (Energy Saver) lit?

- If it is lit, press  (Energy Saver) to cancel the Sleep mode.

→ Is the machine connected to a computer correctly?

- Check the network connection of the machine and the computer.
 - ▶ **Setting up the Network Environment(P. 8)**

If the machine does not respond to computer operations

→ Restart the machine.

- If the machine does not respond even though its power is turned ON, turn the power OFF (▶ **Turning OFF the Machine(P. 62)**). Confirm that the power cord is connected correctly, wait 10 or more seconds after the main power is turned OFF, and then turn the power back ON (▶ **Turning ON the Machine(P. 61)**).

→ Check whether the driver is installed correctly.

- For information on installing the driver, see ▶ **Installing Drivers(P. 44)** .

→ Check whether the IP address of the machine is correct.

- Check the IP address settings, and change them if they are incorrect. For information on the settings, see ▶ **Setting up Using the Setup Guide(P. 6)** .

When the authentication screen (login screen) is displayed

→ Log in as a registered user.

- When the authentication screen (login screen) is displayed, you must log in as a registered user to continue operating the machine.
 - ▶ **Logging into the Machine(P. 90)**

Cannot Print

7L2J-08R

Check This First

→ Is the Processing/Data indicator (on the control panel) flashing or lit?

- If it is flashing or lit, there is a document that is being processed or waiting to be processed. Wait for the processing to finish or select the document that you want to prioritize from the screen for checking the printing status.
 - ▶ **Checking the Printing Status and History(P. 114)**
 - ▶ **Printing Documents Held in the Machine(P. 116)**

→ Is a message displayed on the screen?

- A message is displayed on the screen when an error or a problem occurs while operating the machine.
 - ▶ **A Message or a Number Starting with "#" (an Error Code) Is Displayed(P. 451)**

→ Is <Auto Select> set to <No>?

- To switch to the appropriate operation mode, change all items or the items you are using to <Yes>. For more details, see Setting the Machine (PS/PCL/UFR II Printer) via the online manual site.

→ Is forced hold printing enabled?

- If it is enabled, documents may not be printed, depending on their settings.
 - ▶ **Configuring the Forced Hold Printing Settings(P. 255)**

→ Are you printing via a print server using the LPR command?

- When continuously printing PDF data using the LPR command, execute one job at a time at the interval set in <Timeout>. For more details, see Setting the Machine (PS/PCL/UFR II Printer) via the online manual site.

Problems with Printing Results

7L2J-08S

- ▶ The printed image is displaced or skewed.(P. 442)
- ▶ Images are uneven or faint.(P. 442)
- ▶ Images are not printed on the intended side of the paper.(P. 442)
- ▶ Images are not printed in the intended size.(P. 442)
- ▶ The orientation does not match on both sides of the paper when using two-sided printing.(P. 443)

The printed image is displaced or skewed.

→ Are the paper guides misaligned?

- Match the paper guides with the paper loaded in the paper source.

Images are uneven or faint.

→ Is the paper damp?

- Replace the paper with paper that is not damp.

→ Are the gradation and density set appropriately?

- Perform gradation adjustment.
 - ▶ **Adjusting Gradation(P. 423)**

Images are not printed on the intended side of the paper.

→ Is the orientation of the loaded paper correct?

- Check the orientation and side of the paper that is facing up. Load the paper again if it is incorrectly orientated.
 - ▶ **Loading Paper(P. 63)**

Images are not printed in the intended size.

→ Do the original size and size of the paper that is loaded match?

- Replace the paper that is loaded with paper of the size you want to print on.
- Match [Output Size] in the printer driver with the size of paper to print on.

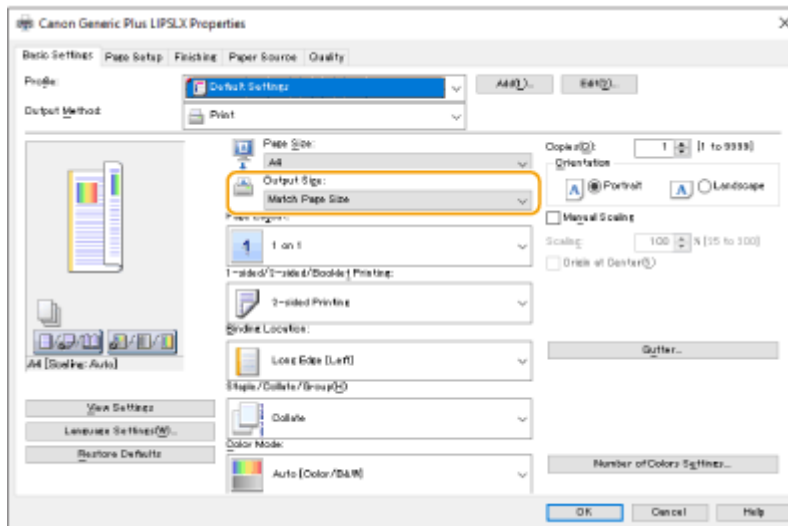

The orientation does not match on both sides of the paper when using two-sided printing.

→ Are the settings for two-sided printing correct?

- Follow the procedure below to check the print settings.

- 1 Select the orientation of the original on the print settings screen of the application.
- 2 On the [Basic Settings] screen of the driver, set [Orientation] to the same orientation you set in step 1.

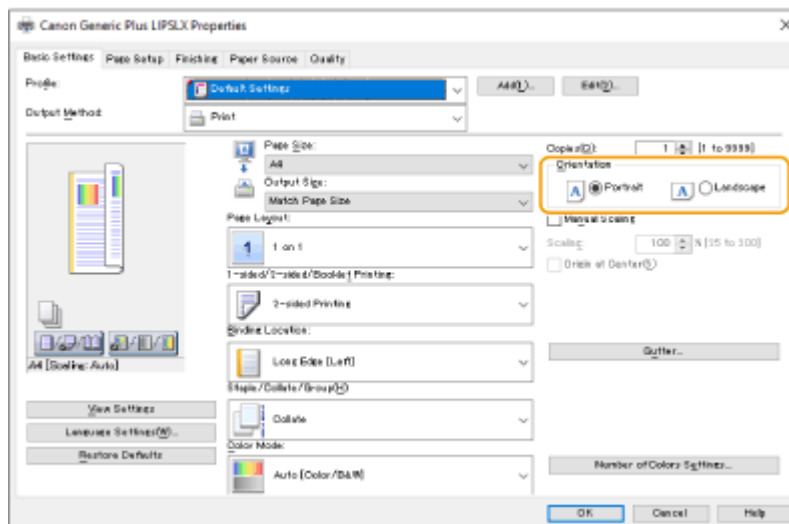

- 3 While checking the print preview, set [Page Layout] ► [Page Order] ► [1-sided/2-sided/Booklet Printing] ► [Binding Location].

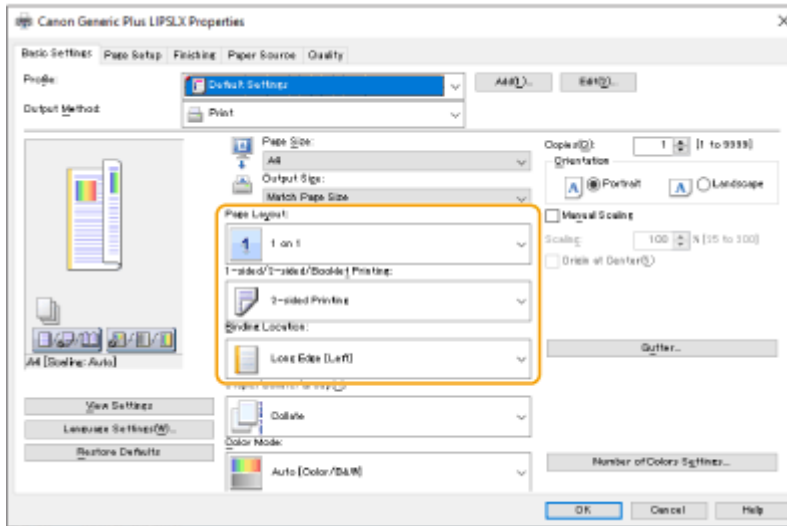

NOTE

- [Page Order] is displayed when [Page Layout] is set to [2 on 1] or higher.

Problems with the Network

7L2J-08U

▶ **Problems with Connections(P. 445)**

▶ **Problems with Wireless Connections(P. 446)**

Problems with Connections

→ Cannot set up the network.

- Check whether <Confirm Network Connection> is set to <On>.
 - ▶ **<Confirm Network Connection>(P. 362)**

→ An unintended destination is dialed up.

- If a dial-up router is on the network to which the machine is connected, the machine connects to a destination other than the intended destination, depending on the settings of the machine or dial-up router. This may result in subscriber line charges and call charges. Check the following.
- If the dial-up router does not have to send packets via broadcast, change the router settings to ensure that it sends packets via a method other than broadcast. If it is necessary to allow broadcasting with the dial-up router, check whether an unnecessary destination is set.
- Check whether the host name and IP address of the file server and mail server, etc. set in the machine are correct.
- If the DNS server is on an external server, use the IP address instead of the host name for the destination, even when connecting to devices on the same network as the machine.
- If the DNS server is on the network that the machine is connected to, check whether the information for devices connected to an external network is registered on the DNS server, and whether it is correct.

→ Cannot recognize the machine from a computer.

- If the IP address of the computer where the Remote UI and utility software are executed is not allowed for sending and receiving in <Firewall Settings>, the information for the machine cannot be displayed on the computer. Check whether the settings are correct.
 - ▶ **Specifying IP Addresses in Firewall Settings(P. 213)**
- When using device management software, set [Use Dedicated Community] to [On] and select [Read/Write] for [MIB Access Permission]. Also set [Dedicated Port Settings] to [On].
 - ▶ **Monitoring and Controlling the Machine with SNMP(P. 34)**
- The machine cannot be recognized when utility software is used to access the machine with a community name other than the SNMP community name set in the machine. Check the SNMP community name.
 - ▶ **Monitoring and Controlling the Machine with SNMP(P. 34)**
- If the message "An error has occurred." is displayed in the Web browser and the Remote UI cannot be started, invalid cache data may remain. Clear the cache of the Web browser.
- If the machine enters the Sleep mode, it may not be able to be recognized from a computer. Cancel the Sleep mode or change <Sleep Mode Energy Use> to <High>.
 - ▶ **<Sleep Mode Energy Use>(P. 360)**

Problems with Wireless Connections

→ Cannot connect wireless LAN and wired LAN at the same time.

- You cannot connect wireless LAN and wired LAN at the same time. USB and wireless LAN or USB and wired LAN can be used at the same time.

→ The Remote UI is not displayed.

- Are <Use HTTP> and <Remote UI Settings> set to <On>?
 - ▶<Use HTTP>(P. 365)
 - ▶Starting the Remote UI(P. 262)
- If you are connected with wireless LAN, restart the Remote UI after checking whether the IP address is set correctly.
 - ▶Conducting a Connection Test for an IPv4 Address(P. 24)
 - ▶Conducting a Connection Test for an IPv6 Address(P. 26)
- If you are connected with wired LAN, restart the Remote UI after checking whether the IP address is set correctly and the cable is connected correctly.
 - ▶Connecting to a Wired LAN(P. 12)
 - ▶Starting the Remote UI(P. 262)
- Are you using a proxy server? If so, add the IP address of the machine in "Exceptions" (addresses to not use a proxy for) in the proxy server settings of the Web browser.
- Is communication with computers restricted in the firewall? If the Remote UI cannot be displayed because the settings are incorrect, set <IPv4 Address Filter>, <IPv6 Address Filter>, or <MAC Address Filter> to <Off> from the control panel of the machine.
 - ▶Restricting Communication by Using Firewalls(P. 212)
 - ▶<Network>(P. 362) ▶ <IPv4 Address Filter>
 - ▶<Network>(P. 362) ▶ <IPv6 Address Filter>
 - ▶<Network>(P. 362) ▶ <MAC Address Filter>

→ Cannot connect to the network.

- The IP address may have failed to be set. Set the IP address again.
 - ▶Setting an IP Address(P. 22)
- If you are connected with wireless LAN, check whether the machine can connect to the network.
 - ▶If you cannot connect to a wireless LAN(P. 447)

→ If you do not know the IP address that was set.

- Press the  (Status Monitor) key and check the IP address.
 - ▶Control Panel(P. 59)
- If you want to know the details of the settings or change the settings, select <Set> on the <Home> screen and configure the settings.
 - ▶Setting an IP Address(P. 22)

→ **Cannot change from wired LAN to wireless LAN or wireless LAN to wired LAN.**

- Did you also switch the LAN setting from the control panel of the machine? You cannot change the connection method of the machine unless you do so.

▶ **Selecting the Network Connection Method(P. 10)**

→ **If you do not know the SSID and network key of the wireless LAN router to connect to or the SSID is not displayed on the screen.**

- Check whether the SSID is displayed on the wireless LAN router or its box.

▶ **Checking the SSID and Network Key(P. 21)**

→ **The SSID of the wireless LAN router to connect to is not displayed in the list of access points.**

- Check whether the SSID of the wireless LAN router that you made a note of is correct.

▶ **Checking the SSID and Network Key(P. 21)**

- If the SSID of the wireless LAN router is not disclosed (if it is using the stealth function*), set the wireless LAN router to disclose the SSID.

* This function prevents the SSID of a wireless LAN router from being automatically detected.

- Check whether the machine is connected to the network.

▶ **If you cannot connect to a wireless LAN(P. 447)**

If you cannot connect to a wireless LAN



Check the status of the computer.

- Is setup of the computer and wireless LAN router complete?
- Are any of cables of the wireless LAN router (power cable, LAN cable, etc.) disconnected?
- Is the wireless LAN router turned ON?

If the problem is still not resolved:

- Turn all the devices off, and then on again.
- After waiting a while, check whether you can connect to the network.



Check whether the machine is turned ON.

If the machine is turned ON, turn it OFF, and then ON again.



Check the installation location of the machine and wireless LAN router.

- Are the machine and wireless LAN router too far away from each other?
- Is there an obstacle such as a wall between the machine and wireless LAN router?
- Are there any devices that emit electromagnetic waves nearby, such as a microwave or digital cordless telephone?

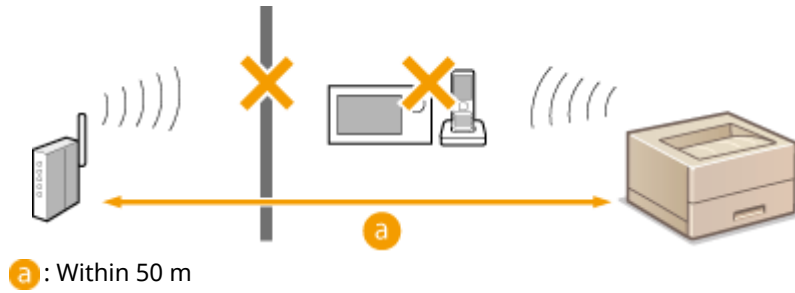

Specify the following settings again.

- ▶ Setting Up the Connection Using WPS Push Button Mode(P. 16)
- ▶ Setting Up the Connection Using WPS PIN Code Mode(P. 17)
- ▶ Setting Up Connection by Selecting a Wireless Router(P. 18)
- ▶ Setting Up a Connection by Specifying Detailed Settings(P. 19)

NOTE

If settings require manual entry

- If the wireless LAN router is set as follows, perform manual entry (▶ Setting Up a Connection by Specifying Detailed Settings(P. 19)):
 - ANY rejection* is enabled.
 - An automatically generated WEP key (hexadecimal) is set.
 - The stealth function is enabled.
- * A wireless LAN router function for refusing connections if the device trying to connect has "ANY" or "blank" set for the SSID.

If it is necessary to change the settings on the wireless LAN router side

- If the wireless LAN router is set as follows, change the settings on the router side:
 - MAC address filtering is set.
 - WEP is selected or WPA/WPA2 encryption is set for the TKIP when communicating only with IEEE 802.11n.

Problems with Security

7L2J-08W

- ▶ The settings in <Set> are not restored even though the check box is deselected in the security policy settings. (P. 449)
- ▶ Cannot import security policy settings.(P. 449)
- ▶ A security administrator password entry screen is displayed even though no password is set.(P. 449)

The settings in <Set> are not restored even though the check box is deselected in the security policy settings.

- Items changed with security policy settings applied are not restored simply by deselecting the check box. Deselect the check box, and change the corresponding settings from [Settings/Registration] in the Remote UI.

Cannot import security policy settings.

- Have you set a different security policy password from the source device? Remove the password in the destination device or set the same password as the source device.
 - ▶ **Using a Password to Protect the Security Policy Settings(P. 163)**

A security administrator password entry screen is displayed even though no password is set.

- If you import security policy settings, the same password is set for the destination device if a security policy password is set in the source device. Check the password of the source device.

Other Problems

7L2J-08X

- ▶ **Cannot press a button, select an item, or an item is not displayed.(P. 450)**
- ▶ **Some settings imported from another device are not reflected.(P. 450)**
- ▶ **Log files are garbled.(P. 450)**
- ▶ **Log events are not recorded even though log collection was started.(P. 450)**
- ▶ **The setting for K-size paper is not displayed.(P. 450)**

Cannot press a button, select an item, or an item is not displayed.

- Some settings can only be used by the administrator. They cannot be used by general users.
 - ▶ **Settings/Registration(P. 295)**
- The system administrator limits the functions that general users can use to prevent unauthorized use, and restricts the use of functions.
- The functions that can be used with User Authentication are managed by the administrator. These functions can be used by logging in using an ID with access privileges.
 - ▶ **Logging into the Machine(P. 90)**
- Functions cannot be used because the optional equipment or system options that they require are not installed.
- The settings are managed with security policy settings. To change the settings, it is necessary to log in to the Remote UI with administrator privileges.
 - ▶ **Configuring the Security Policy Settings(P. 165)**

Some settings imported from another device are not reflected.

- If a security policy is set, settings that violate the security policy cannot be imported.

Log files are garbled.

- When opening CSV files with Microsoft Excel, the content may not be recognized as text strings and may become garbled as a result. If this happens, open the files with a CSV file editor or text editor.

Log events are not recorded even though log collection was started.

- Results may not be reflected in a log file if it is retrieved immediately after log collection is started. Since it takes some time to collect logs, retrieve the log file again after waiting a while.

The setting for K-size paper is not displayed.

- You can use K-size paper by changing the machine settings. For more information, contact your dealer or service representative.

A Message or a Number Starting with "#" (an Error Code) Is Displayed

7L2J-08Y

If a message is displayed on the screen of the machine or the Remote UI, or a number starting with "#" (an error code) is displayed on the details screen for job log or a communication management report, refer to the following to check the remedy.

- ▶ **A Message Saying to Contact Your Dealer or Service Representative Is Displayed(P. 452)**
- ▶ **Countermeasures for Each Message(P. 453)**
- ▶ **Countermeasures for Each Error Code(P. 477)**

A Message Saying to Contact Your Dealer or Service Representative Is Displayed

7L2J-090

If the machine cannot operate normally due to a problem, a message is displayed on the screen. Check the reference according to the displayed message.

▶ **When a message saying to contact your dealer or service representative is displayed(P. 452)**

When a message saying to contact your dealer or service representative is displayed

1 Restart the machine.

- Press the power switch to turn the power OFF (▶ **Turning OFF the Machine(P. 62)**), wait for longer than 10 seconds, and then turn the power ON again (▶ **Turning ON the Machine(P. 61)**).

IMPORTANT:

- Note that data waiting to be processed is erased when you turn the power OFF.

2 If the message is still displayed, prepare the following information.

- Product name
- Your dealer or service representative where you purchased the machine
- The problem (the specific operation you performed and the result and symptom, etc.)
- Code displayed on the screen

3 Turn the power of the machine OFF, pull out the power plug, and contact your dealer or service representative.

WARNING

- Do not connect or disconnect the power cord with wet hands, as this may result in electrical shock.

CAUTION

- Always grasp the power plug when disconnecting the power cord. Pulling on the power cord may expose or snap the core wire, or otherwise damage the power cord. If the power cord is damaged, this could cause current to leak, resulting in a fire or electrical shock.

Countermeasures for Each Message

7L2J-091

If an error occurs during printing, or if a problem occurs with the network connection or settings, a message appears on the machine display or the Remote UI screen. For details about each message and solutions to the problems, refer to the messages below. Also, if a six-digit number is displayed when you are logging in, see **▶If a six-digit number is displayed when you are logging in(P. 470)** .

23 MEMORY FULL

There is insufficient memory to register overlay forms and external characters, etc.

- Cancel printing (**▶Canceling Printing(P. 112)**), initialize the printer to increase the free memory, and then try printing again. However, note that initializing the printer will erase all the print data in the memory of the machine. For more details, see Setting the Machine (PS/PCL/UFR II Printer) via the online manual site.
- Select <Skip Error>, and continue printing. However, the data that could not be registered due to a lack of memory will not be printed.

27 JOB REJECT

The specified emulation does not exist.

- Specify emulation that the machine supports. For more details, see Setting the Machine (PS/PCL/UFR II Printer) via the online manual site.
- Select <Skip Error> to skip the printing that an error occurred for. You can perform the following printing.

33 WORK FULL

Could not print because the dedicated work memory was insufficient.

- Cancel printing (**▶Canceling Printing(P. 112)**), initialize the printer to increase the free memory, and then try printing again. However, note that initializing the printer will erase all the data in the memory of the machine. For more details, see Setting the Machine (PS/PCL/UFR II Printer) via the online manual site.
- Select <Skip Error>, and continue printing. However, the data for which an error was displayed will not be printed correctly. Also note that registered data such as overlay forms and macros may be deleted.

52 IMAGEMODE REJECT

Data that cannot be processed was sent while printing an image.

- Select <Skip Error> to skip the printing that an error occurred for. However, the data for which an error was displayed will not be printed.
- Perform printing again using a printer driver that supports the data format of the image.

Could not verify the CRL.

Could not confirm the CA certificate of the certificate authority that issued the certificate revocation list (CRL).

- Register the CA certificate of the certificate authority that issued the certificate revocation list (CRL).
▶Registering a CA Certificate(P. 233)

D1 Replot Buffer Full

Could not redraw because data could not be registered to the replot buffer.

- Select <Skip Error>, and continue printing. However, the data that caused the error will not be printed correctly. For information on the replot buffer, see Setting the Machine (PS/PCL/UFR II Printer).

D1 Div. Print. Bffr Full

Could not perform divided printing because data could not be registered to the buffer for divided printing.

- Cancel printing (**▶Canceling Printing(P. 112)**), set <Divide Mode> to <No> and <Enlarge/Reduce> to <Auto> in the HP-GL setup menu, specify the output paper size, and perform printing again. However, the data will be enlarged/reduced when printed. For more details, see Setting the Machine (PS/PCL/UFR II Printer).
- Select <Skip Error>, and continue printing. However, the data that could not be registered will not be printed correctly. For information on divided printing, see Setting the Machine (PS/PCL/UFR II Printer).

D1 Polygon Buffer Full

Could not draw because data could not be registered to the polygon buffer.

- Select <Skip Error>, and continue printing. However, the data that could not be registered will not be printed correctly. For information on the polygon buffer, see Setting the Machine (PS/PCL/UFR II Printer).

D0-nn error (nn is two alphanumeric characters)

The printer stopped operating normally due to an unknown problem.

- Restart the machine. Press the power switch to turn the power OFF (**▶Turning OFF the Machine(P. 62)**), wait for longer than 10 seconds, and then turn the power ON again (**▶Turning ON the Machine(P. 61)**). If the message is still displayed after restarting the machine, make a note of the message and contact your dealer or service representative.

FF FONT FULL

Could not register font information in the font table because there were too many fonts to register.

- Cancel printing (**▶Canceling Printing(P. 112)**), initialize the printer to increase the free memory, and then try printing again. However, note that initializing the printer will erase all the data in the memory of the machine. For more details, see Setting the Machine (PS/PCL/UFR II Printer) via the online manual site.
- Select <Skip Error>, and continue printing. However, the data that could not be registered will not be printed correctly.

FM DL SIZE ERROR n (n is a single alphanumeric character)

The printer stopped operating normally due to an unknown problem.

- Restart the machine. If the message is still displayed after restarting the machine, make a note of the message and contact your dealer or service representative.

FM DL SCALE ERROR n (n is a single alphanumeric character)

The printer stopped operating normally due to an unknown problem.

- Restart the machine. If the message is still displayed after restarting the machine, make a note of the message and contact your dealer or service representative.

FM DL FONT MEMORY FULL

The printer stopped operating normally due to an unknown problem.

- Restart the machine. If the message is still displayed after restarting the machine, make a note of the message and contact your dealer or service representative.

FM FILE ACCESS ERROR

The printer stopped operating normally due to an unknown problem.

- Restart the machine. If the message is still displayed after restarting the machine, make a note of the message and contact your dealer or service representative.

FM SC WORK MEM. ERROR n (n is a single alphanumeric character)

The printer stopped operating normally due to an unknown problem.

- Restart the machine. If the message is still displayed after restarting the machine, make a note of the message and contact your dealer or service representative.

FM ALIGNMENT ERROR

The printer stopped operating normally due to an unknown problem.

- Restart the machine. If the message is still displayed after restarting the machine, make a note of the message and contact your dealer or service representative.

FM FONT PARSE ERROR

The printer stopped operating normally due to an unknown problem.

- Restart the machine. If the message is still displayed after restarting the machine, make a note of the message and contact your dealer or service representative.

FM FONT MEMORY FULL

The printer stopped operating normally due to an unknown problem.

- Restart the machine. If the message is still displayed after restarting the machine, make a note of the message and contact your dealer or service representative.

FM WORK MEMORY ERROR

The printer stopped operating normally due to an unknown problem.

- Restart the machine. If the message is still displayed after restarting the machine, make a note of the message and contact your dealer or service representative.

Could not perform IEEE 802.1X authentication. Set the correct authentication information.

The client authentication information is not set correctly.

- Check whether the authentication method and authentication information (key and certificate, user name and password, and CA certificate) are set correctly.

Could not perform IEEE 802.1X authentication. No reply from the destination.

An error occurred while communicating with the authenticator.

- Check whether the authenticator (LAN switch) and RADIUS server are set correctly.

Could not perform IEEE 802.1X authentication. Cannot analyze the certificate.

Failed to analyze the server certificate sent from the RADIUS server.

- Check the content of the server certificate of the RADIUS server.

Could not perform IEEE 802.1X authentication. The certificate is incorrect.

An error occurred when using the server certificate sent from the RADIUS server as a CA certificate for validation.

- Check the content of the server certificate of the RADIUS server and the CA certificate registered in the machine.
 ▶ **Registering a CA Certificate(P. 233)**

Could not perform IEEE 802.1X authentication. The certificate has expired.

The server certificate sent from the RADIUS server has expired.

- Check the expiration date of the server certificate of the RADIUS server.

Could not perform IEEE 802.1X authentication. Change the authentication password.

The password has expired.

- Set a new password.

Could not perform IEEE 802.1X authentication. Check the authentication settings.

The authentication method set in the machine and the authentication method set in the RADIUS server do not match.

- Check the authentication method set in the machine and the RADIUS server, and set the correct authentication method.

Cannot delete the default key because it is in use by TLS or other settings. Check the settings.

The key and certificate you are trying to delete is being used in TLS encrypted communications.

- Set all TLS settings to <Off> to stop TLS encrypted communication.

TCP/IP error. Check the TCP/IP settings.

Could not automatically retrieve the address with DHCP and Auto IP.

- If the address cannot be automatically retrieved with DHCP and Auto IP, <IP Address> in <IPv4 Settings> is set to 0.0.0.0. Set the correct IPv4 address. In addition, if you selected <Wired LAN + Wireless LAN> in <Select Interface>, correctly configure the IPv4 address of the wireless LAN (sub line).

▶ **Setting an IPv4 Address(P. 23)**

▶ **<IP Address Settings>(P. 362)** (<Sub Line Settings>)

0.0.0.0 is set as a fixed IPv4 address in <IP Address> in <IPv4 Settings>.

- Set the correct IPv4 address.

▶ **Setting an IPv4 Address(P. 23)**

▶ **<IP Address Settings>(P. 362)** (<Sub Line Settings>)

The IPv6 address is not set correctly.

Check the following. It may take several minutes until the stateless address is decided.

- Check whether <Use IPv6> is set to <On> in <IPv6 Settings>.
- When using a stateless address or DHCPv6, check whether each address has been retrieved.
- If the address has not been retrieved, check the settings of the router and the DHCPv6 server.

▶ **Setting an IPv6 Address(P. 25)**

The address of the DNS server is not set correctly.

- Check whether the address of the DNS server is set correctly in <IPv4> or <IPv6>.

▶ **Making DNS Settings(P. 31)**

Could not send to the TCP/IP protocol stack.

- Check whether the IPv4 address or IPv6 address is set correctly in <IPv4 Settings> or <IPv6 Settings>.

▶ **Setting an IPv4 Address(P. 23)**

▶ **Setting an IPv6 Address(P. 25)**

Check the TCP/IP settings.

The TCP/IP of the machine is not operating.

- Check the IP address, DHCP, and Auto IP settings in <TCP/IP Settings>.

▶ **Setting an IPv4 Address(P. 23)**

- If you selected <Wired LAN + Wireless LAN> in <Select Interface>, check the settings for the IP address and DHCP in <Sub Line Settings>.

▶ **<IP Address Settings>(P. 362)** (<Sub Line Settings>)

Check the TCP/IP settings. (Main Line)

The IP address of the main line is set to "0.0.0.0".

- Set a different IP address.

▶ **Setting an IPv4 Address(P. 23)**

Check the TCP/IP settings. (Sub Line)

The IP address of the sub line is set to "0.0.0.0".

- Set a different IP address.

▶ **Setting the IPv4 Address of the Sub Line(P. 27)**

Universal Print: Srvr. communication error

The machine is not connected to the network correctly.

- Check the machine and network settings, and try connecting again. Could not communicate because a server error occurred.

- Check whether the server is operating normally. Communication with the server is blocked due to firewall settings.
- Configure the firewall settings to allow communication.

Universal Print: Srvr. authentication error

An error has occurred during server authentication.

- Restart the machine. If the message still appears after restarting the machine, make a note of the message and contact your dealer or service representative.

Universal Print: Certificate expired.

The expiration date of the certificate has expired.

- Delete this machine from Azure Active Directory and the computer, re-register the machine, and then update the certificate.

Universal Print: Internal error

The printer stopped operating normally due to an unknown problem.

- Restart the machine. If the message still appears after restarting the machine, make a note of the message and contact your dealer or service representative.

Universal Print: Printer not registered

This machine was deleted from Azure Active Directory and could not be communicated with.

- Re-register this machine in Azure Active Directory.

Chk. wired LAN adapter connected to USB port.

Multiple USB-LAN adapters are connected, or the USB-LAN adapter is not connected/recognized.

- Check the connection of the USB-LAN adapter.
 - ▶ **Connecting to a Wired LAN for the Sub Line(P. 12)**
- If you reconnected the USB-LAN adapter, restart the machine.
 - ▶ **Front Side(P. 52)**

XPS Print Range Error

There are no pages that can be processed in the specified range for printing.

- Specify a correct page range.

XPS Image Data Error

Failed to extend the image data.

- Replace the image data in the XPS file and try printing again.

XPS Spool Memory Full

There is insufficient memory to process the XPS data.

- Restart the machine and try printing again. If you still cannot print, divide the pages into multiple files and print them separately.

XPS Data Error

An invalid command is specified due to corrupt data, etc. and processing cannot continue.

- Perform printing again using XPS data in a format supported by the machine.

XPS Unsupport Image Err

An unsupported data format is included.

- Convert the data to the TIFF or JPEG format and try printing again.

XPS Font Error

Failed to analyze the font data.

- Replace the font data in the XPS file and try printing again.

XPS Page Data Error

Cannot generate pages because the descriptions are incorrect.

- Perform printing again using XPS data in a format supported by the machine.

XPS Memory Full

There is insufficient memory to process the XPS data.

- Select <Skip Error>, and continue printing. However, pages that include the data that caused the error may not be printed correctly.

Cannot find the access point.

The access point could not be found.

- Check the wireless LAN settings.
 - ▶ **Check the settings and information of the wireless LAN(P. 14)**

Could not delete authentication information because an error occurred.

The authentication information could not be deleted because an unknown error occurred.

- Contact your dealer or service representative.

Could not set authentication information because an error occurred.

The authentication information could not be set because an unspecified error occurred.

- Contact your dealer or service representative.

An error occurred. Contact the system manager.

The selected user has already been deleted.

- Log in as the Administrator and register the button again.

An unexpected system error occurred.

- Check the operations and log in again. If you still cannot log in, consult your system administrator.

Prepare a new waste toner container. (Replacement not yet needed.)

The waste toner container is almost full.

- You can continue printing for a while, but you should have a new one available so that you can make replacement as soon as it is needed. If you decide to replace the waste toner container at the time when this message is displayed, press the icon at the bottom right of the screen to display a motion video to give the instructions for waste toner container replacement. Follow these instructions to replace the waste toner container.

▶ **Procedure for Replacing the Waste Toner Container(P. 415)**

Replace the waste toner container.

The waste toner container is full, so printing is not possible any longer.

- Follow the instructions on the screen to replace the waste toner container.

▶ **Procedure for Replacing the Waste Toner Container(P. 415)**

An error occurred during verification.

The certificate is invalid.

- Register the correct certificate and specify the settings again.
 - ▶ **Configuring the Key and Certificate for TLS(P. 223)**
 - ▶ **Registering a Key and Certificate for Network Communication(P. 232)**

This CRL is invalid.

The certificate revocation list (CRL) may be corrupt, or a signing algorithm not supported by the machine may be used.

- Register the correct certificate revocation list (CRL).
 - ▶ **Registering a Certificate Revocation List (CRL)(P. 235)**

This CRL has expired.

The start date for the certificate revocation list (CRL) may be set to a date in the future.

- Check the start date of the certificate registered in the machine. If the start date is set to a date in the future, use the certificate on a day after that date.
 - ▶ **Registering a Certificate Revocation List (CRL)(P. 235)**

The date and time set on the machine may be incorrect.

- Check the date and time setting of the machine.
 - ▶ **Setting the Date/Time(P. 7)**

Cannot register because the algorithm of this key is not supported.

You tried to register the key and certificate file of an unsupported encryption algorithm.

- Register the key and certificate file of a supported encryption algorithm.
 - ▶ **Registering a Key and Certificate(P. 232)**

▶ **System Specifications(P. 519)**

Cannot set this key as the default key because it is corrupted or invalid.

The key specified for the machine cannot be set because it is corrupted.

- Register the key again.
 - ▶ **Generating the Key and Certificate for Network Communication(P. 227)**
 - ▶ **Registering a Key and Certificate(P. 232)**

This certificate has been revoked.

The certificate is included in the certificate revocation list (CRL).

- Register a new certificate.
 - ▶ **Registering a Key and Certificate for Network Communication(P. 232)**

This certificate is invalid.

The certificate is invalid.

- Register the correct certificate and specify the settings again.
 - ▶ **Configuring the Key and Certificate for TLS(P. 223)**
 - ▶ **Registering a Key and Certificate for Network Communication(P. 232)**

This certificate has expired.

The certificate may have expired.

- Check the expiration date of the certificate registered in the machine. If the certificate has expired, register a valid certificate.
 - ▶ **Registering a Key and Certificate for Network Communication(P. 232)**

The date and time set on the machine may be incorrect.

- Check the date and time setting of the machine.
 - ▶ **Setting the Date/Time(P. 7)**

The appropriate paper size, A4, is not available.

Paper of the optimal size selected with Automatic Paper Selection has not been loaded.

- Load paper of the displayed size.

<Paper Source Auto Selection> is set to <Off>.

- Specify the paper source manually.
- Set a paper source loaded with the optimal paper size to <On> in <Paper Source Auto Selection>.
 - ▶ **<Paper Source Auto Selection>(P. 385)**

Paper of a type that cannot be selected with Automatic Paper Selection is loaded.

- Specify the paper source manually.

Subnet Mask Conflict

The network addresses of the main line and sub line conflict.

- Check the IP address and subnet mask settings of the main line and sub line.

▶ **Setting an IP Address(P. 22)**

The default key is not set.

The key and certificate (TLS server certificate) are not registered.

- To use TLS encrypted communication, first register the key to be used.
- ▶ **Configuring the Key and Certificate for TLS(P. 223)**

An unusable wired LAN adapter was connected.

A USB-LAN adapter that cannot be used with the machine is connected.

- For information on the USB-LAN adapters that can be used, contact your dealer or service representative.
- ▶ **Connecting to a Wired LAN for the Sub Line(P. 12)**

Could not verify the certificate.

The CA certificate of a certificate authority could not be confirmed.

- Register a CA certificate issued by a certificate authority.

Cannot change the settings because the selected key is being used.

The key and certificate you are trying to delete are being used in TLS encrypted communications.

- Set all TLS settings to <Off> to stop TLS encrypted communication.

Session timed out. Wait a moment, then try to access the database again.

The session timed out because the specified length of time elapsed.

- Try accessing again after waiting a while. If the session continues to time out, restart the machine.

Direct Connection ended due to an error.

Failed to connect to the mobile device, or no data was sent or received between the machine and the connected mobile device for a certain period of time.

- Check the connection between the machine and the mobile device.

Could not register because the number of registered users has reached the limit.

Cannot register the user because the number of users has exceeded the upper limit.

- Delete any unnecessary users.

Insert the toner cartridge in the correct color slot.

The color of the inserted toner cartridge may be incorrect.

- Make sure to check the status of the inserted toner cartridge.

The entered PIN is incorrect.

An incorrect PIN was entered.

- Enter the PIN again.

- If you do not know the correct PIN, contact the administrator.

The authentication server is not running. Contact the system manager.

The LAN cable is disconnected.

- Connect the LAN cable.

The Active Directory server is not running.

- Start the Active Directory server.

The KDC service of Active Directory is stopped.

- Follow the procedure below to check the status of the service.
 - 1 Start the "Service" management tool of Active Directory.
 - 2 Check whether the Active Directory server is operating normally.

Communication with the Active Directory * server is blocked by the firewall.

- Stop blocking the default port 88.

* If Active Directory is set as the login destination, communication is normally performed with the UDP protocol using port 88, but the data may be processed with the TCP protocol if it exceeds a certain size.

Cannot find the authentication server. Contact the system manager.

The LAN cable is disconnected.

- Connect the LAN cable.

The primary/secondary DNS server settings of the machine are incorrect or not set.

- Check and adjust the DNS server settings of the machine.

The DNS server specified in the machine is not running or its service is stopped.

- Follow the procedure below to check the status and settings of the DNS server.
 - 1 Check whether the DNS server specified in the machine is running.
 - 2 Start the "Service" management tool of the DNS server.
 - 3 Check the status in <DNS Server>, and if <Enable> is not displayed, right-click and select <Enable>.

Check whether the host record exists in the DNS server.

- Check whether a host record exists in the DNS server, and whether the forwarder settings are correct.

Cannot log in because anonymous access to the authentication server is not allowed. Contact the system manager.

Anonymous access is not allowed on the LDAP server.

- On the information input screen of the LDAP server, select <Use authentication information>, and then specify the user name and password according to what is registered in the LDAP server.
 - ▶ **Registering Server Information(P. 188)**

The account information necessary to log in to the authentication server is invalid. Contact the system manager.

The user name or password is not set correctly.

- Confirm the authentication user ID and password, and whether the user has administrator privileges.

The attributes specified in the server settings are not set correctly.

- Confirm that the attributes are correct. Also, make sure that the fields (attribute names) do not contain invalid values.

▶ **Registering Server Information(P. 188)**

The administrator account information specified in the server settings is not set correctly. Alternatively, the user could not log in as an administrator.

- Specify the correct administrator account information.

The information for the server settings is insufficient.

- Confirm that the attributes necessary for logging in are set correctly.

▶ **Registering Server Information(P. 188)**

IP address conflict detected.

The IPv4 address set for the machine already exists in the same network as the machine.

- Change the IP address of the machine in <IP Address> in <IPv4 Settings> so that it does not conflict with the IP address of another device.

▶ **Setting an IPv4 Address(P. 23)**

An IP address conflict was detected on the network. (Main Line)

The IPv4 address set for the main line of the machine already exists on the same network as the machine.

- Change the IP address of the main line of the machine so that it does not conflict with the IP address of another device.

▶ **Setting an IPv4 Address(P. 23)**

An IP address conflict was detected on the network. (Sub Line)

The IPv4 address set for the sub line of the machine already exists on the same network as the machine.

- Change the IP address of the sub line of the machine so that it does not conflict with the IP address of another device.

▶ **Setting the IPv4 Address of the Sub Line(P. 27)**

Check the network connection.

The cable is not connected to the machine correctly.

- Check whether the LAN cable is connected correctly. If you had to connect it again, restart the machine.

▶ **Connecting to a Wired LAN(P. 12)**

The machine is not connected to the network.

- If you want to use the machine without connecting to a network, set <Confirm Network Connection> to <Off>.

▶ **<Confirm Network Connection>(P. 362)**

Check the network connection.(Main Line)

The machine and the LAN cable of the main line are not connected correctly.

- Check whether the LAN cable is connected correctly. If you had to connect it again, restart the machine.

▶ **Connecting to a Wired LAN(P. 12)**

The machine is not connected to the network.

- If you want to use the machine without connecting to a network, set <Confirm Network Connection> to <Off>.

▶<Confirm Network Connection>(P. 362)

Check the network connection. (Sub Line)

The machine and the LAN cable of the sub line are not connected correctly.

- Check whether the LAN cable is connected correctly. If you had to connect it again, restart the machine.

▶Front Side(P. 52)

The machine is not connected to the network.

- If you want to use the machine without connecting to a network, set <Confirm Network Connection> to <Off>.

▶<Confirm Network Connection>(P. 362)

Cannot log in because an authentication error occurred in Department ID Management. Contact the system manager.

When using User Authentication, Department ID Management is enabled but Department IDs have not been assigned to users.

- If you are a general user, ask your administrator to assign you a Department ID.
- If you are an administrator user, ask the Department ID Management administrator to assign you a Department ID. If no administrator users can log in, contact your dealer or service representative.

PDL Invalid DLG Input

The printer stopped operating normally due to an unknown problem.

- Restart the machine. If the message is still displayed after restarting the machine, make a note of the message and contact your dealer or service representative.

PDL DLG Rendering Error

The printer stopped operating normally due to an unknown problem.

- Restart the machine. If the message is still displayed after restarting the machine, make a note of the message and contact your dealer or service representative.

PDL DLG Unknown Error

The printer stopped operating normally due to an unknown problem.

- Restart the machine. If the message is still displayed after restarting the machine, make a note of the message and contact your dealer or service representative.

PDL DLG Memory Full

The work memory was insufficient when the system was processing data (in particular, graphic processing and text processing).

- Select <Skip Error>, and continue printing. However, pages that include the data that caused the error may not be printed correctly.

PDL DLG Mem. Alloc. Err

The printer stopped operating normally due to an unknown problem.

- Restart the machine. If the message is still displayed after restarting the machine, make a note of the message and contact your dealer or service representative.

PDL GL Orig. Pt Unknown

The printer stopped operating normally due to an unknown problem.

- Restart the machine. If the message is still displayed after restarting the machine, make a note of the message and contact your dealer or service representative.

PDL GL Coord.Result

The printer stopped operating normally due to an unknown problem.

- Restart the machine. If the message is still displayed after restarting the machine, make a note of the message and contact your dealer or service representative.

PDL Invalid GL Input

The printer stopped operating normally due to an unknown problem.

- Restart the machine. If the message is still displayed after restarting the machine, make a note of the message and contact your dealer or service representative.

PDL GL Range Check

The printer stopped operating normally due to an unknown problem.

- Restart the machine. If the message is still displayed after restarting the machine, make a note of the message and contact your dealer or service representative.

PDL GL Memory Full

The work memory was insufficient when the system was processing data (in particular, graphic processing and text processing).

- Select <Skip Error>, and continue printing. However, pages that include the data that caused the error may not be printed correctly.

PDL GL Mem. Alloc. Err

The printer stopped operating normally due to an unknown problem.

- Restart the machine. If the message is still displayed after restarting the machine, make a note of the message and contact your dealer or service representative.

PDL IMG Refer. Data Err

The TIFF or JPEG data includes data that cannot be processed with the machine.

- Cancel printing (**▶Canceling Printing(P. 112)**), initialize the printer to increase the free memory, and then try printing again. However, note that initializing the printer will erase all the data in the memory of the machine. For more details, see Setting the Machine (PS/PCL/UFR II Printer) via the online manual site.

PDL IMG Initial. Err

The memory for printing the TIFF or JPEG data was insufficient.

- Cancel printing (**▶Canceling Printing(P. 112)**), initialize the printer to increase the free memory, and then try printing again. However, note that initializing the printer will erase all the data in the memory of the machine. For more details, see Setting the Machine (PS/PCL/UFR II Printer) via the online manual site.

PDL IMG Process. Error

An unknown problem occurred while processing the TIFF or JPEG data.

- Cancel printing (**▶Canceling Printing(P. 112)**), initialize the printer, and try printing again. However, note that initializing the printer will erase all the data in the memory of the machine. For more details, see Setting the Machine (PS/PCL/UFR II Printer) via the online manual site.

PDL IMG Invalid Data

The TIFF or JPEG data includes data that cannot be processed with the machine.

- Cancel printing (**▶Canceling Printing(P. 112)**), and check the TIFF or JPEG data.
- Select <Skip Error>, and continue printing. However, the data that caused the error will not be printed.

Data that cannot be processed by the machine because the machine has the same IP address as another device, etc. was sent.

- Cancel printing (**▶Canceling Printing(P. 112)**), check the IP address in <TCP/IP Settings>, and change the IP address if necessary.
 - **▶Setting an IP Address(P. 22)**

PDL IMG Work Memory Full

The memory for processing the TIFF or JPEG data was insufficient.

- Cancel printing (**▶Canceling Printing(P. 112)**), initialize the printer to increase the free memory, and then try printing again. However, note that initializing the printer will erase all the data in the memory of the machine. For more details, see Setting the Machine (PS/PCL/UFR II Printer) via the online manual site.
- Select <Skip Error>, and continue printing. However, the data that caused the error will not be printed.

PDL nn Rendering Error (nn is the module name)

The printer stopped operating normally due to an unknown problem.

- Restart the machine. If the message is still displayed after restarting the machine, make a note of the message and contact your dealer or service representative.

PDL PDF Error

PDF data that cannot be processed with the machine was sent.

- Cancel printing (**▶Canceling Printing(P. 112)**), optimize the PDF using Adobe Acrobat, and try printing again.
- Cancel printing (**▶Canceling Printing(P. 112)**), open the PDF file in an application, and try printing again using the printer driver.
- If the above-mentioned remedies do not solve the problem, make a note of the message and contact your dealer or service representative.

PDL PDF Data Decode Err

The password for printing the PDF file is incorrect.

- Enter the correct password, and try printing again.

Printing is not allowed in the security settings of the PDF file.

- Change the PDF file to allow printing in an application for editing PDF files.

If the PDF file is linked with a policy server, the policy server cannot be accessed.

- Check whether the policy server is turned on.
- Check whether the machine, policy server, and network are operating normally.

PDL PDF Memory Full

There is insufficient memory to process the PDF data.

- Cancel printing (**▶Canceling Printing(P. 112)**), optimize the PDF by adjusting settings such as the image resolution using Adobe Acrobat (to reduce the size of the data to print at one time), and perform printing again.
- Cancel printing (**▶Canceling Printing(P. 112)**), divide the pages of the PDF data in Adobe Acrobat into multiple files, and try printing again.
- Cancel printing (**▶Canceling Printing(P. 112)**), open the PDF file in an application, and try printing again using the printer driver.

PDL RIP Process. Error

The printer stopped operating normally due to an unknown problem.

- Restart the machine. If the message is still displayed after restarting the machine, make a note of the message and contact your dealer or service representative.

PDL XPS Error

An undefined error occurred.

- Restart the machine and try again. If the message is still displayed, make a note of the message and contact your dealer or service representative.

PDL XPS Initialize Error

An unknown error such as not being able to retrieve memory during initialization occurred.

- Restart the machine and try again. If the message is still displayed, make a note of the message and contact your dealer or service representative.

PDL XPS Rendering Error

An error occurred in the rendering system.

- Restart the machine and try again. If the message is still displayed, make a note of the message and contact your dealer or service representative.

PDL Image Comp. Error

The printer stopped operating normally due to an unknown problem.

- Restart the machine. If the message is still displayed after restarting the machine, make a note of the message and contact your dealer or service representative.

PDL Rendering Timeout

The printer stopped operating normally due to an unknown problem.

- Restart the machine. If the message is still displayed after restarting the machine, make a note of the message and contact your dealer or service representative.

PDL Data Transfer Error

The printer stopped operating normally due to an unknown problem.

- Restart the machine. If the message is still displayed after restarting the machine, make a note of the message and contact your dealer or service representative.

PDL Reg. Access Error

The printer stopped operating normally due to an unknown problem.

- Restart the machine. If the message is still displayed after restarting the machine, make a note of the message and contact your dealer or service representative.

The password does not meet the policy requirements. Change the password.

The entered password violates the password policy.

- Enter a password that complies with the password policy. If you do not know the password policy, consult your system administrator.

A toner cartridge that cannot be used with this device has been inserted, so printing is currently unavailable.

A toner cartridge that can be used with the machine has not been loaded.

- Load the toner cartridge that can be used with the machine. For instructions on checking the model number of the toner cartridge, see **▶Replacement Parts(P. 418)** .

Timer settings for this device and the authentication server may not be synchronized. Contact the system manager.

The date and time settings of the machine and the authentication server are different.

- Synchronize the date and time settings of the machine and the authentication server.

No paper.

The paper in the paper source has run out.

- Load paper in the paper source displayed on the screen.
▶Loading Paper(P. 63)

The paper guides in the paper source are in the wrong position.

- Adjust the paper guides according to the edges of the paper. Depending on the cut edge of the paper, multiple sheets of paper may be fed together when printing, which can cause paper jams. This can be reduced by changing the orientation of the loaded paper.

The paper settings differ from the paper that is loaded.

- Press  (Status Monitor) ► select <Device Status> ► <Paper Information> to check the paper setting. If the paper settings are incorrect, match them with the paper that is loaded. The paper loaded in the paper drawers and multi-purpose tray can be set in <Paper Settings> on the <Home> screen.
 ► **Specifying Paper Size and Type(P. 91)**

The paper settings of the driver or application differ from the paper that is loaded.

- Check the paper settings on the [Printing Preferences] screen of the printer driver, and if the paper settings are incorrect, match them with the paper that is loaded.

Login failed. Anonymous access to the authentication server is not allowed. Contact the system manager.

Anonymous access is not allowed in the LDAP server.

- Select the check box in [Use authentication information] on the screen for entering information on the LDAP server, and set the user name and password according to the information registered in the LDAP server.
 ► **Registering Server Information(P. 188)**

Login failed. The account information necessary to log in to the authentication server is invalid. Contact the system manager.

The user name or password is not set correctly.

- On the screen for entering the information for the LDAP server, set the correct settings according to the settings registered in the LDAP server.
 ► **Registering Server Information(P. 188)**

If a six-digit number is displayed when you are logging in

If an error occurs when you are logging in, a six-digit number may be displayed below the message. Take the necessary measure depending on the six-digit number displayed.

310001

Communication with the authentication server failed.

- Check the network cables from the machine and the domain controller (Active Directory).
- Check whether the domain controller is down.
- Check whether name resolution is working correctly with the DNS server set for the machine on the domain controller.
- Try again after augmenting the current value of [Period Until Timeout:] in the Active Directory settings.

310002

When [Use access mode within sites] is enabled on the machine, the site information of Active Directory is not set correctly.

- Check whether the site setting on Active Directory is valid.

310003

The network environment is not yet ready.

- Check again after a while.
- Check whether name resolution to the specified domain name is working correctly (the address can be identified) with the DNS server set for the machine, and then make adjustments as necessary.
- The DNS server set for the machine cannot be found, or it is currently unable to communicate. Check the configuration and the communication environment.

322000

A server error has occurred during Kerberos authentication.

- In Active Directory, deselect the check box for [Do not require Kerberos preauthentication], which is an account option for the logged-in user account. Alternatively, check whether Active Directory is used properly.

322006

The objective user does not exist on the authentication server.

- Check whether the authentication user or search user exists on the domain controller to authenticate.

322012

In Active Directory, the check box for [Smart card is required for interactive logon], which is an account option for the logged-in user account, is selected.

- In Active Directory, deselect the check box for [Smart card is required for interactive logon], which is an account option for the logged-in user account. After clearing the check box, be sure to reset the password. When resetting the password, you can use the same password instead of a new one.

322018

The validity period of the account has expired.

- Check the validity period of the account in question.

322023

The validity period of the password has expired.

- Change the password.
- In Active Directory, check the setting of the account options for the logged-in user account.

322024

The user name or password is wrong when keyboard authentication is performed.

- Check the password of the authentication user or search user.

322029

The attempt to communicate with the writable domain controller failed.

- Check the network cable from the writable domain controller.
- Check whether the writable domain controller is down.
- Check whether name resolution is working correctly with the DNS server on the writable domain controller.
- Try again after augmenting the current value of [Period Until Timeout:] in the Active Directory settings.

322037

The date and time settings are not identical between the machine and the authentication server.

- Ensure that the date and time settings are identical between the machine and the authentication server.

322xxx

A Kerberos authentication error.

- A Kerberos error code is displayed in place of xxx.

323000

An error has occurred during LDAP server authentication.

- Check whether Active Directory or LDAP service is used properly.

323008

An LDAP server authentication error has occurred in relation to TLS/non-TLS communication.

- Check the communication settings (TLS/non-TLS) of the server.
- Check whether the communication settings on the device side are identical to those on the server side.

323048

You are attempting to log in as an anonymous user for LDAP server authentication.

- Check whether the LDAP service setting permits anonymous user authentication.

323049/323053

The user information for LDAP server authentication is not set correctly.

- Check the user name and password of the authentication user or search user.
- Check whether the authentication user or search user is invalid, whether their validity period has expired, and whether they are account-locked.

323xxx

An LDAP server authentication (LDAPBind) error.

- An LDAPBind error code is displayed in place of xxx.

324000

An error has occurred during LDAP server search.

- Check whether Active Directory or LDAP service is used properly.

324xxx

LDAP server search (LDAPSearch) error.

- An LDAPSearch error code is displayed in place of xxx.

325000

An error has occurred during LDAP server authentication.

- Check whether Active Directory or LDAP service is used properly.

325010

You have attempted to perform registration to a read-only domain controller.

- If the domain controller configured in Active Directory is of the read-only type, no user information editing functions (registering/deleting cards, changing PIN) are available. To use the user information registration function, configure a writable domain controller.

325050

The search user set in the Administrator settings page does not have update authority (write access).

- Check whether the search user is granted write access to the user attribute that you are going to modify.

325067

You are attempting to modify an attribute of a Relative Distinguished Name (RDN) such as cn attribute.

- You are attempting to modify an attribute of a Relative Distinguished Name (RDN) such as cn attribute. The information of such attribute cannot be modified, so specify another attribute.

325xxx

An LDAP server update error.

- An LDAPModify error code is displayed in place of xxx.

331000

User authentication failed.

- Check the user name and password. If the user name and password are correct, contact your system manager.

331001

The user name has not been entered.

- Enter the user name.

331002

Cannot find the user.

- Check the user name and password. If the user name and password are correct, contact your system manager. The user may not exist on the LDAP server, or the search user may not have read access to attribute information of the relevant account.

331003

You are using a card that is not registered on the authentication server.

- Check whether you are using a valid card.

331004

Card information is double registered on the authentication server.

- Contact your system manager.

331005

The validity period of the logged-in user has expired.

- Contact your system manager.

331006

The validity value of the card and that on the authentication server are different from each other.

- Check whether you are using a valid card. If you are using a valid card, contact your system manager.

331007

A validity value outside the range is set on the authentication server.

- Check whether the server is operated with the correct attribute of validity value.

331008

The account of the logged-in user is locked out.

- Contact your system manager.

331009

The user ID of the account you are using to log in to the machine is invalid. Or the Active Directory settings may not be correct.

- Check whether all of the required attributes are set correctly.
- In Active Directory, deselect the check box for [Do not require Kerberos preauthentication], which is an account option for the logged-in user account.

331010

To perform authentication for a specific function, you have attempted to log in as a user who is not permitted to use that function.

- Contact your system manager.

331011

Login to perform authentication for a specific function failed.

- Check which functions the logged-in user is able to use.

331012

The PIN of the logged-in user is invalid.

- Enter the PIN again.

331013

The account of the logged-in user is invalid.

- Contact your system manager.

332000

User information updating failed.

- Updating the user information failed. Check whether the user information you used for updating is valid and whether invalid information is not specified for updating.

332001

Already registered card information.

- The card of the logged-in user is already registered. Check whether you are using a valid card. Or contact your system manager.

332002

An invalid attribute was specified for user information updating.

- When card information editing functions are used, it is not permitted to make registration with sAMAccountName or userPrincipalName attribute in the Active Directory settings. One solution is to use other attribute.

332003

An invalid login name was specified for user information updating.

- It is not permitted to register the name of the logged-in user (login name). Check the user name and contact your system manager.

332004

An invalid display name was specified for user information updating.

- It is not permitted to register the display name of the logged-in user. Check the display name attribute value on the server being referred to, and contact your system manager.

332005

An invalid domain name was specified for user information updating.

- It is not permitted to register the domain name for the logged-in user. Check the domain name you have selected and contact your system manager.

332006

An invalid email address was specified for user information updating.

- It is not permitted to register the email address of the logged-in user. Check the email address attribute value on the server being referred to, and contact your system manager.

332007

An invalid role was specified for user information updating.

- Check the attribute value for determining the privileges on the side of the server being referred to, and contact your system manager.

332008

The maximum registerable number of users was exceeded during user information updating.

- Contact your system manager.

Countermeasures for Each Error Code

7L2J-092

When printing is not completed normally, a number starting with "#" (an error code) is displayed on the details screen for job log or a communication management report (▶ **Printing Reports and Lists(P. 436)**). Perform the countermeasure required for the error code.

NOTE

- Some error codes may not be displayed, depending on your machine.

#001 to #800

- ▶ #009(P. 477) ▶ #010(P. 477) ▶ #037(P. 478) ▶ #099(P. 478) ▶ #701(P. 478)
 ▶ #749(P. 478) ▶ #752(P. 478) ▶ #753(P. 478) ▶ #755(P. 479) ▶ #772(P. 479)

#801 to #999

- ▶ #801(P. 479) ▶ #802(P. 479) ▶ #810(P. 479) ▶ #813(P. 480) ▶ #816(P. 480)
 ▶ #818(P. 480) ▶ #819(P. 480) ▶ #820(P. 480) ▶ #821(P. 480) ▶ #822(P. 481)
 ▶ #825(P. 481) ▶ #827(P. 481) ▶ #828(P. 481) ▶ #829(P. 481) ▶ #831(P. 481)
 ▶ #837(P. 481) ▶ #843(P. 481) ▶ #844(P. 482) ▶ #851(P. 482) ▶ #852(P. 482)
 ▶ #853(P. 482) ▶ #856(P. 482) ▶ #857(P. 482) ▶ #858(P. 482) ▶ #860(P. 483)
 ▶ #861(P. 483) ▶ #862(P. 483) ▶ #863(P. 483) ▶ #865(P. 483) ▶ #866(P. 483)
 ▶ #919(P. 483) ▶ #923(P. 484) ▶ #934(P. 484) ▶ #939(P. 484) ▶ #995(P. 484)

■ #009

Paper has run out.

- Load paper.
 ▶ **Loading Paper(P. 63)**

The paper drawer is not inserted correctly.

- Insert the paper drawer in all the way.
 ▶ **Basic Paper Loading Method(P. 64)**

■ #010

Paper has run out.

- Load paper.

▶ **Loading Paper(P. 63)**

■ #037

Data containing more than 1,000 pages was received.

- The machine deletes any pages after the 999th page, and prints the remaining 999 pages. Tell the other party to send the 1,000th and subsequent pages again.

■ #099

The operation was canceled before it was complete.

- Perform the operation again.

■ #701

The Department ID does not exist, or the PIN was changed.

- If you are using User Authentication, assign Department IDs to users. If you are using DepartmentID Authentication, enter the new Department ID and PIN to log in again.

The reception setting in <Printer Jobs with Unknown IDs> is set to <Reject>.

- Set <Printer Jobs with Unknown IDs> in <Department ID Management> to <Allow>.

▶ **Setting the Department ID Management(P. 200)**

■ #749

The operation could not be performed because a service call message is displayed.

- Turn the main power OFF, and turn the main power ON again. If the operation still cannot be performed correctly, turn the main power switch OFF, remove the power plug from the outlet, and contact your dealer or service representative.

▶ **Turning OFF the Machine(P. 62)**

▶ **Turning ON the Machine(P. 61)**

■ #752

The server is not running or the network is disconnected.

- Check whether the SMTP server is operating normally.
- Check the status of the network.

The SMTP server name setting for e-mail is incorrect or the e-mail address or domain name is not set.

- Check the SMTP server name, e-mail address, and domain name settings in <Communication Settings>.

▶ **Configuring E-Mail Print Settings(P. 45)**

■ #753

A TCP/IP error (Socket or Select error, etc.) occurred when receiving an e-mail.

- Check the status of the network cable and connector. If there is still a problem, restart the machine.

▶ **Turning ON the Machine(P. 61)**

■ #755

The IP address is not set.

- Check <TCP/IP Settings> in <Preferences>.
 - ▶<Network>(P. 362) ▶ <TCP/IP Settings>
- If you selected <Wired LAN + Wireless LAN> or <Wired LAN + Wired LAN> in <Select Interface>, also check <Sub Line Settings> in <Preferences>.

When the machine was turned ON, an IP address was not assigned to the machine by DHCP or Auto IP.

 - ▶<Network>(P. 362) ▶ <Sub Line Settings>

When the machine was turned ON, an IP address was not assigned to the machine by DHCP or Auto IP.

- Check <TCP/IP Settings> in <Preferences>.
 - ▶<Network>(P. 362) ▶ <TCP/IP Settings>
- If you selected <Wired LAN + Wireless LAN> or <Wired LAN + Wired LAN> in <Select Interface>, also check <Sub Line Settings> in <Preferences>.

When the machine was turned ON, an IP address was not assigned to the machine by DHCP or Auto IP.

 - ▶<Network>(P. 362) ▶ <Sub Line Settings>

■ #772

The network is disconnected.

- Check the status of the network.

■ #801

A timeout error occurred due to a problem on the mail server side when communicating with the SMTP server to receive an e-mail.

- Check whether the SMTP server is operating normally.
- Check the status of the network.

An error was returned from the SMTP server when connecting with SMTP. The address setting is incorrect. An error occurred due to a problem on the server side when sending to a file server.

- Check whether SMTP is operating normally, the status of the network, the destination settings, and the status and settings of the file server.

■ #802

The SMTP server name specified in <Communication Settings> is incorrect.

- Check the SMTP server name set in <Communication Settings>.
 - ▶<Configuring E-Mail Print Settings>(P. 45)

The DNS server address specified in <DNS Settings> is incorrect.

- Check the DNS server address specified in the DNS settings.
 - ▶<Making DNS Settings>(P. 31)

Connection to the DNS server failed.

- Check that the DNS server is functioning normally.

■ #810

A POP server connection error occurred when an e-mail was received.

- Check the POP server settings in <Communication Settings>.
 - ▶ **Configuring E-Mail Print Settings(P. 45)**
- Check whether the POP server is operating correctly. Check the status of the network.

An error was returned from the POP server when connecting to the POP server. Alternatively, a timeout error occurred on the server side.

- Check the POP server settings in <Communication Settings>.
 - ▶ **Configuring E-Mail Print Settings(P. 45)**
- Check whether the POP server is operating correctly. Check the status of the network.

■ #813

A POP server authentication error (user account error or password error) occurred when an e-mail was received.

- Check the POP server settings in <Communication Settings>.
 - ▶ **Configuring E-Mail Print Settings(P. 45)**

■ #816

Printing could not be performed because the maximum number of prints set in Department ID Management was exceeded.

- Contact your System Manager.

■ #818

The received data was in a file format that cannot be printed.

- Tell the other party to change the file format and send again.

■ #819

Data that cannot be handled was received. The MIME information is invalid.

- Tell the other party to check the settings and send again.

■ #820

Data that cannot be handled was received. The BASE64 or uuencode is invalid.

- Tell the other party to check the settings and send again.

■ #821

Data that cannot be handled was received. A TIFF analysis error occurred.

- Tell the other party to check the settings and send again.

■ #822

Data that cannot be handled was received. The image cannot be decoded.

- Tell the other party to check the settings and send again.

■ #825

The Department ID and PIN of a job being executed or a reserved job were deleted, or the PIN was changed.

- Execute the job again using the changed Department ID and PIN.

■ #827

Data that cannot be handled was received. Unsupported MIME information was included.

- Tell the other party to check the settings and send again.

■ #828

HTML data was received.

- Tell the other party to change to a format other than HTML and send again.

■ #829

Data containing more than 1,000 pages was received.

- The machine deletes any pages after the 999th page, and prints the remaining 999 pages. Tell the other party to send the 1,000th and subsequent pages again.

■ #831

An e-mail document could not be received using SMTP because of the Receive Filter setting in Firewall Settings.

- Reset the Receive Filter setting in Firewall Settings.
 ▶ **Specifying IP Addresses in Firewall Settings(P. 213)**

■ #837

A connection request was received from a host whose connection is restricted by the Receive Filter settings in Firewall Settings.

- Check the Receive Filter settings in Firewall Settings. This may also represent a hacking attempt via unauthorized access.
 ▶ **Specifying IP Addresses in Firewall Settings(P. 213)**

■ #843

There is a great difference between the time of the KDC (Key Distribution Center) server and the time set in the machine.

- Adjust the current date and time in <Date/Time Settings>.

▶ **Setting the Date/Time(P. 7)**

- Adjust the current time set in the KDC (Key Distribution Center) server.

■ #844

Sending could not be performed because a validation error occurred when validating the TLS server certificate when communicating with the POP server because <Confirm TLS Certificate for POP RX> is set to <On>.

- Use the Remote UI to check whether the CA certificate used to sign the TLS server certificate on the POP server side is registered in the machine.
- Check whether the TLS server certificate on the POP server side is correct.
- Check whether the TLS server certificate is a self-signed certificate.

■ #851

The printer job could not be stored because the memory is full.

- Check the amount of available memory, and execute the job again.

■ #852

The power was turned OFF while the job was being executed.

- Check that the power cable and plug are securely connected, and execute the job again.

■ #853

The memory is full.

- Reduce the number of pages or check that the number of jobs waiting to be processed has decreased, and execute the job again.

■ #856

The executed operation was canceled because the memory area for temporarily saving data became full.

- Contact your administrator.

■ #857

Printing was canceled due to the job being canceled while being received, or due to timeout.

- If timeout has occurred, check the status of the network.

■ #858

The data is invalid.

- Check that the print protocol is supported by the machine, as well as the print settings.

■ #860

Recovery failed after a paper jam, or an incompatible page description language or settings which cannot be combined were included.

- Check the paper or job settings.

■ #861

An error occurred while processing the print data or image data.

- Check the image size and paper size, as well as the color specification settings.

■ #862

Settings are included which are not supported, cannot be combined, or otherwise exceed the limits of the machine.

- Check the job settings.

■ #863

The job was canceled because initialization operations were performed while the print data was being processed.

- Execute the job again.

■ #865

The required functions for printing are currently restricted.

- Check the machine and the job settings.

■ #866

The job was canceled by the security related settings.

- If you are executing a job from the printer driver, use the user information of the appropriate privileges.
- If you are executing a job from the control panel, login as a user with the appropriate privileges.

NOTE

The security related settings are as follows.

- [Restrict Job from Remote Device w/out User Authent.] is selected
- <Prohibit Authentication Using Department ID and PIN> is <On>

■ #919

A syntax error or a PostScript error that exceeds device restrictions, etc. was detected.

- Set <Print PS Errors> (Set) to <On>, submit the job again, confirm the contents of the PostScript error, then execute the job after resolving the error. For more details, see Setting the Machine (PS/PCL/UFR II Printer) via the online manual site.

■ #923

Could not print on the specified side of the cover, or body.

- Change to a paper type that is compatible with two-sided printing, and execute the job again.

■ #934

An error occurred for a print job, and the job was deleted because the specified time period elapsed.

- Resolve the error and execute the job again.
- You can also change the time period before deletion or disable automatic deletion from <Auto Delete Suspended Jobs> (Set).
▶<Auto Delete Suspended Jobs>(P. 387)

■ #939

Printing was canceled due to an error that occurred while processing the image data.

- Execute the job again.

■ #995

Reserved communication jobs were cleared.

- Perform the operation again, as necessary.

Clearing Paper Jams

7L2J-093

If a paper jam occurs, a message, the location of the paper jam, and the procedure for clearing it are displayed on the screen. If you do not know how to clear the paper jam from viewing the screen, see **Paper Jam Locations(P. 486)** to clear the paper jam. For information on cautions when clearing paper jams, see the Important Safety Instructions.

CAUTION

- Do not forcibly remove the jammed paper from the machine. Forcibly removing the paper may result in injury or damage parts of the machine.
 - If you cannot remove the paper, contact your dealer or service representative.
- When all paper jams have been cleared, immediately remove your hands from the machine and optional equipment so that your clothing and hands do not get caught in the rollers.

IMPORTANT

Cautions when clearing paper jams

- When clearing paper jams, do not turn the power OFF. Data being printed is erased when you turn the power OFF.
- When the paper gets torn, be sure to remove the torn pieces so that they do not remain.

■ If Paper Jams Frequently Occur

If paper jams frequently occur even though there are no problems with the machine and its optional equipment, check the following.

Are the paper guides misaligned?

- Match the paper guides with the paper loaded in the paper source.

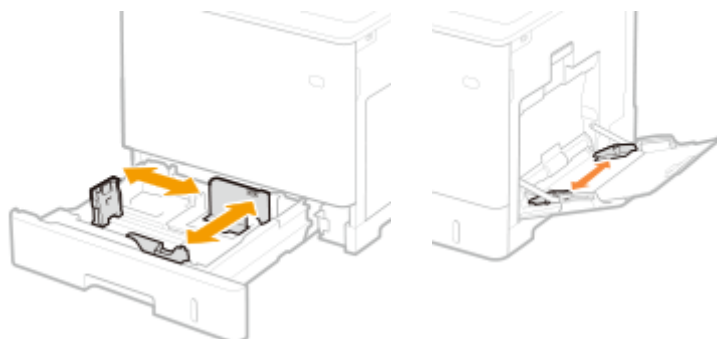

Do sheets of paper overlap when being fed?

- If paper jams occur due to overlapping of sheets of paper when being fed, reload the paper by changing the orientation.

Is the paper type correct?

- On the <Paper Type> display, check the paper type. **▶Specifying Paper Size and Type(P. 91)**

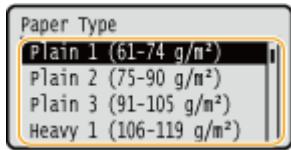

- If the paper loaded in a paper source differs from the paper type setting, see **▶Loading Paper(P. 63)** to set the paper type again.

Do pieces of paper remain in the machine?

- Pieces of paper may remain in the machine after removing a paper jam. Open the location where the paper was jammed, and remove any pieces of paper (Do not forcibly remove the jammed paper from the machine. Forcibly removing the paper may result in injury or damage parts of the machine. If you cannot remove the paper, contact your dealer or service representative.).

Paper Jam Locations

For information on the paper jam locations and the method for clearing paper jams, see the following diagram and references.

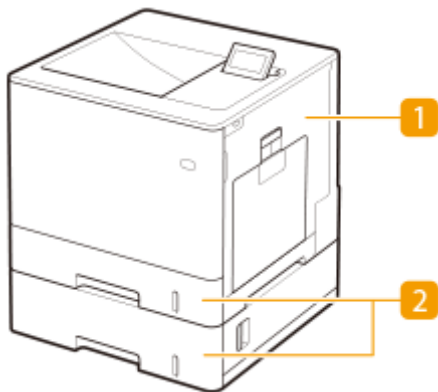

- 1** Inside the main unit **▶Paper Jams inside the Machine or in the Fixing Unit(P. 487)**
- 2** Paper drawer **▶Paper Jams in a Paper Source(P. 491)**

NOTE

- Paper may not actually be jammed in the location you check. Even in this case, follow the instructions on the screen to check all the locations.
- The screen indicating that there is a paper jam is repeatedly displayed until you clear the paper jam.
- Do not remove paper from a location other than that displayed as a paper jam location on the screen. This may cause paper jams in other locations or missing pages in output documents.

Paper Jams inside the Machine or in the Fixing Unit

7L2J-094

Check the paper jam location on the screen, and follow the procedure below to remove the paper.

1 Gently pull out the paper.



2 Close the tray.



3 Open the right cover.

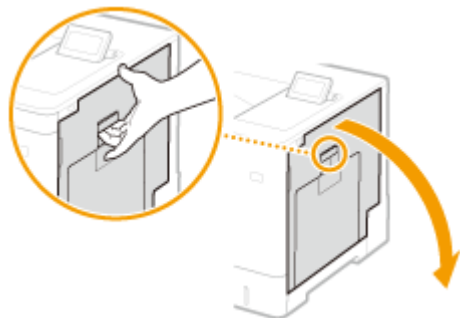

4 Gently pull out the paper.



5 Remove the jammed paper in the delivery unit.

- 1 Lift up the delivery unit.

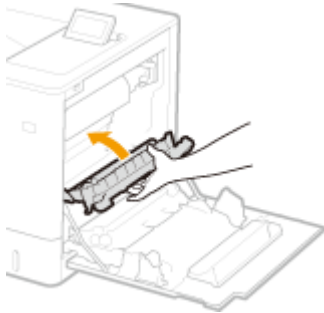

- 2 Lower the green levers on both sides of the transport guide.

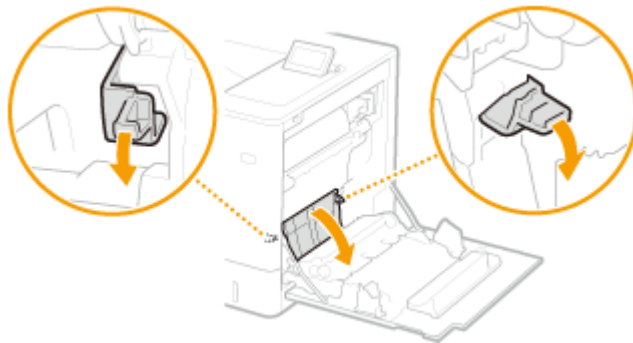

- 3 Gently pull out the paper.

- Pull out the paper while holding it as horizontally as possible to prevent unfixed toner from falling.

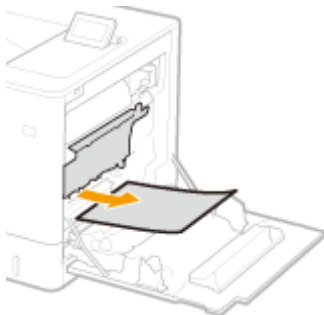

6 Check whether there is a paper jam in the fixing unit.

- 1 Turn the delivery unit downward.

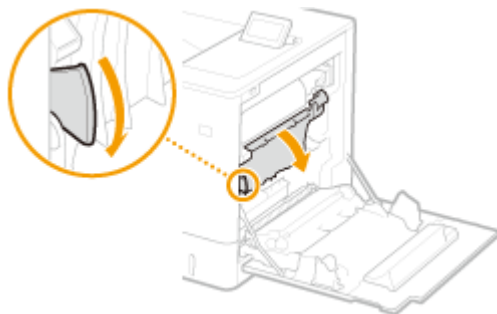

- 2 Hold the handles on both sides of the fixing unit, and pull out the fixing unit straight toward you.



3 Open the cover.

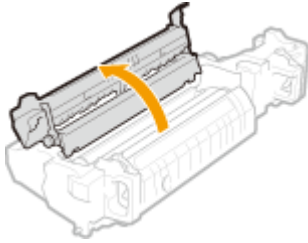

4 Gently pull out the paper.

- Pull out the paper while holding it as horizontally as possible to prevent unfixed toner from falling.

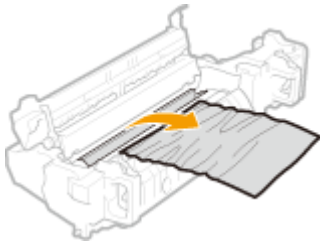

5 Close the cover.

6 Gently pull out the paper.

- Determine in which way you can pull out the jammed paper more easily, and try that way first.
- Pull out the paper while holding it as horizontally as possible to prevent unfixed toner from falling.

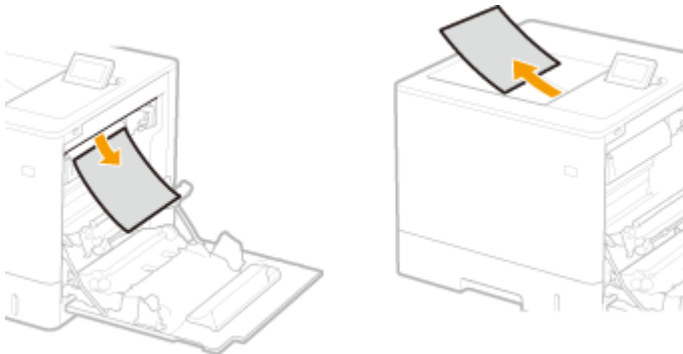

7 Place the fixing unit back into position.

- Fully push it in until it cannot go any further.



7 Close the right cover.

NOTE:

When the message is still displayed

- Paper may be jammed in other locations. Check other locations, and remove jammed paper if any. If the message is still displayed, check whether the right cover is securely closed.

Paper Jams in a Paper Source

7L2J-095

Check the paper jam location on the screen, and follow the procedure below to remove the paper.

- ◻ Clearing Paper Jams in Paper Drawers 1 (P. 491)
- ◻ Clearing Paper Jams in Paper Drawers 2, 3 and 4 (Optional) (P. 492)

Clearing Paper Jams in Paper Drawers 1

1 Open the right cover.

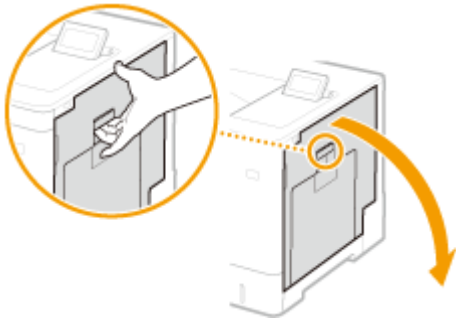

2 Remove the jammed paper in the delivery unit.

1 Lift up the delivery unit.

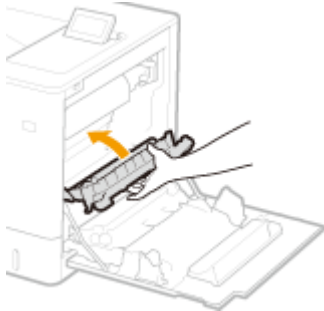

2 Lower the green levers on both sides of the transport guide.

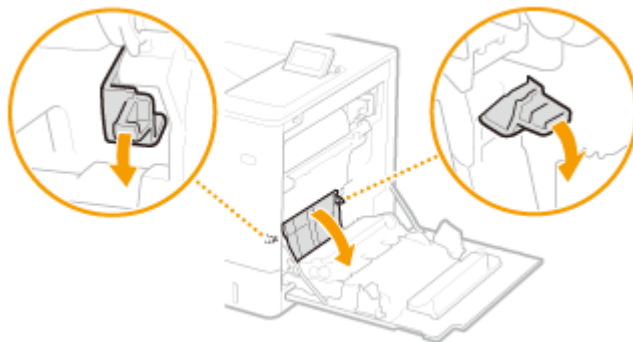

3 Gently pull out the paper.

- Pull out the paper while holding it as horizontally as possible to prevent unfixed toner from falling.

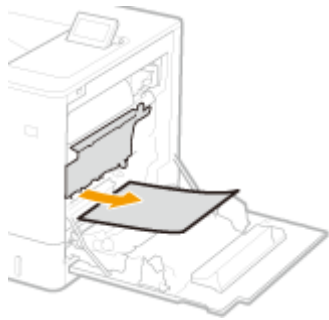

3 Remove the jammed paper in the paper drawer.

- 1 Pull out the paper drawer until it stops.

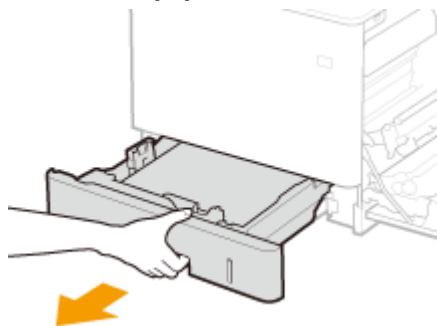

- 2 Gently pull out the paper.



- 3 Set the paper drawer.

4 Close the right cover.

NOTE:

When the message is still displayed

- Paper may be jammed in other locations. Check other locations, and remove jammed paper if any. If the message is still displayed, check whether the right cover is securely closed.

Clearing Paper Jams in Paper Drawers 2, 3 and 4

NOTE

- Remove jammed paper in Paper Drawers 3 and 4 with the same procedure as Paper Drawer 2.

1 Open the right cover.

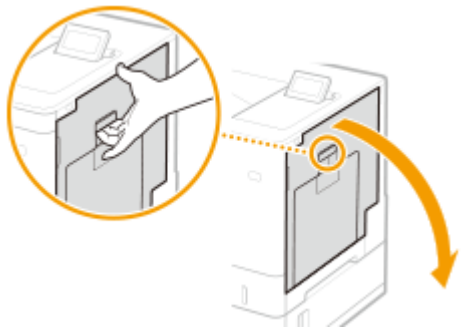

2 Remove the jammed paper in the delivery unit.

1 Lift up the delivery unit.

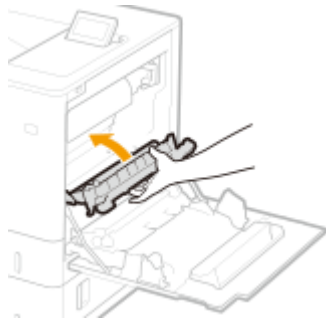

2 Lower the green levers on both sides of the transport guide.

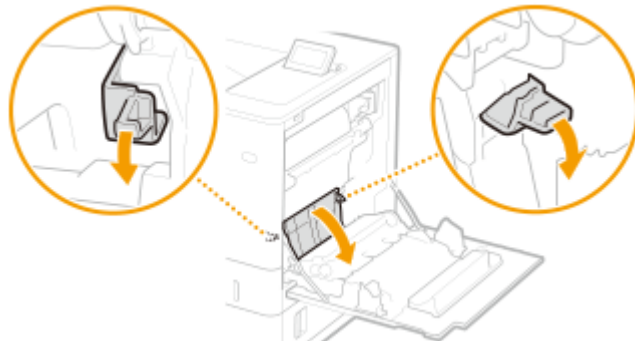

3 Gently pull out the paper.

- Pull out the paper while holding it as horizontally as possible to prevent unfixed toner from falling.

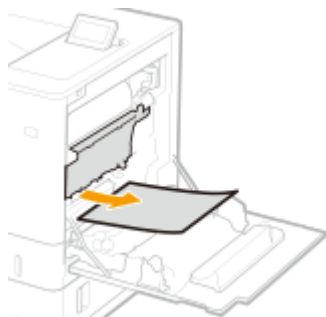

3 Close the right cover.

4 Open the right cover of the paper feeder.

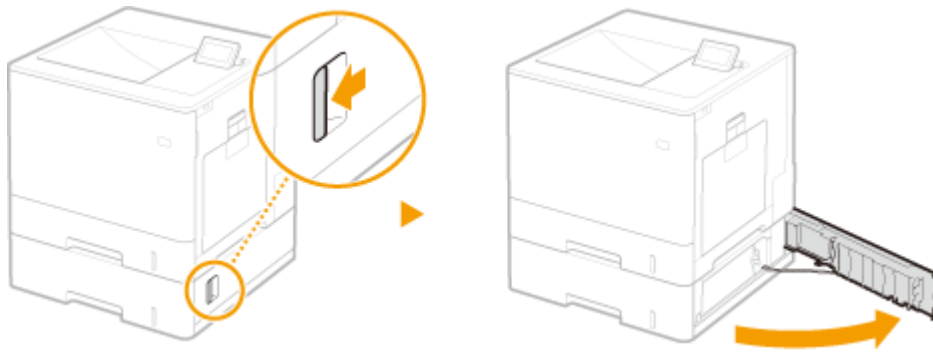

5 Lower the green lever to open the transport guide.

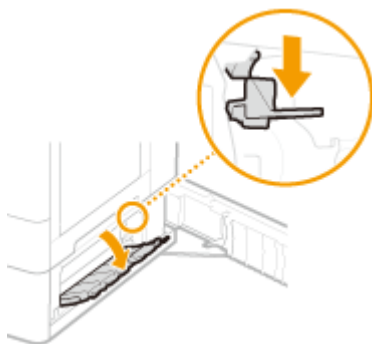

6 Gently pull out the paper.



7 Pull out the paper drawer until it stops, and gently pull out the paper.

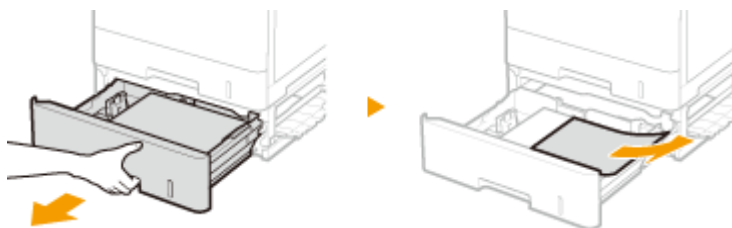

8 Set the paper drawer.

9 Close the right cover of the paper feeder.

NOTE:

When the message is still displayed

Troubleshooting

- Paper may be jammed in other locations. Check other locations, and remove jammed paper if any. If the message is still displayed, check whether the right cover is securely closed.

Implementing Security Measures

Implementing Security Measures	497
Various Security Functions	498

Implementing Security Measures

7L2J-096

Saving important data to the machine and sharing information via the machine enable the machine to be used more effectively. It also raises the value the machine provides as an information asset.

The machine provides various functions for enhancing security, such as preventing information leaks, preventing unauthorized access, and protecting confidential information. Using these security functions together enables you to use the machine securely.

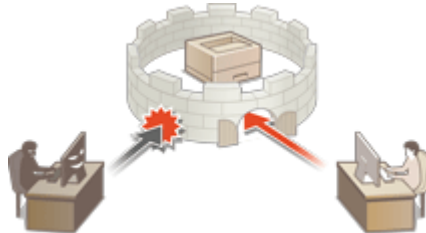

▶ **Various Security Functions(P. 498)**

Various Security Functions

7L2J-097

Do you feel uneasy about the following problems?

- Unattended output
- Unauthorized access
- Forgetting to erase confidential data on the machine

The machine provides various security functions for minimize the risk of information leakage and unauthorized access. This section describes functions that are effective in certain situations.

- ▶ **Preventing Documents Leaks(P. 498)**
- ▶ **Preventing Unauthorized Access to the Network(P. 498)**
- ▶ **Preventing Leaks of Confidential Information during Operation of the Machine(P. 499)**

! IMPORTANT

- Implementing security measures does not guarantee that all information will be protected.

NOTE

- Using the Import All function enables multiple devices to be managed with the same settings. ▶ **Importing/Exporting the Setting Data(P. 273)**

Preventing Documents Leaks



When managing confidential documents, it is necessary to handle problems such as leaks and loss. The machine has a security function that prohibits printing until the user logs in at the device, in order to prevent the leakage or loss of documents.

Use the following functions as security measures for preventing document leaks.

Force Hold

To avoid leaving printed material, accidental information leakage, misprinting, etc., the administrator can set to store the document before printing. ▶ **Printing Documents Held in the Machine(P. 116)**

Only Allow Encrypted Print Jobs

By using Encrypted Secure Printing, you can send encrypted printing data to a machine from your computer. This enables you to reduce the risk of information leaks when sending printed data, and to print more safely. ▶ **Forced Hold Settings(P. 116)**

Preventing Unauthorized Access to the Network



Although Cloud services have made it easier to exchange data via the Internet, communication can still be intercepted or modified by malicious third parties due to network vulnerabilities. The machine provides various measures for increasing network security, such as only allowing communication with specific IP addresses and encrypting data for communication.

Use the following functions as security measures for preventing unauthorized network access, etc.

Firewall Settings

Unauthorized access by third parties, as well as network attacks and breaches, can be blocked by only allowing communication with devices that have a specific IP address. [▶Restricting Communication by Using Firewalls\(P. 212\)](#)

Proxy Settings

You can provide greater security by using a proxy server for connections outside the network. [▶Setting a Proxy\(P. 221\)](#)

TLS Settings

TLS is a protocol for encryption for data sent over a network and is often used for communication via a Web browser or an e-mail application. TLS encrypted communication enables secure network communication when accessing the machine using the Remote UI. [▶Configuring the Key and Certificate for TLS\(P. 223\)](#)

IPSec Settings

While TLS only encrypts data used on a specific application, such as a Web browser or an e-mail application, IPSec encrypts the whole (or payloads of) IP packets. This enables IPSec to offer a more versatile security system than TLS. [▶Configuring the IPSec Settings\(P. 244\)](#)

IEEE 802.1X Settings

If a device tries to connect and start communicating on an 802.1X network, the device must go through user authentication in order to prove that the connection is made by an authorized user. Authentication information is sent to and checked by a RADIUS server, which permits or rejects communication to the network depending on the authentication result. If authentication fails, a LAN switch (or an access point) blocks access from the outside of the network. The machine can connect to an 802.1X network as a client device. [▶Configuring the IEEE 802.1X Authentication Settings\(P. 251\)](#)

Preventing Leaks of Confidential Information during Operation of the Machine



The machine generates value as an information asset by storing important data. Preventing confidential information from remaining on the machine after disposal is another important security measure. The machine provides various measures for increasing security of operation, such as preventing unregistered users from operating the machine, and completely erasing temporary job data when the machine is started.

Use the following functions as security measures for preventing leaks of confidential information during operation of the machine.

Verify System at Startup

The integrity of the firmware, system, and AddOn applications in the machine is verified during startup. ▶
<**Verify System at Startup**>(P. 402)

McAfee Embedded Control

When the machine is operating, the McAfee Embedded Control function is used to prevent unauthorized program modification and the execution of unauthorized programs, for improved system reliability. ▶<**McAfee Embedded Control**>(P. 402)

Personal Authentication Management

A user name and password can be used to perform personal authentication of users. Preventing unauthorized access by third parties and setting usage restrictions can maintain a higher level of security and enable more efficient operation of the machine. ▶<**Managing Users**>(P. 172)

Initialize All Data/Settings

You can restore all of the machine settings to the factory default values. Since data remaining in the memory is overwritten with meaningless values, this prevents external leaks of confidential data when disposing of the machine. ▶<**Initializing Settings**>(P. 289)

Security Policy Settings

A security policy describes company-wide rules regarding information security. With this machine, multiple settings related to a security policy can be set together. ▶<**Applying a Security Policy to the Machine**>(P. 162)

Allow Use of Default Password for Remote Access

You can set the machine to not allow users to log in to the Remote UI using the default password (7654321) of the "Administrator" user for security reasons. ▶<**Setting an Authentication/Password Policy**>(P. 207)

Appendix

Appendix	502
Third Party Software	504
Notice	505
Feature Highlights	507
Productivity	508
Image Quality	509
Manageability	510
Building a Dual Network Environment	511
Office Compatibility	514
Basic Windows Operations	515
System Specifications	519
Printer Functions	520
Management Functions	523
System Environment	527
Network Environment	528
System Options	530
Hardware Specifications	531
Main Unit	532
Available Paper	534
Paper Feeder PF-D	541
Cassette Feeding Unit-AV	542
Options	543
Optional Equipment	544
Paper Feeder PF-D	545
Cassette Feeding Unit-AV	546
Manuals and Their Contents	547
Using User's Guide	548
Screen Layout of User's Guide	549
Viewing User's Guide	552

Appendix

7L2J-098

This chapter contains the technical specifications of this machine, descriptions of options, instructions on how to use the User's Guide, disclaimers, copyright information, and other important information for customers. Read this chapter as necessary.

■ Machine Specifications

You can check the specifications of the machine, network environment, etc.



- ▶ **Hardware Specifications(P. 531)**
- ▶ **System Specifications(P. 519)**

■ Using Optional Equipment

See this section to check the optional equipment and the system options to use the machine more efficiently.

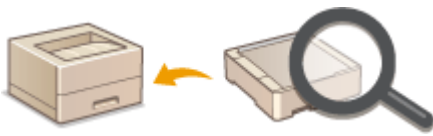

- ▶ **Options(P. 543)**
- ▶ **Optional Equipment(P. 544)**
- ▶ **System Options(P. 530)**

■ Referencing the Manual of This Machine

See the following section(s) to read instructions on how to use the various manuals and the User's Guide (this manual) that help you understand machine's functions and operating procedures.



- ▶ **Manuals and Their Contents(P. 547)**
- ▶ **Using User's Guide(P. 548)**

■ Others

This section describes basic OS operations and includes disclaimers, copyright information, and other information.



- ▶ **Third Party Software(P. 504)**
- ▶ **Feature Highlights(P. 507)**
- ▶ **Basic Windows Operations(P. 515)**
- ▶ **Notice(P. 505)**

Third Party Software

7L2J-099

For information related to third-party software, click the following icon(s).

Third-Party Services



THIRD PARTY LICENSE README



Third-Party Software Included in This Manual



Notice

7L2J-0AS

■ IPv6Ready Logo



The protocol stack included in this machine has obtained the IPv6 Ready Logo Phase-2 established by the IPv6 Forum.

■ When disposing of used toner cartridges

- To protect the environment and make more effective use of resources, Canon promotes the recovery and recycling of used toner cartridges. Please cooperate in the recovery of toner cartridges (resource reuse). For details on resource reuse, see the Canon website:

global.canon/ctc

When disposing of toner cartridges, pack them in their original packaging to prevent toner dispersal and dispose of the cartridges in accordance with your local government instructions.

■ Installation

- If you find the machine's operation to be noisy in some operating modes or due to your surroundings, we recommend setting up the machine in a separate location from your office.
- Water droplets (condensation) may form inside the machine if the room where the machine is installed is heated rapidly, or if the machine is moved from a cool, dry location to a warm, humid location. Using the machine under these conditions may result in problems such as paper jams, poor print quality, or faults. Let the machine adjust to the ambient temperature and humidity for at least two hours before use.
- Machines with storage devices such as hard disks may not operate properly when used at high altitudes (3,000 meters above sea level or higher).

■ Trademarks

Mopria®, the Mopria® Logo and the Mopria® Alliance logo are registered trademarks and service marks of Mopria Alliance, Inc. in the United States and other countries. Unauthorized use is strictly prohibited.

This product contains the Universal Font Scaling Technology or UFST® under license from Monotype Imaging, Inc. UFST® is a trademark of Monotype Imaging, Inc. registered in the United States Patent and Trademark Office and may be registered in certain jurisdictions.

UFST: Copyright © 1989 - 1996, 1997, 2003, 2004, 2008, 2014, all rights reserved, by Monotype Imaging Inc.

Adobe, Acrobat and Reader are registered trademarks of Adobe Systems Incorporated in the United States and/or other countries.

Apple, Bonjour, iPad, iPhone, iPod touch, Safari, Mac, macOS and OS X are trademarks of Apple Inc.

Microsoft, Windows, Windows Vista, Windows Server, Windows Phone, Internet Explorer, Microsoft Edge, Excel and PowerPoint are either registered trademarks or trademarks of Microsoft Corporation in the United States and/or other countries.

Google Chrome and Android are trademarks of Google LLC.

Portions of this software are copyright © 2007 The FreeType Project(www.freetype.org).

All rights reserved.



Java is a registered trademark of Oracle and /or its affiliates.



Adobe, PostScript, and the PostScript logo are either registered trademarks or trademarks of Adobe Systems Incorporated in the United States and/or other countries.

Copyright © 2007 -08 Adobe Systems Incorporated. All rights reserved.

Protected by U.S. Patents 5,737,599; 5,781,785; 5,819,301; 5,929,866; 5,943,063; 6,073,148; 6,515,763; 6,639,593; 6,754,382; 7,046,403; 7,213,269; 7,242,415; Patents pending in the U.S. and other countries.

All instances of the name PostScript in the text are references to the PostScript language as defined by Adobe Systems Incorporated unless otherwise stated. The name PostScript also is used as a product trademark for Adobe Systems' implementation of the PostScript language interpreter.

Except as otherwise stated, any reference to a "PostScript printing device," "PostScript display device," or similar item refers to a printing device, display device or item (respectively) that contains PostScript technology created or licensed by Adobe Systems Incorporated and not to devices or items that purport to be merely compatible with the PostScript language.

Adobe, the Adobe logo, PostScript, the PostScript logo, and PostScript 3 are either registered trademarks or trademarks of Adobe Systems Incorporated in the United States and/or other countries.

Linux is a registered trademark of Linus Torvalds. Microsoft and Windows are either registered trademarks or trademarks of Microsoft Corporation in the United States and/or other countries.

All other trademarks are the property of their respective owners.

All brand names and product names appearing on this manual are registered trademarks or trademarks of their respective owners.

All other trademarks are the property of their respective owners.

■ Disclaimers

- The information in this document is subject to change without notice.
- CANON INC. MAKES NO WARRANTY OF ANY KIND WITH REGARD TO THIS MATERIAL, EITHER EXPRESS OR IMPLIED, EXCEPT AS PROVIDED HEREIN, INCLUDING WITHOUT LIMITATION, THEREOF, WARRANTIES AS TO MARKETABILITY, MERCHANTABILITY, FITNESS FOR A PARTICULAR PURPOSE OF USE, OR NON-INFRINGEMENT. CANON INC. SHALL NOT BE LIABLE FOR ANY DIRECT, INCIDENTAL, OR CONSEQUENTIAL DAMAGES OF ANY NATURE, OR LOSSES OR EXPENSES RESULTING FROM THE USE OF THIS MATERIAL.
- If you are unable to view the manual in PDF format, download Adobe Acrobat Reader from the Adobe Systems website (<https://get.adobe.com/reader/>).

■ Copyright

Reproduction of the contents of this document in whole or in part without prior permission is prohibited.

Feature Highlights

7L2J-09C

This section highlights six ways in which you can use the machine to its fullest potential.

Superior productivity to help your business' daily operations run more smoothly

▶ **Productivity(P. 508)**

Clearer images thanks to high-quality image printing and corrective functions

▶ **Image Quality(P. 509)**

Expanded capabilities and easier management

▶ **Manageability(P. 510)**

An energy-saving design that's environmentally friendly

▶ **Office Compatibility(P. 514)**

Productivity

7L2J-09E



This section describes how to use the machine's superior productivity to help your daily business operations run more smoothly.

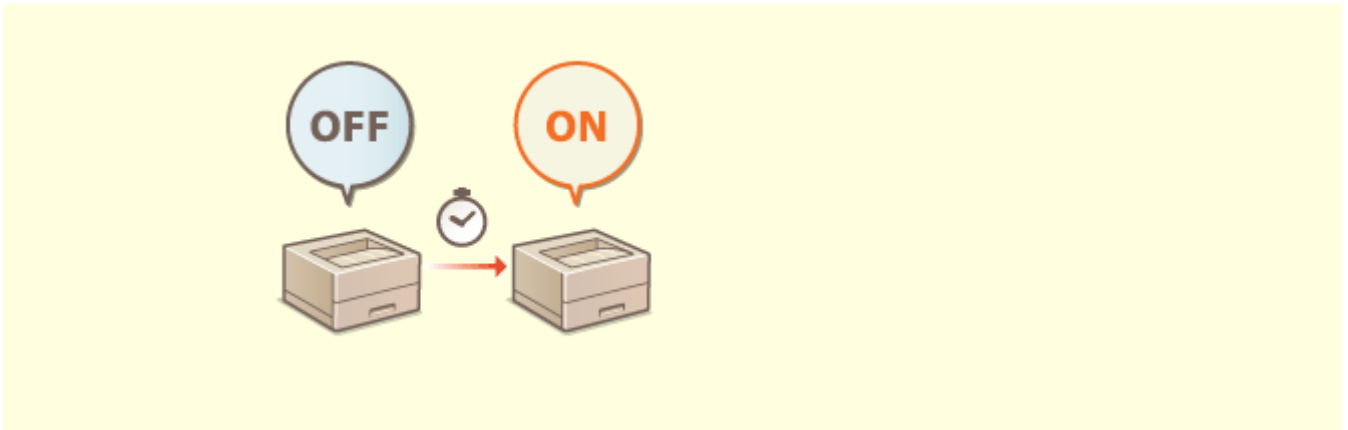

Using the Machine Immediately after Turning it ON (Quick Startup)

Specifying <Quick Startup Settings for Main Power> reduces the time required for the machine to start up after turning the main power ON, enabling smoother operations.

▶<Quick Startup Settings for Main Power>(P. 358)

Image Quality

7L2J-09F



This section describes functions that help to produce crisp and clear images, such as high-quality image printing and corrective functions.

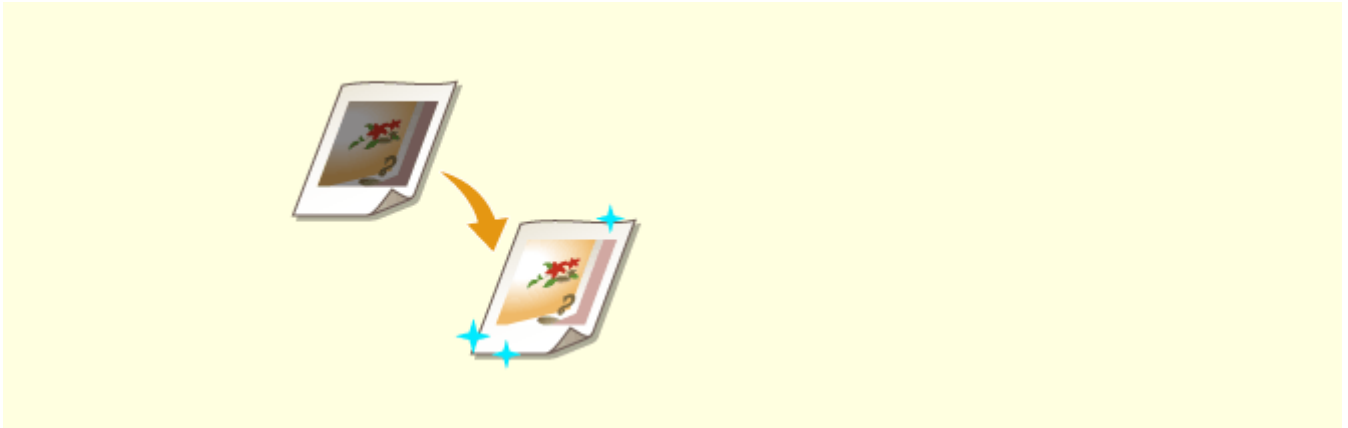

Adjusting Print Quality

You can achieve more satisfying print results by using corrective functions such as gradation adjustment and density correction.

▶ **Adjusting Print Quality(P. 422)**

Manageability

7L2J-09H



This section describes how to expand the capabilities of the machine and make management easier.



Dual Network Environment

A dual network environment using wired LAN and wireless LAN or wired LAN and another wired LAN can be used.

▶ **Building a Dual Network Environment(P. 511)**

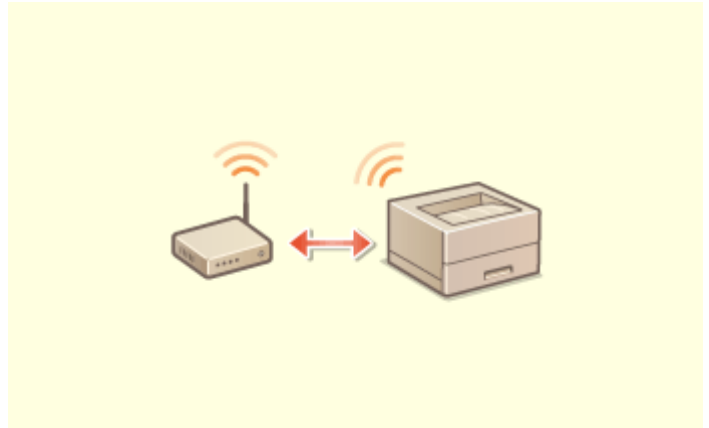

Connecting to the Wireless LAN

A wireless LAN is built into the machine, enabling you to connect a computer or mobile device to the machine, as well as install it in a separate location.

▶ **Connecting to a Wireless LAN(P. 14)**

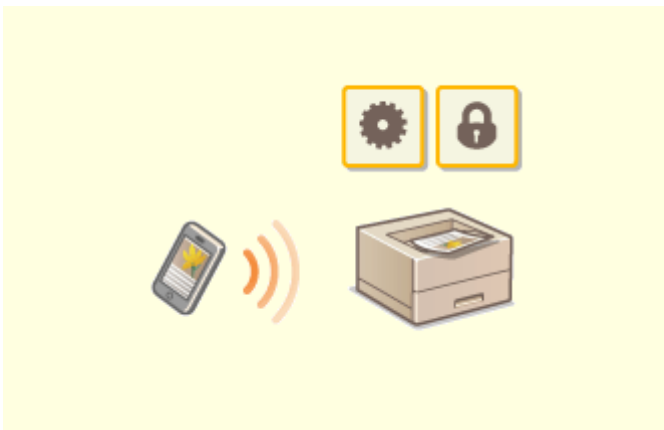

Linking with Mobile Devices

You can directly print data saved in a mobile device from the machine. You can also use your mobile device to specify settings for forced hold printing in the machine.

▶ **Linking with Mobile Devices(P. 142)**

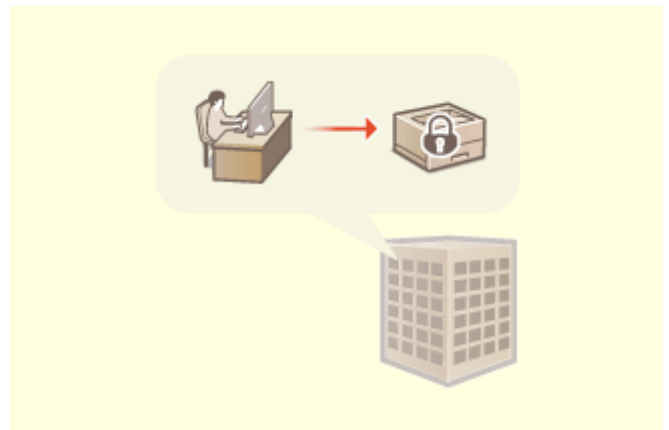

Operating an Office Security Policy

A security policy describes company-wide rules regarding information security. With this machine, multiple settings related to a security policy can be set together.

▶ **Applying a Security Policy to the Machine(P. 162)**

Building a Dual Network Environment

7L2J-09J

Do you have separate machines in each department or floor of the same office for security purposes?

In addition to single connections with a wired LAN or wireless LAN, this machine enables dual network environments with both a wired LAN and wireless LAN or a wired LAN and another wired LAN via a USB-LAN adapter*. This makes it easy to build network environments where employees use the main line and customers use a sub line with restricted functionality. It also contributes to reduced costs as it is not necessary to install a machine for each network environment.

* For information on the supported USB-LAN adapters, contact your dealer or service representative.



This machine and the User's Guide refer to the main wired LAN in a dual network as the "main line". The sub wireless LAN or another wired LAN in a dual network is referred to as the "sub line."

- ▶ **Flow of Settings Required for a Dual Network(P. 511)**
- ▶ **Cautions When Using the Sub Line(P. 512)**

Flow of Settings Required for a Dual Network

In a dual network, the main line and sub line have separate settings. This section describes the settings required for the sub line network.

NOTE

- Specify the wired LAN/wireless LAN settings common to the main and sub lines, as required.
 - ▶ **Connecting to a Wired LAN(P. 12)**
 - ▶ **Connecting to a Wireless LAN(P. 14)**

- ▶ **Connecting to a Wired LAN(P. 12)**
- ▶ **Connecting to a Wireless LAN(P. 14)**

Step 1

▶ **Selecting the Network Connection Method(P. 10)**

- Select <Wired LAN + Wireless LAN> or <Wired LAN + Wired LAN>.



Step 2**▶Setting the IPv4 Address of the Sub Line(P. 27)**

- Specify the IPv4 address settings from <IP Address Settings> in <Sub Line Settings>. When using static routing, also set a gateway address.

**Step 3****▶Making Ethernet Settings(P. 29) ***

- Set this when using a wired LAN via a USB-LAN adapter for the sub line.
* Specify the required settings according to your environment.

**Step 4****▶Configuring the Firewall of the Sub Line(P. 218) ***

- Register the port numbers of the functions to use/restrict in the firewall settings of the sub line.
* Specify the required settings according to your environment.

**Step 5****▶Setting Static Routing(P. 38) ***

- Set static routing when connecting to another network via a router.
* Specify the required settings according to your environment.

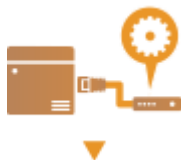
**Step 6****▶Configuring System Data Communication(P. 43) ***

- Set this when performing specific system data communication in environments where DNS name resolution or network connections via a proxy cannot be used.
* Specify the required settings according to your environment.



Cautions When Using the Sub Line

The network functions set in the machine can all be used for the main line. However, the functions that can be used with the sub line are limited.

IMPORTANT

- The DNS server and WINS server settings cannot be used at the same time as the main line.
- <DNS Server Address Settings> and <Proxy Settings> in <Settings for System Data Communication> can only be used for specific system data communication. When using a DNS server or proxy server for the sub line for applications other than system data communication, register the addresses and port numbers to use with the sub line in the settings of the main line.
- ▶ **Making DNS Settings(P. 31)**
- ▶ **Setting a Proxy(P. 221)**

■ Functions Restricted for the Sub Line

The following network functions cannot be used with the sub line.

- IPv6 address settings
- IEEE802.1X authentication
- IPSec
- NetBIOS
- FTP (ACTIVE mode)
- DHCP Option Settings
- DNS Dynamic Update Settings
- Multicast Discovery Settings
- Setting the IP address via AutoIP
- Firewall settings via MAC address filter
- Browsing using the SMB protocol

The following functions and services cannot be used, due to the above limitations.

- Building a printing/accounting system that performs server connections via an AddOn application
- Building an authentication system for an Active Directory server
- File sending using DNS name resolution or NetBIOS name resolution from the SMB or WebDAV protocol^{*1}
- Automatic discovery of other multifunction printers on the sub line side using multicast discovery^{*1}
- Functions such as the following that use the IP address of the main line
 - [Security Policy Settings]
 - Batch importing/batch exporting
- Universal Print

^{*1} Specify the IP address directly.

Office Compatibility

7L2J-09K



This section describes how to use the machine in an environmentally-friendly manner.



Using the Sleep Mode to Save Power During Standby

The machine saves power by switching to the Sleep mode or Energy Saver mode when not in use. Users can also save power by only starting up the functions they require when the machine recovers from the Sleep mode.

- ▶ **Entering Sleep Mode(P. 104)**
- ▶ **<Timer/Energy Settings>(P. 358)**

Basic Windows Operations

7L2J-09X

- ▶ **Displaying the Printer Folder(P. 515)**
- ▶ **Displaying Shared Printers in the Print Server(P. 515)**
- ▶ **Checking the LPR/RAW Printer Port(P. 517)**
- ▶ **When Printing from the Windows Store App(P. 518)**

NOTE

- Depending on the computer that you use, the operation may differ.

■ Displaying the Printer Folder

Windows Server 2012

Right-click the lower-left corner of the screen ▶ select [Control Panel] ▶ [View devices and printers].

Windows 8.1/Server 2012 R2

Right-click [Start] ▶ select [Control Panel] ▶ [View devices and printers].

Windows 10

[

Windows Server 2016

Right-click [

■ Displaying Shared Printers in the Print Server

1 Open Windows Explorer.

Windows Server 2012

Right-click the lower-left corner of the screen ▶ select [File Explorer].

Windows 8.1/Server 2012 R2

Right-click [Start] ▶ select [File Explorer].

Windows 10/Server 2016

Right-click [

2 Select [Network] or [My Network Places] and double-click the computer set up as a print server.

- To view computers on the network, you may need to turn on network discovery or search the network for computers.

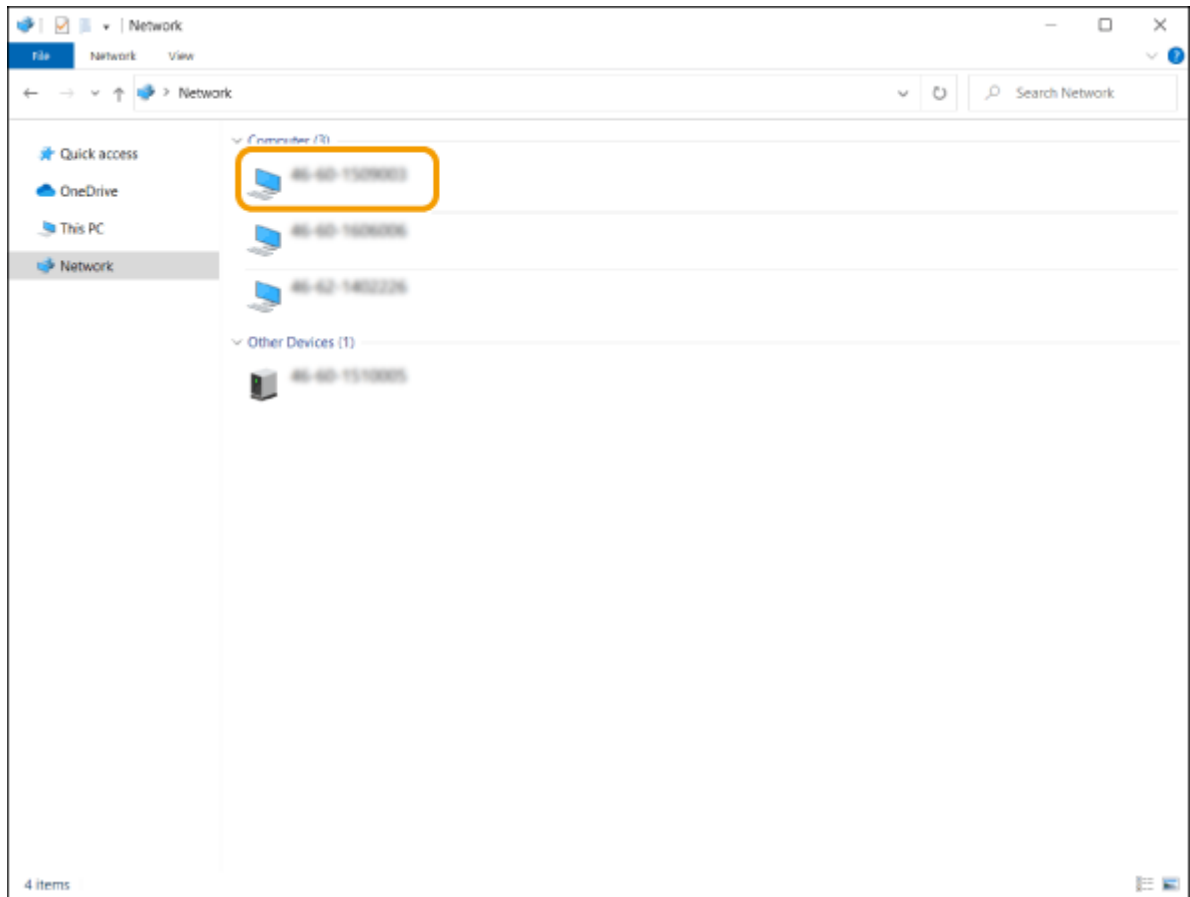

⇒ The shared printer is displayed.

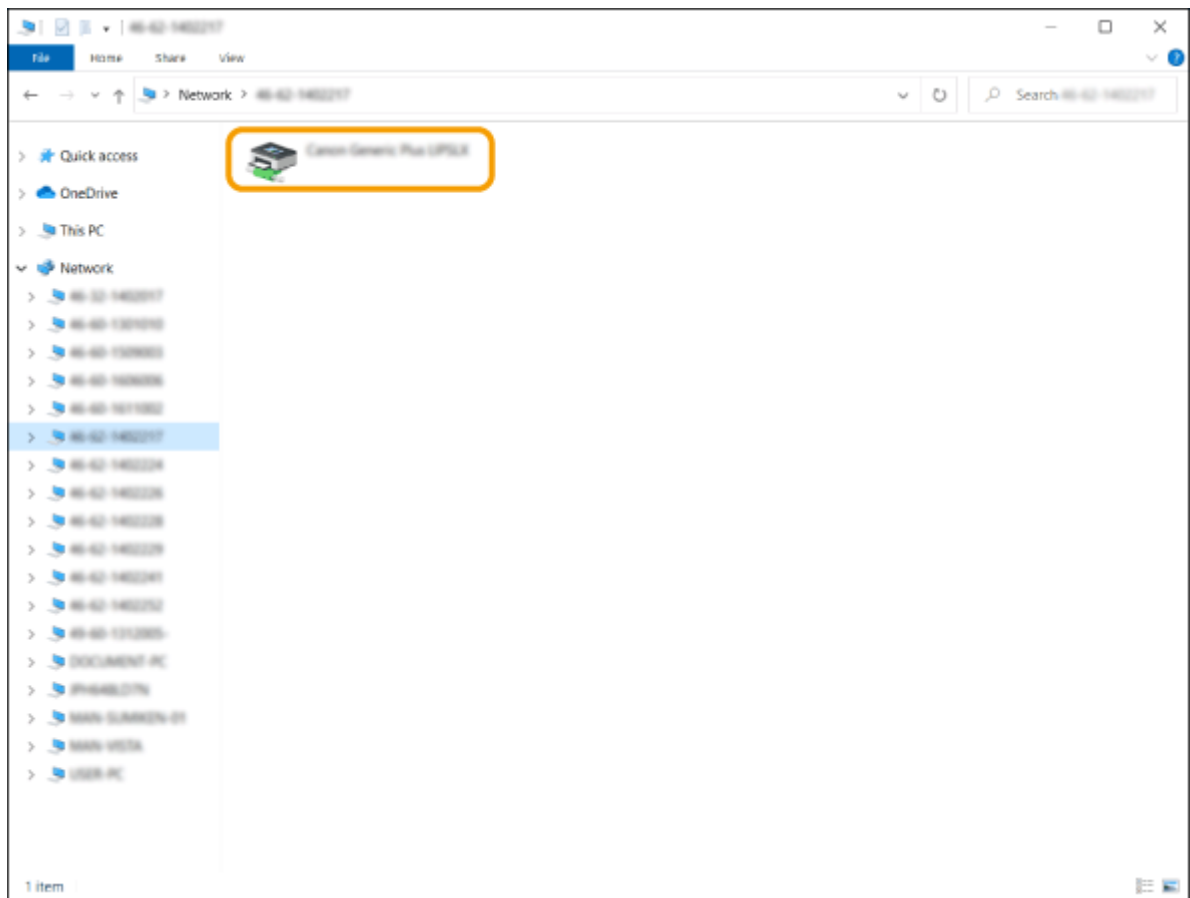

■ Checking the LPR/RAW Printer Port

1 Open the printer folder. ▶ **Displaying the Printer Folder(P. 515)**

2 Right-click your printer icon of the machine and click [Printer properties] (or [Properties]).

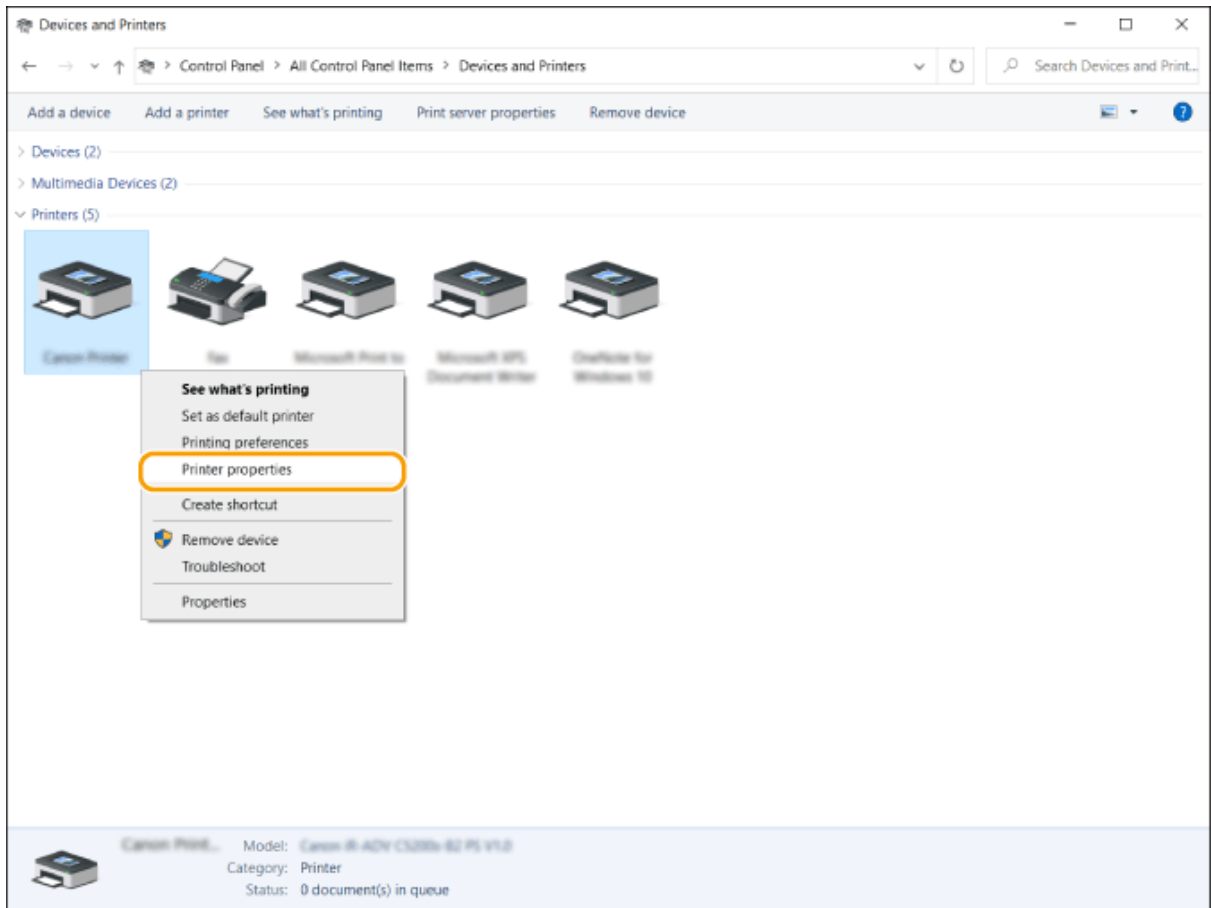

3 Check the port settings.

- Click the [Ports] tab.
- Make sure that the correct port is selected for the printer.

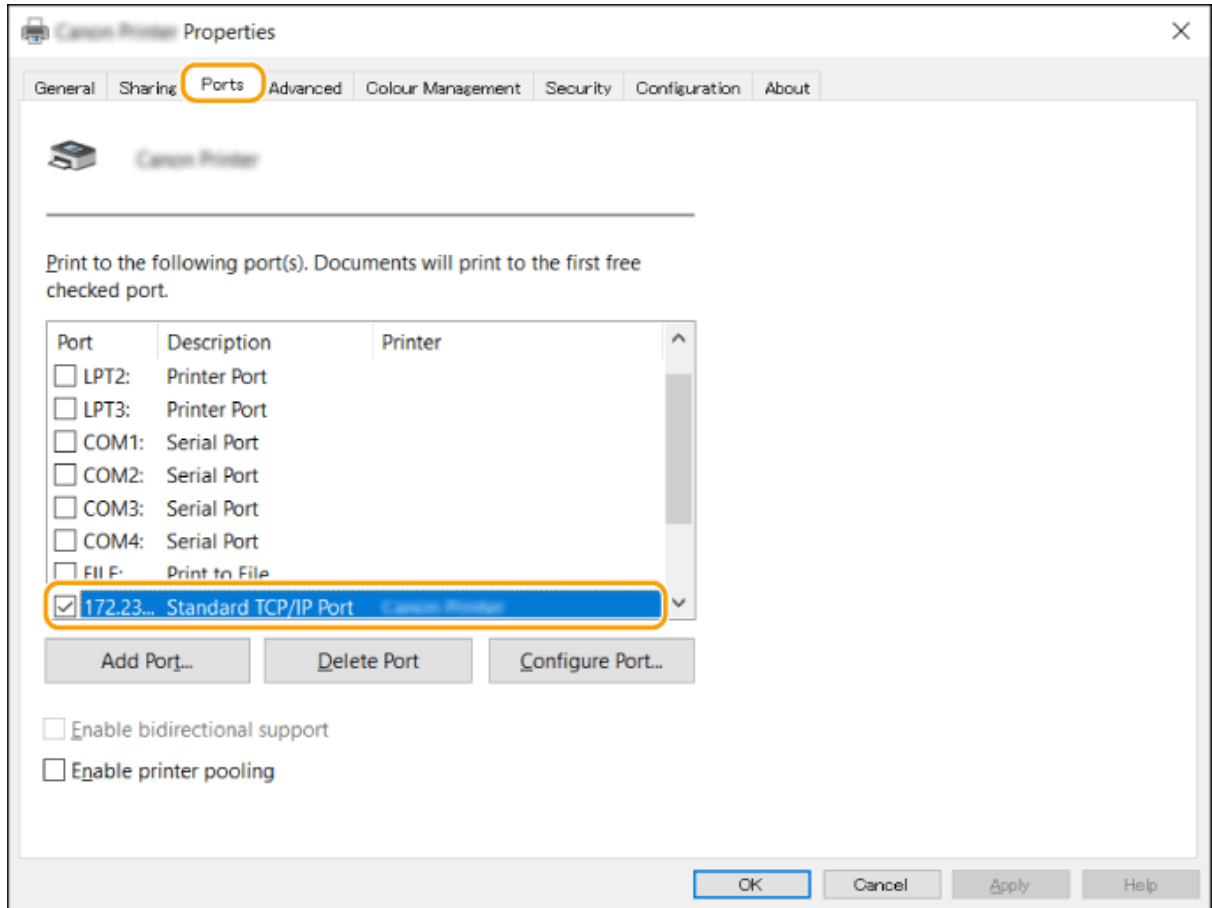

■ When Printing from the Windows Store App

Windows Server 2012

Display the charms on the right side of the screen ► Tap or click [Devices] ► The driver that you use ► [Print].

Windows 8.1/Server 2012 R2

Display the charms on the right side of the screen ► Tap or click [Devices] ► [Print] ► The driver that you use ► [Print].

Windows 10

Tap or click [Print] on the application ► The driver that you use ► [Print].

NOTE

- If you print using this method, only a limited number of print settings are available.
- If the message [The printer requires your attention. Go to the desktop to take care of it.] is displayed, go to the desktop and follow the instructions in the displayed dialog box. This message appears when the machine is set to display the user name during printing and similar instances.

System Specifications

7L2J-09Y

This section presents the system specifications for this product. Specifications are subject to change without notice for product improvement or future release.

■ Functional Specifications

- ▶ **Printer Functions(P. 520)**
- ▶ **Management Functions(P. 523)**

■ Environment To Use the Machine

- ▶ **System Environment(P. 527)**
- ▶ **Network Environment(P. 528)**
- ▶ **System Options(P. 530)**

Printer Functions

7L2J-0A0

■ UFR II Printer Function

Type	Internal
Print Size	▶ Available Paper(P. 534)
Print Speed	Same as "Print Speed" in "Main Unit" ▶ Main Unit(P. 532)
Data Processing Resolution	600 dpi x 600 dpi, 1200 dpi x 1200 dpi
Page Description Language (PDL)	UFR II
Protocol Supported	TCP/IP (LPD/Port9100/IPP/IPPS/FTP/WSD)
Compatible OS	<ul style="list-style-type: none"> • Windows 8.1/Windows 10/Windows Server 2012/Windows Server 2012 R2/Windows Server 2016/Windows Server 2019 • Mac OS X (10.11 and later)
Resident Fonts	None
Interface	USB2.0High • Speed, 1000Base-T/100Base-TX/10Base-T (IEEE 802.3 compliant)

■ PCL Printer Function

Type	Internal
Print Size	▶ Available Paper(P. 534)
Print Speed	Same as "Print Speed" in "Main Unit" ▶ Main Unit(P. 532)
Data Processing Resolution	<ul style="list-style-type: none"> • PCL5: 600 dpi x 600 dpi • PCL6: 600 dpi x 600 dpi, 1200 dpi x 1200 dpi
Page Description Language (PDL)	PCL5, PCL6
Protocol Supported	TCP/IP (LPD/Port9100/IPP/IPPS/FTP/WSD)
Compatible OS	Windows 8.1/Windows 10/Windows Server2012/Windows Server2012 R2/Windows Server2016/Windows Server2019
Resident Fonts	93 Roman, 10 Bitmap fonts, 2 OCR fonts, Andalé Mono WT J/K/S/T* ¹ (Japanese, Korean, Simplified Chinese, and Traditional Chinese) , Barcode fonts* ²

Interface	USB2.0High・Speed, 1000Base-T/100Base-TX/10Base-T (IEEE 802.3 compliant)
------------------	---

*1 Requires optional PCL International Font Set

*2 Require optional Barcode Printing Kit

■ PS Printer Function

Type	Internal
Print Size	▶ Available Paper(P. 534)
Print Speed	Same as "Print Speed" in "Main Unit" ▶ Main Unit(P. 532)
Data Processing Resolution	600 dpi x 600 dpi, 1200 dpi x 1200 dpi
Page Description Language (PDL)	Adobe PostScript 3
Protocol Supported	TCP/IP (LPD/Port9100/IPP/IPPS/FTP/WSD)
Compatible OS	<p>Driver</p> <ul style="list-style-type: none"> ● Windows 8.1/Windows 10/Windows Server2012/Windows Server2012 R2/Windows Server2016/Windows Server2019 ● Mac OS X (10.11 and later) <p>PPD</p> <ul style="list-style-type: none"> ● Windows 8.1/Windows 10 ● Mac OS X (10.11 and later)
Resident Fonts	136 Styles
Interface	USB2.0High・Speed, 1000Base-T/100Base-TX/10Base-T (IEEE 802.3 compliant)

■ E-Mail Print Function

Compatible Mail Receiving Server Software	<ul style="list-style-type: none"> ● Microsoft Exchange Server 2013 ● Microsoft Exchange Server 2016 ● Microsoft Exchange Server 2019 ● Qpopper 4.1.0
Protocol Supported	POP3 (receive*1), SMTP (receive*2)
Supported Attachment File Decoding Formats	uuencode, x-uuencode, base64
Printable Format of Attached Image Files	TIFF

*1 Supports APOP and encrypted communication (TLS) during POP RX.

*2 Supports encrypted communication (TLS) during SMTP RX.

Management Functions

7L2J-0A1

■ Information Registered in User Authentication

Up to 5,001 users can be registered.

■ Registering Department IDs

Up to 1,000 Department IDs can be registered.

■ Authentication Functions

- When an Active Directory server is specified as an authentication server, the following system environment is required.

Software (operating system):	Windows Server 2008 SP2 ^{*1} /Windows Server 2008 R2 SP1/Windows Server 2012 ^{*2} / Windows Server 2012 R2 ^{*2} /Windows Server 2016 ^{*2} /Windows Server 2019 ^{*2}
-------------------------------------	---

^{*1} 64-bit operating systems are not supported.

^{*2} Users cannot log in with Active Directory authentication if Kerberos Armoring is enabled for KDC-related policies (group policies). Make sure to disable Kerberos Armoring.

- Kerberos encryption methods for the Active Directory authentication supported by the current version of User Authentication are as follows.

Encryption method	<ul style="list-style-type: none"> 128-bit AES (Advanced Encryption Standard) 256-bit AES (Advanced Encryption Standard) DES (Data Encryption Standard) RC4
--------------------------	---

NOTE

- The available encryption methods may vary, depending on the Active Directory settings.
- Of the available encryption methods, the one with the highest cipher strength is automatically selected.

- When specifying an Active Directory server as an authentication server, use the following ports^{*1} on the server.

To communicate with a DNS server:	port number 53
To communicate with a KDC (Key Distribution Center):	port number 88
To communicate with a server for LDAP directory service (can be changed to an arbitrary port number for the LDAP service):	port number 389

^{*1} The above port numbers are default values. These numbers may vary depending on the selected settings.

- When specifying an LDAP server as an authentication server, the following system environment is required.

Software:	OpenLDAP
Operating system:	Requirements are pursuant to the product specifications of the LDAP server.

- When specifying an LDAP server as an authentication server, use the following ports*1 on the server.

To communicate with the LDAP server using LDAP (when TLS is enabled):	port number 636
To communicate with the LDAP server using LDAP (when TLS is disabled):	port number 389

*1 The port numbers can be changed according to the LDAP server settings.

■ Firewall Settings

- When specifying IP addresses in firewall settings, up to 16 IP addresses (or ranges of IP addresses) can be specified for both IPv4 and IPv6.
- When specifying MAC addresses in firewall settings, up to 100 MAC addresses can be specified.
- The exception addresses and exception port numbers that can be used for communication using the sub line and are registered by default are indicated below.

Exception addresses:	0.0.0.1 to 255.255.255.255
Exception port numbers:	53, 67, 68, 80, 161, 443, 515*, 631*, 3702, 5353, 5357, 5358, 8000*, 8080, 8443*, 9013, 9100*, 10443*, 20010*, 47545

* Inbound filter only

■ Registration of Keys and Certificates

- If you install a key or CA certificate from a computer, make sure that they meet the following requirements:

Format	<ul style="list-style-type: none"> Key: PKCS#12*1 CA certificate: X.509 DER/PEM
File extension	<ul style="list-style-type: none"> Key: ".p12" or ".pfx" CA certificate: ".cer" or ".pem"
Public key algorithm (and key length)	<ul style="list-style-type: none"> RSA (512 bits, 1024 bits, 2048 bits, 4096 bits) DSA (1024 bits, 2048 bits, 3072 bits) ECDSA (P256, P384, P521)
Certificate signature algorithm	<ul style="list-style-type: none"> RSA: SHA-1, SHA-256, SHA-384*2, SHA-512*2, MD2, MD5 DSA: SHA-1 ECDSA: SHA-1, SHA-256, SHA-384, SHA-512
Certificate thumbprint algorithm	SHA-1

*1 Requirements for the certificate contained in a key are pursuant to CA certificates.

*2 SHA384-RSA and SHA512-RSA are available only when the RSA key length is 1024 bits or more.

■ Registration of Certificate Revocation Lists (CRL)

Up to 50 certificate revocation lists (CRL) can be registered. Note, however, that CRL cannot be registered in the following cases.

- The data size of the CRL exceeds 1 MB.
- An unsupported signature algorithm is being used.
- The number of revoked certificates registered in one CRL file exceeds 1,000.

■ Definition of "Weak Encryption"

When [Prohibit Use of Weak Encryption] is selected, the use of the following algorithms is prohibited.

Hash:	MD4, MD5, SHA-1
HMAC:	HMAC-MD5
Common key cryptosystem:	RC2, RC4, DES
Public key cryptosystem:	RSA encryption (512 bits/1024 bits), RSA signature (512 bits/1024 bits), DSA (512 bits/1024 bits), DH (512 bits/1024 bits)

NOTE

- Even when [Prohibit Use of Key/Certificate with Weak Encryption] is selected, the hash algorithm SHA-1, which is used for signing a root certificate, can be used.

■ FIPS 140-2 Standard Algorithm

When [Format Encryption Method to FIPS 140-2] is selected, the following algorithms are prohibited from use.

Hash:	MD4, MD5, SHA-1 (for a purpose other than TLS)
Common key cryptosystem:	RC2, RC4, DES, PBE
Public key cryptosystem:	RSA encryption (512 bits/1024 bits), RSA signature (512 bits/1024 bits), DSA signature (512 bits/1024 bits), DH (512 bits/1024 bits)

■ Log Management

- The following types of logs can be managed on the machine. Collected logs can be exported in the CSV file format.

Log Type	Number Indicated as "Log Type" in the CSV File	Description
User Authentication Log	4098	This log contains information related to the authentication status of user authentication (login/logout and user authentication success/failure), the registering/changing/

		deleting of user information managed with User Authentication.
Job Log	1001	This log contains information related to the completion of print jobs.
Receive Log	8193	This log contains information related to reception.
Machine Management Log	8198	This log contains information related to the starting/shutting down of the machine and changes made to the settings using <Set>. The Machine Management Log also records changes in user information or security-related settings when the machine is inspected or repaired by your dealer or service representative.
Network Authentication Log	8200	This log is recorded when IPSec communication fails.
Export/Import All Log	8202	This log contains information related to the importing/exporting of the settings by using the Export All/Import All function.
Application/Software Management Screen Operation Log	3101	This is an operation log for software registration/updates, and AddOn application installers, etc.
Security Policy Log	8204	This log contains information related to the setting status of the security policy settings.
System Maintenance Log	8206	This log contains information related to firmware updates and backup/restoration of the AddOn application, etc.
Authentication Print Log	8207	This log contains information and the operation history related to the forced hold print jobs.
Log for Audit Log Management	3001	This log contains information related to the starting and ending of this function (the Audit Log Management function), as well as the exporting of logs, etc.

NOTE

- Logs can contain up to 40,000 records. When the number of records exceeds 40,000, they are deleted, with the oldest records first.

■ Import/Export of the Setting Data

See  **Settings/Registration Table(P. 296)** .

■ SCEP Server Support

Only the Network Device Enrollment Service (NDES) of Windows Server 2008 R2/Windows Server 2012 R2/Windows Server 2016 is supported.

System Environment

7L2J-0A2

System requirements for the Remote UI *1	<p>Windows</p> <ul style="list-style-type: none"> • Internet Explorer 11 • Microsoft Edge • Google Chrome <p>Mac OS</p> <ul style="list-style-type: none"> • Safari 11 or later • Google Chrome
System requirements for the User's Guide	<p>Windows</p> <ul style="list-style-type: none"> • Internet Explorer 9 and later • Microsoft Edge • Firefox • Firefox ESR • Chrome (Online browsing only) <p>Linux</p> <ul style="list-style-type: none"> • Firefox <p>Mac OS</p> <ul style="list-style-type: none"> • Safari • Firefox • Chrome (Online browsing only) <p>iOS</p> <ul style="list-style-type: none"> • Safari (Online browsing only) <p>Android</p> <ul style="list-style-type: none"> • Chrome (Online browsing only)

*1 Before changing the settings of the machine, set your Web browser to enable all cookies and use JavaScript.

Network Environment

7L2J-0A3

■ Wired LAN Specifications

Interface (Primary line/Secondary line)	10Base-T/100Base-TX/1000Base-T (RJ-45)
Protocol Supported	<p>TCP/IP</p> <ul style="list-style-type: none"> • Frame type: Ethernet II • Print applications: LPD/Raw/IPP/IPPS/FTP/WSD/Mopria/AirPrint/Windows 10 Mobile Print

NOTE

- For precautions related to the sub line, see [▶ Cautions When Using the Sub Line\(P. 512\)](#) .

■ Wireless LAN Specifications

Standard	IEEE 802.11b, IEEE 802.11g, IEEE 802.11n
Transmission Scheme	<ul style="list-style-type: none"> • IEEE 802.11b (Modulation system: DS-SS) • IEEE 802.11g (Modulation system: OFDM method) • IEEE 802.11n (Modulation system: OFDM method)
Frequency Range	2.412 to 2.472 GHz
Maximum Radio-Frequency Power Transmitted	+14.08 dBm
Security (encryption method)	<p>Infrastructure Mode</p> <ul style="list-style-type: none"> • 128 (104)/64 (40) bit WEP • WPA-PSK (TKIP/AES-CCMP) • WPA2-PSK (TKIP/AES-CCMP) • WPA-EAP (AES-CCMP) • WPA2-EAP (AES-CCMP) <p>Access Point Mode</p> <p>WPA2-PSK (AES-CCMP)</p> <p>Wi-Fi Direct Mode</p> <p>WPA2-PSK (AES-CCMP)</p>
Connection Method	WPS (Wi-Fi Protected Setup), Manual setup

Port Numbers Available for Direct Connection

Type	Port Number	Protocol
TCP	515	LPD
	9100	RAW
	80, 8000, 8080	HTTP
	631	IPP
	443, 10443	IPPS
	443, 8443	HTTPS
	9013	CPCA (unique Canon protocol)
	5357, 5358	WSD
UDP	161	SNMP
	5353	mDNS
	67, 68	DHCPv4
	3702	WSD
	47545	CPCA (unique Canon protocol)

System Options

7L2J-0AU

By installing system-related options, you can further enhance the performance of the machine.

■ Barcode Printing Kit

This option enables you to print barcodes. For more details, see Bar Code Printing via the online manual site.

■ PCL International Font Set

This option enables you to add the following fonts for a PCL printer. As a result, you can output using multiple languages in a SAP Unicode environment.

- Andale® and WorldType® Collection J (Japanese Version)
- Andale® and WorldType® Collection K (Korean Version)
- Andale® and WorldType® Collection S (Simplified Chinese Version)
- Andale® and WorldType® Collection T (Traditional Chinese Version)

In order to support differences in character design depending on the region, four font versions are enabled.

Hardware Specifications

7L2J-0A5

This section presents the specifications of the main unit and optional equipment of this product. Note that the specifications are subject to change without notice for product improvement or future release.

■ Machine Specifications

- ▶ **Main Unit(P. 532)**
- ▶ **Available Paper(P. 534)**

■ Specifications of Optional Equipment

- ▶ **Paper Feeder PF-D(P. 541)**
- ▶ **Cassette Feeding Unit-AV(P. 542)**

Main Unit

7L2J-0A6

Name	Canon imageCLASS X C1538P
Type	Desktop
Resolution for Writing	600 dpi x 600 dpi
Number of Tones	256
Acceptable Paper Stock	<p>Paper Sizes</p> <p>Paper Drawer</p> <ul style="list-style-type: none"> • Max: 216.0 mm x 297.0 mm • Min: 101.6 mm x 148.0 mm <p>Multi-Purpose Tray</p> <ul style="list-style-type: none"> • Max: 216.0 mm x 355.6 mm • Min: 76.2 mm x 127.0 mm <p>Paper Weight</p> <ul style="list-style-type: none"> • Paper Drawer: 60 g/m² to 163 g/m² • Multi-Purpose Tray: 60 g/m² to 216 g/m²
Paper Type	▶Available Paper(P. 534)
Warm-Up Time *1	<p>After Powering ON</p> <ul style="list-style-type: none"> • When <Quick Startup Settings for Main Power> is set to <On>: 2 seconds or less* • When <Quick Startup Settings for Main Power> is set to <Off>: 50 seconds or less <p>*Depending on the situations, the machine does not startup quickly. Returning from the Sleep mode</p> <p>6 seconds or less</p>
First Print Time	<ul style="list-style-type: none"> • Color: 6.3 seconds or less • Black and White: 5.3 seconds or less
Print Speed *2(Plain A4/LTR, 100%)	<ul style="list-style-type: none"> • 38 sheets/minute (A4) • 40 sheets/minute (LTR)
Paper Feeding System/Capacity *3	<p>Paper Drawer</p> <ul style="list-style-type: none"> • 550 sheets (80 g/m² / 75 g/m²) • 640 sheets (64 g/m²) • Paper other than above: height 60 mm or less <p>Multi-Purpose Tray</p> <ul style="list-style-type: none"> • 100 sheets (80 g/m² / 75 g/m² / 64 g/m²) x 1 • Paper other than above: height 11 mm or less

Appendix

Inner Tray Capacity	200 sheets (80 g/m ² / 75 g/m ² / 64 g/m ²)* ³
Power Source	220 V - 240 V a.c., 50/60 Hz, 3.7 A
Power Consumption * ¹	<p>Maximum Power Consumption</p> <p>1,500 W</p> <p>When the machine is in the Sleep mode</p> <p>1.1 W</p> <p>When the main power switch is turned OFF</p> <ul style="list-style-type: none"> • When <Quick Startup Settings for Main Power> is set to <On>: 1.1 W • When <Quick Startup Settings for Main Power> is set to <Off>: 0.4 W
Dimensions (W x D x H)	458 mm x 464 mm x 443 mm
Weight (Toner cartridges excluded)	<p>Main Unit Approximately 25 kg</p> <p>Consumables</p> <p>▶ Consumables(P. 418)</p>
Installation Space (W x D)	<p>696 mm x 764 mm (When the paper drawer is pulled out and the multi-purpose tray is opened.)</p> <p>*Provide a space of 100 mm or more around the machine.</p>
Memory Capacity	<p>RAM: 2 GB</p> <p>eMMC: 15 GB</p>
Environmental Conditions	<p>Temperature: 10 °C to 30 °C</p> <p>Humidity: 20 % to 80 % RH (no condensation)</p>

*¹ May vary depending on the environment and conditions under which the machine is being used.

*² Print speed is measured based on internal testing using A4/LTR size paper printed with 100% print ratio to original on one-sided paper. Internal testing involved continuously printing the same one page of content on plain paper. Print speed may vary depending on paper type, paper size or paper feeding direction. The device may automatically pause or slow down in order to adjust printer condition such as controlling temperature of a certain unit or limiting impact to image quality during continuous printing.

*³ May vary depending on the installation environment and paper to use.

Available Paper

7L2J-0A7

The paper types that can be used with this machine are shown in the following table. Also, confirm the precautions regarding paper use.

- ▶ Supported Paper Sizes(P. 534)
- ▶ Supported Paper Types(P. 538)
- ▶ Precautions Regarding Paper(P. 539)
- ▶ Storing Paper Printed With the Machine(P. 540)

Supported Paper Sizes

Paper Sizes	Paper Source (Standard)		Paper Source (Optional)	
	Paper Drawer 1	Multi-Purpose Tray	Paper Feeder PF-D	Cassette Feeding Unit-AV
A4	✓	✓	✓	✓
A5	✓	✓	✓	✓
A5R	✓	✓	✓	✓
A6	✓	✓	✓	✓
B5	✓	✓	✓	✓
16K	✓	✓	✓	✓
LTR	✓	✓	✓	✓
LGL	-	✓	✓	✓
STMT	✓	✓	✓	✓
EXEC	✓	✓	✓	✓
FOOLSCAP/FOLIO	-	✓	✓	✓
OFICIO	-	✓	✓	✓
OFICIO (Mexico)	-	✓	✓	✓
LETTER (Government)	✓	✓	✓	✓
OFICIO (Brazil)	-	✓	✓	✓

Appendix

Paper Sizes	Paper Source (Standard)		Paper Source (Optional)	
	Paper Drawer 1	Multi-Purpose Tray	Paper Feeder PF-D	Cassette Feeding Unit-AV
LEGAL (India)	-	✓	✓	✓
LEGAL (Government)	-	✓	✓	✓
FOOLSCAP (Australia)	-	✓	✓	✓
F4A	-	✓	✓	✓
Free Size (76.2 mm x 127.0 mm to 216.0 mm x 355.6 mm)	✓*1	✓	✓*2	✓*2
Custom Size (76.2 mm x 127.0 mm to 216.0 mm x 355.6 mm)	✓*1	✓	✓*2	✓*2
Postcard	-	✓	-	-
Reply Postcard	-	✓	-	-
4 on 1 Postcard	-	✓	-	-
No.10 (COM10)	-	✓	-	-
ISO-C5	-	✓	-	-
DL	-	✓	-	-
Monarch	-	✓	-	-
Nagagata 3	-	✓	-	-
Yougatanaga 3	-	✓	-	-

*1 You can use custom size settings ranging from 101.6 mm x 148.0 mm to 216.0 mm x 297.0 mm.

*2 You can use custom size settings ranging from 101.6 mm x 148.0 mm to 216.0 mm x 355.6 mm.

NOTE

Paper sizes supported by this machine

- The following table shows most of the sizes of paper and envelope that can be used with the machine.

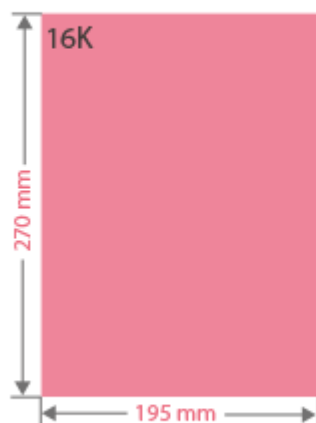
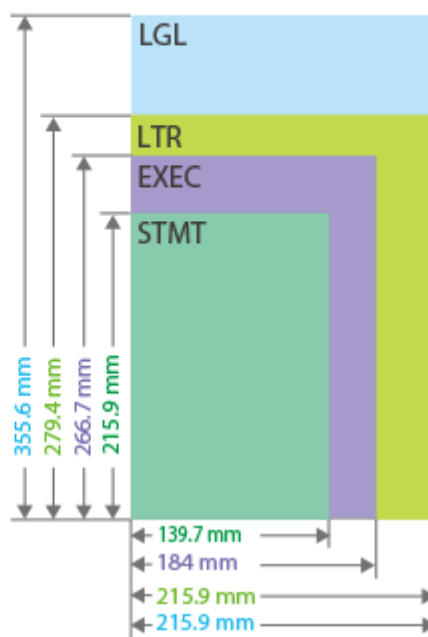
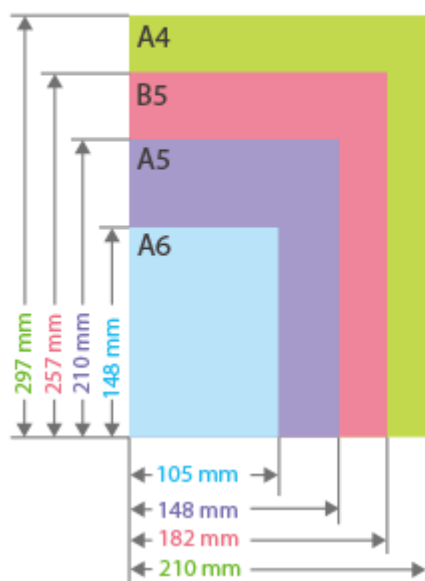

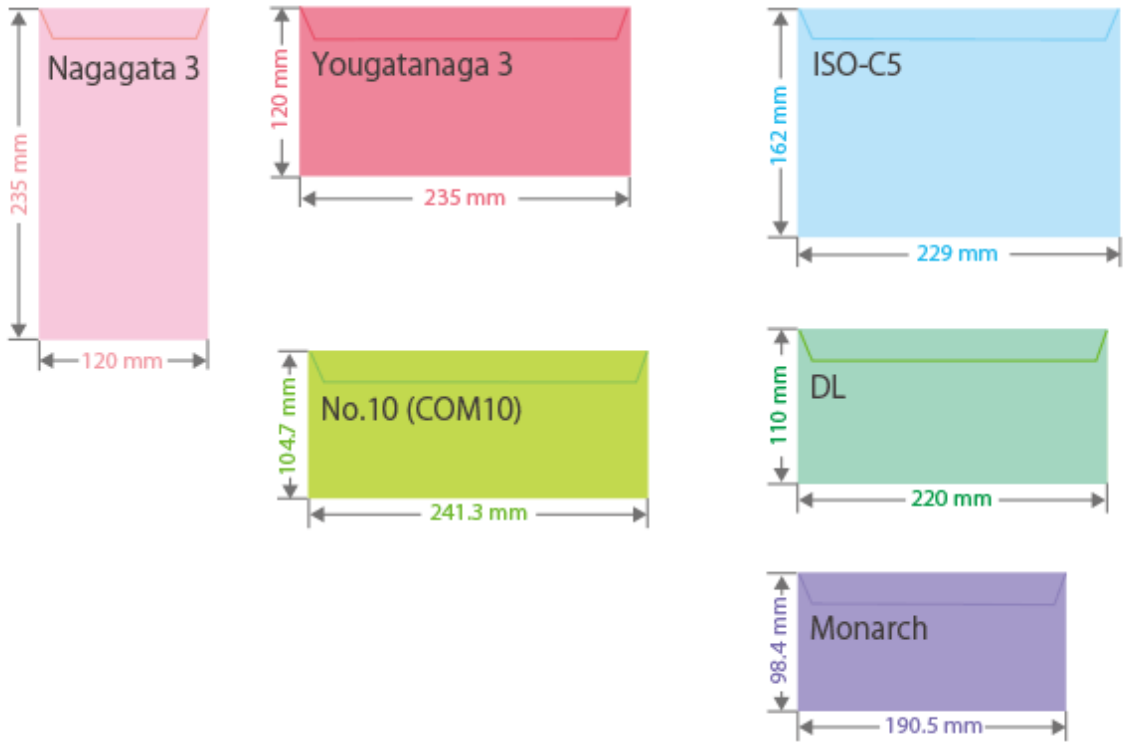

- Other supported paper sizes are as follows.

FOOLSCAP/FOLIO (215.9 mm x 330.2 mm)

OFICIO (215.9 mm x 317.5 mm)

OFICIO (Mexico) (216.0 mm x 341.0 mm)

LETTER (Government) (203.2 mm x 266.7 mm)

OFICIO (Brazil) (216.0 mm x 355.0 mm)

LEGAL (India) (215.0 mm x 345.0 mm)

LEGAL (Government) (203.2 mm x 330.2 mm)

FOOLSCAP (Australia) (206.0 mm x 337.0 mm)

F4A (215.9 mm x 342.9 mm)

Postcard (100.0 x 148.0 mm)

Reply Postcard (148.0 x 200.0 mm)

4 on 1 Postcard (200.0 x 296.0 mm)

"Vertical" side and "Horizontal" side of paper

- In the User's Guide, regardless of the paper orientation, the side of paper perpendicular (**a**) to the front of the machine is referred to as the "vertical" side while the side parallel (**b**) to the front of the machine is referred to as the "horizontal" side.

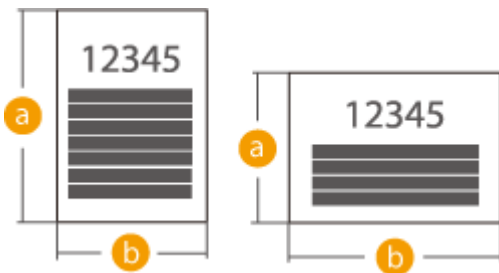

Supported Paper Types

Chlorine-free paper can be used with this machine.

Paper Type	Paper Weight	Paper Source (Standard)		Paper Source (Optional)	
		Paper Drawer 1	Multi-Purpose Tray	Paper Feeder PF-D	Cassette Feeding Unit-AV
Thin	60 g/m ²	✓	✓	✓	✓
Plain 1	61 to 74 g/m ²	✓	✓	✓	✓
Plain 2	75 to 90 g/m ²	✓	✓	✓	✓
Plain 3	91 to 105 g/m ²	✓	✓	✓	✓
Heavy 1	106 to 119 g/m ²	✓	✓	✓	✓
Heavy 2	120 to 128 g/m ²	✓	✓	✓	✓
Heavy 3	129 to 163 g/m ²	✓	✓	✓	✓
Heavy 4	164 to 200 g/m ²	-	✓	-	-
Heavy 5	201 to 216 g/m ²	-	✓	-	-
Color	61 to 74 g/m ²	✓	✓	✓	✓
Recycled 1 ^{*1}	61 to 74 g/m ²	✓	✓	✓	✓
Recycled 2 ^{*1}	75 to 90 g/m ²	✓	✓	✓	✓
Letterhead 1	61 to 74 g/m ²	✓	✓	✓	✓
Letterhead 2	75 to 90 g/m ²	✓	✓	✓	✓
Letterhead 3	91 to 105 g/m ²	✓	✓	✓	✓
Letterhead 4	106 to 119 g/m ²	✓	✓	✓	✓
Letterhead 5	120 to 128 g/m ²	✓	✓	✓	✓
Letterhead 6	129 to 163 g/m ²	✓	✓	✓	✓
Letterhead 7	164 to 200 g/m ²	-	✓	-	-
Labels	118 to 130 g/m ²	✓	-	✓	✓

Paper Type	Paper Weight	Paper Source (Standard)		Paper Source (Optional)	
		Paper Drawer 1	Multi-Purpose Tray	Paper Feeder PF-D	Cassette Feeding Unit-AV
Bond 1	60 to 74 g/m ²	✓	✓	✓	✓
Bond 2	75 to 105 g/m ²	✓	✓	✓	✓
Envelope	80 to 100 g/m ²	-	✓	-	-
Postcard ^{*2}	190 g/m ²	-	✓	-	-

*1 You can use 100% recycled paper.

*2 The inkjet printable postcard or reply postcard can not be used.

■ Paper Available for Two-Sided Printing

- When performing 2-sided printing, use paper that meets the following requirements.

Paper size: A4, B5, A5R, LGL, LTR, EXEC, 16K, FOOLSCAP/FOLIO, OFICIO, OFICIO (Mexico), LETTER (Government), OFICIO (Brazil), LEGAL (India), LEGAL (Government), FOOLSCAP (Australia), F4A, Free Size (148.0 mm x 210.0 mm to 216.0 mm x 355.6 mm), Custom Size (148.0 mm x 210.0 mm to 216.0 mm x 355.6 mm)

Paper type: Thin, Plain 1, Plain 2, Plain 3, Heavy 1, Heavy 2, Heavy 3, Recycled 1, Recycled 2, Letterhead 1, Letterhead 2, Letterhead 3, Letterhead 4, Letterhead 5, Letterhead 6, Bond 1, Bond 2 and Color

Paper weight: 60 g/m² to 163 g/m²

If using other paper, select <Yes> for <Enable settings for 2nd side of 2-sided page?> to print on the back side of printed paper.

Precautions Regarding Paper

IMPORTANT

Do not use the following types of paper

Doing so may cause a paper jam or other printing problems.

- Wrinkled or creased paper
- Curled or rolled paper
- Torn paper
- Damp paper
- Very thin paper
- Thin straw paper
- Paper printed by a thermal transfer printer
- The reverse side of paper which has been printed by a thermal transfer printer
- Highly textured paper
- Glossy paper
- Inkjet printable postcard

When using paper

- Only use paper that has fully acclimatized to the environment in which this machine is installed. Using paper that has been stored under different temperature or humidity may cause paper jams or result in poor print quality.

Paper handling and storage

- We recommend using the paper immediately after opening the package. Rewrap any remaining paper in its original package, and store it on a flat surface.
- Keep the paper wrapped in its original package to protect the paper from moisture or dryness.
- Do not store the paper in such a way that may cause it to curl or fold.
- Do not store the paper vertically or stack too much paper.
- Do not store the paper in direct sunlight, or in a place subject to high humidity, dryness, or drastic changes in temperature or humidity.

NOTE

When printing on paper that has absorbed moisture

- Steam may emit from the paper output area, or water droplets may form around the paper output area. There is nothing unusual about any of these occurrences, which occur when the heat generated from fixing toner on the paper causes moisture in the paper to evaporate (most likely to occur at low room temperatures).

Storing Paper Printed With the Machine

Be aware of the following precautions when handling and storing paper printed using the machine.

■ Storing Printed Paper

- Store the paper on a flat surface.
- Do not store paper together with items made from PVC (polyvinyl chloride), such as clear folders. The toner may melt, causing paper to become stuck to PVC-based material.
- Store paper so that it does not become folded or wrinkled. Doing so may cause the toner to come off.
- If you intend to store paper for long periods (two or more years), preserve them in a binder, etc.
- Long-term storage may cause paper to discolor, which in turn may cause print to appear discolored.
- Do not store paper in places with high temperatures.

■ Precautions when sticking printouts with adhesive

- Be sure to use insoluble adhesive.
- Test the adhesive on an unneeded printout before using.
- Before stacking printouts that stuck with adhesive, check that the adhesive completely dried.

Paper Feeder PF-D

7L2J-0A8

Paper Size/Weight/Type	🔗 Available Paper(P. 534)
Paper Drawers Capacity	<ul style="list-style-type: none">• 550 sheets (80 g/m² / 75 g/m²)• 640 sheets (64 g/m²)• Paper other than above: 60 mm in height or less
Dimensions (W x D x H)	458 mm x 464 mm x 130 mm
Weight	Approximately 6.1 kg

Cassette Feeding Unit-AV

7L2J-0A9

Paper Size/Weight/Type	🔗 Available Paper(P. 534)
Paper Drawers Capacity	<ul style="list-style-type: none">• 550 sheets (80 g/m² / 75 g/m²)• 640 sheets (64 g/m²)• Paper other than above: 60 mm in height or less
Dimensions (W x D x H)	597 mm x 635 mm x 225 mm
Weight	Approximately 15.5 kg

Options

7L2J-0AA

The functionality of the machine can be expanded by installing options to the machine.

■ Available Options

▶ **Optional Equipment(P. 544)**

▶ **System Options(P. 530)**

■ Finding Options According to Your Purposes

To add paper drawers

▶ **Paper Feeder PF-D(P. 545)**

▶ **Cassette Feeding Unit-AV(P. 546)**

NOTE

- Some of the settings may not be displayed depending on the configuration of optional equipment installed on the machine.

Optional Equipment

7L2J-0AC

By combining options, you can use functions more efficiently.

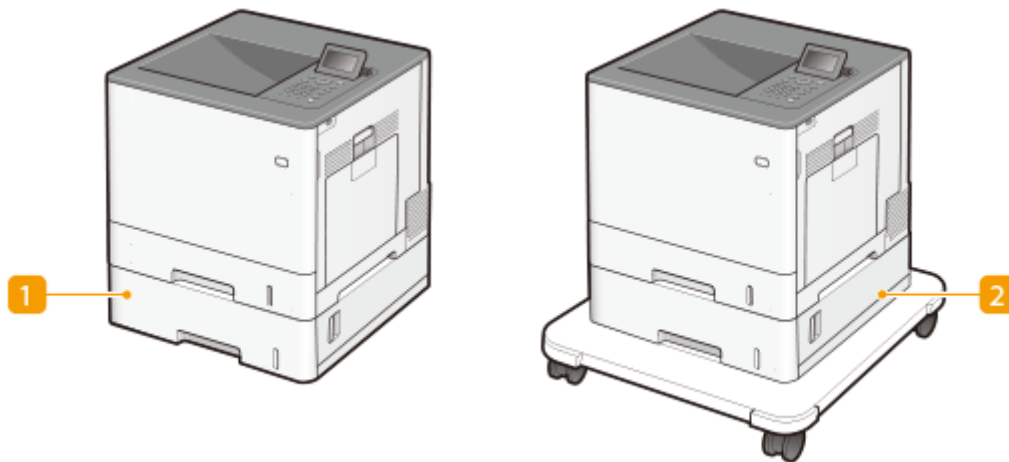

1 Paper Feeder PF-D

Load frequently used paper in the paper drawer of this product. ▶ **Paper Feeder PF-D(P. 545)**

2 Cassette Feeding Unit-AV

Load frequently used paper in the paper drawer of this product. ▶ **Cassette Feeding Unit-AV(P. 546)**

Paper Feeder PF-D

7L2J-0AE

Enables you to add a paper drawer. Loading different sized paper in the optional paper drawer enables reduced work for switching paper.

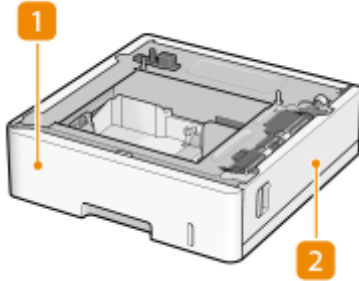

1 Paper drawer ▶ Basic Paper Loading Method(P. 64)

Load Paper.

2 Right cover

Open this cover when clearing a paper jam inside the machine. ▶ Paper Jams in a Paper Source(P. 491)

NOTE

- Up to three units of the Paper Feeder PF-D can be attached. When the Cassette Feeding Unit-AV is attached, up to two units of the Paper Feeder PF-D can be attached.

Cassette Feeding Unit-AV

7L2J-0AF

Enables you to add a paper drawer. Loading different sized paper in the optional paper drawer enables reduced work for switching paper.

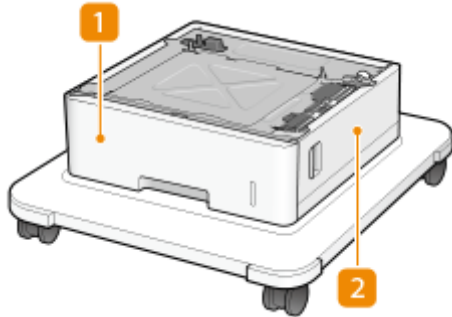

1 Paper drawer ▶ Basic Paper Loading Method(P. 64)

Load Paper.

2 Right cover

Open this cover when clearing a paper jam inside the machine. ▶ Paper Jams in a Paper Source(P. 491)







NOTE

- Up to two units of the Paper Feeder PF-D can be attached on top of the Cassette Feeding Unit-AV. Up to three paper sources can be added.

Manuals and Their Contents

7L2J-0AH

The manuals listed below are included with the machine. Refer to them as necessary.

Important Safety Instructions		<p>The content described in this manual is for the prevention of damage to property and injury to users of the machine and others.</p> 
Setup Guide		<p>This manual outlines the initial settings on the machine required when the machine is turned on for the first time; and describes how to install the software and driver.</p> 
User's Guide (This Manual)		<p>This manual describes all the functions of the machine. You can browse information by category or enter a keyword to search for pages on a specific topic.  Using User's Guide(P. 548)</p>
Setting the Machine (PS/PCL/UFR II Printer)		<p>This manual describes how to use the PS/PCL/UFR II printer.</p>

V_201012

For the manuals with  , access [here](#) .

Using User's Guide

7L2J-0AJ

The User's Guide is a manual that can be viewed on your computer or smartphone, etc. This section describes the screen layout of the User's Guide and how to view the User's Guide. It also describes how to make settings for the display of the User's Guide.

■ Screen Layout of User's Guide

This section explains the User's Guide screen layout and how to use the buttons on the screen. ▶ **Screen Layout of User's Guide(P. 549)**

■ Viewing User's Guide

This section describes what you should be familiar to when viewing the User's Guide, including the meanings of the marks used in the User's Guide and how the keys on the control panel and the buttons on the computer screen are represented in the User's Guide. ▶ **Viewing User's Guide(P. 552)**

■ Setting the Display of the User's Guide

You can change the character size used in the User's Guide, and switch the screen layout to one that is appropriate to the device on which the User's Guide is displayed.

NOTE

- If you are unable to view the manual in PDF format, download Adobe Acrobat Reader from the Adobe Systems website (<https://get.adobe.com/reader/>).

How to find the topic you are looking for

Search the contents

- You can find the page you are looking for by selecting the topic from the Contents on the left side of the screen.

Search by keyword

- Perform a search by entering a keyword, such as "envelope" or "toner cartridge," and the pages containing the keyword are displayed. You can find the page you are looking for from those results. You can also enter phrases such as "connecting to a network." The keyword search also supports the AND Boolean to search for multiple keywords. For the details of the search screen and how to operate the screen, see ▶ **Search(P. 550)** .

Screen Layout of User's Guide

7L2J-0AK

The User's Guide is divided into different screens, and the content of each screen varies.

Top Page

Appears when the User's Guide starts.

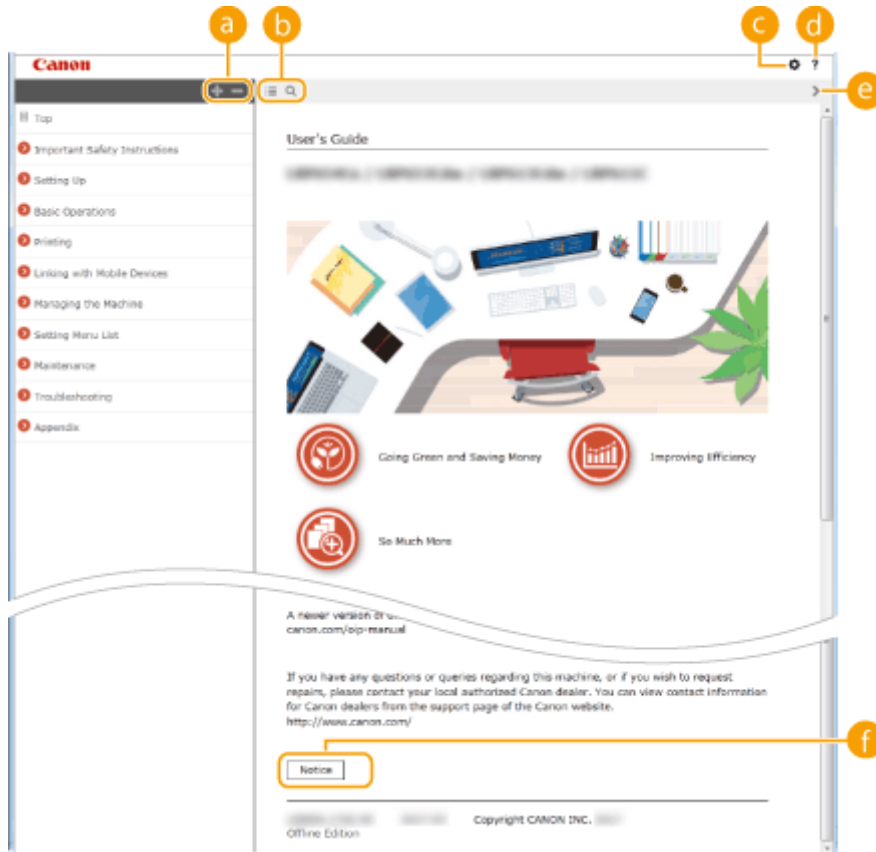

Click to display all items underneath chapters. Click to return to the original list.



Click to switch between the table of contents and the search display. When the table of contents is displayed, each click on switches between hiding and showing the display. When the search display is shown, each click on switches between hiding and showing the display.



Click to specify settings such as text size, layout, and display method for the User's Guide.



Click to display information on how to view the User's Guide, how to perform a search, and other information.



Click to display the previous or following topic.

f [Notice]

Click to view important information you should know when using the machine.

Topic Page

Contains information about how to configure and use the machine.

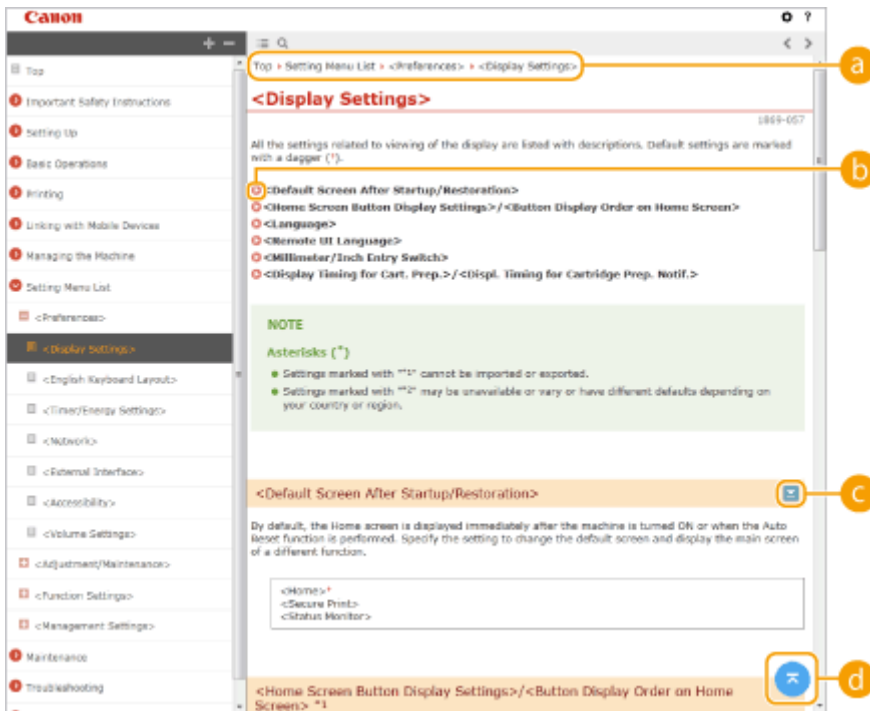

a Navigation

See what chapter topic you are currently viewing.



Click to go to the corresponding page. To return to the previous page, click "Back" on your Web browser.



Click  to display the hidden detailed descriptions. Click  to close the detailed descriptions.



Click to return to the page top.

Search

Click  to display the search screen. Contains a text box to perform a search by keyword and find the page you are looking for.

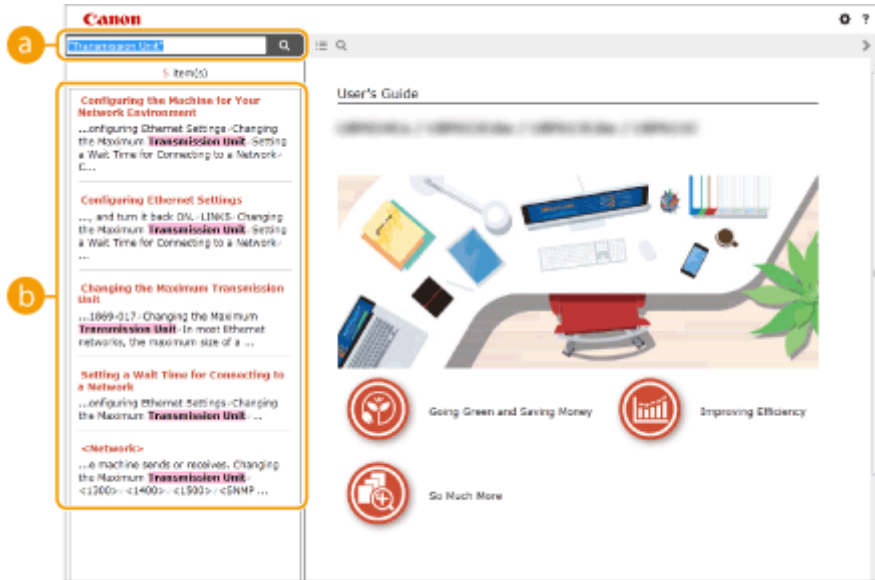

a [Enter keyword(s) here]

Enter a keyword or keywords and click  to display the search results. You can search for pages containing all the keywords by separating the keywords by a space (blank). Also you can only search for pages containing an exact phrase by enclosing the keywords in double quotation marks.

b Search result

Displays the search results of the pages that contain the specified keywords. From the results, locate the page you are looking for and click the topic title of the page.

NOTE

- The keywords appear in bold in the pages displayed as search results.

Viewing User's Guide

7L2J-0AL

This section describes the marks, buttons, screens, and other items used in the User's Guide. The warnings and cautions are also given in the "Important Safety Instructions" included with the machine. See also these instructions.

Marks

Cautions regarding safety, restrictions and cautions regarding the handling of the machine, useful tips, and other information are indicated using the marks below.



Indicates a warning concerning operations that may lead to death or serious personal injury if not performed correctly. To ensure that you use the machine safely, always observe these warnings.



Indicates a precaution for preventing the risk of personal injury or property damage other than a product fault due to improper use of the machine. To ensure that you use the machine safely, always observe these cautions.



Indicates an operation that must not be performed. Read these items carefully, and make sure not to perform the described operations.



Indicates important operational requirements and restrictions that should always be observed when using this machine. Always observe these important items to avoid malfunctions, faults or property damage due to improper machine operation.

NOTE



Indicates a clarification of an operation, or contains additional explanations for a procedure.

TIPS



Indicates useful functions or tips for using the machine.

Keys and buttons

Keys on the operation panel and buttons on the computer display appear in the following notation:

Type	Example
Keys on the control panel	 
Settings displayed on the control panel	<Function Settings> <Cancel?>
Buttons and other text interfaces displayed on the computer display	[Preferences] [OK]



▲, ▼, and  on the operation panel are used to select the target item in settings, but their description is omitted in the User's Guide. The operation for selecting <XXXXX> using ▲ or ▼ and pressing  is represented as shown below in the User's Guide.

- 1 Select <XXXXX>.

Screen

Depending on the operating system you are using, the appearance of the displays used in this manual may slightly differ from the actual displays. Also, the appearance of the printer driver and software may differ depending on their version.

Illustrations

Illustrations used in the User's Guide are from "C1538P" unless otherwise specifically noted.

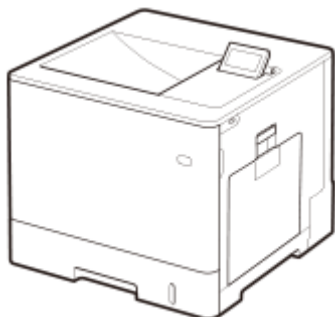

Third-Party Services

If you use third-party services through the PRODUCT, use of the services are subjected the conditions below.

When you access and/or obtain some third party content (such as text, images, videos, audios, or software) through the SOFTWARE, except as expressly permitted by the content owner or by applicable law, you may not (a) scrape, build databases or otherwise create permanent copies of such content, or keep cached copies longer than permitted by the cache header; (b) copy, translate, modify, create a derivative work of, sell, lease, lend, convey, distribute, publicly display or sublicense to any third party; (c) misrepresent the source or ownership; and (d) remove, obscure, or alter any copyright, trademark or other proprietary rights notices, falsify or delete any author attributions, legal notices or other labels of the origin or source of material.

The Software Subjected to Other License Conditions

Please refer to Contents of Software and respective License terms below, for more detail and corresponding license conditions.

Contents of Software

Names of Software	page
1.Adobe PostScript 3.....	5
2.Apache Commons Logging.....	12
3.Apache Commons Net.....	17
4.Apache log4j.....	22
5.AWS IoT Device SDK.....	26
6.AWS SDK for Java.....	31
7.Crypto API.....	36
8.expat.....	37
9.fontconfig.....	39
10.freetype2.....	40
11.HarfBuzz.....	45
12.HttpClient2.0 Alpha1 Release.....	46
13.iw.....	48
14.Jackson JSON Processor.....	49
15.JAVA SE.....	54
16.JSEncrypt.....	55
17.libcurl.....	58
18.libjingle.....	71
19.libpcap.....	72
20.libpng.....	73
21.memcached.....	76
22.Net-SNMP.....	77
23.OpenSSL.....	85
24.OSGi Release 5.....	96
25.Paho MQTT Client.....	102
26.pango (part of OpenTypeCode).....	103
27.pixman.....	104
28.Protocol Buffers.....	106
29.servlet.jar.....	107
30.Wi-Fi Test Suite.....	111
31.wpa_supplicant-2.6.....	112

32.X Window System.....	114
33.XKCP.....	205
34.xkeyboard-config	206
35.compat-wireless	212
36.Device Driver for REALTEK RTL8153	212
37.fusermount.....	212
38.Linux	212
39.WLAN USB Driver.....	212
40.atk	220
41.cairo	220
42.glib.....	220
43.glibc	220
44.GTK+	220
45.json-glib.....	220
46.libfuse	220
47.Libnl	220
48.libusb	220
49.pango (except OpenTypeCode)	220
50.iproute.....	229
51.Squid	239

The software after No. 35 and downwards in the Contents of Software described above, please see the followings.

- (1) Please access <<https://global.canon/en/oss/scd/index.html>> to fill the request form so that you receive an e-mail with the URL to download the source code; or
- (2) Please send us a letter in writing with the following information, so that you receive the source code via postal mail.

In case you have chosen this (2), WE MAY CHARGE YOU no more than the cost of performing this distribution.

- (i) Your Address (Country/Region, ZIP code, Address, Your name) [mandatory]
- (ii) Your e-mail address (for the purpose of possible communication with us) [optional]
- (iii) Name of the model that you purchased [mandatory].
- (iv) Platform Version. Please see the <Check Device Configuration> display on the control panel. [mandatory]
- (v) Product ID number labeled on the back of the main unit. [mandatory]

– Addressee:

Open Source Promotion Division, Canon Inc.
30-2, Shimomaruko 3-chome, Ohta-ku,
Tokyo 146-8501, Japan

– Please see Privacy Notice at Canon Global <<https://global.canon/>>.

1.Adobe PostScript 3

Copyright 2007–2008 Adobe Systems Incorporated and its licensors. All rights reserved.

Portions include software under the following terms:

This product contains either BSAFE and/or TIPEM software by RSA Security Inc.

Portions of Pool.c_Copyright 1987 – NeXT, Inc., and portions of Graphics.c_Copyright 1988 NeXT, Inc. as an unpublished work. All Rights Reserved.

The Apache Software License, Version 1.1

This product includes software developed by the Apache Software Foundation (<http://www.apache.org/>).

Portions Copyright (c) 1998–2000 The Apache Software Foundation. All rights reserved.

Redistribution and use in source and binary forms, with or without modification, are permitted provided that the following conditions are met:

1. Redistributions of source code must retain the above copyright notice, this list of conditions and the following disclaimer.
2. Redistributions in binary form must reproduce the above copyright notice, this list of conditions and the following disclaimer in the documentation and/or other materials provided with the distribution.
3. The end–user documentation included with the redistribution, if any, must include the following acknowledgment:

"This product includes software developed by the Apache Software Foundation (<http://www.apache.org/>)."

Alternately, this acknowledgment may appear in the software itself, if and wherever such third–party acknowledgments normally appear.

4. The names "Xerces" and "Apache Software Foundation" must not be used to endorse or promote products derived from this software without prior written permission. For written permission, please contact apache@apache.org.
5. Products derived from this software may not be called "Apache", nor may "Apache" appear in their name, without prior written permission of the Apache Software Foundation.

THIS SOFTWARE IS PROVIDED ``AS IS" AND ANY EXPRESSED OR IMPLIED WARRANTIES, INCLUDING,

BUT NOT LIMITED TO, THE IMPLIED WARRANTIES OF MERCHANTABILITY AND FITNESS FOR A PARTICULAR PURPOSE ARE DISCLAIMED. IN NO EVENT SHALL THE APACHE SOFTWARE FOUNDATION OR ITS CONTRIBUTORS BE LIABLE FOR ANY DIRECT, INDIRECT, INCIDENTAL, SPECIAL, EXEMPLARY, OR CONSEQUENTIAL DAMAGES (INCLUDING, BUT NOT LIMITED TO, PROCUREMENT OF SUBSTITUTE GOODS OR SERVICES; LOSS OF USE, DATA, OR PROFITS; OR BUSINESS INTERRUPTION) HOWEVER CAUSED AND ON ANY THEORY OF LIABILITY, WHETHER IN CONTRACT, STRICT LIABILITY, OR TORT (INCLUDING NEGLIGENCE OR OTHERWISE) ARISING IN ANY WAY OUT OF THE USE OF THIS SOFTWARE, EVEN IF ADVISED OF THE POSSIBILITY OF SUCH DAMAGE.

This software consists of voluntary contributions made by many individuals on behalf of the Apache Software Foundation and was originally based on software copyright (c) 1999, International Business Machines, Inc., <http://www.ibm.com>. For more information on the Apache Software Foundation, please see <http://www.apache.org/>.

This product includes software developed by the University of California, Berkeley and its contributors. Portions Copyright (c) 1990 The Regents of the University of California. All rights reserved.

Redistribution and use in source and binary forms, with or without modification, are permitted provided that the following conditions are met:

1. Redistributions of source code must retain the above copyright notice, this list of conditions and the following disclaimer.
2. Redistributions in binary form must reproduce the above copyright notice, this list of conditions and the following disclaimer in the documentation and/or other materials provided with the distribution.
3. All advertising materials mentioning features or use of this software must display the following acknowledgement:

This product includes software developed by the University of California, Berkeley and its contributors.

4. Neither the name of the University nor the names of its contributors may be used to endorse or promote products derived from this software without specific prior written permission.

THIS SOFTWARE IS PROVIDED BY THE REGENTS AND CONTRIBUTORS "AS IS" AND ANY EXPRESS OR IMPLIED WARRANTIES, INCLUDING, BUT NOT LIMITED TO, THE IMPLIED WARRANTIES OF MERCHANTABILITY AND FITNESS FOR A PARTICULAR PURPOSE ARE DISCLAIMED. IN NO EVENT SHALL THE REGENTS OR CONTRIBUTORS BE LIABLE FOR ANY DIRECT, INDIRECT, INCIDENTAL, SPECIAL, EXEMPLARY, OR CONSEQUENTIAL DAMAGES (INCLUDING, BUT NOT LIMITED TO, PROCUREMENT OF SUBSTITUTE GOODS OR SERVICES; LOSS OF USE, DATA, OR PROFITS; OR BUSINESS INTERRUPTION) HOWEVER CAUSED AND ON ANY THEORY OF LIABILITY, WHETHER IN CONTRACT, STRICT LIABILITY, OR TORT (INCLUDING NEGLIGENCE OR OTHERWISE) ARISING IN ANY WAY OUT OF THE USE OF THIS

SOFTWARE, EVEN IF ADVISED OF THE POSSIBILITY OF SUCH DAMAGE.

Portions Copyright (c) 1985, 1986 The Regents of the University of California. All rights reserved.

This code is derived from software contributed to Berkeley by James A. Woods, derived from original work by Spencer Thomas and Joseph Orost.

Redistribution and use in source and binary forms are permitted provided that the above copyright notice and this paragraph are duplicated in all such forms and that any documentation, advertising materials, and other materials related to such distribution and use acknowledge that the software was developed by the University of California, Berkeley. The name of the University may not be used to endorse or promote products derived from this software without specific prior written permission.

THIS SOFTWARE IS PROVIDED ``AS IS" AND WITHOUT ANY EXPRESS OR IMPLIED WARRANTIES, INCLUDING, WITHOUT LIMITATION, THE IMPLIED WARRANTIES OF MERCHANTABILITY AND FITNESS FOR A PARTICULAR PURPOSE.

Portions Copyright (c) 1993 X Consortium

Permission is hereby granted, free of charge, to any person obtaining a copy of this software and associated documentation files (the "Software"), to deal in the Software without restriction, including without limitation the rights to use, copy, modify, merge, publish, distribute, sublicense, and/or sell copies of the Software, and to permit persons to whom the Software is furnished to do so, subject to the following conditions:

The above copyright notice and this permission notice shall be included in all copies or substantial portions of the Software.

THE SOFTWARE IS PROVIDED "AS IS", WITHOUT WARRANTY OF ANY KIND, EXPRESS OR IMPLIED, INCLUDING BUT NOT LIMITED TO THE WARRANTIES OF MERCHANTABILITY, FITNESS FOR A PARTICULAR PURPOSE AND NONINFRINGEMENT. IN NO EVENT SHALL THE X CONSORTIUM BE LIABLE FOR ANY CLAIM, DAMAGES OR OTHER LIABILITY, WHETHER IN AN ACTION OF CONTRACT, TORT OR OTHERWISE, ARISING FROM, OUT OF OR IN CONNECTION WITH THE SOFTWARE OR THE USE OR OTHER DEALINGS IN THE SOFTWARE.

Except as contained in this notice, the name of the X Consortium shall not be used in advertising or otherwise to promote the sale, use or other dealings in this Software without prior written authorization from the X Consortium.

NOTICE REGARDING SABLOTRON

March 27, 2003

Portions of this product are based on Modifications created from the Original Code known as the "Sablotron XSLT Processor". The Sablotron XSLT Processor is subject to the Mozilla Public License Version 1.1 (the "License"). You may obtain a copy of the License at <http://www.mozilla.org/MPL/>

Software distributed under the License is distributed on an "AS IS" basis, WITHOUT WARRANTY OF ANY KIND, either express or implied. See the License for the specific language governing rights and limitations under the License.

The Original Code is the Sablotron XSLT Processor.

The Initial Developer of the Original Code is Ginger Alliance Ltd. Portions created by Ginger Alliance are Copyright (C) 2000 Ginger Alliance Ltd. All Rights Reserved.

Pursuant to sections 3.2 and 3.6 of the License, the Modifications created by Adobe Systems Incorporated are available as Source Code. The Modifications may be downloaded via the Internet from:

<http://partners.adobe.com/asn/tech/xml/sablotron/index.jsp>

The Original Code may be downloaded via the Internet from:

<https://sourceforge.net/projects/sablotron/>

This product includes software developed by the University of California, Berkeley and its contributors. Portions Copyright (c) 1982, 1986, 1987, 1988, 1989, 1990, 1991, 1992, 1993, 1994 The Regents of the University of California. All rights reserved.

Redistribution and use in source and binary forms, with or without modification, are permitted provided that the following conditions are met:

1. Redistributions of source code must retain the above copyright notice, this list of conditions and the following disclaimer.
2. Redistributions in binary form must reproduce the above copyright notice, this list of conditions

and the following disclaimer in the documentation and/or other materials provided with the distribution.

3. All advertising materials mentioning features or use of this software must display the following acknowledgement: This product includes software developed by the University of California, Berkeley and its contributors.

4. Neither the name of the University nor the names of its contributors may be used to endorse or promote products derived from this software without specific prior written permission.

THIS SOFTWARE IS PROVIDED BY THE REGENTS AND CONTRIBUTORS "AS IS" AND ANY EXPRESS OR IMPLIED WARRANTIES, INCLUDING, BUT NOT LIMITED TO, THE IMPLIED WARRANTIES OF MERCHANTABILITY AND FITNESS FOR A PARTICULAR PURPOSE ARE DISCLAIMED. IN NO EVENT SHALL THE REGENTS OR CONTRIBUTORS BE LIABLE FOR ANY DIRECT, INDIRECT, INCIDENTAL, SPECIAL, EXEMPLARY, OR CONSEQUENTIAL DAMAGES (INCLUDING, BUT NOT LIMITED TO, PROCUREMENT OF SUBSTITUTE GOODS OR SERVICES; LOSS OF USE, DATA, OR PROFITS; OR BUSINESS INTERRUPTION) HOWEVER CAUSED AND ON ANY THEORY OF LIABILITY, WHETHER IN CONTRACT, STRICT LIABILITY, OR TORT (INCLUDING NEGLIGENCE OR OTHERWISE) ARISING IN ANY WAY OUT OF THE USE OF THIS SOFTWARE, EVEN IF ADVISED OF THE POSSIBILITY OF SUCH DAMAGE.

Portions Copyright (c) 2001 by Andrei Alexandrescu. This code accompanies the book: Alexandrescu, Andrei. "Modern C++ Design: Generic Programming and Design Patterns Applied". Copyright (c) 2001. Addison-Wesley.

Permission to use, copy, modify, distribute and sell this software for any purpose is hereby granted without fee, provided that the above copyright notice appear in all copies and that both that copyright notice and this permission notice appear in supporting documentation. The author or Addison-Wesley Longman make no representations about the suitability of this software for any purpose. It is provided "as is" without express or implied warranty.

Portions developed by the University of California, Berkeley.

Portions Copyright © 1991–2005 Unicode, Inc. All rights reserved. Distributed under the Terms of Use in <http://www.unicode.org/copyright.html>.

Permission is hereby granted, free of charge, to any person obtaining a copy of the Unicode data files and associated documentation (the "Data Files") or Unicode software and associated documentation (the "Software") to deal in the Data Files or Software without restriction, including without limitation the rights to use, copy, modify, merge, publish, distribute, and/or sell copies of the Data Files or Software, and to permit persons to whom the Data Files or Software are furnished to do so, provided that (a) the above copyright notice(s) and this permission notice appear in all copies of the Data Files

or Software, (b) both the above copyright notice(s) and this permission notice appear in associated documentation, and (c) there is clear notice in each modified Data File or in the Software as well as in the documentation associated with the Data File(s) or Software that the data or software has been modified.

THE DATA FILES AND SOFTWARE ARE PROVIDED "AS IS", WITHOUT WARRANTY OF ANY KIND, EXPRESS OR IMPLIED, INCLUDING BUT NOT LIMITED TO THE WARRANTIES OF MERCHANTABILITY, FITNESS FOR A PARTICULAR PURPOSE AND NONINFRINGEMENT OF THIRD PARTY RIGHTS. IN NO EVENT SHALL THE COPYRIGHT HOLDER OR HOLDERS INCLUDED IN THIS NOTICE BE LIABLE FOR ANY CLAIM, OR ANY SPECIAL INDIRECT OR CONSEQUENTIAL DAMAGES, OR ANY DAMAGES WHATSOEVER RESULTING FROM LOSS OF USE, DATA OR PROFITS, WHETHER IN AN ACTION OF CONTRACT, NEGLIGENCE OR OTHER TORTIOUS ACTION, ARISING OUT OF OR IN CONNECTION WITH THE USE OR PERFORMANCE OF THE DATA FILES OR SOFTWARE.

Except as contained in this notice, the name of a copyright holder shall not be used in advertising or otherwise to promote the sale, use or other dealings in these Data Files or Software without prior written authorization of the copyright holder.

Unicode and the Unicode logo are trademarks of Unicode, Inc., and may be registered in some jurisdictions. All other trademarks and registered trademarks mentioned herein are the property of their respective owners.

Adobe shall retain and reproduce, and require its Sublicensees to retain and reproduce JIM's following copyright notice within each copy of the licensed programs in any form, in whole or in part: "© 1981, 1990 JMI Consultants, Inc. All rights reserved."

This product includes software developed by the University of California, Berkeley and its contributors. Portions Copyright (c) 1990, 1993 The Regents of the University of California. All rights reserved.

This code is derived from software contributed to Berkeley by Chris Torek.

Redistribution and use in source and binary forms, with or without modification, are permitted provided that the following conditions are met:

1. Redistributions of source code must retain the above copyright notice, this list of conditions and the following disclaimer.
2. Redistributions in binary form must reproduce the above copyright notice, this list of conditions and the following disclaimer in the documentation and/or other materials provided with the distribution.

3. All advertising materials mentioning features or use of this software must display the following acknowledgement:

This product includes software developed by the University of California, Berkeley and its contributors.

4. Neither the name of the University nor the names of its contributors may be used to endorse or promote products derived from this software without specific prior written permission.

THIS SOFTWARE IS PROVIDED BY THE REGENTS AND CONTRIBUTORS "AS IS" AND ANY EXPRESS OR IMPLIED WARRANTIES, INCLUDING, BUT NOT LIMITED TO, THE IMPLIED WARRANTIES OF MERCHANTABILITY AND FITNESS FOR A PARTICULAR PURPOSE ARE DISCLAIMED. IN NO EVENT SHALL THE REGENTS OR CONTRIBUTORS BE LIABLE FOR ANY DIRECT, INDIRECT, INCIDENTAL, SPECIAL, EXEMPLARY, OR CONSEQUENTIAL DAMAGES (INCLUDING, BUT NOT LIMITED TO, PROCUREMENT OF SUBSTITUTE GOODS OR SERVICES; LOSS OF USE, DATA, OR PROFITS; OR BUSINESS INTERRUPTION) HOWEVER CAUSED AND ON ANY THEORY OF LIABILITY, WHETHER IN CONTRACT, STRICT LIABILITY, OR TORT (INCLUDING NEGLIGENCE OR OTHERWISE) ARISING IN ANY WAY OUT OF THE USE OF THIS SOFTWARE, EVEN IF ADVISED OF THE POSSIBILITY OF SUCH DAMAGE.

The Loki Library

Portions Copyright (c) 2001 by Andrei Alexandrescu // This code accompanies the book: Alexandrescu, Andrei. "Modern C++ Design: Generic Programming and Design Patterns Applied". Copyright (c) 2001. Addison-Wesley.

Permission to use, copy, modify, distribute and sell this software for any purpose is hereby granted without fee, provided that the above copyright notice appear in all copies and that both that copyright notice and this permission notice appear in supporting documentation. The author or Addison-Wesley Longman make no representations about the suitability of this software for any purpose. It is provided "as is" without express or implied warranty.

Updated Information/Additional Third Party Code Information available at <http://www.adobe.com/go/thirdparty> .

2. Apache Commons Logging

Apache License

Version 2.0, January 2004

TERMS AND CONDITIONS FOR USE, REPRODUCTION, AND DISTRIBUTION

1. Definitions.

"License" shall mean the terms and conditions for use, reproduction, and distribution as defined by Sections 1 through 9 of this document.

"Licensor" shall mean the copyright owner or entity authorized by the copyright owner that is granting the License.

"Legal Entity" shall mean the union of the acting entity and all other entities that control, are controlled by, or are under common control with that entity. For the purposes of this definition, "control" means (i) the power, direct or indirect, to cause the direction or management of such entity, whether by contract or otherwise, or (ii) ownership of fifty percent (50%) or more of the outstanding shares, or (iii) beneficial ownership of such entity.

"You" (or "Your") shall mean an individual or Legal Entity exercising permissions granted by this License.

"Source" form shall mean the preferred form for making modifications, including but not limited to software source code, documentation source, and configuration files.

"Object" form shall mean any form resulting from mechanical transformation or translation of a Source form, including but not limited to compiled object code, generated documentation, and conversions to other media types.

"Work" shall mean the work of authorship, whether in Source or Object form, made available under the License, as indicated by a copyright notice that is included in or attached to the work (an example is provided in the Appendix below).

"Derivative Works" shall mean any work, whether in Source or Object form, that is based on (or derived from) the Work and for which the editorial revisions, annotations, elaborations, or other modifications

represent, as a whole, an original work of authorship. For the purposes of this License, Derivative Works shall not include works that remain separable from, or merely link (or bind by name) to the interfaces of, the Work and Derivative Works thereof.

"Contribution" shall mean any work of authorship, including the original version of the Work and any modifications or additions to that Work or Derivative Works thereof, that is intentionally submitted to Licensor for inclusion in the Work by the copyright owner or by an individual or Legal Entity authorized to submit on behalf of the copyright owner. For the purposes of this definition, "submitted" means any form of electronic, verbal, or written communication sent to the Licensor or its representatives, including but not limited to communication on electronic mailing lists, source code control systems, and issue tracking systems that are managed by, or on behalf of, the Licensor for the purpose of discussing and improving the Work, but excluding communication that is conspicuously marked or otherwise designated in writing by the copyright owner as "Not a Contribution."

"Contributor" shall mean Licensor and any individual or Legal Entity on behalf of whom a Contribution has been received by Licensor and subsequently incorporated within the Work.

2. Grant of Copyright License. Subject to the terms and conditions of this License, each Contributor hereby grants to You a perpetual, worldwide, non-exclusive, no-charge, royalty-free, irrevocable copyright license to reproduce, prepare Derivative Works of, publicly display, publicly perform, sublicense, and distribute the Work and such Derivative Works in Source or Object form.

3. Grant of Patent License. Subject to the terms and conditions of this License, each Contributor hereby grants to You a perpetual, worldwide, non-exclusive, no-charge, royalty-free, irrevocable (except as stated in this section) patent license to make, have made, use, offer to sell, sell, import, and otherwise transfer the Work, where such license applies only to those patent claims licensable by such Contributor that are necessarily infringed by their Contribution(s) alone or by combination of their Contribution(s) with the Work to which such Contribution(s) was submitted. If You institute patent litigation against any entity (including a cross-claim or counterclaim in a lawsuit) alleging that the Work or a Contribution incorporated within the Work constitutes direct or contributory patent infringement, then any patent licenses granted to You under this License for that Work shall terminate as of the date such litigation is filed.

4. Redistribution. You may reproduce and distribute copies of the Work or Derivative Works thereof in any medium, with or without modifications, and in Source or Object form, provided that You meet the following conditions:

1. You must give any other recipients of the Work or Derivative Works a copy of this License; and
2. You must cause any modified files to carry prominent notices stating that You changed the files; and
3. You must retain, in the Source form of any Derivative Works that You distribute, all copyright, patent, trademark, and attribution notices from the Source form of the Work, excluding those notices that do not pertain to any part of the Derivative Works; and
4. If the Work includes a "NOTICE" text file as part of its distribution, then any Derivative Works that You distribute must include a readable copy of the attribution notices contained within such NOTICE file, excluding those notices that do not pertain to any part of the Derivative Works, in at least one of the following places: within a NOTICE text file distributed as part of the Derivative Works; within the Source form or documentation, if provided along with the Derivative Works; or, within a display generated by the Derivative Works, if and wherever such third-party notices normally appear. The contents of the NOTICE file are for informational purposes only and do not modify the License. You may add Your own attribution notices within Derivative Works that You distribute, alongside or as an addendum to the NOTICE text from the Work, provided that such additional attribution notices cannot be construed as modifying the License.

You may add Your own copyright statement to Your modifications and may provide additional or different license terms and conditions for use, reproduction, or distribution of Your modifications, or for any such Derivative Works as a whole, provided Your use, reproduction, and distribution of the Work otherwise complies with the conditions stated in this License.

5. Submission of Contributions. Unless You explicitly state otherwise, any Contribution intentionally submitted for inclusion in the Work by You to the Licensor shall be under the terms and conditions of this License, without any additional terms or conditions. Notwithstanding the above, nothing herein shall supersede or modify the terms of any separate license agreement you may have executed with Licensor regarding such Contributions.

6. Trademarks. This License does not grant permission to use the trade names, trademarks, service marks, or product names of the Licensor, except as required for reasonable and customary use in describing the origin of the Work and reproducing the content of the NOTICE file.

7. Disclaimer of Warranty. Unless required by applicable law or agreed to in writing, Licensor provides the Work (and each Contributor provides its Contributions) on an "AS IS" BASIS, WITHOUT WARRANTIES OR CONDITIONS OF ANY KIND, either express or implied, including, without limitation, any warranties or conditions of TITLE, NON-INFRINGEMENT, MERCHANTABILITY, or FITNESS FOR A PARTICULAR PURPOSE. You are solely responsible for determining the appropriateness of using or redistributing

the Work and assume any risks associated with Your exercise of permissions under this License.

8. Limitation of Liability. In no event and under no legal theory, whether in tort (including negligence), contract, or otherwise, unless required by applicable law (such as deliberate and grossly negligent acts) or agreed to in writing, shall any Contributor be liable to You for damages, including any direct, indirect, special, incidental, or consequential damages of any character arising as a result of this License or out of the use or inability to use the Work (including but not limited to damages for loss of goodwill, work stoppage, computer failure or malfunction, or any and all other commercial damages or losses), even if such Contributor has been advised of the possibility of such damages.

9. Accepting Warranty or Additional Liability. While redistributing the Work or Derivative Works thereof, You may choose to offer, and charge a fee for, acceptance of support, warranty, indemnity, or other liability obligations and/or rights consistent with this License. However, in accepting such obligations, You may act only on Your own behalf and on Your sole responsibility, not on behalf of any other Contributor, and only if You agree to indemnify, defend, and hold each Contributor harmless for any liability incurred by, or claims asserted against, such Contributor by reason of your accepting any such warranty or additional liability.

END OF TERMS AND CONDITIONS

Note: Other license terms may apply to certain, identified software files contained within or distributed with the accompanying software if such terms are included in the directory containing the accompanying software. Such other license terms will then apply in lieu of the terms of the software license above.

JSON processing code subject to the JSON License from JSON.org:

Permission is hereby granted, free of charge, to any person obtaining a copy of this software and associated documentation files (the "Software"), to deal in the Software without restriction, including without limitation the rights to use, copy, modify, merge, publish, distribute, sublicense, and/or sell copies of the Software, and to permit persons to whom the Software is furnished to do so, subject to the following conditions:

The above copyright notice and this permission notice shall be included in all copies or substantial portions of the Software.

The Software shall be used for Good, not Evil.

THE SOFTWARE IS PROVIDED "AS IS", WITHOUT WARRANTY OF ANY KIND, EXPRESS OR IMPLIED, INCLUDING BUT NOT LIMITED TO THE WARRANTIES OF MERCHANTABILITY, FITNESS FOR A PARTICULAR PURPOSE AND NONINFRINGEMENT. IN NO EVENT SHALL THE AUTHORS OR COPYRIGHT HOLDERS BE LIABLE FOR ANY CLAIM, DAMAGES OR OTHER LIABILITY, WHETHER IN AN ACTION OF CONTRACT, TORT OR OTHERWISE, ARISING FROM, OUT OF OR IN CONNECTION WITH THE SOFTWARE OR THE USE OR OTHER DEALINGS IN THE SOFTWARE.

■ "NOTICE" :

Apache Commons Logging

Copyright 2003–2014 The Apache Software Foundation

This product includes software developed at

The Apache Software Foundation (<http://www.apache.org/>).

3. Apache Commons Net

Apache License

Version 2.0, January 2004

TERMS AND CONDITIONS FOR USE, REPRODUCTION, AND DISTRIBUTION

1. Definitions.

"License" shall mean the terms and conditions for use, reproduction, and distribution as defined by Sections 1 through 9 of this document.

"Licensor" shall mean the copyright owner or entity authorized by the copyright owner that is granting the License.

"Legal Entity" shall mean the union of the acting entity and all other entities that control, are controlled by, or are under common control with that entity. For the purposes of this definition, "control" means (i) the power, direct or indirect, to cause the direction or management of such entity, whether by contract or otherwise, or (ii) ownership of fifty percent (50%) or more of the outstanding shares, or (iii) beneficial ownership of such entity.

"You" (or "Your") shall mean an individual or Legal Entity exercising permissions granted by this License.

"Source" form shall mean the preferred form for making modifications, including but not limited to software source code, documentation source, and configuration files.

"Object" form shall mean any form resulting from mechanical transformation or translation of a Source form, including but not limited to compiled object code, generated documentation, and conversions to other media types.

"Work" shall mean the work of authorship, whether in Source or Object form, made available under the License, as indicated by a copyright notice that is included in or attached to the work (an example is provided in the Appendix below).

"Derivative Works" shall mean any work, whether in Source or Object form, that is based on (or derived from) the Work and for which the editorial revisions, annotations, elaborations, or other modifications

represent, as a whole, an original work of authorship. For the purposes of this License, Derivative Works shall not include works that remain separable from, or merely link (or bind by name) to the interfaces of, the Work and Derivative Works thereof.

"Contribution" shall mean any work of authorship, including the original version of the Work and any modifications or additions to that Work or Derivative Works thereof, that is intentionally submitted to Licensor for inclusion in the Work by the copyright owner or by an individual or Legal Entity authorized to submit on behalf of the copyright owner. For the purposes of this definition, "submitted" means any form of electronic, verbal, or written communication sent to the Licensor or its representatives, including but not limited to communication on electronic mailing lists, source code control systems, and issue tracking systems that are managed by, or on behalf of, the Licensor for the purpose of discussing and improving the Work, but excluding communication that is conspicuously marked or otherwise designated in writing by the copyright owner as "Not a Contribution."

"Contributor" shall mean Licensor and any individual or Legal Entity on behalf of whom a Contribution has been received by Licensor and subsequently incorporated within the Work.

2. Grant of Copyright License. Subject to the terms and conditions of this License, each Contributor hereby grants to You a perpetual, worldwide, non-exclusive, no-charge, royalty-free, irrevocable copyright license to reproduce, prepare Derivative Works of, publicly display, publicly perform, sublicense, and distribute the Work and such Derivative Works in Source or Object form.

3. Grant of Patent License. Subject to the terms and conditions of this License, each Contributor hereby grants to You a perpetual, worldwide, non-exclusive, no-charge, royalty-free, irrevocable (except as stated in this section) patent license to make, have made, use, offer to sell, sell, import, and otherwise transfer the Work, where such license applies only to those patent claims licensable by such Contributor that are necessarily infringed by their Contribution(s) alone or by combination of their Contribution(s) with the Work to which such Contribution(s) was submitted. If You institute patent litigation against any entity (including a cross-claim or counterclaim in a lawsuit) alleging that the Work or a Contribution incorporated within the Work constitutes direct or contributory patent infringement, then any patent licenses granted to You under this License for that Work shall terminate as of the date such litigation is filed.

4. Redistribution. You may reproduce and distribute copies of the Work or Derivative Works thereof in any medium, with or without modifications, and in Source or Object form, provided that You meet the following conditions:

1. You must give any other recipients of the Work or Derivative Works a copy of this License; and
2. You must cause any modified files to carry prominent notices stating that You changed the files; and
3. You must retain, in the Source form of any Derivative Works that You distribute, all copyright, patent, trademark, and attribution notices from the Source form of the Work, excluding those notices that do not pertain to any part of the Derivative Works; and
4. If the Work includes a "NOTICE" text file as part of its distribution, then any Derivative Works that You distribute must include a readable copy of the attribution notices contained within such NOTICE file, excluding those notices that do not pertain to any part of the Derivative Works, in at least one of the following places: within a NOTICE text file distributed as part of the Derivative Works; within the Source form or documentation, if provided along with the Derivative Works; or, within a display generated by the Derivative Works, if and wherever such third-party notices normally appear. The contents of the NOTICE file are for informational purposes only and do not modify the License. You may add Your own attribution notices within Derivative Works that You distribute, alongside or as an addendum to the NOTICE text from the Work, provided that such additional attribution notices cannot be construed as modifying the License.

You may add Your own copyright statement to Your modifications and may provide additional or different license terms and conditions for use, reproduction, or distribution of Your modifications, or for any such Derivative Works as a whole, provided Your use, reproduction, and distribution of the Work otherwise complies with the conditions stated in this License.

5. Submission of Contributions. Unless You explicitly state otherwise, any Contribution intentionally submitted for inclusion in the Work by You to the Licensor shall be under the terms and conditions of this License, without any additional terms or conditions. Notwithstanding the above, nothing herein shall supersede or modify the terms of any separate license agreement you may have executed with Licensor regarding such Contributions.

6. Trademarks. This License does not grant permission to use the trade names, trademarks, service marks, or product names of the Licensor, except as required for reasonable and customary use in describing the origin of the Work and reproducing the content of the NOTICE file.

7. Disclaimer of Warranty. Unless required by applicable law or agreed to in writing, Licensor provides the Work (and each Contributor provides its Contributions) on an "AS IS" BASIS, WITHOUT WARRANTIES OR CONDITIONS OF ANY KIND, either express or implied, including, without limitation, any warranties or conditions of TITLE, NON-INFRINGEMENT, MERCHANTABILITY, or FITNESS FOR A PARTICULAR PURPOSE. You are solely responsible for determining the appropriateness of using or redistributing

the Work and assume any risks associated with Your exercise of permissions under this License.

8. Limitation of Liability. In no event and under no legal theory, whether in tort (including negligence), contract, or otherwise, unless required by applicable law (such as deliberate and grossly negligent acts) or agreed to in writing, shall any Contributor be liable to You for damages, including any direct, indirect, special, incidental, or consequential damages of any character arising as a result of this License or out of the use or inability to use the Work (including but not limited to damages for loss of goodwill, work stoppage, computer failure or malfunction, or any and all other commercial damages or losses), even if such Contributor has been advised of the possibility of such damages.

9. Accepting Warranty or Additional Liability. While redistributing the Work or Derivative Works thereof, You may choose to offer, and charge a fee for, acceptance of support, warranty, indemnity, or other liability obligations and/or rights consistent with this License. However, in accepting such obligations, You may act only on Your own behalf and on Your sole responsibility, not on behalf of any other Contributor, and only if You agree to indemnify, defend, and hold each Contributor harmless for any liability incurred by, or claims asserted against, such Contributor by reason of your accepting any such warranty or additional liability.

END OF TERMS AND CONDITIONS

Note: Other license terms may apply to certain, identified software files contained within or distributed with the accompanying software if such terms are included in the directory containing the accompanying software. Such other license terms will then apply in lieu of the terms of the software license above.

JSON processing code subject to the JSON License from JSON.org:

Permission is hereby granted, free of charge, to any person obtaining a copy of this software and associated documentation files (the "Software"), to deal in the Software without restriction, including without limitation the rights to use, copy, modify, merge, publish, distribute, sublicense, and/or sell copies of the Software, and to permit persons to whom the Software is furnished to do so, subject to the following conditions:

The above copyright notice and this permission notice shall be included in all copies or substantial portions of the Software.

The Software shall be used for Good, not Evil.

THE SOFTWARE IS PROVIDED "AS IS", WITHOUT WARRANTY OF ANY KIND, EXPRESS OR IMPLIED, INCLUDING BUT NOT LIMITED TO THE WARRANTIES OF MERCHANTABILITY, FITNESS FOR A PARTICULAR PURPOSE AND NONINFRINGEMENT. IN NO EVENT SHALL THE AUTHORS OR COPYRIGHT HOLDERS BE LIABLE FOR ANY CLAIM, DAMAGES OR OTHER LIABILITY, WHETHER IN AN ACTION OF CONTRACT, TORT OR OTHERWISE, ARISING FROM, OUT OF OR IN CONNECTION WITH THE SOFTWARE OR THE USE OR OTHER DEALINGS IN THE SOFTWARE.

■ “NOTICE” :

Apache Commons Net

Copyright 2001–2017 The Apache Software Foundation

This product includes software developed at

The Apache Software Foundation (<http://www.apache.org/>).

4.Apache log4j

Apache License

Version 2.0, January 2004

<http://www.apache.org/licenses/>

TERMS AND CONDITIONS FOR USE, REPRODUCTION, AND DISTRIBUTION

1. Definitions.

"License" shall mean the terms and conditions for use, reproduction, and distribution as defined by Sections 1 through 9 of this document.

"Licensor" shall mean the copyright owner or entity authorized by the copyright owner that is granting the License.

"Legal Entity" shall mean the union of the acting entity and all other entities that control, are controlled by, or are under common control with that entity. For the purposes of this definition, "control" means (i) the power, direct or indirect, to cause the direction or management of such entity, whether by contract or otherwise, or (ii) ownership of fifty percent (50%) or more of the outstanding shares, or (iii) beneficial ownership of such entity.

"You" (or "Your") shall mean an individual or Legal Entity exercising permissions granted by this License.

"Source" form shall mean the preferred form for making modifications, including but not limited to software source code, documentation source, and configuration files.

"Object" form shall mean any form resulting from mechanical transformation or translation of a Source form, including but not limited to compiled object code, generated documentation, and conversions to other media types.

"Work" shall mean the work of authorship, whether in Source or Object form, made available under the License, as indicated by a copyright notice that is included in or attached to the work (an example is provided in the Appendix below).

"Derivative Works" shall mean any work, whether in Source or Object form, that is based on (or derived from) the Work and for which the editorial revisions, annotations, elaborations, or other modifications represent, as a whole, an original work of authorship. For the purposes of this License, Derivative Works shall not include works that remain separable from, or merely link (or bind by name) to the interfaces of, the Work and Derivative Works thereof.

"Contribution" shall mean any work of authorship, including the original version of the Work and any modifications or additions to that Work or Derivative Works thereof, that is intentionally submitted to Licensor for inclusion in the Work by the copyright owner or by an individual or Legal Entity authorized to submit on behalf of the copyright owner. For the purposes of this definition, "submitted" means any form of electronic, verbal, or written communication sent to the Licensor or its representatives, including but not limited to communication on electronic mailing lists, source

code control systems, and issue tracking systems that are managed by, or on behalf of, the Licensor for the purpose of discussing and improving the Work, but excluding communication that is conspicuously marked or otherwise designated in writing by the copyright owner as "Not a Contribution."

"Contributor" shall mean Licensor and any individual or Legal Entity on behalf of whom a Contribution has been received by Licensor and subsequently incorporated within the Work.

2. Grant of Copyright License. Subject to the terms and conditions of this License, each Contributor hereby grants to You a perpetual, worldwide, non-exclusive, no-charge, royalty-free, irrevocable copyright license to reproduce, prepare Derivative Works of, publicly display, publicly perform, sublicense, and distribute the Work and such Derivative Works in Source or Object form.

3. Grant of Patent License. Subject to the terms and conditions of this License, each Contributor hereby grants to You a perpetual, worldwide, non-exclusive, no-charge, royalty-free, irrevocable (except as stated in this section) patent license to make, have made, use, offer to sell, sell, import, and otherwise transfer the Work, where such license applies only to those patent claims licensable by such Contributor that are necessarily infringed by their Contribution(s) alone or by combination of their Contribution(s) with the Work to which such Contribution(s) was submitted. If You institute patent litigation against any entity (including a cross-claim or counterclaim in a lawsuit) alleging that the Work or a Contribution incorporated within the Work constitutes direct or contributory patent infringement, then any patent licenses granted to You under this License for that Work shall terminate as of the date such litigation is filed.

4. Redistribution. You may reproduce and distribute copies of the Work or Derivative Works thereof in any medium, with or without modifications, and in Source or Object form, provided that You meet the following conditions:

- a. You must give any other recipients of the Work or Derivative Works a copy of this License; and
- b. You must cause any modified files to carry prominent notices stating that You changed the files; and
- c. You must retain, in the Source form of any Derivative Works that You distribute, all copyright, patent, trademark, and attribution notices from the Source form of the Work, excluding those notices that do not pertain to any part of the Derivative Works; and
- d. If the Work includes a "NOTICE" text file as part of its distribution, then any Derivative Works that You distribute must include a readable copy of the attribution notices contained within such NOTICE file, excluding those notices that do not pertain to any part of the Derivative Works, in at least one of the following places: within a NOTICE text file distributed as part of the Derivative Works; within the Source form or documentation, if provided along with the Derivative Works; or, within a display generated by the Derivative Works, if and wherever such third-party notices normally appear. The contents of the NOTICE file are for informational purposes only and do not modify the License. You may add Your own attribution notices within Derivative Works that You distribute, alongside or

as an addendum to the NOTICE text from the Work, provided that such additional attribution notices cannot be construed as modifying the License.

You may add Your own copyright statement to Your modifications and may provide additional or different license terms and conditions for use, reproduction, or distribution of Your modifications, or for any such Derivative Works as a whole, provided Your use, reproduction, and distribution of the Work otherwise complies with the conditions stated in this License.

5. Submission of Contributions. Unless You explicitly state otherwise, any Contribution intentionally submitted for inclusion in the Work by You to the Licensor shall be under the terms and conditions of this License, without any additional terms or conditions. Notwithstanding the above, nothing herein shall supersede or modify the terms of any separate license agreement you may have executed with Licensor regarding such Contributions.

6. Trademarks. This License does not grant permission to use the trade names, trademarks, service marks, or product names of the Licensor, except as required for reasonable and customary use in describing the origin of the Work and reproducing the content of the NOTICE file.

7. Disclaimer of Warranty. Unless required by applicable law or agreed to in writing, Licensor provides the Work (and each Contributor provides its Contributions) on an "AS IS" BASIS, WITHOUT WARRANTIES OR CONDITIONS OF ANY KIND, either express or implied, including, without limitation, any warranties or conditions of TITLE, NON-INFRINGEMENT, MERCHANTABILITY, or FITNESS FOR A PARTICULAR PURPOSE. You are solely responsible for determining the appropriateness of using or redistributing the Work and assume any risks associated with Your exercise of permissions under this License.

8. Limitation of Liability. In no event and under no legal theory, whether in tort (including negligence), contract, or otherwise, unless required by applicable law (such as deliberate and grossly negligent acts) or agreed to in writing, shall any Contributor be liable to You for damages, including any direct, indirect, special, incidental, or consequential damages of any character arising as a result of this License or out of the use or inability to use the Work (including but not limited to damages for loss of goodwill, work stoppage, computer failure or malfunction, or any and all other commercial damages or losses), even if such Contributor has been advised of the possibility of such damages.

9. Accepting Warranty or Additional Liability. While redistributing the Work or Derivative Works thereof, You may choose to offer, and charge a fee for, acceptance of support, warranty, indemnity, or other liability obligations and/or rights consistent with this License. However, in accepting such obligations, You may act only on Your own behalf and on Your sole responsibility, not on behalf of any other Contributor, and only if You agree to indemnify, defend, and hold each Contributor harmless for any liability incurred by, or claims asserted against, such Contributor by reason of your accepting any such warranty or additional liability.

END OF TERMS AND CONDITIONS

APPENDIX: How to apply the Apache License to your work

To apply the Apache License to your work, attach the following boilerplate notice, with the fields enclosed by brackets "[]" replaced with your own identifying information. (Don't include the brackets!)

The text should be enclosed in the appropriate comment syntax for the file format. We also recommend that a file or class name and description of purpose be included on the same "printed page" as the copyright notice for easier identification within third-party archives.

Copyright [yyyy] [name of copyright owner] Licensed under the Apache License, Version 2.0 (the "License"); you may not use this file except in compliance with the License. You may obtain a copy of the License at <http://www.apache.org/licenses/LICENSE-2.0> Unless required by applicable law or agreed to in writing, software distributed under the License is distributed on an "AS IS" BASIS, WITHOUT WARRANTIES OR CONDITIONS OF ANY KIND, either express or implied. See the License for the specific language governing permissions and limitations under the License.

5.AWS IoT Device SDK

Apache License

Version 2.0, January 2004

TERMS AND CONDITIONS FOR USE, REPRODUCTION, AND DISTRIBUTION

1. Definitions.

"License" shall mean the terms and conditions for use, reproduction, and distribution as defined by Sections 1 through 9 of this document.

"Licensor" shall mean the copyright owner or entity authorized by the copyright owner that is granting the License.

"Legal Entity" shall mean the union of the acting entity and all other entities that control, are controlled by, or are under common control with that entity. For the purposes of this definition, "control" means (i) the power, direct or indirect, to cause the direction or management of such entity, whether by contract or otherwise, or (ii) ownership of fifty percent (50%) or more of the outstanding shares, or (iii) beneficial ownership of such entity.

"You" (or "Your") shall mean an individual or Legal Entity exercising permissions granted by this License.

"Source" form shall mean the preferred form for making modifications, including but not limited to software source code, documentation source, and configuration files.

"Object" form shall mean any form resulting from mechanical transformation or translation of a Source form, including but not limited to compiled object code, generated documentation, and conversions to other media types.

"Work" shall mean the work of authorship, whether in Source or Object form, made available under the License, as indicated by a copyright notice that is included in or attached to the work (an example is provided in the Appendix below).

"Derivative Works" shall mean any work, whether in Source or Object form, that is based on (or derived from) the Work and for which the editorial revisions, annotations, elaborations, or other modifications

represent, as a whole, an original work of authorship. For the purposes of this License, Derivative Works shall not include works that remain separable from, or merely link (or bind by name) to the interfaces of, the Work and Derivative Works thereof.

"Contribution" shall mean any work of authorship, including the original version of the Work and any modifications or additions to that Work or Derivative Works thereof, that is intentionally submitted to Licensor for inclusion in the Work by the copyright owner or by an individual or Legal Entity authorized to submit on behalf of the copyright owner. For the purposes of this definition, "submitted" means any form of electronic, verbal, or written communication sent to the Licensor or its representatives, including but not limited to communication on electronic mailing lists, source code control systems, and issue tracking systems that are managed by, or on behalf of, the Licensor for the purpose of discussing and improving the Work, but excluding communication that is conspicuously marked or otherwise designated in writing by the copyright owner as "Not a Contribution."

"Contributor" shall mean Licensor and any individual or Legal Entity on behalf of whom a Contribution has been received by Licensor and subsequently incorporated within the Work.

2. Grant of Copyright License. Subject to the terms and conditions of this License, each Contributor hereby grants to You a perpetual, worldwide, non-exclusive, no-charge, royalty-free, irrevocable copyright license to reproduce, prepare Derivative Works of, publicly display, publicly perform, sublicense, and distribute the Work and such Derivative Works in Source or Object form.

3. Grant of Patent License. Subject to the terms and conditions of this License, each Contributor hereby grants to You a perpetual, worldwide, non-exclusive, no-charge, royalty-free, irrevocable (except as stated in this section) patent license to make, have made, use, offer to sell, sell, import, and otherwise transfer the Work, where such license applies only to those patent claims licensable by such Contributor that are necessarily infringed by their Contribution(s) alone or by combination of their Contribution(s) with the Work to which such Contribution(s) was submitted. If You institute patent litigation against any entity (including a cross-claim or counterclaim in a lawsuit) alleging that the Work or a Contribution incorporated within the Work constitutes direct or contributory patent infringement, then any patent licenses granted to You under this License for that Work shall terminate as of the date such litigation is filed.

4. Redistribution. You may reproduce and distribute copies of the Work or Derivative Works thereof in any medium, with or without modifications, and in Source or Object form, provided that You meet the following conditions:

1. You must give any other recipients of the Work or Derivative Works a copy of this License; and
2. You must cause any modified files to carry prominent notices stating that You changed the files; and
3. You must retain, in the Source form of any Derivative Works that You distribute, all copyright, patent, trademark, and attribution notices from the Source form of the Work, excluding those notices that do not pertain to any part of the Derivative Works; and
4. If the Work includes a "NOTICE" text file as part of its distribution, then any Derivative Works that You distribute must include a readable copy of the attribution notices contained within such NOTICE file, excluding those notices that do not pertain to any part of the Derivative Works, in at least one of the following places: within a NOTICE text file distributed as part of the Derivative Works; within the Source form or documentation, if provided along with the Derivative Works; or, within a display generated by the Derivative Works, if and wherever such third-party notices normally appear. The contents of the NOTICE file are for informational purposes only and do not modify the License. You may add Your own attribution notices within Derivative Works that You distribute, alongside or as an addendum to the NOTICE text from the Work, provided that such additional attribution notices cannot be construed as modifying the License.

You may add Your own copyright statement to Your modifications and may provide additional or different license terms and conditions for use, reproduction, or distribution of Your modifications, or for any such Derivative Works as a whole, provided Your use, reproduction, and distribution of the Work otherwise complies with the conditions stated in this License.

5. Submission of Contributions. Unless You explicitly state otherwise, any Contribution intentionally submitted for inclusion in the Work by You to the Licensor shall be under the terms and conditions of this License, without any additional terms or conditions. Notwithstanding the above, nothing herein shall supersede or modify the terms of any separate license agreement you may have executed with Licensor regarding such Contributions.

6. Trademarks. This License does not grant permission to use the trade names, trademarks, service marks, or product names of the Licensor, except as required for reasonable and customary use in describing the origin of the Work and reproducing the content of the NOTICE file.

7. Disclaimer of Warranty. Unless required by applicable law or agreed to in writing, Licensor provides the Work (and each Contributor provides its Contributions) on an "AS IS" BASIS, WITHOUT WARRANTIES OR CONDITIONS OF ANY KIND, either express or implied, including, without limitation, any warranties or conditions of TITLE, NON-INFRINGEMENT, MERCHANTABILITY, or FITNESS FOR A PARTICULAR PURPOSE. You are solely responsible for determining the appropriateness of using or redistributing

the Work and assume any risks associated with Your exercise of permissions under this License.

8. Limitation of Liability. In no event and under no legal theory, whether in tort (including negligence), contract, or otherwise, unless required by applicable law (such as deliberate and grossly negligent acts) or agreed to in writing, shall any Contributor be liable to You for damages, including any direct, indirect, special, incidental, or consequential damages of any character arising as a result of this License or out of the use or inability to use the Work (including but not limited to damages for loss of goodwill, work stoppage, computer failure or malfunction, or any and all other commercial damages or losses), even if such Contributor has been advised of the possibility of such damages.

9. Accepting Warranty or Additional Liability. While redistributing the Work or Derivative Works thereof, You may choose to offer, and charge a fee for, acceptance of support, warranty, indemnity, or other liability obligations and/or rights consistent with this License. However, in accepting such obligations, You may act only on Your own behalf and on Your sole responsibility, not on behalf of any other Contributor, and only if You agree to indemnify, defend, and hold each Contributor harmless for any liability incurred by, or claims asserted against, such Contributor by reason of your accepting any such warranty or additional liability.

END OF TERMS AND CONDITIONS

Note: Other license terms may apply to certain, identified software files contained within or distributed with the accompanying software if such terms are included in the directory containing the accompanying software. Such other license terms will then apply in lieu of the terms of the software license above.

JSON processing code subject to the JSON License from JSON.org:

Permission is hereby granted, free of charge, to any person obtaining a copy of this software and associated documentation files (the "Software"), to deal in the Software without restriction, including without limitation the rights to use, copy, modify, merge, publish, distribute, sublicense, and/or sell copies of the Software, and to permit persons to whom the Software is furnished to do so, subject to the following conditions:

The above copyright notice and this permission notice shall be included in all copies or substantial portions of the Software.

The Software shall be used for Good, not Evil.

THE SOFTWARE IS PROVIDED "AS IS", WITHOUT WARRANTY OF ANY KIND, EXPRESS OR IMPLIED, INCLUDING BUT NOT LIMITED TO THE WARRANTIES OF MERCHANTABILITY, FITNESS FOR A PARTICULAR PURPOSE AND NONINFRINGEMENT. IN NO EVENT SHALL THE AUTHORS OR COPYRIGHT HOLDERS BE LIABLE FOR ANY CLAIM, DAMAGES OR OTHER LIABILITY, WHETHER IN AN ACTION OF CONTRACT, TORT OR OTHERWISE, ARISING FROM, OUT OF OR IN CONNECTION WITH THE SOFTWARE OR THE USE OR OTHER DEALINGS IN THE SOFTWARE.

■ “NOTICE” :

AWS IoT Device SDK for Java

Copyright 2010–2016 Amazon.com, Inc. or its affiliates. All Rights Reserved.

This product includes software developed by
Amazon Technologies, Inc (<http://www.amazon.com/>).

THIRD PARTY COMPONENTS

This software includes third party software subject to the following copyrights:

- PKCS#1 and PKCS#8 PEM encoded private key parsing and utility functions from oauth.googlecode.com - Copyright 1998–2010 AOL Inc.

The licenses for these third party components are included in LICENSE.txt

6.AWS SDK for Java

Apache License

Version 2.0, January 2004

TERMS AND CONDITIONS FOR USE, REPRODUCTION, AND DISTRIBUTION

1. Definitions.

"License" shall mean the terms and conditions for use, reproduction, and distribution as defined by Sections 1 through 9 of this document.

"Licensor" shall mean the copyright owner or entity authorized by the copyright owner that is granting the License.

"Legal Entity" shall mean the union of the acting entity and all other entities that control, are controlled by, or are under common control with that entity. For the purposes of this definition, "control" means (i) the power, direct or indirect, to cause the direction or management of such entity, whether by contract or otherwise, or (ii) ownership of fifty percent (50%) or more of the outstanding shares, or (iii) beneficial ownership of such entity.

"You" (or "Your") shall mean an individual or Legal Entity exercising permissions granted by this License.

"Source" form shall mean the preferred form for making modifications, including but not limited to software source code, documentation source, and configuration files.

"Object" form shall mean any form resulting from mechanical transformation or translation of a Source form, including but not limited to compiled object code, generated documentation, and conversions to other media types.

"Work" shall mean the work of authorship, whether in Source or Object form, made available under the License, as indicated by a copyright notice that is included in or attached to the work (an example is provided in the Appendix below).

"Derivative Works" shall mean any work, whether in Source or Object form, that is based on (or derived from) the Work and for which the editorial revisions, annotations, elaborations, or other

modifications represent, as a whole, an original work of authorship. For the purposes of this License, Derivative Works shall not include works that remain separable from, or merely link (or bind by name) to the interfaces of, the Work and Derivative Works thereof.

"Contribution" shall mean any work of authorship, including the original version of the Work and any modifications or additions to that Work or Derivative Works thereof, that is intentionally submitted to Licensor for inclusion in the Work by the copyright owner or by an individual or Legal Entity authorized to submit on behalf of the copyright owner. For the purposes of this definition, "submitted" means any form of electronic, verbal, or written communication sent to the Licensor or its representatives, including but not limited to communication on electronic mailing lists, source code control systems, and issue tracking systems that are managed by, or on behalf of, the Licensor for the purpose of discussing and improving the Work, but excluding communication that is conspicuously marked or otherwise designated in writing by the copyright owner as "Not a Contribution."

"Contributor" shall mean Licensor and any individual or Legal Entity on behalf of whom a Contribution has been received by Licensor and subsequently incorporated within the Work.

2. Grant of Copyright License. Subject to the terms and conditions of this License, each Contributor hereby grants to You a perpetual, worldwide, non-exclusive, no-charge, royalty-free, irrevocable copyright license to reproduce, prepare Derivative Works of, publicly display, publicly perform, sublicense, and distribute the Work and such Derivative Works in Source or Object form.

3. Grant of Patent License. Subject to the terms and conditions of this License, each Contributor hereby grants to You a perpetual, worldwide, non-exclusive, no-charge, royalty-free, irrevocable (except as stated in this section) patent license to make, have made, use, offer to sell, sell, import, and otherwise transfer the Work, where such license applies only to those patent claims licensable by such Contributor that are necessarily infringed by their Contribution(s) alone or by combination of their Contribution(s) with the Work to which such Contribution(s) was submitted. If You institute patent litigation against any entity (including a cross-claim or counterclaim in a lawsuit) alleging that the Work or a Contribution incorporated within the Work constitutes direct or contributory patent infringement, then any patent licenses granted to You under this License for that Work shall terminate as of the date such litigation is filed.

4. Redistribution. You may reproduce and distribute copies of the Work or Derivative Works thereof in any medium, with or without modifications, and in Source or Object form, provided that You meet the following conditions:

1. You must give any other recipients of the Work or Derivative Works a copy of this License; and
2. You must cause any modified files to carry prominent notices stating that You changed the files; and
3. You must retain, in the Source form of any Derivative Works that You distribute, all copyright, patent, trademark, and attribution notices from the Source form of the Work, excluding those notices that do not pertain to any part of the Derivative Works; and
4. If the Work includes a "NOTICE" text file as part of its distribution, then any Derivative Works that You distribute must include a readable copy of the attribution notices contained within such NOTICE file, excluding those notices that do not pertain to any part of the Derivative Works, in at least one of the following places: within a NOTICE text file distributed as part of the Derivative Works; within the Source form or documentation, if provided along with the Derivative Works; or, within a display generated by the Derivative Works, if and wherever such third-party notices normally appear. The contents of the NOTICE file are for informational purposes only and do not modify the License. You may add Your own attribution notices within Derivative Works that You distribute, alongside or as an addendum to the NOTICE text from the Work, provided that such additional attribution notices cannot be construed as modifying the License.

You may add Your own copyright statement to Your modifications and may provide additional or different license terms and conditions for use, reproduction, or distribution of Your modifications, or for any such Derivative Works as a whole, provided Your use, reproduction, and distribution of the Work otherwise complies with the conditions stated in this License.

5. Submission of Contributions. Unless You explicitly state otherwise, any Contribution intentionally submitted for inclusion in the Work by You to the Licensor shall be under the terms and conditions of this License, without any additional terms or conditions. Notwithstanding the above, nothing herein shall supersede or modify the terms of any separate license agreement you may have executed with Licensor regarding such Contributions.

6. Trademarks. This License does not grant permission to use the trade names, trademarks, service marks, or product names of the Licensor, except as required for reasonable and customary use in describing the origin of the Work and reproducing the content of the NOTICE file.

7. Disclaimer of Warranty. Unless required by applicable law or agreed to in writing, Licensor provides the Work (and each Contributor provides its Contributions) on an "AS IS" BASIS, WITHOUT WARRANTIES OR CONDITIONS OF ANY KIND, either express or implied, including, without limitation, any warranties or conditions of TITLE, NON-INFRINGEMENT, MERCHANTABILITY, or FITNESS FOR A PARTICULAR PURPOSE. You are solely responsible for determining the

appropriateness of using or redistributing the Work and assume any risks associated with Your exercise of permissions under this License.

8. Limitation of Liability. In no event and under no legal theory, whether in tort (including negligence), contract, or otherwise, unless required by applicable law (such as deliberate and grossly negligent acts) or agreed to in writing, shall any Contributor be liable to You for damages, including any direct, indirect, special, incidental, or consequential damages of any character arising as a result of this License or out of the use or inability to use the Work (including but not limited to damages for loss of goodwill, work stoppage, computer failure or malfunction, or any and all other commercial damages or losses), even if such Contributor has been advised of the possibility of such damages.

9. Accepting Warranty or Additional Liability. While redistributing the Work or Derivative Works thereof, You may choose to offer, and charge a fee for, acceptance of support, warranty, indemnity, or other liability obligations and/or rights consistent with this License. However, in accepting such obligations, You may act only on Your own behalf and on Your sole responsibility, not on behalf of any other Contributor, and only if You agree to indemnify, defend, and hold each Contributor harmless for any liability incurred by, or claims asserted against, such Contributor by reason of your accepting any such warranty or additional liability.

END OF TERMS AND CONDITIONS

Note: Other license terms may apply to certain, identified software files contained within or distributed with the accompanying software if such terms are included in the directory containing the accompanying software. Such other license terms will then apply in lieu of the terms of the software license above.

JSON processing code subject to the JSON License from JSON.org:

Permission is hereby granted, free of charge, to any person obtaining a copy of this software and associated documentation files (the "Software"), to deal in the Software without restriction, including without limitation the rights to use, copy, modify, merge, publish, distribute, sublicense, and/or sell copies of the Software, and to permit persons to whom the Software is furnished to do so, subject to the following conditions:

The above copyright notice and this permission notice shall be included in all copies or substantial portions of the Software.

The Software shall be used for Good, not Evil.

THE SOFTWARE IS PROVIDED "AS IS", WITHOUT WARRANTY OF ANY KIND, EXPRESS OR IMPLIED, INCLUDING BUT NOT LIMITED TO THE WARRANTIES OF MERCHANTABILITY, FITNESS FOR A PARTICULAR PURPOSE AND NONINFRINGEMENT. IN NO EVENT SHALL THE AUTHORS OR COPYRIGHT HOLDERS BE LIABLE FOR ANY CLAIM, DAMAGES OR OTHER LIABILITY, WHETHER IN AN ACTION OF CONTRACT, TORT OR OTHERWISE, ARISING FROM, OUT OF OR IN CONNECTION WITH THE SOFTWARE OR THE USE OR OTHER DEALINGS IN THE SOFTWARE.

■ "NOTICE" :

AWS SDK for Java

Copyright 2010–2012 Amazon.com, Inc. or its affiliates. All Rights Reserved.

This product includes software developed by
Amazon Technologies, Inc (<http://www.amazon.com/>).

THIRD PARTY COMPONENTS

This software includes third party software subject to the following copyrights:

- XML parsing and utility functions from JetS3t – Copyright 2006–2009 James Murty.
- JSON parsing and utility functions from JSON.org – Copyright 2002 JSON.org.

The licenses for these third party components are included in LICENSE.txt

7.Crypto API

COPYRIGHT INFORMATION

Copyright (c) 2000 The Legion Of The Bouncy Castle (<http://www.bouncycastle.org>)

Permission is hereby granted, free of charge, to any person obtaining a copy of this software and associated documentation files (the "Software"), to deal in the Software without restriction, including without limitation the rights to use, copy, modify, merge, publish, distribute, sublicense, and/or sell copies of the Software, and to permit persons to whom the Software is furnished to do so, subject to the following conditions:

The above copyright notice and this permission notice shall be included in all copies or substantial portions of the Software.

THE SOFTWARE IS PROVIDED "AS IS", WITHOUT WARRANTY OF ANY KIND, EXPRESS OR IMPLIED, INCLUDING BUT NOT LIMITED TO THE WARRANTIES OF MERCHANTABILITY, FITNESS FOR A PARTICULAR PURPOSE AND NONINFRINGEMENT. IN NO EVENT SHALL THE AUTHORS OR COPYRIGHT HOLDERS BE LIABLE FOR ANY CLAIM, DAMAGES OR OTHER LIABILITY, WHETHER IN AN ACTION OF CONTRACT, TORT OR OTHERWISE, ARISING FROM, OUT OF OR IN CONNECTION WITH THE SOFTWARE OR THE USE OR OTHER DEALINGS IN THE SOFTWARE.

8. expat

Copyright (c) 1998, 1999, 2000 Thai Open Source Software Center Ltd
and Clark Cooper

Copyright (c) 2001, 2002, 2003, 2004, 2005, 2006 Expat maintainers.

Permission is hereby granted, free of charge, to any person obtaining a copy of this software and associated documentation files (the "Software"), to deal in the Software without restriction, including without limitation the rights to use, copy, modify, merge, publish, distribute, sublicense, and/or sell copies of the Software, and to permit persons to whom the Software is furnished to do so, subject to the following conditions:

The above copyright notice and this permission notice shall be included in all copies or substantial portions of the Software.

THE SOFTWARE IS PROVIDED "AS IS", WITHOUT WARRANTY OF ANY KIND, EXPRESS OR IMPLIED, INCLUDING BUT NOT LIMITED TO THE WARRANTIES OF MERCHANTABILITY, FITNESS FOR A PARTICULAR PURPOSE AND NONINFRINGEMENT. IN NO EVENT SHALL THE AUTHORS OR COPYRIGHT HOLDERS BE LIABLE FOR ANY CLAIM, DAMAGES OR OTHER LIABILITY, WHETHER IN AN ACTION OF CONTRACT, TORT OR OTHERWISE, ARISING FROM, OUT OF OR IN CONNECTION WITH THE SOFTWARE OR THE USE OR OTHER DEALINGS IN THE SOFTWARE.

Copyright (c) 1998, 1999, 2000 Thai Open Source Software Center Ltd

Permission is hereby granted, free of charge, to any person obtaining a copy of this software and associated documentation files (the "Software"), to deal in the Software without restriction, including without limitation the rights to use, copy, modify, merge, publish, distribute, sublicense, and/or sell copies of the Software, and to permit persons to whom the Software is furnished to do so, subject to the following conditions:

The above copyright notice and this permission notice shall be included in all copies or substantial portions of the Software.

THE SOFTWARE IS PROVIDED "AS IS", WITHOUT WARRANTY OF ANY KIND, EXPRESS OR IMPLIED, INCLUDING BUT NOT LIMITED TO THE WARRANTIES OF MERCHANTABILITY, FITNESS FOR A PARTICULAR PURPOSE AND NONINFRINGEMENT. IN NO EVENT SHALL THE AUTHORS OR COPYRIGHT HOLDERS BE LIABLE FOR ANY CLAIM, DAMAGES OR OTHER LIABILITY, WHETHER IN AN ACTION OF

CONTRACT, TORT OR OTHERWISE, ARISING FROM, OUT OF OR IN CONNECTION WITH THE SOFTWARE OR THE USE OR OTHER DEALINGS IN THE SOFTWARE.

9.fontconfig

Copyright © 2001,2003 Keith Packard

Permission to use, copy, modify, distribute, and sell this software and its documentation for any purpose is hereby granted without fee, provided that the above copyright notice appear in all copies and that both that copyright notice and this permission notice appear in supporting documentation, and that the name of Keith Packard not be used in advertising or publicity pertaining to distribution of the software without specific, written prior permission. Keith Packard makes no representations about the suitability of this software for any purpose. It is provided "as is" without express or implied warranty.

KEITH PACKARD DISCLAIMS ALL WARRANTIES WITH REGARD TO THIS SOFTWARE, INCLUDING ALL IMPLIED WARRANTIES OF MERCHANTABILITY AND FITNESS, IN NO EVENT SHALL KEITH PACKARD BE LIABLE FOR ANY SPECIAL, INDIRECT OR CONSEQUENTIAL DAMAGES OR ANY DAMAGES WHATSOEVER RESULTING FROM LOSS OF USE, DATA OR PROFITS, WHETHER IN AN ACTION OF CONTRACT, NEGLIGENCE OR OTHER TORTIOUS ACTION, ARISING OUT OF OR IN CONNECTION WITH THE USE OR PERFORMANCE OF THIS SOFTWARE.

10.freetype2

The FreeType Project LICENSE

2006-Jan-27

Copyright 1996-2002, 2006 by
David Turner, Robert Wilhelm, and Werner Lemberg

Introduction

=====

The FreeType Project is distributed in several archive packages; some of them may contain, in addition to the FreeType font engine, various tools and contributions which rely on, or relate to, the FreeType Project.

This license applies to all files found in such packages, and which do not fall under their own explicit license. The license affects thus the FreeType font engine, the test programs, documentation and makefiles, at the very least.

This license was inspired by the BSD, Artistic, and IJG (Independent JPEG Group) licenses, which all encourage inclusion and use of free software in commercial and freeware products alike. As a consequence, its main points are that:

- o We don't promise that this software works. However, we will be interested in any kind of bug reports. ('as is' distribution)
- o You can use this software for whatever you want, in parts or full form, without having to pay us. ('royalty-free' usage)
- o You may not pretend that you wrote this software. If you use

it, or only parts of it, in a program, you must acknowledge somewhere in your documentation that you have used the FreeType code. (`credits'

We specifically permit and encourage the inclusion of this software, with or without modifications, in commercial products. We disclaim all warranties covering The FreeType Project and assume no liability related to The FreeType Project.

Finally, many people asked us for a preferred form for a credit/disclaimer to use in compliance with this license. We thus encourage you to use the following text:

Portions of this software are copyright © <year> The FreeType Project (www.freetype.org). All rights reserved.

Please replace <year> with the value from the FreeType version you actually use.

Legal Terms

=====

0. Definitions

Throughout this license, the terms `package', `FreeType Project', and `FreeType archive' refer to the set of files originally distributed by the authors (David Turner, Robert Wilhelm, and Werner Lemberg) as the `FreeType Project', be they named as alpha, beta or final release.

`You' refers to the licensee, or person using the project, where `using' is a generic term including compiling the project's source code as well as linking it to form a `program' or `executable'.

This program is referred to as 'a program using the FreeType engine'.

This license applies to all files distributed in the original FreeType Project, including all source code, binaries and documentation, unless otherwise stated in the file in its original, unmodified form as distributed in the original archive. If you are unsure whether or not a particular file is covered by this license, you must contact us to verify this.

The FreeType Project is copyright (C) 1996–2000 by David Turner, Robert Wilhelm, and Werner Lemberg. All rights reserved except as specified below.

1. No Warranty

THE FREETYPE PROJECT IS PROVIDED 'AS IS' WITHOUT WARRANTY OF ANY KIND, EITHER EXPRESS OR IMPLIED, INCLUDING, BUT NOT LIMITED TO, WARRANTIES OF MERCHANTABILITY AND FITNESS FOR A PARTICULAR PURPOSE. IN NO EVENT WILL ANY OF THE AUTHORS OR COPYRIGHT HOLDERS BE LIABLE FOR ANY DAMAGES CAUSED BY THE USE OR THE INABILITY TO USE, OF THE FREETYPE PROJECT.

2. Redistribution

This license grants a worldwide, royalty-free, perpetual and irrevocable right and license to use, execute, perform, compile, display, copy, create derivative works of, distribute and sublicense the FreeType Project (in both source and object code forms) and derivative works thereof for any purpose; and to authorize others to exercise some or all of the rights granted herein, subject to the following conditions:

- o Redistribution of source code must retain this license file ('FTL.TXT') unaltered; any additions, deletions or changes to the original files must be clearly indicated in accompanying

documentation. The copyright notices of the unaltered, original files must be preserved in all copies of source files.

- o Redistribution in binary form must provide a disclaimer that states that the software is based in part of the work of the FreeType Team, in the distribution documentation. We also encourage you to put an URL to the FreeType web page in your documentation, though this isn't mandatory.

These conditions apply to any software derived from or based on the FreeType Project, not just the unmodified files. If you use our work, you must acknowledge us. However, no fee need be paid to us.

3. Advertising

Neither the FreeType authors and contributors nor you shall use the name of the other for commercial, advertising, or promotional purposes without specific prior written permission.

We suggest, but do not require, that you use one or more of the following phrases to refer to this software in your documentation or advertising materials: `FreeType Project', `FreeType Engine', `FreeType library', or `FreeType Distribution'.

As you have not signed this license, you are not required to accept it. However, as the FreeType Project is copyrighted material, only this license, or another one contracted with the authors, grants you the right to use, distribute, and modify it. Therefore, by using, distributing, or modifying the FreeType Project, you indicate that you understand and accept all the terms of this license.

4. Contacts

There are two mailing lists related to FreeType:

- o freetype@nongnu.org

Discusses general use and applications of FreeType, as well as future and wanted additions to the library and distribution. If you are looking for support, start in this list if you haven't found anything to help you in the documentation.

- o freetype-devel@nongnu.org

Discusses bugs, as well as engine internals, design issues, specific licenses, porting, etc.

Our home page can be found at

<http://www.freetype.org>

--- end of FTL.TXT ---

11.HarfBuzz

Copyright (C) 2006 Behdad Esfahbod

Copyright (C) 1998–2004 David Turner and Werner Lemberg

Copyright (C) 2008 Nokia Corporation and/or its subsidiary(-ies)

Copyright (C) 2004,2007 Red Hat, Inc.

Permission is hereby granted, without written agreement and without license or royalty fees, to use, copy, modify, and distribute this software and its documentation for any purpose, provided that the above copyright notice and the following two paragraphs appear in all copies of this software.

IN NO EVENT SHALL THE COPYRIGHT HOLDER BE LIABLE TO ANY PARTY FOR DIRECT, INDIRECT, SPECIAL, INCIDENTAL, OR CONSEQUENTIAL DAMAGES ARISING OUT OF THE USE OF THIS SOFTWARE AND ITS DOCUMENTATION, EVEN IF THE COPYRIGHT HOLDER HAS BEEN ADVISED OF THE POSSIBILITY OF SUCH DAMAGE.

THE COPYRIGHT HOLDER SPECIFICALLY DISCLAIMS ANY WARRANTIES, INCLUDING, BUT NOT LIMITED TO, THE IMPLIED WARRANTIES OF MERCHANTABILITY AND FITNESS FOR A PARTICULAR PURPOSE. THE SOFTWARE PROVIDED HEREUNDER IS ON AN "AS IS" BASIS, AND THE COPYRIGHT HOLDER HAS NO OBLIGATION TO PROVIDE MAINTENANCE, SUPPORT, UPDATES, ENHANCEMENTS, OR MODIFICATIONS.

12.HttpClient2.0 Alpha1 Release

This product includes software developed by the Apache Software Foundation (<http://www.apache.org/>) and is subject to the following terms and conditions.

Copyright (c) 2001 The Apache Software Foundation. All rights reserved.

Redistribution and use in source and binary forms, with or without modification, are permitted provided that the following conditions are met:

1. Redistributions of source code must retain the above copyright notice, this list of conditions and the following disclaimer.
2. Redistributions in binary form must reproduce the above copyright notice, this list of conditions and the following disclaimer in the documentation and/or other materials provided with the distribution.
3. The end-user documentation included with the redistribution, if any, must include the following acknowledgement:

"This product includes software developed by the Apache Software Foundation (<http://www.apache.org/>)."

Alternately, this acknowledgement may appear in the software itself, if and wherever such third-party acknowledgements normally appear.

4. The names "The Jakarta Project", "Commons", "Xerces", "Crimson", "Velocity", and "Apache Software Foundation" must not be used to endorse or promote products derived from this software without prior written permission. For written permission, please contact apache@apache.org.
5. Products derived from this software may not be called "Jakarta", "Commons", "Xerces", "Crimson", "Velocity", or "Apache", nor may "Jakarta", "Commons", "Xerces", "Crimson", "Velocity", or "Apache" appear in their names without prior written permission of the Apache Group.

NO WARRANTY

THIS SOFTWARE IS PROVIDED "AS IS" AND ANY EXPRESSED OR IMPLIED WARRANTIES, INCLUDING, BUT NOT LIMITED TO, THE IMPLIED WARRANTIES OF MERCHANTABILITY AND FITNESS FOR A PARTICULAR PURPOSE ARE DISCLAIMED. IN NO EVENT SHALL THE APACHE SOFTWARE FOUNDATION OR ITS CONTRIBUTORS BE LIABLE FOR ANY DIRECT, INDIRECT, INCIDENTAL, SPECIAL, EXEMPLARY, OR CONSEQUENTIAL DAMAGES (INCLUDING, BUT NOT LIMITED TO, PROCUREMENT OF SUBSTITUTE GOODS OR SERVICES; LOSS OF USE, DATA, OR PROFITS; OR BUSINESS INTERRUPTION) HOWEVER CAUSED AND ON ANY THEORY OF LIABILITY, WHETHER IN CONTRACT, STRICT LIABILITY, OR TORT (INCLUDING NEGLIGENCE OR OTHERWISE) ARISING IN ANY WAY OUT OF THE USE OF THIS SOFTWARE, EVEN IF ADVISED OF THE POSSIBILITY OF SUCH DAMAGE.

This software consists of voluntary contributions made by many individuals on behalf of the Apache Software Foundation. For more information on the Apache Software Foundation, please see <http://www.apache.org/>.

13.iw

Copyright (c) 2007, 2008 Johannes Berg

Copyright (c) 2007 Andy Lutomirski

Copyright (c) 2007 Mike Kershaw

Copyright (c) 2008–2009 Luis R. Rodriguez

Permission to use, copy, modify, and/or distribute this software for any purpose with or without fee is hereby granted, provided that the above copyright notice and this permission notice appear in all copies.

THE SOFTWARE IS PROVIDED "AS IS" AND THE AUTHOR DISCLAIMS ALL WARRANTIES WITH REGARD TO THIS SOFTWARE INCLUDING ALL IMPLIED WARRANTIES OF MERCHANTABILITY AND FITNESS. IN NO EVENT SHALL THE AUTHOR BE LIABLE FOR ANY SPECIAL, DIRECT, INDIRECT, OR CONSEQUENTIAL DAMAGES OR ANY DAMAGES WHATSOEVER RESULTING FROM LOSS OF USE, DATA OR PROFITS, WHETHER IN AN ACTION OF CONTRACT, NEGLIGENCE OR OTHER TORTIOUS ACTION, ARISING OUT OF OR IN CONNECTION WITH THE USE OR PERFORMANCE OF THIS SOFTWARE.

14.Jackson JSON Processor

Apache License

Version 2.0, January 2004

TERMS AND CONDITIONS FOR USE, REPRODUCTION, AND DISTRIBUTION

1. Definitions.

"License" shall mean the terms and conditions for use, reproduction, and distribution as defined by Sections 1 through 9 of this document.

"Licensor" shall mean the copyright owner or entity authorized by the copyright owner that is granting the License.

"Legal Entity" shall mean the union of the acting entity and all other entities that control, are controlled by, or are under common control with that entity. For the purposes of this definition, "control" means (i) the power, direct or indirect, to cause the direction or management of such entity, whether by contract or otherwise, or (ii) ownership of fifty percent (50%) or more of the outstanding shares, or (iii) beneficial ownership of such entity.

"You" (or "Your") shall mean an individual or Legal Entity exercising permissions granted by this License.

"Source" form shall mean the preferred form for making modifications, including but not limited to software source code, documentation source, and configuration files.

"Object" form shall mean any form resulting from mechanical transformation or translation of a Source form, including but not limited to compiled object code, generated documentation, and conversions to other media types.

"Work" shall mean the work of authorship, whether in Source or Object form, made available under the License, as indicated by a copyright notice that is included in or attached to the work (an example is provided in the Appendix below).

"Derivative Works" shall mean any work, whether in Source or Object form, that is based on (or derived from) the Work and for which the editorial revisions, annotations, elaborations, or other

modifications represent, as a whole, an original work of authorship. For the purposes of this License, Derivative Works shall not include works that remain separable from, or merely link (or bind by name) to the interfaces of, the Work and Derivative Works thereof.

"Contribution" shall mean any work of authorship, including the original version of the Work and any modifications or additions to that Work or Derivative Works thereof, that is intentionally submitted to Licensor for inclusion in the Work by the copyright owner or by an individual or Legal Entity authorized to submit on behalf of the copyright owner. For the purposes of this definition, "submitted" means any form of electronic, verbal, or written communication sent to the Licensor or its representatives, including but not limited to communication on electronic mailing lists, source code control systems, and issue tracking systems that are managed by, or on behalf of, the Licensor for the purpose of discussing and improving the Work, but excluding communication that is conspicuously marked or otherwise designated in writing by the copyright owner as "Not a Contribution."

"Contributor" shall mean Licensor and any individual or Legal Entity on behalf of whom a Contribution has been received by Licensor and subsequently incorporated within the Work.

2. Grant of Copyright License. Subject to the terms and conditions of this License, each Contributor hereby grants to You a perpetual, worldwide, non-exclusive, no-charge, royalty-free, irrevocable copyright license to reproduce, prepare Derivative Works of, publicly display, publicly perform, sublicense, and distribute the Work and such Derivative Works in Source or Object form.

3. Grant of Patent License. Subject to the terms and conditions of this License, each Contributor hereby grants to You a perpetual, worldwide, non-exclusive, no-charge, royalty-free, irrevocable (except as stated in this section) patent license to make, have made, use, offer to sell, sell, import, and otherwise transfer the Work, where such license applies only to those patent claims licensable by such Contributor that are necessarily infringed by their Contribution(s) alone or by combination of their Contribution(s) with the Work to which such Contribution(s) was submitted. If You institute patent litigation against any entity (including a cross-claim or counterclaim in a lawsuit) alleging that the Work or a Contribution incorporated within the Work constitutes direct or contributory patent infringement, then any patent licenses granted to You under this License for that Work shall terminate as of the date such litigation is filed.

4. Redistribution. You may reproduce and distribute copies of the Work or Derivative Works thereof in any medium, with or without modifications, and in Source or Object form, provided that You meet the following conditions:

1. You must give any other recipients of the Work or Derivative Works a copy of this License; and
2. You must cause any modified files to carry prominent notices stating that You changed the files; and
3. You must retain, in the Source form of any Derivative Works that You distribute, all copyright, patent, trademark, and attribution notices from the Source form of the Work, excluding those notices that do not pertain to any part of the Derivative Works; and
4. If the Work includes a "NOTICE" text file as part of its distribution, then any Derivative Works that You distribute must include a readable copy of the attribution notices contained within such NOTICE file, excluding those notices that do not pertain to any part of the Derivative Works, in at least one of the following places: within a NOTICE text file distributed as part of the Derivative Works; within the Source form or documentation, if provided along with the Derivative Works; or, within a display generated by the Derivative Works, if and wherever such third-party notices normally appear. The contents of the NOTICE file are for informational purposes only and do not modify the License. You may add Your own attribution notices within Derivative Works that You distribute, alongside or as an addendum to the NOTICE text from the Work, provided that such additional attribution notices cannot be construed as modifying the License.

You may add Your own copyright statement to Your modifications and may provide additional or different license terms and conditions for use, reproduction, or distribution of Your modifications, or for any such Derivative Works as a whole, provided Your use, reproduction, and distribution of the Work otherwise complies with the conditions stated in this License.

5. Submission of Contributions. Unless You explicitly state otherwise, any Contribution intentionally submitted for inclusion in the Work by You to the Licensor shall be under the terms and conditions of this License, without any additional terms or conditions. Notwithstanding the above, nothing herein shall supersede or modify the terms of any separate license agreement you may have executed with Licensor regarding such Contributions.

6. Trademarks. This License does not grant permission to use the trade names, trademarks, service marks, or product names of the Licensor, except as required for reasonable and customary use in describing the origin of the Work and reproducing the content of the NOTICE file.

7. Disclaimer of Warranty. Unless required by applicable law or agreed to in writing, Licensor provides the Work (and each Contributor provides its Contributions) on an "AS IS" BASIS, WITHOUT WARRANTIES OR CONDITIONS OF ANY KIND, either express or implied, including, without limitation, any warranties or conditions of TITLE, NON-INFRINGEMENT, MERCHANTABILITY, or FITNESS FOR A PARTICULAR PURPOSE. You are solely responsible for determining the

appropriateness of using or redistributing the Work and assume any risks associated with Your exercise of permissions under this License.

8. Limitation of Liability. In no event and under no legal theory, whether in tort (including negligence), contract, or otherwise, unless required by applicable law (such as deliberate and grossly negligent acts) or agreed to in writing, shall any Contributor be liable to You for damages, including any direct, indirect, special, incidental, or consequential damages of any character arising as a result of this License or out of the use or inability to use the Work (including but not limited to damages for loss of goodwill, work stoppage, computer failure or malfunction, or any and all other commercial damages or losses), even if such Contributor has been advised of the possibility of such damages.

9. Accepting Warranty or Additional Liability. While redistributing the Work or Derivative Works thereof, You may choose to offer, and charge a fee for, acceptance of support, warranty, indemnity, or other liability obligations and/or rights consistent with this License. However, in accepting such obligations, You may act only on Your own behalf and on Your sole responsibility, not on behalf of any other Contributor, and only if You agree to indemnify, defend, and hold each Contributor harmless for any liability incurred by, or claims asserted against, such Contributor by reason of your accepting any such warranty or additional liability.

END OF TERMS AND CONDITIONS

Note: Other license terms may apply to certain, identified software files contained within or distributed with the accompanying software if such terms are included in the directory containing the accompanying software. Such other license terms will then apply in lieu of the terms of the software license above.

JSON processing code subject to the JSON License from JSON.org:

Permission is hereby granted, free of charge, to any person obtaining a copy of this software and associated documentation files (the "Software"), to deal in the Software without restriction, including without limitation the rights to use, copy, modify, merge, publish, distribute, sublicense, and/or sell copies of the Software, and to permit persons to whom the Software is furnished to do so, subject to the following conditions:

The above copyright notice and this permission notice shall be included in all copies or substantial portions of the Software.

The Software shall be used for Good, not Evil.

THE SOFTWARE IS PROVIDED "AS IS", WITHOUT WARRANTY OF ANY KIND, EXPRESS OR IMPLIED, INCLUDING BUT NOT LIMITED TO THE WARRANTIES OF MERCHANTABILITY, FITNESS FOR A PARTICULAR PURPOSE AND NONINFRINGEMENT. IN NO EVENT SHALL THE AUTHORS OR COPYRIGHT HOLDERS BE LIABLE FOR ANY CLAIM, DAMAGES OR OTHER LIABILITY, WHETHER IN AN ACTION OF CONTRACT, TORT OR OTHERWISE, ARISING FROM, OUT OF OR IN CONNECTION WITH THE SOFTWARE OR THE USE OR OTHER DEALINGS IN THE SOFTWARE.

15.JAVA SE

- a. Java Technology Restrictions. You may not create, modify, or change the behavior of classes, interfaces, of subpackages that are in any way identified as “Java”, “Javax”, “Sun” or similar convention as specified by Oracle in any naming convention designation.
- b. Trademarks and Logos. You shall acknowledge that Oracle owns the Java trademark and all Java-related trademarks, logos and icons including the Coffee Cup and Duke (“Java Marks”) and agree to: (a) comply with the Java Trademark Guidelines at <http://www.oracle.com/us/legal/trademarks/index.html>; (b) not do anything harmful to or inconsistent with Oracle’s rights in the Java Marks; and (c) assist Oracle in protecting those rights, including assigning to Oracle any right acquired by You in any Java Mark.
- c. Source Code. JAVA SE may contain source code that, unless expressly licensed for other purposes, is provided solely for reference purpose pursuant to the terms applicable to JAVA SE.
- d. Third Party Code. The additional copyright notices and license terms applicable to portions of the JAVA SE are forth in the THIRDPARTYLICENSEREADME.txt file.
- e. Commercial Features. Your use of the Commercial Features for any commercial or production purpose requires a separate license from Oracle. “Commercial Features” means those features identified in Table 1–1 (Commercial Features In Java SE Product Editions) of the Program Documentation accessible at <http://www.oracle.com/technetwork/java/javase/documentation/index.html>.

16.JSEncrypt

Copyright (c) 2008–2013 Lapo Luchini <lapo@lapo.it>

Permission to use, copy, modify, and/or distribute this software for any purpose with or without fee is hereby granted, provided that the above copyright notice and this permission notice appear in all copies.

THE SOFTWARE IS PROVIDED "AS IS" AND THE AUTHOR DISCLAIMS ALL WARRANTIES WITH REGARD TO THIS SOFTWARE INCLUDING ALL IMPLIED WARRANTIES OF MERCHANTABILITY AND FITNESS. IN NO EVENT SHALL THE AUTHOR BE LIABLE FOR ANY SPECIAL, DIRECT, INDIRECT, OR CONSEQUENTIAL DAMAGES OR ANY DAMAGES WHATSOEVER RESULTING FROM LOSS OF USE, DATA OR PROFITS, WHETHER IN AN ACTION OF CONTRACT, NEGLIGENCE OR OTHER TORTIOUS ACTION, ARISING OUT OF OR IN CONNECTION WITH THE USE OR PERFORMANCE OF THIS SOFTWARE.

* Copyright (c) 2003–2005 Tom Wu

* All Rights Reserved.

*

* Permission is hereby granted, free of charge, to any person obtaining

* a copy of this software and associated documentation files (the

* "Software"), to deal in the Software without restriction, including

* without limitation the rights to use, copy, modify, merge, publish,

* distribute, sublicense, and/or sell copies of the Software, and to

* permit persons to whom the Software is furnished to do so, subject to

* the following conditions:

*

* The above copyright notice and this permission notice shall be

* included in all copies or substantial portions of the Software.

*

* THE SOFTWARE IS PROVIDED "AS-IS" AND WITHOUT WARRANTY OF ANY KIND,

* EXPRESS, IMPLIED OR OTHERWISE, INCLUDING WITHOUT LIMITATION, ANY

* WARRANTY OF MERCHANTABILITY OR FITNESS FOR A PARTICULAR PURPOSE.

*

* IN NO EVENT SHALL TOM WU BE LIABLE FOR ANY SPECIAL, INCIDENTAL,

* INDIRECT OR CONSEQUENTIAL DAMAGES OF ANY KIND, OR ANY DAMAGES WHATSOEVER

* RESULTING FROM LOSS OF USE, DATA OR PROFITS, WHETHER OR NOT ADVISED OF
* THE POSSIBILITY OF DAMAGE, AND ON ANY THEORY OF LIABILITY, ARISING OUT
* OF OR IN CONNECTION WITH THE USE OR PERFORMANCE OF THIS SOFTWARE.

*

* In addition, the following condition applies:

*

* All redistributions must retain an intact copy of this copyright notice
* and disclaimer.

CONTAINS CODE FROM YUI LIBRARY SEE LICENSE @ <http://yuilibrary.com/license/>

The 'jsrsasign'(RSA-Sign JavaScript Library) License

Copyright (c) 2010-2013 Kenji Urushima

Permission is hereby granted, free of charge, to any person obtaining a copy of this software and associated documentation files (the "Software"), to deal in the Software without restriction, including without limitation the rights to use, copy, modify, merge, publish, distribute, sublicense, and/or sell copies of the Software, and to permit persons to whom the Software is furnished to do so, subject to the following conditions:

The above copyright notice and this permission notice shall be included in all copies or substantial portions of the Software.

THE SOFTWARE IS PROVIDED "AS IS", WITHOUT WARRANTY OF ANY KIND, EXPRESS OR IMPLIED, INCLUDING BUT NOT LIMITED TO THE WARRANTIES OF MERCHANTABILITY, FITNESS FOR A PARTICULAR PURPOSE AND NONINFRINGEMENT. IN NO EVENT SHALL THE AUTHORS OR COPYRIGHT HOLDERS BE LIABLE FOR ANY CLAIM, DAMAGES OR OTHER LIABILITY, WHETHER IN AN ACTION OF CONTRACT, TORT OR OTHERWISE, ARISING FROM, OUT OF OR IN CONNECTION WITH THE SOFTWARE OR THE USE OR OTHER DEALINGS IN THE SOFTWARE.

The MIT License (MIT)

Copyright (c) 2013 AllPlayers.com

Permission is hereby granted, free of charge, to any person obtaining a copy of this software and associated documentation files (the "Software"), to deal in the Software without restriction, including without limitation the rights to use, copy, modify, merge, publish, distribute, sublicense, and/or sell copies of the Software, and to permit persons to whom the Software is furnished to do so, subject to the following conditions:

The above copyright notice and this permission notice shall be included in all copies or substantial portions of the Software.

THE SOFTWARE IS PROVIDED "AS IS", WITHOUT WARRANTY OF ANY KIND, EXPRESS OR IMPLIED, INCLUDING BUT NOT LIMITED TO THE WARRANTIES OF MERCHANTABILITY, FITNESS FOR A PARTICULAR PURPOSE AND NONINFRINGEMENT. IN NO EVENT SHALL THE AUTHORS OR COPYRIGHT HOLDERS BE LIABLE FOR ANY CLAIM, DAMAGES OR OTHER LIABILITY, WHETHER IN AN ACTION OF CONTRACT, TORT OR OTHERWISE, ARISING FROM, OUT OF OR IN CONNECTION WITH THE SOFTWARE OR THE USE OR OTHER DEALINGS IN THE SOFTWARE.

The MIT License (MIT)

Copyright(c) 2011 TJ Holowaychuk <tj@vision-media.ca>

Permission is hereby granted, free of charge, to any person obtaining a copy of this software and associated documentation files (the "Software"), to deal in the Software without restriction, including without limitation the rights to use, copy, modify, merge, publish, distribute, sublicense, and/or sell copies of the Software, and to permit persons to whom the Software is furnished to do so, subject to the following conditions:

The above copyright notice and this permission notice shall be included in all copies or substantial portions of the Software.

THE SOFTWARE IS PROVIDED "AS IS", WITHOUT WARRANTY OF ANY KIND, EXPRESS OR IMPLIED, INCLUDING BUT NOT LIMITED TO THE WARRANTIES OF MERCHANTABILITY, FITNESS FOR A PARTICULAR PURPOSE AND NONINFRINGEMENT. IN NO EVENT SHALL THE AUTHORS OR COPYRIGHT HOLDERS BE LIABLE FOR ANY CLAIM, DAMAGES OR OTHER LIABILITY, WHETHER IN AN ACTION OF CONTRACT, TORT OR OTHERWISE, ARISING FROM, OUT OF OR IN CONNECTION WITH THE SOFTWARE OR THE USE OR OTHER DEALINGS IN THE SOFTWARE.

17.libcurl

COPYRIGHT AND PERMISSION NOTICE

Copyright (c) 1996 – 2019, Daniel Stenberg, daniel@haxx.se, and many contributors, see the THANKS file.

All rights reserved.

Permission to use, copy, modify, and distribute this software for any purpose with or without fee is hereby granted, provided that the above copyright notice and this permission notice appear in all copies.

THE SOFTWARE IS PROVIDED "AS IS", WITHOUT WARRANTY OF ANY KIND, EXPRESS OR IMPLIED, INCLUDING BUT NOT LIMITED TO THE WARRANTIES OF MERCHANTABILITY, FITNESS FOR A PARTICULAR PURPOSE AND NONINFRINGEMENT OF THIRD PARTY RIGHTS. IN NO EVENT SHALL THE AUTHORS OR COPYRIGHT HOLDERS BE LIABLE FOR ANY CLAIM, DAMAGES OR OTHER LIABILITY, WHETHER IN AN ACTION OF CONTRACT, TORT OR OTHERWISE, ARISING FROM, OUT OF OR IN CONNECTION WITH THE SOFTWARE OR THE USE OR OTHER DEALINGS IN THE SOFTWARE.

Except as contained in this notice, the name of a copyright holder shall not be used in advertising or otherwise to promote the sale, use or other dealings in this Software without prior written authorization of the copyright holder.

COPYRIGHT AND PERMISSION NOTICE

Copyright (C) 2010, DirecTV, Contact: Eric Hu, ehu@directv.com.

Copyright (C) 2010 – 2018, Daniel Stenberg, daniel@haxx.se, et al.

All rights reserved.

Permission to use, copy, modify, and distribute this software for any purpose with or without fee is hereby granted, provided that the above copyright notice and this permission notice appear in all copies.

THE SOFTWARE IS PROVIDED "AS IS", WITHOUT WARRANTY OF ANY KIND, EXPRESS OR IMPLIED, INCLUDING BUT NOT LIMITED TO THE WARRANTIES OF MERCHANTABILITY, FITNESS FOR A

PARTICULAR PURPOSE AND NONINFRINGEMENT OF THIRD PARTY RIGHTS. IN NO EVENT SHALL THE AUTHORS OR COPYRIGHT HOLDERS BE LIABLE FOR ANY CLAIM, DAMAGES OR OTHER LIABILITY, WHETHER IN AN ACTION OF CONTRACT, TORT OR OTHERWISE, ARISING FROM, OUT OF OR IN CONNECTION WITH THE SOFTWARE OR THE USE OR OTHER DEALINGS IN THE SOFTWARE.

Except as contained in this notice, the name of a copyright holder shall not be used in advertising or otherwise to promote the sale, use or other dealings in this Software without prior written authorization of the copyright holder.

COPYRIGHT AND PERMISSION NOTICE

Copyright (C) 2012 - 2016, Linus Nielsen Feltzing, <linus@haxx.se>

Copyright (C) 2012 - 2017, Daniel Stenberg, <daniel@haxx.se>, et al.

All rights reserved.

Permission to use, copy, modify, and distribute this software for any purpose with or without fee is hereby granted, provided that the above copyright notice and this permission notice appear in all copies.

THE SOFTWARE IS PROVIDED "AS IS", WITHOUT WARRANTY OF ANY KIND, EXPRESS OR IMPLIED, INCLUDING BUT NOT LIMITED TO THE WARRANTIES OF MERCHANTABILITY, FITNESS FOR A PARTICULAR PURPOSE AND NONINFRINGEMENT OF THIRD PARTY RIGHTS. IN NO EVENT SHALL THE AUTHORS OR COPYRIGHT HOLDERS BE LIABLE FOR ANY CLAIM, DAMAGES OR OTHER LIABILITY, WHETHER IN AN ACTION OF CONTRACT, TORT OR OTHERWISE, ARISING FROM, OUT OF OR IN CONNECTION WITH THE SOFTWARE OR THE USE OR OTHER DEALINGS IN THE SOFTWARE.

Except as contained in this notice, the name of a copyright holder shall not be used in advertising or otherwise to promote the sale, use or other dealings in this Software without prior written authorization of the copyright holder.

COPYRIGHT AND PERMISSION NOTICE

Copyright (C) 2015 - 2017, Daniel Stenberg, <daniel@haxx.se>, et al.

Copyright (C) 2012 - 2014, Linus Nielsen Feltzing, <linus@haxx.se>

All rights reserved.

Permission to use, copy, modify, and distribute this software for any purpose with or without fee is hereby granted, provided that the above copyright notice and this permission notice appear in all copies.

THE SOFTWARE IS PROVIDED "AS IS", WITHOUT WARRANTY OF ANY KIND, EXPRESS OR IMPLIED, INCLUDING BUT NOT LIMITED TO THE WARRANTIES OF MERCHANTABILITY, FITNESS FOR A PARTICULAR PURPOSE AND NONINFRINGEMENT OF THIRD PARTY RIGHTS. IN NO EVENT SHALL THE AUTHORS OR COPYRIGHT HOLDERS BE LIABLE FOR ANY CLAIM, DAMAGES OR OTHER LIABILITY, WHETHER IN AN ACTION OF CONTRACT, TORT OR OTHERWISE, ARISING FROM, OUT OF OR IN CONNECTION WITH THE SOFTWARE OR THE USE OR OTHER DEALINGS IN THE SOFTWARE.

Except as contained in this notice, the name of a copyright holder shall not be used in advertising or otherwise to promote the sale, use or other dealings in this Software without prior written authorization of the copyright holder.

COPYRIGHT AND PERMISSION NOTICE

Copyright (C) 2014 – 2017, Steve Holme, <steve_holme@hotmail.com>.

All rights reserved.

Permission to use, copy, modify, and distribute this software for any purpose with or without fee is hereby granted, provided that the above copyright notice and this permission notice appear in all copies.

THE SOFTWARE IS PROVIDED "AS IS", WITHOUT WARRANTY OF ANY KIND, EXPRESS OR IMPLIED, INCLUDING BUT NOT LIMITED TO THE WARRANTIES OF MERCHANTABILITY, FITNESS FOR A PARTICULAR PURPOSE AND NONINFRINGEMENT OF THIRD PARTY RIGHTS. IN NO EVENT SHALL THE AUTHORS OR COPYRIGHT HOLDERS BE LIABLE FOR ANY CLAIM, DAMAGES OR OTHER LIABILITY, WHETHER IN AN ACTION OF CONTRACT, TORT OR OTHERWISE, ARISING FROM, OUT OF OR IN CONNECTION WITH THE SOFTWARE OR THE USE OR OTHER DEALINGS IN THE SOFTWARE.

Except as contained in this notice, the name of a copyright holder shall not be used in advertising or otherwise to promote the sale, use or other dealings in this Software without prior written authorization of the copyright holder.

COPYRIGHT AND PERMISSION NOTICE

Copyright (C) 2012 – 2015, Daniel Stenberg, <daniel@haxx.se>, et al.

Copyright (C) 2010, Howard Chu, <hyc@highlandsun.com>

All rights reserved.

Permission to use, copy, modify, and distribute this software for any purpose with or without fee is hereby granted, provided that the above copyright notice and this permission notice appear in all copies.

THE SOFTWARE IS PROVIDED "AS IS", WITHOUT WARRANTY OF ANY KIND, EXPRESS OR IMPLIED, INCLUDING BUT NOT LIMITED TO THE WARRANTIES OF MERCHANTABILITY, FITNESS FOR A PARTICULAR PURPOSE AND NONINFRINGEMENT OF THIRD PARTY RIGHTS. IN NO EVENT SHALL THE AUTHORS OR COPYRIGHT HOLDERS BE LIABLE FOR ANY CLAIM, DAMAGES OR OTHER LIABILITY, WHETHER IN AN ACTION OF CONTRACT, TORT OR OTHERWISE, ARISING FROM, OUT OF OR IN CONNECTION WITH THE SOFTWARE OR THE USE OR OTHER DEALINGS IN THE SOFTWARE.

Except as contained in this notice, the name of a copyright holder shall not be used in advertising or otherwise to promote the sale, use or other dealings in this Software without prior written authorization of the copyright holder.

COPYRIGHT AND PERMISSION NOTICE

Copyright (C) 2010, Howard Chu, <hyc@highlandsun.com>

All rights reserved.

Permission to use, copy, modify, and distribute this software for any purpose with or without fee is hereby granted, provided that the above copyright notice and this permission notice appear in all copies.

THE SOFTWARE IS PROVIDED "AS IS", WITHOUT WARRANTY OF ANY KIND, EXPRESS OR IMPLIED, INCLUDING BUT NOT LIMITED TO THE WARRANTIES OF MERCHANTABILITY, FITNESS FOR A PARTICULAR PURPOSE AND NONINFRINGEMENT OF THIRD PARTY RIGHTS. IN NO EVENT SHALL THE AUTHORS OR COPYRIGHT HOLDERS BE LIABLE FOR ANY CLAIM, DAMAGES OR OTHER LIABILITY, WHETHER IN AN ACTION OF CONTRACT, TORT OR OTHERWISE, ARISING FROM, OUT OF OR IN CONNECTION WITH THE SOFTWARE OR THE USE OR OTHER DEALINGS IN THE SOFTWARE.

Except as contained in this notice, the name of a copyright holder shall not be used in advertising or

otherwise to promote the sale, use or other dealings in this Software without prior written authorization of the copyright holder.

COPYRIGHT AND PERMISSION NOTICE

Copyright (C) 1998 – 2016, Florin Petriuc, <petriuc.florin@gmail.com>

All rights reserved.

Permission to use, copy, modify, and distribute this software for any purpose with or without fee is hereby granted, provided that the above copyright notice and this permission notice appear in all copies.

THE SOFTWARE IS PROVIDED "AS IS", WITHOUT WARRANTY OF ANY KIND, EXPRESS OR IMPLIED, INCLUDING BUT NOT LIMITED TO THE WARRANTIES OF MERCHANTABILITY, FITNESS FOR A PARTICULAR PURPOSE AND NONINFRINGEMENT OF THIRD PARTY RIGHTS. IN NO EVENT SHALL THE AUTHORS OR COPYRIGHT HOLDERS BE LIABLE FOR ANY CLAIM, DAMAGES OR OTHER LIABILITY, WHETHER IN AN ACTION OF CONTRACT, TORT OR OTHERWISE, ARISING FROM, OUT OF OR IN CONNECTION WITH THE SOFTWARE OR THE USE OR OTHER DEALINGS IN THE SOFTWARE.

Except as contained in this notice, the name of a copyright holder shall not be used in advertising or otherwise to promote the sale, use or other dealings in this Software without prior written authorization of the copyright holder.

COPYRIGHT AND PERMISSION NOTICE

Copyright (C) 2012 – 2017, Nick Zitzmann, <nickzman@gmail.com>.

Copyright (C) 2012 – 2018, Daniel Stenberg, <daniel@haxx.se>, et al.

All rights reserved.

Permission to use, copy, modify, and distribute this software for any purpose with or without fee is hereby granted, provided that the above copyright notice and this permission notice appear in all copies.

THE SOFTWARE IS PROVIDED "AS IS", WITHOUT WARRANTY OF ANY KIND, EXPRESS OR IMPLIED, INCLUDING BUT NOT LIMITED TO THE WARRANTIES OF MERCHANTABILITY, FITNESS FOR A PARTICULAR PURPOSE AND NONINFRINGEMENT OF THIRD PARTY RIGHTS. IN NO EVENT SHALL THE

AUTHORS OR COPYRIGHT HOLDERS BE LIABLE FOR ANY CLAIM, DAMAGES OR OTHER LIABILITY, WHETHER IN AN ACTION OF CONTRACT, TORT OR OTHERWISE, ARISING FROM, OUT OF OR IN CONNECTION WITH THE SOFTWARE OR THE USE OR OTHER DEALINGS IN THE SOFTWARE.

Except as contained in this notice, the name of a copyright holder shall not be used in advertising or otherwise to promote the sale, use or other dealings in this Software without prior written authorization of the copyright holder.

COPYRIGHT AND PERMISSION NOTICE

Copyright (C) 2014 - 2016, Steve Holme, <steve_holme@hotmail.com>.

Copyright (C) 2015 - 2017, Daniel Stenberg, <daniel@haxx.se>, et al.

All rights reserved.

Permission to use, copy, modify, and distribute this software for any purpose with or without fee is hereby granted, provided that the above copyright notice and this permission notice appear in all copies.

THE SOFTWARE IS PROVIDED "AS IS", WITHOUT WARRANTY OF ANY KIND, EXPRESS OR IMPLIED, INCLUDING BUT NOT LIMITED TO THE WARRANTIES OF MERCHANTABILITY, FITNESS FOR A PARTICULAR PURPOSE AND NONINFRINGEMENT OF THIRD PARTY RIGHTS. IN NO EVENT SHALL THE AUTHORS OR COPYRIGHT HOLDERS BE LIABLE FOR ANY CLAIM, DAMAGES OR OTHER LIABILITY, WHETHER IN AN ACTION OF CONTRACT, TORT OR OTHERWISE, ARISING FROM, OUT OF OR IN CONNECTION WITH THE SOFTWARE OR THE USE OR OTHER DEALINGS IN THE SOFTWARE.

Except as contained in this notice, the name of a copyright holder shall not be used in advertising or otherwise to promote the sale, use or other dealings in this Software without prior written authorization of the copyright holder.

COPYRIGHT AND PERMISSION NOTICE

Copyright (C) 2010 - 2011, Hoi-Ho Chan, <hoiho.chan@gmail.com>

Copyright (C) 2012 - 2018, Daniel Stenberg, <daniel@haxx.se>, et al.

All rights reserved.

Permission to use, copy, modify, and distribute this software for any purpose with or without fee is

hereby granted, provided that the above copyright notice and this permission notice appear in all copies.

THE SOFTWARE IS PROVIDED "AS IS", WITHOUT WARRANTY OF ANY KIND, EXPRESS OR IMPLIED, INCLUDING BUT NOT LIMITED TO THE WARRANTIES OF MERCHANTABILITY, FITNESS FOR A PARTICULAR PURPOSE AND NONINFRINGEMENT OF THIRD PARTY RIGHTS. IN NO EVENT SHALL THE AUTHORS OR COPYRIGHT HOLDERS BE LIABLE FOR ANY CLAIM, DAMAGES OR OTHER LIABILITY, WHETHER IN AN ACTION OF CONTRACT, TORT OR OTHERWISE, ARISING FROM, OUT OF OR IN CONNECTION WITH THE SOFTWARE OR THE USE OR OTHER DEALINGS IN THE SOFTWARE.

Except as contained in this notice, the name of a copyright holder shall not be used in advertising or otherwise to promote the sale, use or other dealings in this Software without prior written authorization of the copyright holder.

COPYRIGHT AND PERMISSION NOTICE

Copyright (C) 2012 – 2018, Daniel Stenberg, <daniel@haxx.se>, et al.

Copyright (C) 2010 , 2011, Hoi-Ho Chan, <hoiho.chan@gmail.com>

All rights reserved.

Permission to use, copy, modify, and distribute this software for any purpose with or without fee is hereby granted, provided that the above copyright notice and this permission notice appear in all copies.

THE SOFTWARE IS PROVIDED "AS IS", WITHOUT WARRANTY OF ANY KIND, EXPRESS OR IMPLIED, INCLUDING BUT NOT LIMITED TO THE WARRANTIES OF MERCHANTABILITY, FITNESS FOR A PARTICULAR PURPOSE AND NONINFRINGEMENT OF THIRD PARTY RIGHTS. IN NO EVENT SHALL THE AUTHORS OR COPYRIGHT HOLDERS BE LIABLE FOR ANY CLAIM, DAMAGES OR OTHER LIABILITY, WHETHER IN AN ACTION OF CONTRACT, TORT OR OTHERWISE, ARISING FROM, OUT OF OR IN CONNECTION WITH THE SOFTWARE OR THE USE OR OTHER DEALINGS IN THE SOFTWARE.

Except as contained in this notice, the name of a copyright holder shall not be used in advertising or otherwise to promote the sale, use or other dealings in this Software without prior written authorization of the copyright holder.

COPYRIGHT AND PERMISSION NOTICE

Copyright (C) 2010, Howard Chu, <hyc@openldap.org>

Copyright (C) 2011 – 2018, Daniel Stenberg, <daniel@haxx.se>, et al.

All rights reserved.

Permission to use, copy, modify, and distribute this software for any purpose with or without fee is hereby granted, provided that the above copyright notice and this permission notice appear in all copies.

THE SOFTWARE IS PROVIDED "AS IS", WITHOUT WARRANTY OF ANY KIND, EXPRESS OR IMPLIED, INCLUDING BUT NOT LIMITED TO THE WARRANTIES OF MERCHANTABILITY, FITNESS FOR A PARTICULAR PURPOSE AND NONINFRINGEMENT OF THIRD PARTY RIGHTS. IN NO EVENT SHALL THE AUTHORS OR COPYRIGHT HOLDERS BE LIABLE FOR ANY CLAIM, DAMAGES OR OTHER LIABILITY, WHETHER IN AN ACTION OF CONTRACT, TORT OR OTHERWISE, ARISING FROM, OUT OF OR IN CONNECTION WITH THE SOFTWARE OR THE USE OR OTHER DEALINGS IN THE SOFTWARE.

Except as contained in this notice, the name of a copyright holder shall not be used in advertising or otherwise to promote the sale, use or other dealings in this Software without prior written authorization of the copyright holder.

COPYRIGHT AND PERMISSION NOTICE

Copyright (C) 2012 – 2016, Marc Hoersken, <info@marc-hoersken.de>

Copyright (C) 2012, Mark Salisbury, <mark.salisbury@hp.com>

Copyright (C) 2012 – 2018, Daniel Stenberg, <daniel@haxx.se>, et al.

All rights reserved.

Permission to use, copy, modify, and distribute this software for any purpose with or without fee is hereby granted, provided that the above copyright notice and this permission notice appear in all copies.

THE SOFTWARE IS PROVIDED "AS IS", WITHOUT WARRANTY OF ANY KIND, EXPRESS OR IMPLIED, INCLUDING BUT NOT LIMITED TO THE WARRANTIES OF MERCHANTABILITY, FITNESS FOR A PARTICULAR PURPOSE AND NONINFRINGEMENT OF THIRD PARTY RIGHTS. IN NO EVENT SHALL THE AUTHORS OR COPYRIGHT HOLDERS BE LIABLE FOR ANY CLAIM, DAMAGES OR OTHER LIABILITY, WHETHER IN AN ACTION OF CONTRACT, TORT OR OTHERWISE, ARISING FROM, OUT OF OR IN CONNECTION WITH THE SOFTWARE OR THE USE OR OTHER DEALINGS IN THE SOFTWARE.

Except as contained in this notice, the name of a copyright holder shall not be used in advertising or otherwise to promote the sale, use or other dealings in this Software without prior written authorization of the copyright holder.

COPYRIGHT AND PERMISSION NOTICE

Copyright (C) 2012, Marc Hoersken, <info@marc-hoersken.de>, et al.

Copyright (C) 2012 – 2017, Daniel Stenberg, <daniel@haxx.se>, et al.

All rights reserved.

Permission to use, copy, modify, and distribute this software for any purpose with or without fee is hereby granted, provided that the above copyright notice and this permission notice appear in all copies.

THE SOFTWARE IS PROVIDED "AS IS", WITHOUT WARRANTY OF ANY KIND, EXPRESS OR IMPLIED, INCLUDING BUT NOT LIMITED TO THE WARRANTIES OF MERCHANTABILITY, FITNESS FOR A PARTICULAR PURPOSE AND NONINFRINGEMENT OF THIRD PARTY RIGHTS. IN NO EVENT SHALL THE AUTHORS OR COPYRIGHT HOLDERS BE LIABLE FOR ANY CLAIM, DAMAGES OR OTHER LIABILITY, WHETHER IN AN ACTION OF CONTRACT, TORT OR OTHERWISE, ARISING FROM, OUT OF OR IN CONNECTION WITH THE SOFTWARE OR THE USE OR OTHER DEALINGS IN THE SOFTWARE.

Except as contained in this notice, the name of a copyright holder shall not be used in advertising or otherwise to promote the sale, use or other dealings in this Software without prior written authorization of the copyright holder.

COPYRIGHT AND PERMISSION NOTICE

Copyright (C) 2014, Bill Nagel <wnagel@tycoint.com>, Exacq Technologies

Copyright (C) 2016–2018, Daniel Stenberg, <daniel@haxx.se>, et al.

All rights reserved.

Permission to use, copy, modify, and distribute this software for any purpose with or without fee is hereby granted, provided that the above copyright notice and this permission notice appear in all copies.

THE SOFTWARE IS PROVIDED "AS IS", WITHOUT WARRANTY OF ANY KIND, EXPRESS OR IMPLIED, INCLUDING BUT NOT LIMITED TO THE WARRANTIES OF MERCHANTABILITY, FITNESS FOR A PARTICULAR PURPOSE AND NONINFRINGEMENT OF THIRD PARTY RIGHTS. IN NO EVENT SHALL THE AUTHORS OR COPYRIGHT HOLDERS BE LIABLE FOR ANY CLAIM, DAMAGES OR OTHER LIABILITY, WHETHER IN AN ACTION OF CONTRACT, TORT OR OTHERWISE, ARISING FROM, OUT OF OR IN CONNECTION WITH THE SOFTWARE OR THE USE OR OTHER DEALINGS IN THE SOFTWARE.

Except as contained in this notice, the name of a copyright holder shall not be used in advertising or otherwise to promote the sale, use or other dealings in this Software without prior written authorization of the copyright holder.

COPYRIGHT AND PERMISSION NOTICE

Copyright (C) 2009, Markus Moeller, <markus_moeller@compuserve.com>

Copyright (C) 2012 - 2017, Daniel Stenberg, <daniel@haxx.se>, et al.

All rights reserved.

Permission to use, copy, modify, and distribute this software for any purpose with or without fee is hereby granted, provided that the above copyright notice and this permission notice appear in all copies.

THE SOFTWARE IS PROVIDED "AS IS", WITHOUT WARRANTY OF ANY KIND, EXPRESS OR IMPLIED, INCLUDING BUT NOT LIMITED TO THE WARRANTIES OF MERCHANTABILITY, FITNESS FOR A PARTICULAR PURPOSE AND NONINFRINGEMENT OF THIRD PARTY RIGHTS. IN NO EVENT SHALL THE AUTHORS OR COPYRIGHT HOLDERS BE LIABLE FOR ANY CLAIM, DAMAGES OR OTHER LIABILITY, WHETHER IN AN ACTION OF CONTRACT, TORT OR OTHERWISE, ARISING FROM, OUT OF OR IN CONNECTION WITH THE SOFTWARE OR THE USE OR OTHER DEALINGS IN THE SOFTWARE.

Except as contained in this notice, the name of a copyright holder shall not be used in advertising or otherwise to promote the sale, use or other dealings in this Software without prior written authorization of the copyright holder.

COPYRIGHT AND PERMISSION NOTICE

Copyright (C) 2012 - 2017, Daniel Stenberg, <daniel@haxx.se>, et al.

Copyright (C) 2009, 2011, Markus Moeller, <markus_moeller@compuserve.com>

All rights reserved.

Permission to use, copy, modify, and distribute this software for any purpose with or without fee is hereby granted, provided that the above copyright notice and this permission notice appear in all copies.

THE SOFTWARE IS PROVIDED "AS IS", WITHOUT WARRANTY OF ANY KIND, EXPRESS OR IMPLIED, INCLUDING BUT NOT LIMITED TO THE WARRANTIES OF MERCHANTABILITY, FITNESS FOR A PARTICULAR PURPOSE AND NONINFRINGEMENT OF THIRD PARTY RIGHTS. IN NO EVENT SHALL THE AUTHORS OR COPYRIGHT HOLDERS BE LIABLE FOR ANY CLAIM, DAMAGES OR OTHER LIABILITY, WHETHER IN AN ACTION OF CONTRACT, TORT OR OTHERWISE, ARISING FROM, OUT OF OR IN CONNECTION WITH THE SOFTWARE OR THE USE OR OTHER DEALINGS IN THE SOFTWARE.

Except as contained in this notice, the name of a copyright holder shall not be used in advertising or otherwise to promote the sale, use or other dealings in this Software without prior written authorization of the copyright holder.

* Copyright (C) 2017 – 2018 Red Hat, Inc.

*

* Authors: Nikos Mavrogiannopoulos, Tomas Mraz, Stanislav Zidek,

* Robert Kolcun, Andreas Schneider

*

* This software is licensed as described in the file COPYING, which

* you should have received as part of this distribution. The terms

* are also available at <https://curl.haxx.se/docs/copyright.html>.

*

* You may opt to use, copy, modify, merge, publish, distribute and/or sell

* copies of the Software, and permit persons to whom the Software is

* furnished to do so, under the terms of the COPYING file.

*

* This software is distributed on an "AS IS" basis, WITHOUT WARRANTY OF ANY

* KIND, either express or implied.

Copyright (C) 1994 X Consortium

#

Permission is hereby granted, free of charge, to any person obtaining a copy

of this software and associated documentation files (the "Software"), to

deal in the Software without restriction, including without limitation the

rights to use, copy, modify, merge, publish, distribute, sublicense, and/or
sell copies of the Software, and to permit persons to whom the Software is
furnished to do so, subject to the following conditions:

The above copyright notice and this permission notice shall be included in
all copies or substantial portions of the Software.

THE SOFTWARE IS PROVIDED "AS IS", WITHOUT WARRANTY OF ANY KIND, EXPRESS OR
IMPLIED, INCLUDING BUT NOT LIMITED TO THE WARRANTIES OF MERCHANTABILITY,
FITNESS FOR A PARTICULAR PURPOSE AND NONINFRINGEMENT. IN NO EVENT SHALL THE
X CONSORTIUM BE LIABLE FOR ANY CLAIM, DAMAGES OR OTHER LIABILITY, WHETHER IN
AN ACTION OF CONTRACT, TORT OR OTHERWISE, ARISING FROM, OUT OF OR IN CONNEC-
TION WITH THE SOFTWARE OR THE USE OR OTHER DEALINGS IN THE SOFTWARE. +

Except as contained in this notice, the name of the X Consortium shall not
be used in advertising or otherwise to promote the sale, use or other deal-
ings in this Software without prior written authorization from the X Consor-
tium.

* Copyright (C) 1996-2001 Internet Software Consortium.

*

* Permission to use, copy, modify, and distribute this software for any
* purpose with or without fee is hereby granted, provided that the above
* copyright notice and this permission notice appear in all copies.

*

* THE SOFTWARE IS PROVIDED "AS IS" AND INTERNET SOFTWARE CONSORTIUM
* DISCLAIMS ALL WARRANTIES WITH REGARD TO THIS SOFTWARE INCLUDING ALL
* IMPLIED WARRANTIES OF MERCHANTABILITY AND FITNESS. IN NO EVENT SHALL
* INTERNET SOFTWARE CONSORTIUM BE LIABLE FOR ANY SPECIAL, DIRECT,
* INDIRECT, OR CONSEQUENTIAL DAMAGES OR ANY DAMAGES WHATSOEVER RESULTING
* FROM LOSS OF USE, DATA OR PROFITS, WHETHER IN AN ACTION OF CONTRACT,
* NEGLIGENCE OR OTHER TORTIOUS ACTION, ARISING OUT OF OR IN CONNECTION
* WITH THE USE OR PERFORMANCE OF THIS SOFTWARE.

* Copyright (c) 1995, 1996, 1997, 1998, 1999, 2017 Kungliga Tekniska Högskolan
* (Royal Institute of Technology, Stockholm, Sweden).

* Copyright (c) 2001 - 2017 Daniel Stenberg

* All rights reserved.

*

* Redistribution and use in source and binary forms, with or without
* modification, are permitted provided that the following conditions
* are met:

*

* 1. Redistributions of source code must retain the above copyright
* notice, this list of conditions and the following disclaimer.

*

* 2. Redistributions in binary form must reproduce the above copyright
* notice, this list of conditions and the following disclaimer in the
* documentation and/or other materials provided with the distribution.

*

* 3. Neither the name of the Institute nor the names of its contributors
* may be used to endorse or promote products derived from this software
* without specific prior written permission.

*

* THIS SOFTWARE IS PROVIDED BY THE INSTITUTE AND CONTRIBUTORS ``AS IS" AND
* ANY EXPRESS OR IMPLIED WARRANTIES, INCLUDING, BUT NOT LIMITED TO, THE
* IMPLIED WARRANTIES OF MERCHANTABILITY AND FITNESS FOR A PARTICULAR PURPOSE
* ARE DISCLAIMED. IN NO EVENT SHALL THE INSTITUTE OR CONTRIBUTORS BE LIABLE
* FOR ANY DIRECT, INDIRECT, INCIDENTAL, SPECIAL, EXEMPLARY, OR CONSEQUENTIAL
* DAMAGES (INCLUDING, BUT NOT LIMITED TO, PROCUREMENT OF SUBSTITUTE GOODS
* OR SERVICES; LOSS OF USE, DATA, OR PROFITS; OR BUSINESS INTERRUPTION)
* HOWEVER CAUSED AND ON ANY THEORY OF LIABILITY, WHETHER IN CONTRACT, STRICT
* LIABILITY, OR TORT (INCLUDING NEGLIGENCE OR OTHERWISE) ARISING IN ANY WAY
* OUT OF THE USE OF THIS SOFTWARE, EVEN IF ADVISED OF THE POSSIBILITY OF
* SUCH DAMAGE. */

18.libjingle

Copyright 2004--2007, Google Inc.

Redistribution and use in source and binary forms, with or without modification, are permitted provided that the following conditions are met:

1. Redistributions of source code must retain the above copyright notice, this list of conditions and the following disclaimer.
2. Redistributions in binary form must reproduce the above copyright notice, this list of conditions and the following disclaimer in the documentation and/or other materials provided with the distribution.
3. The name of the author may not be used to endorse or promote products derived from this software without specific prior written permission.

THIS SOFTWARE IS PROVIDED BY THE AUTHOR ``AS IS" AND ANY EXPRESS OR IMPLIED WARRANTIES, INCLUDING, BUT NOT LIMITED TO, THE IMPLIED WARRANTIES OF MERCHANTABILITY AND FITNESS FOR A PARTICULAR PURPOSE ARE DISCLAIMED. IN NO EVENT SHALL THE AUTHOR BE LIABLE FOR ANY DIRECT, INDIRECT, INCIDENTAL, SPECIAL, EXEMPLARY, OR CONSEQUENTIAL DAMAGES (INCLUDING, BUT NOT LIMITED TO, PROCUREMENT OF SUBSTITUTE GOODS OR SERVICES; LOSS OF USE, DATA, OR PROFITS; OR BUSINESS INTERRUPTION) HOWEVER CAUSED AND ON ANY THEORY OF LIABILITY, WHETHER IN CONTRACT, STRICT LIABILITY, OR TORT (INCLUDING NEGLIGENCE OR OTHERWISE) ARISING IN ANY WAY OUT OF THE USE OF THIS SOFTWARE, EVEN IF ADVISED OF THE POSSIBILITY OF SUCH DAMAGE.

19.libpcap

License: BSD

Redistribution and use in source and binary forms, with or without modification, are permitted provided that the following conditions are met:

1. Redistributions of source code must retain the above copyright notice, this list of conditions and the following disclaimer.
2. Redistributions in binary form must reproduce the above copyright notice, this list of conditions and the following disclaimer in the documentation and/or other materials provided with the distribution.
3. The names of the authors may not be used to endorse or promote products derived from this software without specific prior written permission.

THIS SOFTWARE IS PROVIDED BY THE COPYRIGHT HOLDERS AND CONTRIBUTORS "AS IS" AND ANY EXPRESS OR IMPLIED WARRANTIES, INCLUDING, BUT NOT LIMITED TO, THE IMPLIED WARRANTIES OF MERCHANTABILITY AND FITNESS FOR A PARTICULAR PURPOSE ARE DISCLAIMED. IN NO EVENT SHALL THE COPYRIGHT HOLDER OR CONTRIBUTORS BE LIABLE FOR ANY DIRECT, INDIRECT, INCIDENTAL, SPECIAL, EXEMPLARY, OR CONSEQUENTIAL DAMAGES (INCLUDING, BUT NOT LIMITED TO, PROCUREMENT OF SUBSTITUTE GOODS OR SERVICES; LOSS OF USE, DATA, OR PROFITS; OR BUSINESS INTERRUPTION) HOWEVER CAUSED AND ON ANY THEORY OF LIABILITY, WHETHER IN CONTRACT, STRICT LIABILITY, OR TORT (INCLUDING NEGLIGENCE OR OTHERWISE) ARISING IN ANY WAY OUT OF THE USE OF THIS SOFTWARE, EVEN IF ADVISED OF THE POSSIBILITY OF SUCH DAMAGE.

20.libpng

* If you modify libpng you may insert additional notices immediately following
* this sentence.

*

* libpng version 1.2.6, August 15, 2004, is

* Copyright (c) 2004 Glenn Randers-Pehrson, and is

* distributed according to the same disclaimer and license as libpng-1.2.5

* with the following individual added to the list of Contributing Authors

* Cosmin Truta

*

* libpng versions 1.0.7, July 1, 2000, through 1.2.5, October 3, 2002, are

* Copyright (c) 2000-2002 Glenn Randers-Pehrson, and are

* distributed according to the same disclaimer and license as libpng-1.0.6

* with the following individuals added to the list of Contributing Authors

*

* Simon-Pierre Cadieux

* Eric S. Raymond

* Gilles Vollant

*

* and with the following additions to the disclaimer:

*

* There is no warranty against interference with your enjoyment of the

* library or against infringement. There is no warranty that our

* efforts or the library will fulfill any of your particular purposes

* or needs. This library is provided with all faults, and the entire

* risk of satisfactory quality, performance, accuracy, and effort is with

* the user.

*

* libpng versions 0.97, January 1998, through 1.0.6, March 20, 2000, are

* Copyright (c) 1998, 1999, 2000 Glenn Randers-Pehrson

* Distributed according to the same disclaimer and license as libpng-0.96,

* with the following individuals added to the list of Contributing Authors:

*

* Tom Lane

* Glenn Randers-Pehrson

* Willem van Schaik

*

* libpng versions 0.89, June 1996, through 0.96, May 1997, are

* Copyright (c) 1996, 1997 Andreas Dilger

* Distributed according to the same disclaimer and license as libpng-0.88,

* with the following individuals added to the list of Contributing Authors:

*

* John Bowler

* Kevin Bracey

* Sam Bushell

* Magnus Holmgren

* Greg Roelofs

* Tom Tanner

*

* libpng versions 0.5, May 1995, through 0.88, January 1996, are

* Copyright (c) 1995, 1996 Guy Eric Schalnat, Group 42, Inc.

*

* For the purposes of this copyright and license, "Contributing Authors"

* is defined as the following set of individuals:

*

* Andreas Dilger

* Dave Martindale

* Guy Eric Schalnat

* Paul Schmidt

* Tim Wegner

*

* The PNG Reference Library is supplied "AS IS". The Contributing Authors

* and Group 42, Inc. disclaim all warranties, expressed or implied,

* including, without limitation, the warranties of merchantability and of

* fitness for any purpose. The Contributing Authors and Group 42, Inc.

* assume no liability for direct, indirect, incidental, special, exemplary,

* or consequential damages, which may result from the use of the PNG

* Reference Library, even if advised of the possibility of such damage.

*

* Permission is hereby granted to use, copy, modify, and distribute this

* source code, or portions hereof, for any purpose, without fee, subject

* to the following restrictions:

*

- * 1. The origin of this source code must not be misrepresented.
- *
- * 2. Altered versions must be plainly marked as such and
- * must not be misrepresented as being the original source.
- *
- * 3. This Copyright notice may not be removed or altered from
- * any source or altered source distribution.
- *
- * The Contributing Authors and Group 42, Inc. specifically permit, without
- * fee, and encourage the use of this source code as a component to
- * supporting the PNG file format in commercial products. If you use this
- * source code in a product, acknowledgment is not required but would be
- * appreciated.

21.memcached

Copyright (c) 2003, Danga Interactive, Inc.
All rights reserved.

Redistribution and use in source and binary forms, with or without modification, are permitted provided that the following conditions are met:

- * Redistributions of source code must retain the above copyright notice, this list of conditions and the following disclaimer.

- * Redistributions in binary form must reproduce the above copyright notice, this list of conditions and the following disclaimer in the documentation and/or other materials provided with the distribution.

- * Neither the name of the Danga Interactive nor the names of its contributors may be used to endorse or promote products derived from this software without specific prior written permission.

THIS SOFTWARE IS PROVIDED BY THE COPYRIGHT HOLDERS AND CONTRIBUTORS "AS IS" AND ANY EXPRESS OR IMPLIED WARRANTIES, INCLUDING, BUT NOT LIMITED TO, THE IMPLIED WARRANTIES OF MERCHANTABILITY AND FITNESS FOR A PARTICULAR PURPOSE ARE DISCLAIMED. IN NO EVENT SHALL THE COPYRIGHT OWNER OR CONTRIBUTORS BE LIABLE FOR ANY DIRECT, INDIRECT, INCIDENTAL, SPECIAL, EXEMPLARY, OR CONSEQUENTIAL DAMAGES (INCLUDING, BUT NOT LIMITED TO, PROCUREMENT OF SUBSTITUTE GOODS OR SERVICES; LOSS OF USE, DATA, OR PROFITS; OR BUSINESS INTERRUPTION) HOWEVER CAUSED AND ON ANY THEORY OF LIABILITY, WHETHER IN CONTRACT, STRICT LIABILITY, OR TORT (INCLUDING NEGLIGENCE OR OTHERWISE) ARISING IN ANY WAY OUT OF THE USE OF THIS SOFTWARE, EVEN IF ADVISED OF THE POSSIBILITY OF SUCH DAMAGE.

22.Net-SNMP

Various copyrights apply to this package, listed in various separate parts below. Please make sure that you read all the parts.

----- Part 1: CMU/UCD copyright notice: (BSD like) -----

Copyright 1989, 1991, 1992 by Carnegie Mellon University

Derivative Work - 1996, 1998-2000

Copyright 1996, 1998-2000 The Regents of the University of California

All Rights Reserved

Permission to use, copy, modify and distribute this software and its documentation for any purpose and without fee is hereby granted, provided that the above copyright notice appears in all copies and that both that copyright notice and this permission notice appear in supporting documentation, and that the name of CMU and The Regents of the University of California not be used in advertising or publicity pertaining to distribution of the software without specific written permission.

CMU AND THE REGENTS OF THE UNIVERSITY OF CALIFORNIA DISCLAIM ALL WARRANTIES WITH REGARD TO THIS SOFTWARE, INCLUDING ALL IMPLIED WARRANTIES OF MERCHANTABILITY AND FITNESS. IN NO EVENT SHALL CMU OR THE REGENTS OF THE UNIVERSITY OF CALIFORNIA BE LIABLE FOR ANY SPECIAL, INDIRECT OR CONSEQUENTIAL DAMAGES OR ANY DAMAGES WHATSOEVER RESULTING FROM THE LOSS OF USE, DATA OR PROFITS, WHETHER IN AN ACTION OF CONTRACT, NEGLIGENCE OR OTHER TORTIOUS ACTION, ARISING OUT OF OR IN CONNECTION WITH THE USE OR PERFORMANCE OF THIS SOFTWARE.

----- Part 2: Networks Associates Technology, Inc copyright notice (BSD) -----

Copyright (c) 2001-2003, Networks Associates Technology, Inc

All rights reserved.

Redistribution and use in source and binary forms, with or without modification, are permitted provided that the following conditions are met:

- * Redistributions of source code must retain the above copyright notice, this list of conditions and the following disclaimer.
- * Redistributions in binary form must reproduce the above copyright notice, this list of conditions and the following disclaimer in the documentation and/or other materials provided with the distribution.
- * Neither the name of the Networks Associates Technology, Inc nor the names of its contributors may be used to endorse or promote products derived from this software without specific prior written permission.

THIS SOFTWARE IS PROVIDED BY THE COPYRIGHT HOLDERS AND CONTRIBUTORS "AS IS" AND ANY EXPRESS OR IMPLIED WARRANTIES, INCLUDING, BUT NOT LIMITED TO, THE IMPLIED WARRANTIES OF MERCHANTABILITY AND FITNESS FOR A PARTICULAR PURPOSE ARE DISCLAIMED. IN NO EVENT SHALL THE COPYRIGHT HOLDERS OR CONTRIBUTORS BE LIABLE FOR ANY DIRECT, INDIRECT, INCIDENTAL, SPECIAL, EXEMPLARY, OR CONSEQUENTIAL DAMAGES (INCLUDING, BUT NOT LIMITED TO, PROCUREMENT OF SUBSTITUTE GOODS OR SERVICES; LOSS OF USE, DATA, OR PROFITS; OR BUSINESS INTERRUPTION) HOWEVER CAUSED AND ON ANY THEORY OF LIABILITY, WHETHER IN CONTRACT, STRICT LIABILITY, OR TORT (INCLUDING NEGLIGENCE OR OTHERWISE) ARISING IN ANY WAY OUT OF THE USE OF THIS SOFTWARE, EVEN IF ADVISED OF THE POSSIBILITY OF SUCH DAMAGE.

----- Part 3: Cambridge Broadband Ltd. copyright notice (BSD) -----

Portions of this code are copyright (c) 2001–2003, Cambridge Broadband Ltd.
All rights reserved.

Redistribution and use in source and binary forms, with or without modification, are permitted provided that the following conditions are met:

- * Redistributions of source code must retain the above copyright notice,

this list of conditions and the following disclaimer.

- * Redistributions in binary form must reproduce the above copyright notice, this list of conditions and the following disclaimer in the documentation and/or other materials provided with the distribution.
- * The name of Cambridge Broadband Ltd. may not be used to endorse or promote products derived from this software without specific prior written permission.

THIS SOFTWARE IS PROVIDED BY THE COPYRIGHT HOLDER "AS IS" AND ANY EXPRESS OR IMPLIED WARRANTIES, INCLUDING, BUT NOT LIMITED TO, THE IMPLIED WARRANTIES OF MERCHANTABILITY AND FITNESS FOR A PARTICULAR PURPOSE ARE DISCLAIMED. IN NO EVENT SHALL THE COPYRIGHT HOLDER BE LIABLE FOR ANY DIRECT, INDIRECT, INCIDENTAL, SPECIAL, EXEMPLARY, OR CONSEQUENTIAL DAMAGES (INCLUDING, BUT NOT LIMITED TO, PROCUREMENT OF SUBSTITUTE GOODS OR SERVICES; LOSS OF USE, DATA, OR PROFITS; OR BUSINESS INTERRUPTION) HOWEVER CAUSED AND ON ANY THEORY OF LIABILITY, WHETHER IN CONTRACT, STRICT LIABILITY, OR TORT (INCLUDING NEGLIGENCE OR OTHERWISE) ARISING IN ANY WAY OUT OF THE USE OF THIS SOFTWARE, EVEN IF ADVISED OF THE POSSIBILITY OF SUCH DAMAGE.

----- Part 4: Sun Microsystems, Inc. copyright notice (BSD) -----

Copyright © 2003 Sun Microsystems, Inc., 4150 Network Circle, Santa Clara, California 95054, U.S.A. All rights reserved.

Use is subject to license terms below.

This distribution may include materials developed by third parties.

Sun, Sun Microsystems, the Sun logo and Solaris are trademarks or registered trademarks of Sun Microsystems, Inc. in the U.S. and other countries.

Redistribution and use in source and binary forms, with or without modification, are permitted provided that the following conditions are met:

- * Redistributions of source code must retain the above copyright notice, this list of conditions and the following disclaimer.
- * Redistributions in binary form must reproduce the above copyright notice, this list of conditions and the following disclaimer in the documentation and/or other materials provided with the distribution.
- * Neither the name of the Sun Microsystems, Inc. nor the names of its contributors may be used to endorse or promote products derived from this software without specific prior written permission.

THIS SOFTWARE IS PROVIDED BY THE COPYRIGHT HOLDERS AND CONTRIBUTORS "AS IS" AND ANY EXPRESS OR IMPLIED WARRANTIES, INCLUDING, BUT NOT LIMITED TO, THE IMPLIED WARRANTIES OF MERCHANTABILITY AND FITNESS FOR A PARTICULAR PURPOSE ARE DISCLAIMED. IN NO EVENT SHALL THE COPYRIGHT HOLDERS OR CONTRIBUTORS BE LIABLE FOR ANY DIRECT, INDIRECT, INCIDENTAL, SPECIAL, EXEMPLARY, OR CONSEQUENTIAL DAMAGES (INCLUDING, BUT NOT LIMITED TO, PROCUREMENT OF SUBSTITUTE GOODS OR SERVICES; LOSS OF USE, DATA, OR PROFITS; OR BUSINESS INTERRUPTION) HOWEVER CAUSED AND ON ANY THEORY OF LIABILITY, WHETHER IN CONTRACT, STRICT LIABILITY, OR TORT (INCLUDING NEGLIGENCE OR OTHERWISE) ARISING IN ANY WAY OUT OF THE USE OF THIS SOFTWARE, EVEN IF ADVISED OF THE POSSIBILITY OF SUCH DAMAGE.

----- Part 5: Sparta, Inc copyright notice (BSD) -----

Copyright (c) 2003-2012, Sparta, Inc
All rights reserved.

Redistribution and use in source and binary forms, with or without modification, are permitted provided that the following conditions are met:

- * Redistributions of source code must retain the above copyright notice, this list of conditions and the following disclaimer.
- * Redistributions in binary form must reproduce the above copyright notice, this list of conditions and the following disclaimer in the documentation and/or other materials provided with the distribution.

- * Neither the name of Sparta, Inc nor the names of its contributors may be used to endorse or promote products derived from this software without specific prior written permission.

THIS SOFTWARE IS PROVIDED BY THE COPYRIGHT HOLDERS AND CONTRIBUTORS "AS IS" AND ANY EXPRESS OR IMPLIED WARRANTIES, INCLUDING, BUT NOT LIMITED TO, THE IMPLIED WARRANTIES OF MERCHANTABILITY AND FITNESS FOR A PARTICULAR PURPOSE ARE DISCLAIMED. IN NO EVENT SHALL THE COPYRIGHT HOLDERS OR CONTRIBUTORS BE LIABLE FOR ANY DIRECT, INDIRECT, INCIDENTAL, SPECIAL, EXEMPLARY, OR CONSEQUENTIAL DAMAGES (INCLUDING, BUT NOT LIMITED TO, PROCUREMENT OF SUBSTITUTE GOODS OR SERVICES; LOSS OF USE, DATA, OR PROFITS; OR BUSINESS INTERRUPTION) HOWEVER CAUSED AND ON ANY THEORY OF LIABILITY, WHETHER IN CONTRACT, STRICT LIABILITY, OR TORT (INCLUDING NEGLIGENCE OR OTHERWISE) ARISING IN ANY WAY OUT OF THE USE OF THIS SOFTWARE, EVEN IF ADVISED OF THE POSSIBILITY OF SUCH DAMAGE.

----- Part 6: Cisco/BUPTNIC copyright notice (BSD) -----

Copyright (c) 2004, Cisco, Inc and Information Network
Center of Beijing University of Posts and Telecommunications.
All rights reserved.

Redistribution and use in source and binary forms, with or without modification, are permitted provided that the following conditions are met:

- * Redistributions of source code must retain the above copyright notice, this list of conditions and the following disclaimer.
- * Redistributions in binary form must reproduce the above copyright notice, this list of conditions and the following disclaimer in the documentation and/or other materials provided with the distribution.
- * Neither the name of Cisco, Inc, Beijing University of Posts and Telecommunications, nor the names of their contributors may be used to endorse or promote products derived from this software without specific prior written permission.

THIS SOFTWARE IS PROVIDED BY THE COPYRIGHT HOLDERS AND CONTRIBUTORS ``AS IS" AND ANY EXPRESS OR IMPLIED WARRANTIES, INCLUDING, BUT NOT LIMITED TO, THE IMPLIED WARRANTIES OF MERCHANTABILITY AND FITNESS FOR A PARTICULAR PURPOSE ARE DISCLAIMED. IN NO EVENT SHALL THE COPYRIGHT HOLDERS OR CONTRIBUTORS BE LIABLE FOR ANY DIRECT, INDIRECT, INCIDENTAL, SPECIAL, EXEMPLARY, OR CONSEQUENTIAL DAMAGES (INCLUDING, BUT NOT LIMITED TO, PROCUREMENT OF SUBSTITUTE GOODS OR SERVICES; LOSS OF USE, DATA, OR PROFITS; OR BUSINESS INTERRUPTION) HOWEVER CAUSED AND ON ANY THEORY OF LIABILITY, WHETHER IN CONTRACT, STRICT LIABILITY, OR TORT (INCLUDING NEGLIGENCE OR OTHERWISE) ARISING IN ANY WAY OUT OF THE USE OF THIS SOFTWARE, EVEN IF ADVISED OF THE POSSIBILITY OF SUCH DAMAGE.

----- Part 7: Fabasoft R&D Software GmbH & Co KG copyright notice (BSD) -----

Copyright (c) Fabasoft R&D Software GmbH & Co KG, 2003

oss@fabasoft.com

Author: Bernhard Penz <bernhard.penz@fabasoft.com>

Redistribution and use in source and binary forms, with or without modification, are permitted provided that the following conditions are met:

- * Redistributions of source code must retain the above copyright notice, this list of conditions and the following disclaimer.
- * Redistributions in binary form must reproduce the above copyright notice, this list of conditions and the following disclaimer in the documentation and/or other materials provided with the distribution.
- * The name of Fabasoft R&D Software GmbH & Co KG or any of its subsidiaries, brand or product names may not be used to endorse or promote products derived from this software without specific prior written permission.

THIS SOFTWARE IS PROVIDED BY THE COPYRIGHT HOLDER ``AS IS" AND ANY EXPRESS OR IMPLIED WARRANTIES, INCLUDING, BUT NOT LIMITED TO, THE IMPLIED WARRANTIES OF MERCHANTABILITY AND FITNESS FOR A PARTICULAR PURPOSE ARE DISCLAIMED. IN NO EVENT SHALL THE COPYRIGHT HOLDER BE LIABLE FOR ANY DIRECT, INDIRECT, INCIDENTAL, SPECIAL, EXEMPLARY, OR CONSEQUENTIAL DAMAGES (INCLUDING, BUT NOT LIMITED TO, PROCUREMENT OF

SUBSTITUTE GOODS OR SERVICES; LOSS OF USE, DATA, OR PROFITS; OR BUSINESS INTERRUPTION) HOWEVER CAUSED AND ON ANY THEORY OF LIABILITY, WHETHER IN CONTRACT, STRICT LIABILITY, OR TORT (INCLUDING NEGLIGENCE OR OTHERWISE) ARISING IN ANY WAY OUT OF THE USE OF THIS SOFTWARE, EVEN IF ADVISED OF THE POSSIBILITY OF SUCH DAMAGE.

----- Part 8: Apple Inc. copyright notice (BSD) -----

Copyright (c) 2007 Apple Inc. All rights reserved.

Redistribution and use in source and binary forms, with or without modification, are permitted provided that the following conditions are met:

1. Redistributions of source code must retain the above copyright notice, this list of conditions and the following disclaimer.
2. Redistributions in binary form must reproduce the above copyright notice, this list of conditions and the following disclaimer in the documentation and/or other materials provided with the distribution.
3. Neither the name of Apple Inc. ("Apple") nor the names of its contributors may be used to endorse or promote products derived from this software without specific prior written permission.

THIS SOFTWARE IS PROVIDED BY APPLE AND ITS CONTRIBUTORS "AS IS" AND ANY EXPRESS OR IMPLIED WARRANTIES, INCLUDING, BUT NOT LIMITED TO, THE IMPLIED WARRANTIES OF MERCHANTABILITY AND FITNESS FOR A PARTICULAR PURPOSE ARE DISCLAIMED. IN NO EVENT SHALL APPLE OR ITS CONTRIBUTORS BE LIABLE FOR ANY DIRECT, INDIRECT, INCIDENTAL, SPECIAL, EXEMPLARY, OR CONSEQUENTIAL DAMAGES (INCLUDING, BUT NOT LIMITED TO, PROCUREMENT OF SUBSTITUTE GOODS OR SERVICES; LOSS OF USE, DATA, OR PROFITS; OR BUSINESS INTERRUPTION) HOWEVER CAUSED AND ON ANY THEORY OF LIABILITY, WHETHER IN CONTRACT, STRICT LIABILITY, OR TORT (INCLUDING NEGLIGENCE OR OTHERWISE) ARISING IN ANY WAY OUT OF THE USE OF THIS SOFTWARE, EVEN IF ADVISED OF THE POSSIBILITY OF SUCH DAMAGE.

----- Part 9: ScienceLogic, LLC copyright notice (BSD) -----

Copyright (c) 2009, ScienceLogic, LLC
All rights reserved.

Redistribution and use in source and binary forms, with or without modification, are permitted provided that the following conditions are met:

- * Redistributions of source code must retain the above copyright notice, this list of conditions and the following disclaimer.
- * Redistributions in binary form must reproduce the above copyright notice, this list of conditions and the following disclaimer in the documentation and/or other materials provided with the distribution.
- * Neither the name of ScienceLogic, LLC nor the names of its contributors may be used to endorse or promote products derived from this software without specific prior written permission.

THIS SOFTWARE IS PROVIDED BY THE COPYRIGHT HOLDERS AND CONTRIBUTORS ``AS IS" AND ANY EXPRESS OR IMPLIED WARRANTIES, INCLUDING, BUT NOT LIMITED TO, THE IMPLIED WARRANTIES OF MERCHANTABILITY AND FITNESS FOR A PARTICULAR PURPOSE ARE DISCLAIMED. IN NO EVENT SHALL THE COPYRIGHT HOLDERS OR CONTRIBUTORS BE LIABLE FOR ANY DIRECT, INDIRECT, INCIDENTAL, SPECIAL, EXEMPLARY, OR CONSEQUENTIAL DAMAGES (INCLUDING, BUT NOT LIMITED TO, PROCUREMENT OF SUBSTITUTE GOODS OR SERVICES; LOSS OF USE, DATA, OR PROFITS; OR BUSINESS INTERRUPTION) HOWEVER CAUSED AND ON ANY THEORY OF LIABILITY, WHETHER IN CONTRACT, STRICT LIABILITY, OR TORT (INCLUDING NEGLIGENCE OR OTHERWISE) ARISING IN ANY WAY OUT OF THE USE OF THIS SOFTWARE, EVEN IF ADVISED OF THE POSSIBILITY OF SUCH DAMAGE.

23.OpenSSL

OpenSSL License

/*

=====
=====

* Copyright (c) 1998-2011 The OpenSSL Project. All rights reserved.

*

* Redistribution and use in source and binary forms, with or without
* modification, are permitted provided that the following conditions
* are met:

*

* 1. Redistributions of source code must retain the above copyright
* notice, this list of conditions and the following disclaimer.

*

* 2. Redistributions in binary form must reproduce the above copyright
* notice, this list of conditions and the following disclaimer in
* the documentation and/or other materials provided with the
* distribution.

*

* 3. All advertising materials mentioning features or use of this
* software must display the following acknowledgment:

* "This product includes software developed by the OpenSSL Project
* for use in the OpenSSL Toolkit. (<http://www.openssl.org/>)"

*

* 4. The names "OpenSSL Toolkit" and "OpenSSL Project" must not be used to
* endorse or promote products derived from this software without
* prior written permission. For written permission, please contact
* openssl-core@openssl.org.

*

* 5. Products derived from this software may not be called "OpenSSL"
* nor may "OpenSSL" appear in their names without prior written
* permission of the OpenSSL Project.

*

* 6. Redistributions of any form whatsoever must retain the following

* acknowledgment:

* "This product includes software developed by the OpenSSL Project

* for use in the OpenSSL Toolkit (<http://www.openssl.org/>)"

*

* THIS SOFTWARE IS PROVIDED BY THE OpenSSL PROJECT ``AS IS" AND ANY

* EXPRESSED OR IMPLIED WARRANTIES, INCLUDING, BUT NOT LIMITED TO, THE

* IMPLIED WARRANTIES OF MERCHANTABILITY AND FITNESS FOR A PARTICULAR

* PURPOSE ARE DISCLAIMED. IN NO EVENT SHALL THE OpenSSL PROJECT OR

* ITS CONTRIBUTORS BE LIABLE FOR ANY DIRECT, INDIRECT, INCIDENTAL,

* SPECIAL, EXEMPLARY, OR CONSEQUENTIAL DAMAGES (INCLUDING, BUT

* NOT LIMITED TO, PROCUREMENT OF SUBSTITUTE GOODS OR SERVICES;

* LOSS OF USE, DATA, OR PROFITS; OR BUSINESS INTERRUPTION)

* HOWEVER CAUSED AND ON ANY THEORY OF LIABILITY, WHETHER IN CONTRACT,

* STRICT LIABILITY, OR TORT (INCLUDING NEGLIGENCE OR OTHERWISE)

* ARISING IN ANY WAY OUT OF THE USE OF THIS SOFTWARE, EVEN IF ADVISED

* OF THE POSSIBILITY OF SUCH DAMAGE.

*

=====

=====

*

* This product includes cryptographic software written by Eric Young

* (eay@cryptsoft.com). This product includes software written by Tim

* Hudson (tjh@cryptsoft.com).

*

*/

Original SSLeay License

/* Copyright (C) 1995-1998 Eric Young (eay@cryptsoft.com)

* All rights reserved.

*

* This package is an SSL implementation written

* by Eric Young (eay@cryptsoft.com).

* The implementation was written so as to conform with Netscapes SSL.

*

* This library is free for commercial and non-commercial use as long as

* the following conditions are aheared to. The following conditions

* apply to all code found in this distribution, be it the RC4, RSA,
 * lhash, DES, etc., code; not just the SSL code. The SSL documentation
 * included with this distribution is covered by the same copyright terms
 * except that the holder is Tim Hudson (tjh@cryptsoft.com).
 *

* Copyright remains Eric Young's, and as such any Copyright notices in
 * the code are not to be removed.
 * If this package is used in a product, Eric Young should be given attribution
 * as the author of the parts of the library used.
 * This can be in the form of a textual message at program startup or
 * in documentation (online or textual) provided with the package.
 *

* Redistribution and use in source and binary forms, with or without
 * modification, are permitted provided that the following conditions
 * are met:

* 1. Redistributions of source code must retain the copyright
 * notice, this list of conditions and the following disclaimer.
 * 2. Redistributions in binary form must reproduce the above copyright
 * notice, this list of conditions and the following disclaimer in the
 * documentation and/or other materials provided with the distribution.
 * 3. All advertising materials mentioning features or use of this software
 * must display the following acknowledgement:
 * "This product includes cryptographic software written by
 * Eric Young (eay@cryptsoft.com)"
 * The word 'cryptographic' can be left out if the routines from the library
 * being used are not cryptographic related :-).
 * 4. If you include any Windows specific code (or a derivative thereof) from
 * the apps directory (application code) you must include an acknowledgement:
 * "This product includes software written by Tim Hudson (tjh@cryptsoft.com)"
 *

* THIS SOFTWARE IS PROVIDED BY ERIC YOUNG ``AS IS" AND
 * ANY EXPRESS OR IMPLIED WARRANTIES, INCLUDING, BUT NOT LIMITED TO, THE
 * IMPLIED WARRANTIES OF MERCHANTABILITY AND FITNESS FOR A PARTICULAR PURPOSE
 * ARE DISCLAIMED. IN NO EVENT SHALL THE AUTHOR OR CONTRIBUTORS BE LIABLE
 * FOR ANY DIRECT, INDIRECT, INCIDENTAL, SPECIAL, EXEMPLARY, OR CONSEQUENTIAL
 * DAMAGES (INCLUDING, BUT NOT LIMITED TO, PROCUREMENT OF SUBSTITUTE GOODS
 * OR SERVICES; LOSS OF USE, DATA, OR PROFITS; OR BUSINESS INTERRUPTION)
 * HOWEVER CAUSED AND ON ANY THEORY OF LIABILITY, WHETHER IN CONTRACT, STRICT

```
* LIABILITY, OR TORT (INCLUDING NEGLIGENCE OR OTHERWISE) ARISING IN ANY WAY
* OUT OF THE USE OF THIS SOFTWARE, EVEN IF ADVISED OF THE POSSIBILITY OF
* SUCH DAMAGE.
*
* The licence and distribution terms for any publically available version or
* derivative of this code cannot be changed. i.e. this code cannot simply be
* copied and put under another distribution licence
* [including the GNU Public Licence.]
*/
/*
* Copyright (c) 2002 Bob Beck <beck@openbsd.org>
* Copyright (c) 2002 Theo de Raadt
* Copyright (c) 2002 Markus Friedl
* All rights reserved.
*
* Redistribution and use in source and binary forms, with or without
* modification, are permitted provided that the following conditions
* are met:
* 1. Redistributions of source code must retain the above copyright
*    notice, this list of conditions and the following disclaimer.
* 2. Redistributions in binary form must reproduce the above copyright
*    notice, this list of conditions and the following disclaimer in the
*    documentation and/or other materials provided with the distribution.
*
* THIS SOFTWARE IS PROVIDED BY THE AUTHOR AND CONTRIBUTORS ``AS IS'' AND ANY
* EXPRESS OR IMPLIED WARRANTIES, INCLUDING, BUT NOT LIMITED TO, THE IMPLIED
* WARRANTIES OF MERCHANTABILITY AND FITNESS FOR A PARTICULAR PURPOSE ARE
* DISCLAIMED.  IN NO EVENT SHALL THE AUTHOR OR CONTRIBUTORS BE LIABLE FOR ANY
* DIRECT, INDIRECT, INCIDENTAL, SPECIAL, EXEMPLARY, OR CONSEQUENTIAL DAMAGES
* (INCLUDING, BUT NOT LIMITED TO, PROCUREMENT OF SUBSTITUTE GOODS OR SERVICES;
* LOSS OF USE, DATA, OR PROFITS; OR BUSINESS INTERRUPTION) HOWEVER CAUSED AND
* ON ANY THEORY OF LIABILITY, WHETHER IN CONTRACT, STRICT LIABILITY, OR TORT
* (INCLUDING NEGLIGENCE OR OTHERWISE) ARISING IN ANY WAY OUT OF THE USE OF
* THIS SOFTWARE, EVEN IF ADVISED OF THE POSSIBILITY OF SUCH DAMAGE.
*
*/
/*
```

* Copyright (c) 2004, Richard Levitte <richard@levitte.org>

* All rights reserved.

*

* Redistribution and use in source and binary forms, with or without

* modification, are permitted provided that the following conditions

* are met:

* 1. Redistributions of source code must retain the above copyright

* notice, this list of conditions and the following disclaimer.

* 2. Redistributions in binary form must reproduce the above copyright

* notice, this list of conditions and the following disclaimer in the

* documentation and/or other materials provided with the distribution.

*

* THIS SOFTWARE IS PROVIDED BY THE REGENTS AND CONTRIBUTORS ``AS IS" AND

* ANY EXPRESS OR IMPLIED WARRANTIES, INCLUDING, BUT NOT LIMITED TO, THE

* IMPLIED WARRANTIES OF MERCHANTABILITY AND FITNESS FOR A PARTICULAR PURPOSE

* ARE DISCLAIMED. IN NO EVENT SHALL THE REGENTS OR CONTRIBUTORS BE LIABLE

* FOR ANY DIRECT, INDIRECT, INCIDENTAL, SPECIAL, EXEMPLARY, OR CONSEQUENTIAL

* DAMAGES (INCLUDING, BUT NOT LIMITED TO, PROCUREMENT OF SUBSTITUTE GOODS

* OR SERVICES; LOSS OF USE, DATA, OR PROFITS; OR BUSINESS INTERRUPTION)

* HOWEVER CAUSED AND ON ANY THEORY OF LIABILITY, WHETHER IN CONTRACT, STRICT

* LIABILITY, OR TORT (INCLUDING NEGLIGENCE OR OTHERWISE) ARISING IN ANY WAY

* OUT OF THE USE OF THIS SOFTWARE, EVEN IF ADVISED OF THE POSSIBILITY OF

* SUCH DAMAGE.

*/

/* Copyright (c) 2014, Google Inc.

*

* Permission to use, copy, modify, and/or distribute this software for any

* purpose with or without fee is hereby granted, provided that the above

* copyright notice and this permission notice appear in all copies.

*

* THE SOFTWARE IS PROVIDED "AS IS" AND THE AUTHOR DISCLAIMS ALL WARRANTIES

* WITH REGARD TO THIS SOFTWARE INCLUDING ALL IMPLIED WARRANTIES OF

* MERCHANTABILITY AND FITNESS. IN NO EVENT SHALL THE AUTHOR BE LIABLE FOR ANY

* SPECIAL, DIRECT, INDIRECT, OR CONSEQUENTIAL DAMAGES OR ANY DAMAGES

* WHATSOEVER RESULTING FROM LOSS OF USE, DATA OR PROFITS, WHETHER IN AN ACTION

* OF CONTRACT, NEGLIGENCE OR OTHER TORTIOUS ACTION, ARISING OUT OF OR IN

* CONNECTION WITH THE USE OR PERFORMANCE OF THIS SOFTWARE.

*/

OpenSSL License

/*

=====
=====

* Copyright (c) 1998–2018 The OpenSSL Project. All rights reserved.

*

* Redistribution and use in source and binary forms, with or without
* modification, are permitted provided that the following conditions
* are met:

*

* 1. Redistributions of source code must retain the above copyright
* notice, this list of conditions and the following disclaimer.

*

* 2. Redistributions in binary form must reproduce the above copyright
* notice, this list of conditions and the following disclaimer in
* the documentation and/or other materials provided with the
* distribution.

*

* 3. All advertising materials mentioning features or use of this
* software must display the following acknowledgment:
* "This product includes software developed by the OpenSSL Project
* for use in the OpenSSL Toolkit. (<http://www.openssl.org/>)"

*

* 4. The names "OpenSSL Toolkit" and "OpenSSL Project" must not be used to
* endorse or promote products derived from this software without
* prior written permission. For written permission, please contact
* openssl-core@openssl.org.

*

* 5. Products derived from this software may not be called "OpenSSL"
* nor may "OpenSSL" appear in their names without prior written
* permission of the OpenSSL Project.

*

* 6. Redistributions of any form whatsoever must retain the following
* acknowledgment:
* "This product includes software developed by the OpenSSL Project
* for use in the OpenSSL Toolkit (<http://www.openssl.org/>)"

*
* THIS SOFTWARE IS PROVIDED BY THE OpenSSL PROJECT ``AS IS" AND ANY
* EXPRESSED OR IMPLIED WARRANTIES, INCLUDING, BUT NOT LIMITED TO, THE
* IMPLIED WARRANTIES OF MERCHANTABILITY AND FITNESS FOR A PARTICULAR
* PURPOSE ARE DISCLAIMED. IN NO EVENT SHALL THE OpenSSL PROJECT OR
* ITS CONTRIBUTORS BE LIABLE FOR ANY DIRECT, INDIRECT, INCIDENTAL,
* SPECIAL, EXEMPLARY, OR CONSEQUENTIAL DAMAGES (INCLUDING, BUT
* NOT LIMITED TO, PROCUREMENT OF SUBSTITUTE GOODS OR SERVICES;
* LOSS OF USE, DATA, OR PROFITS; OR BUSINESS INTERRUPTION)
* HOWEVER CAUSED AND ON ANY THEORY OF LIABILITY, WHETHER IN CONTRACT,
* STRICT LIABILITY, OR TORT (INCLUDING NEGLIGENCE OR OTHERWISE)
* ARISING IN ANY WAY OUT OF THE USE OF THIS SOFTWARE, EVEN IF ADVISED
* OF THE POSSIBILITY OF SUCH DAMAGE.

=====
=====

*
* This product includes cryptographic software written by Eric Young
* (eay@cryptsoft.com). This product includes software written by Tim
* Hudson (tjh@cryptsoft.com).
*
*/

Original SSLeay License

/* Copyright (C) 1995-1998 Eric Young (eay@cryptsoft.com)
* All rights reserved.
*
* This package is an SSL implementation written
* by Eric Young (eay@cryptsoft.com).
* The implementation was written so as to conform with Netscapes SSL.
*
* This library is free for commercial and non-commercial use as long as
* the following conditions are aheared to. The following conditions
* apply to all code found in this distribution, be it the RC4, RSA,
* lhash, DES, etc., code; not just the SSL code. The SSL documentation
* included with this distribution is covered by the same copyright terms

* except that the holder is Tim Hudson (tjh@cryptsoft.com).

*

* Copyright remains Eric Young's, and as such any Copyright notices in

* the code are not to be removed.

* If this package is used in a product, Eric Young should be given attribution

* as the author of the parts of the library used.

* This can be in the form of a textual message at program startup or

* in documentation (online or textual) provided with the package.

*

* Redistribution and use in source and binary forms, with or without

* modification, are permitted provided that the following conditions

* are met:

* 1. Redistributions of source code must retain the copyright

* notice, this list of conditions and the following disclaimer.

* 2. Redistributions in binary form must reproduce the above copyright

* notice, this list of conditions and the following disclaimer in the

* documentation and/or other materials provided with the distribution.

* 3. All advertising materials mentioning features or use of this software

* must display the following acknowledgement:

* "This product includes cryptographic software written by

* Eric Young (eay@cryptsoft.com)"

* The word 'cryptographic' can be left out if the routines from the library

* being used are not cryptographic related :-).

* 4. If you include any Windows specific code (or a derivative thereof) from

* the apps directory (application code) you must include an acknowledgement:

* "This product includes software written by Tim Hudson (tjh@cryptsoft.com)"

*

* THIS SOFTWARE IS PROVIDED BY ERIC YOUNG ``AS IS" AND

* ANY EXPRESS OR IMPLIED WARRANTIES, INCLUDING, BUT NOT LIMITED TO, THE

* IMPLIED WARRANTIES OF MERCHANTABILITY AND FITNESS FOR A PARTICULAR PURPOSE

* ARE DISCLAIMED. IN NO EVENT SHALL THE AUTHOR OR CONTRIBUTORS BE LIABLE

* FOR ANY DIRECT, INDIRECT, INCIDENTAL, SPECIAL, EXEMPLARY, OR CONSEQUENTIAL

* DAMAGES (INCLUDING, BUT NOT LIMITED TO, PROCUREMENT OF SUBSTITUTE GOODS

* OR SERVICES; LOSS OF USE, DATA, OR PROFITS; OR BUSINESS INTERRUPTION)

* HOWEVER CAUSED AND ON ANY THEORY OF LIABILITY, WHETHER IN CONTRACT, STRICT

* LIABILITY, OR TORT (INCLUDING NEGLIGENCE OR OTHERWISE) ARISING IN ANY WAY

* OUT OF THE USE OF THIS SOFTWARE, EVEN IF ADVISED OF THE POSSIBILITY OF

* SUCH DAMAGE.

*
* The licence and distribution terms for any publically available version or
* derivative of this code cannot be changed. i.e. this code cannot simply be
* copied and put under another distribution licence
* [including the GNU Public Licence.]
*/

=====
=====

* Copyright (c) 1998-2008 The OpenSSL Project. All rights reserved.

*
* Redistribution and use in source and binary forms, with or without
* modification, are permitted provided that the following conditions
* are met:

*
* 1. Redistributions of source code must retain the above copyright
* notice, this list of conditions and the following disclaimer.

*
* 2. Redistributions in binary form must reproduce the above copyright
* notice, this list of conditions and the following disclaimer in
* the documentation and/or other materials provided with the
* distribution.

*
* 3. All advertising materials mentioning features or use of this
* software must display the following acknowledgment:
* "This product includes software developed by the OpenSSL Project
* for use in the OpenSSL Toolkit. (<http://www.openssl.org/>)"

*
* 4. The names "OpenSSL Toolkit" and "OpenSSL Project" must not be used to
* endorse or promote products derived from this software without
* prior written permission. For written permission, please contact
* openssl-core@openssl.org.

*
* 5. Products derived from this software may not be called "OpenSSL"
* nor may "OpenSSL" appear in their names without prior written
* permission of the OpenSSL Project.

*
* 6. Redistributions of any form whatsoever must retain the following

* acknowledgment:
* "This product includes software developed by the OpenSSL Project
* for use in the OpenSSL Toolkit (<http://www.openssl.org/>)"
*
* THIS SOFTWARE IS PROVIDED BY THE OpenSSL PROJECT ``AS IS'' AND ANY
* EXPRESSED OR IMPLIED WARRANTIES, INCLUDING, BUT NOT LIMITED TO, THE
* IMPLIED WARRANTIES OF MERCHANTABILITY AND FITNESS FOR A PARTICULAR
* PURPOSE ARE DISCLAIMED. IN NO EVENT SHALL THE OpenSSL PROJECT OR
* ITS CONTRIBUTORS BE LIABLE FOR ANY DIRECT, INDIRECT, INCIDENTAL,
* SPECIAL, EXEMPLARY, OR CONSEQUENTIAL DAMAGES (INCLUDING, BUT
* NOT LIMITED TO, PROCUREMENT OF SUBSTITUTE GOODS OR SERVICES;
* LOSS OF USE, DATA, OR PROFITS; OR BUSINESS INTERRUPTION)
* HOWEVER CAUSED AND ON ANY THEORY OF LIABILITY, WHETHER IN CONTRACT,
* STRICT LIABILITY, OR TORT (INCLUDING NEGLIGENCE OR OTHERWISE)
* ARISING IN ANY WAY OUT OF THE USE OF THIS SOFTWARE, EVEN IF ADVISED
* OF THE POSSIBILITY OF SUCH DAMAGE.

=====
=====

/* Copyright (C) 1995-1998 Eric Young (eay@cryptsoft.com)
* All rights reserved.
*
* This package is an SSL implementation written
* by Eric Young (eay@cryptsoft.com).
* The implementation was written so as to conform with Netscapes SSL.
*
* This library is free for commercial and non-commercial use as long as
* the following conditions are aheared to. The following conditions
* apply to all code found in this distribution, be it the RC4, RSA,
* lhash, DES, etc., code; not just the SSL code. The SSL documentation
* included with this distribution is covered by the same copyright terms
* except that the holder is Tim Hudson (tjh@cryptsoft.com).
*
* Copyright remains Eric Young's, and as such any Copyright notices in
* the code are not to be removed.
* If this package is used in a product, Eric Young should be given attribution
* as the author of the parts of the library used.

* This can be in the form of a textual message at program startup or
 * in documentation (online or textual) provided with the package.
 *
 * Redistribution and use in source and binary forms, with or without
 * modification, are permitted provided that the following conditions
 * are met:
 * 1. Redistributions of source code must retain the copyright
 * notice, this list of conditions and the following disclaimer.
 * 2. Redistributions in binary form must reproduce the above copyright
 * notice, this list of conditions and the following disclaimer in the
 * documentation and/or other materials provided with the distribution.
 * 3. All advertising materials mentioning features or use of this software
 * must display the following acknowledgement:
 * "This product includes cryptographic software written by
 * Eric Young (eay@cryptsoft.com)"
 * The word 'cryptographic' can be left out if the routines from the library
 * being used are not cryptographic related :-).
 * 4. If you include any Windows specific code (or a derivative thereof) from
 * the apps directory (application code) you must include an acknowledgement:
 * "This product includes software written by Tim Hudson (tjh@cryptsoft.com)"
 *
 * THIS SOFTWARE IS PROVIDED BY ERIC YOUNG ``AS IS'' AND
 * ANY EXPRESS OR IMPLIED WARRANTIES, INCLUDING, BUT NOT LIMITED TO, THE
 * IMPLIED WARRANTIES OF MERCHANTABILITY AND FITNESS FOR A PARTICULAR PURPOSE
 * ARE DISCLAIMED. IN NO EVENT SHALL THE AUTHOR OR CONTRIBUTORS BE LIABLE
 * FOR ANY DIRECT, INDIRECT, INCIDENTAL, SPECIAL, EXEMPLARY, OR CONSEQUENTIAL
 * DAMAGES (INCLUDING, BUT NOT LIMITED TO, PROCUREMENT OF SUBSTITUTE GOODS
 * OR SERVICES; LOSS OF USE, DATA, OR PROFITS; OR BUSINESS INTERRUPTION)
 * HOWEVER CAUSED AND ON ANY THEORY OF LIABILITY, WHETHER IN CONTRACT, STRICT
 * LIABILITY, OR TORT (INCLUDING NEGLIGENCE OR OTHERWISE) ARISING IN ANY WAY
 * OUT OF THE USE OF THIS SOFTWARE, EVEN IF ADVISED OF THE POSSIBILITY OF
 * SUCH DAMAGE.
 *
 * The licence and distribution terms for any publically available version or
 * derivative of this code cannot be changed. i.e. this code cannot simply be
 * copied and put under another distribution licence
 * [including the GNU Public Licence.]
 */

24.OSGi Release 5

Apache License

Version 2.0, January 2004

<http://www.apache.org/licenses/>

TERMS AND CONDITIONS FOR USE, REPRODUCTION, AND DISTRIBUTION

1. Definitions.

"License" shall mean the terms and conditions for use, reproduction, and distribution as defined by Sections 1 through 9 of this document.

"Licensor" shall mean the copyright owner or entity authorized by the copyright owner that is granting the License.

"Legal Entity" shall mean the union of the acting entity and all other entities that control, are controlled by, or are under common control with that entity. For the purposes of this definition, "control" means (i) the power, direct or indirect, to cause the direction or management of such entity, whether by contract or otherwise, or (ii) ownership of fifty percent (50%) or more of the outstanding shares, or (iii) beneficial ownership of such entity.

"You" (or "Your") shall mean an individual or Legal Entity exercising permissions granted by this License.

"Source" form shall mean the preferred form for making modifications, including but not limited to software source code, documentation source, and configuration files.

"Object" form shall mean any form resulting from mechanical transformation or translation of a Source form, including but not limited to compiled object code, generated documentation, and conversions to other media types.

"Work" shall mean the work of authorship, whether in Source or

Object form, made available under the License, as indicated by a copyright notice that is included in or attached to the work (an example is provided in the Appendix below).

"Derivative Works" shall mean any work, whether in Source or Object form, that is based on (or derived from) the Work and for which the editorial revisions, annotations, elaborations, or other modifications represent, as a whole, an original work of authorship. For the purposes of this License, Derivative Works shall not include works that remain separable from, or merely link (or bind by name) to the interfaces of, the Work and Derivative Works thereof.

"Contribution" shall mean any work of authorship, including the original version of the Work and any modifications or additions to that Work or Derivative Works thereof, that is intentionally submitted to Licensor for inclusion in the Work by the copyright owner or by an individual or Legal Entity authorized to submit on behalf of the copyright owner. For the purposes of this definition, "submitted" means any form of electronic, verbal, or written communication sent to the Licensor or its representatives, including but not limited to communication on electronic mailing lists, source code control systems, and issue tracking systems that are managed by, or on behalf of, the Licensor for the purpose of discussing and improving the Work, but excluding communication that is conspicuously marked or otherwise designated in writing by the copyright owner as "Not a Contribution."

"Contributor" shall mean Licensor and any individual or Legal Entity on behalf of whom a Contribution has been received by Licensor and subsequently incorporated within the Work.

2. Grant of Copyright License. Subject to the terms and conditions of this License, each Contributor hereby grants to You a perpetual, worldwide, non-exclusive, no-charge, royalty-free, irrevocable copyright license to reproduce, prepare Derivative Works of, publicly display, publicly perform, sublicense, and distribute the Work and such Derivative Works in Source or Object form.

3. Grant of Patent License. Subject to the terms and conditions of

this License, each Contributor hereby grants to You a perpetual, worldwide, non-exclusive, no-charge, royalty-free, irrevocable (except as stated in this section) patent license to make, have made, use, offer to sell, sell, import, and otherwise transfer the Work, where such license applies only to those patent claims licensable by such Contributor that are necessarily infringed by their Contribution(s) alone or by combination of their Contribution(s) with the Work to which such Contribution(s) was submitted. If You institute patent litigation against any entity (including a cross-claim or counterclaim in a lawsuit) alleging that the Work or a Contribution incorporated within the Work constitutes direct or contributory patent infringement, then any patent licenses granted to You under this License for that Work shall terminate as of the date such litigation is filed.

4. Redistribution. You may reproduce and distribute copies of the Work or Derivative Works thereof in any medium, with or without modifications, and in Source or Object form, provided that You meet the following conditions:

(a) You must give any other recipients of the Work or Derivative Works a copy of this License; and

(b) You must cause any modified files to carry prominent notices stating that You changed the files; and

(c) You must retain, in the Source form of any Derivative Works that You distribute, all copyright, patent, trademark, and attribution notices from the Source form of the Work, excluding those notices that do not pertain to any part of the Derivative Works; and

(d) If the Work includes a "NOTICE" text file as part of its distribution, then any Derivative Works that You distribute must include a readable copy of the attribution notices contained within such NOTICE file, excluding those notices that do not pertain to any part of the Derivative Works, in at least one of the following places: within a NOTICE text file distributed

as part of the Derivative Works; within the Source form or documentation, if provided along with the Derivative Works; or, within a display generated by the Derivative Works, if and wherever such third-party notices normally appear. The contents of the NOTICE file are for informational purposes only and do not modify the License. You may add Your own attribution notices within Derivative Works that You distribute, alongside or as an addendum to the NOTICE text from the Work, provided that such additional attribution notices cannot be construed as modifying the License.

You may add Your own copyright statement to Your modifications and may provide additional or different license terms and conditions for use, reproduction, or distribution of Your modifications, or for any such Derivative Works as a whole, provided Your use, reproduction, and distribution of the Work otherwise complies with the conditions stated in this License.

5. Submission of Contributions. Unless You explicitly state otherwise, any Contribution intentionally submitted for inclusion in the Work by You to the Licensor shall be under the terms and conditions of this License, without any additional terms or conditions.

Notwithstanding the above, nothing herein shall supersede or modify the terms of any separate license agreement you may have executed with Licensor regarding such Contributions.

6. Trademarks. This License does not grant permission to use the trade names, trademarks, service marks, or product names of the Licensor, except as required for reasonable and customary use in describing the origin of the Work and reproducing the content of the NOTICE file.

7. Disclaimer of Warranty. Unless required by applicable law or agreed to in writing, Licensor provides the Work (and each Contributor provides its Contributions) on an "AS IS" BASIS, WITHOUT WARRANTIES OR CONDITIONS OF ANY KIND, either express or implied, including, without limitation, any warranties or conditions of TITLE, NON-INFRINGEMENT, MERCHANTABILITY, or FITNESS FOR A PARTICULAR PURPOSE. You are solely responsible for determining the

appropriateness of using or redistributing the Work and assume any risks associated with Your exercise of permissions under this License.

8. Limitation of Liability. In no event and under no legal theory, whether in tort (including negligence), contract, or otherwise, unless required by applicable law (such as deliberate and grossly negligent acts) or agreed to in writing, shall any Contributor be liable to You for damages, including any direct, indirect, special, incidental, or consequential damages of any character arising as a result of this License or out of the use or inability to use the Work (including but not limited to damages for loss of goodwill, work stoppage, computer failure or malfunction, or any and all other commercial damages or losses), even if such Contributor has been advised of the possibility of such damages.

9. Accepting Warranty or Additional Liability. While redistributing the Work or Derivative Works thereof, You may choose to offer, and charge a fee for, acceptance of support, warranty, indemnity, or other liability obligations and/or rights consistent with this License. However, in accepting such obligations, You may act only on Your own behalf and on Your sole responsibility, not on behalf of any other Contributor, and only if You agree to indemnify, defend, and hold each Contributor harmless for any liability incurred by, or claims asserted against, such Contributor by reason of your accepting any such warranty or additional liability.

END OF TERMS AND CONDITIONS

APPENDIX: How to apply the Apache License to your work.

To apply the Apache License to your work, attach the following boilerplate notice, with the fields enclosed by brackets "[]" replaced with your own identifying information. (Don't include the brackets!) The text should be enclosed in the appropriate comment syntax for the file format. We also recommend that a file or class name and description of purpose be included on the same "printed page" as the copyright notice for easier identification within third-party archives.

Copyright [yyyy] [name of copyright owner]

Licensed under the Apache License, Version 2.0 (the "License");
you may not use this file except in compliance with the License.
You may obtain a copy of the License at

<http://www.apache.org/licenses/LICENSE-2.0>

Unless required by applicable law or agreed to in writing, software
distributed under the License is distributed on an "AS IS" BASIS,
WITHOUT WARRANTIES OR CONDITIONS OF ANY KIND, either express or implied.
See the License for the specific language governing permissions and
limitations under the License.

25.Paho MQTT Client

Eclipse Distribution License – v 1.0

Copyright (c) 2007, Eclipse Foundation, Inc. and its licensors.

All rights reserved.

Redistribution and use in source and binary forms, with or without modification, are permitted provided that the following conditions are met:

- Redistributions of source code must retain the above copyright notice, this list of conditions and the following disclaimer.
- Redistributions in binary form must reproduce the above copyright notice, this list of conditions and the following disclaimer in the documentation and/or other materials provided with the distribution.
- Neither the name of the Eclipse Foundation, Inc. nor the names of its contributors may be used to endorse or promote products derived from this software without specific prior written permission.

THIS SOFTWARE IS PROVIDED BY THE COPYRIGHT HOLDERS AND CONTRIBUTORS "AS IS" AND ANY EXPRESS OR IMPLIED WARRANTIES, INCLUDING, BUT NOT LIMITED TO, THE IMPLIED WARRANTIES OF MERCHANTABILITY AND FITNESS FOR A PARTICULAR PURPOSE ARE DISCLAIMED. IN NO EVENT SHALL THE COPYRIGHT OWNER OR CONTRIBUTORS BE LIABLE FOR ANY DIRECT, INDIRECT, INCIDENTAL, SPECIAL, EXEMPLARY, OR CONSEQUENTIAL DAMAGES (INCLUDING, BUT NOT LIMITED TO, PROCUREMENT OF SUBSTITUTE GOODS OR SERVICES; LOSS OF USE, DATA, OR PROFITS; OR BUSINESS INTERRUPTION) HOWEVER CAUSED AND ON ANY THEORY OF LIABILITY, WHETHER IN CONTRACT, STRICT LIABILITY, OR TORT (INCLUDING NEGLIGENCE OR OTHERWISE) ARISING IN ANY WAY OUT OF THE USE OF THIS SOFTWARE, EVEN IF ADVISED OF THE POSSIBILITY OF SUCH DAMAGE.

26.pango (part of OpenTypeCode)

Copyright (C) 2009 Red Hat, Inc.

Copyright (C) 1998–2004 David Turner and Werner Lemberg

Copyright (C) 2004,2007 Red Hat, Inc.

Copyright (C) 2004,2007,2009 Red Hat, Inc.

Copyright (C) 2007,2008,2009 Red Hat, Inc.

Copyright (C) 2007 Chris Wilson

Permission is hereby granted, without written agreement and without license or royalty fees, to use, copy, modify, and distribute this software and its documentation for any purpose, provided that the above copyright notice and the following two paragraphs appear in all copies of this software.

IN NO EVENT SHALL THE COPYRIGHT HOLDER BE LIABLE TO ANY PARTY FOR DIRECT, INDIRECT, SPECIAL, INCIDENTAL, OR CONSEQUENTIAL DAMAGES ARISING OUT OF THE USE OF THIS SOFTWARE AND ITS DOCUMENTATION, EVEN IF THE COPYRIGHT HOLDER HAS BEEN ADVISED OF THE POSSIBILITY OF SUCH DAMAGE.

THE COPYRIGHT HOLDER SPECIFICALLY DISCLAIMS ANY WARRANTIES, INCLUDING, BUT NOT LIMITED TO, THE IMPLIED WARRANTIES OF MERCHANTABILITY AND FITNESS FOR A PARTICULAR PURPOSE. THE SOFTWARE PROVIDED HEREUNDER IS ON AN "AS IS" BASIS, AND THE COPYRIGHT HOLDER HAS NO OBLIGATION TO PROVIDE MAINTENANCE, SUPPORT, UPDATES, ENHANCEMENTS, OR MODIFICATIONS.

27.pixman

The following is the 'standard copyright' agreed upon by most contributors, and is currently the canonical license, though a modification is currently under discussion. Copyright holders of new code should use this license statement where possible, and append their name to this list.

Copyright 1987, 1988, 1989, 1998 The Open Group

Copyright 1987, 1988, 1989 Digital Equipment Corporation

Copyright 1999, 2004, 2008 Keith Packard

Copyright 2000 SuSE, Inc.

Copyright 2000 Keith Packard, member of The XFree86 Project, Inc.

Copyright 2004, 2005, 2007, 2008 Red Hat, Inc.

Copyright 2004 Nicholas Miell

Copyright 2005 Lars Knoll & Zack Rusin, Trolltech

Copyright 2005 Trolltech AS

Copyright 2007 Luca Barbato

Copyright 2008 Aaron Plattner, NVIDIA Corporation

Copyright 2008 Rodrigo Kumpera

Copyright 2008 André Tupinambá

Copyright 2008 Mozilla Corporation

Copyright 2008 Frederic Plourde

Copyright 2009 Sun Microsystems, Inc.

Permission is hereby granted, free of charge, to any person obtaining a copy of this software and associated documentation files (the "Software"), to deal in the Software without restriction, including without limitation the rights to use, copy, modify, merge, publish, distribute, sublicense, and/or sell copies of the Software, and to permit persons to whom the Software is furnished to do so, subject to the following conditions:

The above copyright notice and this permission notice (including the next paragraph) shall be included in all copies or substantial portions of the Software.

THE SOFTWARE IS PROVIDED "AS IS", WITHOUT WARRANTY OF ANY KIND, EXPRESS OR IMPLIED, INCLUDING BUT NOT LIMITED TO THE WARRANTIES OF MERCHANTABILITY,

FITNESS FOR A PARTICULAR PURPOSE AND NONINFRINGEMENT. IN NO EVENT SHALL THE AUTHORS OR COPYRIGHT HOLDERS BE LIABLE FOR ANY CLAIM, DAMAGES OR OTHER LIABILITY, WHETHER IN AN ACTION OF CONTRACT, TORT OR OTHERWISE, ARISING FROM, OUT OF OR IN CONNECTION WITH THE SOFTWARE OR THE USE OR OTHER DEALINGS IN THE SOFTWARE.

28.Protocol Buffers

Copyright 2008, Google Inc.

All rights reserved.

Redistribution and use in source and binary forms, with or without modification, are permitted provided that the following conditions are met:

- * Redistributions of source code must retain the above copyright notice, this list of conditions and the following disclaimer.

- * Redistributions in binary form must reproduce the above copyright notice, this list of conditions and the following disclaimer in the documentation and/or other materials provided with the distribution.

- * Neither the name of Google Inc. nor the names of its contributors may be used to endorse or promote products derived from this software without specific prior written permission.

THIS SOFTWARE IS PROVIDED BY THE COPYRIGHT HOLDERS AND CONTRIBUTORS "AS IS" AND ANY EXPRESS OR IMPLIED WARRANTIES, INCLUDING, BUT NOT LIMITED TO, THE IMPLIED WARRANTIES OF MERCHANTABILITY AND FITNESS FOR A PARTICULAR PURPOSE ARE DISCLAIMED. IN NO EVENT SHALL THE COPYRIGHT OWNER OR CONTRIBUTORS BE LIABLE FOR ANY DIRECT, INDIRECT, INCIDENTAL, SPECIAL, EXEMPLARY, OR CONSEQUENTIAL DAMAGES (INCLUDING, BUT NOT LIMITED TO, PROCUREMENT OF SUBSTITUTE GOODS OR SERVICES; LOSS OF USE, DATA, OR PROFITS; OR BUSINESS INTERRUPTION) HOWEVER CAUSED AND ON ANY THEORY OF LIABILITY, WHETHER IN CONTRACT, STRICT LIABILITY, OR TORT (INCLUDING NEGLIGENCE OR OTHERWISE) ARISING IN ANY WAY OUT OF THE USE OF THIS SOFTWARE, EVEN IF ADVISED OF THE POSSIBILITY OF SUCH DAMAGE.

Code generated by the Protocol Buffer compiler is owned by the owner of the input file used when generating it. This code is not standalone and requires a support library to be linked with it. This support library is itself covered by the above license.

29.servlet.jar

Apache License

Version 2.0, January 2004

<http://www.apache.org/licenses/>

TERMS AND CONDITIONS FOR USE, REPRODUCTION, AND DISTRIBUTION

1. Definitions.

"License" shall mean the terms and conditions for use, reproduction, and distribution as defined by Sections 1 through 9 of this document.

"Licensor" shall mean the copyright owner or entity authorized by the copyright owner that is granting the License.

"Legal Entity" shall mean the union of the acting entity and all other entities that control, are controlled by, or are under common control with that entity. For the purposes of this definition, "control" means (i) the power, direct or indirect, to cause the direction or management of such entity, whether by contract or otherwise, or (ii) ownership of fifty percent (50%) or more of the outstanding shares, or (iii) beneficial ownership of such entity.

"You" (or "Your") shall mean an individual or Legal Entity exercising permissions granted by this License.

"Source" form shall mean the preferred form for making modifications, including but not limited to software source code, documentation source, and configuration files.

"Object" form shall mean any form resulting from mechanical transformation or translation of a Source form, including but not limited to compiled object code, generated documentation, and conversions to other media types.

"Work" shall mean the work of authorship, whether in Source or Object form, made available under the License, as indicated by a copyright notice that is included in or attached to the work (an example is provided in the Appendix below).

"Derivative Works" shall mean any work, whether in Source or Object form, that is based on (or derived from) the Work and for which the editorial revisions, annotations, elaborations, or other modifications represent, as a whole, an original work of authorship. For the purposes of this License, Derivative Works shall not include works that remain separable from, or merely link (or bind by name) to the interfaces of, the Work and Derivative Works thereof.

"Contribution" shall mean any work of authorship, including the original version of the Work and any modifications or additions to that Work or Derivative Works thereof, that is intentionally submitted to Licensor for inclusion in the Work by the copyright owner or by an individual or Legal Entity authorized to submit on behalf of the copyright owner. For the purposes of this definition, "submitted" means any form of electronic, verbal, or written communication sent to the Licensor or its representatives, including but not limited to communication on electronic mailing lists, source

code control systems, and issue tracking systems that are managed by, or on behalf of, the Licensor for the purpose of discussing and improving the Work, but excluding communication that is conspicuously marked or otherwise designated in writing by the copyright owner as "Not a Contribution."

"Contributor" shall mean Licensor and any individual or Legal Entity on behalf of whom a Contribution has been received by Licensor and subsequently incorporated within the Work.

2. Grant of Copyright License.

Subject to the terms and conditions of this License, each Contributor hereby grants to You a perpetual, worldwide, non-exclusive, no-charge, royalty-free, irrevocable copyright license to reproduce, prepare Derivative Works of, publicly display, publicly perform, sublicense, and distribute the Work and such Derivative Works in Source or Object form.

3. Grant of Patent License.

Subject to the terms and conditions of this License, each Contributor hereby grants to You a perpetual, worldwide, non-exclusive, no-charge, royalty-free, irrevocable (except as stated in this section) patent license to make, have made, use, offer to sell, sell, import, and otherwise transfer the Work, where such license applies only to those patent claims licensable by such Contributor that are necessarily infringed by their Contribution(s) alone or by combination of their Contribution(s) with the Work to which such Contribution(s) was submitted. If You institute patent litigation against any entity (including a cross-claim or counterclaim in a lawsuit) alleging that the Work or a Contribution incorporated within the Work constitutes direct or contributory patent infringement, then any patent licenses granted to You under this License for that Work shall terminate as of the date such litigation is filed.

4. Redistribution.

You may reproduce and distribute copies of the Work or Derivative Works thereof in any medium, with or without modifications, and in Source or Object form, provided that You meet the following conditions:

You must give any other recipients of the Work or Derivative Works a copy of this License; and

You must cause any modified files to carry prominent notices stating that You changed the files; and

You must retain, in the Source form of any Derivative Works that You distribute, all copyright, patent, trademark, and attribution notices from the Source form of the Work, excluding those notices that do not pertain to any part of the Derivative Works; and

If the Work includes a "NOTICE" text file as part of its distribution, then any Derivative Works that You distribute must include a readable copy of the attribution notices contained within such NOTICE file, excluding those notices that do not pertain to any part of the Derivative Works, in at least one of the following places: within a NOTICE text file distributed as part of the Derivative Works; within the Source form or documentation, if provided along with the Derivative Works; or, within a display generated by the Derivative Works, if and wherever such third-party notices normally appear. The contents of the NOTICE file are for informational purposes only and do not modify the License. You

may add Your own attribution notices within Derivative Works that You distribute, alongside or as an addendum to the NOTICE text from the Work, provided that such additional attribution notices cannot be construed as modifying the License.

You may add Your own copyright statement to Your modifications and may provide additional or different license terms and conditions for use, reproduction, or distribution of Your modifications, or for any such Derivative Works as a whole, provided Your use, reproduction, and distribution of the Work otherwise complies with the conditions stated in this License.

5. Submission of Contributions.

Unless You explicitly state otherwise, any Contribution intentionally submitted for inclusion in the Work by You to the Licensor shall be under the terms and conditions of this License, without any additional terms or conditions. Notwithstanding the above, nothing herein shall supersede or modify the terms of any separate license agreement you may have executed with Licensor regarding such Contributions.

6. Trademarks.

This License does not grant permission to use the trade names, trademarks, service marks, or product names of the Licensor, except as required for reasonable and customary use in describing the origin of the Work and reproducing the content of the NOTICE file.

7. Disclaimer of Warranty.

Unless required by applicable law or agreed to in writing, Licensor provides the Work (and each Contributor provides its Contributions) on an "AS IS" BASIS, WITHOUT WARRANTIES OR CONDITIONS OF ANY KIND, either express or implied, including, without limitation, any warranties or conditions of TITLE, NON-INFRINGEMENT, MERCHANTABILITY, or FITNESS FOR A PARTICULAR PURPOSE. You are solely responsible for determining the appropriateness of using or redistributing the Work and assume any risks associated with Your exercise of permissions under this License.

8. Limitation of Liability.

In no event and under no legal theory, whether in tort (including negligence), contract, or otherwise, unless required by applicable law (such as deliberate and grossly negligent acts) or agreed to in writing, shall any Contributor be liable to You for damages, including any direct, indirect, special, incidental, or consequential damages of any character arising as a result of this License or out of the use or inability to use the Work (including but not limited to damages for loss of goodwill, work stoppage, computer failure or malfunction, or any and all other commercial damages or losses), even if such Contributor has been advised of the possibility of such damages.

9. Accepting Warranty or Additional Liability.

While redistributing the Work or Derivative Works thereof, You may choose to offer, and charge a fee for, acceptance of support, warranty, indemnity, or other liability obligations and/or rights consistent with this License. However, in accepting such obligations, You may act only on Your own behalf and on Your sole responsibility, not on behalf of any other Contributor, and only if You agree to indemnify, defend, and hold each Contributor harmless for any liability incurred by, or claims asserted against,

such Contributor by reason of your accepting any such warranty or additional liability.

END OF TERMS AND CONDITIONS

APPENDIX: How to apply the Apache License to your work

To apply the Apache License to your work, attach the following boilerplate notice, with the fields enclosed by brackets "[]" replaced with your own identifying information. (Don't include the brackets!) The text should be enclosed in the appropriate comment syntax for the file format. We also recommend that a file or class name and description of purpose be included on the same "printed page" as the copyright notice for easier identification within third-party archives.

Copyright [yyyy] [name of copyright owner]

Licensed under the Apache License, Version 2.0 (the "License");
you may not use this file except in compliance with the License.
You may obtain a copy of the License at

<http://www.apache.org/licenses/LICENSE-2.0>

Unless required by applicable law or agreed to in writing, software
distributed under the License is distributed on an "AS IS" BASIS,
WITHOUT WARRANTIES OR CONDITIONS OF ANY KIND, either express or implied.
See the License for the specific language governing permissions and
limitations under the License.

30.Wi-Fi Test Suite

The ISC License

Copyright (c) 2015 Wi-Fi Alliance

Permission to use, copy, modify, and/or distribute this software for any purpose with or without fee is hereby granted, provided that the above copyright notice and this permission notice appear in all copies.

THE SOFTWARE IS PROVIDED "AS IS" AND THE AUTHOR DISCLAIMS ALL WARRANTIES WITH REGARD TO THIS SOFTWARE INCLUDING ALL IMPLIED WARRANTIES OF MERCHANTABILITY AND FITNESS. IN NO EVENT SHALL THE AUTHOR BE LIABLE FOR ANY SPECIAL, DIRECT, INDIRECT, OR CONSEQUENTIAL DAMAGES OR ANY DAMAGES WHATSOEVER RESULTING FROM LOSS OF USE, DATA OR PROFITS, WHETHER IN AN ACTION OF CONTRACT, NEGLIGENCE OR OTHER TORTIOUS ACTION, ARISING OUT OF OR IN CONNECTION WITH THE USE OR PERFORMANCE OF THIS SOFTWARE.

31.wpa_supplicant-2.6

wpa_supplicant and hostapd

Copyright (c) 2002-2016, Jouni Malinen <j@w1.fi> and contributors
All Rights Reserved.

These programs are licensed under the BSD license (the one with
advertisement clause removed).

If you are submitting changes to the project, please see CONTRIBUTIONS
file for more instructions.

This package may include either wpa_supplicant, hostapd, or both. See
README file respective subdirectories (wpa_supplicant/README or
hostapd/README) for more details.

Source code files were moved around in v0.6.x releases and compared to
earlier releases, the programs are now built by first going to a
subdirectory (wpa_supplicant or hostapd) and creating build
configuration (.config) and running 'make' there (for Linux/BSD/cygwin
builds).

License

This software may be distributed, used, and modified under the terms of
BSD license:

Redistribution and use in source and binary forms, with or without
modification, are permitted provided that the following conditions are
met:

1. Redistributions of source code must retain the above copyright

notice, this list of conditions and the following disclaimer.

2. Redistributions in binary form must reproduce the above copyright notice, this list of conditions and the following disclaimer in the documentation and/or other materials provided with the distribution.
3. Neither the name(s) of the above-listed copyright holder(s) nor the names of its contributors may be used to endorse or promote products derived from this software without specific prior written permission.

THIS SOFTWARE IS PROVIDED BY THE COPYRIGHT HOLDERS AND CONTRIBUTORS "AS IS" AND ANY EXPRESS OR IMPLIED WARRANTIES, INCLUDING, BUT NOT LIMITED TO, THE IMPLIED WARRANTIES OF MERCHANTABILITY AND FITNESS FOR A PARTICULAR PURPOSE ARE DISCLAIMED. IN NO EVENT SHALL THE COPYRIGHT OWNER OR CONTRIBUTORS BE LIABLE FOR ANY DIRECT, INDIRECT, INCIDENTAL, SPECIAL, EXEMPLARY, OR CONSEQUENTIAL DAMAGES (INCLUDING, BUT NOT LIMITED TO, PROCUREMENT OF SUBSTITUTE GOODS OR SERVICES; LOSS OF USE, DATA, OR PROFITS; OR BUSINESS INTERRUPTION) HOWEVER CAUSED AND ON ANY THEORY OF LIABILITY, WHETHER IN CONTRACT, STRICT LIABILITY, OR TORT (INCLUDING NEGLIGENCE OR OTHERWISE) ARISING IN ANY WAY OUT OF THE USE OF THIS SOFTWARE, EVEN IF ADVISED OF THE POSSIBILITY OF SUCH DAMAGE.

32.X Window System

Copyright 1984 – 1996, 1998, 2002 The Open Group

Permission to use, copy, modify, distribute, and sell this software and its documentation for any purpose is hereby granted without fee, provided that the above copyright notice appear in all copies and that both that copyright notice and this permission notice appear in supporting documentation.

The above copyright notice and this permission notice shall be included in all copies or substantial portions of the Software.

THE SOFTWARE IS PROVIDED "AS IS", WITHOUT WARRANTY OF ANY KIND, EXPRESS OR IMPLIED, INCLUDING BUT NOT LIMITED TO THE WARRANTIES OF MERCHANTABILITY, FITNESS FOR A PARTICULAR PURPOSE AND NONINFRINGEMENT. IN NO EVENT SHALL THE OPEN GROUP BE LIABLE FOR ANY CLAIM, DAMAGES OR OTHER LIABILITY, WHETHER IN AN ACTION OF CONTRACT, TORT OR OTHERWISE, ARISING FROM, OUT OF OR IN CONNECTION WITH THE SOFTWARE OR THE USE OR OTHER DEALINGS IN THE SOFTWARE.

Except as contained in this notice, the name of The Open Group shall not be used in advertising or otherwise to promote the sale, use or other dealings in this Software without prior written authorization from The Open Group.

Copyright (c) 1991, 2002, 2004 – 2009 Oracle and/or its affiliates. All rights reserved.

Permission is hereby granted, free of charge, to any person obtaining a copy of this software and associated documentation files (the "Software"), to deal in the Software without restriction, including without limitation the rights to use, copy, modify, merge, publish, distribute, sublicense, and/or sell copies of the Software, and to permit persons to whom the Software is furnished to do so, subject to the following conditions:

The above copyright notice and this permission notice (including the next paragraph) shall be included in all copies or substantial portions of the Software.

THE SOFTWARE IS PROVIDED "AS IS", WITHOUT WARRANTY OF ANY KIND, EXPRESS OR IMPLIED, INCLUDING BUT NOT LIMITED TO THE WARRANTIES OF MERCHANTABILITY, FITNESS FOR A PARTICULAR PURPOSE AND NONINFRINGEMENT. IN NO EVENT SHALL THE AUTHORS OR COPYRIGHT HOLDERS BE LIABLE FOR ANY CLAIM, DAMAGES OR OTHER LIABILITY, WHETHER IN AN ACTION OF CONTRACT, TORT OR OTHERWISE, ARISING FROM, OUT OF OR IN CONNECTION WITH THE SOFTWARE OR THE USE OR OTHER DEALINGS IN THE SOFTWARE.

Copyright © 1999 – 2001, 2003, 2004, 2008 Keith Packard

Permission to use, copy, modify, distribute, and sell this software and its documentation for any purpose is hereby granted without fee, provided that the above copyright notice appear in all copies and that both that copyright notice and this permission notice appear in supporting documentation, and that the name of Keith Packard not be used in advertising or publicity pertaining to distribution of the software without specific, written prior permission. Keith Packard makes no representations about the suitability of this software for any purpose. It is provided "as is" without express or implied warranty.

KEITH PACKARD DISCLAIMS ALL WARRANTIES WITH REGARD TO THIS SOFTWARE, INCLUDING ALL IMPLIED WARRANTIES OF MERCHANTABILITY AND FITNESS, IN NO EVENT SHALL KEITH PACKARD BE LIABLE FOR ANY SPECIAL, INDIRECT OR CONSEQUENTIAL DAMAGES OR ANY DAMAGES WHATSOEVER RESULTING FROM LOSS OF USE, DATA OR PROFITS, WHETHER IN AN ACTION OF CONTRACT, NEGLIGENCE OR OTHER TORTIOUS ACTION, ARISING OUT OF OR IN CONNECTION WITH THE USE OR PERFORMANCE OF THIS SOFTWARE.

Copyright © 2001,2003 Keith Packard

Copyright © 2007 Eric Anholt

Permission to use, copy, modify, distribute, and sell this software and its documentation for any purpose is hereby granted without fee, provided that the above copyright notice appear in all copies and that both that copyright notice and this permission notice appear in supporting documentation, and that the name of Keith Packard not be used in

advertising or publicity pertaining to distribution of the software without specific, written prior permission. Keith Packard makes no representations about the suitability of this software for any purpose. It is provided "as is" without express or implied warranty.

KEITH PACKARD DISCLAIMS ALL WARRANTIES WITH REGARD TO THIS SOFTWARE, INCLUDING ALL IMPLIED WARRANTIES OF MERCHANTABILITY AND FITNESS, IN NO EVENT SHALL KEITH PACKARD BE LIABLE FOR ANY SPECIAL, INDIRECT OR CONSEQUENTIAL DAMAGES OR ANY DAMAGES WHATSOEVER RESULTING FROM LOSS OF USE, DATA OR PROFITS, WHETHER IN AN ACTION OF CONTRACT, NEGLIGENCE OR OTHER TORTIOUS ACTION, ARISING OUT OF OR IN CONNECTION WITH THE USE OR PERFORMANCE OF THIS SOFTWARE.

Copyright © 2007, 2009 Red Hat, Inc.

Permission is hereby granted, free of charge, to any person obtaining a copy of this software and associated documentation files (the "Software"), to deal in the Software without restriction, including without limitation the rights to use, copy, modify, merge, publish, distribute, and/or sell copies of the Software, and to permit persons to whom the Software is furnished to do so, provided that the above copyright notice(s) and this permission notice appear in all copies of the Software and that both the above copyright notice(s) and this permission notice appear in supporting documentation.

THE SOFTWARE IS PROVIDED "AS IS", WITHOUT WARRANTY OF ANY KIND, EXPRESS OR IMPLIED, INCLUDING BUT NOT LIMITED TO THE WARRANTIES OF MERCHANTABILITY, FITNESS FOR A PARTICULAR PURPOSE AND NONINFRINGEMENT OF THIRD PARTY RIGHTS. IN NO EVENT SHALL THE COPYRIGHT HOLDER OR HOLDERS INCLUDED IN THIS NOTICE BE LIABLE FOR ANY CLAIM, OR ANY SPECIAL INDIRECT OR CONSEQUENTIAL DAMAGES, OR ANY DAMAGES WHATSOEVER RESULTING FROM LOSS OF USE, DATA OR PROFITS, WHETHER IN AN ACTION OF CONTRACT, NEGLIGENCE OR OTHER TORTIOUS ACTION, ARISING OUT OF OR IN CONNECTION WITH THE USE OR PERFORMANCE OF THIS SOFTWARE.

Except as contained in this notice, the name of a copyright holder shall not be used in advertising or otherwise to promote the sale, use or

other dealings in this Software without prior written authorization of the copyright holder.

Copyright 1990, 1991 Network Computing Devices;
Portions Copyright 1987 by Digital Equipment Corporation

Permission to use, copy, modify, distribute, and sell this software and its documentation for any purpose is hereby granted without fee, provided that the above copyright notice appear in all copies and that both that copyright notice and this permission notice appear in supporting documentation, and that the names of Network Computing Devices or Digital not be used in advertising or publicity pertaining to distribution of the software without specific, written prior permission.

Network Computing Devices and Digital make no representations about the suitability of this software for any purpose. It is provided "as is" without express or implied warranty.

NETWORK COMPUTING DEVICES AND DIGITAL DISCLAIM ALL WARRANTIES WITH REGARD TO THIS SOFTWARE, INCLUDING ALL IMPLIED WARRANTIES OF MERCHANTABILITY AND FITNESS, IN NO EVENT SHALL NETWORK COMPUTING DEVICES OR DIGITAL BE LIABLE FOR ANY SPECIAL, INDIRECT OR CONSEQUENTIAL DAMAGES OR ANY DAMAGES WHATSOEVER RESULTING FROM LOSS OF USE, DATA OR PROFITS, WHETHER IN AN ACTION OF CONTRACT, NEGLIGENCE OR OTHER TORTIOUS ACTION, ARISING OUT OF OR IN CONNECTION WITH THE USE OR PERFORMANCE OF THIS SOFTWARE.

Copyright 1987 - 1991, 1993, 1996, 1997 by Digital Equipment Corporation, Maynard, Massachusetts.
All Rights Reserved

Permission to use, copy, modify, and distribute this software and its documentation for any purpose and without fee is hereby granted, provided that the above copyright notice appear in all copies and that both that copyright notice and this permission notice appear in supporting documentation, and that the name of Digital not be used in advertising or publicity pertaining to distribution of the software without specific, written prior permission.

DIGITAL DISCLAIMS ALL WARRANTIES WITH REGARD TO THIS SOFTWARE, INCLUDING ALL IMPLIED WARRANTIES OF MERCHANTABILITY AND FITNESS, IN NO EVENT SHALL DIGITAL BE LIABLE FOR ANY SPECIAL, INDIRECT OR CONSEQUENTIAL DAMAGES OR ANY DAMAGES WHATSOEVER RESULTING FROM LOSS OF USE, DATA OR PROFITS, WHETHER IN AN ACTION OF CONTRACT, NEGLIGENCE OR OTHER TORTIOUS ACTION, ARISING OUT OF OR IN CONNECTION WITH THE USE OR PERFORMANCE OF THIS SOFTWARE.

Copyright (c) 1997, 1999 – 2003 The XFree86 Project Inc.
All Rights Reserved.

The above copyright notice and this permission notice shall be included in all copies or substantial portions of the Software.

THE SOFTWARE IS PROVIDED "AS IS", WITHOUT WARRANTY OF ANY KIND, EXPRESS OR IMPLIED, INCLUDING BUT NOT LIMITED TO THE WARRANTIES OF MERCHANTABILITY, FITNESS FOR A PARTICULAR PURPOSE AND NONINFRINGEMENT. IN NO EVENT SHALL THE OPEN GROUP BE LIABLE FOR ANY CLAIM, DAMAGES OR OTHER LIABILITY, WHETHER IN AN ACTION OF CONTRACT, TORT OR OTHERWISE, ARISING FROM, OUT OF OR IN CONNECTION WITH THE SOFTWARE OR THE USE OR OTHER DEALINGS IN THE SOFTWARE.

Except as contained in this notice, the name of The XFree86 Project Inc. shall not be used in advertising or otherwise to promote the sale, use or other dealings in this Software without prior written authorization from The XFree86 Project Inc..

Copyright (C) 1991–2000 Silicon Graphics, Inc. All Rights Reserved.

Permission is hereby granted, free of charge, to any person obtaining a copy of this software and associated documentation files (the "Software"), to deal in the Software without restriction, including without limitation the rights to use, copy, modify, merge, publish, distribute, sublicense, and/or sell copies of the Software, and to permit persons to whom the Software is furnished to do so, subject to the following conditions:

The above copyright notice including the dates of first publication and

either this permission notice or a reference to
<http://oss.sgi.com/projects/FreeB/>
shall be included in all copies or substantial portions of the Software.

THE SOFTWARE IS PROVIDED "AS IS", WITHOUT WARRANTY OF ANY KIND, EXPRESS OR IMPLIED, INCLUDING BUT NOT LIMITED TO THE WARRANTIES OF MERCHANTABILITY, FITNESS FOR A PARTICULAR PURPOSE AND NONINFRINGEMENT. IN NO EVENT SHALL SILICON GRAPHICS, INC. BE LIABLE FOR ANY CLAIM, DAMAGES OR OTHER LIABILITY, WHETHER IN AN ACTION OF CONTRACT, TORT OR OTHERWISE, ARISING FROM, OUT OF OR IN CONNECTION WITH THE SOFTWARE OR THE USE OR OTHER DEALINGS IN THE SOFTWARE.

Except as contained in this notice, the name of Silicon Graphics, Inc. shall not be used in advertising or otherwise to promote the sale, use or other dealings in this Software without prior written authorization from Silicon Graphics, Inc.

Copyright 1984 - 1989, 1994, 1995 by Hewlett-Packard Company
All Rights Reserved

Permission to use, copy, modify, and distribute this software and its documentation for any purpose and without fee is hereby granted, provided that the above copyright notice appear in all copies and that both that copyright notice and this permission notice appear in supporting documentation, and that the name of Hewlett-Packard not be used in advertising or publicity pertaining to distribution of the software without specific, written prior permission.

HEWLETT-PACKARD DISCLAIMS ALL WARRANTIES WITH REGARD TO THIS SOFTWARE, INCLUDING ALL IMPLIED WARRANTIES OF MERCHANTABILITY AND FITNESS, IN NO EVENT SHALL HEWLETT-PACKARD BE LIABLE FOR ANY SPECIAL, INDIRECT OR CONSEQUENTIAL DAMAGES OR ANY DAMAGES WHATSOEVER RESULTING FROM LOSS OF USE, DATA OR PROFITS, WHETHER IN AN ACTION OF CONTRACT, NEGLIGENCE OR OTHER TORTIOUS ACTION, ARISING OUT OF OR IN CONNECTION WITH THE USE OR PERFORMANCE OF THIS SOFTWARE.

Except as contained in this notice, the name of the Hewlett-Packard

Company shall not be used in advertising or otherwise to promote the sale, use or other dealings in this Software without prior written authorization from the Hewlett-Packard Company.

Copyright (c) 1993 – 1997 by Silicon Graphics Computer Systems, Inc.

Permission to use, copy, modify, and distribute this software and its documentation for any purpose and without fee is hereby granted, provided that the above copyright notice appear in all copies and that both that copyright notice and this permission notice appear in supporting documentation, and that the name of Silicon Graphics not be used in advertising or publicity pertaining to distribution of the software without specific prior written permission. Silicon Graphics makes no representation about the suitability of this software for any purpose. It is provided "as is" without any express or implied warranty.

SILICON GRAPHICS DISCLAIMS ALL WARRANTIES WITH REGARD TO THIS SOFTWARE, INCLUDING ALL IMPLIED WARRANTIES OF MERCHANTABILITY AND FITNESS FOR A PARTICULAR PURPOSE. IN NO EVENT SHALL SILICON GRAPHICS BE LIABLE FOR ANY SPECIAL, INDIRECT OR CONSEQUENTIAL DAMAGES OR ANY DAMAGES WHATSOEVER RESULTING FROM LOSS OF USE, DATA OR PROFITS, WHETHER IN AN ACTION OF CONTRACT, NEGLIGENCE OR OTHER TORTIOUS ACTION, ARISING OUT OF OR IN CONNECTION WITH THE USE OR PERFORMANCE OF THIS SOFTWARE.

Copyright (c) 1998–2001 by Juliusz Chroboczek

Permission is hereby granted, free of charge, to any person obtaining a copy of this software and associated documentation files (the "Software"), to deal in the Software without restriction, including without limitation the rights to use, copy, modify, merge, publish, distribute, sublicense, and/or sell copies of the Software, and to permit persons to whom the Software is furnished to do so, subject to the following conditions:

The above copyright notice and this permission notice shall be included in all copies or substantial portions of the Software.

THE SOFTWARE IS PROVIDED "AS IS", WITHOUT WARRANTY OF ANY KIND, EXPRESS OR IMPLIED, INCLUDING BUT NOT LIMITED TO THE WARRANTIES OF MERCHANTABILITY, FITNESS FOR A PARTICULAR PURPOSE AND NONINFRINGEMENT. IN NO EVENT SHALL THE AUTHORS OR COPYRIGHT HOLDERS BE LIABLE FOR ANY CLAIM, DAMAGES OR OTHER LIABILITY, WHETHER IN AN ACTION OF CONTRACT, TORT OR OTHERWISE, ARISING FROM, OUT OF OR IN CONNECTION WITH THE SOFTWARE OR THE USE OR OTHER DEALINGS IN THE SOFTWARE.

(C) Copyright IBM Corporation 2006, 2007

(C) Copyright Eric Anholt 2006

Copyright 2007, 2008, 2009 Sun Microsystems, Inc.

Copyright 2009 Red Hat, Inc.

All Rights Reserved.

Permission is hereby granted, free of charge, to any person obtaining a copy of this software and associated documentation files (the "Software"), to deal in the Software without restriction, including without limitation on the rights to use, copy, modify, merge, publish, distribute, sub license, and/or sell copies of the Software, and to permit persons to whom the Software is furnished to do so, subject to the following conditions:

The above copyright notice and this permission notice (including the next paragraph) shall be included in all copies or substantial portions of the Software.

THE SOFTWARE IS PROVIDED "AS IS", WITHOUT WARRANTY OF ANY KIND, EXPRESS OR IMPLIED, INCLUDING BUT NOT LIMITED TO THE WARRANTIES OF MERCHANTABILITY, FITNESS FOR A PARTICULAR PURPOSE AND NON-INFRINGEMENT. IN NO EVENT SHALL IBM AND/OR THEIR SUPPLIERS BE LIABLE FOR ANY CLAIM, DAMAGES OR OTHER LIABILITY, WHETHER IN AN ACTION OF CONTRACT, TORT OR OTHERWISE, ARISING FROM, OUT OF OR IN CONNECTION WITH THE SOFTWARE OR THE USE OR OTHER DEALINGS IN THE SOFTWARE.

Copyright (c) 2008 Juan Romero Pardines

Copyright (c) 2008 Mark Kettenis

Permission to use, copy, modify, and distribute this software for any purpose with or without fee is hereby granted, provided that the above copyright notice and this permission notice appear in all copies.

THE SOFTWARE IS PROVIDED "AS IS" AND THE AUTHOR DISCLAIMS ALL WARRANTIES WITH REGARD TO THIS SOFTWARE INCLUDING ALL IMPLIED WARRANTIES OF MERCHANTABILITY AND FITNESS. IN NO EVENT SHALL THE AUTHOR BE LIABLE FOR ANY SPECIAL, DIRECT, INDIRECT, OR CONSEQUENTIAL DAMAGES OR ANY DAMAGES WHATSOEVER RESULTING FROM LOSS OF USE, DATA OR PROFITS, WHETHER IN AN ACTION OF CONTRACT, NEGLIGENCE OR OTHER TORTIOUS ACTION, ARISING OUT OF OR IN CONNECTION WITH THE USE OR PERFORMANCE OF THIS SOFTWARE.

Copyright (C) 2003–2006,2008 Jamey Sharp, Josh Triplett

Copyright © 2009 Red Hat, Inc.

Copyright 1990–1992,1999,2000,2004,2009,2010 Oracle and/or its affiliates.

All rights reserved.

Permission is hereby granted, free of charge, to any person obtaining a copy of this software and associated documentation files (the "Software"), to deal in the Software without restriction, including without limitation the rights to use, copy, modify, merge, publish, distribute, sublicense, and/or sell copies of the Software, and to permit persons to whom the Software is furnished to do so, subject to the following conditions:

The above copyright notice and this permission notice (including the next paragraph) shall be included in all copies or substantial portions of the Software.

THE SOFTWARE IS PROVIDED "AS IS", WITHOUT WARRANTY OF ANY KIND, EXPRESS OR IMPLIED, INCLUDING BUT NOT LIMITED TO THE WARRANTIES OF MERCHANTABILITY, FITNESS FOR A PARTICULAR PURPOSE AND NONINFRINGEMENT. IN NO EVENT SHALL THE AUTHORS OR COPYRIGHT HOLDERS BE LIABLE FOR ANY CLAIM, DAMAGES OR OTHER LIABILITY, WHETHER IN AN ACTION OF CONTRACT, TORT OR OTHERWISE, ARISING FROM, OUT OF OR IN CONNECTION WITH THE SOFTWARE OR THE USE OR OTHER

DEALINGS IN THE SOFTWARE.

Copyright 1985, 1986, 1987, 1988, 1989, 1990, 1991, 1994, 1996 X Consortium
Copyright 2000 The XFree86 Project, Inc.

Permission is hereby granted, free of charge, to any person obtaining a copy of this software and associated documentation files (the "Software"), to deal in the Software without restriction, including without limitation the rights to use, copy, modify, merge, publish, distribute, sublicense, and/or sell copies of the Software, and to permit persons to whom the Software is furnished to do so, subject to the following conditions:

The above copyright notice and this permission notice shall be included in all copies or substantial portions of the Software.

THE SOFTWARE IS PROVIDED "AS IS", WITHOUT WARRANTY OF ANY KIND, EXPRESS OR IMPLIED, INCLUDING BUT NOT LIMITED TO THE WARRANTIES OF MERCHANTABILITY, FITNESS FOR A PARTICULAR PURPOSE AND NONINFRINGEMENT. IN NO EVENT SHALL THE X CONSORTIUM BE LIABLE FOR ANY CLAIM, DAMAGES OR OTHER LIABILITY, WHETHER IN AN ACTION OF CONTRACT, TORT OR OTHERWISE, ARISING FROM, OUT OF OR IN CONNECTION WITH THE SOFTWARE OR THE USE OR OTHER DEALINGS IN THE SOFTWARE.

Except as contained in this notice, the name of the X Consortium shall not be used in advertising or otherwise to promote the sale, use or other dealings in this Software without prior written authorization from the X Consortium.

Copyright 1985 – 1991 by Digital Equipment Corporation
Portions Copyright 1990, 1991 by Tektronix, Inc.

Permission to use, copy, modify and distribute this documentation for any purpose and without fee is hereby granted, provided that the above copyright notice appears in all copies and that both that copyright notice and this permission notice appear in all copies, and that the names of

Digital and Tektronix not be used in in advertising or publicity pertaining to this documentation without specific, written prior permission.

Digital and Tektronix makes no representations about the suitability of this documentation for any purpose.

It is provided ``as is" without express or implied warranty.

Copyright (c) 1999 – 2000 Free Software Foundation, Inc.

Permission is hereby granted, free of charge, to any person obtaining a copy of this software and associated documentation files (the "Software"), to deal in the Software without restriction, including without limitation the rights to use, copy, modify, merge, publish, distribute, sublicense, and/or sell copies of the Software, and to permit persons to whom the Software is furnished to do so, subject to the following conditions:

The above copyright notice and this permission notice shall be included in all copies or substantial portions of the Software.

THE SOFTWARE IS PROVIDED "AS IS", WITHOUT WARRANTY OF ANY KIND, EXPRESS OR IMPLIED, INCLUDING BUT NOT LIMITED TO THE WARRANTIES OF MERCHANTABILITY, FITNESS FOR A PARTICULAR PURPOSE AND NONINFRINGEMENT. IN NO EVENT SHALL THE FREE SOFTWARE FOUNDATION BE LIABLE FOR ANY CLAIM, DAMAGES OR OTHER LIABILITY, WHETHER IN AN ACTION OF CONTRACT, TORT OR OTHERWISE, ARISING FROM, OUT OF OR IN CONNECTION WITH THE SOFTWARE OR THE USE OR OTHER DEALINGS IN THE SOFTWARE.

Except as contained in this notice, the name of the Free Software Foundation shall not be used in advertising or otherwise to promote the sale, use or other dealings in this Software without prior written authorization from the Free Software Foundation.

(c) Copyright 1990 1991 Tektronix, Inc.
All Rights Reserved

This file is a component of an X Window System–specific implementation of Xcms based on the TekColor Color Management System. TekColor is a trademark of Tektronix, Inc. The term "TekHVC" designates a particular

color space that is the subject of U.S. Patent No. 4,985,853 (equivalent foreign patents pending). Permission is hereby granted to use, copy, modify, sell, and otherwise distribute this software and its documentation for any purpose and without fee, provided that:

1. This copyright, permission, and disclaimer notice is reproduced in all copies of this software and any modification thereof and in supporting documentation;
2. Any color-handling application which displays TekHVC color coordinates identifies these as TekHVC color coordinates in any interface that displays these coordinates and in any associated documentation;
3. The term "TekHVC" is always used, and is only used, in association with the mathematical derivations of the TekHVC Color Space, including those provided in this file and any equivalent pathways and mathematical derivations, regardless of digital (e.g., floating point or integer) representation.

Tektronix makes no representation about the suitability of this software for any purpose. It is provided "as is" and with all faults.

TEKTRONIX DISCLAIMS ALL WARRANTIES APPLICABLE TO THIS SOFTWARE, INCLUDING THE IMPLIED WARRANTIES OF MERCHANTABILITY AND FITNESS FOR A PARTICULAR PURPOSE. IN NO EVENT SHALL TEKTRONIX BE LIABLE FOR ANY SPECIAL, INDIRECT OR CONSEQUENTIAL DAMAGES OR ANY DAMAGES WHATSOEVER RESULTING FROM LOSS OF USE, DATA, OR PROFITS, WHETHER IN AN ACTION OF CONTRACT, NEGLIGENCE, OR OTHER TORTIOUS ACTION, ARISING OUT OF OR IN CONNECTION WITH THE USE OR THE PERFORMANCE OF THIS SOFTWARE.

Copyright 1992 by Oki Technosystems Laboratory, Inc.

Copyright 1992 by Fuji Xerox Co., Ltd.

Permission to use, copy, modify, distribute, and sell this software and its documentation for any purpose is hereby granted without fee, provided that the above copyright notice appear in all copies and that both that copyright notice and this permission notice appear in supporting documentation, and that the name of Oki Technosystems

Laboratory and Fuji Xerox not be used in advertising or publicity pertaining to distribution of the software without specific, written prior permission.

Oki Technosystems Laboratory and Fuji Xerox make no representations about the suitability of this software for any purpose. It is provided "as is" without express or implied warranty.

OKI TECHNOSYSTEMS LABORATORY AND FUJI XEROX DISCLAIM ALL WARRANTIES WITH REGARD TO THIS SOFTWARE, INCLUDING ALL IMPLIED WARRANTIES OF MERCHANTABILITY AND FITNESS, IN NO EVENT SHALL OKI TECHNOSYSTEMS LABORATORY AND FUJI XEROX BE LIABLE FOR ANY SPECIAL, INDIRECT OR CONSEQUENTIAL DAMAGES OR ANY DAMAGES WHATSOEVER RESULTING FROM LOSS OF USE, DATA OR PROFITS, WHETHER IN AN ACTION OF CONTRACT, NEGLIGENCE OR OTHER TORTIOUS ACTION, ARISING OUT OF OR IN CONNECTION WITH THE USE OR PERFORMANCE OF THIS SOFTWARE.

Copyright 1990 – 1994 by FUJITSU LIMITED

Permission to use, copy, modify, distribute, and sell this software and its documentation for any purpose is hereby granted without fee, provided that the above copyright notice appear in all copies and that both that copyright notice and this permission notice appear in supporting documentation, and that the name of FUJITSU LIMITED not be used in advertising or publicity pertaining to distribution of the software without specific, written prior permission.

FUJITSU LIMITED makes no representations about the suitability of this software for any purpose.

It is provided "as is" without express or implied warranty.

FUJITSU LIMITED DISCLAIM ALL WARRANTIES WITH REGARD TO THIS SOFTWARE, INCLUDING ALL IMPLIED WARRANTIES OF MERCHANTABILITY AND FITNESS, IN NO EVENT SHALL FUJITSU LIMITED BE LIABLE FOR ANY SPECIAL, INDIRECT OR CONSEQUENTIAL DAMAGES OR ANY DAMAGES WHATSOEVER RESULTING FROM LOSS OF USE, DATA OR PROFITS, WHETHER IN AN ACTION OF CONTRACT, NEGLIGENCE OR OTHER TORTIOUS ACTION, ARISING OUT OF OR IN CONNECTION WITH THE USE OR PERFORMANCE OF THIS SOFTWARE.

Copyright (c) 1995 David E. Wexelblat. All rights reserved

Permission is hereby granted, free of charge, to any person obtaining a copy of this software and associated documentation files (the "Software"), to deal in the Software without restriction, including without limitation the rights to use, copy, modify, merge, publish, distribute, sublicense, and/or sell copies of the Software, and to permit persons to whom the Software is furnished to do so, subject to the following conditions:

The above copyright notice and this permission notice shall be included in all copies or substantial portions of the Software.

THE SOFTWARE IS PROVIDED "AS IS", WITHOUT WARRANTY OF ANY KIND, EXPRESS OR IMPLIED, INCLUDING BUT NOT LIMITED TO THE WARRANTIES OF MERCHANTABILITY, FITNESS FOR A PARTICULAR PURPOSE AND NONINFRINGEMENT. IN NO EVENT SHALL DAVID E. WEXELBLAT BE LIABLE FOR ANY CLAIM, DAMAGES OR OTHER LIABILITY, WHETHER IN AN ACTION OF CONTRACT, TORT OR OTHERWISE, ARISING FROM, OUT OF OR IN CONNECTION WITH THE SOFTWARE OR THE USE OR OTHER DEALINGS IN THE SOFTWARE.

Except as contained in this notice, the name of David E. Wexelblat shall not be used in advertising or otherwise to promote the sale, use or other dealings in this Software without prior written authorization from David E. Wexelblat.

Copyright 1990, 1991 by OMRON Corporation

Permission to use, copy, modify, distribute, and sell this software and its documentation for any purpose is hereby granted without fee, provided that the above copyright notice appear in all copies and that both that copyright notice and this permission notice appear in supporting documentation, and that the name OMRON not be used in advertising or publicity pertaining to distribution of the software without specific, written prior permission. OMRON makes no representations about the suitability of this software for any purpose. It is provided

"as is" without express or implied warranty.

OMRON DISCLAIMS ALL WARRANTIES WITH REGARD TO THIS SOFTWARE, INCLUDING ALL IMPLIED WARRANTIES OF MERCHANTABILITY AND FITNESS, IN NO EVENT SHALL OMRON BE LIABLE FOR ANY SPECIAL, INDIRECT OR CONSEQUENTIAL DAMAGES OR ANY DAMAGES WHATSOEVER RESULTING FROM LOSS OF USE, DATA OR PROFITS, WHETHER IN AN ACTION OF CONTRACT, NEGLIGENCE OR OTHER TORTUOUS ACTION, ARISING OUT OF OR IN CONNECTION WITH THE USE OR PERFORMANCE OF THIS SOFTWARE.

Copyright 1985, 1986, 1987, 1988, 1989, 1990, 1991 by
Digital Equipment Corporation
Portions Copyright 1990, 1991 by Tektronix, Inc

Rewritten for X.org by Chris Lee <clee@freedesktop.org>

Permission to use, copy, modify, distribute, and sell this documentation for any purpose and without fee is hereby granted, provided that the above copyright notice and this permission notice appear in all copies.
Chris Lee makes no representations about the suitability for any purpose of the information in this document. It is provided ¥`¥`as-is without express or implied warranty.

Copyright 1993 by Digital Equipment Corporation, Maynard, Massachusetts,
Copyright 1994 by FUJITSU LIMITED
Copyright 1994 by Sony Corporation

All Rights Reserved

Permission to use, copy, modify, and distribute this software and its documentation for any purpose and without fee is hereby granted, provided that the above copyright notice appear in all copies and that both that copyright notice and this permission notice appear in supporting documentation, and that the names of Digital, FUJITSU LIMITED and Sony Corporation not be used in advertising or publicity pertaining to distribution of the software without specific, written

prior permission.

DIGITAL, FUJITSU LIMITED AND SONY CORPORATION DISCLAIMS ALL WARRANTIES WITH REGARD TO THIS SOFTWARE, INCLUDING ALL IMPLIED WARRANTIES OF MERCHANTABILITY AND FITNESS, IN NO EVENT SHALL DIGITAL, FUJITSU LIMITED AND SONY CORPORATION BE LIABLE FOR ANY SPECIAL, INDIRECT OR CONSEQUENTIAL DAMAGES OR ANY DAMAGES WHATSOEVER RESULTING FROM LOSS OF USE, DATA OR PROFITS, WHETHER IN AN ACTION OF CONTRACT, NEGLIGENCE OR OTHER TORTIOUS ACTION, ARISING OUT OF OR IN CONNECTION WITH THE USE OR PERFORMANCE OF THIS SOFTWARE.

Copyright 1991 by the Open Software Foundation

Permission to use, copy, modify, distribute, and sell this software and its documentation for any purpose is hereby granted without fee, provided that the above copyright notice appear in all copies and that both that copyright notice and this permission notice appear in supporting documentation, and that the name of Open Software Foundation not be used in advertising or publicity pertaining to distribution of the software without specific, written prior permission. Open Software Foundation makes no representations about the suitability of this software for any purpose. It is provided "as is" without express or implied warranty.

OPEN SOFTWARE FOUNDATION DISCLAIMS ALL WARRANTIES WITH REGARD TO THIS SOFTWARE, INCLUDING ALL IMPLIED WARRANTIES OF MERCHANTABILITY AND FITNESS, IN NO EVENT SHALL OPEN SOFTWARE FOUNDATION BE LIABLE FOR ANY SPECIAL, INDIRECT OR CONSEQUENTIAL DAMAGES OR ANY DAMAGES WHATSOEVER RESULTING FROM LOSS OF USE, DATA OR PROFITS, WHETHER IN AN ACTION OF CONTRACT, NEGLIGENCE OR OTHER TORTIOUS ACTION, ARISING OUT OF OR IN CONNECTION WITH THE USE OR PERFORMANCE OF THIS SOFTWARE.

Copyright 1990, 1991, 1992, 1993, 1994 by FUJITSU LIMITED

Copyright 1993, 1994 by Sony Corporation

Permission to use, copy, modify, distribute, and sell this software and

its documentation for any purpose is hereby granted without fee, provided that the above copyright notice appear in all copies and that both that copyright notice and this permission notice appear in supporting documentation, and that the name of FUJITSU LIMITED and Sony Corporation not be used in advertising or publicity pertaining to distribution of the software without specific, written prior permission. FUJITSU LIMITED and Sony Corporation makes no representations about the suitability of this software for any purpose. It is provided "as is" without express or implied warranty.

FUJITSU LIMITED AND SONY CORPORATION DISCLAIMS ALL WARRANTIES WITH REGARD TO THIS SOFTWARE, INCLUDING ALL IMPLIED WARRANTIES OF MERCHANTABILITY AND FITNESS, IN NO EVENT SHALL FUJITSU LIMITED OR SONY CORPORATION BE LIABLE FOR ANY SPECIAL, INDIRECT OR CONSEQUENTIAL DAMAGES OR ANY DAMAGES WHATSOEVER RESULTING FROM LOSS OF USE, DATA OR PROFITS, WHETHER IN AN ACTION OF CONTRACT, NEGLIGENCE OR OTHER TORTIOUS ACTION, ARISING OUT OF OR IN CONNECTION WITH THE USE OR PERFORMANCE OF THIS SOFTWARE.

Copyright 1991, 1992, 1993, 1994 by FUJITSU LIMITED

Copyright 1993 by Digital Equipment Corporation

Permission to use, copy, modify, distribute, and sell this software and its documentation for any purpose is hereby granted without fee, provided that the above copyright notice appear in all copies and that both that copyright notice and this permission notice appear in supporting documentation, and that the name of FUJITSU LIMITED and Digital Equipment Corporation not be used in advertising or publicity pertaining to distribution of the software without specific, written prior permission. FUJITSU LIMITED and Digital Equipment Corporation makes no representations about the suitability of this software for any purpose. It is provided "as is" without express or implied warranty.

FUJITSU LIMITED AND DIGITAL EQUIPMENT CORPORATION DISCLAIM ALL WARRANTIES WITH REGARD TO THIS SOFTWARE, INCLUDING ALL IMPLIED WARRANTIES OF MERCHANTABILITY AND FITNESS, IN NO EVENT SHALL FUJITSU LIMITED AND DIGITAL EQUIPMENT CORPORATION BE LIABLE FOR

ANY SPECIAL, INDIRECT OR CONSEQUENTIAL DAMAGES OR ANY DAMAGES WHATSOEVER RESULTING FROM LOSS OF USE, DATA OR PROFITS, WHETHER IN AN ACTION OF CONTRACT, NEGLIGENCE OR OTHER TORTIOUS ACTION, ARISING OUT OF OR IN CONNECTION WITH THE USE OR PERFORMANCE OF THIS SOFTWARE.

Copyright 1992, 1993 by FUJITSU LIMITED

Copyright 1993 by Fujitsu Open Systems Solutions, Inc.

Copyright 1994 by Sony Corporation

Permission to use, copy, modify, distribute and sell this software and its documentation for any purpose is hereby granted without fee, provided that the above copyright notice appear in all copies and that both that copyright notice and this permission notice appear in supporting documentation, and that the name of FUJITSU LIMITED, Fujitsu Open Systems Solutions, Inc. and Sony Corporation not be used in advertising or publicity pertaining to distribution of the software without specific, written prior permission.

FUJITSU LIMITED, Fujitsu Open Systems Solutions, Inc. and Sony Corporation make no representations about the suitability of this software for any purpose. It is provided "as is" without express or implied warranty.

FUJITSU LIMITED, FUJITSU OPEN SYSTEMS SOLUTIONS, INC. AND SONY CORPORATION DISCLAIM ALL WARRANTIES WITH REGARD TO THIS SOFTWARE, INCLUDING ALL IMPLIED WARRANTIES OF MERCHANTABILITY AND FITNESS, IN NO EVENT SHALL FUJITSU OPEN SYSTEMS SOLUTIONS, INC., FUJITSU LIMITED AND SONY CORPORATION BE LIABLE FOR ANY SPECIAL, INDIRECT OR CONSEQUENTIAL DAMAGES OR ANY DAMAGES WHATSOEVER RESULTING FROM LOSS OF USE, DATA OR PROFITS, WHETHER IN AN ACTION OF CONTRACT, NEGLIGENCE OR OTHER TORTIOUS ACTION, ARISING OUT OF OR IN CONNECTION WITH THE USE OR PERFORMANCE OF THIS SOFTWARE.

Copyright 1993 by SunSoft, Inc.

Copyright 1999–2000 by Bruno Haible

Permission to use, copy, modify, distribute, and sell this software and its documentation for any purpose is hereby granted without fee, provided that the above copyright notice appear in all copies and that both that copyright notice and this permission notice appear in supporting documentation, and that the names of SunSoft, Inc. and Bruno Haible not be used in advertising or publicity pertaining to distribution of the software without specific, written prior permission. SunSoft, Inc. and Bruno Haible make no representations about the suitability of this software for any purpose. It is provided "as is" without express or implied warranty.

SunSoft Inc. AND Bruno Haible DISCLAIM ALL WARRANTIES WITH REGARD TO THIS SOFTWARE, INCLUDING ALL IMPLIED WARRANTIES OF MERCHANTABILITY AND FITNESS, IN NO EVENT SHALL SunSoft, Inc. OR Bruno Haible BE LIABLE FOR ANY SPECIAL, INDIRECT OR CONSEQUENTIAL DAMAGES OR ANY DAMAGES WHATSOEVER RESULTING FROM LOSS OF USE, DATA OR PROFITS, WHETHER IN AN ACTION OF CONTRACT, NEGLIGENCE OR OTHER TORTIOUS ACTION, ARISING OUT OF OR IN CONNECTION WITH THE USE OR PERFORMANCE OF THIS SOFTWARE.

Copyright 1991 by the Open Software Foundation
Copyright 1993 by the TOSHIBA Corp.

Permission to use, copy, modify, distribute, and sell this software and its documentation for any purpose is hereby granted without fee, provided that the above copyright notice appear in all copies and that both that copyright notice and this permission notice appear in supporting documentation, and that the names of Open Software Foundation and TOSHIBA not be used in advertising or publicity pertaining to distribution of the software without specific, written prior permission. Open Software Foundation and TOSHIBA make no representations about the suitability of this software for any purpose. It is provided "as is" without express or implied warranty.

OPEN SOFTWARE FOUNDATION AND TOSHIBA DISCLAIM ALL WARRANTIES WITH REGARD TO THIS SOFTWARE, INCLUDING ALL IMPLIED WARRANTIES OF MERCHANTABILITY AND FITNESS, IN NO EVENT SHALL OPEN SOFTWARE FOUNDATION OR TOSHIBA BE LIABLE FOR ANY SPECIAL, INDIRECT OR CONSEQUENTIAL DAMAGES OR ANY DAMAGES

WHATSOEVER RESULTING FROM LOSS OF USE, DATA OR PROFITS, WHETHER IN AN ACTION OF CONTRACT, NEGLIGENCE OR OTHER TORTIOUS ACTION, ARISING OUT OF OR IN CONNECTION WITH THE USE OR PERFORMANCE OF THIS SOFTWARE.

Copyright 1988 by Wyse Technology, Inc., San Jose, Ca.,
All Rights Reserved

Permission to use, copy, modify, and distribute this software and its documentation for any purpose and without fee is hereby granted, provided that the above copyright notice appear in all copies and that both that copyright notice and this permission notice appear in supporting documentation, and that the name Wyse not be used in advertising or publicity pertaining to distribution of the software without specific, written prior permission.

WYSE DISCLAIMS ALL WARRANTIES WITH REGARD TO THIS SOFTWARE, INCLUDING ALL IMPLIED WARRANTIES OF MERCHANTABILITY AND FITNESS, IN NO EVENT SHALL DIGITAL BE LIABLE FOR ANY SPECIAL, INDIRECT OR CONSEQUENTIAL DAMAGES OR ANY DAMAGES WHATSOEVER RESULTING FROM LOSS OF USE, DATA OR PROFITS, WHETHER IN AN ACTION OF CONTRACT, NEGLIGENCE OR OTHER TORTIOUS ACTION, ARISING OUT OF OR IN CONNECTION WITH THE USE OR PERFORMANCE OF THIS SOFTWARE.

Copyright 1991 by the Open Software Foundation
Copyright 1993, 1994 by the Sony Corporation

Permission to use, copy, modify, distribute, and sell this software and its documentation for any purpose is hereby granted without fee, provided that the above copyright notice appear in all copies and that both that copyright notice and this permission notice appear in supporting documentation, and that the names of Open Software Foundation and Sony Corporation not be used in advertising or publicity pertaining to distribution of the software without specific, written prior permission. Open Software Foundation and Sony Corporation make no representations about the suitability of this software for any purpose. It is provided "as is" without express or implied warranty.

OPEN SOFTWARE FOUNDATION AND SONY CORPORATION DISCLAIM ALL WARRANTIES WITH REGARD TO THIS SOFTWARE, INCLUDING ALL IMPLIED WARRANTIES OF MERCHANTABILITY AND FITNESS, IN NO EVENT SHALL OPEN SOFTWARE FOUNDATION OR SONY CORPORATION BE LIABLE FOR ANY SPECIAL, INDIRECT OR CONSEQUENTIAL DAMAGES OR ANY DAMAGES WHATSOEVER RESULTING FROM LOSS OF USE, DATA OR PROFITS, WHETHER IN AN ACTION OF CONTRACT, NEGLIGENCE OR OTHER TORTIOUS ACTION, ARISING OUT OF OR IN CONNECTION WITH THE USE OR PERFORMANCE OF THIS SOFTWARE.

Copyright 1992, 1993 by FUJITSU LIMITED

Copyright 1993 by Fujitsu Open Systems Solutions, Inc.

Permission to use, copy, modify, distribute and sell this software and its documentation for any purpose is hereby granted without fee, provided that the above copyright notice appear in all copies and that both that copyright notice and this permission notice appear in supporting documentation, and that the name of FUJITSU LIMITED and Fujitsu Open Systems Solutions, Inc. not be used in advertising or publicity pertaining to distribution of the software without specific, written prior permission.

FUJITSU LIMITED and Fujitsu Open Systems Solutions, Inc. makes no representations about the suitability of this software for any purpose.

It is provided "as is" without express or implied warranty.

FUJITSU LIMITED AND FUJITSU OPEN SYSTEMS SOLUTIONS, INC. DISCLAIMS ALL WARRANTIES WITH REGARD TO THIS SOFTWARE, INCLUDING ALL IMPLIED WARRANTIES OF MERCHANTABILITY AND FITNESS, IN NO EVENT SHALL FUJITSU OPEN SYSTEMS SOLUTIONS, INC. AND FUJITSU LIMITED BE LIABLE FOR ANY SPECIAL, INDIRECT OR CONSEQUENTIAL DAMAGES OR ANY DAMAGES WHATSOEVER RESULTING FROM LOSS OF USE, DATA OR PROFITS, WHETHER IN AN ACTION OF CONTRACT, NEGLIGENCE OR OTHER TORTIOUS ACTION, ARISING OUT OF OR IN CONNECTION WITH THE USE OR PERFORMANCE OF THIS SOFTWARE.

Copyright 1993, 1994 by Sony Corporation

Permission to use, copy, modify, distribute, and sell this software and its documentation for any purpose is hereby granted without fee, provided that the above copyright notice appear in all copies and that both that copyright notice and this permission notice appear in supporting documentation, and that the name of Sony Corporation not be used in advertising or publicity pertaining to distribution of the software without specific, written prior permission. Sony Corporation makes no representations about the suitability of this software for any purpose. It is provided "as is" without express or implied warranty.

SONY CORPORATION DISCLAIMS ALL WARRANTIES WITH REGARD TO THIS SOFTWARE, INCLUDING ALL IMPLIED WARRANTIES OF MERCHANTABILITY AND FITNESS, IN NO EVENT SHALL SONY CORPORATION BE LIABLE FOR ANY SPECIAL, INDIRECT OR CONSEQUENTIAL DAMAGES OR ANY DAMAGES WHATSOEVER RESULTING FROM LOSS OF USE, DATA OR PROFITS, WHETHER IN AN ACTION OF CONTRACT, NEGLIGENCE OR OTHER TORTIOUS ACTION, ARISING OUT OF OR IN CONNECTION WITH THE USE OR PERFORMANCE OF THIS SOFTWARE.

Copyright 1986, 1998 The Open Group
Copyright (c) 2000 The XFree86 Project, Inc.

Permission to use, copy, modify, distribute, and sell this software and its documentation for any purpose is hereby granted without fee, provided that the above copyright notice appear in all copies and that both that copyright notice and this permission notice appear in supporting documentation.

The above copyright notice and this permission notice shall be included in all copies or substantial portions of the Software.

THE SOFTWARE IS PROVIDED "AS IS", WITHOUT WARRANTY OF ANY KIND, EXPRESS OR IMPLIED, INCLUDING BUT NOT LIMITED TO THE WARRANTIES OF MERCHANTABILITY, FITNESS FOR A PARTICULAR PURPOSE AND NONINFRINGEMENT. IN NO EVENT SHALL THE X CONSORTIUM OR THE XFREE86 PROJECT BE LIABLE FOR ANY CLAIM, DAMAGES OR OTHER LIABILITY, WHETHER IN AN ACTION OF CONTRACT, TORT OR OTHERWISE, ARISING FROM, OUT OF OR IN CONNECTION WITH THE SOFTWARE OR THE USE OR OTHER DEALINGS IN THE

SOFTWARE.

Except as contained in this notice, the name of the X Consortium or of the XFree86 Project shall not be used in advertising or otherwise to promote the sale, use or other dealings in this Software without prior written authorization from the X Consortium and the XFree86 Project.

Copyright 1990, 1991 by OMRON Corporation, NTT Software Corporation,
and Nippon Telegraph and Telephone Corporation

Copyright 1991 by the Open Software Foundation

Copyright 1993 by the FUJITSU LIMITED

Permission to use, copy, modify, distribute, and sell this software and its documentation for any purpose is hereby granted without fee, provided that the above copyright notice appear in all copies and that both that copyright notice and this permission notice appear in supporting documentation, and that the names of OMRON, NTT Software, NTT, and Open Software Foundation not be used in advertising or publicity pertaining to distribution of the software without specific, written prior permission. OMRON, NTT Software, NTT, and Open Software Foundation make no representations about the suitability of this software for any purpose. It is provided "as is" without express or implied warranty.

OMRON, NTT SOFTWARE, NTT, AND OPEN SOFTWARE FOUNDATION
DISCLAIM ALL WARRANTIES WITH REGARD TO THIS SOFTWARE, INCLUDING
ALL IMPLIED WARRANTIES OF MERCHANTABILITY AND FITNESS, IN NO EVENT
SHALL OMRON, NTT SOFTWARE, NTT, OR OPEN SOFTWARE FOUNDATION BE
LIABLE FOR ANY SPECIAL, INDIRECT OR CONSEQUENTIAL DAMAGES OR ANY DAMAGES
WHATSOEVER RESULTING FROM LOSS OF USE, DATA OR PROFITS, WHETHER IN AN
ACTION OF CONTRACT, NEGLIGENCE OR OTHER TORTIOUS ACTION, ARISING OUT OF
OR IN CONNECTION WITH THE USE OR PERFORMANCE OF THIS SOFTWARE.

Copyright 1988 by Wyse Technology, Inc., San Jose, Ca,

Copyright 1987 by Digital Equipment Corporation, Maynard, Massachusetts,

All Rights Reserved

Permission to use, copy, modify, and distribute this software and its documentation for any purpose and without fee is hereby granted, provided that the above copyright notice appear in all copies and that both that copyright notice and this permission notice appear in supporting documentation, and that the name Digital not be used in advertising or publicity pertaining to distribution of the software without specific, written prior permission.

DIGITAL AND WYSE DISCLAIM ALL WARRANTIES WITH REGARD TO THIS SOFTWARE, INCLUDING ALL IMPLIED WARRANTIES OF MERCHANTABILITY AND FITNESS, IN NO EVENT SHALL DIGITAL OR WYSE BE LIABLE FOR ANY SPECIAL, INDIRECT OR CONSEQUENTIAL DAMAGES OR ANY DAMAGES WHATSOEVER RESULTING FROM LOSS OF USE, DATA OR PROFITS, WHETHER IN AN ACTION OF CONTRACT, NEGLIGENCE OR OTHER TORTIOUS ACTION, ARISING OUT OF OR IN CONNECTION WITH THE USE OR PERFORMANCE OF THIS SOFTWARE.

Copyright 1991, 1992 by Fuji Xerox Co., Ltd.

Copyright 1992, 1993, 1994 by FUJITSU LIMITED

Permission to use, copy, modify, distribute, and sell this software and its documentation for any purpose is hereby granted without fee, provided that the above copyright notice appear in all copies and that both that copyright notice and this permission notice appear in supporting documentation, and that the name of Fuji Xerox, FUJITSU LIMITED not be used in advertising or publicity pertaining to distribution of the software without specific, written prior permission. Fuji Xerox, FUJITSU LIMITED make no representations about the suitability of this software for any purpose. It is provided "as is" without express or implied warranty.

FUJI XEROX, FUJITSU LIMITED DISCLAIM ALL WARRANTIES WITH REGARD TO THIS SOFTWARE, INCLUDING ALL IMPLIED WARRANTIES OF MERCHANTABILITY AND FITNESS, IN NO EVENT SHALL FUJI XEROX, FUJITSU LIMITED BE LIABLE FOR ANY SPECIAL, INDIRECT OR CONSEQUENTIAL DAMAGES OR ANY DAMAGES WHATSOEVER RESULTING FROM LOSS OF USE, DATA

OR PROFITS, WHETHER IN AN ACTION OF CONTRACT, NEGLIGENCE OR OTHER TORTIOUS ACTION, ARISING OUT OF OR IN CONNECTION WITH THE USE OR PERFORMANCE OF THIS SOFTWARE.

Copyright 2006 Josh Triplett

Permission is hereby granted, free of charge, to any person obtaining a copy of this software and associated documentation files (the "Software"), to deal in the Software without restriction, including without limitation the rights to use, copy, modify, merge, publish, distribute, sublicense, and/or sell copies of the Software, and to permit persons to whom the Software is furnished to do so, subject to the following conditions:

The above copyright notice and this permission notice shall be included in all copies or substantial portions of the Software.

THE SOFTWARE IS PROVIDED "AS IS", WITHOUT WARRANTY OF ANY KIND, EXPRESS OR IMPLIED, INCLUDING BUT NOT LIMITED TO THE WARRANTIES OF MERCHANTABILITY, FITNESS FOR A PARTICULAR PURPOSE AND NONINFRINGEMENT. IN NO EVENT SHALL THE X CONSORTIUM BE LIABLE FOR ANY CLAIM, DAMAGES OR OTHER LIABILITY, WHETHER IN AN ACTION OF CONTRACT, TORT OR OTHERWISE, ARISING FROM, OUT OF OR IN CONNECTION WITH THE SOFTWARE OR THE USE OR OTHER DEALINGS IN THE SOFTWARE.

(c) Copyright 1996 by Sebastien Marineau and Holger Veit

<marineau@genie.uottawa.ca>

<Holger.Veit@gmd.de>

Permission is hereby granted, free of charge, to any person obtaining a copy of this software and associated documentation files (the "Software"), to deal in the Software without restriction, including without limitation the rights to use, copy, modify, merge, publish, distribute, sublicense, and/or sell copies of the Software, and to permit persons to whom the Software is furnished to do so, subject to the following conditions:

The above copyright notice and this permission notice shall be included in all copies or substantial portions of the Software.

THE SOFTWARE IS PROVIDED "AS IS", WITHOUT WARRANTY OF ANY KIND, EXPRESS OR IMPLIED, INCLUDING BUT NOT LIMITED TO THE WARRANTIES OF MERCHANTABILITY, FITNESS FOR A PARTICULAR PURPOSE AND NONINFRINGEMENT. IN NO EVENT SHALL HOLGER VEIT BE LIABLE FOR ANY CLAIM, DAMAGES OR OTHER LIABILITY, WHETHER IN AN ACTION OF CONTRACT, TORT OR OTHERWISE, ARISING FROM, OUT OF OR IN CONNECTION WITH THE SOFTWARE OR THE USE OR OTHER DEALINGS IN THE SOFTWARE.

Except as contained in this notice, the name of Sebastien Marineau or Holger Veit shall not be used in advertising or otherwise to promote the sale, use or other dealings in this Software without prior written authorization from Holger Veit or Sebastien Marineau.

Copyright 1990, 1991 by OMRON Corporation, NTT Software Corporation,
and Nippon Telegraph and Telephone Corporation

Copyright 1991 by the Open Software Foundation

Copyright 1993 by the TOSHIBA Corp.

Copyright 1993, 1994 by Sony Corporation

Copyright 1993, 1994 by the FUJITSU LIMITED

Permission to use, copy, modify, distribute, and sell this software and its documentation for any purpose is hereby granted without fee, provided that the above copyright notice appear in all copies and that both that copyright notice and this permission notice appear in supporting documentation, and that the names of OMRON, NTT Software, NTT, Open Software Foundation, and Sony Corporation not be used in advertising or publicity pertaining to distribution of the software without specific, written prior permission. OMRON, NTT Software, NTT, Open Software Foundation, and Sony Corporation make no representations about the suitability of this software for any purpose. It is provided "as is" without express or implied warranty.

OMRON, NTT SOFTWARE, NTT, OPEN SOFTWARE FOUNDATION, AND SONY CORPORATION DISCLAIM ALL WARRANTIES WITH REGARD TO THIS SOFTWARE, INCLUDING

ALL IMPLIED WARRANTIES OF MERCHANTABILITY AND FITNESS, IN NO EVENT SHALL OMRON, NTT SOFTWARE, NTT, OPEN SOFTWARE FOUNDATION, OR SONY CORPORATION BE LIABLE FOR ANY SPECIAL, INDIRECT OR CONSEQUENTIAL DAMAGES OR ANY DAMAGES WHATSOEVER RESULTING FROM LOSS OF USE, DATA OR PROFITS, WHETHER IN AN ACTION OF CONTRACT, NEGLIGENCE OR OTHER TORTIOUS ACTION, ARISING OUT OF OR IN CONNECTION WITH THE USE OR PERFORMANCE OF THIS SOFTWARE.

Copyright 2000 by Bruno Haible

Permission to use, copy, modify, distribute, and sell this software and its documentation for any purpose is hereby granted without fee, provided that the above copyright notice appear in all copies and that both that copyright notice and this permission notice appear in supporting documentation, and that the name of Bruno Haible not be used in advertising or publicity pertaining to distribution of the software without specific, written prior permission. Bruno Haible makes no representations about the suitability of this software for any purpose. It is provided "as is" without express or implied warranty.

Bruno Haible DISCLAIMS ALL WARRANTIES WITH REGARD TO THIS SOFTWARE, INCLUDING ALL IMPLIED WARRANTIES OF MERCHANTABILITY AND FITNESS, IN NO EVENT SHALL Bruno Haible BE LIABLE FOR ANY SPECIAL, INDIRECT OR CONSEQUENTIAL DAMAGES OR ANY DAMAGES WHATSOEVER RESULTING FROM LOSS OF USE, DATA OR PROFITS, WHETHER IN AN ACTION OF CONTRACT, NEGLIGENCE OR OTHER TORTIOUS ACTION, ARISING OUT OF OR IN CONNECTION WITH THE USE OR PERFORMANCE OF THIS SOFTWARE.

Copyright (c) 2007–2009, Troy D. Hanson
All rights reserved.

Redistribution and use in source and binary forms, with or without modification, are permitted provided that the following conditions are met:

Redistributions of source code must retain the above copyright notice, this list of conditions and the following disclaimer.

THIS SOFTWARE IS PROVIDED BY THE COPYRIGHT HOLDERS AND CONTRIBUTORS "AS IS" AND ANY EXPRESS OR IMPLIED WARRANTIES, INCLUDING, BUT NOT LIMITED TO, THE IMPLIED WARRANTIES OF MERCHANTABILITY AND FITNESS FOR A PARTICULAR PURPOSE ARE DISCLAIMED. IN NO EVENT SHALL THE COPYRIGHT OWNER OR CONTRIBUTORS BE LIABLE FOR ANY DIRECT, INDIRECT, INCIDENTAL, SPECIAL, EXEMPLARY, OR CONSEQUENTIAL DAMAGES (INCLUDING, BUT NOT LIMITED TO, PROCUREMENT OF SUBSTITUTE GOODS OR SERVICES; LOSS OF USE, DATA, OR PROFITS; OR BUSINESS INTERRUPTION) HOWEVER CAUSED AND ON ANY THEORY OF LIABILITY, WHETHER IN CONTRACT, STRICT LIABILITY, OR TORT (INCLUDING NEGLIGENCE OR OTHERWISE) ARISING IN ANY WAY OUT OF THE USE OF THIS SOFTWARE, EVEN IF ADVISED OF THE POSSIBILITY OF SUCH DAMAGE.

Copyright 1992, 1993 by TOSHIBA Corp.

Permission to use, copy, modify, and distribute this software and its documentation for any purpose and without fee is hereby granted, provided that the above copyright notice appear in all copies and that both that copyright notice and this permission notice appear in supporting documentation, and that the name of TOSHIBA not be used in advertising or publicity pertaining to distribution of the software without specific, written prior permission. TOSHIBA make no representations about the suitability of this software for any purpose. It is provided "as is" without express or implied warranty.

TOSHIBA DISCLAIM ALL WARRANTIES WITH REGARD TO THIS SOFTWARE, INCLUDING ALL IMPLIED WARRANTIES OF MERCHANTABILITY AND FITNESS, IN NO EVENT SHALL TOSHIBA BE LIABLE FOR ANY SPECIAL, INDIRECT OR CONSEQUENTIAL DAMAGES OR ANY DAMAGES WHATSOEVER RESULTING FROM LOSS OF USE, DATA OR PROFITS, WHETHER IN AN ACTION OF CONTRACT, NEGLIGENCE OR OTHER TORTIOUS ACTION, ARISING OUT OF OR IN CONNECTION WITH THE USE OR PERFORMANCE OF THIS SOFTWARE.

Copyright IBM Corporation 1993

All Rights Reserved

License to use, copy, modify, and distribute this software and its documentation for any purpose and without fee is hereby granted, provided that the above copyright notice appear in all copies and that both that copyright notice and this permission notice appear in supporting documentation, and that the name of IBM not be used in advertising or publicity pertaining to distribution of the software without specific, written prior permission.

IBM DISCLAIMS ALL WARRANTIES WITH REGARD TO THIS SOFTWARE, INCLUDING ALL IMPLIED WARRANTIES OF MERCHANTABILITY, FITNESS, AND NONINFRINGEMENT OF THIRD PARTY RIGHTS, IN NO EVENT SHALL IBM BE LIABLE FOR ANY SPECIAL, INDIRECT OR CONSEQUENTIAL DAMAGES OR ANY DAMAGES WHATSOEVER RESULTING FROM LOSS OF USE, DATA OR PROFITS, WHETHER IN AN ACTION OF CONTRACT, NEGLIGENCE OR OTHER TORTIOUS ACTION, ARISING OUT OF OR IN CONNECTION WITH THE USE OR PERFORMANCE OF THIS SOFTWARE.

Copyright 1990, 1991 by OMRON Corporation, NTT Software Corporation,
and Nippon Telegraph and Telephone Corporation

Permission to use, copy, modify, distribute, and sell this software and its documentation for any purpose is hereby granted without fee, provided that the above copyright notice appear in all copies and that both that copyright notice and this permission notice appear in supporting documentation, and that the names of OMRON, NTT Software, and NTT not be used in advertising or publicity pertaining to distribution of the software without specific, written prior permission. OMRON, NTT Software, and NTT make no representations about the suitability of this software for any purpose. It is provided "as is" without express or implied warranty.

OMRON, NTT SOFTWARE, AND NTT, DISCLAIM ALL WARRANTIES WITH REGARD TO THIS SOFTWARE, INCLUDING ALL IMPLIED WARRANTIES OF MERCHANTABILITY AND FITNESS, IN NO EVENT SHALL OMRON, NTT SOFTWARE, OR NTT, BE LIABLE FOR ANY SPECIAL, INDIRECT OR CONSEQUENTIAL DAMAGES OR ANY DAMAGES WHATSOEVER RESULTING FROM LOSS OF USE, DATA OR PROFITS, WHETHER IN AN

ACTION OF CONTRACT, NEGLIGENCE OR OTHER TORTIOUS ACTION, ARISING OUT OF OR IN CONNECTION WITH THE USE OR PERFORMANCE OF THIS SOFTWARE.

Copyright (C) 2001–2006 Bart Massey, Jamey Sharp, and Josh Triplett.
All Rights Reserved.

Permission is hereby granted, free of charge, to any person obtaining a copy of this software and associated documentation files (the "Software"), to deal in the Software without restriction, including without limitation the rights to use, copy, modify, merge, publish, distribute, sublicense, and/or sell copies of the Software, and to permit persons to whom the Software is furnished to do so, subject to the following conditions:

The above copyright notice and this permission notice shall be included in all copies or substantial portions of the Software.

THE SOFTWARE IS PROVIDED "AS IS", WITHOUT WARRANTY OF ANY KIND, EXPRESS OR IMPLIED, INCLUDING BUT NOT LIMITED TO THE WARRANTIES OF MERCHANTABILITY, FITNESS FOR A PARTICULAR PURPOSE AND NONINFRINGEMENT. IN NO EVENT SHALL THE AUTHORS BE LIABLE FOR ANY CLAIM, DAMAGES OR OTHER LIABILITY, WHETHER IN AN ACTION OF CONTRACT, TORT OR OTHERWISE, ARISING FROM, OUT OF OR IN CONNECTION WITH THE SOFTWARE OR THE USE OR OTHER DEALINGS IN THE SOFTWARE.

Except as contained in this notice, the names of the authors or their institutions shall not be used in advertising or otherwise to promote the sale, use or other dealings in this Software without prior written authorization from the authors.

Copyright 1988 – 1990, 1992, 1994, 1995 Network Computing Devices

Permission to use, copy, modify, distribute, and sell this software and its documentation for any purpose is hereby granted without fee, provided that the above copyright notice appear in all copies and that both that copyright notice and this permission notice appear in supporting documentation, and that the name of NCD. not be used in advertising or publicity pertaining to distribution of the software without specific, written prior permission. NCD. makes no representations about the suitability of this software for any purpose. It is provided "as is" without express or implied warranty.

NCD. DISCLAIMS ALL WARRANTIES WITH REGARD TO THIS SOFTWARE, INCLUDING ALL IMPLIED WARRANTIES OF MERCHANTABILITY AND FITNESS, IN NO EVENT SHALL NCD. BE LIABLE FOR ANY SPECIAL, INDIRECT OR CONSEQUENTIAL DAMAGES OR ANY DAMAGES WHATSOEVER RESULTING FROM LOSS OF USE, DATA OR PROFITS, WHETHER IN AN ACTION OF CONTRACT, NEGLIGENCE OR OTHER TORTIOUS ACTION, ARISING OUT OF OR IN CONNECTION WITH THE USE OR PERFORMANCE OF THIS SOFTWARE.

Copyright 1991, 1993 by Digital Equipment Corporation, Maynard, Massachusetts, and Olivetti Research Limited, Cambridge, England.

All Rights Reserved

Permission to use, copy, modify, and distribute this software and its documentation for any purpose and without fee is hereby granted, provided that the above copyright notice appear in all copies and that both that copyright notice and this permission notice appear in supporting documentation, and that the names of Digital or Olivetti not be used in advertising or publicity pertaining to distribution of the software without specific, written prior permission.

DIGITAL AND OLIVETTI DISCLAIM ALL WARRANTIES WITH REGARD TO THIS SOFTWARE, INCLUDING ALL IMPLIED WARRANTIES OF MERCHANTABILITY AND FITNESS, IN NO EVENT SHALL THEY BE LIABLE FOR ANY SPECIAL, INDIRECT OR CONSEQUENTIAL DAMAGES OR ANY DAMAGES WHATSOEVER RESULTING FROM LOSS OF USE, DATA OR PROFITS, WHETHER IN AN ACTION OF CONTRACT, NEGLIGENCE OR OTHER TORTIOUS ACTION, ARISING OUT OF OR IN CONNECTION WITH THE USE OR PERFORMANCE OF THIS SOFTWARE.

Copyright 1999, 2005, 2006 Sun Microsystems, Inc. All rights reserved.

Permission is hereby granted, free of charge, to any person obtaining a copy of this software and associated documentation files (the "Software"), to deal in the Software without restriction, including without limitation the rights to use, copy, modify, merge, publish, distribute, sublicense, and/or sell copies of the Software, and to permit persons to whom the Software is furnished to do so, subject to the following conditions:

The above copyright notice and this permission notice (including the next paragraph) shall be included in all copies or substantial portions of the Software.

THE SOFTWARE IS PROVIDED "AS IS", WITHOUT WARRANTY OF ANY KIND, EXPRESS OR IMPLIED, INCLUDING BUT NOT LIMITED TO THE WARRANTIES OF MERCHANTABILITY, FITNESS FOR A PARTICULAR PURPOSE AND NONINFRINGEMENT. IN NO EVENT SHALL THE AUTHORS OR COPYRIGHT HOLDERS BE LIABLE FOR ANY CLAIM, DAMAGES OR OTHER LIABILITY, WHETHER IN AN ACTION OF CONTRACT, TORT OR OTHERWISE, ARISING FROM, OUT OF OR IN CONNECTION WITH THE SOFTWARE OR THE USE OR OTHER DEALINGS IN THE SOFTWARE.

Copyright (c) 1989 X Consortium, Inc. and Digital Equipment Corporation.

Copyright (c) 1992 X Consortium, Inc. and Intergraph Corporation.

Copyright (c) 1993 X Consortium, Inc. and Silicon Graphics, Inc.

Copyright (c) 1994, 1995 X Consortium, Inc. and Hewlett-Packard Company.

Permission to use, copy, modify, and distribute this documentation for any purpose and without fee is hereby granted, provided that the above copyright notice and this permission notice appear in all copies.

Digital Equipment Corporation, Intergraph Corporation, Silicon Graphics, Hewlett-Packard, and the X Consortium make no representations about the suitability for any purpose of the information in this document. This documentation is provided "as is" without express or implied warranty.

Copyright © 2007 Red Hat, Inc

Copyright © 2008,2009 Sun Microsystems, Inc. All rights reserved.

Permission is hereby granted, free of charge, to any person obtaining a copy of this software and associated documentation files (the "Software"), to deal in the Software without restriction, including without limitation the rights to use, copy, modify, merge, publish, distribute, sublicense, and/or sell copies of the Software, and to permit persons to whom the Software is furnished to do so, subject to the following conditions:

The above copyright notice and this permission notice (including the next paragraph) shall be included in all copies or substantial portions of the Software.

THE SOFTWARE IS PROVIDED "AS IS", WITHOUT WARRANTY OF ANY KIND, EXPRESS OR IMPLIED, INCLUDING BUT NOT LIMITED TO THE WARRANTIES OF MERCHANTABILITY, FITNESS FOR A PARTICULAR PURPOSE AND NONINFRINGEMENT. IN NO EVENT SHALL THE AUTHORS OR COPYRIGHT HOLDERS BE LIABLE FOR ANY CLAIM, DAMAGES OR OTHER LIABILITY, WHETHER IN AN ACTION OF CONTRACT, TORT OR OTHERWISE, ARISING FROM, OUT OF OR IN CONNECTION WITH THE SOFTWARE OR THE USE OR OTHER DEALINGS IN THE SOFTWARE.

Copyright (c) 1997 by Mark Leisher

Copyright (c) 1998–2003 by Juliusz Chroboczek

Copyright (c) 1998 Go Watanabe, All rights reserved.

Copyright (c) 1998 Kazushi (Jam) Marukawa, All rights reserved.

Copyright (c) 1998 Takuya SHIOZAKI, All rights reserved.

Copyright (c) 1998 X-TrueType Server Project, All rights reserved.

Copyright (c) 2003–2004 After X-TT Project, All rights reserved.

Permission is hereby granted, free of charge, to any person obtaining a copy of this software and associated documentation files (the "Software"), to deal in the Software without restriction, including without limitation the rights to use, copy, modify, merge, publish, distribute, sublicense, and/or sell copies of the Software, and to permit persons to whom the Software is furnished to do so, subject to the following conditions:

The above copyright notice and this permission notice shall be included in all copies or substantial portions of the Software.

THE SOFTWARE IS PROVIDED "AS IS", WITHOUT WARRANTY OF ANY KIND, EXPRESS OR IMPLIED, INCLUDING BUT NOT LIMITED TO THE WARRANTIES OF MERCHANTABILITY, FITNESS FOR A PARTICULAR PURPOSE AND NONINFRINGEMENT. IN NO EVENT SHALL THE AUTHORS OR COPYRIGHT HOLDERS BE LIABLE FOR ANY CLAIM, DAMAGES OR OTHER LIABILITY, WHETHER IN AN ACTION OF CONTRACT, TORT OR OTHERWISE, ARISING FROM, OUT OF OR IN CONNECTION WITH THE SOFTWARE OR THE USE OR OTHER DEALINGS IN THE SOFTWARE.

Copyright 1999, 2000 SuSE, Inc.

Permission to use, copy, modify, distribute, and sell this software and its documentation for any purpose is hereby granted without fee, provided that the above copyright notice appear in all copies and that both that copyright notice and this permission notice appear in supporting documentation, and that the name of SuSE not be used in advertising or publicity pertaining to distribution of the software without specific, written prior permission. SuSE makes no representations about the suitability of this software for any purpose. It is provided "as is" without express or implied warranty.

SuSE DISCLAIMS ALL WARRANTIES WITH REGARD TO THIS SOFTWARE, INCLUDING ALL IMPLIED WARRANTIES OF MERCHANTABILITY AND FITNESS, IN NO EVENT SHALL SuSE BE LIABLE FOR ANY SPECIAL, INDIRECT OR CONSEQUENTIAL DAMAGES OR ANY DAMAGES WHATSOEVER RESULTING FROM LOSS OF USE, DATA OR PROFITS, WHETHER IN AN ACTION OF CONTRACT, NEGLIGENCE OR OTHER TORTIOUS ACTION, ARISING OUT OF OR IN CONNECTION WITH THE USE OR PERFORMANCE OF THIS SOFTWARE.

Copyright (c) 1991, 1993

The Regents of the University of California. All rights reserved.

Redistribution and use in source and binary forms, with or without modification, are permitted provided that the following conditions are met:

1. Redistributions of source code must retain the above copyright notice, this list of conditions and the following disclaimer.
2. Redistributions in binary form must reproduce the above copyright

notice, this list of conditions and the following disclaimer in the documentation and/or other materials provided with the distribution.

3. All advertising materials mentioning features or use of this software must display the following acknowledgement:

This product includes software developed by the University of California, Berkeley and its contributors.

4. Neither the name of the University nor the names of its contributors may be used to endorse or promote products derived from this software without specific prior written permission.

THIS SOFTWARE IS PROVIDED BY THE REGENTS AND CONTRIBUTORS ``AS IS'' AND ANY EXPRESS OR IMPLIED WARRANTIES, INCLUDING, BUT NOT LIMITED TO, THE IMPLIED WARRANTIES OF MERCHANTABILITY AND FITNESS FOR A PARTICULAR PURPOSE ARE DISCLAIMED. IN NO EVENT SHALL THE REGENTS OR CONTRIBUTORS BE LIABLE FOR ANY DIRECT, INDIRECT, INCIDENTAL, SPECIAL, EXEMPLARY, OR CONSEQUENTIAL DAMAGES (INCLUDING, BUT NOT LIMITED TO, PROCUREMENT OF SUBSTITUTE GOODS OR SERVICES; LOSS OF USE, DATA, OR PROFITS; OR BUSINESS INTERRUPTION) HOWEVER CAUSED AND ON ANY THEORY OF LIABILITY, WHETHER IN CONTRACT, STRICT LIABILITY, OR TORT (INCLUDING NEGLIGENCE OR OTHERWISE) ARISING IN ANY WAY OUT OF THE USE OF THIS SOFTWARE, EVEN IF ADVISED OF THE POSSIBILITY OF SUCH DAMAGE.

Copyright (c) 1998-1999 Shunsuke Akiyama <akiyama@jp.FreeBSD.org>.

All rights reserved.

Copyright (c) 1998-1999 X-TrueType Server Project, All rights reserved.

Redistribution and use in source and binary forms, with or without modification, are permitted provided that the following conditions are met:

1. Redistributions of source code must retain the above copyright notice, this list of conditions and the following disclaimer.
2. Redistributions in binary form must reproduce the above copyright notice, this list of conditions and the following disclaimer in the documentation and/or other materials provided with the distribution.

THIS SOFTWARE IS PROVIDED BY THE AUTHOR AND CONTRIBUTORS ``AS IS'' AND ANY EXPRESS OR IMPLIED WARRANTIES, INCLUDING, BUT NOT LIMITED TO, THE

IMPLIED WARRANTIES OF MERCHANTABILITY AND FITNESS FOR A PARTICULAR PURPOSE ARE DISCLAIMED. IN NO EVENT SHALL THE AUTHOR OR CONTRIBUTORS BE LIABLE FOR ANY DIRECT, INDIRECT, INCIDENTAL, SPECIAL, EXEMPLARY, OR CONSEQUENTIAL DAMAGES (INCLUDING, BUT NOT LIMITED TO, PROCUREMENT OF SUBSTITUTE GOODS OR SERVICES; LOSS OF USE, DATA, OR PROFITS; OR BUSINESS INTERRUPTION) HOWEVER CAUSED AND ON ANY THEORY OF LIABILITY, WHETHER IN CONTRACT, STRICT LIABILITY, OR TORT (INCLUDING NEGLIGENCE OR OTHERWISE) ARISING IN ANY WAY OUT OF THE USE OF THIS SOFTWARE, EVEN IF ADVISED OF THE POSSIBILITY OF SUCH DAMAGE.

Copyright © 2000 Compaq Computer Corporation

Copyright © 2002 Hewlett-Packard Company

Copyright © 2006 Intel Corporation

Permission to use, copy, modify, distribute, and sell this software and its documentation for any purpose is hereby granted without fee, provided that the above copyright notice appear in all copies and that both that copyright notice and this permission notice appear in supporting documentation, and that the name of the copyright holders not be used in advertising or publicity pertaining to distribution of the software without specific, written prior permission. The copyright holders make no representations about the suitability of this software for any purpose. It is provided "as is" without express or implied warranty.

THE COPYRIGHT HOLDERS DISCLAIM ALL WARRANTIES WITH REGARD TO THIS SOFTWARE, INCLUDING ALL IMPLIED WARRANTIES OF MERCHANTABILITY AND FITNESS, IN NO EVENT SHALL THE COPYRIGHT HOLDERS BE LIABLE FOR ANY SPECIAL, INDIRECT OR CONSEQUENTIAL DAMAGES OR ANY DAMAGES WHATSOEVER RESULTING FROM LOSS OF USE, DATA OR PROFITS, WHETHER IN AN ACTION OF CONTRACT, NEGLIGENCE OR OTHER TORTIOUS ACTION, ARISING OUT OF OR IN CONNECTION WITH THE USE OR PERFORMANCE OF THIS SOFTWARE.

Copyright 1991 by Digital Equipment Corporation, Maynard, Massachusetts, and the Massachusetts Institute of Technology, Cambridge, Massachusetts.

All Rights Reserved

Permission to use, copy, modify, and distribute this software and its documentation for any purpose and without fee is hereby granted, provided that the above copyright notice appear in all copies and that both that copyright notice and this permission notice appear in supporting documentation, and that the names of Digital or MIT not be used in advertising or publicity pertaining to distribution of the software without specific, written prior permission.

DIGITAL DISCLAIMS ALL WARRANTIES WITH REGARD TO THIS SOFTWARE, INCLUDING ALL IMPLIED WARRANTIES OF MERCHANTABILITY AND FITNESS, IN NO EVENT SHALL DIGITAL BE LIABLE FOR ANY SPECIAL, INDIRECT OR CONSEQUENTIAL DAMAGES OR ANY DAMAGES WHATSOEVER RESULTING FROM LOSS OF USE, DATA OR PROFITS, WHETHER IN AN ACTION OF CONTRACT, NEGLIGENCE OR OTHER TORTIOUS ACTION, ARISING OUT OF OR IN CONNECTION WITH THE USE OR PERFORMANCE OF THIS SOFTWARE.

Permission is hereby granted, free of charge, to any person obtaining a copy of this software and associated documentation files (the "Software"), to deal in the Software without restriction, including without limitation the rights to use, copy, modify, merge, publish, distribute, sublicense, and/or sell copies of the Software, and to permit persons to whom the Software is furnished to do so, subject to the following conditions:

The above copyright notice and this permission notice shall be included in all copies or substantial portions of the Software.

THE SOFTWARE IS PROVIDED "AS IS", WITHOUT WARRANTY OF ANY KIND, EXPRESS OR IMPLIED, INCLUDING BUT NOT LIMITED TO THE WARRANTIES OF MERCHANTABILITY, FITNESS FOR A PARTICULAR PURPOSE AND NONINFRINGEMENT. IN NO EVENT SHALL THE XFREE86 PROJECT BE LIABLE FOR ANY CLAIM, DAMAGES OR OTHER LIABILITY, WHETHER IN AN ACTION OF CONTRACT, TORT OR OTHERWISE, ARISING FROM, OUT OF OR IN CONNECTION WITH THE SOFTWARE OR THE USE OR OTHER DEALINGS IN THE SOFTWARE.

Except as contained in this notice, the name of the XFree86 Project shall not be used in advertising or otherwise to promote the sale, use or other dealings in this Software without prior written authorization from the XFree86 Project.

Copyright (c) 2004 The Unichrome Project. All rights reserved.

Permission is hereby granted, free of charge, to any person obtaining a copy of this software and associated documentation files (the "Software"), to deal in the Software without restriction, including without limitation the rights to use, copy, modify, merge, publish, distribute, sublicense, and/or sell copies of the Software, and to permit persons to whom the Software is furnished to do so, subject to the following conditions:

The above copyright notice and this permission notice shall be included in all copies or substantial portions of the Software.

THE SOFTWARE IS PROVIDED "AS IS", WITHOUT WARRANTY OF ANY KIND, EXPRESS OR IMPLIED, INCLUDING BUT NOT LIMITED TO THE WARRANTIES OF MERCHANTABILITY, FITNESS FOR A PARTICULAR PURPOSE AND NONINFRINGEMENT. IN NO EVENT SHALL THE AUTHOR(S) OR COPYRIGHT HOLDER(S) BE LIABLE FOR ANY CLAIM, DAMAGES OR OTHER LIABILITY, WHETHER IN AN ACTION OF CONTRACT, TORT OR OTHERWISE, ARISING FROM, OUT OF OR IN CONNECTION WITH THE SOFTWARE OR THE USE OR OTHER DEALINGS IN THE SOFTWARE.

Copyright (C) 2001–2006 Bart Massey, Jamey Sharp, and Josh Triplett.
All Rights Reserved.

Permission is hereby granted, free of charge, to any person obtaining a copy of this software and associated documentation files (the "Software"), to deal in the Software without restriction, including without limitation the rights to use, copy, modify, merge, publish, distribute, sublicense, and/or sell copies of the Software, and to permit persons to whom the Software is furnished to do so, subject to the following conditions:

The above copyright notice and this permission notice shall be included in all copies or substantial portions of the Software.

THE SOFTWARE IS PROVIDED "AS IS", WITHOUT WARRANTY OF ANY KIND, EXPRESS OR IMPLIED, INCLUDING BUT NOT LIMITED TO THE WARRANTIES OF MERCHANTABILITY, FITNESS FOR A PARTICULAR PURPOSE AND NONINFRINGEMENT. IN NO EVENT SHALL THE AUTHORS BE LIABLE FOR ANY CLAIM, DAMAGES OR OTHER LIABILITY, WHETHER IN AN ACTION OF CONTRACT, TORT OR OTHERWISE, ARISING FROM, OUT OF OR IN CONNECTION WITH THE SOFTWARE OR THE USE OR OTHER DEALINGS IN THE SOFTWARE.

Except as contained in this notice, the names of the authors or their institutions shall not be used in advertising or otherwise to promote the sale, use or other dealings in this Software without prior written authorization from the authors.

Copyright © 2006–2008 Peter Hutterer

Permission is hereby granted, free of charge, to any person obtaining a copy of this software and associated documentation files (the "Software"), to deal in the Software without restriction, including without limitation the rights to use, copy, modify, merge, publish, distribute, sublicense, and/or sell copies of the Software, and to permit persons to whom the Software is furnished to do so, subject to the following conditions:

The above copyright notice and this permission notice (including the next paragraph) shall be included in all copies or substantial portions of the Software.

THE SOFTWARE IS PROVIDED "AS IS", WITHOUT WARRANTY OF ANY KIND, EXPRESS OR IMPLIED, INCLUDING BUT NOT LIMITED TO THE WARRANTIES OF MERCHANTABILITY, FITNESS FOR A PARTICULAR PURPOSE AND NONINFRINGEMENT. IN NO EVENT SHALL THE AUTHORS OR COPYRIGHT HOLDERS BE LIABLE FOR ANY CLAIM, DAMAGES OR OTHER LIABILITY, WHETHER IN AN ACTION OF CONTRACT, TORT OR OTHERWISE, ARISING FROM, OUT OF OR IN CONNECTION WITH THE SOFTWARE OR THE USE OR OTHER DEALINGS IN THE SOFTWARE.

Copyright 1990,91 by Thomas Roell, Dinkelscherben, Germany.

Copyright 1993 by David Dawes <dawes@xfree86.org>

Copyright 2002 by SuSE Linux AG, Author: Egbert Eich

Copyright 1994–2002 by The XFree86 Project, Inc.

Copyright 2002 by Paul Elliott

Copyright © 2008 University of South Australia

Copyright 2008 by Chris Salch

Copyright © 2008, 2009 Red Hat, Inc.

Permission to use, copy, modify, distribute, and sell this software and its documentation for any purpose is hereby granted without fee, provided that the above copyright notice appear in all copies and that both that copyright notice and this permission notice appear in supporting documentation, and that the name of the authors not be used in advertising or publicity pertaining to distribution of the software without specific, written prior permission. The authors make no representations about the suitability of this software for any purpose. It is provided "as is" without express or implied warranty.

THE AUTHORS DISCLAIM ALL WARRANTIES WITH REGARD TO THIS SOFTWARE, INCLUDING ALL IMPLIED WARRANTIES OF MERCHANTABILITY AND FITNESS, IN NO EVENT SHALL THE AUTHORS BE LIABLE FOR ANY SPECIAL, INDIRECT OR CONSEQUENTIAL DAMAGES OR ANY DAMAGES WHATSOEVER RESULTING FROM LOSS OF USE, DATA OR PROFITS, WHETHER IN AN ACTION OF CONTRACT, NEGLIGENCE OR OTHER TORTIOUS ACTION, ARISING OUT OF OR IN CONNECTION WITH THE USE OR PERFORMANCE OF THIS SOFTWARE.

Copyright 2005 Adam Jackson.

Permission is hereby granted, free of charge, to any person obtaining a copy of this software and associated documentation files (the "Software"), to deal in the Software without restriction, including without limitation on the rights to use, copy, modify, merge, publish, distribute, sublicense, and/or sell copies of the Software, and to permit persons to whom the Software is furnished to do so, subject to the following conditions:

The above copyright notice and this permission notice (including the next paragraph) shall be included in all copies or substantial portions of the Software.

THE SOFTWARE IS PROVIDED "AS IS", WITHOUT WARRANTY OF ANY KIND, EXPRESS OR IMPLIED, INCLUDING BUT NOT LIMITED TO THE WARRANTIES OF MERCHANTABILITY, FITNESS FOR A PARTICULAR PURPOSE AND NON-INFRINGEMENT. IN NO EVENT SHALL ADAM JACKSON BE LIABLE FOR ANY CLAIM, DAMAGES OR OTHER LIABILITY, WHETHER IN AN ACTION OF CONTRACT, TORT OR OTHERWISE, ARISING FROM, OUT OF OR IN CONNECTION WITH THE SOFTWARE OR THE USE OR OTHER DEALINGS IN THE SOFTWARE.

Copyright (c) 1992–2003 by The XFree86 Project, Inc.

Copyright 1997 by Metro Link, Inc.

Permission is hereby granted, free of charge, to any person obtaining a copy of this software and associated documentation files (the "Software"), to deal in the Software without restriction, including without limitation the rights to use, copy, modify, merge, publish, distribute, sublicense, and/or sell copies of the Software, and to permit persons to whom the Software is furnished to do so, subject to the following conditions:

The above copyright notice and this permission notice shall be included in all copies or substantial portions of the Software.

THE SOFTWARE IS PROVIDED "AS IS", WITHOUT WARRANTY OF ANY KIND, EXPRESS OR IMPLIED, INCLUDING BUT NOT LIMITED TO THE WARRANTIES OF MERCHANTABILITY, FITNESS FOR A PARTICULAR PURPOSE AND NON-INFRINGEMENT. IN NO EVENT SHALL THE COPYRIGHT HOLDER(S) OR AUTHOR(S) BE LIABLE FOR ANY CLAIM, DAMAGES OR OTHER LIABILITY, WHETHER IN AN ACTION OF CONTRACT, TORT OR OTHERWISE, ARISING FROM, OUT OF OR IN CONNECTION WITH THE SOFTWARE OR THE USE OR OTHER DEALINGS IN THE SOFTWARE.

Except as contained in this notice, the name of the copyright holder(s) and author(s) shall not be used in advertising or otherwise to promote the sale, use or other dealings in this Software without prior written authorization from the copyright holder(s) and author(s).

Copyright 1990,91 by Thomas Roell, Dinkelscherben, Germany.

Copyright 1993 by David Dawes <dawes@xfree86.org>

Permission to use, copy, modify, distribute, and sell this software and its documentation for any purpose is hereby granted without fee, provided that the above copyright notice appear in all copies and that both that copyright notice and this permission notice appear in supporting documentation, and that the names of Thomas Roell and David Dawes not be used in advertising or publicity pertaining to distribution of the software without specific, written prior permission. Thomas Roell and David Dawes make no representations about the suitability of this software for any purpose. It is provided "as is" without express or implied warranty.

THOMAS ROELL AND DAVID DAWES DISCLAIM ALL WARRANTIES WITH REGARD TO THIS SOFTWARE, INCLUDING ALL IMPLIED WARRANTIES OF MERCHANTABILITY AND FITNESS. IN NO EVENT SHALL THOMAS ROELL OR DAVID DAWES BE LIABLE FOR ANY SPECIAL, INDIRECT OR CONSEQUENTIAL DAMAGES OR ANY DAMAGES WHATSOEVER RESULTING FROM LOSS OF USE, DATA OR PROFITS, WHETHER IN AN ACTION OF CONTRACT, NEGLIGENCE OR OTHER TORTIOUS ACTION, ARISING OUT OF OR IN CONNECTION WITH THE USE OR PERFORMANCE OF THIS SOFTWARE.

Copyright 1992 by Rich Murphey <Rich@Rice.edu>

Copyright 1993 by David Dawes <dawes@xfree86.org>

Permission to use, copy, modify, distribute, and sell this software and its documentation for any purpose is hereby granted without fee, provided that the above copyright notice appear in all copies and that both that copyright notice and this permission notice appear in supporting documentation, and that the names of Rich Murphey and David Dawes not be used in advertising or publicity pertaining to distribution of the software without specific, written prior permission. Rich Murphey and David Dawes make no representations about the suitability of this software for any purpose. It is provided "as is" without express or implied warranty.

RICH MURPHEY AND DAVID DAWES DISCLAIM ALL WARRANTIES WITH REGARD TO THIS SOFTWARE, INCLUDING ALL IMPLIED WARRANTIES OF MERCHANTABILITY AND FITNESS, IN NO EVENT SHALL RICH MURPHEY OR DAVID DAWES BE LIABLE FOR ANY SPECIAL, INDIRECT OR CONSEQUENTIAL DAMAGES OR ANY DAMAGES WHATSOEVER RESULTING FROM LOSS OF USE, DATA OR PROFITS, WHETHER IN AN ACTION OF CONTRACT, NEGLIGENCE OR OTHER TORTIOUS ACTION, ARISING OUT OF OR IN CONNECTION WITH THE USE OR PERFORMANCE OF THIS SOFTWARE.

Copyright 1992 by Orest Zborowski <obz@Kodak.com>

Copyright 1993 by David Dawes <dawes@xfree86.org>

Permission to use, copy, modify, distribute, and sell this software and its documentation for any purpose is hereby granted without fee, provided that the above copyright notice appear in all copies and that both that copyright notice and this permission notice appear in supporting documentation, and that the names of Orest Zborowski and David Dawes not be used in advertising or publicity pertaining to distribution of the software without specific, written prior permission. Orest Zborowski and David Dawes make no representations about the suitability of this software for any purpose. It is provided "as is" without express or implied warranty.

OREST ZBOROWSKI AND DAVID DAWES DISCLAIMS ALL WARRANTIES WITH REGARD TO THIS SOFTWARE, INCLUDING ALL IMPLIED WARRANTIES OF MERCHANTABILITY AND FITNESS, IN NO EVENT SHALL OREST ZBOROWSKI OR DAVID DAWES BE LIABLE FOR ANY SPECIAL, INDIRECT OR CONSEQUENTIAL DAMAGES OR ANY DAMAGES WHATSOEVER RESULTING FROM LOSS OF USE, DATA OR PROFITS, WHETHER IN AN ACTION OF CONTRACT, NEGLIGENCE OR OTHER TORTIOUS ACTION, ARISING OUT OF OR IN CONNECTION WITH THE USE OR PERFORMANCE OF THIS SOFTWARE.

Portions based on kbdrate.c from util-linux 2.9t, which is
Copyright 1992 Rickard E. Faith. Distributed under the GPL.
This program comes with ABSOLUTELY NO WARRANTY.

Copyright 1990,91 by Thomas Roell, Dinkelscherben, Germany
Copyright 1993 by David Dawes <dawes@XFree86.org>

Copyright 1999 by David Holland <davidh@iquest.net)

Permission to use, copy, modify, distribute, and sell this software and its documentation for any purpose is hereby granted without fee, provided that the above copyright notice appear in all copies and that both that copyright notice and this permission notice appear in supporting documentation, and that the names of Thomas Roell, David Dawes, and David Holland not be used in advertising or publicity pertaining to distribution of the software without specific, written prior permission. Thomas Roell, David Dawes, and David Holland make no representations about the suitability of this software for any purpose. It is provided "as is" without express or implied warranty.

THOMAS ROELL, DAVID DAWES, AND DAVID HOLLAND DISCLAIM ALL WARRANTIES WITH REGARD TO THIS SOFTWARE, INCLUDING ALL IMPLIED WARRANTIES OF MERCHANTABILITY AND FITNESS. IN NO EVENT SHALL THOMAS ROELL, DAVID DAWES, OR DAVID HOLLAND BE LIABLE FOR ANY SPECIAL, INDIRECT OR CONSEQUENTIAL DAMAGES OR ANY DAMAGES WHATSOEVER RESULTING FROM LOSS OF USE, DATA OR PROFITS, WHETHER IN AN ACTION OF CONTRACT, NEGLIGENCE OR OTHER TORTIOUS ACTION, ARISING OUT OF OR IN CONNECTION WITH THE USE OR PERFORMANCE OF THIS SOFTWARE.

Copyright 1990,91 by Thomas Roell, Dinkelscherben, Germany.

Copyright 1993 by David Dawes <dawes@xfree86.org>

Copyright 2002 by SuSE Linux AG, Author: Egbert Eich

Copyright 1994–2002 by The XFree86 Project, Inc.

Copyright 2002 by Paul Elliott

Permission to use, copy, modify, distribute, and sell this software and its documentation for any purpose is hereby granted without fee, provided that the above copyright notice appear in all copies and that both that copyright notice and this permission notice appear in supporting documentation, and that the names of copyright holders not be used in advertising or publicity pertaining to distribution of the software without specific, written prior permission. The copyright holders make no representations about the suitability of this software for any purpose. It is provided "as is" without express or implied warranty.

THE COPYRIGHT HOLDERS DISCLAIM ALL WARRANTIES WITH REGARD TO THIS SOFTWARE, INCLUDING ALL IMPLIED WARRANTIES OF MERCHANTABILITY AND FITNESS, IN NO EVENT SHALL THE COPYRIGHT HOLDERS BE LIABLE FOR ANY SPECIAL, INDIRECT OR CONSEQUENTIAL DAMAGES OR ANY DAMAGES WHATSOEVER RESULTING FROM LOSS OF USE, DATA OR PROFITS, WHETHER IN AN ACTION OF CONTRACT, NEGLIGENCE OR OTHER TORTIOUS ACTION, ARISING OUT OF OR IN CONNECTION WITH THE USE OR PERFORMANCE OF THIS SOFTWARE.

Copyright 1998 by Kazutaka YOKOTA <yokota@zodiac.mech.utsunomiya-u.ac.jp>

Permission to use, copy, modify, distribute, and sell this software and its documentation for any purpose is hereby granted without fee, provided that the above copyright notice appear in all copies and that both that copyright notice and this permission notice appear in supporting documentation, and that the name of Kazutaka YOKOTA not be used in advertising or publicity pertaining to distribution of the software without specific, written prior permission. Kazutaka YOKOTA makes no representations about the suitability of this software for any purpose. It is provided "as is" without express or implied warranty.

KAZUTAKA YOKOTA DISCLAIMS ALL WARRANTIES WITH REGARD TO THIS SOFTWARE, INCLUDING ALL IMPLIED WARRANTIES OF MERCHANTABILITY AND FITNESS, IN NO EVENT SHALL KAZUTAKA YOKOTA BE LIABLE FOR ANY SPECIAL, INDIRECT OR CONSEQUENTIAL DAMAGES OR ANY DAMAGES WHATSOEVER RESULTING FROM LOSS OF USE, DATA OR PROFITS, WHETHER IN AN ACTION OF CONTRACT, NEGLIGENCE OR OTHER TORTIOUS ACTION, ARISING OUT OF OR IN CONNECTION WITH THE USE OR PERFORMANCE OF THIS SOFTWARE.

Copyright 1997,1998 by UCHIYAMA Yasushi

Permission to use, copy, modify, distribute, and sell this software and its documentation for any purpose is hereby granted without fee, provided that the above copyright notice appear in all copies and that both that copyright notice and this permission notice appear in supporting documentation, and that the name of UCHIYAMA Yasushi not be used in

advertising or publicity pertaining to distribution of the software without specific, written prior permission. UCHIYAMA Yasushi makes no representations about the suitability of this software for any purpose. It is provided "as is" without express or implied warranty.

UCHIYAMA YASUSHI DISCLAIMS ALL WARRANTIES WITH REGARD TO THIS SOFTWARE, INCLUDING ALL IMPLIED WARRANTIES OF MERCHANTABILITY AND FITNESS, IN NO EVENT SHALL UCHIYAMA YASUSHI BE LIABLE FOR ANY SPECIAL, INDIRECT OR CONSEQUENTIAL DAMAGES OR ANY DAMAGES WHATSOEVER RESULTING FROM LOSS OF USE, DATA OR PROFITS, WHETHER IN AN ACTION OF CONTRACT, NEGLIGENCE OR OTHER TORTIOUS ACTION, ARISING OUT OF OR IN CONNECTION WITH THE USE OR PERFORMANCE OF THIS SOFTWARE.

Copyright 2001 - 2005 by J. Kean Johnston <jkj@sco.com>

Permission to use, copy, modify, distribute, and sell this software and its documentation for any purpose is hereby granted without fee, provided that the above copyright notice appear in all copies and that both that copyright notice and this permission notice appear in supporting documentation, and that the name J. Kean Johnston not be used in advertising or publicity pertaining to distribution of the software without specific, written prior permission. J. Kean Johnston makes no representations about the suitability of this software for any purpose. It is provided "as is" without express or implied warranty.

J. KEAN JOHNSTON DISCLAIMS ALL WARRANTIES WITH REGARD TO THIS SOFTWARE, INCLUDING ALL IMPLIED WARRANTIES OF MERCHANTABILITY AND FITNESS, IN NO EVENT SHALL J. KEAN JOHNSTON BE LIABLE FOR ANY SPECIAL, INDIRECT OR CONSEQUENTIAL DAMAGES OR ANY DAMAGES WHATSOEVER RESULTING FROM LOSS OF USE, DATA OR PROFITS, WHETHER IN AN ACTION OF CONTRACT, NEGLIGENCE OR OTHER TORTIOUS ACTION, ARISING OUT OF OR IN CONNECTION WITH THE USE OR PERFORMANCE OF THIS SOFTWARE.

Copyright 2002, 2003, 2005 Tungsten Graphics, Inc., Cedar Park, Texas.
All Rights Reserved.

Permission is hereby granted, free of charge, to any person obtaining a

copy of this software and associated documentation files (the "Software"), to deal in the Software without restriction, including without limitation the rights to use, copy, modify, merge, publish, distribute, sub license, and/or sell copies of the Software, and to permit persons to whom the Software is furnished to do so, subject to the following conditions:

The above copyright notice and this permission notice (including the next paragraph) shall be included in all copies or substantial portions of the Software.

THE SOFTWARE IS PROVIDED "AS IS", WITHOUT WARRANTY OF ANY KIND, EXPRESS OR IMPLIED, INCLUDING BUT NOT LIMITED TO THE WARRANTIES OF MERCHANTABILITY, FITNESS FOR A PARTICULAR PURPOSE AND NON-INFRINGEMENT. IN NO EVENT SHALL TUNGSTEN GRAPHICS AND/OR ITS SUPPLIERS BE LIABLE FOR ANY CLAIM, DAMAGES OR OTHER LIABILITY, WHETHER IN AN ACTION OF CONTRACT, TORT OR OTHERWISE, ARISING FROM, OUT OF OR IN CONNECTION WITH THE SOFTWARE OR THE USE OR OTHER DEALINGS IN THE SOFTWARE.

Copyright (c) 2005 Jesse Barnes <jbarnes@virtuousgeek.org>

Copyright © 2002 David Dawes

Copyright 1998–1999 Precision Insight, Inc., Cedar Park, Texas.

All Rights Reserved.

Permission is hereby granted, free of charge, to any person obtaining a copy of this software and associated documentation files (the "Software"), to deal in the Software without restriction, including without limitation the rights to use, copy, modify, merge, publish, distribute, sub license, and/or sell copies of the Software, and to permit persons to whom the Software is furnished to do so, subject to the following conditions:

The above copyright notice and this permission notice (including the next paragraph) shall be included in all copies or substantial portions of the Software.

THE SOFTWARE IS PROVIDED "AS IS", WITHOUT WARRANTY OF ANY KIND, EXPRESS

OR IMPLIED, INCLUDING BUT NOT LIMITED TO THE WARRANTIES OF MERCHANTABILITY, FITNESS FOR A PARTICULAR PURPOSE AND NON-INFRINGEMENT. IN NO EVENT SHALL PRECISION INSIGHT AND/OR ITS SUPPLIERS BE LIABLE FOR ANY CLAIM, DAMAGES OR OTHER LIABILITY, WHETHER IN AN ACTION OF CONTRACT, TORT OR OTHERWISE, ARISING FROM, OUT OF OR IN CONNECTION WITH THE SOFTWARE OR THE USE OR OTHER DEALINGS IN THE SOFTWARE.

Copyright © 2006 – 2010 Intel Corporation

Copyright © 2007 Red Hat, Inc.

Permission is hereby granted, free of charge, to any person obtaining a copy of this software and associated documentation files (the "Software"), to deal in the Software without restriction, including without limitation the rights to use, copy, modify, merge, publish, distribute, sublicense, and/or sell copies of the Software, and to permit persons to whom the Software is furnished to do so, subject to the following conditions:

The above copyright notice and this permission notice (including the next paragraph) shall be included in all copies or substantial portions of the Software.

THE SOFTWARE IS PROVIDED "AS IS", WITHOUT WARRANTY OF ANY KIND, EXPRESS OR IMPLIED, INCLUDING BUT NOT LIMITED TO THE WARRANTIES OF MERCHANTABILITY, FITNESS FOR A PARTICULAR PURPOSE AND NON-INFRINGEMENT. IN NO EVENT SHALL THE AUTHORS OR COPYRIGHT HOLDERS BE LIABLE FOR ANY CLAIM, DAMAGES OR OTHER LIABILITY, WHETHER IN AN ACTION OF CONTRACT, TORT OR OTHERWISE, ARISING FROM, OUT OF OR IN CONNECTION WITH THE SOFTWARE OR THE USE OR OTHER DEALINGS IN THE SOFTWARE.

Copyright 2000 by Alan Hourihane, Sychdyn, North Wales, UK.

Permission to use, copy, modify, distribute, and sell this software and its documentation for any purpose is hereby granted without fee, provided that the above copyright notice appear in all copies and that both that copyright notice and this permission notice appear in supporting documentation, and that the name of Alan Hourihane not be used in advertising or publicity pertaining to distribution of the software without specific, written prior permission. Alan Hourihane makes no representations

about the suitability of this software for any purpose. It is provided "as is" without express or implied warranty.

ALAN HOURIHANE DISCLAIMS ALL WARRANTIES WITH REGARD TO THIS SOFTWARE, INCLUDING ALL IMPLIED WARRANTIES OF MERCHANTABILITY AND FITNESS, IN NO EVENT SHALL ALAN HOURIHANE BE LIABLE FOR ANY SPECIAL, INDIRECT OR CONSEQUENTIAL DAMAGES OR ANY DAMAGES WHATSOEVER RESULTING FROM LOSS OF USE, DATA OR PROFITS, WHETHER IN AN ACTION OF CONTRACT, NEGLIGENCE OR OTHER TORTIOUS ACTION, ARISING OUT OF OR IN CONNECTION WITH THE USE OR PERFORMANCE OF THIS SOFTWARE.

Copyright 2000 Intel Corporation. All Rights Reserved.

Permission is hereby granted, free of charge, to any person obtaining a copy of this software and associated documentation files (the "Software"), to deal in the Software without restriction, including without limitation the rights to use, copy, modify, merge, publish, distribute, sub license, and/or sell copies of the Software, and to permit persons to whom the Software is furnished to do so, subject to the following conditions:

The above copyright notice and this permission notice (including the next paragraph) shall be included in all copies or substantial portions of the Software.

THE SOFTWARE IS PROVIDED "AS IS", WITHOUT WARRANTY OF ANY KIND, EXPRESS OR IMPLIED, INCLUDING BUT NOT LIMITED TO THE WARRANTIES OF MERCHANTABILITY, FITNESS FOR A PARTICULAR PURPOSE AND NON-INFRINGEMENT. IN NO EVENT SHALL INTEL, AND/OR ITS SUPPLIERS BE LIABLE FOR ANY CLAIM, DAMAGES OR OTHER LIABILITY, WHETHER IN AN ACTION OF CONTRACT, TORT OR OTHERWISE, ARISING FROM, OUT OF OR IN CONNECTION WITH THE SOFTWARE OR THE USE OR OTHER DEALINGS IN THE SOFTWARE.

Copyright 2001 VA Linux Systems Inc., Fremont, California.

Copyright © 2002 by David Dawes

All Rights Reserved.

Permission is hereby granted, free of charge, to any person obtaining a copy of this software and associated documentation files (the "Software"), to deal in the Software without restriction, including without limitation on the rights to use, copy, modify, merge, publish, distribute, sublicense, and/or sell copies of the Software, and to permit persons to whom the Software is furnished to do so, subject to the following conditions:

The above copyright notice and this permission notice (including the next paragraph) shall be included in all copies or substantial portions of the Software.

THE SOFTWARE IS PROVIDED "AS IS", WITHOUT WARRANTY OF ANY KIND, EXPRESS OR IMPLIED, INCLUDING BUT NOT LIMITED TO THE WARRANTIES OF MERCHANTABILITY, FITNESS FOR A PARTICULAR PURPOSE AND NON-INFRINGEMENT. IN NO EVENT SHALL ATI, VA LINUX SYSTEMS AND/OR THEIR SUPPLIERS BE LIABLE FOR ANY CLAIM, DAMAGES OR OTHER LIABILITY, WHETHER IN AN ACTION OF CONTRACT, TORT OR OTHERWISE, ARISING FROM, OUT OF OR IN CONNECTION WITH THE SOFTWARE OR THE USE OR OTHER DEALINGS IN THE SOFTWARE.

Copyright © 2000–2001 Juliusz Chroboczek

Copyright © 1998 Egbert Eich

Copyright © 2006–2007 Intel Corporation

Copyright © 2006 Nokia Corporation

Copyright © 2006–2008 Peter Hutterer

Copyright © 2006 Adam Jackson

Copyright © 2009 NVIDIA Corporation

Copyright © 1999 Keith Packard

Copyright © 2007–2009 Red Hat, Inc.

Copyright © 2005–2008 Daniel Stone

Copyright © 2006–2009 Simon Thum

Copyright © 1987, 2003–2006, 2008–2009 Sun Microsystems, Inc.

Copyright © 2006 Luc Verhaegen

Permission is hereby granted, free of charge, to any person obtaining a copy of this software and associated documentation files (the "Software"), to deal in the Software without restriction, including without limitation the rights to use, copy, modify, merge, publish, distribute, sublicense,

and/or sell copies of the Software, and to permit persons to whom the Software is furnished to do so, subject to the following conditions:

The above copyright notice and this permission notice (including the next paragraph) shall be included in all copies or substantial portions of the Software.

THE SOFTWARE IS PROVIDED "AS IS", WITHOUT WARRANTY OF ANY KIND, EXPRESS OR IMPLIED, INCLUDING BUT NOT LIMITED TO THE WARRANTIES OF MERCHANTABILITY, FITNESS FOR A PARTICULAR PURPOSE AND NONINFRINGEMENT. IN NO EVENT SHALL THE AUTHORS OR COPYRIGHT HOLDERS BE LIABLE FOR ANY CLAIM, DAMAGES OR OTHER LIABILITY, WHETHER IN AN ACTION OF CONTRACT, TORT OR OTHERWISE, ARISING FROM, OUT OF OR IN CONNECTION WITH THE SOFTWARE OR THE USE OR OTHER DEALINGS IN THE SOFTWARE.

Copyright (C) 1994–2003 The XFree86 Project, Inc. All Rights Reserved.

Copyright (C) Colin Harrison 2005–2008

Permission is hereby granted, free of charge, to any person obtaining a copy of this software and associated documentation files (the "Software"), to deal in the Software without restriction, including without limitation the rights to use, copy, modify, merge, publish, distribute, sublicense, and/or sell copies of the Software, and to permit persons to whom the Software is furnished to do so, subject to the following conditions:

The above copyright notice and this permission notice shall be included in all copies or substantial portions of the Software.

THE SOFTWARE IS PROVIDED "AS IS", WITHOUT WARRANTY OF ANY KIND, EXPRESS OR IMPLIED, INCLUDING BUT NOT LIMITED TO THE WARRANTIES OF MERCHANTABILITY, FITNESS FOR A PARTICULAR PURPOSE AND NONINFRINGEMENT. IN NO EVENT SHALL THE XFREE86 PROJECT BE LIABLE FOR ANY CLAIM, DAMAGES OR OTHER LIABILITY, WHETHER IN AN ACTION OF CONTRACT, TORT OR OTHERWISE, ARISING FROM, OUT OF OR IN CONNECTION WITH THE SOFTWARE OR THE USE OR OTHER DEALINGS IN THE SOFTWARE.

Except as contained in this notice, the name of the XFree86 Project shall not be used in advertising or otherwise to promote the sale, use or other dealings

in this Software without prior written authorization from the XFree86 Project.

Copyright 1985–1998, 2001 The Open Group
Copyright 2002 Red Hat Inc., Durham, North Carolina.

Permission to use, copy, modify, distribute, and sell this software and its documentation for any purpose is hereby granted without fee, provided that the above copyright notice appear in all copies and that both that copyright notice and this permission notice appear in supporting documentation.

The above copyright notice and this permission notice shall be included in all copies or substantial portions of the Software.

THE SOFTWARE IS PROVIDED "AS IS", WITHOUT WARRANTY OF ANY KIND, EXPRESS OR IMPLIED, INCLUDING BUT NOT LIMITED TO THE WARRANTIES OF MERCHANTABILITY, FITNESS FOR A PARTICULAR PURPOSE AND NONINFRINGEMENT. IN NO EVENT SHALL THE OPEN GROUP BE LIABLE FOR ANY CLAIM, DAMAGES OR OTHER LIABILITY, WHETHER IN AN ACTION OF CONTRACT, TORT OR OTHERWISE, ARISING FROM, OUT OF OR IN CONNECTION WITH THE SOFTWARE OR THE USE OR OTHER DEALINGS IN THE SOFTWARE.

Except as contained in this notice, the name of The Open Group shall not be used in advertising or otherwise to promote the sale, use or other dealings in this Software without prior written authorization from The Open Group.

Copyright (c) 1987, 1989–1990, 1992–1995 X Consortium

Permission is hereby granted, free of charge, to any person obtaining a copy of this software and associated documentation files (the "Software"), to deal in the Software without restriction, including without limitation the rights to use, copy, modify, merge, publish, distribute, sublicense, and/or sell copies of the Software, and to permit persons to whom the Software is furnished to do so, subject to the following conditions:

The above copyright notice and this permission notice shall be included in all copies or substantial portions of the Software.

THE SOFTWARE IS PROVIDED "AS IS", WITHOUT WARRANTY OF ANY KIND, EXPRESS OR IMPLIED, INCLUDING BUT NOT LIMITED TO THE WARRANTIES OF MERCHANTABILITY, FITNESS FOR A PARTICULAR PURPOSE AND NONINFRINGEMENT. IN NO EVENT SHALL THE X CONSORTIUM BE LIABLE FOR ANY CLAIM, DAMAGES OR OTHER LIABILITY, WHETHER IN AN ACTION OF CONTRACT, TORT OR OTHERWISE, ARISING FROM, OUT OF OR IN CONNECTION WITH THE SOFTWARE OR THE USE OR OTHER DEALINGS IN THE SOFTWARE.

Except as contained in this notice, the name of the X Consortium shall not be used in advertising or otherwise to promote the sale, use or other dealings in this Software without prior written authorization from the X Consortium.

Copyright © 1999–2000 SuSE, Inc.

Copyright © 2007, 2008 Red Hat, Inc.

Permission to use, copy, modify, distribute, and sell this software and its documentation for any purpose is hereby granted without fee, provided that the above copyright notice appear in all copies and that both that copyright notice and this permission notice appear in supporting documentation, and that the name of SuSE not be used in advertising or publicity pertaining to distribution of the software without specific, written prior permission. SuSE makes no representations about the suitability of this software for any purpose. It is provided "as is" without express or implied warranty.

SuSE DISCLAIMS ALL WARRANTIES WITH REGARD TO THIS SOFTWARE, INCLUDING ALL IMPLIED WARRANTIES OF MERCHANTABILITY AND FITNESS, IN NO EVENT SHALL SuSE BE LIABLE FOR ANY SPECIAL, INDIRECT OR CONSEQUENTIAL DAMAGES OR ANY DAMAGES WHATSOEVER RESULTING FROM LOSS OF USE, DATA OR PROFITS, WHETHER IN AN ACTION OF CONTRACT, NEGLIGENCE OR OTHER TORTIOUS ACTION, ARISING OUT OF OR IN CONNECTION WITH THE USE OR PERFORMANCE OF THIS SOFTWARE.

Copyright 1987–1991, 1993 by Digital Equipment Corporation, Maynard, Massachusetts.

Copyright 1991 Massachusetts Institute of Technology, Cambridge, Massachusetts.

Copyright 1991, 1993 Olivetti Research Limited, Cambridge, England.

All Rights Reserved

Permission to use, copy, modify, and distribute this software and its documentation for any purpose and without fee is hereby granted, provided that the above copyright notice appear in all copies and that both that copyright notice and this permission notice appear in supporting documentation, and that the name of Digital not be used in advertising or publicity pertaining to distribution of the software without specific, written prior permission.

DIGITAL DISCLAIMS ALL WARRANTIES WITH REGARD TO THIS SOFTWARE, INCLUDING ALL IMPLIED WARRANTIES OF MERCHANTABILITY AND FITNESS, IN NO EVENT SHALL DIGITAL BE LIABLE FOR ANY SPECIAL, INDIRECT OR CONSEQUENTIAL DAMAGES OR ANY DAMAGES WHATSOEVER RESULTING FROM LOSS OF USE, DATA OR PROFITS, WHETHER IN AN ACTION OF CONTRACT, NEGLIGENCE OR OTHER TORTIOUS ACTION, ARISING OUT OF OR IN CONNECTION WITH THE USE OR PERFORMANCE OF THIS SOFTWARE.

Copyright 1987 by Digital Equipment Corporation, Maynard, Massachusetts,
Copyright 1994 Quarterdeck Office Systems.

All Rights Reserved

Permission to use, copy, modify, and distribute this software and its documentation for any purpose and without fee is hereby granted, provided that the above copyright notice appear in all copies and that both that copyright notice and this permission notice appear in supporting documentation, and that the names of Digital and Quarterdeck not be used in advertising or publicity pertaining to distribution of the software without specific, written prior permission.

DIGITAL AND QUARTERDECK DISCLAIM ALL WARRANTIES WITH REGARD TO THIS SOFTWARE, INCLUDING ALL IMPLIED WARRANTIES OF MERCHANTABILITY AND FITNESS, IN NO EVENT SHALL DIGITAL BE LIABLE FOR ANY SPECIAL, INDIRECT OR CONSEQUENTIAL DAMAGES OR ANY DAMAGES WHATSOEVER RESULTING FROM LOSS OF USE, DATA OR PROFITS, WHETHER IN AN ACTION OF CONTRACT, NEGLIGENCE

OR OTHER TORTIOUS ACTION, ARISING OUT OF OR IN CONNECTION WITH THE USE OR PERFORMANCE OF THIS SOFTWARE.

Copyright 1997 Digital Equipment Corporation.
All rights reserved.

This software is furnished under license and may be used and copied only in accordance with the following terms and conditions. Subject to these conditions, you may download, copy, install, use, modify and distribute this software in source and/or binary form. No title or ownership is transferred hereby.

- 1) Any source code used, modified or distributed must reproduce and retain this copyright notice and list of conditions as they appear in the source file.
- 2) No right is granted to use any trade name, trademark, or logo of Digital Equipment Corporation. Neither the "Digital Equipment Corporation" name nor any trademark or logo of Digital Equipment Corporation may be used to endorse or promote products derived from this software without the prior written permission of Digital Equipment Corporation.
- 3) This software is provided "AS-IS" and any express or implied warranties, including but not limited to, any implied warranties of merchantability, fitness for a particular purpose, or non-infringement are disclaimed. In no event shall DIGITAL be liable for any damages whatsoever, and in particular, DIGITAL shall not be liable for special, indirect, consequential, or incidental damages or damages for lost profits, loss of revenue or loss of use, whether such damages arise in contract, negligence, tort, under statute, in equity, at law or otherwise, even if advised of the possibility of such damage.

Copyright 2001–2005 Red Hat Inc., Durham, North Carolina.
Copyright (c) 2003 by the XFree86 Project, Inc.
All Rights Reserved.

Permission is hereby granted, free of charge, to any person obtaining a copy of this software and associated documentation files (the "Software"), to deal in the Software without restriction, including without limitation on the rights to use, copy, modify, merge, publish, distribute, sublicense, and/or sell copies of the Software, and to permit persons to whom the Software is furnished to do so, subject to the following conditions:

The above copyright notice and this permission notice (including the next paragraph) shall be included in all copies or substantial portions of the Software.

THE SOFTWARE IS PROVIDED "AS IS", WITHOUT WARRANTY OF ANY KIND, EXPRESS OR IMPLIED, INCLUDING BUT NOT LIMITED TO THE WARRANTIES OF MERCHANTABILITY, FITNESS FOR A PARTICULAR PURPOSE AND NON-INFRINGEMENT. IN NO EVENT SHALL RED HAT AND/OR THEIR SUPPLIERS BE LIABLE FOR ANY CLAIM, DAMAGES OR OTHER LIABILITY, WHETHER IN AN ACTION OF CONTRACT, TORT OR OTHERWISE, ARISING FROM, OUT OF OR IN CONNECTION WITH THE SOFTWARE OR THE USE OR OTHER DEALINGS IN THE SOFTWARE.

Copyright © 2006 Red Hat, Inc.

(C) Copyright 1998–1999 Precision Insight, Inc., Cedar Park, Texas.

All Rights Reserved.

Permission is hereby granted, free of charge, to any person obtaining a copy of this software and associated documentation files (the "Software"), to deal in the Software without restriction, including without limitation the rights to use, copy, modify, merge, publish, distribute, sub license, and/or sell copies of the Software, and to permit persons to whom the Software is furnished to do so, subject to the following conditions:

The above copyright notice and this permission notice (including the next paragraph) shall be included in all copies or substantial portions of the Software.

THE SOFTWARE IS PROVIDED "AS IS", WITHOUT WARRANTY OF ANY KIND, EXPRESS OR

IMPLIED, INCLUDING BUT NOT LIMITED TO THE WARRANTIES OF MERCHANTABILITY, FITNESS FOR A PARTICULAR PURPOSE AND NON-INFRINGEMENT. IN NO EVENT SHALL RED HAT, INC, OR PRECISION INSIGHT AND/OR THEIR SUPPLIERS BE LIABLE FOR ANY CLAIM, DAMAGES OR OTHER LIABILITY, WHETHER IN AN ACTION OF CONTRACT, TORT OR OTHERWISE, ARISING FROM, OUT OF OR IN CONNECTION WITH THE SOFTWARE OR THE USE OR OTHER DEALINGS IN THE SOFTWARE.

Copyright (c) 1995 X Consortium

Copyright 2004 Red Hat Inc., Durham, North Carolina.

All Rights Reserved.

Permission is hereby granted, free of charge, to any person obtaining a copy of this software and associated documentation files (the "Software"), to deal in the Software without restriction, including without limitation on the rights to use, copy, modify, merge, publish, distribute, sublicense, and/or sell copies of the Software, and to permit persons to whom the Software is furnished to do so, subject to the following conditions:

The above copyright notice and this permission notice shall be included in all copies or substantial portions of the Software.

THE SOFTWARE IS PROVIDED "AS IS", WITHOUT WARRANTY OF ANY KIND, EXPRESS OR IMPLIED, INCLUDING BUT NOT LIMITED TO THE WARRANTIES OF MERCHANTABILITY, FITNESS FOR A PARTICULAR PURPOSE AND NON-INFRINGEMENT. IN NO EVENT SHALL RED HAT, THE X CONSORTIUM, AND/OR THEIR SUPPLIERS BE LIABLE FOR ANY CLAIM, DAMAGES OR OTHER LIABILITY, WHETHER IN AN ACTION OF CONTRACT, TORT OR OTHERWISE, ARISING FROM, OUT OF OR IN CONNECTION WITH THE SOFTWARE OR THE USE OR OTHER DEALINGS IN THE SOFTWARE.

Except as contained in this notice, the name of the X Consortium shall not be used in advertising or otherwise to promote the sale, use or other dealings in this Software without prior written authorization from the X Consortium.

Copyright 1998–2000 Precision Insight, Inc., Cedar Park, Texas.

Copyright 2000 VA Linux Systems, Inc.

Copyright (c) 2002, 2008, 2009 Apple Computer, Inc.

Copyright (c) 2003–2004 Torrey T. Lyons.

All Rights Reserved.

Permission is hereby granted, free of charge, to any person obtaining a copy of this software and associated documentation files (the "Software"), to deal in the Software without restriction, including without limitation the rights to use, copy, modify, merge, publish, distribute, sub license, and/or sell copies of the Software, and to permit persons to whom the Software is furnished to do so, subject to the following conditions:

The above copyright notice and this permission notice (including the next paragraph) shall be included in all copies or substantial portions of the Software.

THE SOFTWARE IS PROVIDED "AS IS", WITHOUT WARRANTY OF ANY KIND, EXPRESS OR IMPLIED, INCLUDING BUT NOT LIMITED TO THE WARRANTIES OF MERCHANTABILITY, FITNESS FOR A PARTICULAR PURPOSE AND NON-INFRINGEMENT. IN NO EVENT SHALL PRECISION INSIGHT AND/OR ITS SUPPLIERS BE LIABLE FOR ANY CLAIM, DAMAGES OR OTHER LIABILITY, WHETHER IN AN ACTION OF CONTRACT, TORT OR OTHERWISE, ARISING FROM, OUT OF OR IN CONNECTION WITH THE SOFTWARE OR THE USE OR OTHER DEALINGS IN THE SOFTWARE.

(C) Copyright IBM Corporation 2002 – 2007

All Rights Reserved.

Permission is hereby granted, free of charge, to any person obtaining a copy of this software and associated documentation files (the "Software"), to deal in the Software without restriction, including without limitation the rights to use, copy, modify, merge, publish, distribute, sub license, and/or sell copies of the Software, and to permit persons to whom the Software is furnished to do so, subject to the following conditions:

The above copyright notice and this permission notice (including the next

paragraph) shall be included in all copies or substantial portions of the Software.

THE SOFTWARE IS PROVIDED "AS IS", WITHOUT WARRANTY OF ANY KIND, EXPRESS OR IMPLIED, INCLUDING BUT NOT LIMITED TO THE WARRANTIES OF MERCHANTABILITY, FITNESS FOR A PARTICULAR PURPOSE AND NON-INFRINGEMENT. IN NO EVENT SHALL IBM, AND/OR THEIR SUPPLIERS BE LIABLE FOR ANY CLAIM, DAMAGES OR OTHER LIABILITY, WHETHER IN AN ACTION OF CONTRACT, TORT OR OTHERWISE, ARISING FROM, OUT OF OR IN CONNECTION WITH THE SOFTWARE OR THE USE OR OTHER DEALINGS IN THE SOFTWARE.

Copyright (c) 1997, 1998 Metro Link Incorporated

Permission is hereby granted, free of charge, to any person obtaining a copy of this software and associated documentation files (the "Software"), to deal in the Software without restriction, including without limitation the rights to use, copy, modify, merge, publish, distribute, sublicense, and/or sell copies of the Software, and to permit persons to whom the Software is furnished to do so, subject to the following conditions:

The above copyright notice and this permission notice shall be included in all copies or substantial portions of the Software.

THE SOFTWARE IS PROVIDED "AS IS", WITHOUT WARRANTY OF ANY KIND, EXPRESS OR IMPLIED, INCLUDING BUT NOT LIMITED TO THE WARRANTIES OF MERCHANTABILITY, FITNESS FOR A PARTICULAR PURPOSE AND NON-INFRINGEMENT. IN NO EVENT SHALL THE X CONSORTIUM BE LIABLE FOR ANY CLAIM, DAMAGES OR OTHER LIABILITY, WHETHER IN AN ACTION OF CONTRACT, TORT OR OTHERWISE, ARISING FROM, OUT OF OR IN CONNECTION WITH THE SOFTWARE OR THE USE OR OTHER DEALINGS IN THE SOFTWARE.

Except as contained in this notice, the name of the Metro Link shall not be used in advertising or otherwise to promote the sale, use or other dealings in this Software without prior written authorization from Metro Link.

Copyright 1995–1998 by Metro Link, Inc.

Copyright (c) 1997 Matthieu Herrb

Permission to use, copy, modify, distribute, and sell this software and its documentation for any purpose is hereby granted without fee, provided that the above copyright notice appear in all copies and that both that copyright notice and this permission notice appear in supporting documentation, and that the name of Metro Link, Inc. not be used in advertising or publicity pertaining to distribution of the software without specific, written prior permission. Metro Link, Inc. makes no representations about the suitability of this software for any purpose.

It is provided "as is" without express or implied warranty.

METRO LINK, INC. DISCLAIMS ALL WARRANTIES WITH REGARD TO THIS SOFTWARE, INCLUDING ALL IMPLIED WARRANTIES OF MERCHANTABILITY AND FITNESS, IN NO EVENT SHALL METRO LINK, INC. BE LIABLE FOR ANY SPECIAL, INDIRECT OR CONSEQUENTIAL DAMAGES OR ANY DAMAGES WHATSOEVER RESULTING FROM LOSS OF USE, DATA OR PROFITS, WHETHER IN AN ACTION OF CONTRACT, NEGLIGENCE OR OTHER TORTIOUS ACTION, ARISING OUT OF OR IN CONNECTION WITH THE USE OR PERFORMANCE OF THIS SOFTWARE.

Copyright (c) 2000 by Conectiva S.A. (<http://www.conectiva.com>)

Permission is hereby granted, free of charge, to any person obtaining a copy of this software and associated documentation files (the "Software"), to deal in the Software without restriction, including without limitation the rights to use, copy, modify, merge, publish, distribute, sublicense, and/or sell copies of the Software, and to permit persons to whom the Software is furnished to do so, subject to the following conditions:

The above copyright notice and this permission notice shall be included in all copies or substantial portions of the Software.

THE SOFTWARE IS PROVIDED "AS IS", WITHOUT WARRANTY OF ANY KIND, EXPRESS OR IMPLIED, INCLUDING BUT NOT LIMITED TO THE WARRANTIES OF MERCHANTABILITY, FITNESS FOR A PARTICULAR PURPOSE AND NONINFRINGEMENT. IN NO EVENT SHALL CONECTIVA LINUX BE LIABLE FOR ANY CLAIM, DAMAGES OR OTHER LIABILITY,

WHETHER IN AN ACTION OF CONTRACT, TORT OR OTHERWISE, ARISING FROM, OUT OF OR IN CONNECTION WITH THE SOFTWARE OR THE USE OR OTHER DEALINGS IN THE SOFTWARE.

Except as contained in this notice, the name of Conectiva Linux shall not be used in advertising or otherwise to promote the sale, use or other dealings in this Software without prior written authorization from Conectiva Linux.

Copyright (c) 2001, Andy Ritger aritger@nvidia.com
All rights reserved.

Redistribution and use in source and binary forms, with or without modification, are permitted provided that the following conditions are met:

- o Redistributions of source code must retain the above copyright notice, this list of conditions and the following disclaimer.
- o Redistributions in binary form must reproduce the above copyright notice, this list of conditions and the following disclaimer in the documentation and/or other materials provided with the distribution.
- o Neither the name of NVIDIA nor the names of its contributors may be used to endorse or promote products derived from this software without specific prior written permission.

THIS SOFTWARE IS PROVIDED BY THE COPYRIGHT HOLDERS AND CONTRIBUTORS "AS IS" AND ANY EXPRESS OR IMPLIED WARRANTIES, INCLUDING, BUT NOT LIMITED TO, THE IMPLIED WARRANTIES OF MERCHANTABILITY AND FITNESS FOR A PARTICULAR PURPOSE ARE DISCLAIMED. IN NO EVENT SHALL THE REGENTS OR CONTRIBUTORS BE LIABLE FOR ANY DIRECT, INDIRECT, INCIDENTAL, SPECIAL, EXEMPLARY, OR CONSEQUENTIAL DAMAGES (INCLUDING, BUT NOT LIMITED TO, PROCUREMENT OF SUBSTITUTE GOODS OR SERVICES; LOSS OF USE, DATA, OR PROFITS; OR BUSINESS INTERRUPTION) HOWEVER CAUSED AND ON ANY THEORY OF LIABILITY, WHETHER IN CONTRACT, STRICT LIABILITY, OR TORT (INCLUDING NEGLIGENCE OR OTHERWISE) ARISING IN ANY WAY OUT OF THE USE OF THIS SOFTWARE, EVEN IF ADVISED OF THE

POSSIBILITY OF SUCH DAMAGE.

Copyright 1992 Vrije Universiteit, The Netherlands

Permission to use, copy, modify, and distribute this software and its documentation for any purpose and without fee is hereby granted, provided that the above copyright notice appear in all copies and that both that copyright notice and this permission notice appear in supporting documentation, and that the name of the Vrije Universiteit not be used in advertising or publicity pertaining to distribution of the software without specific, written prior permission. The Vrije Universiteit makes no representations about the suitability of this software for any purpose. It is provided "as is" without express or implied warranty.

The Vrije Universiteit DISCLAIMS ALL WARRANTIES WITH REGARD TO THIS SOFTWARE, INCLUDING ALL IMPLIED WARRANTIES OF MERCHANTABILITY AND FITNESS, IN NO EVENT SHALL The Vrije Universiteit BE LIABLE FOR ANY SPECIAL, INDIRECT OR CONSEQUENTIAL DAMAGES OR ANY DAMAGES WHATSOEVER RESULTING FROM LOSS OF USE, DATA OR PROFITS, WHETHER IN AN ACTION OF CONTRACT, NEGLIGENCE OR OTHER TORTIOUS ACTION, ARISING OUT OF OR IN CONNECTION WITH THE USE OR PERFORMANCE OF THIS SOFTWARE.

Copyright 1998 by Concurrent Computer Corporation

Permission to use, copy, modify, distribute, and sell this software and its documentation for any purpose is hereby granted without fee, provided that the above copyright notice appear in all copies and that both that copyright notice and this permission notice appear in supporting documentation, and that the name of Concurrent Computer Corporation not be used in advertising or publicity pertaining to distribution of the software without specific, written prior permission. Concurrent Computer Corporation makes no representations about the suitability of this software for any purpose. It is provided "as is" without express or implied warranty.

CONCURRENT COMPUTER CORPORATION DISCLAIMS ALL WARRANTIES WITH REGARD

TO THIS SOFTWARE, INCLUDING ALL IMPLIED WARRANTIES OF MERCHANTABILITY AND FITNESS, IN NO EVENT SHALL CONCURRENT COMPUTER CORPORATION BE LIABLE FOR ANY SPECIAL, INDIRECT OR CONSEQUENTIAL DAMAGES OR ANY DAMAGES WHATSOEVER RESULTING FROM LOSS OF USE, DATA OR PROFITS, WHETHER IN AN ACTION OF CONTRACT, NEGLIGENCE OR OTHER TORTIOUS ACTION, ARISING OUT OF OR IN CONNECTION WITH THE USE OR PERFORMANCE OF THIS SOFTWARE.

Copyright © 2004 Nokia

Permission to use, copy, modify, distribute, and sell this software and its documentation for any purpose is hereby granted without fee, provided that the above copyright notice appear in all copies and that both that copyright notice and this permission notice appear in supporting documentation, and that the name of Nokia not be used in advertising or publicity pertaining to distribution of the software without specific, written prior permission. Nokia makes no representations about the suitability of this software for any purpose. It is provided "as is" without express or implied warranty.

NOKIA DISCLAIMS ALL WARRANTIES WITH REGARD TO THIS SOFTWARE, INCLUDING ALL IMPLIED WARRANTIES OF MERCHANTABILITY AND FITNESS, IN NO EVENT SHALL NOKIA BE LIABLE FOR ANY SPECIAL, INDIRECT OR CONSEQUENTIAL DAMAGES OR ANY DAMAGES WHATSOEVER RESULTING FROM LOSS OF USE, DATA OR PROFITS, WHETHER IN AN ACTION OF CONTRACT, NEGLIGENCE OR OTHER TORTIOUS ACTION, ARISING OUT OF OR IN CONNECTION WITH THE USE OR PERFORMANCE OF THIS SOFTWARE.

(c)Copyright 1988,1991 Adobe Systems Incorporated.
All rights reserved.

Permission to use, copy, modify, distribute, and sublicense this software and its documentation for any purpose and without fee is hereby granted, provided that the above copyright notices appear in all copies and that both those copyright notices and this permission notice appear in supporting documentation and that the name of Adobe Systems Incorporated not be used in advertising or publicity

pertaining to distribution of the software without specific, written prior permission. No trademark license to use the Adobe trademarks is hereby granted. If the Adobe trademark "Display PostScript"(tm) is used to describe this software, its functionality or for any other purpose, such use shall be limited to a statement that this software works in conjunction with the Display PostScript system. Proper trademark attribution to reflect Adobe's ownership of the trademark shall be given whenever any such reference to the Display PostScript system is made.

ADOBE MAKES NO REPRESENTATIONS ABOUT THE SUITABILITY OF THE SOFTWARE FOR ANY PURPOSE. IT IS PROVIDED "AS IS" WITHOUT EXPRESS OR IMPLIED WARRANTY. ADOBE DISCLAIMS ALL WARRANTIES WITH REGARD TO THIS SOFTWARE, INCLUDING ALL IMPLIED WARRANTIES OF MERCHANTABILITY, FITNESS FOR A PARTICULAR PURPOSE AND NON-INFRINGEMENT OF THIRD PARTY RIGHTS. IN NO EVENT SHALL ADOBE BE LIABLE TO YOU OR ANY OTHER PARTY FOR ANY SPECIAL, INDIRECT, OR CONSEQUENTIAL DAMAGES OR ANY DAMAGES WHATSOEVER WHETHER IN AN ACTION OF CONTRACT, NEGLIGENCE, STRICT LIABILITY OR ANY OTHER ACTION ARISING OUT OF OR IN CONNECTION WITH THE USE OR PERFORMANCE OF THIS SOFTWARE. ADOBE WILL NOT PROVIDE ANY TRAINING OR OTHER SUPPORT FOR THE SOFTWARE.

Adobe, PostScript, and Display PostScript are trademarks of Adobe Systems Incorporated which may be registered in certain jurisdictions.

Copyright 1989 Network Computing Devices, Inc., Mountain View, California.

Permission to use, copy, modify, and distribute this software and its documentation for any purpose and without fee is hereby granted, provided that the above copyright notice appear in all copies and that both that copyright notice and this permission notice appear in supporting documentation, and that the name of N.C.D. not be used in advertising or publicity pertaining to distribution of the software without specific, written prior permission. N.C.D. makes no representations about the suitability of this software for any purpose. It is provided "as is" without express or implied warranty.

Copyright 1992, 1993 Data General Corporation;

Copyright 1992, 1993 OMRON Corporation

Permission to use, copy, modify, distribute, and sell this software and its documentation for any purpose is hereby granted without fee, provided that the above copyright notice appear in all copies and that both that copyright notice and this permission notice appear in supporting documentation, and that neither the name OMRON or DATA GENERAL be used in advertising or publicity pertaining to distribution of the software without specific, written prior permission of the party whose name is to be used. Neither OMRON or DATA GENERAL make any representation about the suitability of this software for any purpose. It is provided "as is" without express or implied warranty.

OMRON AND DATA GENERAL EACH DISCLAIM ALL WARRANTIES WITH REGARD TO THIS SOFTWARE, INCLUDING ALL IMPLIED WARRANTIES OF MERCHANTABILITY AND FITNESS, IN NO EVENT SHALL OMRON OR DATA GENERAL BE LIABLE FOR ANY SPECIAL, INDIRECT OR CONSEQUENTIAL DAMAGES OR ANY DAMAGES WHATSOEVER RESULTING FROM LOSS OF USE, DATA OR PROFITS, WHETHER IN AN ACTION OF CONTRACT, NEGLIGENCE OR OTHER TORTIOUS ACTION, ARISING OUT OF OR IN CONNECTION WITH THE USE OR PERFORMANCE OF THIS SOFTWARE.

Copyright © 1998–2004, 2006 Keith Packard

Copyright © 2000–2002 Keith Packard, member of The XFree86 Project, Inc.

Copyright (c) 2002 Apple Computer, Inc.

Copyright (c) 2003 Torrey T. Lyons.

All Rights Reserved.

Permission to use, copy, modify, distribute, and sell this software and its documentation for any purpose is hereby granted without fee, provided that the above copyright notice appear in all copies and that both that copyright notice and this permission notice appear in supporting documentation, and that the name of Keith Packard not be used in advertising or publicity pertaining to distribution of the software without specific, written prior permission. Keith Packard makes no representations about the suitability of this software for any purpose. It is provided "as is" without express or implied warranty.

KEITH PACKARD DISCLAIMS ALL WARRANTIES WITH REGARD TO THIS SOFTWARE,

INCLUDING ALL IMPLIED WARRANTIES OF MERCHANTABILITY AND FITNESS, IN NO EVENT SHALL KEITH PACKARD BE LIABLE FOR ANY SPECIAL, INDIRECT OR CONSEQUENTIAL DAMAGES OR ANY DAMAGES WHATSOEVER RESULTING FROM LOSS OF USE, DATA OR PROFITS, WHETHER IN AN ACTION OF CONTRACT, NEGLIGENCE OR OTHER TORTIOUS ACTION, ARISING OUT OF OR IN CONNECTION WITH THE USE OR PERFORMANCE OF THIS SOFTWARE.

Copyright © 1999 Keith Packard

Copyright © 2000 Compaq Computer Corporation

Copyright © 2002 MontaVista Software Inc.

Copyright © 2005 OpenedHand Ltd.

Copyright © 2006 Nokia Corporation

Permission to use, copy, modify, distribute, and sell this software and its documentation for any purpose is hereby granted without fee, provided that the above copyright notice appear in all copies and that both that copyright notice and this permission notice appear in supporting documentation, and that the name of the authors and/or copyright holders not be used in advertising or publicity pertaining to distribution of the software without specific, written prior permission. The authors and/or copyright holders make no representations about the suitability of this software for any purpose. It is provided "as is" without express or implied warranty.

THE AUTHORS AND/OR COPYRIGHT HOLDERS DISCLAIM ALL WARRANTIES WITH REGARD TO THIS SOFTWARE, INCLUDING ALL IMPLIED WARRANTIES OF MERCHANTABILITY AND FITNESS, IN NO EVENT SHALL THE AUTHORS AND/OR COPYRIGHT HOLDERS BE LIABLE FOR ANY SPECIAL, INDIRECT OR CONSEQUENTIAL DAMAGES OR ANY DAMAGES WHATSOEVER RESULTING FROM LOSS OF USE, DATA OR PROFITS, WHETHER IN AN ACTION OF CONTRACT, NEGLIGENCE OR OTHER TORTIOUS ACTION, ARISING OUT OF OR IN CONNECTION WITH THE USE OR PERFORMANCE OF THIS SOFTWARE.

Copyright 1993 by Davor Matic

Permission to use, copy, modify, distribute, and sell this software and its documentation for any purpose is hereby granted without fee,

provided that the above copyright notice appear in all copies and that both that copyright notice and this permission notice appear in supporting documentation. Davor Matic makes no representations about the suitability of this software for any purpose. It is provided "as is" without express or implied warranty.

Copyright (C) 2001–2004 Harold L Hunt II All Rights Reserved.

Copyright (C) Colin Harrison 2005–2008

Permission is hereby granted, free of charge, to any person obtaining a copy of this software and associated documentation files (the "Software"), to deal in the Software without restriction, including without limitation the rights to use, copy, modify, merge, publish, distribute, sublicense, and/or sell copies of the Software, and to permit persons to whom the Software is furnished to do so, subject to the following conditions:

The above copyright notice and this permission notice shall be included in all copies or substantial portions of the Software.

THE SOFTWARE IS PROVIDED "AS IS", WITHOUT WARRANTY OF ANY KIND, EXPRESS OR IMPLIED, INCLUDING BUT NOT LIMITED TO THE WARRANTIES OF MERCHANTABILITY, FITNESS FOR A PARTICULAR PURPOSE AND NONINFRINGEMENT. IN NO EVENT SHALL HAROLD L HUNT II BE LIABLE FOR ANY CLAIM, DAMAGES OR OTHER LIABILITY, WHETHER IN AN ACTION OF CONTRACT, TORT OR OTHERWISE, ARISING FROM, OUT OF OR IN CONNECTION WITH THE SOFTWARE OR THE USE OR OTHER DEALINGS IN THE SOFTWARE.

Except as contained in this notice, the name of Harold L Hunt II shall not be used in advertising or otherwise to promote the sale, use or other dealings in this Software without prior written authorization from Harold L Hunt II.

Copyright 1990,91 by Thomas Roell, Dinkelscherben, Germany.

Permission to use, copy, modify, distribute, and sell this software and its

documentation for any purpose is hereby granted without fee, provided that the above copyright notice appear in all copies and that both that copyright notice and this permission notice appear in supporting documentation, and that the name of Thomas Roell not be used in advertising or publicity pertaining to distribution of the software without specific, written prior permission. Thomas Roell makes no representations about the suitability of this software for any purpose. It is provided "as is" without express or implied warranty.

THOMAS ROELL DISCLAIMS ALL WARRANTIES WITH REGARD TO THIS SOFTWARE, INCLUDING ALL IMPLIED WARRANTIES OF MERCHANTABILITY AND FITNESS, IN NO EVENT SHALL THOMAS ROELL BE LIABLE FOR ANY SPECIAL, INDIRECT OR CONSEQUENTIAL DAMAGES OR ANY DAMAGES WHATSOEVER RESULTING FROM LOSS OF USE, DATA OR PROFITS, WHETHER IN AN ACTION OF CONTRACT, NEGLIGENCE OR OTHER TORTIOUS ACTION, ARISING OUT OF OR IN CONNECTION WITH THE USE OR PERFORMANCE OF THIS SOFTWARE.

Copyright 1990,91 by Thomas Roell, Dinkelscherben, Germany

Copyright 1993 by David Wexelblat <dwex@goblin.org>

Permission to use, copy, modify, distribute, and sell this software and its documentation for any purpose is hereby granted without fee, provided that the above copyright notice appear in all copies and that both that copyright notice and this permission notice appear in supporting documentation, and that the names of Thomas Roell and David Wexelblat not be used in advertising or publicity pertaining to distribution of the software without specific, written prior permission. Thomas Roell and David Wexelblat makes no representations about the suitability of this software for any purpose. It is provided "as is" without express or implied warranty.

THOMAS ROELL AND DAVID WEXELBLAT DISCLAIMS ALL WARRANTIES WITH REGARD TO THIS SOFTWARE, INCLUDING ALL IMPLIED WARRANTIES OF MERCHANTABILITY AND FITNESS, IN NO EVENT SHALL THOMAS ROELL OR DAVID WEXELBLAT BE LIABLE FOR ANY SPECIAL, INDIRECT OR CONSEQUENTIAL DAMAGES OR ANY DAMAGES WHATSOEVER RESULTING FROM LOSS OF USE, DATA OR PROFITS, WHETHER IN AN ACTION OF CONTRACT, NEGLIGENCE OR OTHER TORTIOUS ACTION, ARISING OUT OF OR IN

CONNECTION WITH THE USE OR PERFORMANCE OF THIS SOFTWARE.

Copyright 1990,91,92,93 by Thomas Roell, Germany.

Copyright 1991,92,93 by SGCS (Snitily Graphics Consulting Services), USA.

Permission to use, copy, modify, distribute, and sell this software and its documentation for any purpose is hereby granted without fee, provided that the above copyright notice appear in all copies and that both that copyright notice and this permission notice appear in supporting documentation, and that the name of Thomas Roell nor SGCS be used in advertising or publicity pertaining to distribution of the software without specific, written prior permission.

Thomas Roell nor SGCS makes no representations about the suitability of this software for any purpose. It is provided "as is" without express or implied warranty.

THOMAS ROELL AND SGCS DISCLAIMS ALL WARRANTIES WITH REGARD TO THIS SOFTWARE, INCLUDING ALL IMPLIED WARRANTIES OF MERCHANTABILITY AND FITNESS, IN NO EVENT SHALL THOMAS ROELL OR SGCS BE LIABLE FOR ANY SPECIAL, INDIRECT OR CONSEQUENTIAL DAMAGES OR ANY DAMAGES WHATSOEVER RESULTING FROM LOSS OF USE, DATA OR PROFITS, WHETHER IN AN ACTION OF CONTRACT, NEGLIGENCE OR OTHER TORTIOUS ACTION, ARISING OUT OF OR IN CONNECTION WITH THE USE OR PERFORMANCE OF THIS SOFTWARE.

Copyright 1998 by Alan Hourihane, Wigan, England.

Copyright 2000–2002 by Alan Hourihane, Flint Mountain, North Wales.

Permission to use, copy, modify, distribute, and sell this software and its documentation for any purpose is hereby granted without fee, provided that the above copyright notice appear in all copies and that both that copyright notice and this permission notice appear in supporting documentation, and that the name of Alan Hourihane not be used in advertising or publicity pertaining to distribution of the software without specific, written prior permission. Alan Hourihane makes no representations about the suitability of this software for any purpose. It is provided "as is" without express or implied warranty.

ALAN HOURIHANE DISCLAIMS ALL WARRANTIES WITH REGARD TO THIS SOFTWARE, INCLUDING ALL IMPLIED WARRANTIES OF MERCHANTABILITY AND FITNESS, IN NO EVENT SHALL ALAN HOURIHANE BE LIABLE FOR ANY SPECIAL, INDIRECT OR CONSEQUENTIAL DAMAGES OR ANY DAMAGES WHATSOEVER RESULTING FROM LOSS OF USE, DATA OR PROFITS, WHETHER IN AN ACTION OF CONTRACT, NEGLIGENCE OR OTHER TORTIOUS ACTION, ARISING OUT OF OR IN CONNECTION WITH THE USE OR PERFORMANCE OF THIS SOFTWARE.

Copyright 1995 Kaleb S. KEITHLEY

Permission is hereby granted, free of charge, to any person obtaining a copy of this software and associated documentation files (the "Software"), to deal in the Software without restriction, including without limitation the rights to use, copy, modify, merge, publish, distribute, sublicense, and/or sell copies of the Software, and to permit persons to whom the Software is furnished to do so, subject to the following conditions:

The above copyright notice and this permission notice shall be included in all copies or substantial portions of the Software.

THE SOFTWARE IS PROVIDED "AS IS", WITHOUT WARRANTY OF ANY KIND, EXPRESS OR IMPLIED, INCLUDING BUT NOT LIMITED TO THE WARRANTIES OF MERCHANTABILITY, FITNESS FOR A PARTICULAR PURPOSE AND NONINFRINGEMENT. IN NO EVENT SHALL Kaleb S. KEITHLEY BE LIABLE FOR ANY CLAIM, DAMAGES OR OTHER LIABILITY, WHETHER IN AN ACTION OF CONTRACT, TORT OR OTHERWISE, ARISING FROM, OUT OF OR IN CONNECTION WITH THE SOFTWARE OR THE USE OR OTHER DEALINGS IN THE SOFTWARE.

Except as contained in this notice, the name of Kaleb S. KEITHLEY shall not be used in advertising or otherwise to promote the sale, use or other dealings in this Software without prior written authorization from Kaleb S. KEITHLEY

Copyright (c) 1997 Matthieu Herrb

Permission to use, copy, modify, distribute, and sell this software and its documentation for any purpose is hereby granted without fee, provided that the above copyright notice appear in all copies and that both that copyright notice and this permission notice appear in supporting documentation, and that the name of Matthieu Herrb not be used in advertising or publicity pertaining to distribution of the software without specific, written prior permission. Matthieu Herrb makes no representations about the suitability of this software for any purpose.

It is provided "as is" without express or implied warranty.

MATTHIEU HERRB DISCLAIMS ALL WARRANTIES WITH REGARD TO THIS SOFTWARE, INCLUDING ALL IMPLIED WARRANTIES OF MERCHANTABILITY AND FITNESS, IN NO EVENT SHALL MATTHIEU HERRB BE LIABLE FOR ANY SPECIAL, INDIRECT OR CONSEQUENTIAL DAMAGES OR ANY DAMAGES WHATSOEVER RESULTING FROM LOSS OF USE, DATA OR PROFITS, WHETHER IN AN ACTION OF CONTRACT, NEGLIGENCE OR OTHER TORTIOUS ACTION, ARISING OUT OF OR IN CONNECTION WITH THE USE OR PERFORMANCE OF THIS SOFTWARE.

Copyright 2004, Egbert Eich

Permission is hereby granted, free of charge, to any person obtaining a copy of this software and associated documentation files (the "Software"), to deal in the Software without restriction, including without limitation the rights to use, copy, modify, merge, publish, distribute, sublicense, and/or sell copies of the Software, and to permit persons to whom the Software is furnished to do so, subject to the following conditions:

The above copyright notice and this permission notice shall be included in all copies or substantial portions of the Software.

THE SOFTWARE IS PROVIDED "AS IS", WITHOUT WARRANTY OF ANY KIND, EXPRESS OR IMPLIED, INCLUDING BUT NOT LIMITED TO THE WARRANTIES OF MERCHANTABILITY, FITNESS FOR A PARTICULAR PURPOSE AND NONINFRINGEMENT. IN NO EVENT SHALL EGBERT EICH BE LIABLE FOR ANY CLAIM, DAMAGES OR OTHER LIABILITY, WHETHER IN AN ACTION OF CONTRACT, TORT OR OTHERWISE, ARISING FROM, OUT OF OR IN CONNECTION WITH THE SOFTWARE OR THE USE OR OTHER DEALINGS IN THE SOFTWARE.

Except as contained in this notice, the name of Egbert Eich shall not be used in advertising or otherwise to promote the sale, use or other dealings in this Software without prior written authorization from Egbert Eich.

Copyright 1993 by David Wexelblat <dwex@goblin.org>

Copyright 2005 by Kean Johnston <jkj@sco.com>

Copyright 1993 by David McCullough <davidm@stallion.oz.au>

Permission to use, copy, modify, distribute, and sell this software and its documentation for any purpose is hereby granted without fee, provided that the above copyright notice appear in all copies and that both that copyright notice and this permission notice appear in supporting documentation, and that the name of David Wexelblat not be used in advertising or publicity pertaining to distribution of the software without specific, written prior permission. David Wexelblat makes no representations about the suitability of this software for any purpose. It is provided "as is" without express or implied warranty.

DAVID WEXELBLAT DISCLAIMS ALL WARRANTIES WITH REGARD TO THIS SOFTWARE, INCLUDING ALL IMPLIED WARRANTIES OF MERCHANTABILITY AND FITNESS, IN NO EVENT SHALL DAVID WEXELBLAT BE LIABLE FOR ANY SPECIAL, INDIRECT OR CONSEQUENTIAL DAMAGES OR ANY DAMAGES WHATSOEVER RESULTING FROM LOSS OF USE, DATA OR PROFITS, WHETHER IN AN ACTION OF CONTRACT, NEGLIGENCE OR OTHER TORTIOUS ACTION, ARISING OUT OF OR IN CONNECTION WITH THE USE OR PERFORMANCE OF THIS SOFTWARE.

Copyright 1992 by Orest Zborowski <obz@Kodak.com>

Copyright 1993 by David Wexelblat <dwex@goblin.org>

Permission to use, copy, modify, distribute, and sell this software and its documentation for any purpose is hereby granted without fee, provided that the above copyright notice appear in all copies and that both that copyright notice and this permission notice appear in supporting documentation, and that the names of Orest Zborowski and David Wexelblat not be used in advertising or publicity pertaining to distribution of

the software without specific, written prior permission. Orest Zborowski and David Wexelblat make no representations about the suitability of this software for any purpose. It is provided "as is" without express or implied warranty.

OREST ZBOROWSKI AND DAVID WEXELBLAT DISCLAIMS ALL WARRANTIES WITH REGARD TO THIS SOFTWARE, INCLUDING ALL IMPLIED WARRANTIES OF MERCHANTABILITY AND FITNESS, IN NO EVENT SHALL OREST ZBOROWSKI OR DAVID WEXELBLAT BE LIABLE FOR ANY SPECIAL, INDIRECT OR CONSEQUENTIAL DAMAGES OR ANY DAMAGES WHATSOEVER RESULTING FROM LOSS OF USE, DATA OR PROFITS, WHETHER IN AN ACTION OF CONTRACT, NEGLIGENCE OR OTHER TORTIOUS ACTION, ARISING OUT OF OR IN CONNECTION WITH THE USE OR PERFORMANCE OF THIS SOFTWARE.

Copyright 1995–1999 by Frederic Lepied, France. <fred@sugix.frmug.fr.net>

Permission to use, copy, modify, distribute, and sell this software and its documentation for any purpose is hereby granted without fee, provided that the above copyright notice appear in all copies and that both that copyright notice and this permission notice appear in supporting documentation, and that the name of Frederic Lepied not be used in advertising or publicity pertaining to distribution of the software without specific, written prior permission. Frederic Lepied makes no representations about the suitability of this software for any purpose. It is provided "as is" without express or implied warranty.

FREDERIC LEPIED DISCLAIMS ALL WARRANTIES WITH REGARD TO THIS SOFTWARE, INCLUDING ALL IMPLIED WARRANTIES OF MERCHANTABILITY AND FITNESS, IN NO EVENT SHALL FREDERIC LEPIED BE LIABLE FOR ANY SPECIAL, INDIRECT OR CONSEQUENTIAL DAMAGES OR ANY DAMAGES WHATSOEVER RESULTING FROM LOSS OF USE, DATA OR PROFITS, WHETHER IN AN ACTION OF CONTRACT, NEGLIGENCE OR OTHER TORTIOUS ACTION, ARISING OUT OF OR IN CONNECTION WITH THE USE OR PERFORMANCE OF THIS SOFTWARE.

Copyright 1992 by Rich Murphey <Rich@Rice.edu>

Copyright 1993 by David Wexelblat <dwex@goblin.org>

Permission to use, copy, modify, distribute, and sell this software and its documentation for any purpose is hereby granted without fee, provided that the above copyright notice appear in all copies and that both that copyright notice and this permission notice appear in supporting documentation, and that the names of Rich Murphey and David Wexelblat not be used in advertising or publicity pertaining to distribution of the software without specific, written prior permission. Rich Murphey and David Wexelblat make no representations about the suitability of this software for any purpose. It is provided "as is" without express or implied warranty.

RICH MURPHEY AND DAVID WEXELBLAT DISCLAIM ALL WARRANTIES WITH REGARD TO THIS SOFTWARE, INCLUDING ALL IMPLIED WARRANTIES OF MERCHANTABILITY AND FITNESS, IN NO EVENT SHALL RICH MURPHEY OR DAVID WEXELBLAT BE LIABLE FOR ANY SPECIAL, INDIRECT OR CONSEQUENTIAL DAMAGES OR ANY DAMAGES WHATSOEVER RESULTING FROM LOSS OF USE, DATA OR PROFITS, WHETHER IN AN ACTION OF CONTRACT, NEGLIGENCE OR OTHER TORTIOUS ACTION, ARISING OUT OF OR IN CONNECTION WITH THE USE OR PERFORMANCE OF THIS SOFTWARE.

Copyright © 2003–2004 Anders Carlsson

Permission to use, copy, modify, distribute, and sell this software and its documentation for any purpose is hereby granted without fee, provided that the above copyright notice appear in all copies and that both that copyright notice and this permission notice appear in supporting documentation, and that the name of Anders Carlsson not be used in advertising or publicity pertaining to distribution of the software without specific, written prior permission. Anders Carlsson makes no representations about the suitability of this software for any purpose. It is provided "as is" without express or implied warranty.

ANDERS CARLSSON DISCLAIMS ALL WARRANTIES WITH REGARD TO THIS SOFTWARE, INCLUDING ALL IMPLIED WARRANTIES OF MERCHANTABILITY AND FITNESS, IN NO EVENT SHALL ANDERS CARLSSON BE LIABLE FOR ANY SPECIAL, INDIRECT OR CONSEQUENTIAL DAMAGES OR ANY DAMAGES WHATSOEVER RESULTING FROM LOSS OF USE, DATA OR PROFITS, WHETHER IN AN ACTION OF CONTRACT, NEGLIGENCE OR OTHER TORTIOUS ACTION, ARISING OUT OF OR IN CONNECTION WITH THE USE OR

PERFORMANCE OF THIS SOFTWARE.

Copyright (C) 2003 Anders Carlsson
Copyright © 2003–2004 Eric Anholt
Copyright © 2004 Keith Packard

Permission to use, copy, modify, distribute, and sell this software and its documentation for any purpose is hereby granted without fee, provided that the above copyright notice appear in all copies and that both that copyright notice and this permission notice appear in supporting documentation, and that the name of Eric Anholt not be used in advertising or publicity pertaining to distribution of the software without specific, written prior permission. Eric Anholt makes no representations about the suitability of this software for any purpose. It is provided "as is" without express or implied warranty.

ERIC ANHOLT DISCLAIMS ALL WARRANTIES WITH REGARD TO THIS SOFTWARE, INCLUDING ALL IMPLIED WARRANTIES OF MERCHANTABILITY AND FITNESS, IN NO EVENT SHALL ERIC ANHOLT BE LIABLE FOR ANY SPECIAL, INDIRECT OR CONSEQUENTIAL DAMAGES OR ANY DAMAGES WHATSOEVER RESULTING FROM LOSS OF USE, DATA OR PROFITS, WHETHER IN AN ACTION OF CONTRACT, NEGLIGENCE OR OTHER TORTIOUS ACTION, ARISING OUT OF OR IN CONNECTION WITH THE USE OR PERFORMANCE OF THIS SOFTWARE.

Copyright (c) 1998 Todd C. Miller <Todd.Miller@courtesan.com>

Permission to use, copy, modify, and distribute this software for any purpose with or without fee is hereby granted, provided that the above copyright notice and this permission notice appear in all copies.

THE SOFTWARE IS PROVIDED "AS IS" AND TODD C. MILLER DISCLAIMS ALL WARRANTIES WITH REGARD TO THIS SOFTWARE INCLUDING ALL IMPLIED WARRANTIES OF MERCHANTABILITY AND FITNESS. IN NO EVENT SHALL TODD C. MILLER BE LIABLE FOR ANY SPECIAL, DIRECT, INDIRECT, OR CONSEQUENTIAL DAMAGES OR ANY DAMAGES WHATSOEVER RESULTING FROM LOSS OF USE, DATA OR PROFITS, WHETHER IN AN ACTION OF CONTRACT, NEGLIGENCE OR OTHER TORTIOUS ACTION, ARISING OUT OF OR IN

CONNECTION WITH THE USE OR PERFORMANCE OF THIS SOFTWARE.

Copyright © 2003–2004 Philip Blundell

Permission to use, copy, modify, distribute, and sell this software and its documentation for any purpose is hereby granted without fee, provided that the above copyright notice appear in all copies and that both that copyright notice and this permission notice appear in supporting documentation, and that the name of Philip Blundell not be used in advertising or publicity pertaining to distribution of the software without specific, written prior permission. Philip Blundell makes no representations about the suitability of this software for any purpose. It is provided "as is" without express or implied warranty.

PHILIP BLUNDELL DISCLAIMS ALL WARRANTIES WITH REGARD TO THIS SOFTWARE, INCLUDING ALL IMPLIED WARRANTIES OF MERCHANTABILITY AND FITNESS, IN NO EVENT SHALL PHILIP BLUNDELL BE LIABLE FOR ANY SPECIAL, INDIRECT OR CONSEQUENTIAL DAMAGES OR ANY DAMAGES WHATSOEVER RESULTING FROM LOSS OF USE, DATA OR PROFITS, WHETHER IN AN ACTION OF CONTRACT, NEGLIGENCE OR OTHER TORTIOUS ACTION, ARISING OUT OF OR IN CONNECTION WITH THE USE OR PERFORMANCE OF THIS SOFTWARE.

Copyright (c) 1994–2003 by The XFree86 Project, Inc.

Copyright 1997 by Metro Link, Inc.

Copyright 2003 by David H. Dawes.

Copyright 2003 by X-Oz Technologies.

Copyright (c) 2004, X.Org Foundation

Permission is hereby granted, free of charge, to any person obtaining a copy of this software and associated documentation files (the "Software"), to deal in the Software without restriction, including without limitation the rights to use, copy, modify, merge, publish, distribute, sublicense, and/or sell copies of the Software, and to permit persons to whom the Software is furnished to do so, subject to the following conditions:

The above copyright notice and this permission notice shall be included in all copies or substantial portions of the Software.

THE SOFTWARE IS PROVIDED "AS IS", WITHOUT WARRANTY OF ANY KIND, EXPRESS OR IMPLIED, INCLUDING BUT NOT LIMITED TO THE WARRANTIES OF MERCHANTABILITY, FITNESS FOR A PARTICULAR PURPOSE AND NONINFRINGEMENT. IN NO EVENT SHALL THE COPYRIGHT HOLDER(S) OR AUTHOR(S) BE LIABLE FOR ANY CLAIM, DAMAGES OR OTHER LIABILITY, WHETHER IN AN ACTION OF CONTRACT, TORT OR OTHERWISE, ARISING FROM, OUT OF OR IN CONNECTION WITH THE SOFTWARE OR THE USE OR OTHER DEALINGS IN THE SOFTWARE.

Except as contained in this notice, the name of the copyright holder(s) and author(s) shall not be used in advertising or otherwise to promote the sale, use or other dealings in this Software without prior written authorization from the copyright holder(s) and author(s).

Copyright 1990,91 by Thomas Roell, Dinkelscherben, Germany

Copyright 1993 by David Wexelblat <dwex@goblin.org>

Copyright 1999 by David Holland <davidh@iquest.net>

Copyright © 2000 Compaq Computer Corporation

Copyright © 2002 Hewlett-Packard Company

Copyright © 2004, 2005, 2008 Red Hat, Inc.

Copyright © 2004 Nicholas Miell

Copyright © 2005 Trolltech AS

Copyright © 2006 Intel Corporation

Copyright © 2004 - 2007 Keith Packard

Copyright © 2008 George Sapountzis <gsap7@yahoo.gr>

Permission to use, copy, modify, distribute, and sell this software and its documentation for any purpose is hereby granted without fee, provided that the above copyright notice appear in all copies and that both that copyright notice and this permission notice appear in supporting documentation, and that the name of the copyright holders not be used in advertising or publicity pertaining to distribution of the software without specific, written prior permission. The copyright holders make no representations about the suitability of this software for any purpose. It is provided "as is" without express or implied warranty.

THE COPYRIGHT HOLDERS DISCLAIM ALL WARRANTIES WITH REGARD TO THIS SOFTWARE, INCLUDING ALL IMPLIED WARRANTIES OF MERCHANTABILITY AND FITNESS, IN NO EVENT SHALL THE COPYRIGHT HOLDERS BE LIABLE FOR ANY SPECIAL, INDIRECT OR CONSEQUENTIAL DAMAGES OR ANY DAMAGES WHATSOEVER RESULTING FROM LOSS OF USE, DATA OR PROFITS, WHETHER IN AN ACTION OF CONTRACT, NEGLIGENCE OR OTHER TORTIOUS ACTION, ARISING OUT OF OR IN CONNECTION WITH THE USE OR PERFORMANCE OF THIS SOFTWARE.

Copyright © 2000 Keith Packard, member of The XFree86 Project, Inc.
2005 Lars Knoll & Zack Rusin, Trolltech

Permission to use, copy, modify, distribute, and sell this software and its documentation for any purpose is hereby granted without fee, provided that the above copyright notice appear in all copies and that both that copyright notice and this permission notice appear in supporting documentation, and that the name of Keith Packard not be used in advertising or publicity pertaining to distribution of the software without specific, written prior permission. Keith Packard makes no representations about the suitability of this software for any purpose. It is provided "as is" without express or implied warranty.

THE COPYRIGHT HOLDERS DISCLAIM ALL WARRANTIES WITH REGARD TO THIS SOFTWARE, INCLUDING ALL IMPLIED WARRANTIES OF MERCHANTABILITY AND FITNESS, IN NO EVENT SHALL THE COPYRIGHT HOLDERS BE LIABLE FOR ANY SPECIAL, INDIRECT OR CONSEQUENTIAL DAMAGES OR ANY DAMAGES WHATSOEVER RESULTING FROM LOSS OF USE, DATA OR PROFITS, WHETHER IN AN ACTION OF CONTRACT, NEGLIGENCE OR OTHER TORTIOUS ACTION, ARISING OUT OF OR IN CONNECTION WITH THE USE OR PERFORMANCE OF THIS SOFTWARE.

Copyright 1987, 1998 The Open Group
Copyright © 1998–1999, 2001 The XFree86 Project, Inc.
Copyright © 2000 VA Linux Systems, Inc.
Copyright (c) 2000, 2001 Nokia Home Communications

Copyright © 2007, 2008 Red Hat, Inc.

All rights reserved.

Permission is hereby granted, free of charge, to any person obtaining a copy of this software and associated documentation files (the "Software"), to deal in the Software without restriction, including without limitation the rights to use, copy, modify, merge, publish, distribute, and/or sell copies of the Software, and to permit persons to whom the Software is furnished to do so, provided that the above copyright notice(s) and this permission notice appear in all copies of the Software and that both the above copyright notice(s) and this permission notice appear in supporting documentation.

THE SOFTWARE IS PROVIDED "AS IS", WITHOUT WARRANTY OF ANY KIND, EXPRESS OR IMPLIED, INCLUDING BUT NOT LIMITED TO THE WARRANTIES OF MERCHANTABILITY, FITNESS FOR A PARTICULAR PURPOSE AND NONINFRINGEMENT OF THIRD PARTY RIGHTS. IN NO EVENT SHALL THE COPYRIGHT HOLDER OR HOLDERS INCLUDED IN THIS NOTICE BE LIABLE FOR ANY CLAIM, OR ANY SPECIAL INDIRECT OR CONSEQUENTIAL DAMAGES, OR ANY DAMAGES WHATSOEVER RESULTING FROM LOSS OF USE, DATA OR PROFITS, WHETHER IN AN ACTION OF CONTRACT, NEGLIGENCE OR OTHER TORTIOUS ACTION, ARISING OUT OF OR IN CONNECTION WITH THE USE OR PERFORMANCE OF THIS SOFTWARE.

Except as contained in this notice, the name of a copyright holder shall not be used in advertising or otherwise to promote the sale, use or other dealings in this Software without prior written authorization of the copyright holder.

Copyright 1996 by Thomas E. Dickey <dickey@clark.net>

All Rights Reserved

Permission to use, copy, modify, and distribute this software and its documentation for any purpose and without fee is hereby granted, provided that the above copyright notice appear in all copies and that both that copyright notice and this permission notice appear in supporting documentation, and that the name of the above listed

copyright holder(s) not be used in advertising or publicity pertaining to distribution of the software without specific, written prior permission.

THE ABOVE LISTED COPYRIGHT HOLDER(S) DISCLAIM ALL WARRANTIES WITH REGARD TO THIS SOFTWARE, INCLUDING ALL IMPLIED WARRANTIES OF MERCHANTABILITY AND FITNESS, IN NO EVENT SHALL THE ABOVE LISTED COPYRIGHT HOLDER(S) BE LIABLE FOR ANY SPECIAL, INDIRECT OR CONSEQUENTIAL DAMAGES OR ANY DAMAGES WHATSOEVER RESULTING FROM LOSS OF USE, DATA OR PROFITS, WHETHER IN AN ACTION OF CONTRACT, NEGLIGENCE OR OTHER TORTIOUS ACTION, ARISING OUT OF OR IN CONNECTION WITH THE USE OR PERFORMANCE OF THIS SOFTWARE.

Copyright 1998–1999 Precision Insight, Inc., Cedar Park, Texas.

Copyright (c) 2001 Andreas Monitzer.

Copyright (c) 2001–2004 Greg Parker.

Copyright (c) 2001–2004 Torrey T. Lyons

Copyright (c) 2002–2003 Apple Computer, Inc.

Copyright (c) 2004–2005 Alexander Gottwald

Copyright (c) 2002–2009 Apple Inc.

Copyright (c) 2007 Jeremy Huddleston

All Rights Reserved.

Permission is hereby granted, free of charge, to any person obtaining a copy of this software and associated documentation files (the "Software"), to deal in the Software without restriction, including without limitation the rights to use, copy, modify, merge, publish, distribute, sublicense, and/or sell copies of the Software, and to permit persons to whom the Software is furnished to do so, subject to the following conditions:

The above copyright notice and this permission notice shall be included in all copies or substantial portions of the Software.

THE SOFTWARE IS PROVIDED "AS IS", WITHOUT WARRANTY OF ANY KIND, EXPRESS OR IMPLIED, INCLUDING BUT NOT LIMITED TO THE WARRANTIES OF MERCHANTABILITY, FITNESS FOR A PARTICULAR PURPOSE AND NONINFRINGEMENT. IN NO EVENT SHALL THE ABOVE LISTED COPYRIGHT HOLDER(S) BE LIABLE FOR ANY CLAIM, DAMAGES OR OTHER LIABILITY, WHETHER IN AN ACTION OF CONTRACT, TORT OR OTHERWISE,

ARISING FROM, OUT OF OR IN CONNECTION WITH THE SOFTWARE OR THE USE OR OTHER DEALINGS IN THE SOFTWARE.

Except as contained in this notice, the name(s) of the above copyright holders shall not be used in advertising or otherwise to promote the sale, use or other dealings in this Software without prior written authorization.

Copyright (C) 1999,2000 by Eric Sunshine <sunshine@sunshineco.com>

Copyright (C) 2001–2005 by Thomas Winischhofer, Vienna, Austria.

All rights reserved.

Redistribution and use in source and binary forms, with or without modification, are permitted provided that the following conditions are met:

1. Redistributions of source code must retain the above copyright notice, this list of conditions and the following disclaimer.
2. Redistributions in binary form must reproduce the above copyright notice, this list of conditions and the following disclaimer in the documentation and/or other materials provided with the distribution.
3. The name of the author may not be used to endorse or promote products derived from this software without specific prior written permission.

THIS SOFTWARE IS PROVIDED BY THE AUTHOR ``AS IS" AND ANY EXPRESS OR IMPLIED WARRANTIES, INCLUDING, BUT NOT LIMITED TO, THE IMPLIED WARRANTIES OF MERCHANTABILITY AND FITNESS FOR A PARTICULAR PURPOSE ARE DISCLAIMED. IN NO EVENT SHALL THE AUTHOR BE LIABLE FOR ANY DIRECT, INDIRECT, INCIDENTAL, SPECIAL, EXEMPLARY, OR CONSEQUENTIAL DAMAGES (INCLUDING, BUT NOT LIMITED TO, PROCUREMENT OF SUBSTITUTE GOODS OR SERVICES; LOSS OF USE, DATA, OR PROFITS; OR BUSINESS INTERRUPTION) HOWEVER CAUSED AND ON ANY THEORY OF LIABILITY, WHETHER IN CONTRACT, STRICT LIABILITY, OR TORT (INCLUDING NEGLIGENCE OR OTHERWISE) ARISING IN ANY WAY OUT OF THE USE OF THIS SOFTWARE, EVEN IF ADVISED OF THE POSSIBILITY OF SUCH DAMAGE.

Copyright (C) 2005 Bogdan D. bogdand@users.sourceforge.net

Permission is hereby granted, free of charge, to any person obtaining a copy of this software and associated documentation files (the "Software"), to deal in the Software without restriction, including without limitation the rights to use, copy, modify, merge, publish, distribute, sublicense, and/or sell copies of the Software, and to permit persons to whom the Software is furnished to do so, subject to the following conditions:

The above copyright notice and this permission notice shall be included in all copies or substantial portions of the Software.

THE SOFTWARE IS PROVIDED "AS IS", WITHOUT WARRANTY OF ANY KIND, EXPRESS OR IMPLIED, INCLUDING BUT NOT LIMITED TO THE WARRANTIES OF MERCHANTABILITY, FITNESS FOR A PARTICULAR PURPOSE AND NONINFRINGEMENT. IN NO EVENT SHALL THE AUTHOR BE LIABLE FOR ANY CLAIM, DAMAGES OR OTHER LIABILITY, WHETHER IN AN ACTION OF CONTRACT, TORT OR OTHERWISE, ARISING FROM, OUT OF OR IN CONNECTION WITH THE SOFTWARE OR THE USE OR OTHER DEALINGS IN THE SOFTWARE.

Except as contained in this notice, the name of the author shall not be used in advertising or otherwise to promote the sale, use or other dealings in this Software without prior written authorization from the author.

Copyright © 2002 David Dawes

Permission is hereby granted, free of charge, to any person obtaining a copy of this software and associated documentation files (the "Software"), to deal in the Software without restriction, including without limitation the rights to use, copy, modify, merge, publish, distribute, sublicense, and/or sell copies of the Software, and to permit persons to whom the Software is furnished to do so, subject to the following conditions:

The above copyright notice and this permission notice shall be included in all copies or substantial portions of the Software.

THE SOFTWARE IS PROVIDED "AS IS", WITHOUT WARRANTY OF ANY KIND, EXPRESS OR IMPLIED, INCLUDING BUT NOT LIMITED TO THE WARRANTIES OF MERCHANTABILITY, FITNESS FOR A PARTICULAR PURPOSE AND NONINFRINGEMENT. IN NO EVENT SHALL THE AUTHOR(S) BE LIABLE FOR ANY CLAIM, DAMAGES OR OTHER LIABILITY,

WHETHER IN AN ACTION OF CONTRACT, TORT OR OTHERWISE, ARISING FROM, OUT OF OR IN CONNECTION WITH THE SOFTWARE OR THE USE OR OTHER DEALINGS IN THE SOFTWARE.

Except as contained in this notice, the name of the author(s) shall not be used in advertising or otherwise to promote the sale, use or other dealings in this Software without prior written authorization from the author(s).

Copyright (C) 1996–1999 SciTech Software, Inc.

Copyright (C) David Mosberger–Tang

Copyright (C) 1999 Egbert Eich

Copyright (C) 2008 Bart Trojanowski, Symbio Technologies, LLC

Permission to use, copy, modify, distribute, and sell this software and its documentation for any purpose is hereby granted without fee, provided that the above copyright notice appear in all copies and that both that copyright notice and this permission notice appear in supporting documentation, and that the name of the authors not be used in advertising or publicity pertaining to distribution of the software without specific, written prior permission. The authors makes no representations about the suitability of this software for any purpose. It is provided "as is" without express or implied warranty.

THE AUTHORS DISCLAIMS ALL WARRANTIES WITH REGARD TO THIS SOFTWARE, INCLUDING ALL IMPLIED WARRANTIES OF MERCHANTABILITY AND FITNESS, IN NO EVENT SHALL THE AUTHORS BE LIABLE FOR ANY SPECIAL, INDIRECT OR CONSEQUENTIAL DAMAGES OR ANY DAMAGES WHATSOEVER RESULTING FROM LOSS OF USE, DATA OR PROFITS, WHETHER IN AN ACTION OF CONTRACT, NEGLIGENCE OR OTHER TORTIOUS ACTION, ARISING OUT OF OR IN CONNECTION WITH THE USE OR PERFORMANCE OF THIS SOFTWARE.

Copyright 2005–2006 Luc Verhaegen.

Permission is hereby granted, free of charge, to any person obtaining a copy of this software and associated documentation files (the "Software"),

to deal in the Software without restriction, including without limitation the rights to use, copy, modify, merge, publish, distribute, sublicense, and/or sell copies of the Software, and to permit persons to whom the Software is furnished to do so, subject to the following conditions:

The above copyright notice and this permission notice shall be included in all copies or substantial portions of the Software.

THE SOFTWARE IS PROVIDED "AS IS", WITHOUT WARRANTY OF ANY KIND, EXPRESS OR IMPLIED, INCLUDING BUT NOT LIMITED TO THE WARRANTIES OF MERCHANTABILITY, FITNESS FOR A PARTICULAR PURPOSE AND NONINFRINGEMENT. IN NO EVENT SHALL THE COPYRIGHT HOLDER(S) OR AUTHOR(S) BE LIABLE FOR ANY CLAIM, DAMAGES OR OTHER LIABILITY, WHETHER IN AN ACTION OF CONTRACT, TORT OR OTHERWISE, ARISING FROM, OUT OF OR IN CONNECTION WITH THE SOFTWARE OR THE USE OR OTHER DEALINGS IN THE SOFTWARE.

Copyright 1995 by Robin Cutshaw <robin@XFree86.Org>

Copyright 2000 by Egbert Eich

Copyright 2002 by David Dawes

Permission to use, copy, modify, distribute, and sell this software and its documentation for any purpose is hereby granted without fee, provided that the above copyright notice appear in all copies and that both that copyright notice and this permission notice appear in supporting documentation, and that the names of the above listed copyright holder(s) not be used in advertising or publicity pertaining to distribution of the software without specific, written prior permission. The above listed copyright holder(s) make(s) no representations about the suitability of this software for any purpose. It is provided "as is" without express or implied warranty.

THE ABOVE LISTED COPYRIGHT HOLDER(S) DISCLAIM(S) ALL WARRANTIES WITH REGARD TO THIS SOFTWARE, INCLUDING ALL IMPLIED WARRANTIES OF MERCHANTABILITY AND FITNESS, IN NO EVENT SHALL THE ABOVE LISTED COPYRIGHT HOLDER(S) BE LIABLE FOR ANY SPECIAL, INDIRECT OR CONSEQUENTIAL DAMAGES OR ANY DAMAGES WHATSOEVER RESULTING FROM LOSS OF USE, DATA OR PROFITS, WHETHER IN AN ACTION OF CONTRACT, NEGLIGENCE OR OTHER TORTIOUS ACTION, ARISING

OUT OF OR IN CONNECTION WITH THE USE OR PERFORMANCE OF THIS SOFTWARE.

Copyright 1997–2004 by Marc Aurele La France (TSI @ UQV), tsi@xfree86.org

Permission to use, copy, modify, distribute, and sell this software and its documentation for any purpose is hereby granted without fee, provided that the above copyright notice appear in all copies and that both that copyright notice and this permission notice appear in supporting documentation, and that the name of Marc Aurele La France not be used in advertising or publicity pertaining to distribution of the software without specific, written prior permission. Marc Aurele La France makes no representations about the suitability of this software for any purpose. It is provided "as-is" without express or implied warranty.

MARC AURELE LA FRANCE DISCLAIMS ALL WARRANTIES WITH REGARD TO THIS SOFTWARE, INCLUDING ALL IMPLIED WARRANTIES OF MERCHANTABILITY AND FITNESS. IN NO EVENT SHALL MARC AURELE LA FRANCE BE LIABLE FOR ANY SPECIAL, INDIRECT OR CONSEQUENTIAL DAMAGES OR ANY DAMAGES WHATSOEVER RESULTING FROM LOSS OF USE, DATA OR PROFITS, WHETHER IN AN ACTION OF CONTRACT, NEGLIGENCE OR OTHER TORTIOUS ACTION, ARISING OUT OF OR IN CONNECTION WITH THE USE OR PERFORMANCE OF THIS SOFTWARE.

Copyright 1990, 1991 by Thomas Roell, Dinkelscherben, Germany

Copyright 1992 by David Dawes <dawes@XFree86.org>

Copyright 1992 by Jim Tsilla <jtsilla@damon.ccs.northeastern.edu>

Copyright 1992 by Rich Murphey <Rich@Rice.edu>

Copyright 1992 by Robert Baron <Robert.Baron@ernst.mach.cs.cmu.edu>

Copyright 1992 by Orest Zborowski <obz@eskimo.com>

Copyright 1993 by Vrije Universiteit, The Netherlands

Copyright 1993 by David Wexelblat <dwex@XFree86.org>

Copyright 1994, 1996 by Holger Veit <Holger.Veit@gmd.de>

Copyright 1997 by Takis Psarogiannakopoulos <takis@dpmms.cam.ac.uk>

Copyright 1994–2003 by The XFree86 Project, Inc

Permission to use, copy, modify, distribute, and sell this software and its documentation for any purpose is hereby granted without fee, provided that

the above copyright notice appear in all copies and that both that copyright notice and this permission notice appear in supporting documentation, and that the names of the above listed copyright holders not be used in advertising or publicity pertaining to distribution of the software without specific, written prior permission. The above listed copyright holders make no representations about the suitability of this software for any purpose. It is provided "as is" without express or implied warranty.

THE ABOVE LISTED COPYRIGHT HOLDERS DISCLAIM ALL WARRANTIES WITH REGARD TO THIS SOFTWARE, INCLUDING ALL IMPLIED WARRANTIES OF MERCHANTABILITY AND FITNESS, IN NO EVENT SHALL THE ABOVE LISTED COPYRIGHT HOLDERS BE LIABLE FOR ANY SPECIAL, INDIRECT OR CONSEQUENTIAL DAMAGES OR ANY DAMAGES WHATSOEVER RESULTING FROM LOSS OF USE, DATA OR PROFITS, WHETHER IN AN ACTION OF CONTRACT, NEGLIGENCE OR OTHER TORTIOUS ACTION, ARISING OUT OF OR IN CONNECTION WITH THE USE OR PERFORMANCE OF THIS SOFTWARE.

Copyright (C) 2000 Jakub Jelinek (jakub@redhat.com)

Permission is hereby granted, free of charge, to any person obtaining a copy of this software and associated documentation files (the "Software"), to deal in the Software without restriction, including without limitation the rights to use, copy, modify, merge, publish, distribute, sublicense, and/or sell copies of the Software, and to permit persons to whom the Software is furnished to do so, subject to the following conditions:

The above copyright notice and this permission notice shall be included in all copies or substantial portions of the Software.

THE SOFTWARE IS PROVIDED "AS IS", WITHOUT WARRANTY OF ANY KIND, EXPRESS OR IMPLIED, INCLUDING BUT NOT LIMITED TO THE WARRANTIES OF MERCHANTABILITY, FITNESS FOR A PARTICULAR PURPOSE AND NONINFRINGEMENT. IN NO EVENT SHALL JAKUB JELINEK BE LIABLE FOR ANY CLAIM, DAMAGES OR OTHER LIABILITY, WHETHER IN AN ACTION OF CONTRACT, TORT OR OTHERWISE, ARISING FROM, OUT OF OR IN CONNECTION WITH THE SOFTWARE OR THE USE OR OTHER DEALINGS IN THE SOFTWARE.

Copyright (C) 2000 Keith Packard
2004 Eric Anholt
2005 Zack Rusin

Permission to use, copy, modify, distribute, and sell this software and its documentation for any purpose is hereby granted without fee, provided that the above copyright notice appear in all copies and that both that copyright notice and this permission notice appear in supporting documentation, and that the name of copyright holders not be used in advertising or publicity pertaining to distribution of the software without specific, written prior permission. Copyright holders make no representations about the suitability of this software for any purpose. It is provided "as is" without express or implied warranty.

THE COPYRIGHT HOLDERS DISCLAIM ALL WARRANTIES WITH REGARD TO THIS SOFTWARE, INCLUDING ALL IMPLIED WARRANTIES OF MERCHANTABILITY AND FITNESS, IN NO EVENT SHALL THE COPYRIGHT HOLDERS BE LIABLE FOR ANY SPECIAL, INDIRECT OR CONSEQUENTIAL DAMAGES OR ANY DAMAGES WHATSOEVER RESULTING FROM LOSS OF USE, DATA OR PROFITS, WHETHER IN AN ACTION OF CONTRACT, NEGLIGENCE OR OTHER TORTIOUS ACTION, ARISING OUT OF OR IN CONNECTION WITH THE USE OR PERFORMANCE OF THIS SOFTWARE.

Copyright © 2007 OpenedHand Ltd

Permission to use, copy, modify, distribute, and sell this software and its documentation for any purpose is hereby granted without fee, provided that the above copyright notice appear in all copies and that both that copyright notice and this permission notice appear in supporting documentation, and that the name of OpenedHand Ltd not be used in advertising or publicity pertaining to distribution of the software without specific, written prior permission. OpenedHand Ltd makes no representations about the suitability of this software for any purpose. It is provided "as is" without express or implied warranty.

OpenedHand Ltd DISCLAIMS ALL WARRANTIES WITH REGARD TO THIS SOFTWARE, INCLUDING ALL IMPLIED WARRANTIES OF MERCHANTABILITY AND FITNESS, IN NO

EVENT SHALL OpenedHand Ltd BE LIABLE FOR ANY SPECIAL, INDIRECT OR CONSEQUENTIAL DAMAGES OR ANY DAMAGES WHATSOEVER RESULTING FROM LOSS OF USE, DATA OR PROFITS, WHETHER IN AN ACTION OF CONTRACT, NEGLIGENCE OR OTHER TORTIOUS ACTION, ARISING OUT OF OR IN CONNECTION WITH THE USE OR PERFORMANCE OF THIS SOFTWARE.

Copyright (c) 1989, 1990, 1993, 1994

The Regents of the University of California. All rights reserved.

This code is derived from software contributed to Berkeley by Chris Torek.

This code is derived from software contributed to Berkeley by Michael Rendell of Memorial University of Newfoundland.

Redistribution and use in source and binary forms, with or without modification, are permitted provided that the following conditions are met:

1. Redistributions of source code must retain the above copyright notice, this list of conditions and the following disclaimer.
2. Redistributions in binary form must reproduce the above copyright notice, this list of conditions and the following disclaimer in the documentation and/or other materials provided with the distribution.
4. Neither the name of the University nor the names of its contributors may be used to endorse or promote products derived from this software without specific prior written permission.

THIS SOFTWARE IS PROVIDED BY THE REGENTS AND CONTRIBUTORS ``AS IS'' AND ANY EXPRESS OR IMPLIED WARRANTIES, INCLUDING, BUT NOT LIMITED TO, THE IMPLIED WARRANTIES OF MERCHANTABILITY AND FITNESS FOR A PARTICULAR PURPOSE ARE DISCLAIMED. IN NO EVENT SHALL THE REGENTS OR CONTRIBUTORS BE LIABLE FOR ANY DIRECT, INDIRECT, INCIDENTAL, SPECIAL, EXEMPLARY, OR CONSEQUENTIAL DAMAGES (INCLUDING, BUT NOT LIMITED TO, PROCUREMENT OF SUBSTITUTE GOODS OR SERVICES; LOSS OF USE, DATA, OR PROFITS; OR BUSINESS INTERRUPTION) HOWEVER CAUSED AND ON ANY THEORY OF LIABILITY, WHETHER IN CONTRACT, STRICT LIABILITY, OR TORT (INCLUDING NEGLIGENCE OR OTHERWISE) ARISING IN ANY WAY OUT OF THE USE OF THIS SOFTWARE, EVEN IF ADVISED OF THE POSSIBILITY OF

SUCH DAMAGE.

Copyright 1987 by Apollo Computer Inc., Chelmsford, Massachusetts.

Copyright 1989 by Hewlett-Packard Company.

All Rights Reserved

Permission to use, duplicate, change, and distribute this software and its documentation for any purpose and without fee is granted, provided that the above copyright notice appear in such copy and that this copyright notice appear in all supporting documentation, and that the names of Apollo Computer Inc., the Hewlett-Packard Company, or the X Consortium not be used in advertising or publicity pertaining to distribution of the software without written prior permission.

HEWLETT-PACKARD MAKES NO WARRANTY OF ANY KIND WITH REGARD TO THIS SOFTWARE, INCLUDING, BUT NOT LIMITED TO, THE IMPLIED WARRANTIES OF MERCHANTABILITY AND FITNESS FOR A PARTICULAR PURPOSE. Hewlett-Packard shall not be liable for errors contained herein or direct, indirect, special, incidental or consequential damages in connection with the furnishing, performance, or use of this material.

Copyright 1993, 1994 NCR Corporation – Dayton, Ohio, USA

All Rights Reserved

Permission to use, copy, modify, and distribute this software and its documentation for any purpose and without fee is hereby granted, provided that the above copyright notice appear in all copies and that both that copyright notice and this permission notice appear in supporting documentation, and that the name NCR not be used in advertising or publicity pertaining to distribution of the software without specific, written prior permission. NCR makes no representations about the suitability of this software for any purpose. It is provided "as is" without express or implied warranty.

NCR DISCLAIMS ALL WARRANTIES WITH REGARD TO THIS SOFTWARE, INCLUDING ALL IMPLIED WARRANTIES OF MERCHANTABILITY AND FITNESS, IN NO EVENT SHALL NCR BE LIABLE FOR ANY SPECIAL, INDIRECT OR CONSEQUENTIAL DAMAGES OR ANY DAMAGES WHATSOEVER RESULTING FROM LOSS OF USE, DATA OR PROFITS, WHETHER IN AN ACTION OF CONTRACT, NEGLIGENCE OR OTHER TORTIOUS ACTION, ARISING OUT OF OR IN CONNECTION WITH THE USE OR PERFORMANCE OF THIS SOFTWARE.

(c) Copyright 1996 by Sebastien Marineau and Holger Veit

<marineau@genie.uottawa.ca>

<Holger.Veit@gmd.de>

Permission is hereby granted, free of charge, to any person obtaining a copy of this software and associated documentation files (the "Software"), to deal in the Software without restriction, including without limitation the rights to use, copy, modify, merge, publish, distribute, sublicense, and/or sell copies of the Software, and to permit persons to whom the Software is furnished to do so, subject to the following conditions:

The above copyright notice and this permission notice shall be included in all copies or substantial portions of the Software.

THE SOFTWARE IS PROVIDED "AS IS", WITHOUT WARRANTY OF ANY KIND, EXPRESS OR IMPLIED, INCLUDING BUT NOT LIMITED TO THE WARRANTIES OF MERCHANTABILITY, FITNESS FOR A PARTICULAR PURPOSE AND NONINFRINGEMENT. IN NO EVENT SHALL HOLGER VEIT BE LIABLE FOR ANY CLAIM, DAMAGES OR OTHER LIABILITY, WHETHER IN AN ACTION OF CONTRACT, TORT OR OTHERWISE, ARISING FROM, OUT OF OR IN CONNECTION WITH THE SOFTWARE OR THE USE OR OTHER DEALINGS IN THE SOFTWARE.

Except as contained in this notice, the name of Sebastien Marineau or Holger Veit shall not be used in advertising or otherwise to promote the sale, use or other dealings in this Software without prior written authorization from Holger Veit or Sebastien Marineau.

Copyright © 2003 Keith Packard, Noah Levitt

Permission to use, copy, modify, distribute, and sell this software and its documentation for any purpose is hereby granted without fee, provided that the above copyright notice appear in all copies and that both that copyright notice and this permission notice appear in supporting documentation, and that the name of Keith Packard not be used in advertising or publicity pertaining to distribution of the software without specific, written prior permission. Keith Packard makes no representations about the suitability of this software for any purpose. It is provided "as is" without express or implied warranty.

KEITH PACKARD DISCLAIMS ALL WARRANTIES WITH REGARD TO THIS SOFTWARE, INCLUDING ALL IMPLIED WARRANTIES OF MERCHANTABILITY AND FITNESS, IN NO EVENT SHALL KEITH PACKARD BE LIABLE FOR ANY SPECIAL, INDIRECT OR CONSEQUENTIAL DAMAGES OR ANY DAMAGES WHATSOEVER RESULTING FROM LOSS OF USE, DATA OR PROFITS, WHETHER IN AN ACTION OF CONTRACT, NEGLIGENCE OR OTHER TORTIOUS ACTION, ARISING OUT OF OR IN CONNECTION WITH THE USE OR PERFORMANCE OF THIS SOFTWARE.

33.XKCP

Implementation by the Keccak Team, namely, Guido Bertoni, Joan Daemen,
#Michael Peeters, Gilles Van Assche and Ronny Van Keer,
#hereby denoted as "the implementer".

To the extent possible under law, the implementer has waived all copyright
and related or neighboring rights to the source code in this file.

<http://creativecommons.org/publicdomain/zero/1.0/>

34.xkeyboard-config

Copyright 1996 by Joseph Moss

Copyright (C) 2002–2007 Free Software Foundation, Inc.

Copyright (C) Dmitry Golubev <lastguru@mail.ru>, 2003–2004

Copyright (C) 2004, Gregory Mokhin <mokhin@bog.msu.ru>

Copyright (C) 2006 Erdal Ronahî

Permission to use, copy, modify, distribute, and sell this software and its documentation for any purpose is hereby granted without fee, provided that the above copyright notice appear in all copies and that both that copyright notice and this permission notice appear in supporting documentation, and that the name of the copyright holder(s) not be used in advertising or publicity pertaining to distribution of the software without specific, written prior permission. The copyright holder(s) makes no representations about the suitability of this software for any purpose. It is provided "as is" without express or implied warranty.

THE COPYRIGHT HOLDER(S) DISCLAIMS ALL WARRANTIES WITH REGARD TO THIS SOFTWARE, INCLUDING ALL IMPLIED WARRANTIES OF MERCHANTABILITY AND FITNESS, IN NO EVENT SHALL THE COPYRIGHT HOLDER(S) BE LIABLE FOR ANY SPECIAL, INDIRECT OR CONSEQUENTIAL DAMAGES OR ANY DAMAGES WHATSOEVER RESULTING FROM LOSS OF USE, DATA OR PROFITS, WHETHER IN AN ACTION OF CONTRACT, NEGLIGENCE OR OTHER TORTIOUS ACTION, ARISING OUT OF OR IN CONNECTION WITH THE USE OR PERFORMANCE OF THIS SOFTWARE.

Copyright (c) 1996 Digital Equipment Corporation

Permission is hereby granted, free of charge, to any person obtaining a copy of this software and associated documentation files (the "Software"), to deal in the Software without restriction, including without limitation the rights to use, copy, modify, merge, publish, distribute, sublicense, and sell copies of the Software, and to permit persons to whom the Software is furnished to do so, subject to the following conditions:

The above copyright notice and this permission notice shall be included in all copies or substantial portions of the Software.

THE SOFTWARE IS PROVIDED "AS IS", WITHOUT WARRANTY OF ANY KIND, EXPRESS OR IMPLIED, INCLUDING BUT NOT LIMITED TO THE WARRANTIES OF MERCHANTABILITY, FITNESS FOR A PARTICULAR PURPOSE AND NONINFRINGEMENT. IN NO EVENT SHALL DIGITAL EQUIPMENT CORPORATION BE LIABLE FOR ANY CLAIM, DAMAGES OR OTHER LIABILITY, WHETHER IN AN ACTION OF CONTRACT, TORT OR OTHERWISE, ARISING FROM, OUT OF OR IN CONNECTION WITH THE SOFTWARE OR THE USE OR OTHER DEALINGS IN THE SOFTWARE.

Except as contained in this notice, the name of the Digital Equipment Corporation shall not be used in advertising or otherwise to promote the sale, use or other dealings in this Software without prior written authorization from Digital Equipment Corporation.

Copyright 1996, 1998 The Open Group

Permission to use, copy, modify, distribute, and sell this software and its documentation for any purpose is hereby granted without fee, provided that the above copyright notice appear in all copies and that both that copyright notice and this permission notice appear in supporting documentation.

The above copyright notice and this permission notice shall be included in all copies or substantial portions of the Software.

THE SOFTWARE IS PROVIDED "AS IS", WITHOUT WARRANTY OF ANY KIND, EXPRESS OR IMPLIED, INCLUDING BUT NOT LIMITED TO THE WARRANTIES OF MERCHANTABILITY, FITNESS FOR A PARTICULAR PURPOSE AND NONINFRINGEMENT. IN NO EVENT SHALL THE OPEN GROUP BE LIABLE FOR ANY CLAIM, DAMAGES OR OTHER LIABILITY, WHETHER IN AN ACTION OF CONTRACT, TORT OR OTHERWISE, ARISING FROM, OUT OF OR IN CONNECTION WITH THE SOFTWARE OR THE USE OR OTHER DEALINGS IN THE SOFTWARE.

Except as contained in this notice, the name of The Open Group shall not be used in advertising or otherwise to promote the sale, use or

other dealings in this Software without prior written authorization from The Open Group.

Copyright 2004–2005 Sun Microsystems, Inc. All rights reserved.

Permission is hereby granted, free of charge, to any person obtaining a copy of this software and associated documentation files (the "Software"), to deal in the Software without restriction, including without limitation the rights to use, copy, modify, merge, publish, distribute, sublicense, and/or sell copies of the Software, and to permit persons to whom the Software is furnished to do so, subject to the following conditions:

The above copyright notice and this permission notice (including the next paragraph) shall be included in all copies or substantial portions of the Software.

THE SOFTWARE IS PROVIDED "AS IS", WITHOUT WARRANTY OF ANY KIND, EXPRESS OR IMPLIED, INCLUDING BUT NOT LIMITED TO THE WARRANTIES OF MERCHANTABILITY, FITNESS FOR A PARTICULAR PURPOSE AND NONINFRINGEMENT. IN NO EVENT SHALL THE AUTHORS OR COPYRIGHT HOLDERS BE LIABLE FOR ANY CLAIM, DAMAGES OR OTHER LIABILITY, WHETHER IN AN ACTION OF CONTRACT, TORT OR OTHERWISE, ARISING FROM, OUT OF OR IN CONNECTION WITH THE SOFTWARE OR THE USE OR OTHER DEALINGS IN THE SOFTWARE.

Copyright (c) 1996 by Silicon Graphics Computer Systems, Inc.

Permission to use, copy, modify, and distribute this software and its documentation for any purpose and without fee is hereby granted, provided that the above copyright notice appear in all copies and that both that copyright notice and this permission notice appear in supporting documentation, and that the name of Silicon Graphics not be used in advertising or publicity pertaining to distribution of the software without specific prior written permission. Silicon Graphics makes no representation about the suitability of this software for any purpose. It is provided "as is"

without any express or implied warranty.

SILICON GRAPHICS DISCLAIMS ALL WARRANTIES WITH REGARD TO THIS SOFTWARE, INCLUDING ALL IMPLIED WARRANTIES OF MERCHANTABILITY AND FITNESS FOR A PARTICULAR PURPOSE. IN NO EVENT SHALL SILICON GRAPHICS BE LIABLE FOR ANY SPECIAL, INDIRECT OR CONSEQUENTIAL DAMAGES OR ANY DAMAGES WHATSOEVER RESULTING FROM LOSS OF USE, DATA OR PROFITS, WHETHER IN AN ACTION OF CONTRACT, NEGLIGENCE OR OTHER TORTIOUS ACTION, ARISING OUT OF OR IN CONNECTION WITH THE USE OR PERFORMANCE OF THIS SOFTWARE.

Copyright (c) 1996 X Consortium

Permission is hereby granted, free of charge, to any person obtaining a copy of this software and associated documentation files (the "Software"), to deal in the Software without restriction, including without limitation the rights to use, copy, modify, merge, publish, distribute, sublicense, and/or sell copies of the Software, and to permit persons to whom the Software is furnished to do so, subject to the following conditions:

The above copyright notice and this permission notice shall be included in all copies or substantial portions of the Software.

THE SOFTWARE IS PROVIDED "AS IS", WITHOUT WARRANTY OF ANY KIND, EXPRESS OR IMPLIED, INCLUDING BUT NOT LIMITED TO THE WARRANTIES OF MERCHANTABILITY, FITNESS FOR A PARTICULAR PURPOSE AND NONINFRINGEMENT. IN NO EVENT SHALL THE X CONSORTIUM BE LIABLE FOR ANY CLAIM, DAMAGES OR OTHER LIABILITY, WHETHER IN AN ACTION OF CONTRACT, TORT OR OTHERWISE, ARISING FROM, OUT OF OR IN CONNECTION WITH THE SOFTWARE OR THE USE OR OTHER DEALINGS IN THE SOFTWARE.

Except as contained in this notice, the name of the X Consortium shall not be used in advertising or otherwise to promote the sale, use or other dealings in this Software without prior written authorization from the X Consortium.

Copyright (C) 2004, 2006 Ævar Arnfjörð Bjarmason <avarab@gmail.com>

Permission to use, copy, modify, distribute, and sell this software and its documentation for any purpose is hereby granted without fee, provided that the above copyright notice appear in all copies and that both that copyright notice and this permission notice appear in supporting documentation.

The above copyright notice and this permission notice shall be included in all copies or substantial portions of the Software.

THE SOFTWARE IS PROVIDED "AS IS", WITHOUT WARRANTY OF ANY KIND, EXPRESS OR IMPLIED, INCLUDING BUT NOT LIMITED TO THE WARRANTIES OF MERCHANTABILITY, FITNESS FOR A PARTICULAR PURPOSE AND NONINFRINGEMENT. IN NO EVENT SHALL THE OPEN GROUP BE LIABLE FOR ANY CLAIM, DAMAGES OR OTHER LIABILITY, WHETHER IN AN ACTION OF CONTRACT, TORT OR OTHERWISE, ARISING FROM, OUT OF OR IN CONNECTION WITH THE SOFTWARE OR THE USE OR OTHER DEALINGS IN THE SOFTWARE.

Except as contained in this notice, the name of a copyright holder shall not be used in advertising or otherwise to promote the sale, use or other dealings in this Software without prior written authorization of the copyright holder.

Copyright (C) 1999, 2000 by Anton Zinoviev <anton@lml.bas.bg>

This software may be used, modified, copied, distributed, and sold, in both source and binary form provided that the above copyright and these terms are retained. Under no circumstances is the author responsible for the proper functioning of this software, nor does the author assume any responsibility for damages incurred with its use.

Permission is granted to anyone to use, distribute and modify this file in any way, provided that the above copyright notice is left intact and the author of the modification summarizes

the changes in this header.

This file is distributed without any expressed or implied warranty.

35.compat-wireless

36.Device Driver for REALTEK RTL8153

37.fusermount

38.Linux

39.WLAN USB Driver

GNU GENERAL PUBLIC LICENSE

Version 2, June 1991

Copyright (C) 1989, 1991 Free Software Foundation, Inc.

51 Franklin Street, Fifth Floor, Boston, MA 02110-1301, USA

Everyone is permitted to copy and distribute verbatim copies of this license document, but changing it is not allowed.

Preamble

The licenses for most software are designed to take away your freedom to share and change it. By contrast, the GNU General Public License is intended to guarantee your freedom to share and change free software--to make sure the software is free for all its users. This General Public License applies to most of the Free Software Foundation's software and to any other program whose authors commit to using it. (Some other Free Software Foundation software is covered by the GNU Lesser General Public License instead.) You can apply it to your programs, too.

When we speak of free software, we are referring to freedom, not price. Our General Public Licenses are designed to make sure that you have the freedom to distribute copies of free software (and charge for this service if you wish), that you receive source code or can get it if you want it, that you can change the software or use pieces of it in new free programs; and that you know you can do these things.

To protect your rights, we need to make restrictions that forbid anyone to deny you these rights or to ask you to surrender the rights. These restrictions translate to certain responsibilities for you if you distribute copies of the software, or if you modify it.

For example, if you distribute copies of such a program, whether gratis or for a fee, you must give the recipients all the rights that you have. You must make sure that they, too, receive or can get the source code. And you must show them these terms so they know their rights.

We protect your rights with two steps: (1) copyright the software, and (2) offer you this license which gives you legal permission to copy, distribute and/or modify the software.

Also, for each author's protection and ours, we want to make certain that everyone understands that there is no warranty for this free software. If the software is modified by someone else and passed on, we want its recipients to know that what they have is not the original, so that any problems introduced by others will not reflect on the original authors' reputations.

Finally, any free program is threatened constantly by software patents. We wish to avoid the danger that redistributors of a free program will individually obtain patent licenses, in effect making the program proprietary. To prevent this, we have made it clear that any patent must be licensed for everyone's free use or not licensed at all.

The precise terms and conditions for copying, distribution and modification follow.

TERMS AND CONDITIONS FOR COPYING, DISTRIBUTION AND MODIFICATION

0. This License applies to any program or other work which contains a notice placed by the copyright holder saying it may be distributed under the terms of this General Public License. The "Program", below, refers to any such program or work, and a "work based on the Program" means either the Program or any derivative work under copyright law: that is to say, a work containing the Program or a portion of it, either verbatim or with modifications and/or translated into another language. (Hereinafter, translation is included without limitation in the term "modification".) Each licensee is addressed as "you".

Activities other than copying, distribution and modification are not covered by this License; they are outside its scope. The act of running the Program is not restricted, and the output from the Program is covered only if its contents constitute a work based on the Program (independent of having been made by running the Program). Whether that is true depends on what the Program does.

1. You may copy and distribute verbatim copies of the Program's source code as you receive it, in any medium, provided that you conspicuously and appropriately publish on each copy an appropriate copyright notice and disclaimer of warranty; keep intact all the notices that refer to this License and to the absence of any warranty; and give any other recipients of the Program a copy of this License along with the Program.

You may charge a fee for the physical act of transferring a copy, and you may at your option offer warranty protection in exchange for a fee.

2. You may modify your copy or copies of the Program or any portion of it, thus forming a work based on the Program, and copy and distribute such modifications or work under the terms of Section 1 above, provided that you also meet all of these conditions:

a) You must cause the modified files to carry prominent notices stating that you changed the files and the date of any change.

b) You must cause any work that you distribute or publish, that in whole or in part contains or is derived from the Program or any part thereof, to be licensed as a whole at no charge to all third parties under the terms of this License.

c) If the modified program normally reads commands interactively when run, you must cause it, when started running for such interactive use in the most ordinary way, to print or display an announcement including an appropriate copyright notice and a notice that there is no warranty (or else, saying that you provide a warranty) and that users may redistribute the program under these conditions, and telling the user how to view a copy of this License. (Exception: if the Program itself is interactive but does not normally print such an announcement, your work based on the Program is not required to print an announcement.)

These requirements apply to the modified work as a whole. If identifiable sections of that work are not derived from the Program, and can be reasonably considered independent and separate works in themselves, then this License, and its terms, do not apply to those sections when you distribute them as separate works. But when you distribute the same sections as part of a whole which is a work based on the Program, the distribution of the whole must be on the terms of this License, whose permissions for other licensees extend to the entire whole, and thus to each and every part regardless of who wrote it.

Thus, it is not the intent of this section to claim rights or contest your rights to work written entirely by you; rather, the intent is to exercise the right to control the distribution of derivative or collective works based on the Program.

In addition, mere aggregation of another work not based on the Program with the Program (or with a work based on the Program) on a volume of a storage or distribution medium does not bring the other work under the scope of this License.

3. You may copy and distribute the Program (or a work based on it, under Section 2) in object code or executable form under the terms of Sections 1 and 2 above provided that you also do one of the following:

a) Accompany it with the complete corresponding machine-readable source code, which must be distributed under the terms of Sections 1 and 2 above on a medium customarily used for software interchange; or,

b) Accompany it with a written offer, valid for at least three years, to give any third party, for a charge no more than your cost of physically performing source distribution, a complete machine-readable copy of the corresponding source code, to be distributed under the terms of Sections 1 and 2 above on a medium customarily used for software interchange; or,

c) Accompany it with the information you received as to the offer to distribute corresponding source code. (This alternative is allowed only for noncommercial distribution and only if you received the program in object code or executable form with such an offer, in accord with Subsection b above.)

The source code for a work means the preferred form of the work for making modifications to it. For an executable work, complete source code means all the source code for all modules it contains, plus any associated interface definition files, plus the scripts used to control compilation and installation of the executable. However, as a special exception, the source code distributed need not include anything that is normally distributed (in either source or binary form) with the major components (compiler, kernel, and so on) of the operating system on which the executable runs, unless that component itself accompanies the executable.

If distribution of executable or object code is made by offering access to copy from a designated place, then offering equivalent access to copy the source code from the same place counts as distribution of the source code, even though third parties are not compelled to copy the source along with the object code.

4. You may not copy, modify, sublicense, or distribute the Program except as expressly provided under this License. Any attempt otherwise to copy, modify, sublicense or distribute the Program is void, and will automatically terminate your rights under this License. However, parties who have received copies, or rights, from you under this License will not have their licenses terminated so long as such parties remain in full compliance.

5. You are not required to accept this License, since you have not signed it. However, nothing else grants you permission to modify or distribute the Program or its derivative works. These actions are prohibited by law if you do not accept this License. Therefore, by modifying or distributing the Program (or any work based on the Program), you indicate your acceptance of this License to do so, and all its terms and conditions for copying, distributing or modifying the Program or works based on it.

6. Each time you redistribute the Program (or any work based on the Program), the recipient automatically receives a license from the original licensor to copy, distribute or modify the Program

subject to these terms and conditions. You may not impose any further restrictions on the recipients' exercise of the rights granted herein. You are not responsible for enforcing compliance by third parties to this License.

7. If, as a consequence of a court judgment or allegation of patent infringement or for any other reason (not limited to patent issues), conditions are imposed on you (whether by court order, agreement or otherwise) that contradict the conditions of this License, they do not excuse you from the conditions of this License. If you cannot distribute so as to satisfy simultaneously your obligations under this License and any other pertinent obligations, then as a consequence you may not distribute the Program at all. For example, if a patent license would not permit royalty-free redistribution of the Program by all those who receive copies directly or indirectly through you, then the only way you could satisfy both it and this License would be to refrain entirely from distribution of the Program.

If any portion of this section is held invalid or unenforceable under any particular circumstance, the balance of the section is intended to apply and the section as a whole is intended to apply in other circumstances.

It is not the purpose of this section to induce you to infringe any patents or other property right claims or to contest validity of any such claims; this section has the sole purpose of protecting the integrity of the free software distribution system, which is implemented by public license practices. Many people have made generous contributions to the wide range of software distributed through that system in reliance on consistent application of that system; it is up to the author/donor to decide if he or she is willing to distribute software through any other system and a licensee cannot impose that choice.

This section is intended to make thoroughly clear what is believed to be a consequence of the rest of this License.

8. If the distribution and/or use of the Program is restricted in certain countries either by patents or by copyrighted interfaces, the original copyright holder who places the Program under this License may add an explicit geographical distribution limitation excluding those countries, so that distribution is permitted only in or among countries not thus excluded. In such case, this License incorporates the limitation as if written in the body of this License.

9. The Free Software Foundation may publish revised and/or new versions of the General Public License from time to time. Such new versions will be similar in spirit to the present version, but may differ in detail to address new problems or concerns.

Each version is given a distinguishing version number. If the Program specifies a version number of this License which applies to it and "any later version", you have the option of following the terms and conditions either of that version or of any later version published by the Free Software Foundation. If the Program does not specify a version number of this License, you may choose any version ever published by the Free Software Foundation.

10. If you wish to incorporate parts of the Program into other free programs whose distribution conditions are different, write to the author to ask for permission. For software which is copyrighted by the Free Software Foundation, write to the Free Software Foundation; we sometimes make exceptions for this. Our decision will be guided by the two goals of preserving the free status of all derivatives of our free software and of promoting the sharing and reuse of software generally.

NO WARRANTY

11. BECAUSE THE PROGRAM IS LICENSED FREE OF CHARGE, THERE IS NO WARRANTY FOR THE PROGRAM, TO THE EXTENT PERMITTED BY APPLICABLE LAW. EXCEPT WHEN OTHERWISE STATED IN WRITING THE COPYRIGHT HOLDERS AND/OR OTHER PARTIES PROVIDE THE PROGRAM "AS IS" WITHOUT WARRANTY OF ANY KIND, EITHER EXPRESSED OR IMPLIED, INCLUDING, BUT NOT LIMITED TO, THE IMPLIED WARRANTIES OF MERCHANTABILITY AND FITNESS FOR A PARTICULAR PURPOSE. THE ENTIRE RISK AS TO THE QUALITY AND PERFORMANCE OF THE PROGRAM IS WITH YOU. SHOULD THE PROGRAM PROVE DEFECTIVE, YOU ASSUME THE COST OF ALL NECESSARY SERVICING, REPAIR OR CORRECTION.

12. IN NO EVENT UNLESS REQUIRED BY APPLICABLE LAW OR AGREED TO IN WRITING WILL ANY COPYRIGHT HOLDER, OR ANY OTHER PARTY WHO MAY MODIFY AND/OR REDISTRIBUTE THE PROGRAM AS PERMITTED ABOVE, BE LIABLE TO YOU FOR DAMAGES, INCLUDING ANY GENERAL, SPECIAL, INCIDENTAL OR CONSEQUENTIAL DAMAGES ARISING OUT OF THE USE OR INABILITY TO USE THE PROGRAM (INCLUDING BUT NOT LIMITED TO LOSS OF DATA OR DATA BEING RENDERED INACCURATE OR LOSSES SUSTAINED BY YOU OR THIRD PARTIES OR A FAILURE OF THE PROGRAM TO OPERATE WITH ANY OTHER PROGRAMS), EVEN IF SUCH HOLDER OR OTHER PARTY HAS BEEN ADVISED OF THE POSSIBILITY OF SUCH DAMAGES.

END OF TERMS AND CONDITIONS

How to Apply These Terms to Your New Programs

If you develop a new program, and you want it to be of the greatest possible use to the public, the best way to achieve this is to make it free software which everyone can redistribute and change under these terms.

To do so, attach the following notices to the program. It is safest to attach them to the start of each source file to most effectively convey the exclusion of warranty; and each file should have at least the "copyright" line and a pointer to where the full notice is found.

one line to give the program's name and an idea of what it does.

Copyright (C) yyyy name of author

This program is free software; you can redistribute it and/or modify it under the terms of the GNU General Public License as published by the Free Software Foundation; either version 2 of the License, or (at your option) any later version.

This program is distributed in the hope that it will be useful, but WITHOUT ANY WARRANTY; without even the implied warranty of MERCHANTABILITY or FITNESS FOR A PARTICULAR PURPOSE. See the GNU General Public License for more details.

You should have received a copy of the GNU General Public License along with this program; if not, write to the Free Software Foundation, Inc., 51 Franklin Street, Fifth Floor, Boston, MA 02110-1301, USA.

Also add information on how to contact you by electronic and paper mail.

If the program is interactive, make it output a short notice like this when it starts in an interactive mode:

Gnomovision version 69, Copyright (C) year name of author
Gnomovision comes with ABSOLUTELY NO WARRANTY; for details
type `show w'. This is free software, and you are welcome
to redistribute it under certain conditions; type `show c'
for details.

The hypothetical commands `show w' and `show c' should show the appropriate parts of the General Public License. Of course, the commands you use may be called something other than `show w' and `show c'; they could even be mouse-clicks or menu items--whatever suits your program.

You should also get your employer (if you work as a programmer) or your school, if any, to sign a "copyright disclaimer" for the program, if necessary. Here is a sample; alter the names:

Yoyodyne, Inc., hereby disclaims all copyright interest in the program `Gnomovision' (which makes passes at compilers) written by James Hacker.

signature of Ty Coon, 1 April 1989
Ty Coon, President of Vice

This General Public License does not permit incorporating your program into proprietary programs. If your program is a subroutine library, you may consider it more useful to permit linking proprietary applications with the library. If this is what you want to do, use the GNU Lesser General Public License instead of this License.

40.atk
41.cairo
42.glib
43.glibc
44.GTK+
45.json-glib
46.libfuse
47.Libnl
48.libusb
49.pango (except OpenTypeCode)

GNU LESSER GENERAL PUBLIC LICENSE

Version 2.1, February 1999

Copyright (C) 1991, 1999 Free Software Foundation, Inc.

51 Franklin Street, Fifth Floor, Boston, MA 02110-1301 USA

Everyone is permitted to copy and distribute verbatim copies of this license document, but changing it is not allowed.

[This is the first released version of the Lesser GPL. It also counts as the successor of the GNU Library Public License, version 2, hence the version number 2.1.]

Preamble

The licenses for most software are designed to take away your freedom to share and change it. By contrast, the GNU General Public Licenses are intended to guarantee your freedom to share and change free software--to make sure the software is free for all its users.

This license, the Lesser General Public License, applies to some specially designated software packages--typically libraries--of the Free Software Foundation and other authors who decide to use it. You can use it too, but we suggest you first think carefully about whether this license or the ordinary General Public License is the better strategy to use in any particular case, based on the explanations below.

When we speak of free software, we are referring to freedom of use, not price. Our General Public Licenses are designed to make sure that you have the freedom to distribute copies of free software (and charge for this service if you wish); that you receive source code or can get it if you want it; that you can change the software and use pieces of it in new free programs; and that you are informed that you can do these things.

To protect your rights, we need to make restrictions that forbid distributors to deny you these rights or to ask you to surrender these rights. These restrictions translate to certain responsibilities for you

if you distribute copies of the library or if you modify it.

For example, if you distribute copies of the library, whether gratis or for a fee, you must give the recipients all the rights that we gave you. You must make sure that they, too, receive or can get the source code. If you link other code with the library, you must provide complete object files to the recipients, so that they can relink them with the library after making changes to the library and recompiling it. And you must show them these terms so they know their rights.

We protect your rights with a two-step method: (1) we copyright the library, and (2) we offer you this license, which gives you legal permission to copy, distribute and/or modify the library.

To protect each distributor, we want to make it very clear that there is no warranty for the free library. Also, if the library is modified by someone else and passed on, the recipients should know that what they have is not the original version, so that the original author's reputation will not be affected by problems that might be introduced by others.

Finally, software patents pose a constant threat to the existence of any free program. We wish to make sure that a company cannot effectively restrict the users of a free program by obtaining a restrictive license from a patent holder. Therefore, we insist that any patent license obtained for a version of the library must be consistent with the full freedom of use specified in this license.

Most GNU software, including some libraries, is covered by the ordinary GNU General Public License. This license, the GNU Lesser General Public License, applies to certain designated libraries, and is quite different from the ordinary General Public License. We use this license for certain libraries in order to permit linking those libraries into non-free programs.

When a program is linked with a library, whether statically or using a shared library, the combination of the two is legally speaking a combined work, a derivative of the original library. The ordinary General Public License therefore permits such linking only if the entire combination fits its criteria of freedom. The Lesser General Public License permits more lax criteria for linking other code with the library.

We call this license the "Lesser" General Public License because it does Less to protect the user's freedom than the ordinary General Public License. It also provides other free software developers Less of an advantage over competing non-free programs. These disadvantages are the reason we use the ordinary General Public License for many libraries. However, the Lesser license provides advantages in certain special circumstances.

For example, on rare occasions, there may be a special need to encourage the widest possible use of a certain library, so that it becomes a de-facto standard. To achieve this, non-free programs must be allowed to use the library. A more frequent case is that a free library does the same job as widely used non-free libraries. In this case, there is little to gain by limiting the free library to free software only, so we use the Lesser General Public License.

In other cases, permission to use a particular library in non-free programs enables a greater number of people to use a large body of free software. For example, permission to use the GNU C Library in non-free programs enables many more people to use the whole GNU operating system, as well as its

variant, the GNU/Linux operating system.

Although the Lesser General Public License is Less protective of the users' freedom, it does ensure that the user of a program that is linked with the Library has the freedom and the wherewithal to run that program using a modified version of the Library.

The precise terms and conditions for copying, distribution and modification follow. Pay close attention to the difference between a "work based on the library" and a "work that uses the library". The former contains code derived from the library, whereas the latter must be combined with the library in order to run.

TERMS AND CONDITIONS FOR COPYING, DISTRIBUTION AND MODIFICATION

0. This License Agreement applies to any software library or other program which contains a notice placed by the copyright holder or other authorized party saying it may be distributed under the terms of this Lesser General Public License (also called "this License"). Each licensee is addressed as "you". A "library" means a collection of software functions and/or data prepared so as to be conveniently linked with application programs (which use some of those functions and data) to form executables. The "Library", below, refers to any such software library or work which has been distributed under these terms. A "work based on the Library" means either the Library or any derivative work under copyright law: that is to say, a work containing the Library or a portion of it, either verbatim or with modifications and/or translated straightforwardly into another language. (Hereinafter, translation is included without limitation in the term "modification".)

"Source code" for a work means the preferred form of the work for making modifications to it. For a library, complete source code means all the source code for all modules it contains, plus any associated interface definition files, plus the scripts used to control compilation and installation of the library.

Activities other than copying, distribution and modification are not covered by this License; they are outside its scope. The act of running a program using the Library is not restricted, and output from such a program is covered only if its contents constitute a work based on the Library (independent of the use of the Library in a tool for writing it). Whether that is true depends on what the Library does and what the program that uses the Library does.

1. You may copy and distribute verbatim copies of the Library's complete source code as you receive it, in any medium, provided that you conspicuously and appropriately publish on each copy an appropriate copyright notice and disclaimer of warranty; keep intact all the notices that refer to this License and to the absence of any warranty; and distribute a copy of this License along with the Library.

You may charge a fee for the physical act of transferring a copy, and you may at your option offer warranty protection in exchange for a fee.

2. You may modify your copy or copies of the Library or any portion of it, thus forming a work based on the Library, and copy and distribute such modifications or work under the terms of Section 1 above, provided that you also meet all of these conditions:

- a) The modified work must itself be a software library.
- b) You must cause the files modified to carry prominent notices stating that you changed the files and the date of any change.
- c) You must cause the whole of the work to be licensed at no charge to all third parties under the terms of this License.
- d) If a facility in the modified Library refers to a function or a table of data to be supplied by an application program that uses the facility, other than as an argument passed when the facility is invoked, then you must make a good faith effort to ensure that, in the event an application does not supply such function or table, the facility still operates, and performs whatever part of its purpose remains meaningful.

(For example, a function in a library to compute square roots has a purpose that is entirely well-defined independent of the application. Therefore, Subsection 2d requires that any application-supplied function or table used by this function must be optional: if the application does not supply it, the square root function must still compute square roots.)

These requirements apply to the modified work as a whole. If identifiable sections of that work are not derived from the Library, and can be reasonably considered independent and separate works in themselves, then this License, and its terms, do not apply to those sections when you distribute them as separate works. But when you distribute the same sections as part of a whole which is a work based on the Library, the distribution of the whole must be on the terms of this License, whose permissions for other licensees extend to the entire whole, and thus to each and every part regardless of who wrote it.

Thus, it is not the intent of this section to claim rights or contest your rights to work written entirely by you; rather, the intent is to exercise the right to control the distribution of derivative or collective works based on the Library.

In addition, mere aggregation of another work not based on the Library with the Library (or with a work based on the Library) on a volume of a storage or distribution medium does not bring the other work under the scope of this License.

3. You may opt to apply the terms of the ordinary GNU General Public License instead of this License to a given copy of the Library. To do this, you must alter all the notices that refer to this License, so that they refer to the ordinary GNU General Public License, version 2, instead of to this License. (If a newer version than version 2 of the ordinary GNU General Public License has appeared, then you can specify that version instead if you wish.) Do not make any other change in these notices.

Once this change is made in a given copy, it is irreversible for that copy, so the ordinary GNU General Public License applies to all subsequent copies and derivative works made from that copy.

This option is useful when you wish to copy part of the code of the Library into a program that is not a library.

4. You may copy and distribute the Library (or a portion or derivative of it, under Section 2) in object code or executable form under the terms of Sections 1 and 2 above provided that you accompany it

with the complete corresponding machine-readable source code, which must be distributed under the terms of Sections 1 and 2 above on a medium customarily used for software interchange.

If distribution of object code is made by offering access to copy from a designated place, then offering equivalent access to copy the source code from the same place satisfies the requirement to distribute the source code, even though third parties are not compelled to copy the source along with the object code.

5. A program that contains no derivative of any portion of the Library, but is designed to work with the Library by being compiled or linked with it, is called a "work that uses the Library". Such a work, in isolation, is not a derivative work of the Library, and therefore falls outside the scope of this License. However, linking a "work that uses the Library" with the Library creates an executable that is a derivative of the Library (because it contains portions of the Library), rather than a "work that uses the library". The executable is therefore covered by this License. Section 6 states terms for distribution of such executables.

When a "work that uses the Library" uses material from a header file that is part of the Library, the object code for the work may be a derivative work of the Library even though the source code is not. Whether this is true is especially significant if the work can be linked without the Library, or if the work is itself a library. The threshold for this to be true is not precisely defined by law.

If such an object file uses only numerical parameters, data structure layouts and accessors, and small macros and small inline functions (ten lines or less in length), then the use of the object file is unrestricted, regardless of whether it is legally a derivative work. (Executables containing this object code plus portions of the Library will still fall under Section 6.)

Otherwise, if the work is a derivative of the Library, you may distribute the object code for the work under the terms of Section 6. Any executables containing that work also fall under Section 6, whether or not they are linked directly with the Library itself.

6. As an exception to the Sections above, you may also combine or link a "work that uses the Library" with the Library to produce a work containing portions of the Library, and distribute that work under terms of your choice, provided that the terms permit modification of the work for the customer's own use and reverse engineering for debugging such modifications.

You must give prominent notice with each copy of the work that the Library is used in it and that the Library and its use are covered by this License. You must supply a copy of this License. If the work during execution displays copyright notices, you must include the copyright notice for the Library among them, as well as a reference directing the user to the copy of this License. Also, you must do one of these things:

- a) Accompany the work with the complete corresponding machine-readable source code for the Library including whatever changes were used in the work (which must be distributed under Sections 1 and 2 above); and, if the work is an executable linked with the Library, with the complete machine-readable "work that uses the Library", as object code and/or source code, so that the user can modify the Library and then relink to produce a modified executable containing the modified

Library. (It is understood that the user who changes the contents of definitions files in the Library will not necessarily be able to recompile the application to use the modified definitions.)

- b) Use a suitable shared library mechanism for linking with the Library. A suitable mechanism is one that (1) uses at run time a copy of the library already present on the user's computer system, rather than copying library functions into the executable, and (2) will operate properly with a modified version of the library, if the user installs one, as long as the modified version is interface-compatible with the version that the work was made with.

- c) Accompany the work with a written offer, valid for at least three years, to give the same user the materials specified in Subsection 6a, above, for a charge no more than the cost of performing this distribution.

- d) If distribution of the work is made by offering access to copy from a designated place, offer equivalent access to copy the above specified materials from the same place.

- e) Verify that the user has already received a copy of these materials or that you have already sent this user a copy.

For an executable, the required form of the "work that uses the Library" must include any data and utility programs needed for reproducing the executable from it. However, as a special exception, the materials to be distributed need not include anything that is normally distributed (in either source or binary form) with the major components (compiler, kernel, and so on) of the operating system on which the executable runs, unless that component itself accompanies the executable.

It may happen that this requirement contradicts the license restrictions of other proprietary libraries that do not normally accompany the operating system. Such a contradiction means you cannot use both them and the Library together in an executable that you distribute.

7. You may place library facilities that are a work based on the Library side-by-side in a single library together with other library facilities not covered by this License, and distribute such a combined library, provided that the separate distribution of the work based on the Library and of the other library facilities is otherwise permitted, and provided that you do these two things:

- a) Accompany the combined library with a copy of the same work based on the Library, uncombined with any other library facilities. This must be distributed under the terms of the Sections above.

- b) Give prominent notice with the combined library of the fact that part of it is a work based on the Library, and explaining where to find the accompanying uncombined form of the same work.

8. You may not copy, modify, sublicense, link with, or distribute the Library except as expressly provided under this License. Any attempt otherwise to copy, modify, sublicense, link with, or distribute the Library is void, and will automatically terminate your rights under this License. However, parties who have received copies, or rights, from you under this License will not have their licenses terminated so long as such parties remain in full compliance.

9. You are not required to accept this License, since you have not signed it. However, nothing else grants you permission to modify or distribute the Library or its derivative works. These actions are

prohibited by law if you do not accept this License. Therefore, by modifying or distributing the Library (or any work based on the Library), you indicate your acceptance of this License to do so, and all its terms and conditions for copying, distributing or modifying the Library or works based on it.

10. Each time you redistribute the Library (or any work based on the Library), the recipient automatically receives a license from the original licensor to copy, distribute, link with or modify the Library subject to these terms and conditions. You may not impose any further restrictions on the recipients' exercise of the rights granted herein. You are not responsible for enforcing compliance by third parties with this License.

11. If, as a consequence of a court judgment or allegation of patent infringement or for any other reason (not limited to patent issues), conditions are imposed on you (whether by court order, agreement or otherwise) that contradict the conditions of this License, they do not excuse you from the conditions of this License. If you cannot distribute so as to satisfy simultaneously your obligations under this License and any other pertinent obligations, then as a consequence you may not distribute the Library at all. For example, if a patent license would not permit royalty-free redistribution of the Library by all those who receive copies directly or indirectly through you, then the only way you could satisfy both it and this License would be to refrain entirely from distribution of the Library.

If any portion of this section is held invalid or unenforceable under any particular circumstance, the balance of the section is intended to apply, and the section as a whole is intended to apply in other circumstances.

It is not the purpose of this section to induce you to infringe any patents or other property right claims or to contest validity of any such claims; this section has the sole purpose of protecting the integrity of the free software distribution system which is implemented by public license practices. Many people have made generous contributions to the wide range of software distributed through that system in reliance on consistent application of that system; it is up to the author/donor to decide if he or she is willing to distribute software through any other system and a licensee cannot impose that choice.

This section is intended to make thoroughly clear what is believed to be a consequence of the rest of this License.

12. If the distribution and/or use of the Library is restricted in certain countries either by patents or by copyrighted interfaces, the original copyright holder who places the Library under this License may add an explicit geographical distribution limitation excluding those countries, so that distribution is permitted only in or among countries not thus excluded. In such case, this License incorporates the limitation as if written in the body of this License.

13. The Free Software Foundation may publish revised and/or new versions of the Lesser General Public License from time to time. Such new versions will be similar in spirit to the present version, but may differ in detail to address new problems or concerns.

Each version is given a distinguishing version number. If the Library specifies a version number of this License which applies to it and "any later version", you have the option of following the terms

and conditions either of that version or of any later version published by the Free Software Foundation. If the Library does not specify a license version number, you may choose any version ever published by the Free Software Foundation.

14. If you wish to incorporate parts of the Library into other free programs whose distribution conditions are incompatible with these, write to the author to ask for permission. For software which is copyrighted by the Free Software Foundation, write to the Free Software Foundation; we sometimes make exceptions for this. Our decision will be guided by the two goals of preserving the free status of all derivatives of our free software and of promoting the sharing and reuse of software generally.

NO WARRANTY

15. BECAUSE THE LIBRARY IS LICENSED FREE OF CHARGE, THERE IS NO WARRANTY FOR THE LIBRARY, TO THE EXTENT PERMITTED BY APPLICABLE LAW. EXCEPT WHEN OTHERWISE STATED IN WRITING THE COPYRIGHT HOLDERS AND/OR OTHER PARTIES PROVIDE THE LIBRARY "AS IS" WITHOUT WARRANTY OF ANY KIND, EITHER EXPRESSED OR IMPLIED, INCLUDING, BUT NOT LIMITED TO, THE IMPLIED WARRANTIES OF MERCHANTABILITY AND FITNESS FOR A PARTICULAR PURPOSE. THE ENTIRE RISK AS TO THE QUALITY AND PERFORMANCE OF THE LIBRARY IS WITH YOU. SHOULD THE LIBRARY PROVE DEFECTIVE, YOU ASSUME THE COST OF ALL NECESSARY SERVICING, REPAIR OR CORRECTION.

16. IN NO EVENT UNLESS REQUIRED BY APPLICABLE LAW OR AGREED TO IN WRITING WILL ANY COPYRIGHT HOLDER, OR ANY OTHER PARTY WHO MAY MODIFY AND/OR REDISTRIBUTE THE LIBRARY AS PERMITTED ABOVE, BE LIABLE TO YOU FOR DAMAGES, INCLUDING ANY GENERAL, SPECIAL, INCIDENTAL OR CONSEQUENTIAL DAMAGES ARISING OUT OF THE USE OR INABILITY TO USE THE LIBRARY (INCLUDING BUT NOT LIMITED TO LOSS OF DATA OR DATA BEING RENDERED INACCURATE OR LOSSES SUSTAINED BY YOU OR THIRD PARTIES OR A FAILURE OF THE LIBRARY TO OPERATE WITH ANY OTHER SOFTWARE), EVEN IF SUCH HOLDER OR OTHER PARTY HAS BEEN ADVISED OF THE POSSIBILITY OF SUCH DAMAGES.

END OF TERMS AND CONDITIONS

How to Apply These Terms to Your New Libraries

If you develop a new library, and you want it to be of the greatest possible use to the public, we recommend making it free software that everyone can redistribute and change. You can do so by permitting redistribution under these terms (or, alternatively, under the terms of the ordinary General Public License).

To apply these terms, attach the following notices to the library. It is safest to attach them to the start of each source file to most effectively convey the exclusion of warranty; and each file should have at least the "copyright" line and a pointer to where the full notice is found.

one line to give the library's name and an idea of what it does.

Copyright (C) year name of author

This library is free software; you can redistribute it and/or modify it under the terms of the GNU Lesser General Public

License as published by the Free Software Foundation; either version 2.1 of the License, or (at your option) any later version.

This library is distributed in the hope that it will be useful, but WITHOUT ANY WARRANTY; without even the implied warranty of MERCHANTABILITY or FITNESS FOR A PARTICULAR PURPOSE. See the GNU Lesser General Public License for more details.

You should have received a copy of the GNU Lesser General Public License along with this library; if not, write to the Free Software Foundation, Inc., 51 Franklin Street, Fifth Floor, Boston, MA 02110-1301 USA
Also add information on how to contact you by electronic and paper mail.

You should also get your employer (if you work as a programmer) or your school, if any, to sign a "copyright disclaimer" for the library, if necessary. Here is a sample; alter the names:
Yoyodyne, Inc., hereby disclaims all copyright interest in
the library `Frob' (a library for tweaking knobs) written
by James Random Hacker.

signature of Ty Coon, 1 April 1990
Ty Coon, President of Vice
That's all there is to it!

50.iproute

GNU GENERAL PUBLIC LICENSE

Version 2, June 1991

Copyright (C) 1989, 1991 Free Software Foundation, Inc.

51 Franklin St, Fifth Floor, Boston, MA 02110-1301 USA

Everyone is permitted to copy and distribute verbatim copies of this license document, but changing it is not allowed.

Preamble

The licenses for most software are designed to take away your freedom to share and change it. By contrast, the GNU General Public License is intended to guarantee your freedom to share and change free software--to make sure the software is free for all its users. This General Public License applies to most of the Free Software Foundation's software and to any other program whose authors commit to using it. (Some other Free Software Foundation software is covered by the GNU Library General Public License instead.) You can apply it to your programs, too.

When we speak of free software, we are referring to freedom, not price. Our General Public Licenses are designed to make sure that you have the freedom to distribute copies of free software (and charge for this service if you wish), that you receive source code or can get it if you want it, that you can change the software or use pieces of it in new free programs; and that you know you can do these things.

To protect your rights, we need to make restrictions that forbid anyone to deny you these rights or to ask you to surrender the rights. These restrictions translate to certain responsibilities for you if you distribute copies of the software, or if you modify it.

For example, if you distribute copies of such a program, whether gratis or for a fee, you must give the recipients all the rights that you have. You must make sure that they, too, receive or can get the

source code. And you must show them these terms so they know their rights.

We protect your rights with two steps: (1) copyright the software, and (2) offer you this license which gives you legal permission to copy, distribute and/or modify the software.

Also, for each author's protection and ours, we want to make certain that everyone understands that there is no warranty for this free software. If the software is modified by someone else and passed on, we want its recipients to know that what they have is not the original, so that any problems introduced by others will not reflect on the original authors' reputations.

Finally, any free program is threatened constantly by software patents. We wish to avoid the danger that redistributors of a free program will individually obtain patent licenses, in effect making the program proprietary. To prevent this, we have made it clear that any patent must be licensed for everyone's free use or not licensed at all.

The precise terms and conditions for copying, distribution and modification follow.

GNU GENERAL PUBLIC LICENSE

TERMS AND CONDITIONS FOR COPYING, DISTRIBUTION AND MODIFICATION

0. This License applies to any program or other work which contains a notice placed by the copyright holder saying it may be distributed under the terms of this General Public License. The "Program", below, refers to any such program or work, and a "work based on the Program" means either the Program or any derivative work under copyright law: that is to say, a work containing the Program or a portion of it, either verbatim or with modifications and/or translated into another language. (Hereinafter, translation is included without limitation in the term "modification".) Each licensee is addressed as "you".

Activities other than copying, distribution and modification are not covered by this License; they are outside its scope. The act of

running the Program is not restricted, and the output from the Program is covered only if its contents constitute a work based on the Program (independent of having been made by running the Program). Whether that is true depends on what the Program does.

1. You may copy and distribute verbatim copies of the Program's source code as you receive it, in any medium, provided that you conspicuously and appropriately publish on each copy an appropriate copyright notice and disclaimer of warranty; keep intact all the notices that refer to this License and to the absence of any warranty; and give any other recipients of the Program a copy of this License along with the Program.

You may charge a fee for the physical act of transferring a copy, and you may at your option offer warranty protection in exchange for a fee.

2. You may modify your copy or copies of the Program or any portion of it, thus forming a work based on the Program, and copy and distribute such modifications or work under the terms of Section 1 above, provided that you also meet all of these conditions:

a) You must cause the modified files to carry prominent notices stating that you changed the files and the date of any change.

b) You must cause any work that you distribute or publish, that in whole or in part contains or is derived from the Program or any part thereof, to be licensed as a whole at no charge to all third parties under the terms of this License.

c) If the modified program normally reads commands interactively when run, you must cause it, when started running for such interactive use in the most ordinary way, to print or display an announcement including an appropriate copyright notice and a notice that there is no warranty (or else, saying that you provide a warranty) and that users may redistribute the program under these conditions, and telling the user how to view a copy of this License. (Exception: if the Program itself is interactive but does not normally print such an announcement, your work based on

the Program is not required to print an announcement.)

These requirements apply to the modified work as a whole. If identifiable sections of that work are not derived from the Program, and can be reasonably considered independent and separate works in themselves, then this License, and its terms, do not apply to those sections when you distribute them as separate works. But when you distribute the same sections as part of a whole which is a work based on the Program, the distribution of the whole must be on the terms of this License, whose permissions for other licensees extend to the entire whole, and thus to each and every part regardless of who wrote it.

Thus, it is not the intent of this section to claim rights or contest your rights to work written entirely by you; rather, the intent is to exercise the right to control the distribution of derivative or collective works based on the Program.

In addition, mere aggregation of another work not based on the Program with the Program (or with a work based on the Program) on a volume of a storage or distribution medium does not bring the other work under the scope of this License.

3. You may copy and distribute the Program (or a work based on it, under Section 2) in object code or executable form under the terms of Sections 1 and 2 above provided that you also do one of the following:

- a) Accompany it with the complete corresponding machine-readable source code, which must be distributed under the terms of Sections 1 and 2 above on a medium customarily used for software interchange; or,
- b) Accompany it with a written offer, valid for at least three years, to give any third party, for a charge no more than your cost of physically performing source distribution, a complete machine-readable copy of the corresponding source code, to be distributed under the terms of Sections 1 and 2 above on a medium customarily used for software interchange; or,
- c) Accompany it with the information you received as to the offer

to distribute corresponding source code. (This alternative is allowed only for noncommercial distribution and only if you received the program in object code or executable form with such an offer, in accord with Subsection b above.)

The source code for a work means the preferred form of the work for making modifications to it. For an executable work, complete source code means all the source code for all modules it contains, plus any associated interface definition files, plus the scripts used to control compilation and installation of the executable. However, as a special exception, the source code distributed need not include anything that is normally distributed (in either source or binary form) with the major components (compiler, kernel, and so on) of the operating system on which the executable runs, unless that component itself accompanies the executable.

If distribution of executable or object code is made by offering access to copy from a designated place, then offering equivalent access to copy the source code from the same place counts as distribution of the source code, even though third parties are not compelled to copy the source along with the object code.

4. You may not copy, modify, sublicense, or distribute the Program except as expressly provided under this License. Any attempt otherwise to copy, modify, sublicense or distribute the Program is void, and will automatically terminate your rights under this License. However, parties who have received copies, or rights, from you under this License will not have their licenses terminated so long as such parties remain in full compliance.

5. You are not required to accept this License, since you have not signed it. However, nothing else grants you permission to modify or distribute the Program or its derivative works. These actions are prohibited by law if you do not accept this License. Therefore, by modifying or distributing the Program (or any work based on the Program), you indicate your acceptance of this License to do so, and all its terms and conditions for copying, distributing or modifying the Program or works based on it.

6. Each time you redistribute the Program (or any work based on the Program), the recipient automatically receives a license from the original licensor to copy, distribute or modify the Program subject to these terms and conditions. You may not impose any further restrictions on the recipients' exercise of the rights granted herein. You are not responsible for enforcing compliance by third parties to this License.

7. If, as a consequence of a court judgment or allegation of patent infringement or for any other reason (not limited to patent issues), conditions are imposed on you (whether by court order, agreement or otherwise) that contradict the conditions of this License, they do not excuse you from the conditions of this License. If you cannot distribute so as to satisfy simultaneously your obligations under this License and any other pertinent obligations, then as a consequence you may not distribute the Program at all. For example, if a patent license would not permit royalty-free redistribution of the Program by all those who receive copies directly or indirectly through you, then the only way you could satisfy both it and this License would be to refrain entirely from distribution of the Program.

If any portion of this section is held invalid or unenforceable under any particular circumstance, the balance of the section is intended to apply and the section as a whole is intended to apply in other circumstances.

It is not the purpose of this section to induce you to infringe any patents or other property right claims or to contest validity of any such claims; this section has the sole purpose of protecting the integrity of the free software distribution system, which is implemented by public license practices. Many people have made generous contributions to the wide range of software distributed through that system in reliance on consistent application of that system; it is up to the author/donor to decide if he or she is willing to distribute software through any other system and a licensee cannot impose that choice.

This section is intended to make thoroughly clear what is believed to be a consequence of the rest of this License.

8. If the distribution and/or use of the Program is restricted in certain countries either by patents or by copyrighted interfaces, the original copyright holder who places the Program under this License may add an explicit geographical distribution limitation excluding those countries, so that distribution is permitted only in or among countries not thus excluded. In such case, this License incorporates the limitation as if written in the body of this License.

9. The Free Software Foundation may publish revised and/or new versions of the General Public License from time to time. Such new versions will be similar in spirit to the present version, but may differ in detail to address new problems or concerns.

Each version is given a distinguishing version number. If the Program specifies a version number of this License which applies to it and "any later version", you have the option of following the terms and conditions either of that version or of any later version published by the Free Software Foundation. If the Program does not specify a version number of this License, you may choose any version ever published by the Free Software Foundation.

10. If you wish to incorporate parts of the Program into other free programs whose distribution conditions are different, write to the author to ask for permission. For software which is copyrighted by the Free Software Foundation, write to the Free Software Foundation; we sometimes make exceptions for this. Our decision will be guided by the two goals of preserving the free status of all derivatives of our free software and of promoting the sharing and reuse of software generally.

NO WARRANTY

11. BECAUSE THE PROGRAM IS LICENSED FREE OF CHARGE, THERE IS NO WARRANTY FOR THE PROGRAM, TO THE EXTENT PERMITTED BY APPLICABLE LAW. EXCEPT WHEN OTHERWISE STATED IN WRITING THE COPYRIGHT HOLDERS AND/OR OTHER PARTIES PROVIDE THE PROGRAM "AS IS" WITHOUT WARRANTY OF ANY KIND, EITHER EXPRESSED

OR IMPLIED, INCLUDING, BUT NOT LIMITED TO, THE IMPLIED WARRANTIES OF MERCHANTABILITY AND FITNESS FOR A PARTICULAR PURPOSE. THE ENTIRE RISK AS TO THE QUALITY AND PERFORMANCE OF THE PROGRAM IS WITH YOU. SHOULD THE PROGRAM PROVE DEFECTIVE, YOU ASSUME THE COST OF ALL NECESSARY SERVICING, REPAIR OR CORRECTION.

12. IN NO EVENT UNLESS REQUIRED BY APPLICABLE LAW OR AGREED TO IN WRITING WILL ANY COPYRIGHT HOLDER, OR ANY OTHER PARTY WHO MAY MODIFY AND/OR REDISTRIBUTE THE PROGRAM AS PERMITTED ABOVE, BE LIABLE TO YOU FOR DAMAGES, INCLUDING ANY GENERAL, SPECIAL, INCIDENTAL OR CONSEQUENTIAL DAMAGES ARISING OUT OF THE USE OR INABILITY TO USE THE PROGRAM (INCLUDING BUT NOT LIMITED TO LOSS OF DATA OR DATA BEING RENDERED INACCURATE OR LOSSES SUSTAINED BY YOU OR THIRD PARTIES OR A FAILURE OF THE PROGRAM TO OPERATE WITH ANY OTHER PROGRAMS), EVEN IF SUCH HOLDER OR OTHER PARTY HAS BEEN ADVISED OF THE POSSIBILITY OF SUCH DAMAGES.

END OF TERMS AND CONDITIONS

How to Apply These Terms to Your New Programs

If you develop a new program, and you want it to be of the greatest possible use to the public, the best way to achieve this is to make it free software which everyone can redistribute and change under these terms.

To do so, attach the following notices to the program. It is safest to attach them to the start of each source file to most effectively convey the exclusion of warranty; and each file should have at least the "copyright" line and a pointer to where the full notice is found.

```
<one line to give the program's name and a brief idea of what it does.>  
Copyright (C) <year> <name of author>
```

This program is free software; you can redistribute it and/or modify it under the terms of the GNU General Public License as published by the Free Software Foundation; either version 2 of the License, or (at your option) any later version.

This program is distributed in the hope that it will be useful,

but WITHOUT ANY WARRANTY; without even the implied warranty of MERCHANTABILITY or FITNESS FOR A PARTICULAR PURPOSE. See the GNU General Public License for more details.

You should have received a copy of the GNU General Public License along with this program; if not, write to the Free Software Foundation, Inc., 51 Franklin St, Fifth Floor, Boston, MA 02110-1301 USA

Also add information on how to contact you by electronic and paper mail.

If the program is interactive, make it output a short notice like this when it starts in an interactive mode:

```
Gnomovision version 69, Copyright (C) year name of author
Gnomovision comes with ABSOLUTELY NO WARRANTY; for details type `show w'.
This is free software, and you are welcome to redistribute it
under certain conditions; type `show c' for details.
```

The hypothetical commands ``show w'` and ``show c'` should show the appropriate parts of the General Public License. Of course, the commands you use may be called something other than ``show w'` and ``show c'`; they could even be mouse-clicks or menu items--whatever suits your program.

You should also get your employer (if you work as a programmer) or your school, if any, to sign a "copyright disclaimer" for the program, if necessary. Here is a sample; alter the names:

```
Yoyodyne, Inc., hereby disclaims all copyright interest in the program
`Gnomovision' (which makes passes at compilers) written by James Hacker.
```

```
<signature of Ty Coon>, 1 April 1989
Ty Coon, President of Vice
```

This General Public License does not permit incorporating your program into proprietary programs. If your program is a subroutine library, you may consider it more useful to permit linking proprietary applications with the library. If this is what you want to do, use the GNU Library General

Public License instead of this License.

* Copyright (c) 1982, 1986, 1993

* The Regents of the University of California. All rights reserved.

*

* Redistribution and use in source and binary forms, with or without
* modification, are permitted provided that the following conditions
* are met:

* 1. Redistributions of source code must retain the above copyright
* notice, this list of conditions and the following disclaimer.

* 2. Redistributions in binary form must reproduce the above copyright
* notice, this list of conditions and the following disclaimer in the
* documentation and/or other materials provided with the distribution.

* 4. Neither the name of the University nor the names of its contributors
* may be used to endorse or promote products derived from this software
* without specific prior written permission.

*

* THIS SOFTWARE IS PROVIDED BY THE REGENTS AND CONTRIBUTORS ``AS IS" AND
* ANY EXPRESS OR IMPLIED WARRANTIES, INCLUDING, BUT NOT LIMITED TO, THE
* IMPLIED WARRANTIES OF MERCHANTABILITY AND FITNESS FOR A PARTICULAR PURPOSE
* ARE DISCLAIMED. IN NO EVENT SHALL THE REGENTS OR CONTRIBUTORS BE LIABLE
* FOR ANY DIRECT, INDIRECT, INCIDENTAL, SPECIAL, EXEMPLARY, OR CONSEQUENTIAL
* DAMAGES (INCLUDING, BUT NOT LIMITED TO, PROCUREMENT OF SUBSTITUTE GOODS
* OR SERVICES; LOSS OF USE, DATA, OR PROFITS; OR BUSINESS INTERRUPTION)
* HOWEVER CAUSED AND ON ANY THEORY OF LIABILITY, WHETHER IN CONTRACT, STRICT
* LIABILITY, OR TORT (INCLUDING NEGLIGENCE OR OTHERWISE) ARISING IN ANY WAY
* OUT OF THE USE OF THIS SOFTWARE, EVEN IF ADVISED OF THE POSSIBILITY OF
* SUCH DAMAGE.

51.Squid

GNU GENERAL PUBLIC LICENSE

Version 2, June 1991

Copyright (C) 1989, 1991 Free Software Foundation, Inc.

59 Temple Place, Suite 330, Boston, MA 02111, USA

Everyone is permitted to copy and distribute verbatim copies of this license document, but changing it is not allowed.

Preamble

The licenses for most software are designed to take away your freedom to share and change it. By contrast, the GNU General Public License is intended to guarantee your freedom to share and change free software--to make sure the software is free for all its users. This General Public License applies to most of the Free Software Foundation's software and to any other program whose authors commit to using it. (Some other Free Software Foundation software is covered by the GNU Library General Public License instead.) You can apply it to your programs, too.

When we speak of free software, we are referring to freedom, not price. Our General Public Licenses are designed to make sure that you have the freedom to distribute copies of free software (and charge for this service if you wish), that you receive source code or can get it if you want it, that you can change the software or use pieces of it in new free programs; and that you know you can do these things.

To protect your rights, we need to make restrictions that forbid anyone to deny you these rights or to ask you to surrender the rights. These restrictions translate to certain responsibilities for you if you distribute copies of the software, or if you modify it.

For example, if you distribute copies of such a program, whether gratis or for a fee, you must give the recipients all the rights that you have. You must make sure that they, too, receive or can get the

source code. And you must show them these terms so they know their rights.

We protect your rights with two steps: (1) copyright the software, and (2) offer you this license which gives you legal permission to copy, distribute and/or modify the software.

Also, for each author's protection and ours, we want to make certain that everyone understands that there is no warranty for this free software. If the software is modified by someone else and passed on, we want its recipients to know that what they have is not the original, so that any problems introduced by others will not reflect on the original authors' reputations.

Finally, any free program is threatened constantly by software patents. We wish to avoid the danger that redistributors of a free program will individually obtain patent licenses, in effect making the program proprietary. To prevent this, we have made it clear that any patent must be licensed for everyone's free use or not licensed at all.

The precise terms and conditions for copying, distribution and modification follow.

GNU GENERAL PUBLIC LICENSE

TERMS AND CONDITIONS FOR COPYING, DISTRIBUTION AND MODIFICATION

0. This License applies to any program or other work which contains a notice placed by the copyright holder saying it may be distributed under the terms of this General Public License. The "Program", below, refers to any such program or work, and a "work based on the Program" means either the Program or any derivative work under copyright law: that is to say, a work containing the Program or a portion of it, either verbatim or with modifications and/or translated into another language. (Hereinafter, translation is included without limitation in the term "modification".) Each licensee is addressed as "you".

Activities other than copying, distribution and modification are not covered by this License; they are outside its scope. The act of

running the Program is not restricted, and the output from the Program is covered only if its contents constitute a work based on the Program (independent of having been made by running the Program). Whether that is true depends on what the Program does.

1. You may copy and distribute verbatim copies of the Program's source code as you receive it, in any medium, provided that you conspicuously and appropriately publish on each copy an appropriate copyright notice and disclaimer of warranty; keep intact all the notices that refer to this License and to the absence of any warranty; and give any other recipients of the Program a copy of this License along with the Program.

You may charge a fee for the physical act of transferring a copy, and you may at your option offer warranty protection in exchange for a fee.

2. You may modify your copy or copies of the Program or any portion of it, thus forming a work based on the Program, and copy and distribute such modifications or work under the terms of Section 1 above, provided that you also meet all of these conditions:

a) You must cause the modified files to carry prominent notices stating that you changed the files and the date of any change.

b) You must cause any work that you distribute or publish, that in whole or in part contains or is derived from the Program or any part thereof, to be licensed as a whole at no charge to all third parties under the terms of this License.

c) If the modified program normally reads commands interactively when run, you must cause it, when started running for such interactive use in the most ordinary way, to print or display an announcement including an appropriate copyright notice and a notice that there is no warranty (or else, saying that you provide a warranty) and that users may redistribute the program under these conditions, and telling the user how to view a copy of this License. (Exception: if the Program itself is interactive but does not normally print such an announcement, your work based on

the Program is not required to print an announcement.)

These requirements apply to the modified work as a whole. If identifiable sections of that work are not derived from the Program, and can be reasonably considered independent and separate works in themselves, then this License, and its terms, do not apply to those sections when you distribute them as separate works. But when you distribute the same sections as part of a whole which is a work based on the Program, the distribution of the whole must be on the terms of this License, whose permissions for other licensees extend to the entire whole, and thus to each and every part regardless of who wrote it.

Thus, it is not the intent of this section to claim rights or contest your rights to work written entirely by you; rather, the intent is to exercise the right to control the distribution of derivative or collective works based on the Program.

In addition, mere aggregation of another work not based on the Program with the Program (or with a work based on the Program) on a volume of a storage or distribution medium does not bring the other work under the scope of this License.

3. You may copy and distribute the Program (or a work based on it, under Section 2) in object code or executable form under the terms of Sections 1 and 2 above provided that you also do one of the following:

a) Accompany it with the complete corresponding machine-readable source code, which must be distributed under the terms of Sections 1 and 2 above on a medium customarily used for software interchange; or,

b) Accompany it with a written offer, valid for at least three years, to give any third party, for a charge no more than your cost of physically performing source distribution, a complete machine-readable copy of the corresponding source code, to be distributed under the terms of Sections 1 and 2 above on a medium customarily used for software interchange; or,

c) Accompany it with the information you received as to the offer

to distribute corresponding source code. (This alternative is allowed only for noncommercial distribution and only if you received the program in object code or executable form with such an offer, in accord with Subsection b above.)

The source code for a work means the preferred form of the work for making modifications to it. For an executable work, complete source code means all the source code for all modules it contains, plus any associated interface definition files, plus the scripts used to control compilation and installation of the executable. However, as a special exception, the source code distributed need not include anything that is normally distributed (in either source or binary form) with the major components (compiler, kernel, and so on) of the operating system on which the executable runs, unless that component itself accompanies the executable.

If distribution of executable or object code is made by offering access to copy from a designated place, then offering equivalent access to copy the source code from the same place counts as distribution of the source code, even though third parties are not compelled to copy the source along with the object code.

4. You may not copy, modify, sublicense, or distribute the Program except as expressly provided under this License. Any attempt otherwise to copy, modify, sublicense or distribute the Program is void, and will automatically terminate your rights under this License. However, parties who have received copies, or rights, from you under this License will not have their licenses terminated so long as such parties remain in full compliance.

5. You are not required to accept this License, since you have not signed it. However, nothing else grants you permission to modify or distribute the Program or its derivative works. These actions are prohibited by law if you do not accept this License. Therefore, by modifying or distributing the Program (or any work based on the Program), you indicate your acceptance of this License to do so, and all its terms and conditions for copying, distributing or modifying the Program or works based on it.

6. Each time you redistribute the Program (or any work based on the Program), the recipient automatically receives a license from the original licensor to copy, distribute or modify the Program subject to these terms and conditions. You may not impose any further restrictions on the recipients' exercise of the rights granted herein. You are not responsible for enforcing compliance by third parties to this License.

7. If, as a consequence of a court judgment or allegation of patent infringement or for any other reason (not limited to patent issues), conditions are imposed on you (whether by court order, agreement or otherwise) that contradict the conditions of this License, they do not excuse you from the conditions of this License. If you cannot distribute so as to satisfy simultaneously your obligations under this License and any other pertinent obligations, then as a consequence you may not distribute the Program at all. For example, if a patent license would not permit royalty-free redistribution of the Program by all those who receive copies directly or indirectly through you, then the only way you could satisfy both it and this License would be to refrain entirely from distribution of the Program.

If any portion of this section is held invalid or unenforceable under any particular circumstance, the balance of the section is intended to apply and the section as a whole is intended to apply in other circumstances.

It is not the purpose of this section to induce you to infringe any patents or other property right claims or to contest validity of any such claims; this section has the sole purpose of protecting the integrity of the free software distribution system, which is implemented by public license practices. Many people have made generous contributions to the wide range of software distributed through that system in reliance on consistent application of that system; it is up to the author/donor to decide if he or she is willing to distribute software through any other system and a licensee cannot impose that choice.

This section is intended to make thoroughly clear what is believed to be a consequence of the rest of this License.

8. If the distribution and/or use of the Program is restricted in certain countries either by patents or by copyrighted interfaces, the original copyright holder who places the Program under this License may add an explicit geographical distribution limitation excluding those countries, so that distribution is permitted only in or among countries not thus excluded. In such case, this License incorporates the limitation as if written in the body of this License.

9. The Free Software Foundation may publish revised and/or new versions of the General Public License from time to time. Such new versions will be similar in spirit to the present version, but may differ in detail to address new problems or concerns.

Each version is given a distinguishing version number. If the Program specifies a version number of this License which applies to it and "any later version", you have the option of following the terms and conditions either of that version or of any later version published by the Free Software Foundation. If the Program does not specify a version number of this License, you may choose any version ever published by the Free Software Foundation.

10. If you wish to incorporate parts of the Program into other free programs whose distribution conditions are different, write to the author to ask for permission. For software which is copyrighted by the Free Software Foundation, write to the Free Software Foundation; we sometimes make exceptions for this. Our decision will be guided by the two goals of preserving the free status of all derivatives of our free software and of promoting the sharing and reuse of software generally.

NO WARRANTY

11. BECAUSE THE PROGRAM IS LICENSED FREE OF CHARGE, THERE IS NO WARRANTY FOR THE PROGRAM, TO THE EXTENT PERMITTED BY APPLICABLE LAW. EXCEPT WHEN OTHERWISE STATED IN WRITING THE COPYRIGHT HOLDERS AND/OR OTHER PARTIES PROVIDE THE PROGRAM "AS IS" WITHOUT WARRANTY OF ANY KIND, EITHER EXPRESSED

OR IMPLIED, INCLUDING, BUT NOT LIMITED TO, THE IMPLIED WARRANTIES OF MERCHANTABILITY AND FITNESS FOR A PARTICULAR PURPOSE. THE ENTIRE RISK AS TO THE QUALITY AND PERFORMANCE OF THE PROGRAM IS WITH YOU. SHOULD THE PROGRAM PROVE DEFECTIVE, YOU ASSUME THE COST OF ALL NECESSARY SERVICING, REPAIR OR CORRECTION.

12. IN NO EVENT UNLESS REQUIRED BY APPLICABLE LAW OR AGREED TO IN WRITING WILL ANY COPYRIGHT HOLDER, OR ANY OTHER PARTY WHO MAY MODIFY AND/OR REDISTRIBUTE THE PROGRAM AS PERMITTED ABOVE, BE LIABLE TO YOU FOR DAMAGES, INCLUDING ANY GENERAL, SPECIAL, INCIDENTAL OR CONSEQUENTIAL DAMAGES ARISING OUT OF THE USE OR INABILITY TO USE THE PROGRAM (INCLUDING BUT NOT LIMITED TO LOSS OF DATA OR DATA BEING RENDERED INACCURATE OR LOSSES SUSTAINED BY YOU OR THIRD PARTIES OR A FAILURE OF THE PROGRAM TO OPERATE WITH ANY OTHER PROGRAMS), EVEN IF SUCH HOLDER OR OTHER PARTY HAS BEEN ADVISED OF THE POSSIBILITY OF SUCH DAMAGES.

END OF TERMS AND CONDITIONS

Appendix: How to Apply These Terms to Your New Programs

If you develop a new program, and you want it to be of the greatest possible use to the public, the best way to achieve this is to make it free software which everyone can redistribute and change under these terms.

To do so, attach the following notices to the program. It is safest to attach them to the start of each source file to most effectively convey the exclusion of warranty; and each file should have at least the "copyright" line and a pointer to where the full notice is found.

<one line to give the program's name and a brief idea of what it does.>
Copyright (C) 19yy <name of author>

This program is free software; you can redistribute it and/or modify it under the terms of the GNU General Public License as published by the Free Software Foundation; either version 2 of the License, or (at your option) any later version.

This program is distributed in the hope that it will be useful,

but WITHOUT ANY WARRANTY; without even the implied warranty of MERCHANTABILITY or FITNESS FOR A PARTICULAR PURPOSE. See the GNU General Public License for more details.

You should have received a copy of the GNU General Public License along with this program; if not, write to the Free Software Foundation, Inc., 59 Temple Place, Suite 330, Boston, MA 02111, USA.

Also add information on how to contact you by electronic and paper mail.

If the program is interactive, make it output a short notice like this when it starts in an interactive mode:

```
Gnomovision version 69, Copyright (C) 19yy name of author
Gnomovision comes with ABSOLUTELY NO WARRANTY; for details type `show w'.
This is free software, and you are welcome to redistribute it
under certain conditions; type `show c' for details.
```

The hypothetical commands ``show w'` and ``show c'` should show the appropriate parts of the General Public License. Of course, the commands you use may be called something other than ``show w'` and ``show c'`; they could even be mouse-clicks or menu items--whatever suits your program.

You should also get your employer (if you work as a programmer) or your school, if any, to sign a "copyright disclaimer" for the program, if necessary. Here is a sample; alter the names:

```
Yoyodyne, Inc., hereby disclaims all copyright interest in the program
`Gnomovision' (which makes passes at compilers) written by James Hacker.
```

```
<signature of Ty Coon>, 1 April 1989
Ty Coon, President of Vice
```

This General Public License does not permit incorporating your program into proprietary programs. If your program is a subroutine library, you may consider it more useful to permit linking proprietary applications with the library. If this is what you want to do, use the GNU Library General Public License instead of this License.

////////////////////////////////////

GNU LESSER GENERAL PUBLIC LICENSE

Version 2.1, February 1999

Copyright (C) 1991, 1999 Free Software Foundation, Inc.
51 Franklin Street, Fifth Floor, Boston, MA 02110-1301 USA
Everyone is permitted to copy and distribute verbatim copies
of this license document, but changing it is not allowed.

[This is the first released version of the Lesser GPL. It also counts
as the successor of the GNU Library Public License, version 2, hence
the version number 2.1.]

Preamble

The licenses for most software are designed to take away your
freedom to share and change it. By contrast, the GNU General Public
Licenses are intended to guarantee your freedom to share and change
free software--to make sure the software is free for all its users.

This license, the Lesser General Public License, applies to some
specially designated software packages--typically libraries--of the
Free Software Foundation and other authors who decide to use it. You
can use it too, but we suggest you first think carefully about whether
this license or the ordinary General Public License is the better
strategy to use in any particular case, based on the explanations below.

When we speak of free software, we are referring to freedom of use,
not price. Our General Public Licenses are designed to make sure that
you have the freedom to distribute copies of free software (and charge
for this service if you wish); that you receive source code or can get
it if you want it; that you can change the software and use pieces of
it in new free programs; and that you are informed that you can do
these things.

To protect your rights, we need to make restrictions that forbid

distributors to deny you these rights or to ask you to surrender these rights. These restrictions translate to certain responsibilities for you if you distribute copies of the library or if you modify it.

For example, if you distribute copies of the library, whether gratis or for a fee, you must give the recipients all the rights that we gave you. You must make sure that they, too, receive or can get the source code. If you link other code with the library, you must provide complete object files to the recipients, so that they can relink them with the library after making changes to the library and recompiling it. And you must show them these terms so they know their rights.

We protect your rights with a two-step method: (1) we copyright the library, and (2) we offer you this license, which gives you legal permission to copy, distribute and/or modify the library.

To protect each distributor, we want to make it very clear that there is no warranty for the free library. Also, if the library is modified by someone else and passed on, the recipients should know that what they have is not the original version, so that the original author's reputation will not be affected by problems that might be introduced by others.

Finally, software patents pose a constant threat to the existence of any free program. We wish to make sure that a company cannot effectively restrict the users of a free program by obtaining a restrictive license from a patent holder. Therefore, we insist that any patent license obtained for a version of the library must be consistent with the full freedom of use specified in this license.

Most GNU software, including some libraries, is covered by the ordinary GNU General Public License. This license, the GNU Lesser General Public License, applies to certain designated libraries, and is quite different from the ordinary General Public License. We use this license for certain libraries in order to permit linking those libraries into non-free programs.

When a program is linked with a library, whether statically or using

a shared library, the combination of the two is legally speaking a combined work, a derivative of the original library. The ordinary General Public License therefore permits such linking only if the entire combination fits its criteria of freedom. The Lesser General Public License permits more lax criteria for linking other code with the library.

We call this license the "Lesser" General Public License because it does Less to protect the user's freedom than the ordinary General Public License. It also provides other free software developers Less of an advantage over competing non-free programs. These disadvantages are the reason we use the ordinary General Public License for many libraries. However, the Lesser license provides advantages in certain special circumstances.

For example, on rare occasions, there may be a special need to encourage the widest possible use of a certain library, so that it becomes a de-facto standard. To achieve this, non-free programs must be allowed to use the library. A more frequent case is that a free library does the same job as widely used non-free libraries. In this case, there is little to gain by limiting the free library to free software only, so we use the Lesser General Public License.

In other cases, permission to use a particular library in non-free programs enables a greater number of people to use a large body of free software. For example, permission to use the GNU C Library in non-free programs enables many more people to use the whole GNU operating system, as well as its variant, the GNU/Linux operating system.

Although the Lesser General Public License is Less protective of the users' freedom, it does ensure that the user of a program that is linked with the Library has the freedom and the wherewithal to run that program using a modified version of the Library.

The precise terms and conditions for copying, distribution and modification follow. Pay close attention to the difference between a "work based on the library" and a "work that uses the library". The

former contains code derived from the library, whereas the latter must be combined with the library in order to run.

GNU LESSER GENERAL PUBLIC LICENSE

TERMS AND CONDITIONS FOR COPYING, DISTRIBUTION AND MODIFICATION

0. This License Agreement applies to any software library or other program which contains a notice placed by the copyright holder or other authorized party saying it may be distributed under the terms of this Lesser General Public License (also called "this License"). Each licensee is addressed as "you".

A "library" means a collection of software functions and/or data prepared so as to be conveniently linked with application programs (which use some of those functions and data) to form executables.

The "Library", below, refers to any such software library or work which has been distributed under these terms. A "work based on the Library" means either the Library or any derivative work under copyright law: that is to say, a work containing the Library or a portion of it, either verbatim or with modifications and/or translated straightforwardly into another language. (Hereinafter, translation is included without limitation in the term "modification".)

"Source code" for a work means the preferred form of the work for making modifications to it. For a library, complete source code means all the source code for all modules it contains, plus any associated interface definition files, plus the scripts used to control compilation and installation of the library.

Activities other than copying, distribution and modification are not covered by this License; they are outside its scope. The act of running a program using the Library is not restricted, and output from such a program is covered only if its contents constitute a work based on the Library (independent of the use of the Library in a tool for writing it). Whether that is true depends on what the Library does and what the program that uses the Library does.

1. You may copy and distribute verbatim copies of the Library's complete source code as you receive it, in any medium, provided that you conspicuously and appropriately publish on each copy an appropriate copyright notice and disclaimer of warranty; keep intact all the notices that refer to this License and to the absence of any warranty; and distribute a copy of this License along with the Library.

You may charge a fee for the physical act of transferring a copy, and you may at your option offer warranty protection in exchange for a fee.

2. You may modify your copy or copies of the Library or any portion of it, thus forming a work based on the Library, and copy and distribute such modifications or work under the terms of Section 1 above, provided that you also meet all of these conditions:

a) The modified work must itself be a software library.

b) You must cause the files modified to carry prominent notices stating that you changed the files and the date of any change.

c) You must cause the whole of the work to be licensed at no charge to all third parties under the terms of this License.

d) If a facility in the modified Library refers to a function or a table of data to be supplied by an application program that uses the facility, other than as an argument passed when the facility is invoked, then you must make a good faith effort to ensure that, in the event an application does not supply such function or table, the facility still operates, and performs whatever part of its purpose remains meaningful.

(For example, a function in a library to compute square roots has a purpose that is entirely well-defined independent of the application. Therefore, Subsection 2d requires that any application-supplied function or table used by this function must be optional: if the application does not supply it, the square

root function must still compute square roots.)

These requirements apply to the modified work as a whole. If identifiable sections of that work are not derived from the Library, and can be reasonably considered independent and separate works in themselves, then this License, and its terms, do not apply to those sections when you distribute them as separate works. But when you distribute the same sections as part of a whole which is a work based on the Library, the distribution of the whole must be on the terms of this License, whose permissions for other licensees extend to the entire whole, and thus to each and every part regardless of who wrote it.

Thus, it is not the intent of this section to claim rights or contest your rights to work written entirely by you; rather, the intent is to exercise the right to control the distribution of derivative or collective works based on the Library.

In addition, mere aggregation of another work not based on the Library with the Library (or with a work based on the Library) on a volume of a storage or distribution medium does not bring the other work under the scope of this License.

3. You may opt to apply the terms of the ordinary GNU General Public License instead of this License to a given copy of the Library. To do this, you must alter all the notices that refer to this License, so that they refer to the ordinary GNU General Public License, version 2, instead of to this License. (If a newer version than version 2 of the ordinary GNU General Public License has appeared, then you can specify that version instead if you wish.) Do not make any other change in these notices.

Once this change is made in a given copy, it is irreversible for that copy, so the ordinary GNU General Public License applies to all subsequent copies and derivative works made from that copy.

This option is useful when you wish to copy part of the code of the Library into a program that is not a library.

4. You may copy and distribute the Library (or a portion or derivative of it, under Section 2) in object code or executable form under the terms of Sections 1 and 2 above provided that you accompany it with the complete corresponding machine-readable source code, which must be distributed under the terms of Sections 1 and 2 above on a medium customarily used for software interchange.

If distribution of object code is made by offering access to copy from a designated place, then offering equivalent access to copy the source code from the same place satisfies the requirement to distribute the source code, even though third parties are not compelled to copy the source along with the object code.

5. A program that contains no derivative of any portion of the Library, but is designed to work with the Library by being compiled or linked with it, is called a "work that uses the Library". Such a work, in isolation, is not a derivative work of the Library, and therefore falls outside the scope of this License.

However, linking a "work that uses the Library" with the Library creates an executable that is a derivative of the Library (because it contains portions of the Library), rather than a "work that uses the library". The executable is therefore covered by this License. Section 6 states terms for distribution of such executables.

When a "work that uses the Library" uses material from a header file that is part of the Library, the object code for the work may be a derivative work of the Library even though the source code is not. Whether this is true is especially significant if the work can be linked without the Library, or if the work is itself a library. The threshold for this to be true is not precisely defined by law.

If such an object file uses only numerical parameters, data structure layouts and accessors, and small macros and small inline functions (ten lines or less in length), then the use of the object file is unrestricted, regardless of whether it is legally a derivative work. (Executables containing this object code plus portions of the

Library will still fall under Section 6.)

Otherwise, if the work is a derivative of the Library, you may distribute the object code for the work under the terms of Section 6. Any executables containing that work also fall under Section 6, whether or not they are linked directly with the Library itself.

6. As an exception to the Sections above, you may also combine or link a "work that uses the Library" with the Library to produce a work containing portions of the Library, and distribute that work under terms of your choice, provided that the terms permit modification of the work for the customer's own use and reverse engineering for debugging such modifications.

You must give prominent notice with each copy of the work that the Library is used in it and that the Library and its use are covered by this License. You must supply a copy of this License. If the work during execution displays copyright notices, you must include the copyright notice for the Library among them, as well as a reference directing the user to the copy of this License. Also, you must do one of these things:

a) Accompany the work with the complete corresponding machine-readable source code for the Library including whatever changes were used in the work (which must be distributed under Sections 1 and 2 above); and, if the work is an executable linked with the Library, with the complete machine-readable "work that uses the Library", as object code and/or source code, so that the user can modify the Library and then relink to produce a modified executable containing the modified Library. (It is understood that the user who changes the contents of definitions files in the Library will not necessarily be able to recompile the application to use the modified definitions.)

b) Use a suitable shared library mechanism for linking with the Library. A suitable mechanism is one that (1) uses at run time a copy of the library already present on the user's computer system, rather than copying library functions into the executable, and (2)

will operate properly with a modified version of the library, if the user installs one, as long as the modified version is interface-compatible with the version that the work was made with.

c) Accompany the work with a written offer, valid for at least three years, to give the same user the materials specified in Subsection 6a, above, for a charge no more than the cost of performing this distribution.

d) If distribution of the work is made by offering access to copy from a designated place, offer equivalent access to copy the above specified materials from the same place.

e) Verify that the user has already received a copy of these materials or that you have already sent this user a copy.

For an executable, the required form of the "work that uses the Library" must include any data and utility programs needed for reproducing the executable from it. However, as a special exception, the materials to be distributed need not include anything that is normally distributed (in either source or binary form) with the major components (compiler, kernel, and so on) of the operating system on which the executable runs, unless that component itself accompanies the executable.

It may happen that this requirement contradicts the license restrictions of other proprietary libraries that do not normally accompany the operating system. Such a contradiction means you cannot use both them and the Library together in an executable that you distribute.

7. You may place library facilities that are a work based on the Library side-by-side in a single library together with other library facilities not covered by this License, and distribute such a combined library, provided that the separate distribution of the work based on the Library and of the other library facilities is otherwise permitted, and provided that you do these two things:

a) Accompany the combined library with a copy of the same work based on the Library, uncombined with any other library facilities. This must be distributed under the terms of the Sections above.

b) Give prominent notice with the combined library of the fact that part of it is a work based on the Library, and explaining where to find the accompanying uncombined form of the same work.

8. You may not copy, modify, sublicense, link with, or distribute the Library except as expressly provided under this License. Any attempt otherwise to copy, modify, sublicense, link with, or distribute the Library is void, and will automatically terminate your rights under this License. However, parties who have received copies, or rights, from you under this License will not have their licenses terminated so long as such parties remain in full compliance.

9. You are not required to accept this License, since you have not signed it. However, nothing else grants you permission to modify or distribute the Library or its derivative works. These actions are prohibited by law if you do not accept this License. Therefore, by modifying or distributing the Library (or any work based on the Library), you indicate your acceptance of this License to do so, and all its terms and conditions for copying, distributing or modifying the Library or works based on it.

10. Each time you redistribute the Library (or any work based on the Library), the recipient automatically receives a license from the original licensor to copy, distribute, link with or modify the Library subject to these terms and conditions. You may not impose any further restrictions on the recipients' exercise of the rights granted herein. You are not responsible for enforcing compliance by third parties with this License.

11. If, as a consequence of a court judgment or allegation of patent infringement or for any other reason (not limited to patent issues), conditions are imposed on you (whether by court order, agreement or otherwise) that contradict the conditions of this License, they do not

excuse you from the conditions of this License. If you cannot distribute so as to satisfy simultaneously your obligations under this License and any other pertinent obligations, then as a consequence you may not distribute the Library at all. For example, if a patent license would not permit royalty-free redistribution of the Library by all those who receive copies directly or indirectly through you, then the only way you could satisfy both it and this License would be to refrain entirely from distribution of the Library.

If any portion of this section is held invalid or unenforceable under any particular circumstance, the balance of the section is intended to apply, and the section as a whole is intended to apply in other circumstances.

It is not the purpose of this section to induce you to infringe any patents or other property right claims or to contest validity of any such claims; this section has the sole purpose of protecting the integrity of the free software distribution system which is implemented by public license practices. Many people have made generous contributions to the wide range of software distributed through that system in reliance on consistent application of that system; it is up to the author/donor to decide if he or she is willing to distribute software through any other system and a licensee cannot impose that choice.

This section is intended to make thoroughly clear what is believed to be a consequence of the rest of this License.

12. If the distribution and/or use of the Library is restricted in certain countries either by patents or by copyrighted interfaces, the original copyright holder who places the Library under this License may add an explicit geographical distribution limitation excluding those countries, so that distribution is permitted only in or among countries not thus excluded. In such case, this License incorporates the limitation as if written in the body of this License.

13. The Free Software Foundation may publish revised and/or new versions of the Lesser General Public License from time to time. Such new versions will be similar in spirit to the present version,

but may differ in detail to address new problems or concerns.

Each version is given a distinguishing version number. If the Library specifies a version number of this License which applies to it and "any later version", you have the option of following the terms and conditions either of that version or of any later version published by the Free Software Foundation. If the Library does not specify a license version number, you may choose any version ever published by the Free Software Foundation.

14. If you wish to incorporate parts of the Library into other free programs whose distribution conditions are incompatible with these, write to the author to ask for permission. For software which is copyrighted by the Free Software Foundation, write to the Free Software Foundation; we sometimes make exceptions for this. Our decision will be guided by the two goals of preserving the free status of all derivatives of our free software and of promoting the sharing and reuse of software generally.

NO WARRANTY

15. BECAUSE THE LIBRARY IS LICENSED FREE OF CHARGE, THERE IS NO WARRANTY FOR THE LIBRARY, TO THE EXTENT PERMITTED BY APPLICABLE LAW. EXCEPT WHEN OTHERWISE STATED IN WRITING THE COPYRIGHT HOLDERS AND/OR OTHER PARTIES PROVIDE THE LIBRARY "AS IS" WITHOUT WARRANTY OF ANY KIND, EITHER EXPRESSED OR IMPLIED, INCLUDING, BUT NOT LIMITED TO, THE IMPLIED WARRANTIES OF MERCHANTABILITY AND FITNESS FOR A PARTICULAR PURPOSE. THE ENTIRE RISK AS TO THE QUALITY AND PERFORMANCE OF THE LIBRARY IS WITH YOU. SHOULD THE LIBRARY PROVE DEFECTIVE, YOU ASSUME THE COST OF ALL NECESSARY SERVICING, REPAIR OR CORRECTION.

16. IN NO EVENT UNLESS REQUIRED BY APPLICABLE LAW OR AGREED TO IN WRITING WILL ANY COPYRIGHT HOLDER, OR ANY OTHER PARTY WHO MAY MODIFY AND/OR REDISTRIBUTE THE LIBRARY AS PERMITTED ABOVE, BE LIABLE TO YOU FOR DAMAGES, INCLUDING ANY GENERAL, SPECIAL, INCIDENTAL OR CONSEQUENTIAL DAMAGES ARISING OUT OF THE USE OR INABILITY TO USE THE LIBRARY (INCLUDING BUT NOT LIMITED TO LOSS OF DATA OR DATA BEING RENDERED INACCURATE OR LOSSES SUSTAINED BY YOU OR THIRD PARTIES OR A

FAILURE OF THE LIBRARY TO OPERATE WITH ANY OTHER SOFTWARE), EVEN IF SUCH HOLDER OR OTHER PARTY HAS BEEN ADVISED OF THE POSSIBILITY OF SUCH DAMAGES.

END OF TERMS AND CONDITIONS

How to Apply These Terms to Your New Libraries

If you develop a new library, and you want it to be of the greatest possible use to the public, we recommend making it free software that everyone can redistribute and change. You can do so by permitting redistribution under these terms (or, alternatively, under the terms of the ordinary General Public License).

To apply these terms, attach the following notices to the library. It is safest to attach them to the start of each source file to most effectively convey the exclusion of warranty; and each file should have at least the "copyright" line and a pointer to where the full notice is found.

<one line to give the library's name and a brief idea of what it does.>

Copyright (C) <year> <name of author>

This library is free software; you can redistribute it and/or modify it under the terms of the GNU Lesser General Public License as published by the Free Software Foundation; either version 2.1 of the License, or (at your option) any later version.

This library is distributed in the hope that it will be useful, but WITHOUT ANY WARRANTY; without even the implied warranty of MERCHANTABILITY or FITNESS FOR A PARTICULAR PURPOSE. See the GNU Lesser General Public License for more details.

You should have received a copy of the GNU Lesser General Public License along with this library; if not, write to the Free Software Foundation, Inc., 51 Franklin Street, Fifth Floor, Boston, MA 02110-1301 USA

Also add information on how to contact you by electronic and paper mail.

You should also get your employer (if you work as a programmer) or your school, if any, to sign a "copyright disclaimer" for the library, if necessary. Here is a sample; alter the names:

Yoyodyne, Inc., hereby disclaims all copyright interest in the library `Frob' (a library for tweaking knobs) written by James Random Hacker.

<signature of Ty Coon>, 1 April 1990
Ty Coon, President of Vice

That's all there is to it!

=====
=====

- * Translation Snippets provided by Squid Project Translators held in
* copyright for open distribution.
*
- * Translation Snippets provided by Rosetta Project Translators held in
* copyright for open distribution.
*
- * Copyright 2009
*
- * Redistribution and use in source and binary forms, with or without
* modification, are permitted provided that the following conditions
* are met:
* 1. Redistributions of source code must retain the above copyright
* notice, this list of conditions and the following disclaimer.
* 2. Redistributions in binary form must reproduce the above copyright
* notice, this list of conditions and the following disclaimer in the
* documentation and/or other materials provided with the distribution.
* 3. Neither the name of the University nor the names of its contributors
* may be used to endorse or promote products derived from this software
* without specific prior written permission.
*
- * THIS SOFTWARE IS PROVIDED BY THE REGENTS AND CONTRIBUTORS ``AS IS" AND
* ANY EXPRESS OR IMPLIED WARRANTIES, INCLUDING, BUT NOT LIMITED TO, THE
* IMPLIED WARRANTIES OF MERCHANTABILITY AND FITNESS FOR A PARTICULAR PURPOSE

* ARE DISCLAIMED. IN NO EVENT SHALL THE REGENTS OR CONTRIBUTORS BE LIABLE
* FOR ANY DIRECT, INDIRECT, INCIDENTAL, SPECIAL, EXEMPLARY, OR CONSEQUENTIAL
* DAMAGES (INCLUDING, BUT NOT LIMITED TO, PROCUREMENT OF SUBSTITUTE GOODS
* OR SERVICES; LOSS OF USE, DATA, OR PROFITS; OR BUSINESS INTERRUPTION)
* HOWEVER CAUSED AND ON ANY THEORY OF LIABILITY, WHETHER IN CONTRACT, STRICT
* LIABILITY, OR TORT (INCLUDING NEGLIGENCE OR OTHERWISE) ARISING IN ANY WAY
* OUT OF THE USE OF THIS SOFTWARE, EVEN IF ADVISED OF THE POSSIBILITY OF
* SUCH DAMAGE.

see TRANSLATORS file for current contributing translators holding copyrights.

* Livingston Enterprises, Inc.
* 6920 Koll Center Parkway
* Pleasanton, CA 94566

*

* Copyright 1992 Livingston Enterprises, Inc.

*

* Permission to use, copy, modify, and distribute this software for any
* purpose and without fee is hereby granted, provided that this
* copyright and permission notice appear on all copies and supporting
* documentation, the name of Livingston Enterprises, Inc. not be used
* in advertising or publicity pertaining to distribution of the
* program without specific prior permission, and notice be given
* in supporting documentation that copying and distribution is by
* permission of Livingston Enterprises, Inc.

*

* Livingston Enterprises, Inc. makes no representations about
* the suitability of this software for any purpose. It is
* provided "as is" without express or implied warranty.

*

* The new parts of the code is Copyright (C) 1998 R.M. van Selm <selm@cistron.nl>

* with modifications

* Copyright (C) 2004 Henrik Nordstrom <hno@squid-cache.org>

* Copyright (C) 2006 Henrik Nordstrom hno@squid-cache.org

=====
=====

Copyright (C) 2004 Henrik Nordstrom

Permission to use, copy, modify, and distribute this software for any purpose and without fee is hereby granted, provided that this copyright and permission notice appear on all copies and supporting documentation, the name of Henrik Nordstrom. not be used in advertising or publicity pertaining to distribution of the program without specific prior permission.

The author makes no representations about the suitability of this documentation for any purpose. It is provided "as is" without express or implied warranty.

Henrik Nordstrom <hno@squid-cache.org>

=====
=====

Copyright 1988, 1989 by Carnegie Mellon University

All Rights Reserved

Permission to use, copy, modify, and distribute this software and its documentation for any purpose and without fee is hereby granted, provided that the above copyright notice appear in all copies and that both that copyright notice and this permission notice appear in supporting documentation, and that the name of CMU not be used in advertising or publicity pertaining to distribution of the software without specific, written prior permission.

CMU DISCLAIMS ALL WARRANTIES WITH REGARD TO THIS SOFTWARE, INCLUDING ALL IMPLIED WARRANTIES OF MERCHANTABILITY AND FITNESS, IN NO EVENT SHALL CMU BE LIABLE FOR ANY SPECIAL, INDIRECT OR CONSEQUENTIAL DAMAGES OR ANY DAMAGES WHATSOEVER RESULTING FROM LOSS OF USE, DATA OR PROFITS, WHETHER IN AN ACTION OF CONTRACT, NEGLIGENCE OR OTHER TORTIOUS ACTION, ARISING OUT OF OR IN CONNECTION WITH THE USE OR PERFORMANCE OF THIS SOFTWARE.

* Copyright 1997 by Carnegie Mellon University

*

* All Rights Reserved

*

* Permission to use, copy, modify, and distribute this software and its
* documentation for any purpose and without fee is hereby granted,
* provided that the above copyright notice appear in all copies and that
* both that copyright notice and this permission notice appear in
* supporting documentation, and that the name of CMU not be
* used in advertising or publicity pertaining to distribution of the
* software without specific, written prior permission.

*

* CMU DISCLAIMS ALL WARRANTIES WITH REGARD TO THIS SOFTWARE, INCLUDING
* ALL IMPLIED WARRANTIES OF MERCHANTABILITY AND FITNESS, IN NO EVENT SHALL
* CMU BE LIABLE FOR ANY SPECIAL, INDIRECT OR CONSEQUENTIAL DAMAGES OR
* ANY DAMAGES WHATSOEVER RESULTING FROM LOSS OF USE, DATA OR PROFITS,
* WHETHER IN AN ACTION OF CONTRACT, NEGLIGENCE OR OTHER TORTIOUS ACTION,
* ARISING OUT OF OR IN CONNECTION WITH THE USE OR PERFORMANCE OF THIS
* SOFTWARE.

*

* Author: Ryan Troll ryan+@andrew.cmu.edu

// Author: Jens-S. Voেকler <voeckler@rvs.uni-hannover.de>

// (c) 1997 Lehrgebiet Rechnernetze und Verteilte Systeme

// Universit?t Hannover, Germany

//

// Permission to use, copy, modify, distribute, and sell this software
// and its documentation for any purpose is hereby granted without fee,
// provided that (i) the above copyright notices and this permission
// notice appear in all copies of the software and related documentation,
// and (ii) the names of the Lehrgebiet Rechnernetze und Verteilte
// Systeme and the University of Hannover may not be used in any
// advertising or publicity relating to the software without the
// specific, prior written permission of Lehrgebiet Rechnernetze und
// Verteilte Systeme and the University of Hannover.

//

// THE SOFTWARE IS PROVIDED "AS-IS" AND WITHOUT WARRANTY OF ANY KIND,
// EXPRESS, IMPLIED OR OTHERWISE, INCLUDING WITHOUT LIMITATION, ANY

// WARRANTY OF MERCHANTABILITY OR FITNESS FOR A PARTICULAR PURPOSE.

//

// IN NO EVENT SHALL THE LEHRGEBIET RECHNERNETZE UND VERTEILTE SYSTEME OR

// THE UNIVERSITY OF HANNOVER BE LIABLE FOR ANY SPECIAL, INCIDENTAL,

// INDIRECT OR CONSEQUENTIAL DAMAGES OF ANY KIND, OR ANY DAMAGES

// WHATSOEVER RESULTING FROM LOSS OF USE, DATA OR PROFITS, WHETHER OR NOT

// ADVISED OF THE POSSIBILITY OF DAMAGE, AND ON ANY THEORY OF LIABILITY,

// ARISING OUT OF OR IN CONNECTION WITH THE USE OR PERFORMANCE OF THIS

// SOFTWARE.

=====

// (c) 1997 - 2000 Lehrgebiet Rechnernetze und Verteilte Systeme

// Universität Hannover, Germany

//

// Permission to use, copy, modify, distribute, and sell this software

// and its documentation for any purpose is hereby granted without fee,

// provided that (i) the above copyright notices and this permission

// notice appear in all copies of the software and related documentation,

// and (ii) the names of the Lehrgebiet Rechnernetze und Verteilte

// Systeme and the University of Hannover may not be used in any

// advertising or publicity relating to the software without the

// specific, prior written permission of Lehrgebiet Rechnernetze und

// Verteilte Systeme and the University of Hannover.

//

// THE SOFTWARE IS PROVIDED "AS-IS" AND WITHOUT WARRANTY OF ANY KIND,

// EXPRESS, IMPLIED OR OTHERWISE, INCLUDING WITHOUT LIMITATION, ANY

// WARRANTY OF MERCHANTABILITY OR FITNESS FOR A PARTICULAR PURPOSE.

//

// IN NO EVENT SHALL THE LEHRGEBIET RECHNERNETZE UND VERTEILTE SYSTEME OR

// THE UNIVERSITY OF HANNOVER BE LIABLE FOR ANY SPECIAL, INCIDENTAL,

// INDIRECT OR CONSEQUENTIAL DAMAGES OF ANY KIND, OR ANY DAMAGES

// WHATSOEVER RESULTING FROM LOSS OF USE, DATA OR PROFITS, WHETHER OR NOT

// ADVISED OF THE POSSIBILITY OF DAMAGE, AND ON ANY THEORY OF LIABILITY,

// ARISING OUT OF OR IN CONNECTION WITH THE USE OR PERFORMANCE OF THIS

// SOFTWARE.

```
// Author: Jens-S. Voেকler <voeckler@rvs.uni-hannover.de>
//
// File: socket.hh
// Sun May 3 1998
//
// (c) 1998 Lehrgebiet Rechnernetze und Verteilte Systeme
// Universit?t Hannover, Germany
//
// Books: W. Richard Steven, "Advanced Programming in the UNIX Environment",
// Addison-Wesley, 1992.
//
// Permission to use, copy, modify, distribute, and sell this software
// and its documentation for any purpose is hereby granted without fee,
// provided that (i) the above copyright notices and this permission
// notice appear in all copies of the software and related documentation,
// and (ii) the names of the Lehrgebiet Rechnernetze und Verteilte
// Systeme and the University of Hannover may not be used in any
// advertising or publicity relating to the software without the
// specific, prior written permission of Lehrgebiet Rechnernetze und
// Verteilte Systeme and the University of Hannover.
//
// THE SOFTWARE IS PROVIDED "AS-IS" AND WITHOUT WARRANTY OF ANY KIND,
// EXPRESS, IMPLIED OR OTHERWISE, INCLUDING WITHOUT LIMITATION, ANY
// WARRANTY OF MERCHANTABILITY OR FITNESS FOR A PARTICULAR PURPOSE.
//
// IN NO EVENT SHALL THE LEHRGEBIET RECHNERNETZE UND VERTEILTE SYSTEME OR
// THE UNIVERSITY OF HANNOVER BE LIABLE FOR ANY SPECIAL, INCIDENTAL,
// INDIRECT OR CONSEQUENTIAL DAMAGES OF ANY KIND, OR ANY DAMAGES
// WHATSOEVER RESULTING FROM LOSS OF USE, DATA OR PROFITS, WHETHER OR NOT
// ADVISED OF THE POSSIBILITY OF DAMAGE, AND ON ANY THEORY OF LIABILITY,
// ARISING OUT OF OR IN CONNECTION WITH THE USE OR PERFORMANCE OF THIS
// SOFTWARE.
//
// Revision 1.3 1999/01/19 11:00:50 voeckler
// Linux glibc2 fixes for socket size parameters.
//
```

```
// Revision 1.2 1998/08/27 15:23:39 voeckler
// added TCP_NODELAY options at several places.
//
// Revision 1.1 1998/08/13 21:52:55 voeckler
// Initial revision

// Author: Jens-S. Voeckler <voeckler@rvs.uni-hannover.de>
//
// File: squid-tlv.cc
// Tue Jun 15 1999
//
// (c) 1999 Lehrgebiet Rechnernetze und Verteilte Systeme
// Universit?t Hannover, Germany
//
// Permission to use, copy, modify, distribute, and sell this software
// and its documentation for any purpose is hereby granted without fee,
// provided that (i) the above copyright notices and this permission
// notice appear in all copies of the software and related documentation,
// and (ii) the names of the Lehrgebiet Rechnernetze und Verteilte
// Systeme and the University of Hannover may not be used in any
// advertising or publicity relating to the software without the
// specific, prior written permission of Lehrgebiet Rechnernetze und
// Verteilte Systeme and the University of Hannover.
//
// THE SOFTWARE IS PROVIDED "AS-IS" AND WITHOUT WARRANTY OF ANY KIND,
// EXPRESS, IMPLIED OR OTHERWISE, INCLUDING WITHOUT LIMITATION, ANY
// WARRANTY OF MERCHANTABILITY OR FITNESS FOR A PARTICULAR PURPOSE.
//
// IN NO EVENT SHALL THE LEHRGEBIET RECHNERNETZE UND VERTEILTE SYSTEME OR
// THE UNIVERSITY OF HANNOVER BE LIABLE FOR ANY SPECIAL, INCIDENTAL,
// INDIRECT OR CONSEQUENTIAL DAMAGES OF ANY KIND, OR ANY DAMAGES
// WHATSOEVER RESULTING FROM LOSS OF USE, DATA OR PROFITS, WHETHER OR NOT
// ADVISED OF THE POSSIBILITY OF DAMAGE, AND ON ANY THEORY OF LIABILITY,
// ARISING OUT OF OR IN CONNECTION WITH THE USE OR PERFORMANCE OF THIS
// SOFTWARE.
//
// Revision 1.1 1999/06/15 21:10:16 voeckler
// Initial revision
```

```
//  
  
// Author: Jens-S. Voেকler <voeckler@rvs.uni-hannover.de>  
//  
// File: conffile.cc  
// Fri Sep 15 2000  
//  
// (c) 2000 Lehrgebiet Rechnernetze und Verteilte Systeme  
// Universit?t Hannover, Germany  
//  
// Permission to use, copy, modify, distribute, and sell this software  
// and its documentation for any purpose is hereby granted without fee,  
// provided that (i) the above copyright notices and this permission  
// notice appear in all copies of the software and related documentation,  
// and (ii) the names of the Lehrgebiet Rechnernetze und Verteilte  
// Systeme and the University of Hannover may not be used in any  
// advertising or publicity relating to the software without the  
// specific, prior written permission of Lehrgebiet Rechnernetze und  
// Verteilte Systeme and the University of Hannover.  
//  
// THE SOFTWARE IS PROVIDED "AS-IS" AND WITHOUT WARRANTY OF ANY KIND,  
// EXPRESS, IMPLIED OR OTHERWISE, INCLUDING WITHOUT LIMITATION, ANY  
// WARRANTY OF MERCHANTABILITY OR FITNESS FOR A PARTICULAR PURPOSE.  
//  
// IN NO EVENT SHALL THE LEHRGEBIET RECHNERNETZE UND VERTEILTE SYSTEME OR  
// THE UNIVERSITY OF HANNOVER BE LIABLE FOR ANY SPECIAL, INCIDENTAL,  
// INDIRECT OR CONSEQUENTIAL DAMAGES OF ANY KIND, OR ANY DAMAGES  
// WHATSOEVER RESULTING FROM LOSS OF USE, DATA OR PROFITS, WHETHER OR NOT  
// ADVISED OF THE POSSIBILITY OF DAMAGE, AND ON ANY THEORY OF LIABILITY,  
// ARISING OUT OF OR IN CONNECTION WITH THE USE OR PERFORMANCE OF THIS  
// SOFTWARE.  
//  
// Revision 1.1 2000/09/21 09:44:53 voeckler  
// Initial revision  
  
// Author: Jens-S. Voেকler <voeckler@rvs.uni-hannover.de>  
//  
// File: convert.hh
```

```
// Thu Oct 30 1997
//
// (c) 1997 Lehrgebiet Rechnernetze und Verteilte Systeme
// Universit?t Hannover, Germany
//
// Permission to use, copy, modify, distribute, and sell this software
// and its documentation for any purpose is hereby granted without fee,
// provided that (i) the above copyright notices and this permission
// notice appear in all copies of the software and related documentation,
// and (ii) the names of the Lehrgebiet Rechnernetze und Verteilte
// Systeme and the University of Hannover may not be used in any
// advertising or publicity relating to the software without the
// specific, prior written permission of Lehrgebiet Rechnernetze und
// Verteilte Systeme and the University of Hannover.
//
// THE SOFTWARE IS PROVIDED "AS-IS" AND WITHOUT WARRANTY OF ANY KIND,
// EXPRESS, IMPLIED OR OTHERWISE, INCLUDING WITHOUT LIMITATION, ANY
// WARRANTY OF MERCHANTABILITY OR FITNESS FOR A PARTICULAR PURPOSE.
//
// IN NO EVENT SHALL THE LEHRGEBIET RECHNERNETZE UND VERTEILTE SYSTEME OR
// THE UNIVERSITY OF HANNOVER BE LIABLE FOR ANY SPECIAL, INCIDENTAL,
// INDIRECT OR CONSEQUENTIAL DAMAGES OF ANY KIND, OR ANY DAMAGES
// WHATSOEVER RESULTING FROM LOSS OF USE, DATA OR PROFITS, WHETHER OR NOT
// ADVISED OF THE POSSIBILITY OF DAMAGE, AND ON ANY THEORY OF LIABILITY,
// ARISING OUT OF OR IN CONNECTION WITH THE USE OR PERFORMANCE OF THIS
// SOFTWARE.
//
// Revision 1.2 1999/01/19 11:00:50 voeckler
// added bool type workaround.
//
// Revision 1.1 1998/08/13 21:38:04 voeckler
// Initial revision

// Author: Jens-S. V?ckler <voeckler@rvs.uni-hannover.de>
//
// File: copyout.cc
// Tue Jun 15 1999
//
```

```
// (c) 1999 Lehrgebiet Rechnernetze und Verteilte Systeme
// Universit?t Hannover, Germany
//
// Permission to use, copy, modify, distribute, and sell this software
// and its documentation for any purpose is hereby granted without fee,
// provided that (i) the above copyright notices and this permission
// notice appear in all copies of the software and related documentation,
// and (ii) the names of the Lehrgebiet Rechnernetze und Verteilte
// Systeme and the University of Hannover may not be used in any
// advertising or publicity relating to the software without the
// specific, prior written permission of Lehrgebiet Rechnernetze und
// Verteilte Systeme and the University of Hannover.
//
// THE SOFTWARE IS PROVIDED "AS-IS" AND WITHOUT WARRANTY OF ANY KIND,
// EXPRESS, IMPLIED OR OTHERWISE, INCLUDING WITHOUT LIMITATION, ANY
// WARRANTY OF MERCHANTABILITY OR FITNESS FOR A PARTICULAR PURPOSE.
//
// IN NO EVENT SHALL THE LEHRGEBIET RECHNERNETZE UND VERTEILTE SYSTEME OR
// THE UNIVERSITY OF HANNOVER BE LIABLE FOR ANY SPECIAL, INCIDENTAL,
// INDIRECT OR CONSEQUENTIAL DAMAGES OF ANY KIND, OR ANY DAMAGES
// WHATSOEVER RESULTING FROM LOSS OF USE, DATA OR PROFITS, WHETHER OR NOT
// ADVISED OF THE POSSIBILITY OF DAMAGE, AND ON ANY THEORY OF LIABILITY,
// ARISING OUT OF OR IN CONNECTION WITH THE USE OR PERFORMANCE OF THIS
// SOFTWARE.
//
// Revision 1.2 1999/06/16 13:05:26 voeckler
// mmap file copying on Solaris.
//
// Revision 1.1 1999/06/15 21:10:47 voeckler
// Initial revision
```

```
* Copyright (c) 2009–2014, Treehouse Networks Ltd. New Zealand
* All rights reserved.
*
* Redistribution and use in source and binary forms, with or without
* modification, are permitted provided that the following conditions
* are met:
*
```

* 1. Redistributions of source code must retain the above copyright
* notice, this list of conditions and the following disclaimer.

*

* 2. Redistributions in binary form must reproduce the above copyright
* notice, this list of conditions and the following disclaimer in the
* documentation and/or other materials provided with the distribution.

*

* THIS SOFTWARE IS PROVIDED BY THE COPYRIGHT HOLDERS AND CONTRIBUTORS
* "AS IS" AND ANY EXPRESS OR IMPLIED WARRANTIES, INCLUDING, BUT NOT
* LIMITED TO, THE IMPLIED WARRANTIES OF MERCHANTABILITY AND FITNESS
* FOR A PARTICULAR PURPOSE ARE DISCLAIMED. IN NO EVENT SHALL THE
* COPYRIGHT HOLDER OR CONTRIBUTORS BE LIABLE FOR ANY DIRECT, INDIRECT,
* INCIDENTAL, SPECIAL, EXEMPLARY, OR CONSEQUENTIAL DAMAGES (INCLUDING,
* BUT NOT LIMITED TO, PROCUREMENT OF SUBSTITUTE GOODS OR SERVICES;
* LOSS OF USE, DATA, OR PROFITS; OR BUSINESS INTERRUPTION) HOWEVER
* CAUSED AND ON ANY THEORY OF LIABILITY, WHETHER IN CONTRACT, STRICT
* LIABILITY, OR TORT (INCLUDING NEGLIGENCE OR OTHERWISE) ARISING IN
* ANY WAY OUT OF THE USE OF THIS SOFTWARE, EVEN IF ADVISED OF THE
* POSSIBILITY OF SUCH DAMAGE.

* Copyright 2004 The Aerospace Corporation. All rights reserved.

*

* Redistribution and use in source and binary forms, with or without
* modification, are permitted provided that the following conditions
* are met:

*

* 1. Redistributions of source code must retain the above copyright
* notice, this list of conditions, and the following disclaimer.

* 2. Redistributions in binary form must reproduce the above copyright
* notice, this list of conditions, and the following disclaimer in the
* documentation and/or other materials provided with the distribution.

* 3. The name of The Aerospace Corporation may not be used to endorse or
* promote products derived from this software.

*

* THIS SOFTWARE IS PROVIDED BY THE AEROSPACE CORPORATION "AS IS" AND
* ANY EXPRESS OR IMPLIED WARRANTIES, INCLUDING, BUT NOT LIMITED TO, THE
* IMPLIED WARRANTIES OF MERCHANTABILITY AND FITNESS FOR A PARTICULAR PURPOSE
* ARE DISCLAIMED. IN NO EVENT SHALL THE AEROSPACE CORPORATION BE LIABLE

* FOR ANY DIRECT, INDIRECT, INCIDENTAL, SPECIAL, EXEMPLARY, OR CONSEQUENTIAL
* DAMAGES (INCLUDING, BUT NOT LIMITED TO, PROCUREMENT OF SUBSTITUTE GOODS
* OR SERVICES; LOSS OF USE, DATA, OR PROFITS; OR BUSINESS INTERRUPTION)
* HOWEVER CAUSED AND ON ANY THEORY OF LIABILITY, WHETHER IN CONTRACT, STRICT
* LIABILITY, OR TORT (INCLUDING NEGLIGENCE OR OTHERWISE) ARISING IN ANY WAY
* OUT OF THE USE OF THIS SOFTWARE, EVEN IF ADVISED OF THE POSSIBILITY OF
* SUCH DAMAGE.

*

* Copyright (c) 1995

* Bill Paul <wpaul@ctr.columbia.edu>. All rights reserved.

*

* Redistribution and use in source and binary forms, with or without
* modification, are permitted provided that the following conditions
* are met:

* 1. Redistributions of source code must retain the above copyright
* notice, this list of conditions and the following disclaimer.

* 2. Redistributions in binary form must reproduce the above copyright
* notice, this list of conditions and the following disclaimer in the
* documentation and/or other materials provided with the distribution.

* 3. All advertising materials mentioning features or use of this software
* must display the following acknowledgement:

* This product includes software developed by Bill Paul.

* 4. Neither the name of the author nor the names of any co-contributors
* may be used to endorse or promote products derived from this software
* without specific prior written permission.

*

* THIS SOFTWARE IS PROVIDED BY Bill Paul AND CONTRIBUTORS ``AS IS" AND
* ANY EXPRESS OR IMPLIED WARRANTIES, INCLUDING, BUT NOT LIMITED TO, THE
* IMPLIED WARRANTIES OF MERCHANTABILITY AND FITNESS FOR A PARTICULAR PURPOSE
* ARE DISCLAIMED. IN NO EVENT SHALL THE REGENTS OR CONTRIBUTORS BE LIABLE
* FOR ANY DIRECT, INDIRECT, INCIDENTAL, SPECIAL, EXEMPLARY, OR CONSEQUENTIAL
* DAMAGES (INCLUDING, BUT NOT LIMITED TO, PROCUREMENT OF SUBSTITUTE GOODS
* OR SERVICES; LOSS OF USE, DATA, OR PROFITS; OR BUSINESS INTERRUPTION)
* HOWEVER CAUSED AND ON ANY THEORY OF LIABILITY, WHETHER IN CONTRACT, STRICT
* LIABILITY, OR TORT (INCLUDING NEGLIGENCE OR OTHERWISE) ARISING IN ANY WAY
* OUT OF THE USE OF THIS SOFTWARE, EVEN IF ADVISED OF THE POSSIBILITY OF
* SUCH DAMAGE.

*

* EUI-64 conversion and lookup routines

* Copyright (C) 1995, 1996, 1997, and 1998 WIDE Project.

* All rights reserved.

*

* Redistribution and use in source and binary forms, with or without
* modification, are permitted provided that the following conditions
* are met:

* 1. Redistributions of source code must retain the above copyright
* notice, this list of conditions and the following disclaimer.

* 2. Redistributions in binary form must reproduce the above copyright
* notice, this list of conditions and the following disclaimer in the
* documentation and/or other materials provided with the distribution.

* 3. Neither the name of the project nor the names of its contributors
* may be used to endorse or promote products derived from this software
* without specific prior written permission.

*

* THIS SOFTWARE IS PROVIDED BY THE PROJECT AND CONTRIBUTORS ``AS IS" AND
* ANY EXPRESS OR IMPLIED WARRANTIES, INCLUDING, BUT NOT LIMITED TO, THE
* IMPLIED WARRANTIES OF MERCHANTABILITY AND FITNESS FOR A PARTICULAR PURPOSE
* ARE DISCLAIMED. IN NO EVENT SHALL THE PROJECT OR CONTRIBUTORS BE LIABLE
* FOR ANY DIRECT, INDIRECT, INCIDENTAL, SPECIAL, EXEMPLARY, OR CONSEQUENTIAL
* DAMAGES (INCLUDING, BUT NOT LIMITED TO, PROCUREMENT OF SUBSTITUTE GOODS
* OR SERVICES; LOSS OF USE, DATA, OR PROFITS; OR BUSINESS INTERRUPTION)
* HOWEVER CAUSED AND ON ANY THEORY OF LIABILITY, WHETHER IN CONTRACT, STRICT
* LIABILITY, OR TORT (INCLUDING NEGLIGENCE OR OTHERWISE) ARISING IN ANY WAY
* OUT OF THE USE OF THIS SOFTWARE, EVEN IF ADVISED OF THE POSSIBILITY OF
* SUCH DAMAGE.

*

* Copyright (c) 1980, 1983, 1988, 1993

* The Regents of the University of California. All rights reserved.

*

* Redistribution and use in source and binary forms, with or without
* modification, are permitted provided that the following conditions
* are met:

* 1. Redistributions of source code must retain the above copyright
* notice, this list of conditions and the following disclaimer.

- * 2. Redistributions in binary form must reproduce the above copyright notice, this list of conditions and the following disclaimer in the documentation and/or other materials provided with the distribution.
- * 3. All advertising materials mentioning features or use of this software must display the following acknowledgement:
 - * This product includes software developed by the University of California, Berkeley and its contributors.
- * 4. Neither the name of the University nor the names of its contributors may be used to endorse or promote products derived from this software without specific prior written permission.
- *
 - * THIS SOFTWARE IS PROVIDED BY THE REGENTS AND CONTRIBUTORS "AS IS" AND
 - * ANY EXPRESS OR IMPLIED WARRANTIES, INCLUDING, BUT NOT LIMITED TO, THE
 - * IMPLIED WARRANTIES OF MERCHANTABILITY AND FITNESS FOR A PARTICULAR PURPOSE
 - * ARE DISCLAIMED. IN NO EVENT SHALL THE REGENTS OR CONTRIBUTORS BE LIABLE
 - * FOR ANY DIRECT, INDIRECT, INCIDENTAL, SPECIAL, EXEMPLARY, OR CONSEQUENTIAL
 - * DAMAGES (INCLUDING, BUT NOT LIMITED TO, PROCUREMENT OF SUBSTITUTE GOODS
 - * OR SERVICES; LOSS OF USE, DATA, OR PROFITS; OR BUSINESS INTERRUPTION)
 - * HOWEVER CAUSED AND ON ANY THEORY OF LIABILITY, WHETHER IN CONTRACT, STRICT
 - * LIABILITY, OR TORT (INCLUDING NEGLIGENCE OR OTHERWISE) ARISING IN ANY WAY
 - * OUT OF THE USE OF THIS SOFTWARE, EVEN IF ADVISED OF THE POSSIBILITY OF
 - * SUCH DAMAGE.
- * Copyright (c) 1987, 1993, 1994
 - * The Regents of the University of California. All rights reserved.
- *
 - * Redistribution and use in source and binary forms, with or without
 - * modification, are permitted provided that the following conditions
 - * are met:
 - * 1. Redistributions of source code must retain the above copyright notice, this list of conditions and the following disclaimer.
 - * 2. Redistributions in binary form must reproduce the above copyright notice, this list of conditions and the following disclaimer in the documentation and/or other materials provided with the distribution.
 - * 3. Neither the name of the University nor the names of its contributors may be used to endorse or promote products derived from this software without specific prior written permission.
- *

* THIS SOFTWARE IS PROVIDED BY THE REGENTS AND CONTRIBUTORS ``AS IS" AND
* ANY EXPRESS OR IMPLIED WARRANTIES, INCLUDING, BUT NOT LIMITED TO, THE
* IMPLIED WARRANTIES OF MERCHANTABILITY AND FITNESS FOR A PARTICULAR PURPOSE
* ARE DISCLAIMED. IN NO EVENT SHALL THE REGENTS OR CONTRIBUTORS BE LIABLE
* FOR ANY DIRECT, INDIRECT, INCIDENTAL, SPECIAL, EXEMPLARY, OR CONSEQUENTIAL
* DAMAGES (INCLUDING, BUT NOT LIMITED TO, PROCUREMENT OF SUBSTITUTE GOODS
* OR SERVICES; LOSS OF USE, DATA, OR PROFITS; OR BUSINESS INTERRUPTION)
* HOWEVER CAUSED AND ON ANY THEORY OF LIABILITY, WHETHER IN CONTRACT, STRICT
* LIABILITY, OR TORT (INCLUDING NEGLIGENCE OR OTHERWISE) ARISING IN ANY WAY
* OUT OF THE USE OF THIS SOFTWARE, EVEN IF ADVISED OF THE POSSIBILITY OF
* SUCH DAMAGE.

* Copyright (c) 1988, 1989, 1993

* The Regents of the University of California. All rights reserved.

*

* Redistribution and use in source and binary forms, with or without
* modification, are permitted provided that the following conditions
* are met:

* 1. Redistributions of source code must retain the above copyright
* notice, this list of conditions and the following disclaimer.

* 2. Redistributions in binary form must reproduce the above copyright
* notice, this list of conditions and the following disclaimer in the
* documentation and/or other materials provided with the distribution.

* 3. Neither the name of the University nor the names of its contributors
* may be used to endorse or promote products derived from this software
* without specific prior written permission.

*

* THIS SOFTWARE IS PROVIDED BY THE REGENTS AND CONTRIBUTORS ``AS IS" AND
* ANY EXPRESS OR IMPLIED WARRANTIES, INCLUDING, BUT NOT LIMITED TO, THE
* IMPLIED WARRANTIES OF MERCHANTABILITY AND FITNESS FOR A PARTICULAR PURPOSE
* ARE DISCLAIMED. IN NO EVENT SHALL THE REGENTS OR CONTRIBUTORS BE LIABLE
* FOR ANY DIRECT, INDIRECT, INCIDENTAL, SPECIAL, EXEMPLARY, OR CONSEQUENTIAL
* DAMAGES (INCLUDING, BUT NOT LIMITED TO, PROCUREMENT OF SUBSTITUTE GOODS
* OR SERVICES; LOSS OF USE, DATA, OR PROFITS; OR BUSINESS INTERRUPTION)
* HOWEVER CAUSED AND ON ANY THEORY OF LIABILITY, WHETHER IN CONTRACT, STRICT
* LIABILITY, OR TORT (INCLUDING NEGLIGENCE OR OTHERWISE) ARISING IN ANY WAY
* OUT OF THE USE OF THIS SOFTWARE, EVEN IF ADVISED OF THE POSSIBILITY OF
* SUCH DAMAGE.

* Copyright (c) 1990, 1993
* The Regents of the University of California. All rights reserved.
*
* This code is derived from software contributed to Berkeley by
* Chris Torek.
*
* Redistribution and use in source and binary forms, with or without
* modification, are permitted provided that the following conditions
* are met:
* 1. Redistributions of source code must retain the above copyright
* notice, this list of conditions and the following disclaimer.
* 2. Redistributions in binary form must reproduce the above copyright
* notice, this list of conditions and the following disclaimer in the
* documentation and/or other materials provided with the distribution.
* 3. Neither the name of the University nor the names of its contributors
* may be used to endorse or promote products derived from this software
* without specific prior written permission.
*
* THIS SOFTWARE IS PROVIDED BY THE REGENTS AND CONTRIBUTORS ``AS IS'' AND
* ANY EXPRESS OR IMPLIED WARRANTIES, INCLUDING, BUT NOT LIMITED TO, THE
* IMPLIED WARRANTIES OF MERCHANTABILITY AND FITNESS FOR A PARTICULAR PURPOSE
* ARE DISCLAIMED. IN NO EVENT SHALL THE REGENTS OR CONTRIBUTORS BE LIABLE
* FOR ANY DIRECT, INDIRECT, INCIDENTAL, SPECIAL, EXEMPLARY, OR CONSEQUENTIAL
* DAMAGES (INCLUDING, BUT NOT LIMITED TO, PROCUREMENT OF SUBSTITUTE GOODS
* OR SERVICES; LOSS OF USE, DATA, OR PROFITS; OR BUSINESS INTERRUPTION)
* HOWEVER CAUSED AND ON ANY THEORY OF LIABILITY, WHETHER IN CONTRACT, STRICT
* LIABILITY, OR TORT (INCLUDING NEGLIGENCE OR OTHERWISE) ARISING IN ANY WAY
* OUT OF THE USE OF THIS SOFTWARE, EVEN IF ADVISED OF THE POSSIBILITY OF
* SUCH DAMAGE.

* Copyright (c) 2004 by Internet Systems Consortium, Inc. ("ISC")
* Copyright (c) 1996,1999 by Internet Software Consortium.
*
* Permission to use, copy, modify, and distribute this software for any
* purpose with or without fee is hereby granted, provided that the above
* copyright notice and this permission notice appear in all copies.
*

* THE SOFTWARE IS PROVIDED "AS IS" AND ISC DISCLAIMS ALL WARRANTIES
* WITH REGARD TO THIS SOFTWARE INCLUDING ALL IMPLIED WARRANTIES OF
* MERCHANTABILITY AND FITNESS. IN NO EVENT SHALL ISC BE LIABLE FOR
* ANY SPECIAL, DIRECT, INDIRECT, OR CONSEQUENTIAL DAMAGES OR ANY DAMAGES
* WHATSOEVER RESULTING FROM LOSS OF USE, DATA OR PROFITS, WHETHER IN AN
* ACTION OF CONTRACT, NEGLIGENCE OR OTHER TORTIOUS ACTION, ARISING OUT
* OF OR IN CONNECTION WITH THE USE OR PERFORMANCE OF THIS SOFTWARE.

* Copyright (c) 2007 Todd C. Miller <Todd.Miller@courtesan.com>

*

* Permission to use, copy, modify, and distribute this software for any
* purpose with or without fee is hereby granted, provided that the above
* copyright notice and this permission notice appear in all copies.

*

* THE SOFTWARE IS PROVIDED "AS IS" AND THE AUTHOR DISCLAIMS ALL WARRANTIES
* WITH REGARD TO THIS SOFTWARE INCLUDING ALL IMPLIED WARRANTIES OF
* MERCHANTABILITY AND FITNESS. IN NO EVENT SHALL THE AUTHOR BE LIABLE FOR
* ANY SPECIAL, DIRECT, INDIRECT, OR CONSEQUENTIAL DAMAGES OR ANY DAMAGES
* WHATSOEVER RESULTING FROM LOSS OF USE, DATA OR PROFITS, WHETHER IN AN
* ACTION OF CONTRACT, NEGLIGENCE OR OTHER TORTIOUS ACTION, ARISING OUT OF
* OR IN CONNECTION WITH THE USE OR PERFORMANCE OF THIS SOFTWARE.

Copyright 1988, 1989 by Carnegie Mellon University

All Rights Reserved

Permission to use, copy, modify, and distribute this software and its
documentation for any purpose and without fee is hereby granted,
provided that the above copyright notice appear in all copies and that
both that copyright notice and this permission notice appear in
supporting documentation, and that the name of CMU not be
used in advertising or publicity pertaining to distribution of the
software without specific, written prior permission.

CMU DISCLAIMS ALL WARRANTIES WITH REGARD TO THIS SOFTWARE, INCLUDING
ALL IMPLIED WARRANTIES OF MERCHANTABILITY AND FITNESS, IN NO EVENT SHALL
CMU BE LIABLE FOR ANY SPECIAL, INDIRECT OR CONSEQUENTIAL DAMAGES OR
ANY DAMAGES WHATSOEVER RESULTING FROM LOSS OF USE, DATA OR PROFITS,

WHETHER IN AN ACTION OF CONTRACT, NEGLIGENCE OR OTHER TORTIOUS ACTION, ARISING OUT OF OR IN CONNECTION WITH THE USE OR PERFORMANCE OF THIS SOFTWARE.

* _

* Portions Copyright (c) 1993 by Digital Equipment Corporation.

*

* Permission to use, copy, modify, and distribute this software for any
* purpose with or without fee is hereby granted, provided that the above
* copyright notice and this permission notice appear in all copies, and that
* the name of Digital Equipment Corporation not be used in advertising or
* publicity pertaining to distribution of the document or software without
* specific, written prior permission.

*

* THE SOFTWARE IS PROVIDED "AS IS" AND DIGITAL EQUIPMENT CORP. DISCLAIMS ALL
* WARRANTIES WITH REGARD TO THIS SOFTWARE, INCLUDING ALL IMPLIED WARRANTIES
* OF MERCHANTABILITY AND FITNESS. IN NO EVENT SHALL DIGITAL EQUIPMENT
* CORPORATION BE LIABLE FOR ANY SPECIAL, DIRECT, INDIRECT, OR CONSEQUENTIAL
* DAMAGES OR ANY DAMAGES WHATSOEVER RESULTING FROM LOSS OF USE, DATA OR
* PROFITS, WHETHER IN AN ACTION OF CONTRACT, NEGLIGENCE OR OTHER TORTIOUS
* ACTION, ARISING OUT OF OR IN CONNECTION WITH THE USE OR PERFORMANCE OF THIS
* SOFTWARE.

Copyright 1989 by Carnegie Mellon University

All Rights Reserved

Permission to use, copy, modify, and distribute this software and its documentation for any purpose and without fee is hereby granted, provided that the above copyright notice appear in all copies and that both that copyright notice and this permission notice appear in supporting documentation, and that the name of CMU not be used in advertising or publicity pertaining to distribution of the software without specific, written prior permission.

CMU DISCLAIMS ALL WARRANTIES WITH REGARD TO THIS SOFTWARE, INCLUDING ALL IMPLIED WARRANTIES OF MERCHANTABILITY AND FITNESS, IN NO EVENT SHALL CMU BE LIABLE FOR ANY SPECIAL, INDIRECT OR CONSEQUENTIAL DAMAGES OR

ANY DAMAGES WHATSOEVER RESULTING FROM LOSS OF USE, DATA OR PROFITS,
WHETHER IN AN ACTION OF CONTRACT, NEGLIGENCE OR OTHER TORTIOUS ACTION,
ARISING OUT OF OR IN CONNECTION WITH THE USE OR PERFORMANCE OF THIS
SOFTWARE.

// (c) 1999 Lehrgebiet Rechnernetze und Verteilte Systeme

// Universität Hannover, Germany

//

// Permission to use, copy, modify, distribute, and sell this software
// and its documentation for any purpose is hereby granted without fee,
// provided that (i) the above copyright notices and this permission
// notice appear in all copies of the software and related documentation,
// and (ii) the names of the Lehrgebiet Rechnernetze und Verteilte
// Systeme and the University of Hannover may not be used in any
// advertising or publicity relating to the software without the
// specific, prior written permission of Lehrgebiet Rechnernetze und
// Verteilte Systeme and the University of Hannover.

//

// THE SOFTWARE IS PROVIDED "AS-IS" AND WITHOUT WARRANTY OF ANY KIND,
// EXPRESS, IMPLIED OR OTHERWISE, INCLUDING WITHOUT LIMITATION, ANY
// WARRANTY OF MERCHANTABILITY OR FITNESS FOR A PARTICULAR PURPOSE.

//

// IN NO EVENT SHALL THE LEHRGEBIET RECHNERNETZE UND VERTEILTE SYSTEME OR
// THE UNIVERSITY OF HANNOVER BE LIABLE FOR ANY SPECIAL, INCIDENTAL,
// INDIRECT OR CONSEQUENTIAL DAMAGES OF ANY KIND, OR ANY DAMAGES
// WHATSOEVER RESULTING FROM LOSS OF USE, DATA OR PROFITS, WHETHER OR NOT
// ADVISED OF THE POSSIBILITY OF DAMAGE, AND ON ANY THEORY OF LIABILITY,
// ARISING OUT OF OR IN CONNECTION WITH THE USE OR PERFORMANCE OF THIS
// SOFTWARE.

* Livingston Enterprises, Inc.

* 6920 Koll Center Parkway

* Pleasanton, CA 94566

*

* Copyright 1992 Livingston Enterprises, Inc.

* Copyright 1997 Cistron Internet Services B.V.

*

* Permission to use, copy, modify, and distribute this software for any

- * purpose and without fee is hereby granted, provided that this
- * copyright and permission notice appear on all copies and supporting
- * documentation, the name of Livingston Enterprises, Inc. not be used
- * in advertising or publicity pertaining to distribution of the
- * program without specific prior permission, and notice be given
- * in supporting documentation that copying and distribution is by
- * permission of Livingston Enterprises, Inc.
- *
- * Livingston Enterprises, Inc. makes no representations about
- * the suitability of this software for any purpose. It is
- * provided "as is" without express or implied warranty.

This program is based on code from Livingston Enterprises, Inc. and parts are

COPYRIGHT NOTICE SQUID_RAD_AUTH

Copyright (C) 1992-1995 Livingston Enterprises, Inc and Cistron Internet Services B.V. who both have given permission to modify and distribute those parts. The new parts of the code is Copyright (C) 1998 R.M. van Selm <selm@cistron.nl> with modifications Copyright (C) 2004 Henrik Nordstrom <hno@squid-cache.org>

Permission to use, copy, modify, and distribute this software for any purpose and without fee is hereby granted, provided that this copyright and permission notice appear on all copies and supporting documentation, the name of Livingston Enterprises, Inc. not be used in advertising or publicity pertaining to distribution of the program without specific prior permission, and notice be given in supporting documentation that copying and distribution is by permission of Livingston Enterprises, Inc. and Cistron Internet Services B.V.

Neither Livingston Enterprises, Inc. nor Cistron Internet Services B.V. nor I (R.M. van Selm) make representations about the suitability of this software for any purpose. It is provided "as is" without express or implied warranty.

```
// Author: Jens-S. Voekler <voeckler@rvs.uni-hannover.de>
// File: signal.cc
// Date: Sat Feb 28 1998
// Compiler: gcc 2.7.2.x series
//
```



```
// Books: W. Richard Steven, "Advanced Programming in the UNIX Environment",
// Addison-Wesley, 1992.
//
// (c) 1998 Lehrgebiet Rechnernetze und Verteilte Systeme
// Universit?t Hannover, Germany
//
// Permission to use, copy, modify, distribute, and sell this software
// and its documentation for any purpose is hereby granted without fee,
// provided that (i) the above copyright notices and this permission
// notice appear in all copies of the software and related documentation,
// and (ii) the names of the Lehrgebiet Rechnernetze und Verteilte
// Systeme and the University of Hannover may not be used in any
// advertising or publicity relating to the software without the
// specific, prior written permission of Lehrgebiet Rechnernetze und
// Verteilte Systeme and the University of Hannover.
//
// THE SOFTWARE IS PROVIDED "AS-IS" AND WITHOUT WARRANTY OF ANY KIND,
// EXPRESS, IMPLIED OR OTHERWISE, INCLUDING WITHOUT LIMITATION, ANY
// WARRANTY OF MERCHANTABILITY OR FITNESS FOR A PARTICULAR PURPOSE.
//
// IN NO EVENT SHALL THE LEHRGEBIET RECHNERNETZE UND VERTEILTE SYSTEME OR
// THE UNIVERSITY OF HANNOVER BE LIABLE FOR ANY SPECIAL, INCIDENTAL,
// INDIRECT OR CONSEQUENTIAL DAMAGES OF ANY KIND, OR ANY DAMAGES
// WHATSOEVER RESULTING FROM LOSS OF USE, DATA OR PROFITS, WHETHER OR NOT
// ADVISED OF THE POSSIBILITY OF DAMAGE, AND ON ANY THEORY OF LIABILITY,
// ARISING OUT OF OR IN CONNECTION WITH THE USE OR PERFORMANCE OF THIS
// SOFTWARE.

=====
=====
```

compat/os/opensolaris_10_netdb.h:

- * Copyright (c) 2001 Mike Barcroft <mike@FreeBSD.org>
- * Copyright (c) 1990, 1993
- * The Regents of the University of California. All rights reserved.
- *
- * This code is derived from software contributed to Berkeley by

* Chris Torek.

*

* Redistribution and use in source and binary forms, with or without
* modification, are permitted provided that the following conditions
* are met:

* 1. Redistributions of source code must retain the above copyright
* notice, this list of conditions and the following disclaimer.

* 2. Redistributions in binary form must reproduce the above copyright
* notice, this list of conditions and the following disclaimer in the
* documentation and/or other materials provided with the distribution.

* 3. Neither the name of the University nor the names of its contributors
* may be used to endorse or promote products derived from this software
* without specific prior written permission.

*

* THIS SOFTWARE IS PROVIDED BY THE REGENTS AND CONTRIBUTORS ``AS IS'' AND
* ANY EXPRESS OR IMPLIED WARRANTIES, INCLUDING, BUT NOT LIMITED TO, THE
* IMPLIED WARRANTIES OF MERCHANTABILITY AND FITNESS FOR A PARTICULAR PURPOSE
* ARE DISCLAIMED. IN NO EVENT SHALL THE REGENTS OR CONTRIBUTORS BE LIABLE
* FOR ANY DIRECT, INDIRECT, INCIDENTAL, SPECIAL, EXEMPLARY, OR CONSEQUENTIAL
* DAMAGES (INCLUDING, BUT NOT LIMITED TO, PROCUREMENT OF SUBSTITUTE GOODS
* OR SERVICES; LOSS OF USE, DATA, OR PROFITS; OR BUSINESS INTERRUPTION)
* HOWEVER CAUSED AND ON ANY THEORY OF LIABILITY, WHETHER IN CONTRACT, STRICT
* LIABILITY, OR TORT (INCLUDING NEGLIGENCE OR OTHERWISE) ARISING IN ANY WAY
* OUT OF THE USE OF THIS SOFTWARE, EVEN IF ADVISED OF THE POSSIBILITY OF
* SUCH DAMAGE.

=====
=====

(C) Copyright Ion Gaztanaga 2005-2009.

Distributed under the Boost Software License, Version 1.0

Boost Software License - Version 1.0 - August 17th, 2003

Permission is hereby granted, free of charge, to any person or organization
obtaining a copy of the software and accompanying documentation covered by
this license (the "Software") to use, reproduce, display, distribute,
execute, and transmit the Software, and to prepare derivative works of the
Software, and to permit third-parties to whom the Software is furnished to

do so, all subject to the following:

The copyright notices in the Software and this entire statement, including the above license grant, this restriction and the following disclaimer, must be included in all copies of the Software, in whole or in part, and all derivative works of the Software, unless such copies or derivative works are solely in the form of machine-executable object code generated by a source language processor.

THE SOFTWARE IS PROVIDED "AS IS", WITHOUT WARRANTY OF ANY KIND, EXPRESS OR IMPLIED, INCLUDING BUT NOT LIMITED TO THE WARRANTIES OF MERCHANTABILITY, FITNESS FOR A PARTICULAR PURPOSE, TITLE AND NON-INFRINGEMENT. IN NO EVENT SHALL THE COPYRIGHT HOLDERS OR ANYONE DISTRIBUTING THE SOFTWARE BE LIABLE FOR ANY DAMAGES OR OTHER LIABILITY, WHETHER IN CONTRACT, TORT OR OTHERWISE, ARISING FROM, OUT OF OR IN CONNECTION WITH THE SOFTWARE OR THE USE OR OTHER DEALINGS IN THE SOFTWARE.

=====
=====

```
# This originates from X11R5 (mit/util/scripts/install.sh), which was
# later released in X11R6 (xc/config/util/install.sh) with the
# following copyright and license.
#
# Copyright (C) 1994 X Consortium
#
# Permission is hereby granted, free of charge, to any person obtaining a copy
# of this software and associated documentation files (the "Software"), to
# deal in the Software without restriction, including without limitation the
# rights to use, copy, modify, merge, publish, distribute, sublicense, and/or
# sell copies of the Software, and to permit persons to whom the Software is
# furnished to do so, subject to the following conditions:
#
# The above copyright notice and this permission notice shall be included in
# all copies or substantial portions of the Software.
#
# THE SOFTWARE IS PROVIDED "AS IS", WITHOUT WARRANTY OF ANY KIND, EXPRESS OR
# IMPLIED, INCLUDING BUT NOT LIMITED TO THE WARRANTIES OF MERCHANTABILITY,
# FITNESS FOR A PARTICULAR PURPOSE AND NON-INFRINGEMENT. IN NO EVENT SHALL THE
```

```
# X CONSORTIUM BE LIABLE FOR ANY CLAIM, DAMAGES OR OTHER LIABILITY, WHETHER IN
# AN ACTION OF CONTRACT, TORT OR OTHERWISE, ARISING FROM, OUT OF OR IN CONNec-
# TION WITH THE SOFTWARE OR THE USE OR OTHER DEALINGS IN THE SOFTWARE. +
#
# Except as contained in this notice, the name of the X Consortium shall not
# be used in advertising or otherwise to promote the sale, use or other deal-
# ings in this Software without prior written authorization from the X Consor-
# tium.
#
#
# FSF changes to this file are in the public domain.
#
# Calling this script install-sh is preferred over install.sh, to prevent
# 'make' implicit rules from creating a file called install from it
# when there is no Makefile.
#
# This script is compatible with the BSD install script, but was written
# from scratch.
```

DO NOT TRANSLATE OR LOCALIZE.

%% This notice is provided with respect to ASM Bytecode Manipulation Framework v5.0, which may be included with JRE 8, and JDK 8, and OpenJDK 8.

--- begin of LICENSE ---

Copyright (c) 2000-2011 France Telecom
All rights reserved.

Redistribution and use in source and binary forms, with or without modification, are permitted provided that the following conditions are met:

1. Redistributions of source code must retain the above copyright notice, this list of conditions and the following disclaimer.
2. Redistributions in binary form must reproduce the above copyright notice, this list of conditions and the following disclaimer in the documentation and/or other materials provided with the distribution.
3. Neither the name of the copyright holders nor the names of its contributors may be used to endorse or promote products derived from this software without specific prior written permission.

THIS SOFTWARE IS PROVIDED BY THE COPYRIGHT HOLDERS AND CONTRIBUTORS "AS IS" AND ANY EXPRESS OR IMPLIED WARRANTIES, INCLUDING, BUT NOT LIMITED TO, THE IMPLIED WARRANTIES OF MERCHANTABILITY AND FITNESS FOR A PARTICULAR PURPOSE ARE DISCLAIMED. IN NO EVENT SHALL THE COPYRIGHT OWNER OR CONTRIBUTORS BE LIABLE FOR ANY DIRECT, INDIRECT, INCIDENTAL, SPECIAL, EXEMPLARY, OR

CONSEQUENTIAL DAMAGES (INCLUDING, BUT NOT LIMITED TO,
PROCUREMENT OF
SUBSTITUTE GOODS OR SERVICES; LOSS OF USE, DATA, OR PROFITS; OR
BUSINESS
INTERRUPTION) HOWEVER CAUSED AND ON ANY THEORY OF LIABILITY,
WHETHER IN
CONTRACT, STRICT LIABILITY, OR TORT (INCLUDING NEGLIGENCE OR
OTHERWISE)
ARISING IN ANY WAY OUT OF THE USE OF THIS SOFTWARE, EVEN IF ADVISED
OF
THE POSSIBILITY OF SUCH DAMAGE.

--- end of LICENSE ---

%% This notice is provided with respect to BSDiff v4.3, which may be
included with JRE 8, JDK 8, and OpenJDK 8.

--- begin of LICENSE ---

Copyright 2003-2005 Colin Percival
All rights reserved

Redistribution and use in source and binary forms, with or without
modification, are permitted providing that the following conditions
are met:

1. Redistributions of source code must retain the above copyright
notice, this list of conditions and the following disclaimer.
2. Redistributions in binary form must reproduce the above copyright
notice, this list of conditions and the following disclaimer in the
documentation and/or other materials provided with the distribution.

THIS SOFTWARE IS PROVIDED BY THE AUTHOR "AS IS" AND ANY EXPRESS OR
IMPLIED WARRANTIES, INCLUDING, BUT NOT LIMITED TO, THE IMPLIED
WARRANTIES OF MERCHANTABILITY AND FITNESS FOR A PARTICULAR

PURPOSE

ARE DISCLAIMED. IN NO EVENT SHALL THE AUTHOR BE LIABLE FOR ANY DIRECT, INDIRECT, INCIDENTAL, SPECIAL, EXEMPLARY, OR CONSEQUENTIAL DAMAGES (INCLUDING, BUT NOT LIMITED TO, PROCUREMENT OF SUBSTITUTE GOODS

OR SERVICES; LOSS OF USE, DATA, OR PROFITS; OR BUSINESS INTERRUPTION) HOWEVER CAUSED AND ON ANY THEORY OF LIABILITY, WHETHER IN CONTRACT,

STRICT LIABILITY, OR TORT (INCLUDING NEGLIGENCE OR OTHERWISE) ARISING

IN ANY WAY OUT OF THE USE OF THIS SOFTWARE, EVEN IF ADVISED OF THE POSSIBILITY OF SUCH DAMAGE.

--- end of LICENSE ---

%% This notice is provided with respect to CodeViewer 1.0, which may be included with JDK 8.

--- begin of LICENSE ---

Copyright 1999 by CoolServlets.com.

Any errors or suggested improvements to this class can be reported as instructed on CoolServlets.com. We hope you enjoy this program... your comments will encourage further development! This software is distributed under the terms of the BSD License. Redistribution and use in source and binary forms, with or without modification, are permitted provided that the following conditions are met:

1. Redistributions of source code must retain the above copyright notice, this list of conditions and the following disclaimer.
2. Redistributions in binary form must reproduce the above copyright notice, this list of conditions and the following disclaimer in the documentation

and/or other materials provided with the distribution.

Neither name of CoolServlets.com nor the names of its contributors may be used to endorse or promote products derived from this software without specific prior written permission.

THIS SOFTWARE IS PROVIDED BY COOLSERVLETS.COM AND CONTRIBUTORS
"AS IS" AND
ANY EXPRESS OR IMPLIED WARRANTIES, INCLUDING, BUT NOT LIMITED TO,
THE IMPLIED
WARRANTIES OF MERCHANTABILITY AND FITNESS FOR A PARTICULAR
PURPOSE ARE
DISCLAIMED. IN NO EVENT SHALL THE AUTHOR OR CONTRIBUTORS BE
LIABLE FOR ANY
DIRECT, INDIRECT, INCIDENTAL, SPECIAL, EXEMPLARY, OR CONSEQUENTIAL
DAMAGES
(INCLUDING, BUT NOT LIMITED TO, PROCUREMENT OF SUBSTITUTE GOODS
OR SERVICES;
LOSS OF USE, DATA, OR PROFITS; OR BUSINESS INTERRUPTION) HOWEVER
CAUSED AND ON
ANY THEORY OF LIABILITY, WHETHER IN CONTRACT, STRICT LIABILITY, OR
TORT
(INCLUDING NEGLIGENCE OR OTHERWISE) ARISING IN ANY WAY OUT OF THE
USE OF THIS
SOFTWARE, EVEN IF ADVISED OF THE POSSIBILITY OF SUCH DAMAGE."

--- end of LICENSE ---

%% This notice is provided with respect to Cryptix AES 3.2.0, which may be included with JRE 8, JDK 8, and OpenJDK 8.

--- begin of LICENSE ---

Cryptix General License

Copyright (c) 1995-2005 The Cryptix Foundation Limited.

All rights reserved.

Redistribution and use in source and binary forms, with or without modification, are permitted provided that the following conditions are met:

1. Redistributions of source code must retain the copyright notice, this list of conditions and the following disclaimer.
2. Redistributions in binary form must reproduce the above copyright notice, this list of conditions and the following disclaimer in the documentation and/or other materials provided with the distribution.

THIS SOFTWARE IS PROVIDED BY THE CRYPTIX FOUNDATION LIMITED AND CONTRIBUTORS ``AS IS" AND ANY EXPRESS OR IMPLIED WARRANTIES, INCLUDING, BUT NOT LIMITED TO, THE IMPLIED WARRANTIES OF MERCHANTABILITY AND FITNESS FOR A PARTICULAR PURPOSE ARE DISCLAIMED.

IN NO EVENT SHALL THE CRYPTIX FOUNDATION LIMITED OR CONTRIBUTORS BE

LIABLE FOR ANY DIRECT, INDIRECT, INCIDENTAL, SPECIAL, EXEMPLARY, OR CONSEQUENTIAL DAMAGES (INCLUDING, BUT NOT LIMITED TO, PROCUREMENT OF

SUBSTITUTE GOODS OR SERVICES; LOSS OF USE, DATA, OR PROFITS; OR BUSINESS INTERRUPTION) HOWEVER CAUSED AND ON ANY THEORY OF LIABILITY,

WHETHER IN CONTRACT, STRICT LIABILITY, OR TORT (INCLUDING NEGLIGENCE

OR OTHERWISE) ARISING IN ANY WAY OUT OF THE USE OF THIS SOFTWARE, EVEN

IF ADVISED OF THE POSSIBILITY OF SUCH DAMAGE.

--- end of LICENSE ---

%% This notice is provided with respect to CUP Parser Generator for
Java 0.10k, which may be included with JRE 8, JDK 8, and OpenJDK 8.

--- begin of LICENSE ---

Copyright 1996-1999 by Scott Hudson, Frank Flannery, C. Scott Ananian

Permission to use, copy, modify, and distribute this software and its
documentation for any purpose and without fee is hereby granted, provided
that the above copyright notice appear in all copies and that both the
copyright notice and this permission notice and warranty disclaimer appear in
supporting documentation, and that the names of the authors or their
employers not be used in advertising or publicity pertaining to distribution of
the software without specific, written prior permission.

The authors and their employers disclaim all warranties with regard to
this software, including all implied warranties of merchantability and fitness.
In no event shall the authors or their employers be liable for any special,
indirect or consequential damages or any damages whatsoever resulting from
loss of use, data or profits, whether in an action of contract, negligence or
other tortious action, arising out of or in connection with the use or
performance of this software.

--- end of LICENSE ---

%% This notice is provided with respect to Document Object Model (DOM) Level 2
& 3, which may be included with JRE 8, JDK 8, and OpenJDK 8.

--- begin of LICENSE ---

W3C SOFTWARE NOTICE AND LICENSE

<http://www.w3.org/Consortium/Legal/2002/copyright-software-20021231>

This work (and included software, documentation such as READMEs, or other related items) is being provided by the copyright holders under the following license. By obtaining, using and/or copying this work, you (the licensee) agree that you have read, understood, and will comply with the following terms and conditions.

Permission to copy, modify, and distribute this software and its documentation, with or without modification, for any purpose and without fee or royalty is hereby granted, provided that you include the following on ALL copies of the software and documentation or portions thereof, including modifications:

- 1.The full text of this NOTICE in a location viewable to users of the redistributed or derivative work.
- 2.Any pre-existing intellectual property disclaimers, notices, or terms and conditions. If none exist, the W3C Software Short Notice should be included (hypertext is preferred, text is permitted) within the body of any redistributed or derivative code.
- 3.Notice of any changes or modifications to the files, including the date changes were made. (We recommend you provide URIs to the location from which the code is derived.)

THIS SOFTWARE AND DOCUMENTATION IS PROVIDED "AS IS," AND
COPYRIGHT HOLDERS
MAKE NO REPRESENTATIONS OR WARRANTIES, EXPRESS OR IMPLIED,
INCLUDING BUT NOT
LIMITED TO, WARRANTIES OF MERCHANTABILITY OR FITNESS FOR ANY
PARTICULAR
PURPOSE OR THAT THE USE OF THE SOFTWARE OR DOCUMENTATION WILL
NOT INFRINGE ANY

THIRD PARTY PATENTS,COPYRIGHTS, TRADEMARKS OR OTHER RIGHTS.

COPYRIGHT HOLDERS WILL NOT BE LIABLE FOR ANY DIRECT, INDIRECT,
SPECIAL
OR CONSEQUENTIAL DAMAGES ARISING OUT OF ANY USE OF THE SOFTWARE
OR

DOCUMENTATION. The name and trademarks of copyright holders may NOT be used
in advertising or publicity pertaining to the software without specific,
written prior permission. Title to copyright in this software and any
associated documentation will at all times remain with copyright holders.

This formulation of W3C's notice and license became active on December 31
2002. This version removes the copyright ownership notice such that this
license can be used with materials other than those owned by the W3C, reflects
that ERCIM is now a host of the W3C, includes references to this specific
dated version of the license, and removes the ambiguous grant of "use".
Otherwise, this version is the same as the previous version and is written so
as to preserve the Free Software Foundation's assessment of GPL compatibility
and OSI's certification under the Open Source Definition. Please see our
Copyright FAQ for common questions about using materials from our site,
including specific terms and conditions for packages like libwww, Amaya, and
Jigsaw. Other questions about this notice can be directed to
site-policy@w3.org.

--- end of LICENSE ---

%% This notice is provided with respect to Dynalink v0.5, which may be
included with JRE 8, JDK 8, and OpenJDK 8.

--- begin of LICENSE ---

Copyright (c) 2009-2013, Attila Szegedi

All rights reserved.Redistribution and use in source and binary forms, with or without modification, are permitted provided that the following conditions are met:* Redistributions of source code must retain the above copyright notice, this list of conditions and the following disclaimer. * Redistributions in binary form must reproduce the above copyright notice, this list of conditions and the following disclaimer in the documentation and/or other materials provided with the distribution. * Neither the name of Attila Szegedi nor the names of its contributors may be used to endorse or promote products derived from this software without specific prior written permission.

THIS SOFTWARE IS PROVIDED BY THE COPYRIGHT HOLDERS AND CONTRIBUTORS "AS IS"AND ANY EXPRESS OR IMPLIED WARRANTIES, INCLUDING, BUT NOT LIMITED TO, THE IMPLIED WARRANTIES OF MERCHANTABILITY AND FITNESS FOR A PARTICULAR PURPOSE ARE DISCLAIMED. IN NO EVENT SHALL THE COPYRIGHT HOLDER OR CONTRIBUTORS BE LIABLE FOR ANY DIRECT, INDIRECT, INCIDENTAL, SPECIAL, EXEMPLARY, OR CONSEQUENTIAL DAMAGES (INCLUDING, BUT NOT LIMITED TO, PROCUREMENT OF SUBSTITUTE GOODS OR SERVICES; LOSS OF USE, DATA, OR PROFITS; OR BUSINESS INTERRUPTION) HOWEVER CAUSED AND ON ANY THEORY OF LIABILITY, WHETHER IN CONTRACT, STRICT LIABILITY, OR TORT (INCLUDING NEGLIGENCE OR OTHERWISE) ARISING IN ANY WAY OUT OF THE USE OF THIS SOFTWARE, EVEN IF ADVISED OF THE POSSIBILITY OF SUCH DAMAGE.

--- end of LICENSE ---

%% This notice is provided with respect to Elliptic Curve Cryptography, which

may be included with JRE 8, JDK 8, and OpenJDK 8.

You are receiving a copy of the Elliptic Curve Cryptography library in source form with the JDK 8 and OpenJDK 8 source distributions, and as object code in the JRE 8 & JDK 8 runtimes.

In the case of the JRE 8 & JDK 8 runtimes, the terms of the Oracle license do NOT apply to the Elliptic Curve Cryptography library; it is licensed under the following license, separately from Oracle's JDK & JRE. If you do not wish to install the Elliptic Curve Cryptography library, you may delete the library named `libsunec.so` (on Solaris and Linux systems) or `sunec.dll` (on Windows systems) from the JRE bin directory reserved for native libraries.

--- begin of LICENSE ---

GNU LESSER GENERAL PUBLIC LICENSE

Version 2.1, February 1999

Copyright (C) 1991, 1999 Free Software Foundation, Inc.
51 Franklin Street, Fifth Floor, Boston, MA 02110-1301 USA
Everyone is permitted to copy and distribute verbatim copies
of this license document, but changing it is not allowed.

[This is the first released version of the Lesser GPL. It also counts
as the successor of the GNU Library Public License, version 2, hence
the version number 2.1.]

Preamble

The licenses for most software are designed to take away your
freedom to share and change it. By contrast, the GNU General Public
Licenses are intended to guarantee your freedom to share and change
free software--to make sure the software is free for all its users.

This license, the Lesser General Public License, applies to some

specially designated software packages--typically libraries--of the Free Software Foundation and other authors who decide to use it. You can use it too, but we suggest you first think carefully about whether this license or the ordinary General Public License is the better strategy to use in any particular case, based on the explanations below.

When we speak of free software, we are referring to freedom of use, not price. Our General Public Licenses are designed to make sure that you have the freedom to distribute copies of free software (and charge for this service if you wish); that you receive source code or can get it if you want it; that you can change the software and use pieces of it in new free programs; and that you are informed that you can do these things.

To protect your rights, we need to make restrictions that forbid distributors to deny you these rights or to ask you to surrender these rights. These restrictions translate to certain responsibilities for you if you distribute copies of the library or if you modify it.

For example, if you distribute copies of the library, whether gratis or for a fee, you must give the recipients all the rights that we gave you. You must make sure that they, too, receive or can get the source code. If you link other code with the library, you must provide complete object files to the recipients, so that they can relink them with the library after making changes to the library and recompiling it. And you must show them these terms so they know their rights.

We protect your rights with a two-step method: (1) we copyright the library, and (2) we offer you this license, which gives you legal permission to copy, distribute and/or modify the library.

To protect each distributor, we want to make it very clear that there is no warranty for the free library. Also, if the library is modified by someone else and passed on, the recipients should know that what they have is not the original version, so that the original author's reputation will not be affected by problems that might be

introduced by others.

Finally, software patents pose a constant threat to the existence of any free program. We wish to make sure that a company cannot effectively restrict the users of a free program by obtaining a restrictive license from a patent holder. Therefore, we insist that any patent license obtained for a version of the library must be consistent with the full freedom of use specified in this license.

Most GNU software, including some libraries, is covered by the ordinary GNU General Public License. This license, the GNU Lesser General Public License, applies to certain designated libraries, and is quite different from the ordinary General Public License. We use this license for certain libraries in order to permit linking those libraries into non-free programs.

When a program is linked with a library, whether statically or using a shared library, the combination of the two is legally speaking a combined work, a derivative of the original library. The ordinary General Public License therefore permits such linking only if the entire combination fits its criteria of freedom. The Lesser General Public License permits more lax criteria for linking other code with the library.

We call this license the "Lesser" General Public License because it does Less to protect the user's freedom than the ordinary General Public License. It also provides other free software developers Less of an advantage over competing non-free programs. These disadvantages are the reason we use the ordinary General Public License for many libraries. However, the Lesser license provides advantages in certain special circumstances.

For example, on rare occasions, there may be a special need to encourage the widest possible use of a certain library, so that it becomes a de-facto standard. To achieve this, non-free programs must be allowed to use the library. A more frequent case is that a free library does the same job as widely used non-free libraries. In this case, there is little to gain by limiting the free library to free

software only, so we use the Lesser General Public License.

In other cases, permission to use a particular library in non-free programs enables a greater number of people to use a large body of free software. For example, permission to use the GNU C Library in non-free programs enables many more people to use the whole GNU operating system, as well as its variant, the GNU/Linux operating system.

Although the Lesser General Public License is Less protective of the users' freedom, it does ensure that the user of a program that is linked with the Library has the freedom and the wherewithal to run that program using a modified version of the Library.

The precise terms and conditions for copying, distribution and modification follow. Pay close attention to the difference between a "work based on the library" and a "work that uses the library". The former contains code derived from the library, whereas the latter must be combined with the library in order to run.

GNU LESSER GENERAL PUBLIC LICENSE
TERMS AND CONDITIONS FOR COPYING, DISTRIBUTION AND
MODIFICATION

0. This License Agreement applies to any software library or other program which contains a notice placed by the copyright holder or other authorized party saying it may be distributed under the terms of this Lesser General Public License (also called "this License").

Each licensee is addressed as "you".

A "library" means a collection of software functions and/or data prepared so as to be conveniently linked with application programs (which use some of those functions and data) to form executables.

The "Library", below, refers to any such software library or work which has been distributed under these terms. A "work based on the Library" means either the Library or any derivative work under copyright law: that is to say, a work containing the Library or a portion of it, either verbatim or with modifications and/or translated straightforwardly into another language. (Hereinafter, translation is included without limitation in the term "modification".)

"Source code" for a work means the preferred form of the work for making modifications to it. For a library, complete source code means all the source code for all modules it contains, plus any associated interface definition files, plus the scripts used to control compilation and installation of the library.

Activities other than copying, distribution and modification are not covered by this License; they are outside its scope. The act of running a program using the Library is not restricted, and output from such a program is covered only if its contents constitute a work based on the Library (independent of the use of the Library in a tool for writing it). Whether that is true depends on what the Library does and what the program that uses the Library does.

1. You may copy and distribute verbatim copies of the Library's complete source code as you receive it, in any medium, provided that you conspicuously and appropriately publish on each copy an appropriate copyright notice and disclaimer of warranty; keep intact all the notices that refer to this License and to the absence of any warranty; and distribute a copy of this License along with the Library.

You may charge a fee for the physical act of transferring a copy, and you may at your option offer warranty protection in exchange for a fee.

2. You may modify your copy or copies of the Library or any portion of it, thus forming a work based on the Library, and copy and distribute such modifications or work under the terms of Section 1 above, provided that you also meet all of these conditions:

- a) The modified work must itself be a software library.
- b) You must cause the files modified to carry prominent notices stating that you changed the files and the date of any change.
- c) You must cause the whole of the work to be licensed at no charge to all third parties under the terms of this License.
- d) If a facility in the modified Library refers to a function or a table of data to be supplied by an application program that uses the facility, other than as an argument passed when the facility is invoked, then you must make a good faith effort to ensure that, in the event an application does not supply such function or table, the facility still operates, and performs whatever part of its purpose remains meaningful.

(For example, a function in a library to compute square roots has a purpose that is entirely well-defined independent of the application. Therefore, Subsection 2d requires that any application-supplied function or table used by this function must be optional: if the application does not supply it, the square root function must still compute square roots.)

These requirements apply to the modified work as a whole. If identifiable sections of that work are not derived from the Library, and can be reasonably considered independent and separate works in themselves, then this License, and its terms, do not apply to those sections when you distribute them as separate works. But when you distribute the same sections as part of a whole which is a work based on the Library, the distribution of the whole must be on the terms of this License, whose permissions for other licensees extend to the

entire whole, and thus to each and every part regardless of who wrote it.

Thus, it is not the intent of this section to claim rights or contest your rights to work written entirely by you; rather, the intent is to exercise the right to control the distribution of derivative or collective works based on the Library.

In addition, mere aggregation of another work not based on the Library with the Library (or with a work based on the Library) on a volume of a storage or distribution medium does not bring the other work under the scope of this License.

3. You may opt to apply the terms of the ordinary GNU General Public License instead of this License to a given copy of the Library. To do this, you must alter all the notices that refer to this License, so that they refer to the ordinary GNU General Public License, version 2, instead of to this License. (If a newer version than version 2 of the ordinary GNU General Public License has appeared, then you can specify that version instead if you wish.) Do not make any other change in these notices.

Once this change is made in a given copy, it is irreversible for that copy, so the ordinary GNU General Public License applies to all subsequent copies and derivative works made from that copy.

This option is useful when you wish to copy part of the code of the Library into a program that is not a library.

4. You may copy and distribute the Library (or a portion or derivative of it, under Section 2) in object code or executable form under the terms of Sections 1 and 2 above provided that you accompany it with the complete corresponding machine-readable source code, which must be distributed under the terms of Sections 1 and 2 above on a medium customarily used for software interchange.

If distribution of object code is made by offering access to copy from a designated place, then offering equivalent access to copy the source code from the same place satisfies the requirement to distribute the source code, even though third parties are not compelled to copy the source along with the object code.

5. A program that contains no derivative of any portion of the Library, but is designed to work with the Library by being compiled or linked with it, is called a "work that uses the Library". Such a work, in isolation, is not a derivative work of the Library, and therefore falls outside the scope of this License.

However, linking a "work that uses the Library" with the Library creates an executable that is a derivative of the Library (because it contains portions of the Library), rather than a "work that uses the library". The executable is therefore covered by this License. Section 6 states terms for distribution of such executables.

When a "work that uses the Library" uses material from a header file that is part of the Library, the object code for the work may be a derivative work of the Library even though the source code is not. Whether this is true is especially significant if the work can be

linked without the Library, or if the work is itself a library. The threshold for this to be true is not precisely defined by law.

If such an object file uses only numerical parameters, data structure layouts and accessors, and small macros and small inline functions (ten lines or less in length), then the use of the object file is unrestricted, regardless of whether it is legally a derivative work. (Executables containing this object code plus portions of the Library will still fall under Section 6.)

Otherwise, if the work is a derivative of the Library, you may distribute the object code for the work under the terms of Section 6. Any executables containing that work also fall under Section 6, whether or not they are linked directly with the Library itself.

6. As an exception to the Sections above, you may also combine or link a "work that uses the Library" with the Library to produce a work containing portions of the Library, and distribute that work under terms of your choice, provided that the terms permit modification of the work for the customer's own use and reverse engineering for debugging such modifications.

You must give prominent notice with each copy of the work that the Library is used in it and that the Library and its use are covered by this License. You must supply a copy of this License. If the work during execution displays copyright notices, you must include the copyright notice for the Library among them, as well as a reference directing the user to the copy of this License. Also, you must do one of these things:

a) Accompany the work with the complete corresponding machine-readable source code for the Library including whatever changes were used in the work (which must be distributed under Sections 1 and 2 above); and, if the work is an executable linked with the Library, with the complete machine-readable "work that uses the Library", as object code and/or source code, so that the user can modify the Library and then relink to produce a modified executable containing the modified Library. (It is understood that the user who changes the contents of definitions files in the Library will not necessarily be able to recompile the application to use the modified definitions.)

b) Use a suitable shared library mechanism for linking with the Library. A suitable mechanism is one that (1) uses at run time a copy of the library already present on the user's computer system, rather than copying library functions into the executable, and (2) will operate properly with a modified version of the library, if the user installs one, as long as the modified version is interface-compatible with the version that the work was made with.

c) Accompany the work with a written offer, valid for at

least three years, to give the same user the materials specified in Subsection 6a, above, for a charge no more than the cost of performing this distribution.

d) If distribution of the work is made by offering access to copy from a designated place, offer equivalent access to copy the above specified materials from the same place.

e) Verify that the user has already received a copy of these materials or that you have already sent this user a copy.

For an executable, the required form of the "work that uses the Library" must include any data and utility programs needed for reproducing the executable from it. However, as a special exception, the materials to be distributed need not include anything that is normally distributed (in either source or binary form) with the major components (compiler, kernel, and so on) of the operating system on which the executable runs, unless that component itself accompanies the executable.

It may happen that this requirement contradicts the license restrictions of other proprietary libraries that do not normally accompany the operating system. Such a contradiction means you cannot use both them and the Library together in an executable that you distribute.

7. You may place library facilities that are a work based on the Library side-by-side in a single library together with other library facilities not covered by this License, and distribute such a combined library, provided that the separate distribution of the work based on the Library and of the other library facilities is otherwise permitted, and provided that you do these two things:

a) Accompany the combined library with a copy of the same work based on the Library, uncombined with any other library facilities. This must be distributed under the terms of the Sections above.

b) Give prominent notice with the combined library of the fact that part of it is a work based on the Library, and explaining where to find the accompanying uncombined form of the same work.

8. You may not copy, modify, sublicense, link with, or distribute the Library except as expressly provided under this License. Any attempt otherwise to copy, modify, sublicense, link with, or distribute the Library is void, and will automatically terminate your rights under this License. However, parties who have received copies, or rights, from you under this License will not have their licenses terminated so long as such parties remain in full compliance.

9. You are not required to accept this License, since you have not signed it. However, nothing else grants you permission to modify or distribute the Library or its derivative works. These actions are prohibited by law if you do not accept this License. Therefore, by modifying or distributing the Library (or any work based on the Library), you indicate your acceptance of this License to do so, and all its terms and conditions for copying, distributing or modifying the Library or works based on it.

10. Each time you redistribute the Library (or any work based on the Library), the recipient automatically receives a license from the original licensor to copy, distribute, link with or modify the Library

subject to these terms and conditions. You may not impose any further restrictions on the recipients' exercise of the rights granted herein.

You are not responsible for enforcing compliance by third parties with this License.

11. If, as a consequence of a court judgment or allegation of patent infringement or for any other reason (not limited to patent issues), conditions are imposed on you (whether by court order, agreement or otherwise) that contradict the conditions of this License, they do not excuse you from the conditions of this License. If you cannot distribute so as to satisfy simultaneously your obligations under this License and any other pertinent obligations, then as a consequence you may not distribute the Library at all. For example, if a patent license would not permit royalty-free redistribution of the Library by all those who receive copies directly or indirectly through you, then the only way you could satisfy both it and this License would be to refrain entirely from distribution of the Library.

If any portion of this section is held invalid or unenforceable under any particular circumstance, the balance of the section is intended to apply, and the section as a whole is intended to apply in other circumstances.

It is not the purpose of this section to induce you to infringe any patents or other property right claims or to contest validity of any such claims; this section has the sole purpose of protecting the integrity of the free software distribution system which is implemented by public license practices. Many people have made generous contributions to the wide range of software distributed through that system in reliance on consistent application of that system; it is up to the author/donor to decide if he or she is willing to distribute software through any other system and a licensee cannot impose that choice.

This section is intended to make thoroughly clear what is believed to be a consequence of the rest of this License.

12. If the distribution and/or use of the Library is restricted in certain countries either by patents or by copyrighted interfaces, the original copyright holder who places the Library under this License may add an explicit geographical distribution limitation excluding those countries, so that distribution is permitted only in or among countries not thus

excluded. In such case, this License incorporates the limitation as if written in the body of this License.

13. The Free Software Foundation may publish revised and/or new versions of the Lesser General Public License from time to time. Such new versions will be similar in spirit to the present version, but may differ in detail to address new problems or concerns.

Each version is given a distinguishing version number. If the Library specifies a version number of this License which applies to it and "any later version", you have the option of following the terms and conditions either of that version or of any later version published by the Free Software Foundation. If the Library does not specify a license version number, you may choose any version ever published by the Free Software Foundation.

14. If you wish to incorporate parts of the Library into other free programs whose distribution conditions are incompatible with these, write to the author to ask for permission. For software which is copyrighted by the Free Software Foundation, write to the Free Software Foundation; we sometimes make exceptions for this. Our decision will be guided by the two goals of preserving the free status of all derivatives of our free software and of promoting the sharing and reuse of software generally.

NO WARRANTY

15. BECAUSE THE LIBRARY IS LICENSED FREE OF CHARGE, THERE IS NO WARRANTY FOR THE LIBRARY, TO THE EXTENT PERMITTED BY APPLICABLE LAW.

EXCEPT WHEN OTHERWISE STATED IN WRITING THE COPYRIGHT HOLDERS AND/OR

OTHER PARTIES PROVIDE THE LIBRARY "AS IS" WITHOUT WARRANTY OF ANY KIND, EITHER EXPRESSED OR IMPLIED, INCLUDING, BUT NOT LIMITED TO, THE

IMPLIED WARRANTIES OF MERCHANTABILITY AND FITNESS FOR A PARTICULAR

PURPOSE. THE ENTIRE RISK AS TO THE QUALITY AND PERFORMANCE OF THE

LIBRARY IS WITH YOU. SHOULD THE LIBRARY PROVE DEFECTIVE, YOU ASSUME

THE COST OF ALL NECESSARY SERVICING, REPAIR OR CORRECTION.

16. IN NO EVENT UNLESS REQUIRED BY APPLICABLE LAW OR AGREED TO IN

WRITING WILL ANY COPYRIGHT HOLDER, OR ANY OTHER PARTY WHO MAY MODIFY

AND/OR REDISTRIBUTE THE LIBRARY AS PERMITTED ABOVE, BE LIABLE TO YOU

FOR DAMAGES, INCLUDING ANY GENERAL, SPECIAL, INCIDENTAL OR

CONSEQUENTIAL DAMAGES ARISING OUT OF THE USE OR INABILITY TO USE THE

LIBRARY (INCLUDING BUT NOT LIMITED TO LOSS OF DATA OR DATA BEING
RENDERED INACCURATE OR LOSSES SUSTAINED BY YOU OR THIRD PARTIES
OR A
FAILURE OF THE LIBRARY TO OPERATE WITH ANY OTHER SOFTWARE), EVEN
IF
SUCH HOLDER OR OTHER PARTY HAS BEEN ADVISED OF THE POSSIBILITY OF
SUCH
DAMAGES.

END OF TERMS AND CONDITIONS

How to Apply These Terms to Your New Libraries

If you develop a new library, and you want it to be of the greatest possible use to the public, we recommend making it free software that everyone can redistribute and change. You can do so by permitting redistribution under these terms (or, alternatively, under the terms of the ordinary General Public License).

To apply these terms, attach the following notices to the library. It is safest to attach them to the start of each source file to most effectively convey the exclusion of warranty; and each file should have at least the "copyright" line and a pointer to where the full notice is found.

```
<one line to give the library's name and a brief idea of what it does.>  
Copyright (C) <year> <name of author>
```

```
This library is free software; you can redistribute it and/or  
modify it under the terms of the GNU Lesser General Public  
License as published by the Free Software Foundation; either  
version 2.1 of the License, or (at your option) any later version.
```

```
This library is distributed in the hope that it will be useful,  
but WITHOUT ANY WARRANTY; without even the implied warranty of  
MERCHANTABILITY or FITNESS FOR A PARTICULAR PURPOSE. See the  
GNU  
Lesser General Public License for more details.
```

```
You should have received a copy of the GNU Lesser General Public  
License along with this library; if not, write to the Free Software  
Foundation, Inc., 51 Franklin Street, Fifth Floor, Boston, MA 02110-1301 USA
```

Also add information on how to contact you by electronic and paper mail.

You should also get your employer (if you work as a programmer) or your school, if any, to sign a "copyright disclaimer" for the library, if necessary. Here is a sample; alter the names:

Yoyodyne, Inc., hereby disclaims all copyright interest in the library `Frob' (a library for tweaking knobs) written by James Random Hacker.

<signature of Ty Coon>, 1 April 1990

Ty Coon, President of Vice

That's all there is to it!

--- end of LICENSE ---

%% This notice is provided with respect to ECMAScript Language Specification ECMA-262 Edition 5.1 which may be included with JRE 8, JDK 8, and OpenJDK 8.

--- begin of LICENSE ---

Copyright notice

Copyright c 2011 Ecma International

Ecma International

Rue du Rhone 114

CH-1204 Geneva

Tel: +41 22 849 6000

Fax: +41 22 849 6001

Web: <http://www.ecma-international.org>

This document and possible translations of it may be copied and furnished to others, and derivative works that comment on or otherwise explain it or assist in its implementation may be prepared, copied, published, and distributed, in whole or in part, without restriction of any kind, provided that the above copyright notice and this section are included on all such copies and derivative works. However, this document itself may not be modified in any way, including by removing the copyright notice or references to Ecma International, except as needed for the purpose of developing any document or deliverable produced by

Ecma International (in which case the rules applied to copyrights must be followed) or as required to translate it into languages other than English. The limited permissions granted above are perpetual and will not be revoked by Ecma International or its successors or assigns. This document and the information contained herein is provided on an "AS IS" basis and ECMA INTERNATIONAL DISCLAIMS ALL WARRANTIES, EXPRESS OR IMPLIED, INCLUDING BUT NOT LIMITED TO ANY WARRANTY THAT THE USE OF THE INFORMATION HEREIN WILL NOT INFRINGE ANY OWNERSHIP RIGHTS OR ANY IMPLIED WARRANTIES OF MERCHANTABILITY OR FITNESS FOR A PARTICULAR PURPOSE." Software License

All Software contained in this document ("Software") is protected by copyright and is being made available under the "BSD License", included below. This Software may be subject to third party rights (rights from parties other than Ecma International), including patent rights, and no licenses under such third party rights are granted under this license even if the third party concerned is a member of Ecma International. SEE THE ECMA CODE OF CONDUCT IN PATENT MATTERS

AVAILABLE AT <http://www.ecma-international.org/memento/codeofconduct.htm> FOR INFORMATION REGARDING THE LICENSING OF PATENT CLAIMS THAT ARE REQUIRED TO

IMPLEMENT ECMA INTERNATIONAL STANDARDS*. Redistribution and use in source and

binary forms, with or without modification, are permitted provided that the following conditions are met:

1. Redistributions of source code must retain the above copyright notice, this list of conditions and the following disclaimer.
2. Redistributions in binary form must reproduce the above copyright notice, this list of conditions and the following disclaimer in the documentation and/or other materials provided with the distribution.
3. Neither the name of the authors nor Ecma International may be used to endorse

or promote products derived from this software without specific prior written permission.

THIS SOFTWARE IS PROVIDED BY THE ECMA INTERNATIONAL "AS IS" AND ANY EXPRESS OR IMPLIED WARRANTIES, INCLUDING, BUT NOT LIMITED TO, THE IMPLIED WARRANTIES OF MERCHANTABILITY AND FITNESS FOR A PARTICULAR PURPOSE ARE DISCLAIMED. IN NO EVENT SHALL ECMA INTERNATIONAL BE LIABLE FOR ANY DIRECT, INDIRECT, INCIDENTAL, SPECIAL, EXEMPLARY, OR CONSEQUENTIAL DAMAGES (INCLUDING, BUT NOT LIMITED TO, PROCUREMENT OF SUBSTITUTE GOODS OR SERVICES; LOSS OF USE, DATA, OR PROFITS; OR BUSINESS INTERRUPTION) HOWEVER CAUSED AND ON ANY THEORY OF LIABILITY, WHETHER IN CONTRACT, STRICT LIABILITY, OR TORT (INCLUDING NEGLIGENCE OR OTHERWISE) ARISING IN ANY WAY OUT OF THE USE OF THIS SOFTWARE, EVEN IF ADVISED OF THE POSSIBILITY OF SUCH DAMAGE.

--- end of LICENSE ---

%% This notice is provided with respect to Dynalink library which is included with the Nashorn technology.

--- begin of LICENSE ---

Copyright (c) 2009-2013, Attila Szegedi

Redistribution and use in source and binary forms, with or without modification, are permitted provided that the following conditions are met:

- * Redistributions of source code must retain the above copyright notice, this list of conditions and the following disclaimer.
- * Redistributions in binary form must reproduce the above copyright

notice, this list of conditions and the following disclaimer in the documentation and/or other materials provided with the distribution.

* Neither the name of the copyright holder nor the names of contributors may be used to endorse or promote products derived from this software without specific prior written permission.

THIS SOFTWARE IS PROVIDED BY THE COPYRIGHT HOLDERS AND CONTRIBUTORS "AS IS" AND ANY EXPRESS OR IMPLIED WARRANTIES, INCLUDING, BUT NOT LIMITED TO, THE IMPLIED WARRANTIES OF MERCHANTABILITY AND FITNESS FOR A PARTICULAR PURPOSE ARE DISCLAIMED. IN NO EVENT SHALL COPYRIGHT HOLDER BE LIABLE FOR ANY DIRECT, INDIRECT, INCIDENTAL, SPECIAL, EXEMPLARY, OR CONSEQUENTIAL DAMAGES (INCLUDING, BUT NOT LIMITED TO, PROCUREMENT OF SUBSTITUTE GOODS OR SERVICES; LOSS OF USE, DATA, OR PROFITS; OR BUSINESS INTERRUPTION) HOWEVER CAUSED AND ON ANY THEORY OF LIABILITY, WHETHER IN CONTRACT, STRICT LIABILITY, OR TORT (INCLUDING NEGLIGENCE OR OTHERWISE) ARISING IN ANY WAY OUT OF THE USE OF THIS SOFTWARE, EVEN IF ADVISED OF THE POSSIBILITY OF SUCH DAMAGE.

--- end of LICENSE ---

%% This notice is provided with respect to Joni library which is included with the Nashorn technology.

--- begin of LICENSE ---

Permission is hereby granted, free of charge, to any person obtaining a copy of this software and associated documentation files (the "Software"), to deal in the Software without restriction, including without limitation the rights to use, copy, modify, merge, publish, distribute, sublicense, and/or sell copies of the Software, and to permit persons to whom the Software is furnished to do

so, subject to the following conditions:

The above copyright notice and this permission notice shall be included in all copies or substantial portions of the Software.

THE SOFTWARE IS PROVIDED "AS IS", WITHOUT WARRANTY OF ANY KIND, EXPRESS OR IMPLIED, INCLUDING BUT NOT LIMITED TO THE WARRANTIES OF MERCHANTABILITY, FITNESS FOR A PARTICULAR PURPOSE AND NONINFRINGEMENT. IN NO EVENT SHALL THE AUTHORS OR COPYRIGHT HOLDERS BE LIABLE FOR ANY CLAIM, DAMAGES OR OTHER LIABILITY, WHETHER IN AN ACTION OF CONTRACT, TORT OR OTHERWISE, ARISING FROM, OUT OF OR IN CONNECTION WITH THE SOFTWARE OR THE USE OR OTHER DEALINGS IN THE SOFTWARE.

--- end of LICENSE ---

%% This notice is provided with respect to FontConfig 2.5, which may be included with JRE 8, JDK 8, and OpenJDK 8 source distributions on Linux and Solaris.

--- begin of LICENSE ---

Copyright c 2001,2003 Keith Packard

Permission to use, copy, modify, distribute, and sell this software and its documentation for any purpose is hereby granted without fee, provided that the above copyright notice appear in all copies and that both that copyright notice and this permission notice appear in supporting documentation, and that the name of Keith Packard not be used in advertising or publicity pertaining

to distribution of the software without specific, written prior permission.

Keith Packard makes no representations about the suitability of this software for any purpose. It is provided "as is" without express or implied warranty.

KEITH PACKARD DISCLAIMS ALL WARRANTIES WITH REGARD TO THIS SOFTWARE, INCLUDING ALL IMPLIED WARRANTIES OF MERCHANTABILITY AND FITNESS, IN NO EVENT SHALL KEITH PACKARD BE LIABLE FOR ANY SPECIAL, INDIRECT OR CONSEQUENTIAL DAMAGES OR ANY DAMAGES WHATSOEVER RESULTING FROM LOSS OF USE, DATA OR PROFITS, WHETHER IN AN ACTION OF CONTRACT, NEGLIGENCE OR OTHER TORTIOUS ACTION, ARISING OUT OF OR IN CONNECTION WITH THE USE OR PERFORMANCE OF THIS SOFTWARE.

--- end of LICENSE ---

%% This notice is provided with respect to IAIK PKCS#11 Wrapper, which may be included with JRE 8, JDK 8, and OpenJDK 8.

--- begin of LICENSE ---

IAIK PKCS#11 Wrapper License

Copyright (c) 2002 Graz University of Technology. All rights reserved.

Redistribution and use in source and binary forms, with or without modification, are permitted provided that the following conditions are met:

1. Redistributions of source code must retain the above copyright notice, this list of conditions and the following disclaimer.

2. Redistributions in binary form must reproduce the above copyright notice, this list of conditions and the following disclaimer in the documentation and/or other materials provided with the distribution.

3. The end-user documentation included with the redistribution, if any, must include the following acknowledgment:

"This product includes software developed by IAIK of Graz University of Technology."

Alternately, this acknowledgment may appear in the software itself, if and wherever such third-party acknowledgments normally appear.

4. The names "Graz University of Technology" and "IAIK of Graz University of Technology" must not be used to endorse or promote products derived from this software without prior written permission.

5. Products derived from this software may not be called "IAIK PKCS Wrapper", nor may "IAIK" appear in their name, without prior written permission of Graz University of Technology.

THIS SOFTWARE IS PROVIDED "AS IS" AND ANY EXPRESSED OR IMPLIED WARRANTIES, INCLUDING, BUT NOT LIMITED TO, THE IMPLIED WARRANTIES OF MERCHANTABILITY AND FITNESS FOR A PARTICULAR PURPOSE ARE DISCLAIMED. IN NO EVENT SHALL THE LICENSOR BE LIABLE FOR ANY DIRECT, INDIRECT, INCIDENTAL, SPECIAL, EXEMPLARY, OR CONSEQUENTIAL DAMAGES (INCLUDING, BUT NOT LIMITED TO, PROCUREMENT OF SUBSTITUTE GOODS OR SERVICES; LOSS OF USE, DATA, OR PROFITS; OR BUSINESS INTERRUPTION) HOWEVER CAUSED AND ON ANY THEORY OF LIABILITY, WHETHER IN CONTRACT, STRICT LIABILITY, OR TORT (INCLUDING NEGLIGENCE OR

OTHERWISE)

ARISING IN ANY WAY OUT OF THE USE OF THIS SOFTWARE, EVEN IF ADVISED
OF THE
POSSIBILITY OF SUCH DAMAGE.

--- end of LICENSE ---

%% This notice is provided with respect to ICU4C 4.0.1 and ICU4J 4.4, which
may be included with JRE 8, JDK 8, and OpenJDK 8.

--- begin of LICENSE ---

Copyright (c) 1995-2010 International Business Machines Corporation and others

All rights reserved.

Permission is hereby granted, free of charge, to any person obtaining a copy
of this software and associated documentation files (the "Software"), to deal
in the Software without restriction, including without limitation the rights
to use, copy, modify, merge, publish, distribute, and/or sell copies of the
Software, and to permit persons to whom the Software is furnished to do so,
provided that the above copyright notice(s) and this permission notice appear
in all copies of the Software and that both the above copyright notice(s) and
this permission notice appear in supporting documentation.

THE SOFTWARE IS PROVIDED "AS IS", WITHOUT WARRANTY OF ANY KIND,
EXPRESS OR
IMPLIED, INCLUDING BUT NOT LIMITED TO THE WARRANTIES OF
MERCHANTABILITY,
FITNESS FOR A PARTICULAR PURPOSE AND NONINFRINGEMENT OF THIRD
PARTY RIGHTS. IN
NO EVENT SHALL THE COPYRIGHT HOLDER OR HOLDERS INCLUDED IN THIS
NOTICE BE
LIABLE FOR ANY CLAIM, OR ANY SPECIAL INDIRECT OR CONSEQUENTIAL

DAMAGES, OR ANY
DAMAGES WHATSOEVER RESULTING FROM LOSS OF USE, DATA OR PROFITS,
WHETHER IN AN
ACTION OF CONTRACT, NEGLIGENCE OR OTHER TORTIOUS ACTION, ARISING
OUT OF OR IN
CONNECTION WITH THE USE OR PERFORMANCE OF THIS SOFTWARE.

Except as contained in this notice, the name of a copyright holder shall not
be used in advertising or otherwise to promote the sale, use or other dealings
in this Software without prior written authorization of the copyright holder.
All trademarks and registered trademarks mentioned herein are the property of
their respective owners.

--- end of LICENSE ---

%% This notice is provided with respect to IJG JPEG 6b, which may be
included with JRE 8, JDK 8, and OpenJDK 8.

--- begin of LICENSE ---

This software is copyright (C) 1991-1998, Thomas G. Lane.
All Rights Reserved except as specified below.

Permission is hereby granted to use, copy, modify, and distribute this
software (or portions thereof) for any purpose, without fee, subject to these
conditions:

- (1) If any part of the source code for this software is distributed, then this
README file must be included, with this copyright and no-warranty notice
unaltered; and any additions, deletions, or changes to the original files
must be clearly indicated in accompanying documentation.
- (2) If only executable code is distributed, then the accompanying
documentation must state that "this software is based in part on the work of
the Independent JPEG Group".
- (3) Permission for use of this software is granted only if the user accepts

full responsibility for any undesirable consequences; the authors accept NO LIABILITY for damages of any kind.

These conditions apply to any software derived from or based on the IJG code, not just to the unmodified library. If you use our work, you ought to acknowledge us.

Permission is NOT granted for the use of any IJG author's name or company name in advertising or publicity relating to this software or products derived from it. This software may be referred to only as "the Independent JPEG Group's software".

We specifically permit and encourage the use of this software as the basis of commercial products, provided that all warranty or liability claims are assumed by the product vendor.

--- end of LICENSE ---

%% This notice is provided with respect to Joni v1.1.9, which may be included with JRE 8, JDK 8, and OpenJDK 8.

--- begin of LICENSE ---

Permission is hereby granted, free of charge, to any person obtaining a copy of this software and associated documentation files (the "Software"), to deal in the Software without restriction, including without limitation the rights to use, copy, modify, merge, publish, distribute, sublicense, and/or sell copies of the Software, and to permit persons to whom the Software is furnished to do so, subject to the following conditions:

The above copyright notice and this permission notice shall be included in all copies or substantial portions of the Software.

THE SOFTWARE IS PROVIDED "AS IS", WITHOUT WARRANTY OF ANY KIND,

EXPRESS OR
IMPLIED, INCLUDING BUT NOT LIMITED TO THE WARRANTIES OF
MERCHANTABILITY,
FITNESS FOR A PARTICULAR PURPOSE AND NONINFRINGEMENT. IN NO
EVENT SHALL THE
AUTHORS OR COPYRIGHT HOLDERS BE LIABLE FOR ANY CLAIM, DAMAGES
OR OTHER
LIABILITY, WHETHER IN AN ACTION OF CONTRACT, TORT OR OTHERWISE,
ARISING FROM,
OUT OF OR IN CONNECTION WITH THE SOFTWARE OR THE USE OR OTHER
DEALINGS IN THE
SOFTWARE.

--- end of LICENSE ---

%% This notice is provided with respect to JOpt-Simple v3.0, which may be
included with JRE 8, JDK 8, and OpenJDK 8.

--- begin of LICENSE ---

Copyright (c) 2004-2009 Paul R. Holser, Jr.

Permission is hereby granted, free of charge, to any person obtaining
a copy of this software and associated documentation files (the
"Software"), to deal in the Software without restriction, including
without limitation the rights to use, copy, modify, merge, publish,
distribute, sublicense, and/or sell copies of the Software, and to
permit persons to whom the Software is furnished to do so, subject to
the following conditions:

The above copyright notice and this permission notice shall be
included in all copies or substantial portions of the Software.

THE SOFTWARE IS PROVIDED "AS IS", WITHOUT WARRANTY OF ANY KIND,

EXPRESS OR IMPLIED, INCLUDING BUT NOT LIMITED TO THE WARRANTIES
OF
MERCHANTABILITY, FITNESS FOR A PARTICULAR PURPOSE AND
NONINFRINGEMENT. IN NO EVENT SHALL THE AUTHORS OR COPYRIGHT
HOLDERS BE
LIABLE FOR ANY CLAIM, DAMAGES OR OTHER LIABILITY, WHETHER IN AN
ACTION
OF CONTRACT, TORT OR OTHERWISE, ARISING FROM, OUT OF OR IN
CONNECTION
WITH THE SOFTWARE OR THE USE OR OTHER DEALINGS IN THE SOFTWARE.

--- end of LICENSE ---

%% This notice is provided with respect to JSON, which may be included
with JRE 8 & JDK 8.

--- begin of LICENSE ---

Copyright (c) 2002 JSON.org

Permission is hereby granted, free of charge, to any person obtaining a copy
of this software and associated documentation files (the "Software"), to deal
in the Software without restriction, including without limitation the rights
to use, copy, modify, merge, publish, distribute, sublicense, and/or sell
copies of the Software, and to permit persons to whom the Software is
furnished to do so, subject to the following conditions:

The above copyright notice and this permission notice shall be included in all
copies or substantial portions of the Software.

The Software shall be used for Good, not Evil.

THE SOFTWARE IS PROVIDED "AS IS", WITHOUT WARRANTY OF ANY KIND,
EXPRESS OR

IMPLIED, INCLUDING BUT NOT LIMITED TO THE WARRANTIES OF
MERCHANTABILITY,
FITNESS FOR A PARTICULAR PURPOSE AND NONINFRINGEMENT. IN NO
EVENT SHALL THE
AUTHORS OR COPYRIGHT HOLDERS BE LIABLE FOR ANY CLAIM, DAMAGES
OR OTHER
LIABILITY, WHETHER IN AN ACTION OF CONTRACT, TORT OR OTHERWISE,
ARISING FROM,
OUT OF OR IN CONNECTION WITH THE SOFTWARE OR THE USE OR OTHER
DEALINGS IN THE
SOFTWARE.

--- end of LICENSE ---

%% This notice is provided with respect to Kerberos functionality, which
which may be included with JRE 8, JDK 8, and OpenJDK 8.

--- begin of LICENSE ---

(C) Copyright IBM Corp. 1999 All Rights Reserved.
Copyright 1997 The Open Group Research Institute. All rights reserved.

--- end of LICENSE ---

%% This notice is provided with respect to Kerberos functionality from
FundsXpress, INC., which may be included with JRE 8, JDK 8, and OpenJDK 8.

--- begin of LICENSE ---

Copyright (C) 1998 by the FundsXpress, INC.

All rights reserved.

Export of this software from the United States of America may require a specific license from the United States Government. It is the responsibility of any person or organization contemplating export to obtain such a license before exporting.

WITHIN THAT CONSTRAINT, permission to use, copy, modify, and distribute this software and its documentation for any purpose and without fee is hereby granted, provided that the above copyright notice appear in all copies and that both that copyright notice and this permission notice appear in supporting documentation, and that the name of FundsXpress. not be used in advertising or publicity pertaining to distribution of the software without specific, written prior permission. FundsXpress makes no representations about the suitability of this software for any purpose. It is provided "as is" without express or implied warranty.

THIS SOFTWARE IS PROVIDED ``AS IS" AND WITHOUT ANY EXPRESS OR IMPLIED WARRANTIES, INCLUDING, WITHOUT LIMITATION, THE IMPLIED WARRANTIES OF MERCHANTABILITY AND FITNESS FOR A PARTICULAR PURPOSE.

--- end of LICENSE ---

%% This notice is provided with respect to Kronos OpenGL headers, which may be included with JDK 8 and OpenJDK 8 source distributions.

--- begin of LICENSE ---

Copyright (c) 2007 The Khronos Group Inc.

Permission is hereby granted, free of charge, to any person obtaining a copy of this software and/or associated documentation files (the "Materials"), to

deal in the Materials without restriction, including without limitation the rights to use, copy, modify, merge, publish, distribute, sublicense, and/or sell copies of the Materials, and to permit persons to whom the Materials are furnished to do so, subject to the following conditions:

The above copyright notice and this permission notice shall be included in all copies or substantial portions of the Materials.

THE MATERIALS ARE PROVIDED "AS IS", WITHOUT WARRANTY OF ANY KIND, EXPRESS OR IMPLIED, INCLUDING BUT NOT LIMITED TO THE WARRANTIES OF MERCHANTABILITY, FITNESS FOR A PARTICULAR PURPOSE AND NONINFRINGEMENT. IN NO EVENT SHALL THE AUTHORS OR COPYRIGHT HOLDERS BE LIABLE FOR ANY CLAIM, DAMAGES OR OTHER LIABILITY, WHETHER IN AN ACTION OF CONTRACT, TORT OR OTHERWISE, ARISING FROM, OUT OF OR IN CONNECTION WITH THE MATERIALS OR THE USE OR OTHER DEALINGS IN THE MATERIALS.

--- end of LICENSE ---

%% Portions Copyright Eastman Kodak Company 1992

%% This notice is provided with respect to libpng 1.5.4, which may be included with JRE 8, JDK 8, and OpenJDK 8.

--- begin of LICENSE ---

This copy of the libpng notices is provided for your convenience. In case of

any discrepancy between this copy and the notices in the file png.h that is included in the libpng distribution, the latter shall prevail.

COPYRIGHT NOTICE, DISCLAIMER, and LICENSE:

If you modify libpng you may insert additional notices immediately following this sentence.

This code is released under the libpng license.

libpng versions 1.2.6, August 15, 2004, through 1.5.4, July 7, 2011, are Copyright (c) 2004, 2006-2011 Glenn Randers-Pehrson, and are distributed according to the same disclaimer and license as libpng-1.2.5 with the following individual added to the list of Contributing Authors

Cosmin Truta

libpng versions 1.0.7, July 1, 2000, through 1.2.5 - October 3, 2002, are Copyright (c) 2000-2002 Glenn Randers-Pehrson, and are distributed according to the same disclaimer and license as libpng-1.0.6 with the following individuals added to the list of Contributing Authors

Simon-Pierre Cadieux

Eric S. Raymond

Gilles Vollant

and with the following additions to the disclaimer:

There is no warranty against interference with your enjoyment of the library or against infringement. There is no warranty that our efforts or the library will fulfill any of your particular purposes or needs. This library is provided with all faults, and the entire risk of satisfactory quality, performance, accuracy, and effort is with the user.

libpng versions 0.97, January 1998, through 1.0.6, March 20, 2000, are

Copyright (c) 1998, 1999 Glenn Randers-Pehrson, and are distributed according to the same disclaimer and license as libpng-0.96, with the following individuals added to the list of Contributing Authors:

Tom Lane
Glenn Randers-Pehrson
Willem van Schaik

libpng versions 0.89, June 1996, through 0.96, May 1997, are Copyright (c) 1996, 1997 Andreas Dilger
Distributed according to the same disclaimer and license as libpng-0.88, with the following individuals added to the list of Contributing Authors:

John Bowler
Kevin Bracey
Sam Bushell
Magnus Holmgren
Greg Roelofs
Tom Tanner

libpng versions 0.5, May 1995, through 0.88, January 1996, are Copyright (c) 1995, 1996 Guy Eric Schalnat, Group 42, Inc.

For the purposes of this copyright and license, "Contributing Authors" is defined as the following set of individuals:

Andreas Dilger
Dave Martindale
Guy Eric Schalnat
Paul Schmidt
Tim Wegner

The PNG Reference Library is supplied "AS IS". The Contributing Authors and Group 42, Inc. disclaim all warranties, expressed or implied, including, without limitation, the warranties of merchantability and of fitness for any purpose. The Contributing Authors and Group 42, Inc.

assume no liability for direct, indirect, incidental, special, exemplary, or consequential damages, which may result from the use of the PNG Reference Library, even if advised of the possibility of such damage.

Permission is hereby granted to use, copy, modify, and distribute this source code, or portions hereof, for any purpose, without fee, subject to the following restrictions:

1. The origin of this source code must not be misrepresented.
2. Altered versions must be plainly marked as such and must not be misrepresented as being the original source.
3. This Copyright notice may not be removed or altered from any source or altered source distribution.

The Contributing Authors and Group 42, Inc. specifically permit, without fee, and encourage the use of this source code as a component to supporting the PNG file format in commercial products. If you use this source code in a product, acknowledgment is not required but would be appreciated.

A "png_get_copyright" function is available, for convenient use in "about" boxes and the like:

```
printf("%s",png_get_copyright(NULL));
```

Also, the PNG logo (in PNG format, of course) is supplied in the files "pngbar.png" and "pngbar.jpg (88x31) and "pngnow.png" (98x31).

Libpng is OSI Certified Open Source Software. OSI Certified Open Source is a certification mark of the Open Source Initiative.

Glenn Randers-Pehrson
glennrp at users.sourceforge.net

July 7, 2011

--- end of LICENSE ---

%% This notice is provided with respect to libungif 4.1.3, which may be included with JRE 8, JDK 8, and OpenJDK 8.

--- begin of LICENSE ---

The GIFLIB distribution is Copyright (c) 1997 Eric S. Raymond

Permission is hereby granted, free of charge, to any person obtaining a copy of this software and associated documentation files (the "Software"), to deal in the Software without restriction, including without limitation the rights to use, copy, modify, merge, publish, distribute, sublicense, and/or sell copies of the Software, and to permit persons to whom the Software is furnished to do so, subject to the following conditions:

The above copyright notice and this permission notice shall be included in all copies or substantial portions of the Software.

THE SOFTWARE IS PROVIDED "AS IS", WITHOUT WARRANTY OF ANY KIND, EXPRESS OR IMPLIED, INCLUDING BUT NOT LIMITED TO THE WARRANTIES OF MERCHANTABILITY, FITNESS FOR A PARTICULAR PURPOSE AND NONINFRINGEMENT. IN NO EVENT SHALL THE AUTHORS OR COPYRIGHT HOLDERS BE LIABLE FOR ANY CLAIM, DAMAGES OR OTHER LIABILITY, WHETHER IN AN ACTION OF CONTRACT, TORT OR OTHERWISE, ARISING FROM, OUT OF OR IN CONNECTION WITH THE SOFTWARE OR THE USE OR OTHER DEALINGS IN THE SOFTWARE.

--- end of LICENSE ---

%% This notice is provided with respect to Little CMS 2.5, which may be included with JRE 8, JDK 8, and OpenJDK 8.

--- begin of LICENSE ---

Little CMS
Copyright (c) 1998-2011 Marti Maria Saguer

Permission is hereby granted, free of charge, to any person obtaining a copy of this software and associated documentation files (the "Software"), to deal in the Software without restriction, including without limitation the rights to use, copy, modify, merge, publish, distribute, sublicense, and/or sell copies of the Software, and to permit persons to whom the Software is furnished to do so, subject to the following conditions:

The above copyright notice and this permission notice shall be included in all copies or substantial portions of the Software.

THE SOFTWARE IS PROVIDED "AS IS", WITHOUT WARRANTY OF ANY KIND, EXPRESS OR IMPLIED, INCLUDING BUT NOT LIMITED TO THE WARRANTIES OF MERCHANTABILITY, FITNESS FOR A PARTICULAR PURPOSE AND NONINFRINGEMENT. IN NO EVENT SHALL THE AUTHORS OR COPYRIGHT HOLDERS BE LIABLE FOR ANY CLAIM, DAMAGES OR OTHER LIABILITY, WHETHER IN AN ACTION OF CONTRACT, TORT OR OTHERWISE, ARISING FROM, OUT OF OR IN CONNECTION WITH THE SOFTWARE OR THE USE OR OTHER DEALINGS IN THE SOFTWARE.

--- end of LICENSE ---

%% Lucida is a registered trademark or trademark of Bigelow & Holmes in the
U.S. and other countries.

%% This notice is provided with respect to Mesa 3D Graphics Library v4.1,
which may be included with JRE 8, JDK 8, and OpenJDK 8 source distributions.

--- begin of LICENSE ---

Mesa 3-D graphics library
Version: 4.1

Copyright (C) 1999-2002 Brian Paul All Rights Reserved.

Permission is hereby granted, free of charge, to any person obtaining a
copy of this software and associated documentation files (the "Software"),
to deal in the Software without restriction, including without limitation
the rights to use, copy, modify, merge, publish, distribute, sublicense,
and/or sell copies of the Software, and to permit persons to whom the
Software is furnished to do so, subject to the following conditions:

The above copyright notice and this permission notice shall be included
in all copies or substantial portions of the Software.

THE SOFTWARE IS PROVIDED "AS IS", WITHOUT WARRANTY OF ANY KIND,
EXPRESS
OR IMPLIED, INCLUDING BUT NOT LIMITED TO THE WARRANTIES OF
MERCHANTABILITY,
FITNESS FOR A PARTICULAR PURPOSE AND NONINFRINGEMENT. IN NO
EVENT SHALL

BRIAN PAUL BE LIABLE FOR ANY CLAIM, DAMAGES OR OTHER LIABILITY,
WHETHER IN
AN ACTION OF CONTRACT, TORT OR OTHERWISE, ARISING FROM, OUT OF OR
IN
CONNECTION WITH THE SOFTWARE OR THE USE OR OTHER DEALINGS IN
THE SOFTWARE.

--- end of LICENSE ---

%% This notice is provided with respect to Mozilla Network Security
Services (NSS), which is supplied with the JDK test suite in the OpenJDK
source code repository. It is licensed under Mozilla Public License (MPL),
version 2.0.

The NSS libraries are supplied in executable form, built from unmodified
NSS source code labeled with the "NSS_3.13.1_RTM" release tag.

The NSS source code is available in the OpenJDK source code repository at:
jdk/test/sun/security/pkcs11/nss/src

The NSS libraries are available in the OpenJDK source code repository at:
jdk/test/sun/security/pkcs11/nss/lib

--- begin of LICENSE ---

Mozilla Public License Version 2.0

=====

1. Definitions

1.1. "Contributor"

means each individual or legal entity that creates, contributes to
the creation of, or owns Covered Software.

1.2. "Contributor Version"

means the combination of the Contributions of others (if any) used by a Contributor and that particular Contributor's Contribution.

1.3. "Contribution"

means Covered Software of a particular Contributor.

1.4. "Covered Software"

means Source Code Form to which the initial Contributor has attached the notice in Exhibit A, the Executable Form of such Source Code Form, and Modifications of such Source Code Form, in each case including portions thereof.

1.5. "Incompatible With Secondary Licenses"

means

(a) that the initial Contributor has attached the notice described in Exhibit B to the Covered Software; or

(b) that the Covered Software was made available under the terms of version 1.1 or earlier of the License, but not also under the terms of a Secondary License.

1.6. "Executable Form"

means any form of the work other than Source Code Form.

1.7. "Larger Work"

means a work that combines Covered Software with other material, in a separate file or files, that is not Covered Software.

1.8. "License"

means this document.

1.9. "Licensable"

means having the right to grant, to the maximum extent possible,

whether at the time of the initial grant or subsequently, any and all of the rights conveyed by this License.

1.10. "Modifications"

means any of the following:

(a) any file in Source Code Form that results from an addition to, deletion from, or modification of the contents of Covered Software; or

(b) any new file in Source Code Form that contains any Covered Software.

1.11. "Patent Claims" of a Contributor

means any patent claim(s), including without limitation, method, process, and apparatus claims, in any patent Licensable by such Contributor that would be infringed, but for the grant of the License, by the making, using, selling, offering for sale, having made, import, or transfer of either its Contributions or its Contributor Version.

1.12. "Secondary License"

means either the GNU General Public License, Version 2.0, the GNU Lesser General Public License, Version 2.1, the GNU Affero General Public License, Version 3.0, or any later versions of those licenses.

1.13. "Source Code Form"

means the form of the work preferred for making modifications.

1.14. "You" (or "Your")

means an individual or a legal entity exercising rights under this License. For legal entities, "You" includes any entity that controls, is controlled by, or is under common control with You. For purposes of this definition, "control" means (a) the power, direct or indirect, to cause the direction or management of such entity,

whether by contract or otherwise, or (b) ownership of more than fifty percent (50%) of the outstanding shares or beneficial ownership of such entity.

2. License Grants and Conditions

2.1. Grants

Each Contributor hereby grants You a world-wide, royalty-free, non-exclusive license:

- (a) under intellectual property rights (other than patent or trademark) Licensable by such Contributor to use, reproduce, make available, modify, display, perform, distribute, and otherwise exploit its Contributions, either on an unmodified basis, with Modifications, or as part of a Larger Work; and
- (b) under Patent Claims of such Contributor to make, use, sell, offer for sale, have made, import, and otherwise transfer either its Contributions or its Contributor Version.

2.2. Effective Date

The licenses granted in Section 2.1 with respect to any Contribution become effective for each Contribution on the date the Contributor first distributes such Contribution.

2.3. Limitations on Grant Scope

The licenses granted in this Section 2 are the only rights granted under this License. No additional rights or licenses will be implied from the distribution or licensing of Covered Software under this License. Notwithstanding Section 2.1(b) above, no patent license is granted by a Contributor:

(a) for any code that a Contributor has removed from Covered Software;
or

(b) for infringements caused by: (i) Your and any other third party's modifications of Covered Software, or (ii) the combination of its Contributions with other software (except as part of its Contributor Version); or

(c) under Patent Claims infringed by Covered Software in the absence of its Contributions.

This License does not grant any rights in the trademarks, service marks, or logos of any Contributor (except as may be necessary to comply with the notice requirements in Section 3.4).

2.4. Subsequent Licenses

No Contributor makes additional grants as a result of Your choice to distribute the Covered Software under a subsequent version of this License (see Section 10.2) or under the terms of a Secondary License (if permitted under the terms of Section 3.3).

2.5. Representation

Each Contributor represents that the Contributor believes its Contributions are its original creation(s) or it has sufficient rights to grant the rights to its Contributions conveyed by this License.

2.6. Fair Use

This License is not intended to limit any rights You have under applicable copyright doctrines of fair use, fair dealing, or other equivalents.

2.7. Conditions

Sections 3.1, 3.2, 3.3, and 3.4 are conditions of the licenses granted in Section 2.1.

3. Responsibilities

3.1. Distribution of Source Form

All distribution of Covered Software in Source Code Form, including any Modifications that You create or to which You contribute, must be under the terms of this License. You must inform recipients that the Source Code Form of the Covered Software is governed by the terms of this License, and how they can obtain a copy of this License. You may not attempt to alter or restrict the recipients' rights in the Source Code Form.

3.2. Distribution of Executable Form

If You distribute Covered Software in Executable Form then:

- (a) such Covered Software must also be made available in Source Code Form, as described in Section 3.1, and You must inform recipients of the Executable Form how they can obtain a copy of such Source Code Form by reasonable means in a timely manner, at a charge no more than the cost of distribution to the recipient; and
- (b) You may distribute such Executable Form under the terms of this License, or sublicense it under different terms, provided that the license for the Executable Form does not attempt to limit or alter the recipients' rights in the Source Code Form under this License.

3.3. Distribution of a Larger Work

You may create and distribute a Larger Work under terms of Your choice, provided that You also comply with the requirements of this License for the Covered Software. If the Larger Work is a combination of Covered

Software with a work governed by one or more Secondary Licenses, and the Covered Software is not Incompatible With Secondary Licenses, this License permits You to additionally distribute such Covered Software under the terms of such Secondary License(s), so that the recipient of the Larger Work may, at their option, further distribute the Covered Software under the terms of either this License or such Secondary License(s).

3.4. Notices

You may not remove or alter the substance of any license notices (including copyright notices, patent notices, disclaimers of warranty, or limitations of liability) contained within the Source Code Form of the Covered Software, except that You may alter any license notices to the extent required to remedy known factual inaccuracies.

3.5. Application of Additional Terms

You may choose to offer, and to charge a fee for, warranty, support, indemnity or liability obligations to one or more recipients of Covered Software. However, You may do so only on Your own behalf, and not on behalf of any Contributor. You must make it absolutely clear that any such warranty, support, indemnity, or liability obligation is offered by You alone, and You hereby agree to indemnify every Contributor for any liability incurred by such Contributor as a result of warranty, support, indemnity or liability terms You offer. You may include additional disclaimers of warranty and limitations of liability specific to any jurisdiction.

4. Inability to Comply Due to Statute or Regulation

If it is impossible for You to comply with any of the terms of this License with respect to some or all of the Covered Software due to statute, judicial order, or regulation then You must: (a) comply with the terms of this License to the maximum extent possible; and (b)

describe the limitations and the code they affect. Such description must be placed in a text file included with all distributions of the Covered Software under this License. Except to the extent prohibited by statute or regulation, such description must be sufficiently detailed for a recipient of ordinary skill to be able to understand it.

5. Termination

5.1. The rights granted under this License will terminate automatically if You fail to comply with any of its terms. However, if You become compliant, then the rights granted under this License from a particular Contributor are reinstated (a) provisionally, unless and until such Contributor explicitly and finally terminates Your grants, and (b) on an ongoing basis, if such Contributor fails to notify You of the non-compliance by some reasonable means prior to 60 days after You have come back into compliance. Moreover, Your grants from a particular Contributor are reinstated on an ongoing basis if such Contributor notifies You of the non-compliance by some reasonable means, this is the first time You have received notice of non-compliance with this License from such Contributor, and You become compliant prior to 30 days after Your receipt of the notice.

5.2. If You initiate litigation against any entity by asserting a patent infringement claim (excluding declaratory judgment actions, counter-claims, and cross-claims) alleging that a Contributor Version directly or indirectly infringes any patent, then the rights granted to You by any and all Contributors for the Covered Software under Section 2.1 of this License shall terminate.

5.3. In the event of termination under Sections 5.1 or 5.2 above, all end user license agreements (excluding distributors and resellers) which have been validly granted by You or Your distributors under this License prior to termination shall survive termination.

* *
* 6. Disclaimer of Warranty *
* ----- *

* *
* Covered Software is provided under this License on an "as is" *
* basis, without warranty of any kind, either expressed, implied, or *
* statutory, including, without limitation, warranties that the *
* Covered Software is free of defects, merchantable, fit for a *
* particular purpose or non-infringing. The entire risk as to the *
* quality and performance of the Covered Software is with You. *
* Should any Covered Software prove defective in any respect, You *
* (not any Contributor) assume the cost of any necessary servicing, *
* repair, or correction. This disclaimer of warranty constitutes an *
* essential part of this License. No use of any Covered Software is *
* authorized under this License except under this disclaimer. *
* *

* *
* 7. Limitation of Liability *
* ----- *

* *
* Under no circumstances and under no legal theory, whether tort *
* (including negligence), contract, or otherwise, shall any *
* Contributor, or anyone who distributes Covered Software as *
* permitted above, be liable to You for any direct, indirect, *
* special, incidental, or consequential damages of any character *
* including, without limitation, damages for lost profits, loss of *
* goodwill, work stoppage, computer failure or malfunction, or any *
* and all other commercial damages or losses, even if such party *
* shall have been informed of the possibility of such damages. This *
* limitation of liability shall not apply to liability for death or *
* personal injury resulting from such party's negligence to the *
* extent applicable law prohibits such limitation. Some *
* jurisdictions do not allow the exclusion or limitation of *

* incidental or consequential damages, so this exclusion and *
* limitation may not apply to You. *
* *

8. Litigation

Any litigation relating to this License may be brought only in the courts of a jurisdiction where the defendant maintains its principal place of business and such litigation shall be governed by laws of that jurisdiction, without reference to its conflict-of-law provisions. Nothing in this Section shall prevent a party's ability to bring cross-claims or counter-claims.

9. Miscellaneous

This License represents the complete agreement concerning the subject matter hereof. If any provision of this License is held to be unenforceable, such provision shall be reformed only to the extent necessary to make it enforceable. Any law or regulation which provides that the language of a contract shall be construed against the drafter shall not be used to construe this License against a Contributor.

10. Versions of the License

10.1. New Versions

Mozilla Foundation is the license steward. Except as provided in Section 10.3, no one other than the license steward has the right to modify or publish new versions of this License. Each version will be given a distinguishing version number.

10.2. Effect of New Versions

You may distribute the Covered Software under the terms of the version of the License under which You originally received the Covered Software, or under the terms of any subsequent version published by the license steward.

10.3. Modified Versions

If you create software not governed by this License, and you want to create a new license for such software, you may create and use a modified version of this License if you rename the license and remove any references to the name of the license steward (except to note that such modified license differs from this License).

10.4. Distributing Source Code Form that is Incompatible With Secondary Licenses

If You choose to distribute Source Code Form that is Incompatible With Secondary Licenses under the terms of this version of the License, the notice described in Exhibit B of this License must be attached.

Exhibit A - Source Code Form License Notice

This Source Code Form is subject to the terms of the Mozilla Public License, v. 2.0. If a copy of the MPL was not distributed with this file, You can obtain one at <http://mozilla.org/MPL/2.0/>.

If it is not possible or desirable to put the notice in a particular file, then You may include the notice in a location (such as a LICENSE file in a relevant directory) where a recipient would be likely to look for such a notice.

You may add additional accurate notices of copyright ownership.

Exhibit B - "Incompatible With Secondary Licenses" Notice

This Source Code Form is "Incompatible With Secondary Licenses", as defined by the Mozilla Public License, v. 2.0.

--- end of LICENSE ---

%% This notice is provided with respect to PC/SC Lite for Suse Linux v.1.1.1, which may be included with JRE 8, JDK 8, and OpenJDK 8 on Linux and Solaris.

--- begin of LICENSE ---

Copyright (c) 1999-2004 David Corcoran <corcoran@linuxnet.com>
Copyright (c) 1999-2004 Ludovic Rousseau <ludovic.rousseau (at) free.fr>
All rights reserved.

Redistribution and use in source and binary forms, with or without modification, are permitted provided that the following conditions are met:

1. Redistributions of source code must retain the above copyright notice, this list of conditions and the following disclaimer.
2. Redistributions in binary form must reproduce the above copyright notice, this list of conditions and the following disclaimer in the documentation and/or other materials provided with the distribution.
3. All advertising materials mentioning features or use of this software must display the following acknowledgement:
 This product includes software developed by:
 David Corcoran <corcoran@linuxnet.com>
 <http://www.linuxnet.com> (MUSCLE)
4. The name of the author may not be used to endorse or promote products derived from this software without specific prior written permission.

Changes to this license can be made only by the copyright author with

explicit written consent.

THIS SOFTWARE IS PROVIDED BY THE AUTHOR ``AS IS" AND ANY EXPRESS OR IMPLIED WARRANTIES, INCLUDING, BUT NOT LIMITED TO, THE IMPLIED WARRANTIES

OF MERCHANTABILITY AND FITNESS FOR A PARTICULAR PURPOSE ARE DISCLAIMED.

IN NO EVENT SHALL THE AUTHOR BE LIABLE FOR ANY DIRECT, INDIRECT, INCIDENTAL, SPECIAL, EXEMPLARY, OR CONSEQUENTIAL DAMAGES (INCLUDING, BUT

NOT LIMITED TO, PROCUREMENT OF SUBSTITUTE GOODS OR SERVICES; LOSS OF USE,

DATA, OR PROFITS; OR BUSINESS INTERRUPTION) HOWEVER CAUSED AND ON ANY

THEORY OF LIABILITY, WHETHER IN CONTRACT, STRICT LIABILITY, OR TORT (INCLUDING NEGLIGENCE OR OTHERWISE) ARISING IN ANY WAY OUT OF THE USE OF

THIS SOFTWARE, EVEN IF ADVISED OF THE POSSIBILITY OF SUCH DAMAGE.

--- end of LICENSE ---

%% This notice is provided with respect to PorterStemmer v4, which may be included with JRE 8, JDK 8, and OpenJDK 8.

--- begin of LICENSE ---

See: <http://tartarus.org/~martin/PorterStemmer>

The software is completely free for any purpose, unless notes at the head of the program text indicates otherwise (which is rare). In any case, the notes about licensing are never more restrictive than the BSD License.

In every case where the software is not written by me (Martin Porter), this licensing arrangement has been endorsed by the contributor, and it is

therefore unnecessary to ask the contributor again to confirm it.

I have not asked any contributors (or their employers, if they have them) for proofs that they have the right to distribute their software in this way.

--- end of LICENSE ---

%% This notice is provided with respect to Relax NG Object/Parser v.20050510,
which may be included with JRE 8, JDK 8, and OpenJDK 8.

--- begin of LICENSE ---

Copyright (c) Kohsuke Kawaguchi

Permission is hereby granted, free of charge, to any person obtaining a copy of this software and associated documentation files (the "Software"), to deal in the Software without restriction, including without limitation the rights to use, copy, modify, merge, publish, distribute, sublicense, and/or sell copies of the Software, and to permit persons to whom the Software is furnished to do so, subject to the following conditions: The above copyright notice and this permission notice shall be included in all copies or substantial portions of the Software.

THE SOFTWARE IS PROVIDED "AS IS", WITHOUT WARRANTY OF ANY KIND, EXPRESS OR IMPLIED, INCLUDING BUT NOT LIMITED TO THE WARRANTIES OF MERCHANTABILITY, FITNESS FOR A PARTICULAR PURPOSE AND NONINFRINGEMENT. IN NO EVENT SHALL THE AUTHORS OR COPYRIGHT HOLDERS BE LIABLE FOR ANY CLAIM, DAMAGES OR OTHER LIABILITY, WHETHER IN AN ACTION OF CONTRACT, TORT OR OTHERWISE, ARISING FROM, OUT OF OR IN CONNECTION WITH THE SOFTWARE OR THE USE OR OTHER

DEALINGS IN THE
SOFTWARE.

--- end of LICENSE ---

%% This notice is provided with respect to RelaxNGCC v1.12, which may be
included with JRE 8, JDK 8, and OpenJDK 8.

--- begin of LICENSE ---

Copyright (c) 2000-2003 Daisuke Okajima and Kohsuke Kawaguchi.
All rights reserved.

Redistribution and use in source and binary forms, with or without
modification, are permitted provided that the following conditions are met:

1. Redistributions of source code must retain the above copyright notice, this
list of conditions and the following disclaimer.
2. Redistributions in binary form must reproduce the above copyright notice,
this list of conditions and the following disclaimer in the documentation
and/or other materials provided with the distribution.
3. The end-user documentation included with the redistribution, if any, must
include the following acknowledgment:

"This product includes software developed by Daisuke Okajima
and Kohsuke Kawaguchi (<http://relaxngcc.sf.net/>)."

Alternately, this acknowledgment may appear in the software itself, if and
wherever such third-party acknowledgments normally appear.

4. The names of the copyright holders must not be used to endorse or promote
products derived from this software without prior written permission. For

written permission, please contact the copyright holders.

5. Products derived from this software may not be called "RELAXNGCC", nor may "RELAXNGCC" appear in their name, without prior written permission of the copyright holders.

THIS SOFTWARE IS PROVIDED "AS IS" AND ANY EXPRESSED OR IMPLIED WARRANTIES, INCLUDING, BUT NOT LIMITED TO, THE IMPLIED WARRANTIES OF MERCHANTABILITY AND FITNESS FOR A PARTICULAR PURPOSE ARE DISCLAIMED. IN NO EVENT SHALL THE APACHE SOFTWARE FOUNDATION OR ITS CONTRIBUTORS BE LIABLE FOR ANY DIRECT, INDIRECT, INCIDENTAL, SPECIAL, EXEMPLARY, OR CONSEQUENTIAL DAMAGES (INCLUDING, BUT NOT LIMITED TO, PROCUREMENT OF SUBSTITUTE GOODS OR SERVICES; LOSS OF USE, DATA, OR PROFITS; OR BUSINESS INTERRUPTION) HOWEVER CAUSED AND ON ANY THEORY OF LIABILITY, WHETHER IN CONTRACT, STRICT LIABILITY, OR TORT (INCLUDING NEGLIGENCE OR OTHERWISE) ARISING IN ANY WAY OUT OF THE USE OF THIS SOFTWARE, EVEN IF ADVISED OF THE POSSIBILITY OF SUCH DAMAGE.

--- end of LICENSE ---

%% This notice is provided with respect to SAX 2.0.1, which may be included with JRE 8, JDK 8, and OpenJDK 8.

--- begin of LICENSE ---

SAX is free!

In fact, it's not possible to own a license to SAX, since it's been placed in the public domain.

No Warranty

Because SAX is released to the public domain, there is no warranty for the design or for the software implementation, to the extent permitted by applicable law. Except when otherwise stated in writing the copyright holders and/or other parties provide SAX "as is" without warranty of any kind, either expressed or implied, including, but not limited to, the implied warranties of merchantability and fitness for a particular purpose. The entire risk as to the quality and performance of SAX is with you. Should SAX prove defective, you assume the cost of all necessary servicing, repair or correction.

In no event unless required by applicable law or agreed to in writing will any copyright holder, or any other party who may modify and/or redistribute SAX, be liable to you for damages, including any general, special, incidental or consequential damages arising out of the use or inability to use SAX (including but not limited to loss of data or data being rendered inaccurate or losses sustained by you or third parties or a failure of the SAX to operate with any other programs), even if such holder or other party has been advised of the possibility of such damages.

Copyright Disclaimers

This page includes statements to that effect by David Megginson, who would have been able to claim copyright for the original work. SAX 1.0

Version 1.0 of the Simple API for XML (SAX), created collectively by the membership of the XML-DEV mailing list, is hereby released into the public domain.

No one owns SAX: you may use it freely in both commercial and non-commercial applications, bundle it with your software distribution, include it on a CD-ROM, list the source code in a book, mirror the documentation at your own

web site, or use it in any other way you see fit.

David Megginson, sax@megginson.com

1998-05-11

SAX 2.0

I hereby abandon any property rights to SAX 2.0 (the Simple API for XML), and release all of the SAX 2.0 source code, compiled code, and documentation contained in this distribution into the Public Domain. SAX comes with NO WARRANTY or guarantee of fitness for any purpose.

David Megginson, david@megginson.com

2000-05-05

--- end of LICENSE ---

%% This notice is provided with respect to SoftFloat version 2b, which may be included with JRE 8, JDK 8, and OpenJDK 8 on Linux/ARM.

--- begin of LICENSE ---

Use of any of this software is governed by the terms of the license below:

SoftFloat was written by me, John R. Hauser. This work was made possible in part by the International Computer Science Institute, located at Suite 600, 1947 Center Street, Berkeley, California 94704. Funding was partially provided by the National Science Foundation under grant MIP-9311980. The original version of this code was written as part of a project to build a fixed-point vector processor in collaboration with the University of California at Berkeley, overseen by Profs. Nelson Morgan and John Wawrzynek.

THIS SOFTWARE IS DISTRIBUTED AS IS, FOR FREE. Although reasonable effort has been made to avoid it, THIS SOFTWARE MAY CONTAIN FAULTS THAT WILL AT

TIMES RESULT IN INCORRECT BEHAVIOR. USE OF THIS SOFTWARE IS RESTRICTED TO PERSONS AND ORGANIZATIONS WHO CAN AND WILL TAKE FULL RESPONSIBILITY FOR ALL LOSSES, COSTS, OR OTHER PROBLEMS THEY INCUR DUE TO THE SOFTWARE, AND WHO FURTHERMORE EFFECTIVELY INDEMNIFY JOHN HAUSER AND THE INTERNATIONAL COMPUTER SCIENCE INSTITUTE (possibly via similar legal warning) AGAINST ALL LOSSES, COSTS, OR OTHER PROBLEMS INCURRED BY THEIR CUSTOMERS AND CLIENTS DUE TO THE SOFTWARE.

Derivative works are acceptable, even for commercial purposes, provided that the minimal documentation requirements stated in the source code are satisfied.

--- end of LICENSE ---

%% This notice is provided with respect to Sparkle 1.5,
which may be included with JRE 8 on Mac OS X.

--- begin of LICENSE ---

Copyright (c) 2012 Sparkle.org and Andy Matuschak

Permission is hereby granted, free of charge, to any person obtaining a copy of this software and associated documentation files (the "Software"), to deal in the Software without restriction, including without limitation the rights to use, copy, modify, merge, publish, distribute, sublicense, and/or sell copies of the Software, and to permit persons to whom the Software is furnished to do so, subject to the following conditions:

The above copyright notice and this permission notice shall be included in all

copies or substantial portions of the Software.

THE SOFTWARE IS PROVIDED "AS IS", WITHOUT WARRANTY OF ANY KIND,
EXPRESS OR
IMPLIED, INCLUDING BUT NOT LIMITED TO THE WARRANTIES OF
MERCHANTABILITY,
FITNESS FOR A PARTICULAR PURPOSE AND NONINFRINGEMENT. IN NO
EVENT SHALL THE
AUTHORS OR COPYRIGHT HOLDERS BE LIABLE FOR ANY CLAIM, DAMAGES
OR OTHER
LIABILITY, WHETHER IN AN ACTION OF CONTRACT, TORT OR OTHERWISE,
ARISING FROM,
OUT OF OR IN CONNECTION WITH THE SOFTWARE OR THE USE OR OTHER
DEALINGS IN THE
SOFTWARE.

--- end of LICENSE ---

%% Portions licensed from Taligent, Inc.

%% This notice is provided with respect to Thai Dictionary, which may be
included with JRE 8, JDK 8, and OpenJDK 8.

--- begin of LICENSE ---

Copyright (C) 1982 The Royal Institute, Thai Royal Government.

Copyright (C) 1998 National Electronics and Computer Technology Center,
National Science and Technology Development Agency,
Ministry of Science Technology and Environment,
Thai Royal Government.

Permission is hereby granted, free of charge, to any person obtaining a copy of this software and associated documentation files (the "Software"), to deal in the Software without restriction, including without limitation the rights to use, copy, modify, merge, publish, distribute, sublicense, and/or sell copies of the Software, and to permit persons to whom the Software is furnished to do so, subject to the following conditions:

The above copyright notice and this permission notice shall be included in all copies or substantial portions of the Software.

THE SOFTWARE IS PROVIDED "AS IS", WITHOUT WARRANTY OF ANY KIND, EXPRESS OR IMPLIED, INCLUDING BUT NOT LIMITED TO THE WARRANTIES OF MERCHANTABILITY, FITNESS FOR A PARTICULAR PURPOSE AND NONINFRINGEMENT. IN NO EVENT SHALL THE AUTHORS OR COPYRIGHT HOLDERS BE LIABLE FOR ANY CLAIM, DAMAGES OR OTHER LIABILITY, WHETHER IN AN ACTION OF CONTRACT, TORT OR OTHERWISE, ARISING FROM, OUT OF OR IN CONNECTION WITH THE SOFTWARE OR THE USE OR OTHER DEALINGS IN THE SOFTWARE.

--- end of LICENSE ---

%% This notice is provided with respect to Unicode 6.2.0 & CLDR 21.0.1 which may be included with JRE 8, JDK 8, and OpenJDK 8.

--- begin of LICENSE ---

Unicode Terms of Use

For the general privacy policy governing access to this site, see the Unicode

Privacy Policy. For trademark usage, see the UnicodeR Consortium Name and Trademark Usage Policy.

A. Unicode Copyright.

1. Copyright c 1991-2013 Unicode, Inc. All rights reserved.
2. Certain documents and files on this website contain a legend indicating that "Modification is permitted." Any person is hereby authorized, without fee, to modify such documents and files to create derivative works conforming to the UnicodeR Standard, subject to Terms and Conditions herein.
3. Any person is hereby authorized, without fee, to view, use, reproduce, and distribute all documents and files solely for informational purposes in the creation of products supporting the Unicode Standard, subject to the Terms and Conditions herein.
4. Further specifications of rights and restrictions pertaining to the use of the particular set of data files known as the "Unicode Character Database" can be found in Exhibit 1.
5. Each version of the Unicode Standard has further specifications of rights and restrictions of use. For the book editions (Unicode 5.0 and earlier), these are found on the back of the title page. The online code charts carry specific restrictions. All other files, including online documentation of the core specification for Unicode 6.0 and later, are covered under these general Terms of Use.
6. No license is granted to "mirror" the Unicode website where a fee is charged for access to the "mirror" site.
7. Modification is not permitted with respect to this document. All copies of this document must be verbatim.

B. Restricted Rights Legend. Any technical data or software which is licensed to the United States of America, its agencies and/or instrumentalities

under this Agreement is commercial technical data or commercial computer software developed exclusively at private expense as defined in FAR 2.101, or DFARS 252.227-7014 (June 1995), as applicable. For technical data, use, duplication, or disclosure by the Government is subject to restrictions as set forth in DFARS 202.227-7015 Technical Data, Commercial and Items (Nov 1995) and this Agreement. For Software, in accordance with FAR 12-212 or DFARS 227-7202, as applicable, use, duplication or disclosure by the Government is subject to the restrictions set forth in this Agreement.

C. Warranties and Disclaimers.

1. This publication and/or website may include technical or typographical errors or other inaccuracies . Changes are periodically added to the information herein; these changes will be incorporated in new editions of the publication and/or website. Unicode may make improvements and/or changes in the product(s) and/or program(s) described in this publication and/or website at any time.

2. If this file has been purchased on magnetic or optical media from Unicode, Inc. the sole and exclusive remedy for any claim will be exchange of the defective media within ninety (90) days of original purchase.

3. EXCEPT AS PROVIDED IN SECTION C.2, THIS PUBLICATION AND/OR SOFTWARE IS

PROVIDED "AS IS" WITHOUT WARRANTY OF ANY KIND EITHER EXPRESS, IMPLIED,

OR STATUTORY, INCLUDING, BUT NOT LIMITED TO, ANY WARRANTIES OF

MERCHANTABILITY, FITNESS FOR A PARTICULAR PURPOSE, OR NON-INFRINGEMENT.

UNICODE AND ITS LICENSORS ASSUME NO RESPONSIBILITY FOR ERRORS OR

OMISSIONS IN THIS PUBLICATION AND/OR SOFTWARE OR OTHER DOCUMENTS WHICH

ARE REFERENCED BY OR LINKED TO THIS PUBLICATION OR THE UNICODE WEBSITE.

D. Waiver of Damages. In no event shall Unicode or its licensors be liable for any special, incidental, indirect or consequential damages of any kind, or any damages whatsoever, whether or not Unicode was advised of the possibility of the damage, including, without limitation, those resulting from the following: loss of use, data or profits, in connection with the use, modification or distribution of this information or its derivatives.

E. Trademarks & Logos.

1. The Unicode Word Mark and the Unicode Logo are trademarks of Unicode, Inc. “The Unicode Consortium” and “Unicode, Inc.” are trade names of Unicode, Inc. Use of the information and materials found on this website indicates your acknowledgement of Unicode, Inc.’s exclusive worldwide rights in the Unicode Word Mark, the Unicode Logo, and the Unicode trade names.
2. The Unicode Consortium Name and Trademark Usage Policy (“Trademark Policy”) are incorporated herein by reference and you agree to abide by the provisions of the Trademark Policy, which may be changed from time to time in the sole discretion of Unicode, Inc.
3. All third party trademarks referenced herein are the property of their respective owners.

Miscellaneous.

1. Jurisdiction and Venue. This server is operated from a location in the State of California, United States of America. Unicode makes no representation that the materials are appropriate for use in other locations. If you access this server from other locations, you are responsible for compliance with local laws. This Agreement, all use of this site and any claims and damages resulting from use of this site are governed solely by the laws of the State of California without regard to any principles which would apply the laws of a different jurisdiction. The user agrees that any disputes regarding this site shall be resolved solely in the courts located in Santa Clara County, California. The user agrees said courts have personal jurisdiction and agree to waive any

right to transfer the dispute to any other forum.

2. **Modification by Unicode.** Unicode shall have the right to modify this Agreement at any time by posting it to this site. The user may not assign any part of this Agreement without Unicode's prior written consent.
3. **Taxes.** The user agrees to pay any taxes arising from access to this website or use of the information herein, except for those based on Unicode's net income.
4. **Severability.** If any provision of this Agreement is declared invalid or unenforceable, the remaining provisions of this Agreement shall remain in effect.
5. **Entire Agreement.** This Agreement constitutes the entire agreement between the parties.

EXHIBIT 1

UNICODE, INC. LICENSE AGREEMENT - DATA FILES AND SOFTWARE

Unicode Data Files include all data files under the directories <http://www.unicode.org/Public/>, <http://www.unicode.org/reports/>, and <http://www.unicode.org/cldr/data/>. Unicode Data Files do not include PDF online code charts under the directory <http://www.unicode.org/Public/>. Software includes any source code published in the Unicode Standard or under the directories <http://www.unicode.org/Public/>, <http://www.unicode.org/reports/>, and <http://www.unicode.org/cldr/data/>.

NOTICE TO USER: Carefully read the following legal agreement. BY DOWNLOADING, INSTALLING, COPYING OR OTHERWISE USING UNICODE INC.'S DATA FILES ("DATA FILES"), AND/OR SOFTWARE ("SOFTWARE"), YOU UNEQUIVOCALLY ACCEPT, AND AGREE TO BE BOUND BY, ALL OF THE TERMS AND CONDITIONS OF THIS AGREEMENT. IF YOU DO NOT

AGREE, DO NOT DOWNLOAD, INSTALL, COPY, DISTRIBUTE OR USE THE DATA FILES OR SOFTWARE.

COPYRIGHT AND PERMISSION NOTICE

Copyright c 1991-2012 Unicode, Inc. All rights reserved. Distributed under the Terms of Use in <http://www.unicode.org/copyright.html>.

Permission is hereby granted, free of charge, to any person obtaining a copy of the Unicode data files and any associated documentation (the "Data Files") or Unicode software and any associated documentation (the "Software") to deal in the Data Files or Software without restriction, including without limitation the rights to use, copy, modify, merge, publish, distribute, and/or sell copies of the Data Files or Software, and to permit persons to whom the Data Files or Software are furnished to do so, provided that (a) the above copyright notice(s) and this permission notice appear with all copies of the Data Files or Software, (b) both the above copyright notice(s) and this permission notice appear in associated documentation, and (c) there is clear notice in each modified Data File or in the Software as well as in the documentation associated with the Data File(s) or Software that the data or software has been modified.

THE DATA FILES AND SOFTWARE ARE PROVIDED "AS IS", WITHOUT WARRANTY OF ANY KIND, EXPRESS OR IMPLIED, INCLUDING BUT NOT LIMITED TO THE WARRANTIES OF MERCHANTABILITY, FITNESS FOR A PARTICULAR PURPOSE AND NONINFRINGEMENT OF THIRD PARTY RIGHTS. IN NO EVENT SHALL THE COPYRIGHT HOLDER OR HOLDERS INCLUDED IN THIS NOTICE BE LIABLE FOR ANY CLAIM, OR ANY SPECIAL INDIRECT OR CONSEQUENTIAL DAMAGES, OR ANY DAMAGES WHATSOEVER RESULTING FROM LOSS OF USE, DATA OR PROFITS, WHETHER IN AN ACTION OF CONTRACT, NEGLIGENCE OR OTHER

TORTIOUS

ACTION, ARISING OUT OF OR IN CONNECTION WITH THE USE OR
PERFORMANCE OF THE
DATA FILES OR SOFTWARE.

Except as contained in this notice, the name of a copyright holder shall not
be used in advertising or otherwise to promote the sale, use or other dealings
in these Data Files or Software without prior written authorization of the
copyright holder.

Unicode and the Unicode logo are trademarks of Unicode, Inc. in the United
States and other countries. All third party trademarks referenced herein are
the property of their respective owners.

--- end of LICENSE ---

%% This notice is provided with respect to UPX v3.01, which may be included
with JRE 8 on Windows.

--- begin of LICENSE ---

Use of any of this software is governed by the terms of the license below:

```
00000      000 000000000.  0000000  00000
`888'      `8' `888  `Y88.  `8888  d8'
888        8  888  .d88'   Y888..8P
888        8  88800088P'   `8888'
888        8  888                .8PY888.
`88.      .8'  888                d8' `888b
`YbodP'    o888o                o888o o88888o
```

The Ultimate Packer for eXecutables

Copyright (c) 1996-2000 Markus Oberhumer & Laszlo Molnar

<http://wildsau.idv.uni-linz.ac.at/mfx/upx.html>

<http://www.nexus.hu/upx>

<http://upx.tsx.org>

PLEASE CAREFULLY READ THIS LICENSE AGREEMENT, ESPECIALLY IF YOU
PLAN
TO MODIFY THE UPX SOURCE CODE OR USE A MODIFIED UPX VERSION.

ABSTRACT

=====

UPX and UCL are copyrighted software distributed under the terms
of the GNU General Public License (hereinafter the "GPL").

The stub which is imbedded in each UPX compressed program is part
of UPX and UCL, and contains code that is under our copyright. The
terms of the GNU General Public License still apply as compressing
a program is a special form of linking with our stub.

As a special exception we grant the free usage of UPX for all
executables, including commercial programs.

See below for details and restrictions.

COPYRIGHT

=====

UPX and UCL are copyrighted software. All rights remain with the authors.

UPX is Copyright (C) 1996-2000 Markus Franz Xaver Johannes Oberhumer

UPX is Copyright (C) 1996-2000 Laszlo Molnar

UCL is Copyright (C) 1996-2000 Markus Franz Xaver Johannes Oberhumer

GNU GENERAL PUBLIC LICENSE

UPX and the UCL library are free software; you can redistribute them and/or modify them under the terms of the GNU General Public License as published by the Free Software Foundation; either version 2 of the License, or (at your option) any later version.

UPX and UCL are distributed in the hope that they will be useful, but WITHOUT ANY WARRANTY; without even the implied warranty of MERCHANTABILITY or FITNESS FOR A PARTICULAR PURPOSE. See the GNU General Public License for more details.

You should have received a copy of the GNU General Public License along with this program; see the file COPYING.

SPECIAL EXCEPTION FOR COMPRESSED EXECUTABLES

The stub which is imbedded in each UPX compressed program is part of UPX and UCL, and contains code that is under our copyright. The terms of the GNU General Public License still apply as compressing a program is a special form of linking with our stub.

Hereby Markus F.X.J. Oberhumer and Laszlo Molnar grant you special permission to freely use and distribute all UPX compressed programs (including commercial ones), subject to the following restrictions:

1. You must compress your program with a completely unmodified UPX version; either with our precompiled version, or (at your option) with a self compiled version of the unmodified UPX sources as distributed by us.
2. This also implies that the UPX stub must be completely unmodified, i.e.

- the stub imbedded in your compressed program must be byte-identical to the stub that is produced by the official unmodified UPX version.
3. The decompressor and any other code from the stub must exclusively get used by the unmodified UPX stub for decompressing your program at program startup. No portion of the stub may get read, copied, called or otherwise get used or accessed by your program.

ANNOTATIONS

=====

- You can use a modified UPX version or modified UPX stub only for programs that are compatible with the GNU General Public License.
- We grant you special permission to freely use and distribute all UPX compressed programs. But any modification of the UPX stub (such as, but not limited to, removing our copyright string or making your program non-decompressible) will immediately revoke your right to use and distribute a UPX compressed program.
- UPX is not a software protection tool; by requiring that you use the unmodified UPX version for your proprietary programs we make sure that any user can decompress your program. This protects both you and your users as nobody can hide malicious code - any program that cannot be decompressed is highly suspicious by definition.
- You can integrate all or part of UPX and UCL into projects that are compatible with the GNU GPL, but obviously you cannot grant any special exceptions beyond the GPL for our code in your project.
- We want to actively support manufacturers of virus scanners and similar security software. Please contact us if you would like to incorporate parts of UPX or UCL into such a product.

Markus F.X.J. Oberhumer
markus.oberhumer@jk.uni-linz.ac.at

Laszlo Molnar
ml1050@cdata.tvnet.hu

Linz, Austria, 25 Feb 2000

Additional License(s)

The UPX license file is at <http://upx.sourceforge.net/upx-license.html>.

--- end of LICENSE ---

%% This notice is provided with respect to Xfree86-VidMode Extension 1.0,
which may be included with JRE 8, JDK 8, and OpenJDK 8 on Linux and Solaris.

--- begin of LICENSE ---

Version 1.1 of XFree86 ProjectLicence.

Copyright (C) 1994-2004 The XFree86 Project, Inc. All rights reserved.

Permission is hereby granted, free of charge, to any person obtaining a copy of this software and associated documentation files (the "Software"), to deal in the Software without restriction, including without limitation the rights to use, copy, modify, merge, publish, distribute, sublicense, and/or sell copies of the Software, and to permit persons to whom the Software is furnished to do so, subject to the following conditions:

1. Redistributions of source code must retain the above copyright notice, this list of conditions, and the following disclaimer.
2. Redistributions in binary form must reproduce the above copyright notice, this list of conditions and the following disclaimer in the documentation and/or other materials provided with the distribution, and in the same place

and form as other copyright, license and disclaimer information.

3. The end-user documentation included with the redistribution, if any, must include the following acknowledgment: "This product includes software developed by The XFree86 Project, Inc (<http://www.xfree86.org/>) and its contributors", in the same place and form as other third-party acknowledgments. Alternately, this acknowledgment may appear in the software itself, in the same form and location as other such third-party acknowledgments.

4. Except as contained in this notice, the name of The XFree86 Project, Inc shall not be used in advertising or otherwise to promote the sale, use or other dealings in this Software without prior written authorization from The XFree86 Project, Inc.

THIS SOFTWARE IS PROVIDED "AS IS" AND ANY EXPRESSED OR IMPLIED WARRANTIES, INCLUDING, BUT NOT LIMITED TO, THE IMPLIED WARRANTIES OF MERCHANTABILITY AND FITNESS FOR A PARTICULAR PURPOSE ARE DISCLAIMED. IN NO EVENT SHALL THE XFREE86 PROJECT, INC OR ITS CONTRIBUTORS BE LIABLE FOR ANY DIRECT, INDIRECT, INCIDENTAL, SPECIAL, EXEMPLARY, OR CONSEQUENTIAL DAMAGES (INCLUDING, BUT NOT LIMITED TO, PROCUREMENT OF SUBSTITUTE GOODS OR SERVICES; LOSS OF USE, DATA, OR PROFITS; OR BUSINESS INTERRUPTION) HOWEVER CAUSED AND ON ANY THEORY OF LIABILITY, WHETHER IN CONTRACT, STRICT LIABILITY, OR TORT (INCLUDING NEGLIGENCE OR OTHERWISE) ARISING IN ANY WAY OUT OF THE USE OF THIS SOFTWARE, EVEN IF ADVISED OF THE POSSIBILITY OF SUCH DAMAGE.

--- end of LICENSE ---

%% This notice is provided with respect to X Window System 6.8.2, which may be included with JRE 8, JDK 8, and OpenJDK 8 on Linux and Solaris.

--- begin of LICENSE ---

Licenses

The X.Org Foundation March 2004

1. Introduction

The X.org Foundation X Window System distribution is a compilation of code and documentation from many sources. This document is intended primarily as a guide to the licenses used in the distribution: you must check each file and/or package for precise redistribution terms. None-the-less, this summary may be useful to many users. No software incorporating the XFree86 1.1 license has been incorporated.

This document is based on the compilation from XFree86.

2. XFree86 License

XFree86 code without an explicit copyright is covered by the following copyright/license:

Copyright (C) 1994-2003 The XFree86 Project, Inc. All Rights Reserved.

Permission is hereby granted, free of charge, to any person obtaining a copy of this software and associated documentation files (the "Software"), to deal in the Software without restriction, including without limitation the rights to use, copy, modify, merge, publish, distribute, sublicense, and/or sell copies of the Software, and to permit persons to whom the Software is furnished to do so, subject to the following conditions:

The above copyright notice and this permission notice shall be included in all copies or substantial portions of the Software.

THE SOFTWARE IS PROVIDED "AS IS", WITHOUT WARRANTY OF ANY KIND, EXPRESS OR IMPLIED, INCLUDING BUT NOT LIMITED TO THE WARRANTIES OF MERCHANTABILITY, FITNESS FOR A PARTICULAR PURPOSE AND NONINFRINGEMENT. IN NO EVENT SHALL THE XFREE86 PROJECT BE LIABLE FOR ANY CLAIM, DAMAGES OR OTHER LIABILITY, WHETHER IN AN ACTION OF CONTRACT, TORT OR OTHERWISE, ARISING FROM, OUT OF OR IN CONNECTION WITH THE SOFTWARE OR THE USE OR OTHER DEALINGS IN THE SOFTWARE.

Except as contained in this notice, the name of the XFree86 Project shall not be used in advertising or otherwise to promote the sale, use or other dealings in this Software without prior written authorization from the XFree86 Project.

3. Other Licenses

Portions of code are covered by the following licenses/copyrights. See individual files for the copyright dates.

3.1. X/MIT Copyrights

3.1.1. X Consortium

Copyright (C) <date> X Consortium

Permission is hereby granted, free of charge, to any person obtaining a copy of this software and associated documentation files (the "Software"), to deal in the Software without restriction, including without limitation the rights to use, copy, modify, merge, publish, distribute, sublicense, and/or sell

copies of the Software, and to permit persons to whom the Software is furnished to do so, subject to the following conditions:

The above copyright notice and this permission notice shall be included in all copies or substantial portions of the Software.

THE SOFTWARE IS PROVIDED "AS IS", WITHOUT WARRANTY OF ANY KIND, EXPRESS OR IMPLIED, INCLUDING BUT NOT LIMITED TO THE WARRANTIES OF MERCHANTABILITY, FITNESS FOR A PARTICULAR PURPOSE AND NONINFRINGEMENT. IN NO EVENT SHALL THE X CONSORTIUM BE LIABLE FOR ANY CLAIM, DAMAGES OR OTHER LIABILITY, WHETHER IN AN ACTION OF CONTRACT, TORT OR OTHERWISE, ARISING FROM, OUT OF OR IN CONNECTION WITH THE SOFTWARE OR THE USE OR OTHER DEALINGS IN THE SOFTWARE.

Except as contained in this notice, the name of the X Consortium shall not be used in advertising or otherwise to promote the sale, use or other dealings in this Software without prior written authorization from the X Consortium.

X Window System is a trademark of X Consortium, Inc.

3.1.2. The Open Group

Copyright <date> The Open Group

Permission to use, copy, modify, distribute, and sell this software and its documentation for any purpose is hereby granted without fee, provided that the above copyright notice appear in all copies and that both that copyright notice and this permission notice appear in supporting documentation.

The above copyright notice and this permission notice shall be included in all copies or substantial portions of the Software.

THE SOFTWARE IS PROVIDED "AS IS", WITHOUT WARRANTY OF ANY KIND, EXPRESS OR IMPLIED, INCLUDING BUT NOT LIMITED TO THE WARRANTIES OF MERCHANTABILITY, FITNESS FOR A PARTICULAR PURPOSE AND NONINFRINGEMENT. IN NO EVENT SHALL THE OPEN GROUP BE LIABLE FOR ANY CLAIM, DAMAGES OR OTHER LIABILITY, WHETHER IN AN ACTION OF CONTRACT, TORT OR OTHERWISE, ARISING FROM, OUT OF OR IN CONNECTION WITH THE SOFTWARE OR THE USE OR OTHER DEALINGS IN THE SOFTWARE.

Except as contained in this notice, the name of The Open Group shall not be used in advertising or otherwise to promote the sale, use or other dealings in this Software without prior written authorization from The Open Group. 3.2. Berkeley-based copyrights:

o

3.2.1. General

Redistribution and use in source and binary forms, with or without modification, are permitted provided that the following conditions are met:

1. Redistributions of source code must retain the above copyright notice, this list of conditions and the following disclaimer.
2. Redistributions in binary form must reproduce the above copyright notice, this list of conditions and the following disclaimer in the documentation and/or other materials provided with the distribution.
3. The name of the author may not be used to endorse or promote products derived from this software without specific prior written permission.

THIS SOFTWARE IS PROVIDED BY THE AUTHOR "AS IS" AND ANY EXPRESS OR IMPLIED WARRANTIES, INCLUDING, BUT NOT LIMITED TO, THE IMPLIED WARRANTIES

OF
MERCHANTABILITY AND FITNESS FOR A PARTICULAR PURPOSE ARE
DISCLAIMED. IN NO
EVENT SHALL THE AUTHOR BE LIABLE FOR ANY DIRECT, INDIRECT,
INCIDENTAL,
SPECIAL, EXEMPLARY, OR CONSEQUENTIAL DAMAGES (INCLUDING, BUT NOT
LIMITED TO,
PROCUREMENT OF SUBSTITUTE GOODS OR SERVICES; LOSS OF USE, DATA,
OR PROFITS; OR
BUSINESS INTERRUPTION) HOWEVER CAUSED AND ON ANY THEORY OF
LIABILITY, WHETHER
IN CONTRACT, STRICT LIABILITY, OR TORT (INCLUDING NEGLIGENCE OR
OTHERWISE)
ARISING IN ANY WAY OUT OF THE USE OF THIS SOFTWARE, EVEN IF ADVISED
OF THE
POSSIBILITY OF SUCH DAMAGE. 3.2.2. UCB/LBL

Copyright (c) 1993 The Regents of the University of California. All rights reserved.

This software was developed by the Computer Systems Engineering group at Lawrence Berkeley Laboratory under DARPA contract BG 91-66 and contributed to Berkeley.

All advertising materials mentioning features or use of this software must display the following acknowledgement: This product includes software developed by the University of California, Lawrence Berkeley Laboratory.

Redistribution and use in source and binary forms, with or without modification, are permitted provided that the following conditions are met:

1. Redistributions of source code must retain the above copyright notice, this list of conditions and the following disclaimer.
2. Redistributions in binary form must reproduce the above copyright notice, this list of conditions and the following disclaimer in the

documentation and/or other materials provided with the distribution.

3. All advertising materials mentioning features or use of this software must display the following acknowledgement: This product includes software developed by the University of California, Berkeley and its contributors.

4. Neither the name of the University nor the names of its contributors may be used to endorse or promote products derived from this software without specific prior written permission.

THIS SOFTWARE IS PROVIDED BY THE REGENTS AND CONTRIBUTORS ``AS IS'' AND ANY EXPRESS OR IMPLIED WARRANTIES, INCLUDING, BUT NOT LIMITED TO, THE IMPLIED WARRANTIES OF MERCHANTABILITY AND FITNESS FOR A PARTICULAR PURPOSE ARE DISCLAIMED. IN NO EVENT SHALL THE REGENTS OR CONTRIBUTORS BE LIABLE FOR ANY DIRECT, INDIRECT, INCIDENTAL, SPECIAL, EXEMPLARY, OR CONSEQUENTIAL DAMAGES (INCLUDING, BUT NOT LIMITED TO, PROCUREMENT OF SUBSTITUTE GOODS OR SERVICES; LOSS OF USE, DATA, OR PROFITS; OR BUSINESS INTERRUPTION) HOWEVER CAUSED AND ON ANY THEORY OF LIABILITY, WHETHER IN CONTRACT, STRICT LIABILITY, OR TORT (INCLUDING NEGLIGENCE OR OTHERWISE) ARISING IN ANY WAY OUT OF THE USE OF THIS SOFTWARE, EVEN IF ADVISED OF THE POSSIBILITY OF SUCH DAMAGE. 3.2.3.

The
NetBSD Foundation, Inc.

Copyright (c) 2003 The NetBSD Foundation, Inc. All rights reserved.

This code is derived from software contributed to The NetBSD Foundation by Ben Collver <collver1@attbi.com>

Redistribution and use in source and binary forms, with or without modification, are permitted provided that the following conditions are met:

1. Redistributions of source code must retain the above copyright notice, this list of conditions and the following disclaimer.
2. Redistributions in binary form must reproduce the above copyright notice, this list of conditions and the following disclaimer in the documentation and/or other materials provided with the distribution.
3. All advertising materials mentioning features or use of this software must display the following acknowledgement: This product includes software developed by the NetBSD Foundation, Inc. and its contributors.
4. Neither the name of The NetBSD Foundation nor the names of its contributors may be used to endorse or promote products derived from this software without specific prior written permission.

THIS SOFTWARE IS PROVIDED BY THE NETBSD FOUNDATION, INC. AND CONTRIBUTORS ``AS IS'' AND ANY EXPRESS OR IMPLIED WARRANTIES, INCLUDING, BUT NOT LIMITED TO, THE IMPLIED WARRANTIES OF MERCHANTABILITY AND FITNESS FOR A PARTICULAR PURPOSE ARE DISCLAIMED. IN NO EVENT SHALL THE FOUNDATION OR CONTRIBUTORS BE LIABLE FOR ANY DIRECT, INDIRECT, INCIDENTAL, SPECIAL, EXEMPLARY, OR CONSEQUENTIAL DAMAGES (INCLUDING, BUT NOT LIMITED TO, PROCUREMENT OF SUBSTITUTE GOODS OR SERVICES; LOSS OF USE, DATA, OR PROFITS; OR BUSINESS INTERRUPTION) HOWEVER CAUSED AND ON ANY THEORY OF LIABILITY, WHETHER IN CONTRACT, STRICT LIABILITY, OR TORT (INCLUDING NEGLIGENCE OR OTHERWISE) ARISING IN ANY WAY OUT OF THE

USE OF THIS

SOFTWARE, EVEN IF ADVISED OF THE POSSIBILITY OF SUCH DAMAGE. 3.2.4.

Theodore

Ts'o.

Copyright Theodore Ts'o, 1994, 1995, 1996, 1997, 1998, 1999. All rights reserved.

Redistribution and use in source and binary forms, with or without modification, are permitted provided that the following conditions are met:

1. Redistributions of source code must retain the above copyright notice, and the entire permission notice in its entirety, including the disclaimer of warranties.
2. Redistributions in binary form must reproduce the above copyright notice, this list of conditions and the following disclaimer in the documentation and/or other materials provided with the distribution.
3. The name of the author may not be used to endorse or promote products derived from this software without specific prior written permission.

THIS SOFTWARE IS PROVIDED "AS IS" AND ANY EXPRESS OR IMPLIED WARRANTIES, INCLUDING, BUT NOT LIMITED TO, THE IMPLIED WARRANTIES OF MERCHANTABILITY AND FITNESS FOR A PARTICULAR PURPOSE, ALL OF WHICH ARE HEREBY DISCLAIMED. IN NO EVENT SHALL THE AUTHOR BE LIABLE FOR ANY DIRECT, INDIRECT, INCIDENTAL, SPECIAL, EXEMPLARY, OR CONSEQUENTIAL DAMAGES (INCLUDING, BUT NOT LIMITED TO, PROCUREMENT OF SUBSTITUTE GOODS OR SERVICES; LOSS OF USE, DATA, OR PROFITS; OR BUSINESS INTERRUPTION) HOWEVER CAUSED AND ON ANY THEORY OF LIABILITY, WHETHER

IN CONTRACT, STRICT LIABILITY, OR TORT (INCLUDING NEGLIGENCE OR OTHERWISE) ARISING IN ANY WAY OUT OF THE USE OF THIS SOFTWARE, EVEN IF NOT ADVISED OF THE POSSIBILITY OF SUCH DAMAGE. 3.2.5. Theo de Raadt and Damien Miller

Copyright (c) 1995,1999 Theo de Raadt. All rights reserved. Copyright (c) 2001-2002 Damien Miller. All rights reserved.

Redistribution and use in source and binary forms, with or without modification, are permitted provided that the following conditions are met:

1. Redistributions of source code must retain the above copyright notice, this list of conditions and the following disclaimer.
2. Redistributions in binary form must reproduce the above copyright notice, this list of conditions and the following disclaimer in the documentation and/or other materials provided with the distribution.

THIS SOFTWARE IS PROVIDED BY THE AUTHOR "AS IS" AND ANY EXPRESS OR IMPLIED WARRANTIES, INCLUDING, BUT NOT LIMITED TO, THE IMPLIED WARRANTIES OF MERCHANTABILITY AND FITNESS FOR A PARTICULAR PURPOSE ARE DISCLAIMED. IN NO EVENT SHALL THE AUTHOR BE LIABLE FOR ANY DIRECT, INDIRECT, INCIDENTAL, SPECIAL, EXEMPLARY, OR CONSEQUENTIAL DAMAGES (INCLUDING, BUT NOT LIMITED TO, PROCUREMENT OF SUBSTITUTE GOODS OR SERVICES; LOSS OF USE, DATA, OR PROFITS; OR BUSINESS INTERRUPTION) HOWEVER CAUSED AND ON ANY THEORY OF LIABILITY, WHETHER IN CONTRACT, STRICT LIABILITY, OR TORT (INCLUDING NEGLIGENCE OR OTHERWISE) ARISING IN ANY WAY OUT OF THE USE OF THIS SOFTWARE, EVEN IF ADVISED

OF THE

POSSIBILITY OF SUCH DAMAGE. 3.2.6. Todd C. Miller

Copyright (c) 1998 Todd C. Miller <Todd.Miller@courtesan.com>

Permission to use, copy, modify, and distribute this software for any purpose with or without fee is hereby granted, provided that the above copyright notice and this permission notice appear in all copies.

THE SOFTWARE IS PROVIDED "AS IS" AND TODD C. MILLER DISCLAIMS ALL WARRANTIES

WITH REGARD TO THIS SOFTWARE INCLUDING ALL IMPLIED WARRANTIES OF MERCHANTABILITY AND FITNESS. IN NO EVENT SHALL TODD C. MILLER BE LIABLE FOR

ANY SPECIAL, DIRECT, INDIRECT, OR CONSEQUENTIAL DAMAGES OR ANY DAMAGES

WHATSOEVER RESULTING FROM LOSS OF USE, DATA OR PROFITS, WHETHER IN AN ACTION

OF CONTRACT, NEGLIGENCE OR OTHER TORTIOUS ACTION, ARISING OUT OF OR IN

CONNECTION WITH THE USE OR PERFORMANCE OF THIS SOFTWARE. 3.2.7.

Thomas

Winischhofer

Copyright (C) 2001-2004 Thomas Winischhofer

Redistribution and use in source and binary forms, with or without modification, are permitted provided that the following conditions are met:

1. Redistributions of source code must retain the above copyright notice, this list of conditions and the following disclaimer.
2. Redistributions in binary form must reproduce the above copyright notice, this list of conditions and the following disclaimer in the documentation and/or other materials provided with the distribution.

3. The name of the author may not be used to endorse or promote products derived from this software without specific prior written permission.

THIS SOFTWARE IS PROVIDED BY THE AUTHOR ``AS IS" AND ANY EXPRESSED OR IMPLIED WARRANTIES, INCLUDING, BUT NOT LIMITED TO, THE IMPLIED WARRANTIES OF MERCHANTABILITY AND FITNESS FOR A PARTICULAR PURPOSE ARE DISCLAIMED. IN NO EVENT SHALL THE AUTHOR BE LIABLE FOR ANY DIRECT, INDIRECT, INCIDENTAL, SPECIAL, EXEMPLARY, OR CONSEQUENTIAL DAMAGES (INCLUDING, BUT NOT LIMITED TO, PROCUREMENT OF SUBSTITUTE GOODS OR SERVICES; LOSS OF USE, DATA, OR PROFITS; OR BUSINESS INTERRUPTION) HOWEVER CAUSED AND ON ANY THEORY OF LIABILITY, WHETHER IN CONTRACT, STRICT LIABILITY, OR TORT (INCLUDING NEGLIGENCE OR OTHERWISE) ARISING IN ANY WAY OUT OF THE USE OF THIS SOFTWARE, EVEN IF ADVISED OF THE POSSIBILITY OF SUCH DAMAGE. 3.3. NVIDIA Corp

Copyright (c) 1996 NVIDIA, Corp. All rights reserved.

NOTICE TO USER: The source code is copyrighted under U.S. and international laws. NVIDIA, Corp. of Sunnyvale, California owns the copyright and as design patents pending on the design and interface of the NV chips. Users and possessors of this source code are hereby granted a nonexclusive, royalty-free copyright and design patent license to use this code in individual and commercial software.

Any use of this source code must include, in the user documentation and internal comments to the code, notices to the end user as follows:

Copyright (c) 1996 NVIDIA, Corp. NVIDIA design patents pending in the U.S. and

foreign countries.

NVIDIA, CORP. MAKES NO REPRESENTATION ABOUT THE SUITABILITY OF THIS SOURCE CODE FOR ANY PURPOSE. IT IS PROVIDED "AS IS" WITHOUT EXPRESS OR IMPLIED WARRANTY OF ANY KIND. NVIDIA, CORP. DISCLAIMS ALL WARRANTIES WITH REGARD TO THIS SOURCE CODE, INCLUDING ALL IMPLIED WARRANTIES OF MERCHANTABILITY AND FITNESS FOR A PARTICULAR PURPOSE. IN NO EVENT SHALL NVIDIA, CORP. BE LIABLE FOR ANY SPECIAL, INDIRECT, INCIDENTAL, OR CONSEQUENTIAL DAMAGES, OR ANY DAMAGES WHATSOEVER RESULTING FROM LOSS OF USE, DATA OR PROFITS, WHETHER IN AN ACTION OF CONTRACT, NEGLIGENCE OR OTHER TORTIOUS ACTION, ARISING OUT OF OR IN CONNECTION WITH THE USE OR PERFORMANCE OF THIS SOURCE CODE. 3.4. GLX Public License

GLX PUBLIC LICENSE (Version 1.0 (2/11/99)) ("License")

Subject to any third party claims, Silicon Graphics, Inc. ("SGI") hereby grants permission to Recipient (defined below), under Recipient's copyrights in the Original Software (defined below), to use, copy, modify, merge, publish, distribute, sublicense and/or sell copies of Subject Software (defined below), and to permit persons to whom the Subject Software is furnished in accordance with this License to do the same, subject to all of the following terms and conditions, which Recipient accepts by engaging in any such use, copying, modifying, merging, publishing, distributing, sublicensing or selling:

1. Definitions.

(a) "Original Software" means source code of computer software code which is described in Exhibit A as Original Software.

(b) "Modifications" means any addition to or deletion from the substance or structure of either the Original Software or any previous Modifications. When Subject Software is released as a series of files, a Modification means (i) any addition to or deletion from the contents of a file containing Original Software or previous Modifications and (ii) any new file that contains any part of the Original Code or previous Modifications.

(c) "Subject Software" means the Original Software or Modifications or the combination of the Original Software and Modifications, or portions of any of the foregoing.

(d) "Recipient" means an individual or a legal entity exercising rights under, and complying with all of the terms of, this License. For legal entities, "Recipient" includes any entity which controls, is controlled by, or is under common control with Recipient. For purposes of this definition, "control" of an entity means (a) the power, direct or indirect, to direct or manage such entity, or (b) ownership of fifty percent (50%) or more of the outstanding shares or beneficial ownership of such entity.

2. Redistribution of Source Code Subject to These Terms. Redistributions of Subject Software in source code form must retain the notice set forth in Exhibit A, below, in every file. A copy of this License must be included in any documentation for such Subject Software where the recipients' rights relating to Subject Software are described. Recipient may distribute the source code version of Subject Software under a license of Recipient's choice, which may contain terms different from this License, provided that (i) Recipient is in compliance with the terms of this License, and (ii) the license terms include this Section 2 and Sections 3, 4, 7, 8, 10, 12 and 13 of this License, which terms may not be modified or superseded by any other terms of such license. If Recipient distributes the source code version under a different license Recipient must make it absolutely clear that any terms which

differ from this License are offered by Recipient alone, not by SGI. Recipient hereby agrees to indemnify SGI for any liability incurred by SGI as a result of any such terms Recipient offers.

3. Redistribution in Executable Form. The notice set forth in Exhibit A must be conspicuously included in any notice in an executable version of Subject Software, related documentation or collateral in which Recipient describes the user's rights relating to the Subject Software. Recipient may distribute the executable version of Subject Software under a license of Recipient's choice, which may contain terms different from this License, provided that (i) Recipient is in compliance with the terms of this License, and (ii) the license terms include this Section 3 and Sections 4, 7, 8, 10, 12 and 13 of this License, which terms may not be modified or superseded by any other terms of such license. If Recipient distributes the executable version under a different license Recipient must make it absolutely clear that any terms which differ from this License are offered by Recipient alone, not by SGI. Recipient hereby agrees to indemnify SGI for any liability incurred by SGI as a result of any such terms Recipient offers.

4. Termination. This License and the rights granted hereunder will terminate automatically if Recipient fails to comply with terms herein and fails to cure such breach within 30 days of the breach. Any sublicense to the Subject Software which is properly granted shall survive any termination of this License absent termination by the terms of such sublicense. Provisions which, by their nature, must remain in effect beyond the termination of this License shall survive.

5. No Trademark Rights. This License does not grant any rights to use any trade name, trademark or service mark whatsoever. No trade name, trademark or service mark of SGI may be used to endorse or promote products derived from the Subject Software without prior written permission of SGI.

6. No Other Rights. This License does not grant any rights with respect to the OpenGL API or to any software or hardware implementation thereof or to any other software whatsoever, nor shall any other rights or licenses not expressly granted hereunder arise by implication, estoppel or otherwise with

respect to the Subject Software. Title to and ownership of the Original Software at all times remains with SGI. All rights in the Original Software not expressly granted under this License are reserved.

7. Compliance with Laws; Non-Infringement. Recipient shall comply with all applicable laws and regulations in connection with use and distribution of the Subject Software, including but not limited to, all export and import control laws and regulations of the U.S. government and other countries. Recipient may not distribute Subject Software that (i) in any way infringes (directly or contributorily) the rights (including patent, copyright, trade secret, trademark or other intellectual property rights of any kind) of any other person or entity or (ii) breaches any representation or warranty, express, implied or statutory, which under any applicable law it might be deemed to have been distributed.

8. Claims of Infringement. If Recipient at any time has knowledge of any one or more third party claims that reproduction, modification, use, distribution, import or sale of Subject Software (including particular functionality or code incorporated in Subject Software) infringes the third party's intellectual property rights, Recipient must place in a well-identified web page bearing the title "LEGAL" a description of each such claim and a description of the party making each such claim in sufficient detail that a user of the Subject Software will know whom to contact regarding the claim. Also, upon gaining such knowledge of any such claim, Recipient must conspicuously include the URL for such web page in the Exhibit A notice required under Sections 2 and 3, above, and in the text of any related documentation, license agreement or collateral in which Recipient describes end user's rights relating to the Subject Software. If Recipient obtains such knowledge after it makes Subject Software available to any other person or entity, Recipient shall take other steps (such as notifying appropriate mailing lists or newsgroups) reasonably calculated to inform those who received the Subject Software that new knowledge has been obtained.

9. DISCLAIMER OF WARRANTY. SUBJECT SOFTWARE IS PROVIDED ON AN "AS IS" BASIS, WITHOUT WARRANTY OF ANY KIND, EITHER EXPRESSED OR IMPLIED,

INCLUDING, WITHOUT
LIMITATION, WARRANTIES THAT THE SUBJECT SOFTWARE IS FREE OF
DEFECTS,
MERCHANTABLE, FIT FOR A PARTICULAR PURPOSE OR NON- INFRINGING. SGI
ASSUMES NO
RISK AS TO THE QUALITY AND PERFORMANCE OF THE SOFTWARE. SHOULD
ANY SOFTWARE
PROVE DEFECTIVE IN ANY RESPECT, SGI ASSUMES NO COST OR LIABILITY
FOR ANY
SERVICING, REPAIR OR CORRECTION. THIS DISCLAIMER OF WARRANTY
CONSTITUTES AN
ESSENTIAL PART OF THIS LICENSE. NO USE OF ANY SUBJECT SOFTWARE IS
AUTHORIZED
HEREUNDER EXCEPT UNDER THIS DISCLAIMER.

10. LIMITATION OF LIABILITY. UNDER NO CIRCUMSTANCES AND UNDER NO
LEGAL THEORY,
WHETHER TORT (INCLUDING, WITHOUT LIMITATION, NEGLIGENCE OR
STRICT LIABILITY),
CONTRACT, OR OTHERWISE, SHALL SGI OR ANY SGI LICENSOR BE LIABLE FOR
ANY
DIRECT, INDIRECT, SPECIAL, INCIDENTAL, OR CONSEQUENTIAL DAMAGES OF
ANY
CHARACTER INCLUDING, WITHOUT LIMITATION, DAMAGES FOR LOSS OF
GOODWILL, WORK
STOPPAGE, LOSS OF DATA, COMPUTER FAILURE OR MALFUNCTION, OR ANY
AND ALL OTHER
COMMERCIAL DAMAGES OR LOSSES, EVEN IF SUCH PARTY SHALL HAVE BEEN
INFORMED OF
THE POSSIBILITY OF SUCH DAMAGES. THIS LIMITATION OF LIABILITY SHALL
NOT APPLY
TO LIABILITY FOR DEATH OR PERSONAL INJURY RESULTING FROM SGI's
NEGLIGENCE TO
THE EXTENT APPLICABLE LAW PROHIBITS SUCH LIMITATION. SOME
JURISDICTIONS DO NOT
ALLOW THE EXCLUSION OR LIMITATION OF INCIDENTAL OR

CONSEQUENTIAL DAMAGES, SO
THAT EXCLUSION AND LIMITATION MAY NOT APPLY TO RECIPIENT.

11. Indemnity. Recipient shall be solely responsible for damages arising, directly or indirectly, out of its utilization of rights under this License. Recipient will defend, indemnify and hold harmless Silicon Graphics, Inc. from and against any loss, liability, damages, costs or expenses (including the payment of reasonable attorneys fees) arising out of Recipient's use, modification, reproduction and distribution of the Subject Software or out of any representation or warranty made by Recipient.

12. U.S. Government End Users. The Subject Software is a "commercial item" consisting of "commercial computer software" as such terms are defined in title 48 of the Code of Federal Regulations and all U.S. Government End Users acquire only the rights set forth in this License and are subject to the terms of this License.

13. Miscellaneous. This License represents the complete agreement concerning subject matter hereof. If any provision of this License is held to be unenforceable, such provision shall be reformed so as to achieve as nearly as possible the same economic effect as the original provision and the remainder of this License will remain in effect. This License shall be governed by and construed in accordance with the laws of the United States and the State of California as applied to agreements entered into and to be performed entirely within California between California residents. Any litigation relating to this License shall be subject to the exclusive jurisdiction of the Federal Courts of the Northern District of California (or, absent subject matter jurisdiction in such courts, the courts of the State of California), with venue lying exclusively in Santa Clara County, California, with the losing party responsible for costs, including without limitation, court costs and reasonable attorneys fees and expenses. The application of the United Nations Convention on Contracts for the International Sale of Goods is expressly excluded. Any law or regulation which provides that the language of a contract shall be construed against the drafter shall not apply to this License.

Exhibit A

The contents of this file are subject to Sections 2, 3, 4, 7, 8, 10, 12 and 13 of the GLX Public License Version 1.0 (the "License"). You may not use this file except in compliance with those sections of the License. You may obtain a copy of the License at Silicon Graphics, Inc., attn: Legal Services, 2011 N. Shoreline Blvd., Mountain View, CA 94043 or at <http://www.sgi.com/software/opensource/glx/license.html>.

Software distributed under the License is distributed on an "AS IS" basis. ALL WARRANTIES ARE DISCLAIMED, INCLUDING, WITHOUT LIMITATION, ANY IMPLIED WARRANTIES OF MERCHANTABILITY, OF FITNESS FOR A PARTICULAR PURPOSE OR OF NON-INFRINGEMENT. See the License for the specific language governing rights and limitations under the License.

The Original Software is GLX version 1.2 source code, released February, 1999. The developer of the Original Software is Silicon Graphics, Inc. Those portions of the Subject Software created by Silicon Graphics, Inc. are Copyright (c) 1991-9 Silicon Graphics, Inc. All Rights Reserved. 3.5. CID Font Code Public License

CID FONT CODE PUBLIC LICENSE (Version 1.0 (3/31/99))("License")

Subject to any applicable third party claims, Silicon Graphics, Inc. ("SGI") hereby grants permission to Recipient (defined below), under SGI's copyrights in the Original Software (defined below), to use, copy, modify, merge, publish, distribute, sublicense and/or sell copies of Subject Software (defined below) in both source code and executable form, and to permit persons to whom the Subject Software is furnished in accordance with this License to do the same, subject to all of the following terms and conditions, which Recipient accepts by engaging in any such use, copying, modifying, merging, publication, distributing, sublicensing or selling:

1. Definitions.

a. "Original Software" means source code of computer software code that is described in Exhibit A as Original Software.

b. "Modifications" means any addition to or deletion from the substance or structure of either the Original Software or any previous Modifications. When Subject Software is released as a series of files, a Modification means (i) any addition to or deletion from the contents of a file containing Original Software or previous Modifications and (ii) any new file that contains any part of the Original Code or previous Modifications.

c. "Subject Software" means the Original Software or Modifications or the combination of the Original Software and Modifications, or portions of any of the foregoing.

d. "Recipient" means an individual or a legal entity exercising rights under the terms of this License. For legal entities, "Recipient" includes any entity that controls, is controlled by, or is under common control with Recipient. For purposes of this definition, "control" of an entity means (i) the power, direct or indirect, to direct or manage such entity, or (ii) ownership of fifty percent (50%) or more of the outstanding shares or beneficial ownership of such entity.

e. "Required Notice" means the notice set forth in Exhibit A to this License.

f. "Accompanying Technology" means any software or other technology that is not a Modification and that is distributed or made publicly available by Recipient with the Subject Software. Separate software files that do not contain any Original Software or any previous Modification shall not be deemed a Modification, even if such software files are aggregated as part of a product, or in any medium of storage, with any file that does contain Original Software or any previous Modification.

2. License Terms. All distribution of the Subject Software must be made subject to the terms of this License. A copy of this License and the Required

Notice must be included in any documentation for Subject Software where Recipient's rights relating to Subject Software and/or any Accompanying Technology are described. Distributions of Subject Software in source code form must also include the Required Notice in every file distributed. In addition, a ReadMe file entitled "Important Legal Notice" must be distributed with each distribution of one or more files that incorporate Subject Software. That file must be included with distributions made in both source code and executable form. A copy of the License and the Required Notice must be included in that file. Recipient may distribute Accompanying Technology under a license of Recipient's choice, which may contain terms different from this License, provided that (i) Recipient is in compliance with the terms of this License, (ii) such other license terms do not modify or supersede the terms of this License as applicable to the Subject Software, (iii) Recipient hereby indemnifies SGI for any liability incurred by SGI as a result of the distribution of Accompanying Technology or the use of other license terms.

3. Termination. This License and the rights granted hereunder will terminate automatically if Recipient fails to comply with terms herein and fails to cure such breach within 30 days of the breach. Any sublicense to the Subject Software that is properly granted shall survive any termination of this License absent termination by the terms of such sublicense. Provisions which, by their nature, must remain in effect beyond the termination of this License shall survive.

4. Trademark Rights. This License does not grant any rights to use any trade name, trademark or service mark whatsoever. No trade name, trademark or service mark of SGI may be used to endorse or promote products derived from or incorporating any Subject Software without prior written permission of SGI.

5. No Other Rights. No rights or licenses not expressly granted hereunder shall arise by implication, estoppel or otherwise. Title to and ownership of the Original Software at all times remains with SGI. All rights in the Original Software not expressly granted under this License are reserved.

6. Compliance with Laws; Non-Infringement. Recipient shall comply with all applicable laws and regulations in connection with use and distribution of the

Subject Software, including but not limited to, all export and import control laws and regulations of the U.S. government and other countries. Recipient may not distribute Subject Software that (i) in any way infringes (directly or contributorily) the rights (including patent, copyright, trade secret, trademark or other intellectual property rights of any kind) of any other person or entity, or (ii) breaches any representation or warranty, express, implied or statutory, which under any applicable law it might be deemed to have been distributed.

7. Claims of Infringement. If Recipient at any time has knowledge of any one or more third party claims that reproduction, modification, use, distribution, import or sale of Subject Software (including particular functionality or code incorporated in Subject Software) infringes the third party's intellectual property rights, Recipient must place in a well-identified web page bearing the title "LEGAL" a description of each such claim and a description of the party making each such claim in sufficient detail that a user of the Subject Software will know whom to contact regarding the claim. Also, upon gaining such knowledge of any such claim, Recipient must conspicuously include the URL for such web page in the Required Notice, and in the text of any related documentation, license agreement or collateral in which Recipient describes end user's rights relating to the Subject Software. If Recipient obtains such knowledge after it makes Subject Software available to any other person or entity, Recipient shall take other steps (such as notifying appropriate mailing lists or newsgroups) reasonably calculated to provide such knowledge to those who received the Subject Software.

8. DISCLAIMER OF WARRANTY. SUBJECT SOFTWARE IS PROVIDED ON AN "AS IS" BASIS, WITHOUT WARRANTY OF ANY KIND, EITHER EXPRESSED OR IMPLIED, INCLUDING, WITHOUT LIMITATION, WARRANTIES THAT THE SUBJECT SOFTWARE IS FREE OF DEFECTS, MERCHANTABILITY, FIT FOR A PARTICULAR PURPOSE OR NON-INFRINGEMENT. SGI ASSUMES NO RISK AS TO THE QUALITY AND PERFORMANCE OF THE SOFTWARE. SHOULD ANY SOFTWARE

PROVE DEFECTIVE IN ANY RESPECT, SGI ASSUMES NO COST OR LIABILITY FOR ANY SERVICING, REPAIR OR CORRECTION. THIS DISCLAIMER OF WARRANTY CONSTITUTES AN ESSENTIAL PART OF THIS LICENSE. NO USE OF ANY SUBJECT SOFTWARE IS AUTHORIZED HEREUNDER EXCEPT UNDER THIS DISCLAIMER.

9. LIMITATION OF LIABILITY. UNDER NO CIRCUMSTANCES AND UNDER NO LEGAL THEORY, WHETHER TORT (INCLUDING, WITHOUT LIMITATION, NEGLIGENCE OR STRICT LIABILITY), CONTRACT, OR OTHERWISE, SHALL SGI OR ANY SGI LICENSOR BE LIABLE FOR ANY CLAIM, DAMAGES OR OTHER LIABILITY, WHETHER IN AN ACTION OF CONTRACT, TORT OR OTHERWISE, ARISING FROM, OUT OF OR IN CONNECTION WITH THE SUBJECT SOFTWARE OR THE USE OR OTHER DEALINGS IN THE SUBJECT SOFTWARE. SOME JURISDICTIONS DO NOT ALLOW THE EXCLUSION OR LIMITATION OF CERTAIN DAMAGES, SO THIS EXCLUSION AND LIMITATION MAY NOT APPLY TO RECIPIENT TO THE EXTENT SO DISALLOWED.

10. Indemnity. Recipient shall be solely responsible for damages arising, directly or indirectly, out of its utilization of rights under this License. Recipient will defend, indemnify and hold SGI and its successors and assigns harmless from and against any loss, liability, damages, costs or expenses (including the payment of reasonable attorneys fees) arising out of (Recipient's use, modification, reproduction and distribution of the Subject Software or out of any representation or warranty made by Recipient.

11. U.S. Government End Users. The Subject Software is a "commercial item" consisting of "commercial computer software" as such terms are defined in title 48 of the Code of Federal Regulations and all U.S. Government End Users acquire only the rights set forth in this License and are subject to the terms

of this License.

12. Miscellaneous. This License represents the complete agreement concerning subject matter hereof. If any provision of this License is held to be unenforceable by any judicial or administrative authority having proper jurisdiction with respect thereto, such provision shall be reformed so as to achieve as nearly as possible the same economic effect as the original provision and the remainder of this License will remain in effect. This License shall be governed by and construed in accordance with the laws of the United States and the State of California as applied to agreements entered into and to be performed entirely within California between California residents. Any litigation relating to this License shall be subject to the exclusive jurisdiction of the Federal Courts of the Northern District of California (or, absent subject matter jurisdiction in such courts, the courts of the State of California), with venue lying exclusively in Santa Clara County, California, with the losing party responsible for costs, including without limitation, court costs and reasonable attorneys fees and expenses. The application of the United Nations Convention on Contracts for the International Sale of Goods is expressly excluded. Any law or regulation that provides that the language of a contract shall be construed against the drafter shall not apply to this License.

Exhibit A

Copyright (c) 1994-1999 Silicon Graphics, Inc.

The contents of this file are subject to the CID Font Code Public License Version 1.0 (the "License"). You may not use this file except in compliance with the License. You may obtain a copy of the License at Silicon Graphics, Inc., attn: Legal Services, 2011 N. Shoreline Blvd., Mountain View, CA 94043 or at <http://www.sgi.com/software/opensource/cid/license.html>

Software distributed under the License is distributed on an "AS IS" basis. ALL WARRANTIES ARE DISCLAIMED, INCLUDING, WITHOUT LIMITATION, ANY IMPLIED WARRANTIES OF MERCHANTABILITY, OF FITNESS FOR A PARTICULAR

PURPOSE OR OF

NON-INFRINGEMENT. See the License for the specific language governing rights and limitations under the License.

The Original Software (as defined in the License) is CID font code that was developed by Silicon Graphics, Inc. Those portions of the Subject Software (as defined in the License) that were created by Silicon Graphics, Inc. are Copyright (c) 1994-1999 Silicon Graphics, Inc. All Rights Reserved.

[NOTE: When using this text in connection with Subject Software delivered solely in object code form, Recipient may replace the words "this file" with "this software" in both the first and second sentences.] 3.6. Bitstream Vera Fonts Copyright

The fonts have a generous copyright, allowing derivative works (as long as "Bitstream" or "Vera" are not in the names), and full redistribution (so long as they are not *sold* by themselves). They can be bundled, redistributed and sold with any software.

The fonts are distributed under the following copyright:

Copyright (c) 2003 by Bitstream, Inc. All Rights Reserved. Bitstream Vera is a trademark of Bitstream, Inc.

Permission is hereby granted, free of charge, to any person obtaining a copy of the fonts accompanying this license ("Fonts") and associated documentation files (the "Font Software"), to reproduce and distribute the Font Software, including without limitation the rights to use, copy, merge, publish, distribute, and/or sell copies of the Font Software, and to permit persons to whom the Font Software is furnished to do so, subject to the following conditions:

The above copyright and trademark notices and this permission notice shall be included in all copies of one or more of the Font Software typefaces.

The Font Software may be modified, altered, or added to, and in particular the

designs of glyphs or characters in the Fonts may be modified and additional glyphs or characters may be added to the Fonts, only if the fonts are renamed to names not containing either the words "Bitstream" or the word "Vera".

This License becomes null and void to the extent applicable to Fonts or Font Software that has been modified and is distributed under the "Bitstream Vera" names.

The Font Software may be sold as part of a larger software package but no copy of one or more of the Font Software typefaces may be sold by itself.

THE FONT SOFTWARE IS PROVIDED "AS IS", WITHOUT WARRANTY OF ANY KIND, EXPRESS OR IMPLIED, INCLUDING BUT NOT LIMITED TO ANY WARRANTIES OF MERCHANTABILITY, FITNESS FOR A PARTICULAR PURPOSE AND NONINFRINGEMENT OF COPYRIGHT, PATENT, TRADEMARK, OR OTHER RIGHT. IN NO EVENT SHALL BITSTREAM OR THE GNOME FOUNDATION BE LIABLE FOR ANY CLAIM, DAMAGES OR OTHER LIABILITY, INCLUDING ANY GENERAL, SPECIAL, INDIRECT, INCIDENTAL, OR CONSEQUENTIAL DAMAGES, WHETHER IN AN ACTION OF CONTRACT, TORT OR OTHERWISE, ARISING FROM, OUT OF THE USE OR INABILITY TO USE THE FONT SOFTWARE OR FROM OTHER DEALINGS IN THE FONT SOFTWARE.

Except as contained in this notice, the names of Gnome, the Gnome Foundation, and Bitstream Inc., shall not be used in advertising or otherwise to promote the sale, use or other dealings in this Font Software without prior written authorization from the Gnome Foundation or Bitstream Inc., respectively. For further information, contact: fonts at gnome dot org. 3.7. Bigelow & Holmes Inc and URW++ GmbH Luxi font license

Luxi fonts copyright (c) 2001 by Bigelow & Holmes Inc. Luxi font instruction

code copyright (c) 2001 by URW++ GmbH. All Rights Reserved. Luxi is a registered trademark of Bigelow & Holmes Inc.

Permission is hereby granted, free of charge, to any person obtaining a copy of these Fonts and associated documentation files (the "Font Software"), to deal in the Font Software, including without limitation the rights to use, copy, merge, publish, distribute, sublicense, and/or sell copies of the Font Software, and to permit persons to whom the Font Software is furnished to do so, subject to the following conditions:

The above copyright and trademark notices and this permission notice shall be included in all copies of one or more of the Font Software.

The Font Software may not be modified, altered, or added to, and in particular the designs of glyphs or characters in the Fonts may not be modified nor may additional glyphs or characters be added to the Fonts. This License becomes null and void when the Fonts or Font Software have been modified.

THE FONT SOFTWARE IS PROVIDED "AS IS", WITHOUT WARRANTY OF ANY KIND, EXPRESS OR IMPLIED, INCLUDING BUT NOT LIMITED TO ANY WARRANTIES OF MERCHANTABILITY, FITNESS FOR A PARTICULAR PURPOSE AND NONINFRINGEMENT OF COPYRIGHT, PATENT, TRADEMARK, OR OTHER RIGHT. IN NO EVENT SHALL BIGELOW & HOLMES INC. OR URW++ GMBH. BE LIABLE FOR ANY CLAIM, DAMAGES OR OTHER LIABILITY, INCLUDING ANY GENERAL, SPECIAL, INDIRECT, INCIDENTAL, OR CONSEQUENTIAL DAMAGES, WHETHER IN AN ACTION OF CONTRACT, TORT OR OTHERWISE, ARISING FROM, OUT OF THE USE OR INABILITY TO USE THE FONT SOFTWARE OR FROM OTHER DEALINGS IN THE FONT SOFTWARE.

Except as contained in this notice, the names of Bigelow & Holmes Inc. and URW++ GmbH. shall not be used in advertising or otherwise to promote the sale, use or other dealings in this Font Software without prior written authorization from Bigelow & Holmes Inc. and URW++ GmbH.

For further information, contact:

info@urwpp.de or design@bigelowandholmes.com

--- end of LICENSE ---

%% This notice is provided with respect to zlib v1.2.5, which may be included with JRE 8, JDK 8, and OpenJDK 8.

--- begin of LICENSE ---

version 1.2.5, July 18th, 2005

Copyright (C) 1995-2005 Jean-loup Gailly and Mark Adler

This software is provided 'as-is', without any express or implied warranty. In no event will the authors be held liable for any damages arising from the use of this software.

Permission is granted to anyone to use this software for any purpose, including commercial applications, and to alter it and redistribute it freely, subject to the following restrictions:

1. The origin of this software must not be misrepresented; you must not claim that you wrote the original software. If you use this software in a product, an acknowledgment in the product documentation would be appreciated but is not required.
2. Altered source versions must be plainly marked as such, and must not be

misrepresented as being the original software.

3. This notice may not be removed or altered from any source distribution.

Jean-loup Gailly

Mark Adler

jloup@gzip.org

madler@alumni.caltech.edu

--- end of LICENSE ---

%% This notice is provided with respect to the following which may be included with JRE 8, JDK 8, and OpenJDK 8, except where noted:

Apache Commons Math 2.2

Apache Derby 10.10.1.2 [included with JDK 8]

Apache Jakarta BCEL 5.2

Apache Jakarta Regexp 1.4

Apache Santuario XML Security for Java 1.5.4

Apache Xalan-Java 2.7.1

Apache Xerces Java 2.10.0

Apache XML Resolver 1.1

Dynalink 0.5

--- begin of LICENSE ---

Apache License

Version 2.0, January 2004

<http://www.apache.org/licenses/>

TERMS AND CONDITIONS FOR USE, REPRODUCTION, AND DISTRIBUTION

1. Definitions.

"License" shall mean the terms and conditions for use, reproduction, and distribution as defined by Sections 1 through 9 of this document.

"Licensor" shall mean the copyright owner or entity authorized by the copyright owner that is granting the License.

"Legal Entity" shall mean the union of the acting entity and all other entities that control, are controlled by, or are under common control with that entity. For the purposes of this definition, "control" means (i) the power, direct or indirect, to cause the direction or management of such entity, whether by contract or otherwise, or (ii) ownership of fifty percent (50%) or more of the outstanding shares, or (iii) beneficial ownership of such entity.

"You" (or "Your") shall mean an individual or Legal Entity exercising permissions granted by this License.

"Source" form shall mean the preferred form for making modifications, including but not limited to software source code, documentation source, and configuration files.

"Object" form shall mean any form resulting from mechanical transformation or translation of a Source form, including but not limited to compiled object code, generated documentation, and conversions to other media types.

"Work" shall mean the work of authorship, whether in Source or Object form, made available under the License, as indicated by a copyright notice that is included in or attached to the work (an example is provided in the Appendix below).

"Derivative Works" shall mean any work, whether in Source or Object form, that is based on (or derived from) the Work and for which the editorial revisions, annotations, elaborations, or other modifications represent, as a whole, an original work of authorship. For the purposes of this License, Derivative Works shall not include works that remain separable from, or merely link (or bind by name) to the interfaces of, the Work and Derivative Works thereof.

"Contribution" shall mean any work of authorship, including the original version of the Work and any modifications or additions to that Work or Derivative Works thereof, that is intentionally submitted to Licensor for inclusion in the Work by the copyright owner or by an individual or Legal Entity authorized to submit on behalf of the copyright owner. For the purposes of this definition, "submitted" means any form of electronic, verbal, or written communication sent to the Licensor or its representatives, including but not limited to communication on electronic mailing lists, source code control systems, and issue tracking systems that are managed by, or on behalf of, the Licensor for the purpose of discussing and improving the Work, but excluding communication that is conspicuously marked or otherwise designated in writing by the copyright owner as "Not a Contribution."

"Contributor" shall mean Licensor and any individual or Legal Entity on behalf of whom a Contribution has been received by Licensor and subsequently incorporated within the Work.

2. Grant of Copyright License. Subject to the terms and conditions of this License, each Contributor hereby grants to You a perpetual, worldwide, non-exclusive, no-charge, royalty-free, irrevocable copyright license to reproduce, prepare Derivative Works of, publicly display, publicly perform, sublicense, and distribute the Work and such Derivative Works in Source or Object form.
3. Grant of Patent License. Subject to the terms and conditions of this License, each Contributor hereby grants to You a perpetual, worldwide, non-exclusive, no-charge, royalty-free, irrevocable (except as stated in this section) patent license to make, have made, use, offer to sell, sell, import, and otherwise transfer the Work, where such license applies only to those patent claims licensable by such Contributor that are necessarily infringed by their Contribution(s) alone or by combination of their Contribution(s) with the Work to which such Contribution(s) was submitted. If You institute patent litigation against any entity (including a

cross-claim or counterclaim in a lawsuit) alleging that the Work or a Contribution incorporated within the Work constitutes direct or contributory patent infringement, then any patent licenses granted to You under this License for that Work shall terminate as of the date such litigation is filed.

4. Redistribution. You may reproduce and distribute copies of the Work or Derivative Works thereof in any medium, with or without modifications, and in Source or Object form, provided that You meet the following conditions:
 - (a) You must give any other recipients of the Work or Derivative Works a copy of this License; and
 - (b) You must cause any modified files to carry prominent notices stating that You changed the files; and
 - (c) You must retain, in the Source form of any Derivative Works that You distribute, all copyright, patent, trademark, and attribution notices from the Source form of the Work, excluding those notices that do not pertain to any part of the Derivative Works; and
 - (d) If the Work includes a "NOTICE" text file as part of its distribution, then any Derivative Works that You distribute must include a readable copy of the attribution notices contained within such NOTICE file, excluding those notices that do not pertain to any part of the Derivative Works, in at least one of the following places: within a NOTICE text file distributed as part of the Derivative Works; within the Source form or documentation, if provided along with the Derivative Works; or, within a display generated by the Derivative Works, if and wherever such third-party notices normally appear. The contents of the NOTICE file are for informational purposes only and do not modify the License. You may add Your own attribution notices within Derivative Works that You distribute, alongside

or as an addendum to the NOTICE text from the Work, provided that such additional attribution notices cannot be construed as modifying the License.

You may add Your own copyright statement to Your modifications and may provide additional or different license terms and conditions for use, reproduction, or distribution of Your modifications, or for any such Derivative Works as a whole, provided Your use, reproduction, and distribution of the Work otherwise complies with the conditions stated in this License.

5. **Submission of Contributions.** Unless You explicitly state otherwise, any Contribution intentionally submitted for inclusion in the Work by You to the Licensor shall be under the terms and conditions of this License, without any additional terms or conditions. Notwithstanding the above, nothing herein shall supersede or modify the terms of any separate license agreement you may have executed with Licensor regarding such Contributions.
6. **Trademarks.** This License does not grant permission to use the trade names, trademarks, service marks, or product names of the Licensor, except as required for reasonable and customary use in describing the origin of the Work and reproducing the content of the NOTICE file.
7. **Disclaimer of Warranty.** Unless required by applicable law or agreed to in writing, Licensor provides the Work (and each Contributor provides its Contributions) on an "AS IS" BASIS, WITHOUT WARRANTIES OR CONDITIONS OF ANY KIND, either express or implied, including, without limitation, any warranties or conditions of TITLE, NON-INFRINGEMENT, MERCHANTABILITY, or FITNESS FOR A PARTICULAR PURPOSE. You are solely responsible for determining the appropriateness of using or redistributing the Work and assume any risks associated with Your exercise of permissions under this License.
8. **Limitation of Liability.** In no event and under no legal theory, whether in tort (including negligence), contract, or otherwise,

unless required by applicable law (such as deliberate and grossly negligent acts) or agreed to in writing, shall any Contributor be liable to You for damages, including any direct, indirect, special, incidental, or consequential damages of any character arising as a result of this License or out of the use or inability to use the Work (including but not limited to damages for loss of goodwill, work stoppage, computer failure or malfunction, or any and all other commercial damages or losses), even if such Contributor has been advised of the possibility of such damages.

9. **Accepting Warranty or Additional Liability.** While redistributing the Work or Derivative Works thereof, You may choose to offer, and charge a fee for, acceptance of support, warranty, indemnity, or other liability obligations and/or rights consistent with this License. However, in accepting such obligations, You may act only on Your own behalf and on Your sole responsibility, not on behalf of any other Contributor, and only if You agree to indemnify, defend, and hold each Contributor harmless for any liability incurred by, or claims asserted against, such Contributor by reason of your accepting any such warranty or additional liability.

END OF TERMS AND CONDITIONS

APPENDIX: How to apply the Apache License to your work.

To apply the Apache License to your work, attach the following boilerplate notice, with the fields enclosed by brackets "[]" replaced with your own identifying information. (Don't include the brackets!) The text should be enclosed in the appropriate comment syntax for the file format. We also recommend that a file or class name and description of purpose be included on the same "printed page" as the copyright notice for easier identification within third-party archives.

Copyright [yyyy] [name of copyright owner]

Licensed under the Apache License, Version 2.0 (the "License");
you may not use this file except in compliance with the License.
You may obtain a copy of the License at

<http://www.apache.org/licenses/LICENSE-2.0>

Unless required by applicable law or agreed to in writing, software
distributed under the License is distributed on an "AS IS" BASIS,
WITHOUT WARRANTIES OR CONDITIONS OF ANY KIND, either express or
implied.

See the License for the specific language governing permissions and
limitations under the License.

--- end of LICENSE ---

This Font Software is licensed under the SIL Open Font License, Version 1.1.

This license is copied below, and is also available with a FAQ at: <http://scripts.sil.org/OFL>

SIL OPEN FONT LICENSE Version 1.1 - 26 February 2007

PREAMBLE

The goals of the Open Font License (OFL) are to stimulate worldwide development of collaborative font projects, to support the font creation efforts of academic and linguistic communities, and to provide a free and open framework in which fonts may be shared and improved in partnership with others.

The OFL allows the licensed fonts to be used, studied, modified and redistributed freely as long as they are not sold by themselves. The fonts, including any derivative works, can be bundled, embedded, redistributed and/or sold with any software provided that any reserved names are not used by derivative works. The fonts and derivatives, however, cannot be released under any other type of license. The requirement for fonts to remain under this license does not apply to any document created using the fonts or their derivatives.

DEFINITIONS

"Font Software" refers to the set of files released by the Copyright Holder(s) under this license and clearly marked as such. This may include source files, build scripts and documentation.

"Reserved Font Name" refers to any names specified as such after the copyright statement(s).

"Original Version" refers to the collection of Font Software components as distributed by the Copyright Holder(s).

"Modified Version" refers to any derivative made by adding to, deleting, or substituting -- in part or in whole -- any of the components of the Original Version, by changing formats or by porting the Font Software to a new environment.

"Author" refers to any designer, engineer, programmer, technical writer or other person who contributed to the Font Software.

PERMISSION & CONDITIONS

Permission is hereby granted, free of charge, to any person obtaining a copy of the Font Software, to use, study, copy, merge, embed, modify, redistribute, and sell modified and unmodified copies of the Font Software, subject to the following conditions:

- 1) Neither the Font Software nor any of its individual components, in Original or Modified Versions, may be sold by itself.
- 2) Original or Modified Versions of the Font Software may be bundled, redistributed and/or sold with any software, provided that each copy contains the above copyright notice and this license. These can be included either as stand-alone text files, human-readable headers or in the appropriate machine-readable metadata fields within text or binary files as long as those fields can be easily viewed by the user.
- 3) No Modified Version of the Font Software may use the Reserved Font Name(s) unless explicit written permission is granted by the corresponding Copyright Holder. This restriction only applies to the primary font name as presented to the users.
- 4) The name(s) of the Copyright Holder(s) or the Author(s) of the Font Software shall not be used to promote, endorse or advertise any Modified Version, except to acknowledge the contribution(s) of the Copyright Holder(s) and the Author(s) or with their explicit written permission.
- 5) The Font Software, modified or unmodified, in part or in whole, must be distributed entirely under this license, and must not be distributed under any other license. The requirement for fonts to remain under this license does not apply to any document created using the Font Software.

TERMINATION

This license becomes null and void if any of the above conditions are not met.

DISCLAIMER

THE FONT SOFTWARE IS PROVIDED "AS IS", WITHOUT WARRANTY OF ANY KIND, EXPRESS OR IMPLIED, INCLUDING BUT NOT LIMITED TO ANY WARRANTIES OF MERCHANTABILITY, FITNESS FOR A PARTICULAR PURPOSE AND NONINFRINGEMENT OF COPYRIGHT, PATENT, TRADEMARK, OR OTHER RIGHT. IN NO EVENT SHALL THE COPYRIGHT HOLDER BE LIABLE FOR ANY CLAIM, DAMAGES OR OTHER LIABILITY, INCLUDING ANY GENERAL, SPECIAL, INDIRECT, INCIDENTAL, OR CONSEQUENTIAL DAMAGES, WHETHER IN AN ACTION OF CONTRACT, TORT OR OTHERWISE, ARISING FROM, OUT OF THE USE OR INABILITY TO USE THE FONT SOFTWARE OR FROM OTHER DEALINGS IN THE FONT SOFTWARE.