

Canon

S800TM

Color Bubble JetTM Photo Printer

User's Guide

Canon S800 Color Bubble Jet Photo Printer User's Guide.

Copyright

This manual is copyrighted by Canon U.S.A., Inc. with all rights reserved. Under the copyright laws, this manual may not be reproduced in any form, in whole or in part, without the prior written consent of Canon U.S.A., Inc.

© 2001 Canon U.S.A., Inc.

Disclaimer

Canon U.S.A., Inc. has reviewed this manual thoroughly in order that it will be an easy to use guide to your Canon S800 Color Bubble Jet Photo Printer. All statements, technical information and recommendations in this manual and in any guides or related documents are believed reliable, but the accuracy and completeness thereof are not guaranteed or warranted, and they are not intended to be, nor should they be understood to be, representation or warranties concerning the products described.

Specifications are subject to change without notice.

All print speeds based on high-speed draft mode. Print speed will vary depending on system configuration, software, document complexity, print mode and page coverage.



As an Energy Star partner, Canon U.S.A., Inc., has determined that this product meets the Energy Star guidelines for energy efficiency.

All information regarding non-Canon products was compiled from publicly available information. No representation is made regarding the accuracy thereof.

Trademarks

Canon and BJ are registered trademarks and Bubble Jet and S800 are trademarks of Canon Inc.

Canon U.S.A., Inc.
Digital Home and Personal Systems Division
2995 Redhill Avenue
Costa Mesa, CA 92626

Printed in Japan.

Part number QA7-1301

Contents

Chapter 1: Basic Printing	
What Is a Printer Driver?	1
Selecting the S800 Photo Printer for Use	2
Printing Photographs	3
Using Specialty Media	4
Cancelling a Print Job	14
Setting Driver Options	15
Chapter 2: Advanced Print Features	
Using Recommended Paper or Specialty Media	19
Smoothing Rough or Jagged Edges (for Windows)	19
Optimizing Color Photographs	20
Adjusting Print Quality	22
Adjusting Color Balance, Brightness and Saturation	23
Saving and Recalling Driver Settings	24
Chapter 3: Printing Maintenance	
Monitoring Ink Levels	27
Replacing Ink Tanks	28
Printing a Nozzle Check Pattern	30
Cleaning the Printhead	32
Chapter 4: Troubleshooting	
Tips for Troubleshooting	35
Customer Care Center	44
Chapter 5: The BJ Solution Software– Downloading Images	
Minimum System Requirements	46
Installing the BJ Solution Software	46
Accessing the Online Manual	47
Windows Users: Using Your Software	48
Windows Users: Uninstalling the BJ Solution Software	50
Macintosh Users: Using Your Software	50
Macintosh Users: Uninstalling the BJ Solution Software	52

Appendix

Installing the Printer Driver	53
Uninstalling the Printer Driver	55
Registering Your Canon Product	56
System Requirements	56
Safety Information	57
Regulatory Information	60
Product Specifications	62
Limited Warranty—U.S. Only	64
Index	67

Chapter 1: Basic Printing

Congratulations on purchasing your new Canon® S800 Color Bubble Jet™ Photo Printer!

This chapter describes basic features of your S800 photo printer and provides instructions on how to set up and print documents and photographs.

The following topics are presented in this chapter:

- What Is a Printer Driver?
- Selecting the S800 Photo Printer for Use
- Printing Photographs
- Using Specialty Media
- Cancelling a Print Job
- Setting Driver Options



Note

This User's Guide describes some of the features of your S800 photo printer and how to use them. For more detailed information, view and/or print the *S800 Reference Guide* on the Setup Software & Reference Guide CD-ROM.



Note

Driver features described in this guide may be different for Windows NT® 4.0 and Windows 2000 users.

What Is a Printer Driver?

Most computers require special software to link the programs you use to create documents or images with the printer. This special software, called a *printer driver*, converts the information from the software application into a format that the printer can understand, and provides other handy features, such as monitoring the levels of ink in the printer.

Selecting the S800 Photo Printer for Use

If the S800 is the only printer connected to your computer, it will automatically be used every time you print. However, if your computer has access to multiple printers, you can set the S800 as the default (main) printer. In Windows[®], you can also select a printer for one-time use within an application.



To set the S800 as the default printer in Windows[®]:

1. Click **Start**, then **Settings**, then **Printers**.
2. Right-click the **Canon S800** printer icon, then click **Set as Default**. The Canon S800 printer icon will now display with a check mark that indicates it is the default printer.



To select the S800 from within a Windows application:

For Windows users, if another printer is set as the default printer, you can still select the Canon S800 for a specific print job from within most applications.

(Mac[®] users can change the selected printer at any time by changing the default, described above.)



Note

Menus vary from application to application. Consult your application user documentation if the Printer Setup menu option is not listed.

1. From the **File** menu, click **Print**.
2. Select **Canon S800** from the Name drop-down list, then click **OK**.



To select the S800 in Mac[®] OS:

1. Click **Apple**, then **Chooser**.
2. Click the **S800** printer icon. The S800 will remain the default printer until another is selected.

Printing Photographs

For highest quality results when printing digital photographs with your S800 photo printer, it is recommended that you use Canon Photo Paper Pro. See “Using Specialty Media” on page 4 for more information.



To print photographs from a Windows application:

1. Load the printer with specialty media. See “Using Specialty Media” on page 4 for more on how to load various media types.
2. Open the digital photograph to be printed in a software application.
3. From the software application **File** menu, select **Print**, then **Properties**. The Canon S800 Properties window will appear.
4. Select **SuperPhoto** as the print mode, then select the appropriate media type.
5. Click **OK** to close the window.
6. Click **OK** again to print your digital photograph.



To print photographs from a Mac application:

1. Load the printer with specialty media. See “Using Specialty Media” on page 4 for how to load various media types.
2. Open your digital photograph to be printed in a software application.
3. From the software application **File** menu, select **Print**. The Canon S800 print dialog will appear.
4. Select **Photo** as the print mode, then select the appropriate media type.
5. Click **Print** to print your digital photograph.

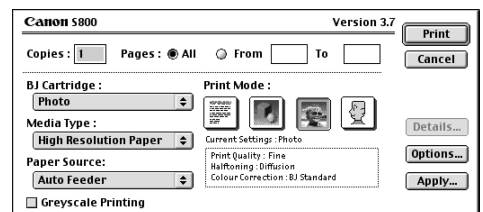

Caring for your Photographs

The Canon S800 photo printer will generate spectacular results for printing photographs, especially when used with Canon specialty media. All images are susceptible to fading over time, but proper care of prints made from your S800 photo printer will insure that print quality lasts long into the future.

There are many environmental factors that impact how long a printout will last before noticeable image fading occurs. Exposure to sunlight or other light sources, humidity, temperature, exposure to cigarette smoke and ozone are just some of the factors that can impact image permanence. While many of these variables cannot be controlled, there are basic measures that you can take to prolong image quality:

- Use Canon Photo Paper Pro and genuine Canon inks. Canon Photo Paper Pro is available in both letter size (8 1/2" x 11") and photo size (4" x 6"), and is specifically designed to work with genuine Canon inks.
- Mount images under glass to reduce exposure to ozone, cigarette smoke and other environmental factors that can degrade images.
- Keep printed images out of direct sunlight or other intense light sources.

See "Using Specialty Media" for more information.

Using Specialty Media

For optimal results, Canon recommends that you use genuine Canon media with your S800 photo printer. Be sure to follow all instructions on storing, handling, and printing on the media.

For General Printing

For everyday paper printing, use Canon Bubble Jet Paper, Canon Brilliant White Paper or plain paper (17 to 23 lb.).

Use standard #10 envelopes with your S800 photo printer.

For Quality Image Printing

Canon Photo Paper Pro: Thick paper coated with a glossy surface. Ideal for reproducing the natural color of photographic images, this is the best choice for printing photographs with the S800.

Canon High Gloss Photo Film: A film sheet with a higher gloss than glossy photo paper. Use this media to obtain high quality reproduction of photo color. Use this media to reproduce photographic images of highly reflective surfaces like metal or glass.

Canon Glossy Photo Paper: Covered with a glossy coating on the print side of the sheet to provide near-photographic quality with the gloss feel of a photographic print. This media is slightly heavier than Canon High Resolution Paper.

Canon High Resolution Paper: Coated paper that produces more vivid color than plain paper. Ideal for printing business documents that include large numbers of color illustrations and graphs.

Canon Photo Paper Pro (4" x 6"): A 4" x 6" size of the same stock as Canon Photo Paper Pro. Print over the perforated borders then remove the borders to trim away white margins. Specifically designed for PhotoRecord for Windows Version 1.2 or later, or ImageBrowser for Macintosh Version 1.4 or later, both of which are included on your CD-ROM.

Canon Glossy Photo Cards (4" x 6"): A 4" x 6" size of the same paper stock as Canon Glossy Photo Paper. Print over the perforated borders then remove the borders to trim away unwanted white margins. Use this medium when you want to print an image over the entire card.

For Creative Media

Canon T-Shirt Transfers: Easy-to-use T-Shirt Transfers can be ironed on to cotton or cotton/poly blend fabric. You can personalize T-shirts or even create team uniforms. Beautify the home by applying transfer designs to tablecloths, pillowcases or aprons.

Canon Magnet Sheets: Canon Magnet Sheets turn your personalized messages and images into unique magnets in seconds. Create a fun, useful magnet using images, photos and text. Print your creations and easily cut them to any shape or size with scissors, then stick your magnet to your refrigerator, file cabinet or other metal surface.

Canon Transparencies: Use to prepare presentations for an overhead projector. Never attempt to use photocopier or laser printer OHP film with the S800.

Canon Banner Paper: Allows you to print on up to six connected sheets of letter-size paper to create party or advertising banners. The banner paper is the same stock as Canon Bubble Jet Paper.



Note

For instructions on loading these creative media, see “Loading Media into the S800” on page 8 or see the *S800 Reference Guide* on the Setup Software & Reference Guide CD-ROM.

Media to Avoid

Never load the following types of media into your S800 photo printer. These media could produce poor quality and jam or damage the printer:

- Folded paper
- Excessively curled, wrinkled or wrapped paper
- Damp paper
- Excessively thin paper
- Excessively thick paper
- Paper with pasted photos, stickers, etc.
- Envelopes with overlapping flaps or self-sealing flaps
- Tractor feed paper, perforated paper or 3-hole punched paper
- Paper with any type of attached fasteners, ribbons, etc.

Printing on Thick Paper

Paper Thickness

Keep these points in mind when selecting media for your S800 photo printer.

Feed Method	Thickness Range	Comment
Automatic	17 – 65 lb.	Load plain paper or other media that is within this thickness range.
Manual	17 – 133 lb.	Load plain paper or other media thicker than 17 lb. but not thicker than 133 lb. You can also manually load any media that falls within the thickness range for automatic feed.

Load Limit and Paper Thickness Lever Position

Media Type	Sheet Feeder Load Limit	Paper Thickness Lever Position
Plain paper	100 sheets (17 lb.)	Up
Photo Paper Pro	1 sheet	Up
High Gloss Photo Film	1 sheet	Up
Glossy Photo Paper	10 sheets	Up
High Resolution Paper	80 sheets	Up
Photo Paper Pro 4" x 6"	20 sheets	Up
Glossy Photo Cards	1 sheet	Up
Transparencies	10 sheets	Up
Banner Paper	1 sheet (can print up to 6 connected sheets)	Down
T-Shirt Transfer	1 sheet	Up
#10 Envelopes	10 envelope	Down
Magnet Sheets	1 sheet	Up

To print on thick paper:

When you print on thick paper, manually feed paper into the manual feed slot in the back of printer:

1. Make sure the printer is turned on, then lower the paper thickness lever to the envelope mark.
2. With the side to be printed facing up, carefully align the sheet with the left side of the manual feed slot, then insert the sheet until the printer grabs it and feeds it partially into the printer.

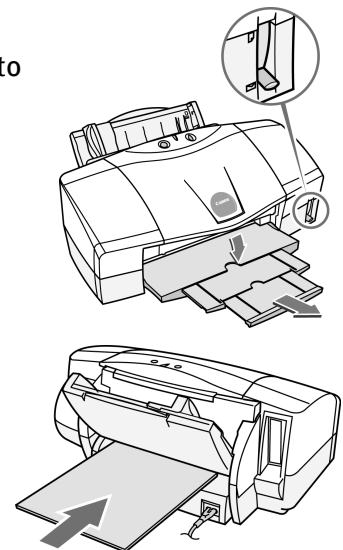

3. In the driver, select the setting for thick paper.



For Windows:

- a. From the software application **File** menu, select **Print**, then **Properties**.
- b. On the Main tab, select **Other Paper** for the Media Type.
- c. When the message asks you to confirm your selection, click **OK**.



For Mac OS:

- a. From the software application **File** menu, select **Print**.
- b. In the Print window, select **Other Paper** for the Media Type.
- c. When the message asks you to confirm your selection, click **OK**.

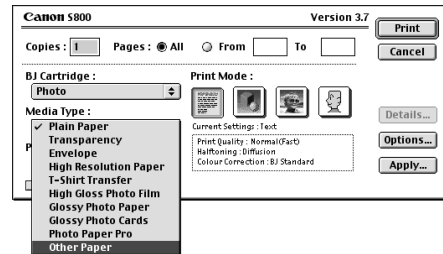

Loading Media into the S800

Follow these instructions for loading media into the printer.



For instructions on loading transparencies and banner paper, see the *S800 Reference Guide* on the Setup Software & Reference Guide CD-ROM.

To load plain or High Resolution Paper:

1. Raise the paper thickness lever to the paper mark.
2. Slide the paper guide completely to the left.

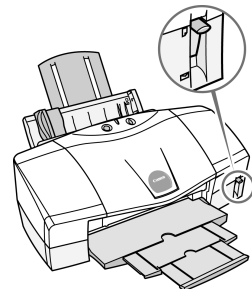

3. Fan the edges of the sheets to remove static cling. Tap the edges of the stack against a flat surface so the stack is aligned.

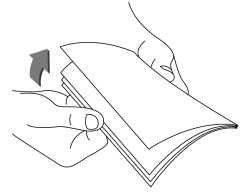

4. With the whiter side facing up, align the stack with the right side of the sheet feeder.

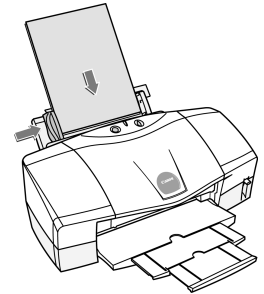

5. Slide the paper guide right to the edge of the sheet.



You can load up to 100 sheets of plain (17 lb.) paper or 80 sheets of High Resolution Paper in the sheet feeder at one time.

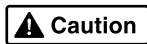

- To prevent paper jams, always fan the sheets and align the edges before you load them into the printer.
- Handle media carefully by its edges. Never touch the print surface (the glossy side of the sheets). Dirt or fingerprints on the print surface will adversely affect print quality.
- When you use High Resolution Paper, do not touch the whiter print side.

To load Photo Paper Pro:

1. Raise the paper thickness lever to the paper mark.
2. Slide the paper guide completely to the left.
3. Set the roller cleaning plate (provided with the printer) into the sheet feeder.
4. Align the roller cleaning plate with the right side of the sheet feeder.

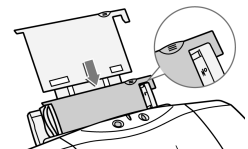

5. With the glossy side facing up, place the sheet of Photo Paper Pro on top of the roller cleaning plate, align the sheet with the right side of the sheet feeder, then insert the sheet into the printer until it stops.
6. Slide the paper guide right to the edge of the sheet.



Load only one sheet of Photo Paper Pro in the sheet feeder at a time.

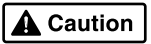

Handle media carefully by its edges. Never touch the print surface (the glossy side of the sheets). Dirt or fingerprints on the print surface will reduce print quality.

To load High Gloss Photo Film:

1. Raise the paper thickness lever to the paper mark.
2. Slide the paper guide completely to the left.
3. With the print side facing up, align a sheet of High Gloss Photo Film with the right side of the sheet feeder and insert the sheet into the printer until it stops.
4. Slide the paper guide right to the edge of the sheet.



- You can load only one sheet of High Gloss Photo Film in the sheet feeder at a time.
- Load the sheet of High Gloss Photo Film with the cut corner in the upper right corner to ensure that the correct print side is facing up.

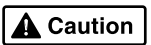

- Handle media carefully by its edges. Never touch the print surface (the glossy side of the sheets). Dirt or fingerprints on the print surface will reduce print quality.
- To prevent changes in color, never stack printed sheets after they have been printed.
- Cover printed sheets with one sheet of plain paper to protect the printed surface, even if you intend to store them in clear plastic folders.

To load Glossy Photo Paper:

1. Raise the paper thickness lever to the paper mark.
2. Slide the paper guide completely to the left.
3. Set the roller cleaning plate (provided with the printer) into the sheet feeder.
4. Align the roller cleaning plate with the right side of the sheet feeder.
5. With the glossy side facing up, place the sheet of Glossy Photo Paper on top of the roller cleaning plate, align the sheet with the right side of the sheet feeder, then insert the sheet into the printer until it stops.
6. Slide the paper guide right to the edge of the sheet.

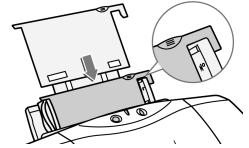

You can load up to 10 sheets of Glossy Photo Paper in the sheet feeder at a time.

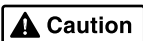

- Handle media carefully by its edges. Never touch the print surface (the glossy side of the sheets). Dirt or fingerprints on the print surface will reduce print quality.
- To prevent changes in color, never stack printed sheets after they have been printed.
- Cover printed sheets with sheets of plain paper to protect the printed surface, even if you intend to store them in clear plastic folders.

To load Photo Paper Pro (4" x 6") or Glossy Photo Cards:

1. Raise the paper thickness lever to the paper mark.
2. Slide the paper guide completely to the left.
3. With the glossy side up, place the sheet of media on top of the Loading Support Sheet provided with the pack of Glossy Photo Cards or Photo Paper Pro and align both sheets.

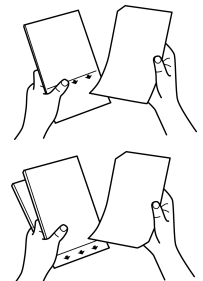

4. Slide the paper guide right to the edge of the sheet.



- You can load up to 20 sheets of Photo Paper Pro 4" x 6" or one Glossy Photo Card at a time with the loading support sheet.
- Make sure that the loading support sheet is pointing down in the direction of the arrow.
- To avoid jamming, never load a Glossy Photo Card or a sheet of Photo Paper Pro 4" x 6" that is curled or bent, and make sure that the edges of the card and the loading support sheet are aligned before setting them in the printer.

5. Align the stack with the right side of the sheet feeder, the insert the stack into the printer.

6. Slide the paper guide right to the edge of the stack.

To load T-Shirt Transfers:

1. Raise the paper thickness lever to the paper mark.
2. Slide the paper guide completely to the left and raise the paper rest.
3. Load the T-Shirt Transfer with the printing side (side without the green line) facing up.
4. Slide the guide right to the edge of the sheet.

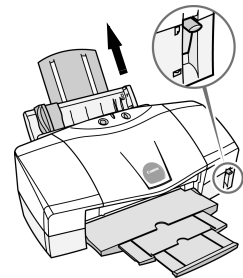

- Load only one T-Shirt Transfer at a time.
- Transfer the image to the T-shirt as soon as possible. See the instructions provided with the T-Shirt Transfers.

To load envelopes:

1. Lower the paper thickness lever to the envelope mark.
2. Slide the paper feed guide completely to the left.
3. Press down on the corners and sides of the envelopes to make them as flat as possible by expelling all of the air in them. To avoid paper jams, make sure the envelopes are flat before you load them into the sheet feeder.
4. With the address side facing up and pointed down, align the stack with the right side of the sheet feeder, then insert the stack into the printer.
5. Slide the paper guide right to the edge of the sheet.

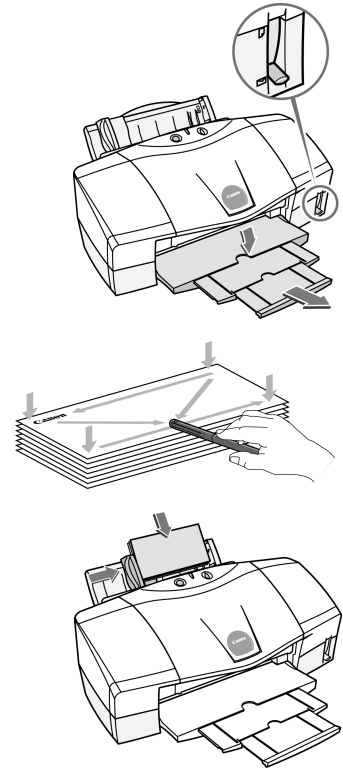

Note

- Make sure that none of the flaps are overlapping.
- If the edges of the envelopes are not sharp, crease them with the side of a pen.
- You can load up to 10 standard #10 envelopes in the sheet feeder.
- Do not allow more than 10 envelopes to stack on the paper output tray.

Cancelling a Print Job

There are several ways to cancel a print job in progress:

To cancel a print job using the printer buttons:

After a print job has started, click the **Resume** button on the printer.

The print job will be cancelled and the paper ejected.

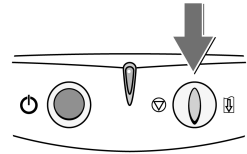

To cancel a print job using The BJ Print Monitor:

You can use the BJ Backgrounder or BJ Print Monitor to cancel print jobs. See the *S800 Reference Guide* on the Setup Software & Reference Guide CD-ROM for more information.

To cancel a job using the BJ Print Monitor, click **Cancel** after the print job has started.

The print job will be cancelled and the paper ejected.

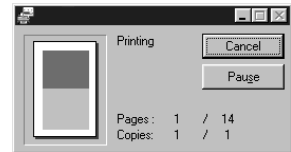

To cancel a print job from Windows:

1. Click **Start**, then **Settings**, then **Printers**.
2. Double-click **Canon S800**, click the print job, then press the **Delete** key.

The print job will be cancelled and the paper ejected.



To cancel a print job using Mac:

On your keyboard, press the Apple™ Command key (**⌘**) and the period key (**.**) at the same time.

The print job will be cancelled and the paper ejected.

Setting Driver Options

The S800 printer driver can be customized to give you the best quality output.



Note

This topic describes the main options. For more options, see the *S800 Reference Guide* on the Setup Software & Reference Guide CD-ROM.

Print Mode

Your S800 photo printer offers the following modes of operation. Each mode adjusts the driver settings for the type of project you are printing:



For Windows:

- Standard** Use to print text documents.
- SuperPhoto** Use to print photographs or color images.
- DTP** Use to print documents that contain text and color photos, business graphics, etc. The printer driver automatically distinguishes between text and photos or graphics and adjusts the printing for the best results.
- Camera** Use to print photographs taken with a digital camera. This setting will produce the best color and will also compensate for underexposure and overexposure in the original image.
- Draft** Use to print draft versions of documents. Draft mode prints faster and uses less ink than other modes.



For Mac:

- Text** Use to print text documents.
- Graphic** Use to print documents that contain text and color photos, business graphics, etc. The printer driver automatically distinguishes between text and photos or graphics and adjusts the printing for the best results.
- Photo** Use to print photographs or color images.
- Manual** Use to save manually set options for later use.



- The Media Type will automatically change when you select a print mode, but you can select another media if desired. See “Using Specialty Media” on page 4 for a description of each media type.
- You can adjust the Print Quality setting if needed. See the *S800 Setup Software & Reference Guide* on the CD-ROM for details.



To set the print mode in Windows:

1. From an application **File** menu, click **Print**.
2. Make sure **Canon S800** is the selected printer, then click **Properties**.
3. On the **Main** tab, click the **Mode** that best describes your print job, then click **OK**.



To set the print mode in Mac OS:

1. From a Macintosh application **File** menu, select **Print**.
2. Select the **Mode** that best describes your print job.

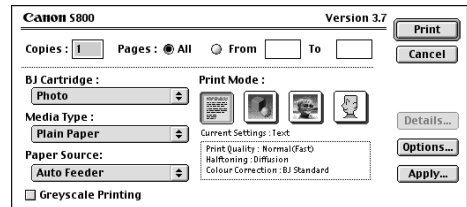

Paper Size and Orientation

Your S800 photo printer offers you the choice of printing vertically on the paper, called *portrait* orientation, or horizontally, called *landscape* orientation.

Portrait Orientation

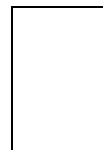

Landscape Orientation



To change paper size and orientation in Windows:

1. From an application **File** menu, select **Print**.
2. Make sure **Canon S800** is the selected printer, then click **Properties**.
3. Click the **Page Layout** tab.
4. Select a paper size from the Page Size drop-down list.
5. Under Orientation, click **Portrait** or **Landscape**. The preview box displays the orientation selected.
6. Click **OK**.



See the *S800 Reference Guide* on the Setup Software & Reference Guide CD-ROM for detailed instructions on using these and other options.



To change paper size and layout in Mac OS:

1. From a Macintosh application **File** menu, select **Page Setup**.
2. Select a paper size from the Paper Size drop-down list.
3. Click on an **Orientation icon** to change the page orientation.
4. Click **OK**.

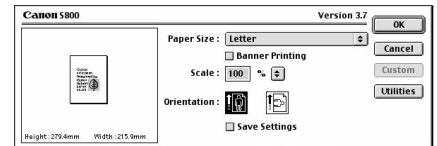

For details about all of the printer driver features, see the *S800 Reference Guide* on the Setup Software & Reference Guide CD-ROM.

Chapter 2: Advanced Print Features

This chapter provides information on how to use the S800 photo printer options to enhance printed color images.

If your print results using pre-set print modes are unsatisfactory, you may be able to improve the printing quality by:

- Using Recommended Paper or Specialty Media
- Smoothing Rough or Jagged Edges (for Windows)
- Optimizing Color Photographs
- Adjusting Print Quality
- Adjusting Color Balance, Brightness and Saturation
- Saving and Recalling Driver Settings

Using Recommended Paper or Specialty Media

You can significantly improve the quality of a picture or an image by using the recommended paper or specialty media. Specialty media best suited for printing color are Photo Paper Pro, Photo Paper Pro 4" x 6", High Resolution Paper, Glossy Photo Paper and High Gloss Photo Film.

These specialty media reproduce colors better than plain paper. For more information, see "Using Specialty Media" on page 4.



Smoothing Rough or Jagged Edges (for Windows)

Use the Image Optimizer feature to smooth rough or jagged images.

1. From an application **File** menu, select **Print**.

Advanced Print Features

2. Make sure **Canon S800** is the selected printer, then click **Properties**.
3. From the **Main** tab, click **Advanced**. A Properties dialog will appear for the print mode selected.
4. From the **Quality** tab, click the **Image Optimizer** check box.
5. Click **OK** to close the print mode Properties window.
6. Click **OK** to close the S800 Properties window.

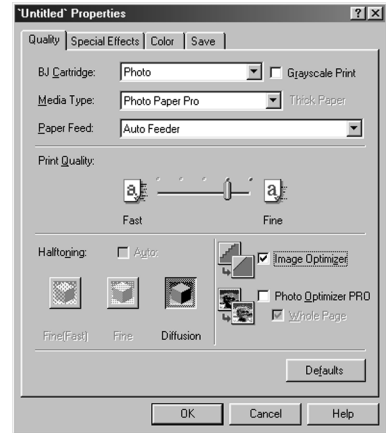

Optimizing Color Photographs

Depending on the conditions under which you took a photograph, sometimes the natural colors in the photograph may not be accurately reproduced in the printed image.

For realistic color reproduction, use the Photo Optimizer PRO feature. Photo Optimizer PRO adjusts color automatically if the original image color is unsatisfactory.



Note

The Photo Optimizer PRO is automatically selected when you use Camera as the Print Mode.



To optimize color photographs in Windows:

1. From an application **File** menu, select **Print**.
2. Make sure **Canon S800** is the selected printer, then click **Properties**.
3. On the **Main** tab, click **Advanced**.
4. On the **Quality** tab, click **Photo Optimizer PRO**.

5. If you want Photo Optimizer PRO to process the entire page, check **Whole Page**.

If you want only the photo image optimized, leave this box unchecked.

6. Click **OK** to close the print mode Properties window.

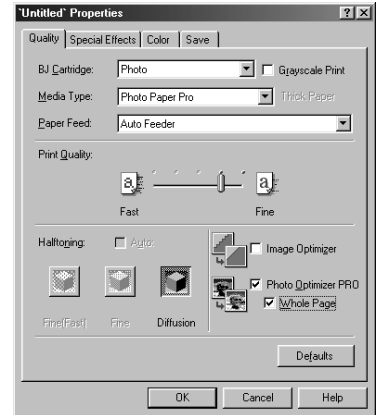

To optimize color photographs in Mac OS:

1. From an application **File** menu, select **Print**.
2. Click the **Manual** print mode icon, then **Details**. The Print Quality dialog box will open.
3. Check the **Photo Optimizer PRO** option.
4. If you want Photo Optimizer PRO to process the entire page, check **Apply Throughout Page**.

If you want only the photo image optimized, leave this box unchecked.

5. Click **OK**.

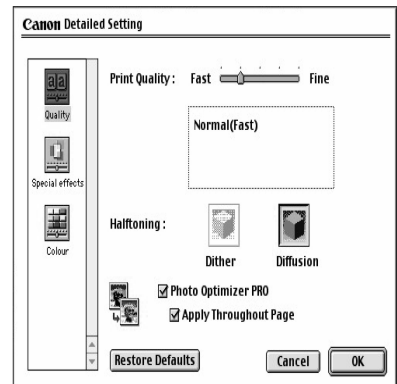

Adjusting Print Quality

You can create a sharper image by specifying the printer add more dots of ink for the image.



Note

The finer the quality, the longer it takes to print a photograph.



To adjust image quality in Windows:

1. From an application **File** menu, select **Print**.
2. Make sure that **Canon S800** is the selected printer, then click **Properties**.
3. On the **Main** tab, click **Advanced**.
4. On the **Quality** tab, slide the **Print Quality slide bar** to the **Fine** setting.
5. Click **OK** to close the Print Mode Properties window.
6. Click **OK** to close the S800 Properties window.

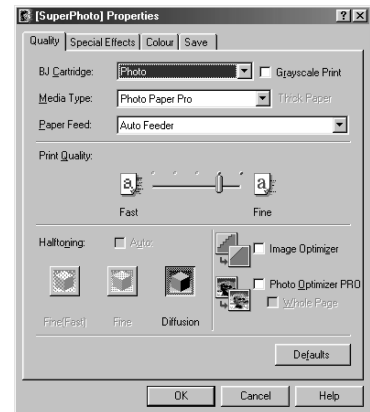

To adjust image quality in Mac OS:

1. From an application **File** menu, select **Print**.
2. Click the **Manual** print mode icon, then **Details**. The Print Quality dialog will appear.
3. Slide the **Print Quality slide bar** to the **Fine** setting.
4. Click **OK**.

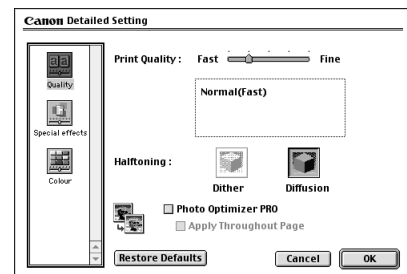

Adjusting Color Balance, Brightness and Saturation

You can enhance color printing by adjusting the color balance, output style (saturation) and brightness.



Note

For detailed information about these settings, see the *S800 Reference Guide* on the Setup Software & Reference Guide CD-ROM.



To adjust color settings in Windows

1. From an application **File** menu, select **Print**.
2. Make sure that **Canon S800** is the selected printer, then click **Properties**.
3. On the **Main** tab, click **Advanced**.
4. Click the **Color** tab.
5. Check the **Color Adjustment** box.
6. Adjust the Color Balance, Output Style (saturation), Brightness, and Intensity settings for your image.
7. Click **OK**.

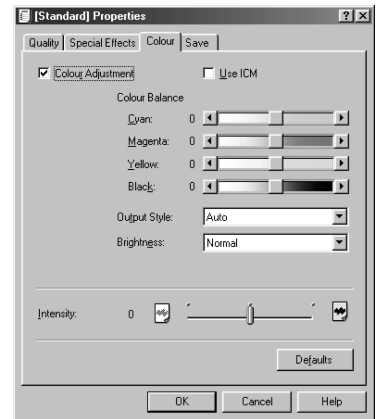

To adjust color settings in Mac OS:

1. From a Mac application, click **File** then **Print**.
2. Click **Manual**, then **Details**.
3. Click **Color**.
4. Adjust the Color Correction, Gamma Correction, Color Balance, and Intensity settings for your image.
5. Click **OK**.

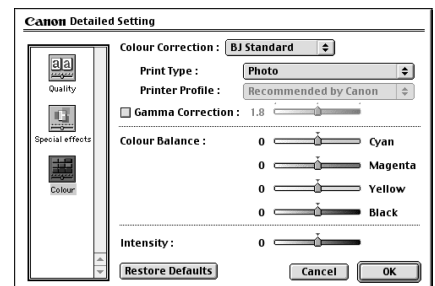

Saving and Recalling Driver Settings

You can assign a name to a combination of driver settings and recall them for future use.



To save driver settings in Windows:

1. From an application **File** menu, select **Print**.
2. Make sure **Canon S800** is the selected printer, then click **Properties**.
3. Make the changes desired, then click **Advanced**.
4. Click the **Save** tab, then type a name for your settings in the Title field.
5. Select an icon. You can later recall the saved settings by clicking this icon.
6. Type a description of your settings if you wish.
7. Click **Save**.



To save driver settings in Mac OS:

1. From an application **File** menu, select **Print**.
2. Click **Apply**. The Register Settings dialog will appear. Click **Apply** again.
3. Type a name for the settings, then click **OK**. The Register Settings window will reappear.
4. Click **Close**.



- To save the new settings as the default setting for the Manual icon, click on the name in the Settings list, then click *Default*.
- See the *S800 Reference Guide* on the Setup Software & Reference Guide CD-ROM for instructions on removing manual settings and restoring default settings.



To recall driver settings in Windows:

1. From an application **File** menu, click **Print**.
2. Make sure **Canon S800** is the selected printer, then click **Properties**.
3. On the **Main** tab, scroll the Print Mode list to the right until you see the name of your saved settings.



To recall driver settings in Mac OS:

1. From an application **File** menu, select **Print**.
2. Click **Apply**, then select the name of your saved settings.
3. Click **Defaults**, then **OK**.
4. Click **Import**, then **Close**.

Chapter 3: Printing Maintenance

This chapter provides information on how to care for the ink delivery system for your Canon S800 photo printer. The following topics are addressed:

- Monitoring Ink Levels
- Replacing Ink Tanks
- Aligning the Printhead
- Printing a Nozzle Check Pattern
- Cleaning the Printhead

Monitoring Ink Levels

The print driver contains a feature that enables you to monitor the level of ink in each ink tank.



To monitor ink levels in Windows:

1. Click **Start**, then **Programs**, then **BJ Printer**, then **BJ Printer Monitor**. The Canon BJ Printer Monitor window will appear.
2. Click on the **Canon S800** icon.
3. From the **Printer Info** menu, click **Start Status Monitor**. The Canon BJ Status Monitor window will appear.

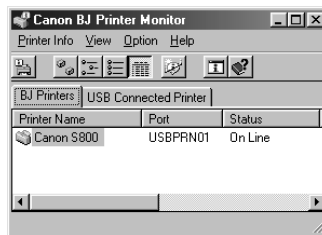

4. Click the **Ink Information** tab to view the levels of ink in each ink tank in your printer.



A message will automatically appear in the S800 Print Monitor reminding you to replace the ink tank levels if you print an image when an ink tank level is low.

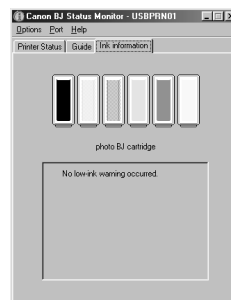

To monitor ink levels in Mac OS:

The S800 Print Monitor can display ink levels when they are running low if you have enabled background printing in the Choose option. See the *S800 Reference Guide* on the Setup Software & Reference Guide CD-ROM for information about this feature.

Replacing Ink Tanks

Follow these steps to replace an empty ink tank.

1. Turn on the printer, then open the front cover. The printhead holder will automatically move to the center.
2. Press the tab on the front of the ink tank, then remove and discard the empty tank.
3. Remove the new ink tank from its package. Pull the orange tape up, remove the wrapper and twist off the orange protective cap.

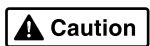
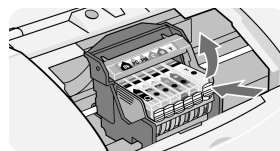

To avoid spilling ink, never press on the sides of an ink tank.

4. Holding the new ink tank at a slight angle, align it with the correct color slot, then gently insert it.

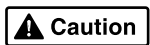
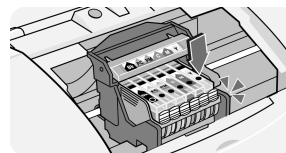

Do not force an ink tank into the printhead. If the ink tank does not go in smoothly, realign it and try again until it does.

5. Press down on the ink tank until it clicks into place.
6. Close the front cover.

Aligning the Printhead

Before using the printer, align the printhead to ensure the best quality printing.



To align the printhead in Windows:

1. Add a sheet of blank paper in the sheet feeder.
2. Click **Start**, then **Settings**, then **Printers**.
3. Right-click the **Canon S800** printer icon, then select **Properties**.
4. From the **Maintenance** tab, click the  Print Head Alignment button:
5. When prompted to print an alignment test page, click **OK**.
6. If the pattern printed successfully, click **Yes**.
7. Compare the different patterns for each color on the printout.



Notice that most patterns have vertical lines, but some in the middle look smooth and uniform.



8. For each color on the test printout, enter the number in the Print Head Alignment window that corresponds with the smoothest looking test pattern.
9. When finished, click **OK**.

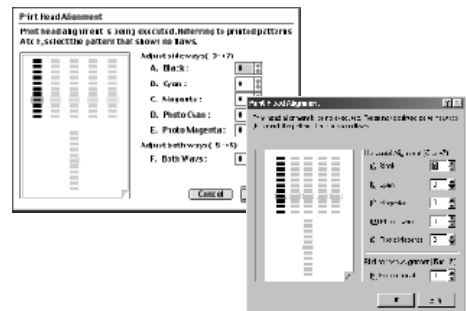

To align the printhead in Mac OS:

1. Add a sheet of blank paper in the sheet feeder.
2. From the **File** menu in a software application, click **Page Setup**.
3. Click the **Utilities** button.
4. Click the down-arrow to select **Test Print**.

Printing Maintenance

- Click the Print Head Alignment button:



- When prompted to print an alignment test page, click **OK**.
- Compare the different patterns for each color on the printout.

Notice that most patterns have vertical lines, but some in the middle look smooth and uniform.



- For each color on the test printout, enter the number in the Print Head Alignment window that corresponds with the smoothest looking test pattern.
- When finished, click **Send**.

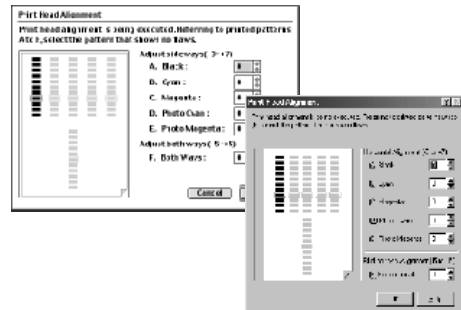

Printing a Nozzle Check Pattern

The contact area of the printhead that discharges ink contains nozzles, tiny openings from which the ink is sprayed. You may see faded or streaked colors and text in your printed output if the nozzles are clogged or the printhead is not aligned.

You can check for these problems by printing a nozzle check pattern.



To print a nozzle check pattern in Windows:

1. Make sure the printer is turned on.
2. Click **Start**, then **Settings**, then **Printers**.
3. Right-click the **Canon S800** printer icon and select **Properties**.
4. Click the **Maintenance** tab, then click the Nozzle Check Pattern button:

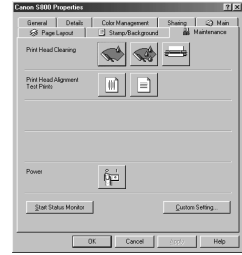

Note

The Maintenance tab button may vary for Windows NT[®] 4.0 and Windows 2000.

5. Read the messages, then click **OK**. The nozzle test pattern will print.
6. Check the nozzle check pattern. If part of the top pattern is missing, clean the printhead. See “Cleaning the Printhead” on page 32 for instructions.



If the bottom pattern is streaked vertically with white, align the printhead. See “Aligning the Printhead” on page 29 for instructions.



To print a nozzle check pattern in Mac OS:

1. Make sure the printer is on.
2. In a software application, click **File**, then **Page Setup**.
3. Click **Utilities**. The Canon S800 Printer Utility dialog will display.
4. Select **Test Print** from the drop-down list. The test print options will display.
5. Click the **Nozzle Check** button: Read the messages, then click **OK**. The nozzle test pattern will print.

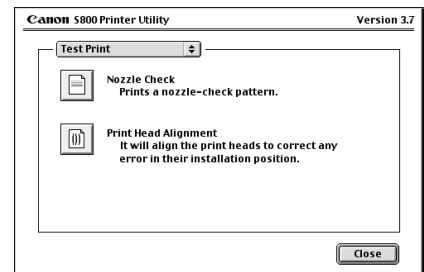

6. Check the nozzle check pattern. If part of the top pattern is missing, clean the printhead. See “Cleaning the Printhead” on page 32 for instructions.



If the bottom pattern is streaked vertically with white, align the printhead. See “Aligning the Printhead” on page 29 for instructions.



Cleaning the Printhead

If your printed output appears faded, streaked or scratchy, the printheads may need to be cleaned. See the *S800 Reference Guide* on the Setup Software & Reference Guide CD-ROM for additional corrective actions.



Note Printhead cleaning consumes ink. Avoid unnecessarily cleaning.



To clean the Printhead in Windows:

1. Make sure the printer is turned on.
2. Click **Start, Settings**, then **Printers**.
3. Right-click the **Canon S800** printer icon, then select **Properties** from the pop-up menu. The Canon S800 Properties window will display.

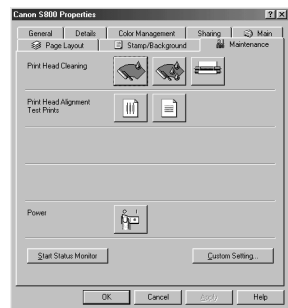

4. Click the **Maintenance** tab, then click the cleaning button:



Note The Maintenance tab and procedures may vary for Windows NT 4.0 and Windows 2000. Follow the instructions when prompted for those operating systems.

5. For each message displayed, click **OK**.

The BJ Status Monitor opens automatically and closes when the printhead cleaning is done. The POWER/ERROR light on the printer flashes green during the cleaning process.

6. Print a nozzle check pattern to check the results of the printhead cleaning. See “Printing a Nozzle Check Pattern” on page 30 for instructions.
7. If there is no change after cleaning, check the amount of ink remaining. If an ink tank is empty, replace it. See “Monitoring Ink Levels” on page 27 for instructions on how to check ink tank levels.



To clean the Printhead in Mac OS:

1. Make sure the printer is on.
2. In a software application, click **File**, then **Page Setup**.
3. Click **Utilities**. The Canon S800 Printer Utility dialog will display.
4. Select **Cleaning** from the drop-down list. The cleaning options will display.
5. Click the **Cleaning** icon: 
6. Read the message, then click **OK**.
7. Print a nozzle check pattern to check the results of the printhead cleaning. See “Printing a Nozzle Check Pattern” on page 30 for instructions.

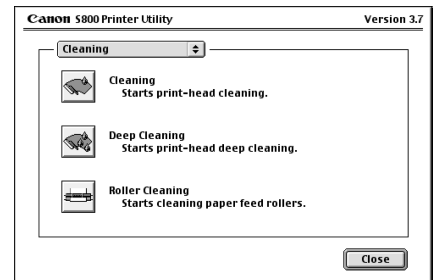

Chapter 4: Troubleshooting

Tips for Troubleshooting

Troubleshooting usually falls into one of the following categories:



Installation The printer driver will not install properly.



Printer Hardware The printer is not working or not working as expected.



Printed Output The printed output is not coming out as expected.



Error Message You are getting an error message from the software (displayed on the screen) or the printer (indicated by blinking lights).





Customer Care Center Canon offers a full range of customer technical support options.

If you encounter difficulties during installation or operation of your Canon S800 photo printer, quickly scan all topics until you find a description that approximates your difficulty. Go through the related solutions until you find one that works.





Troubleshooting Installation



PROBLEM	POSSIBLE CAUSE	TRY THIS
Cannot install the printer driver	Procedure not followed correctly	See “Installing the Printer Driver” on page 53, or see the <i>S800 Reference Guide</i> on the Setup Software & Reference Guide CD-ROM for more information.
	Previous version of printer driver or same printer driver already installed on computer	Always uninstall the previous version of the printer driver before installing the new version. See “Uninstalling the Printer Driver” on page 55.
	Other applications running in the background	Other open applications on your computer can interfere with the installation routine. Close any software applications on your computer before reinstalling the printer driver. See “Installing the Printer Driver” on page 53.
	Installation not starting automatically when CD is inserted into drive	 <p>WINDOWS If printer driver installation did not start automatically when you loaded the CD-ROM:</p> <ol style="list-style-type: none"> 1. Double-click My Computer on the Windows desktop, then double-click the CD-ROM drive. 2. Double-click msetup.exe. <p>If you install the printer driver by clicking Start, then Run, specify the correct CD-ROM drive and file name (x:\msetup.exe, where x is the CD-ROM drive).</p>
CD-ROM drive not specified	<p>Normally, after you insert the S800 CD-ROM the setup window displays automatically. If it does not:</p>  <p>WINDOWS</p> <ol style="list-style-type: none"> 1. Double-click My Computer on the Windows desktop, then double-click the CD-ROM drive. 2. Double-click msetup.exe.  <p>MACINTOSH™ Double-click the CD-ROM icon on your desktop.</p>	



PROBLEM	POSSIBLE CAUSE	TRY THIS
Cannot install the printer driver <i>(continued)</i>	CD-ROM drive not working properly	 <p>WINDOWS Use Windows Explorer to confirm that the CD-ROM is operating normally:</p> <ol style="list-style-type: none"> 1. From the Desktop, double-click My Computer, then CD-ROM. 2. If the files do not appear, refer to your Windows documentation for more information.  <p>MACINTOSH Open the Apple System Profiler, click Devices and Volumes, then open the CD-ROM.</p>
	Computer cannot detect a printer port	<p>Verify that the correct cable (USB or parallel) is connected to both your printer and your computer, and that the connection is secure.</p> <p>Verify that the computer is turned on and the POWER light is a steady (non-blinking) green.</p> <p>If this does not handle the problem, exit the installation procedure and reinstall the software again.</p> <p>Also see the <i>S800 Reference Guide</i> on the Setup Software & Reference Guide CD-ROM for more information.</p>



Troubleshooting Printer Hardware





PROBLEM	POSSIBLE CAUSE	TRY THIS
Paper jams in the printer	Media jammed during automatic or manual feed	<ol style="list-style-type: none"> 1. Gently pull the jammed paper out of the sheet feeder slot or the paper output slot, whichever is easier. If the paper tears and some of it is left in the printer, turn the printer off, open the front cover, and remove the pieces of paper. If the paper will not pull out of the printer easily, do not force it. 2. Reload paper into either the manual or automatic sheet feeder, then press RESUME on the printer. <p>If you turn the printer off, your print job data will be lost. Print the job again.</p> <p>Use a standard paper size whenever possible to prevent jams.</p>



PROBLEM	POSSIBLE CAUSE	TRY THIS
Printer is not responding	Power cable is not securely connected	Verify that the power cable is securely connected to the printer and plugged into a working outlet.
	Printer is not turned on, or is not ready	Verify that the POWER light is on and glowing a steady green. If the light is off, press the POWER button. The green light will blink as the printer is warming up, then go to a steady (no blink) state when the printer is ready. If the POWER light is blinking green, this indicates that the printer is warming up or is processing a print job. If the POWER light blinks orange, or green and orange alternately, see “Handling Error Messages” on page 42.
	Computer and/or printer needs reset	Reboot the computer and/or reset the printer. To reboot the computer, close all open applications, then restart. To reset the printer, turn it off, then on again.
	Printer and computer cabled together incorrectly	Reconnect the printer cable to the correct port, with the correct cable. See the <i>S800 Reference Guide</i> on the Setup Software & Reference Guide CD-ROM for more information.
	Bad cable	Replace the printer cable.
Printing is slow	Incorrect printer driver or settings	Altering driver settings may improve print speed. For example, draft mode is faster than normal mode, but the quality of the print is lower. See “Setting Driver Options” on page 15 for instructions on selecting the optimum print mode for a print job.
	Computer resources are low; not enough memory	You may not have enough memory (RAM) on your computer. Close any open applications that are not needed for printing. If the problem persists, consider adding more memory to your computer.



PROBLEM	POSSIBLE CAUSE	TRY THIS
Printing is slow <i>(continued)</i>	Computer resources are low; not enough disk space	<p>When a print job is sent to the printer, it first goes to a temporary print spool. If the file is large and you have limited disk space available, this can slow or stop printing.</p> <p> WINDOWS Delete all temporary files (.tmp). If you have Windows 98 or later, you can also run the Disk Cleanup utility:</p> <ol style="list-style-type: none"> 1. From the Start menu, click Programs, then Accessories, then System Tools, then Disk Cleanup. 2. Select the drive you want to clean, then click OK. 3. Check Temporary Files, then click OK. The files will be deleted. <p> MACINTOSH If you run out of disk space on your computer, copy any unused files to floppies, a zip disk or other removable media, then delete the files from your hard disk by dragging into the trash.</p>
Printer tried to print but no ink on paper	Ink tanks are not seated properly	Check the ink tanks, and reseal them if necessary. See “Replacing Ink Tanks” on page 28.
	Printhead clogged	Verify that the printhead is working properly. See “Printing a Nozzle Check Pattern” on page 30, or “Cleaning the Printhead” on page 32. If necessary, perform multiple printhead cleanings. See the <i>S800 Reference Guide</i> on the Setup Software & Reference Guide CD-ROM for more information.
	Ink tanks may need to be replaced	Verify that you have sufficient ink in the ink tanks. See “Monitoring Ink Levels” on page 27. If necessary, replace the ink tanks. See “Replacing Ink Tanks” on page 28.
	Printhead may need to be replaced	Verify that the printhead is working properly. See “Printing a Nozzle Check Pattern” on page 30, or “Cleaning the Printhead” on page 32. If necessary, perform multiple printhead cleanings. See “Cleaning the Printhead” on page 32, or the <i>S800 Reference Guide</i> on the Setup Software & Reference Guide CD-ROM for more information.





Troubleshooting Printed Output



PROBLEM	POSSIBLE CAUSE	TRY THIS
Printout and screen image colors appear different	Low ink	Verify that you have sufficient ink in the ink tanks. See “Monitoring Ink Levels” on page 27.
	Printhead may need to be replaced	Verify that the printhead is working properly. See “Printing a Nozzle Check Pattern” on page 30, and/or “Cleaning the Printhead” on page 32. If necessary, perform multiple printhead cleanings. See “Cleaning the Printhead” on page 32, or the <i>S800 Reference Guide</i> on the Setup Software & Reference Guide CD-ROM for more information.
	Printhead not seated correctly	Reseat printhead. See the <i>S800 Reference Guide</i> on the Setup Software & Reference Guide CD-ROM for procedures.
	Incorrect printer driver or settings	Altering driver settings may improve the appearance of your printed image. See “Setting Driver Options” on page 15 for instructions on selecting the optimum print mode for a print job.
	Color settings need to be adjusted	You can enhance the color on your printout. See “Adjusting Color Balance, Brightness and Saturation” on page 23.
Printed colors are incorrect	One or more ink tanks installed in the wrong position.	Verify that each ink tank is lined up with the correct color label in the printhead. For more information, see “Replacing Ink Tanks” on page 28.
Smudged or smeared ink on paper	Ink tanks are not seated properly	Check the ink tanks, and reseal them if necessary. See “Replacing Ink Tanks” on page 28.
	Printhead clogged	Verify that the printhead is working properly. See “Printing a Nozzle Check Pattern” on page 30, or “Cleaning the Printhead” on page 32. If necessary, perform multiple printhead cleanings. See the <i>S800 Reference Guide</i> on the Setup Software & Reference Guide CD-ROM for more information.
	Ink tank may need to be replaced	Verify that you have sufficient ink in the ink tanks. See “Monitoring Ink Levels” on page 27. If necessary, replace the ink tanks. See “Replacing Ink Tanks” on page 28.



PROBLEM	POSSIBLE CAUSE	TRY THIS
Smudged or smeared ink on paper <i>(continued)</i>	Printhead may need to be replaced	Perform multiple printhead cleanings. See “Cleaning the Printhead” on page 32, or the <i>S800 Reference Guide</i> on the Setup Software & Reference Guide CD-ROM for more information.
Printed output is faded or unclear	Media not loaded print-side up	Check that your media is placed in the printer facing in the correct direction. See “Loading Media into the S800” on page 8.
	Low ink	Verify that you have sufficient ink in the ink tanks. See “Monitoring Ink Levels” on page 27.
	Printhead nozzles clogged or damaged	Verify that the printhead is working properly. See “Printing a Nozzle Check Pattern” on page 30, and/or “Cleaning the Printhead” on page 32. If necessary, perform multiple printhead cleanings. See the <i>S800 Reference Guide</i> on the Setup Software & Reference Guide CD-ROM for more information.
	Ink tanks are not seated properly	Check the ink tanks, and reseal them if necessary. See “Replacing Ink Tanks” on page 28.
	Printhead needs to be aligned	Perform printhead alignment. See “Aligning the Printhead” on page 29.
Meaningless characters printed	Corrupted print instructions are stored in the printer buffer.	<ol style="list-style-type: none"> 1. Turn the printer off to clear the printer buffer. 2. Cancel the print job from the computer. (See “Cancelling a Print Job” on page 14.) 3. Turn the printer on again.
	Previous print job paused before it was finished	<p>If a previous print job was paused before it was printed, turn the printer and the computer off, then back on again, <i>or</i></p> <p>WINDOWS</p>  <ol style="list-style-type: none"> 1. Click Start, Settings, Printers. 2. Double-click Canon S800 and cancel any unfinished print jobs. <p>MACINTOSH</p>  <p>On your keyboard, press the Apple Command key (⌘) and the period key (.) at the same time. The print job will be cancelled and the paper ejected.</p>
	Printer and computer not connected securely	Check the cable connections between the printer and the computer to verify that they are securely connected.



PROBLEM	POSSIBLE CAUSE	TRY THIS
Meaningless characters printed <i>(continued)</i>	Incorrect printer driver selected	Check the Printer window to verify that the correct printer driver is selected.
	Bad (corrupted) file	Create the document again and print it. If it prints successfully, the original file was corrupted.
	ECP mode not set	Extended Capabilities (Parallel) Port, or ECP, provides faster data transfer between the computer and the printer. If the ECP setting is incorrect, it could result in incorrect print information going to the printer. See the <i>S800 Reference Guide</i> on the Setup Software & Reference Guide CD-ROM for instructions on how to check ECP settings and reconfigure if needed.







Handling Error Messages





PROBLEM	POSSIBLE CAUSE	TRY THIS
Printer does not print	When an error occurs, the POWER/ERROR light blinks. Count the number of orange blinks between each green blink to identify the problem:	
	Printer blinks green	When the lamp blinks green, the printer is warming up or is receiving print data from the computer. This is not an error condition.
	2 orange blinks (paper is out, paper jam or paper feed error)	Reload the paper correctly. See “Loading Media into the S800” on page 8 for how to load different types of media. If the paper is jammed, see the troubleshooting topic “Paper jams in the printer” on page 37.
	3 orange blinks (paper jam)	See the troubleshooting topic “Paper jams in the printer” on page 37.
	4 orange blinks (ink tank is out of ink)	Replace the empty ink tank. See “Monitoring Ink Levels” on page 27 and “Replacing Ink Tanks” on page 28.
	5 orange blinks (printhead not installed correctly)	Reseat printhead. See the <i>S800 Reference Guide</i> on the Setup Software & Reference Guide CD-ROM for procedures.



PROBLEM	POSSIBLE CAUSE	TRY THIS
Printer does not print <i>(continued)</i>	6 orange blinks (printhead not installed)	Install the printhead. If already installed, remove it, then check the electrical contact area for any blockage or protective tape. Re-install it when done. See the <i>S800 Reference Guide</i> on the Setup Software & Reference Guide CD-ROM on the CD-ROM for procedures.
	7 orange blinks (printhead defective)	Make sure that you are using the printhead designed specifically for the S800. Turn the printer off and on. If the problem persists, contact the Customer Care Center.
	Printer blinks green and orange alternately	If the printer starts blinking green and orange alternately, turn the printer off, unplug it from the power outlet, and wait a few minutes. Plug it into the power outlet again, turn on the printer, then restart the print job. If the problem persists, contact the Customer Care Center.
Low ink alert displays in the BJ Print Monitor	One or more of the ink tanks is low	When Backgrounding is turned on, you can confirm the low ink alert in the BJ Print Monitor. (See the <i>S800 Reference Guide</i> on the Setup Software & Reference Guide CD-ROM for more information on using the BJ Print Monitor.) After the alert displays, you can continue printing for a short time, but have a replacement ready to install. WINDOWS  The low ink alert displays in the BJ Status Monitor. Click the Ink Information tab to determine which ink tank is low. MACINTOSH  The low ink alert displays in a status dialog before a print job starts.
Error message displays in the BJ Status Monitor	Printer is out of paper, ink is low, paper jam	WINDOWS  The BJ Status Monitor opens and displays a message when an error occurs. Read the error message, then click the Guide tab to display more information about solving the problem. MACINTOSH  If Backgrounding is turned on with the Chooser, the BJ Print Monitor displays an error. Follow the instructions in the message to resolve the problem. See the <i>S800 Reference Guide</i> on the Setup Software & Reference Guide CD-ROM for more information on error messages.



PROBLEM	POSSIBLE CAUSE	TRY THIS
System error message displays	System error occurred	<p>If a system error occurs, printing stops.</p> <p> WINDOWS A window displays the error message. System errors may include problems writing to LPT1 or USBPRN, application errors, or general protection faults. Make sure that the printer is turned on, the printer and computer are connected securely, and that the printer port is operating correctly.</p> <p> MACINTOSH The error message contains an error code *XXX, where * is a letter and XXX is a number, which represents the cause of the error. Make sure that the printer is turned on, the printer and computer are connected securely, and that the printer port is operating correctly.</p>

Customer Care Center

Canon offers a full range of customer technical support* options:

- For e-mail support, the latest driver downloads and answers to frequently asked questions (www.usa.canon.com)
- 24-hour, 7-day-a-week automated support for troubleshooting issues on most current products (**1-800-423-2366**)
- 24-hour, Fax-On-Demand System for product specifications and technical information (**1-800-526-4345**)
- Free technical support Monday–Saturday (excluding holidays) for products still under warranty** (**1-757-413-2848**)
- Technical support 7 days a week (excluding holidays) for products no longer under warranty, at \$9.99 per call (**1-757-413-2848**)



Within Canada, call for technical support 24 hours a day, 7 days a week (**1-800-OK-CANON**).

* Support program specifics are subject to change without notice.

** Refer to the product information starting on page 64 for warranty details.

Chapter 5:

The BJ Solution Software— Downloading Images

The BJ Solution software—a fun way to view, organize, adjust, and print images—includes ZoomBrowser EX and PhotoRecord (for Windows) and ImageBrowser (for Macintosh) and PhotoStitch (for Windows/Macintosh).

Easy-to-use features include:

- **Move, copy, or delete** images stored on computer disks.
- **Crop images and adjust colors** with simple editing tools.
- View all files within a specified folder simultaneously; zoom in and out for easier **visual searches**.
- View your files in **chronological order** via the “time tunnel” window.
- Display images one-by-one at full-screen size using the **slide show function**.
- Merge a series of images into a **panoramic view** using the PhotoStitch feature.
- Produce **photo-like prints** using Canon Photo Paper Pro or Canon Specialty Paper. (See “Using Specialty Media” on page 4.) Print multiple images on a single sheet, and add customized borders and background designs. Even add titles and insert text in images and on pages. Or use a printing utility, **PhotoRecord**, to create your own **personal album**.

Minimum System Requirements



Windows

- Pentium 133 MHz, Windows 95/98 (32 MB RAM), Windows 2000/Windows NT 4.0 (64 MB RAM)



Macintosh

- Mac OS 8.1 or higher, 20 MB RAM

Installing the BJ Solution Software



To Install the BJ Solution Software in Windows:



Driver features and screen shots described in this chapter, reflect Windows 98 and may be different for Windows 2000/Windows NT 4.0 users.

1. Close any open software applications.
2. Insert the BJ Solution CD in the CD-ROM drive. The Choose Destination Location dialog box will open. Click **Next**. To choose another installation folder, click **Browse**, then **OK**.



If the setup program does not run automatically, click **Cancel**, then **Exit**. Click **Start**, then **Run**, and type `x:\setup.exe`, where `x` is your CD-ROM drive.

3. Select the software to be installed. Click **Next**. Follow the on-screen instructions.
4. When the Setup Complete dialog box appears, click **Finish**.



To Install the BJ Solution Software in Macintosh:

1. Close any open software applications and insert the BJ Solution CD in the CD-ROM drive.
2. Double-click the **CanonBJSD** icon on your desktop. Double-click **Install**.
3. Select the software to be installed, then click **Install**. The Choose a Folder dialog box will open.

4. Select the destination folder, then click **Choose**. Follow the on-screen instructions.
5. When the Installation Has Finished dialog box appears, click **OK**.

Accessing the Online Manual

The BJ Solution CD includes an electronic manual that is viewable with Adobe® Acrobat Reader 4.0. Follow the instructions below to install Acrobat Reader, which will enable you to view or print the *BJ Solution Disk User's Manual*.



To install Adobe Acrobat Reader in Windows:

1. On your computer, insert the BJ Solution CD in the CD-ROM drive. The BJ Solution installer program will begin. Click **Cancel**, then **Exit Setup**.
2. Click **Start**, then **Run**, then type **x:\readme\english\acrobat\ar405eng.exe**, where x is your CD-ROM drive. Follow the on-screen instructions.



To view the manual in Windows:

1. Insert the CD in the CD-ROM drive.
2. The BJ Solution installer program will begin. Click **Cancel**, then **Exit Setup**.
3. Click **Start**, then **Run**, then type **x:\readme\english\bj_solution_disk_manual.pdf** where x is your CD-ROM drive. Click **OK**.



To install Adobe Acrobat Reader in Macintosh:

1. On your computer, insert the BJ Solution CD in the CD-ROM drive.
2. From your desktop, double-click the **CanonBJSD** icon, then click **Readme, English, Acrobat, Reader Installer**. Follow the on-screen instructions.



To view the manual in Macintosh:

1. Insert the CD in the CD-ROM drive.
2. From your desktop, double-click the **CanonBJSD** icon. Double-click **Readme, English, BJ_Solution_Disk_Manual.pdf**.

Windows Users: Using Your Software



In this section you'll learn how to:

- Start ZoomBrowser EX
- Print on Canon Photo Paper Pro
- Merge photos to create a panoramic view

Starting ZoomBrowser EX

To Start ZoomBrowser EX:

1. Make sure the images are on your hard drive or other accessible media.
2. Double-click the **Canon ZoomBrowser EX** icon on the desktop to start the program.



If the Canon ZoomBrowser EX icon does not appear on the desktop, click **Start, Programs, Canon Utilities, ZoomBrowser EX, then ZoomBrowser EX.**

3. From the **File** menu, select **Add Image Library**. Identify where the images are stored, and click **OK**. The images will display as thumbnails.



Printing on Canon Photo Paper Pro

To print on Canon Photo Paper Pro:

1. Select a folder or images for printing from the ZoomBrowser EX Display window and click **Print Layout** to start the PhotoRecord program. The selected images will display automatically.

The BJ Solution Software – Downloading Images

2. From the PhotoRecord window, you can drag images to change the layout, input descriptive text or captions, or add images.
3. Click **Album Settings**. The Album Settings dialog box will appear.
4. Make sure the **Canon S800** is the selected printer.
5. Under **Album Type**, select **Canon perforated paper printing**. Canon Photo Paper Pro 4 x 6 will become the default media. The results will preview, click **OK**.
6. Load a sheet of Canon Photo Paper Pro into the paper tray, then click **Instant Print**.



When using Canon Photo Paper Pro 4 x 6, insert the sheets in the direction shown and print on the glossier side. When finished, remove perforated edges. The results look just like a photograph.



Note

Remember, when handling specialty media papers, always follow the instructions included with the media for the best printing results. See “Using Specialty Media” on page 4 for a list of other fun-to-use Canon Specialty Papers.

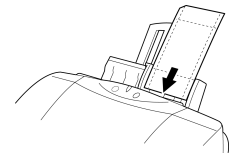

Merging Photos to Create a Panoramic View

You can merge a series of overlapping images into a seamless panoramic view.

To create a panoramic view:

1. Select the images in the ZoomBrowser window, then click **Select All**. The images will highlight. From the **Edit** menu, select **PhotoStitch**. The PhotoStitch program will start.
2. Follow the on-screen instructions to arrange, stitch, rotate, enlarge, or reduce your image.

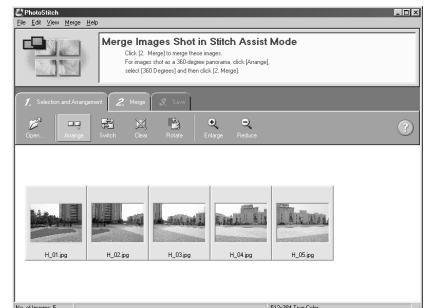

Windows Users: Uninstalling the BJ Solution Software



To uninstall the BJ Solution Software in Windows:

- Click **Start, Programs**. Click **Canon Utilities, ZoomBrowser EX**, then **ZoomBrowser Uninstall**, and follow the on-screen instructions.
- Click **Start, Programs**. Click **Canon Utilities, PhotoStitch**, then **PhotoStitch Uninstall**, and follow the on-screen instructions.

Macintosh Users: Using Your Software



In this section you'll learn how to:

- Start ImageBrowser
- Print on Canon Photo Paper Pro
- Merge photos to create a panoramic view

Starting ImageBrowser

To Start ImageBrowser EX:

1. Make sure the images are on your hard drive or other accessible media.
2. Double-click the **Canon ImageBrowser** icon on the desktop to start the program.
3. Double-click the folder for the device containing your images in the Browser window. The images will display as thumbnails.

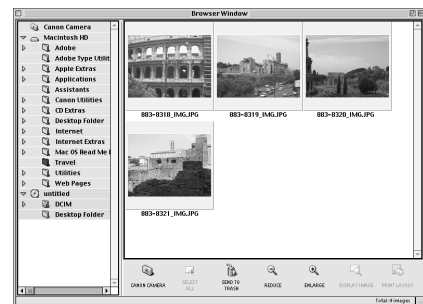

Printing on Canon Photo Paper Pro

To print on Canon Photo Paper Pro:

1. Select the images you desire to print, then click **Print Layout**. The selected images will display automatically.
2. From the Browser window, you can drag images to change the layout, input descriptive text or captions, or add images.
3. Click **Layout Options** in the Print window. The Layout Options dialog box will open.
4. Under **Layout Type**, select **Canon perforated paper**. Canon Photo Paper Pro 4 x 6 will become the default media. Results will preview, then click **OK**.
5. The Paper Registration dialog box will open. Click **OK**.
6. In the Page Setup dialog box, select the **Paper Size** menu and select **Custom 1 - 3**.
7. Click **Custom**. The Custom dialog box will open. Type the Photo Paper Pro values found in the Paper Registration dialog box. Click **Apply**. Make sure to save your setting for future use.
8. Click **OK** in the Page Setup dialog box. The paper size is registered.



Now that Canon Photo Paper Pro has been registered, you can simply select this custom paper size in the Page Setup dialog box for future use.

9. Click **Print**. The printer driver setup screen will open.
10. Load a sheet of Canon Photo Paper Pro into the paper tray. Click **Print**.

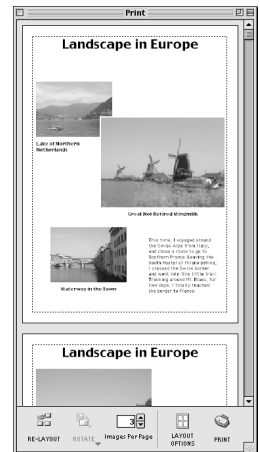

When using Canon Photo Paper Pro 4 x 6, insert the sheets in the direction shown and print on the glossier side. When finished, remove perforated edges. The results look just like a photograph.

**Note**

Remember, when handling specialty media papers, always follow the instructions included with the media for the best printing results. See “Using Specialty Media” on page 4 for a list of other fun-to-use Canon Specialty Papers.

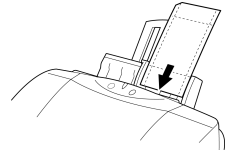

Merging Photos to Create a Panoramic View

You can merge a series of overlapping images into a seamless panoramic view.

To create a panoramic view:

1. Select the images in the Browser window, then click **Select All**. The images will highlight. In the **Edit** menu, select **PhotoStitch**. The PhotoStitch program will start.
2. Follow the on-screen instructions to arrange, stitch, rotate, enlarge, or reduce your image.

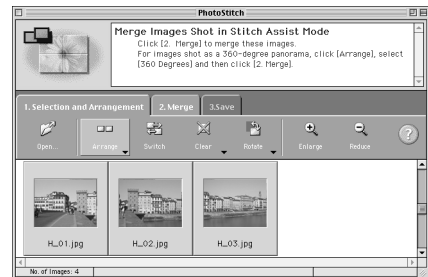

Macintosh Users: Uninstalling the BJ Solution Software



To uninstall the BJ Solution Software in Macintosh:

- Drag its folders to the **Trash** icon located on your desktop.

Appendix

The following topics are included in this appendix:

- Installing the Printer Driver
- Uninstalling the Printer Driver
- Registering Your Canon Product
- System Requirements
- Safety Information
- Regulatory Information
- Product Specifications
- Limited Warranty—U.S. Only

Installing the Printer Driver



To install the printer driver in Windows:



For Windows 2000 or Windows NT 4.0, refer to the README.TXT file on the S800 Setup Software & Reference Guide CD-ROM.

1. Be sure the printer is off before continuing.
2. Turn the computer on, then insert the S800 Setup Software & Reference Guide CD-ROM in the CD-ROM drive. The setup program should run automatically.

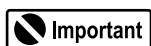

If the printer was turned on when the setup program ran, the Add New Hardware Wizard will appear. Do NOT use the wizard—click Cancel to close the window and continue.



Note

- If the setup program does not run automatically, click **Start**, then **Run**, then type **x:\msetup.exe** (where **x** is the CD-ROM drive).
- If prompted, select a language, then click **OK**.

3. Read the release notes, then click **Next**.
4. Read the License Agreement, then click **Yes**.
5. When the main menu appears, click **Install Software**.



Note

If a message prompts you to restart Windows, remove the CD-ROM, then click **OK**. After the computer restarts, re-insert the CD-ROM and continue.

6. Select **Printer Driver**, then click **Start**. The printer driver will load automatically.
7. At a certain point in the installation process, you will be prompted to turn on the printer so the printer port (connection) can be automatically detected.

When prompted, turn on the printer. When the printer port has been identified, click **OK**.

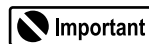

Important

If your computer cannot detect a printer port, see the troubleshooting tip for “Computer cannot detect a printer port” on page 37.

8. Click **Yes** if you are prompted to restart the computer.
When the software installation process is completed, click **Exit**.



To install the printer driver in Mac OS:

1. Prepare your Mac (if needed).
 - If you have an iMac[®] with Mac OS 8.1, download and install the iMac Update 1.0 from www.apple.com.
 - If you have multiple users set up in OS 9, log in as the Owner.
 - To install the printer to a network, see the *S800 Reference Guide* on the Setup Software & Reference Guide CD-ROM.

2. Close any open software applications.
3. Insert the S800 Setup Software & Reference Guide CD-ROM in the CD-ROM drive.
4. Open the printer driver folder on the CD-ROM, then select the English folder.
5. Double-click the **Installer** icon.
6. Read the License Agreement, then click **Accept**.
7. Click **Install**. The the printer driver will load automatically.

**Note**

If a “No other applications can be running...” message displays, click **Continue**.

8. When the installation has completed, click **Restart**.
9. After the computer restarts, select the **Apple** menu, then **Chooser**.
10. Click the **S800** icon in the Chooser.

**Note**

To use the BJ Print Monitor, you must click the **Background** button to the **On** position.

For instructions on using this feature, see the *S800 Reference Guide* on the S800 Setup Software & Reference Guide CD-ROM.

11. Close the Chooser.

Uninstalling the Printer Driver



To uninstall the printer driver in Windows:

1. Click **Start, Programs**, then **BJ Printer**.
2. Click **Uninstall**.
3. Click **Yes** to confirm that you want to uninstall the printer driver.



To uninstall the printer driver in Mac OS:

1. Insert the S800 Setup Software & Reference Guide CD-ROM in the CD-ROM drive.
2. Double-click **Printer Driver**.

3. Double-click **Installer** in the English folder.
4. Read the License Agreement, then click **Accept**.
5. Select **Uninstall** from the drop-down list.
6. Click **Uninstall**.

Registering Your Canon Product



To register your Canon product in Windows:

1. Insert the S800 Setup Software & Reference Guide CD-ROM in the CD-ROM drive.
2. When the Canon installation screen launches, click **Install Software**.
3. Click **Utilities/Product Registration**.
4. Click **Product Registration** and follow the on-screen instructions to register your product. The serial number is located on the inside of the printer, to the right of the printhead.



To register your Canon product in Macintosh:

1. Insert the S800 Setup Software & Reference Guide CD-ROM in the CD-ROM drive.
2. From the Canon BJ window, double-click the **Product Registration** icon.
3. Click the **Register Now** button and follow the on-screen instructions to register your product. The serial number is located on the inside of the printer, to the right of the printhead.

System Requirements

- Windows 95/98: 486 processor; 16 MB RAM; 40 MB free hard disk space
- Windows 2000: Pentium® processor, 133 MHz or faster; 32 MB RAM for Professional, 64 MB RAM for Server; 25 MB free hard disk space
- Windows Me: Pentium processor, 150 MHz or faster; 32 MB RAM; 40 MB free hard disk space

Windows NT 4.0: Pentium processor; 16 MB RAM; 25 MB free hard disk space

Macintosh: OS 8.1 or later; USB port; 10 MB RAM; 30 MB free hard disk space



Note

If you have an iMac with Mac OS 8.1, you must upgrade the OS before installing the printer driver. iMac Update 1.0 is available by download from www.apple.com.

If you have multiple users set up in OS 9, log in as the Owner before downloading and installing.

Safety Information

Warnings and Cautions

This guide uses the following icons to indicate situations that could cause damage or injury:

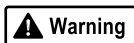

Warning

Always follow the instructions provided in Warnings to prevent potential serious personal injury or death as a result of careless operation of the equipment.

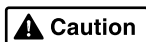

Caution

Always follow the instructions provided in Cautions to prevent minor injuries to yourself or damage to the equipment as a result of careless operation of the equipment.

Read and follow all of these cautions and warnings to ensure the safe use of the printer. To avoid the hazards of fire, personal injury, or damage to the printer, never attempt to use the printer in any way other than the methods described in this guide.

Choosing a Location

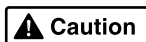

Caution

Never place the printer near flammable solvents such as alcohol, thinner, etc. To avoid the hazards of fire or electric shock, keep all flammable liquids away from the printer.

- Never set the printer on a surface that is unstable or subject to excessive vibration. The printer could tip or fall and cause injury.
- Never use the printer in a location that is subject to high humidity, dust, high temperatures, or direct sunlight.

- Set up and use the printer in a location where ambient temperature is within 41°F–95°F (5°C–35°C) and 10%–90% humidity with no condensation.



Caution

Never place the printer on a thick carpet or rug. Fibers or dust entering the printer could cause a fire.



Warning

Keep the power outlet for the printer free of all obstacles so you can unplug the power cord at any time. Such obstacles could prevent you from unplugging the printer when a printer fault occurs and cause a fire or electric shock. The socket-outlet shall be installed near the equipment and shall be easily accessible.

- Always carry the printer with both hands holding both ends of the printer. To avoid dropping the printer and causing injury, always carry it carefully when moving it to another location.

Power Supply

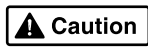

Caution

Never attempt to plug the power cord into a power outlet when your hands are wet. To avoid electric shock, make sure that your hands are dry.

- Always push the plug completely into the power outlet. A loose or poorly connected plug could cause a fire or electric shock.

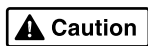

Caution

Never cut, modify, stretch, bend, or twist the power cord, and never place heavy objects on the power cord. A power leak from a damaged power cord could cause a fire or electric shock.

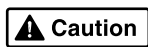

Caution

Never plug the printer power cord into a power outlet (power board, double adapter, etc.) that is shared by other devices or office equipment. To prevent the hazards of fire or electric shock, avoid overloading power points.

- Never use the printer if the power cord is bundled or knotted. To prevent the hazards of fire or electric shock, make sure the power cord is straight.

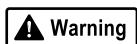

Warning

If you detect smoke, unusual odors, or strange noises around the printer, immediately press the POWER button to turn off the printer and disconnect the power plug. To avoid fire or electric shock, never use the printer under these conditions. Call for the Customer Care Center.

- Always grasp the plug when you unplug the power cord. Pulling on the power cord could damage the cord and cause a fire or electric shock.



Never use an extension cord. To avoid a fire or electric shock, always plug the power cord directly into the power outlet.



Never use a power supply voltage other than that supplied in the country where you purchased the printer. Using incorrect voltage could cause a fire or electric shock. The correct power supply voltage for this printer is AC 120V, 60 Hz.

Cleaning and Maintaining the Printer

- Use only a slightly damp cloth to clean the printer. Never use flammable solvents like alcohol, benzene, thinner, etc. If a flammable solvent contacts an electrical component inside the printer, a fire or electric shock could result.
- Always unplug the printer power cord before you clean the printer. If you mistakenly turn on the printer while cleaning it, you could touch moving components inside the printer and suffer injury.
- Never attempt to disassemble or modify the printer. The printer contains high voltage components which could cause a fire or serious electric shock.

Working Around the Printer

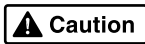

Never use flammable sprays near the printer. Gases in the spray could cause a fire or electric shock if they come in contact with electrical components inside the printer.

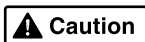

Never insert your fingers or hands inside the printer while it is printing. The printer contains moving parts which could cause injury.

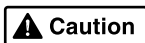

Never place anything on top of the printer, especially metal objects (paper clips, staples, etc.), or containers with flammable solvents (alcohol, thinners, etc.) Objects falling into the printer could cause a fire or electric shock.

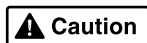

Caution

If any foreign object, especially a piece of metal or liquid, falls into the printer, immediately press the POWER button to turn off the printer, unplug the power cord, then call the Customer Care Center. Continuing to use the printer after a foreign object has fallen into it could cause a fire or electric shock.

Printhead and Ink Tanks

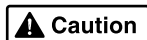

Caution

For safety, always store printhead and ink tanks out of the reach of small children. If a child accidentally licks or ingests any ink, consult a physician immediately.

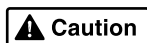

Caution

Never subject a printhead or ink tank to shocks or excessive vibration. Shaking could cause ink to leak and stain clothing.

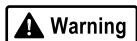

Warning

Never touch the printhead or electrical contacts on a printhead immediately after removing it from the printer. These metal parts become very hot during printing and could cause minor burns.

Turning Off the Printer

To avoid printer malfunction always use the POWER button to turn the printer on and off. Never remove the power cord from the power outlet until you have turned off the printer by pressing the POWER button. After the POWER/ERROR light goes out, you can unplug the power cord from the power outlet.

Using the Printer Near Appliances and Fluorescent Lamps

Allow at least 6 inches clearance between the printer and another appliance or a fluorescent lamp. Electrical noise generated by a fluorescent lamp placed too close to the printer could cause the printer to malfunction.

Regulatory Information

Color Photo Printer Model: K10201 (S800)

This equipment has been tested and found to comply with the limits for a Class B digital device, pursuant to Part 15 of the FCC Rules. These limits are designed to provide reasonable protection against harmful interference in a residential installation. This equipment generates, uses and can radiate radio frequency energy and, if not installed and used in accordance with the

instructions, may cause harmful interference to radio communications. However, there is no guarantee that interference will not occur in a particular installation. If this equipment does cause harmful interference to radio or television reception, which can be determined by turning the equipment off and on, the user is encouraged to try to correct the interference by one or more of the following measures:

- Reorient or relocate the receiving antenna.
- Increase the separation between the equipment and the receiver.
- Connect the equipment into an outlet on a circuit different from that to which the receiver is connected.
- Consult the dealer or an experience radio/TV technician for help.

Do not make any changes or modifications to the equipment unless otherwise specified in the manual. Should such changes or modifications be made, you could be required to stop operation of the equipment.

Use of shielded cable is required to comply with Class B limits in Subpart B of Part 15 of FCC Rules.

Canon U.S.A., Inc.
One Canon Plaza, Lake Success, NY 11042, U.S.A.
1-516-328-5600

Canadian Radio Interference Regulations

This digital apparatus does not exceed Class B limits for radio noise emissions from a digital apparatus as set out in the interference-causing equipment standard entitled “Digital Apparatus”, ICES-003 of the Industry of Science Canada.

Cet appareil numérique respecte les limites de bruits radioléctriques applicables aux appareils numériques de Classe B prescrites dans la norme sur le matériel brouilleur: “Appareils Numériques”, NMB-003 édictée par l’Industrie et Sciences Canada.

Appendix

Product Specifications

Printing method:	Bubble Jet ink on-demand
Printing resolution:	2400 x 1200 dpi
Print speed:	(Printing with Canon standard pattern; speeds may vary based on contents of print job and processor speed.)
Color photo (4" x 6")	Approx. 1 minute
Color photo (8" x 10")	Approx. 2 minutes
Print direction:	Bi-directional
Print width:	8.0 inches maximum (203 mm)
Resident print control mode:	Canon extended mode
Receiver buffer:	80KB
Interface (parallel):	IEEE 1284-compatible
Interface (USB):	USB 1.1-compatible
Interface connector (parallel):	Amphenol 57-40360 or equivalent
Interface connector (USB):	USB standard Series B receptacle
Recommended printer cable (parallel):	
Material:	AWG28 or larger
Type:	Twisted-pair shielded cable
Length:	Up to 6.5 feet (2.0 m)
Connectors:	Amphenol 30360 or equivalent
Recommended printer cable (USB):	
Material:	AWG28 (data wiring pair) or AWG20 to 28 (distribution pair)
Type:	Twisted-pair shielded cable
Length:	Up to 6.5 feet (2.0 m)
Connectors:	USB standard Series B pluggable
Acoustic noise level:	Approx. 37 dB (when printing with SuperPhoto print mode)
Operating environment:	
Temperature:	41°F to 95°F (5°C to 35°C)
Humidity:	10% to 90% (no condensation)
Storage environment:	
Temperature:	32°F to 95°F (0°C to 35°C)
Humidity:	5% to 90% (no condensation)
Power supply:	AC 120 V, 60 Hz
Power consumption:	
Standby:	Approx. 5 W
Printing:	Approx. 26 W
Dimensions:	(with paper rest and paper output tray retracted)
	17.7" (W) x 13.5" (D) x 8.2" (H)
	450 mm (W) x 343 mm (D) x 208 mm (H)
Weight:	Approx. 13 lb. (5.9 kg)
Feed method:	Continuous feed through auto sheet feeder for High Resolution Paper, Photo Paper Pro, Photo Paper Pro 4" x 6", plain paper, envelopes, Transparencies, Glossy Photo Paper, High Gloss Photo Film, Glossy Photo Cards, T-shirt Transfers, Banner Paper
Sheet feeder capacity:	
Plain paper (17 lb.)	100 sheets maximum
High Resolution Paper	80 sheets maximum

Envelopes	10 envelopes maximum
Transparencies	10 sheets maximum
Glossy Photo Paper	1 sheet
High Gloss Photo Film	1 sheet
Glossy Photo Cards	1 sheet
Banner Paper	1 sheet (can print up to 6 connected sheets)
T-shirt Transfers	1 sheet
Photo Paper Pro 4" x 6"	20 sheets
Photo Paper Pro	1 sheet
Magnet Sheets	1 sheet

Ordinary print media:**Regular size:**

Letter, Legal, 4" x 6", standard #10 and European DL envelopes

Weight:

Automatic feed: 17–23 lb.

Manual feed: 17–133 lb.

Thickness:

0.02 inches (0.6 mm)

Graphic image printing:**Data format**

Canon extended mode raster image format

Resolution

Canon extended mode 300, 600, 1200, 2400 dpi

Printhead:

Nozzles: 1,536 (256 per color)

Limited Warranty—U.S. Only

The limited warranty set forth below is given by Canon U.S.A., Inc. (“Canon”) with respect to the Canon brand computer peripheral product (the “product”) that you have purchased, when purchased and used in the United States. The product that you have purchased is the only product to which this warranty card and the limited warranty provided by Canon and stated on the card apply.

Your product, when delivered to you in new condition in its original container, is warranted against defects in materials or workmanship as follows: for a period of one (1) year from the date of original purchase, defective parts or a defective product returned to a Canon repair facility or a Canon Authorized Service Facility (“ASF”) for such product, as applicable, and proven to be defective upon inspection, will be exchanged for new or comparable rebuilt parts, or a refurbished product, as determined by the Canon repair facility or the ASF. Warranty repair or replacement shall not extend the original warranty period of the defective product. This limited warranty does not cover any supplies or accessories, including without limitation, ink cartridges and ink tanks, as to which there shall be no warranty or replacement.

This limited warranty shall only apply if the product is used in conjunction with compatible computer equipment and compatible software, as to which items Canon shall have no responsibility.

Non-Canon brand equipment and software that may be distributed with the product are sold “as is,” without warranty of any kind by Canon, including any implied warranty regarding merchantability or fitness for a particular purpose, and all such warranties are disclaimed. The sole warranty, if any, with respect to such non-Canon brand items is given by the manufacturer or producer thereof.

This limited warranty covers all defects encountered in normal use of the product, and does not apply in the following cases:

- (a) Loss of or damage to the product due to abuse, mishandling, improper packaging by you, alteration, accident, electrical current fluctuations, failure to follow operating, maintenance or environmental instructions prescribed in Canon’s instruction manual, or service performed by other than a Canon repair facility or an ASF.
- (b) Use of parts or supplies (other than those sold by Canon) that cause damage to the product or cause abnormally frequent service calls or service problems.
- (c) If the product has had its serial number or dating altered or removed.

NO IMPLIED WARRANTY, INCLUDING ANY IMPLIED WARRANTY OF MERCHANTABILITY OR FITNESS FOR A PARTICULAR PURPOSE, APPLIES TO THE PRODUCT AFTER THE APPLICABLE PERIOD OF THE EXPRESS LIMITED WARRANTY STATED ABOVE, AND NO OTHER EXPRESS WARRANTY OR GUARANTY, EXCEPT AS MENTIONED ABOVE, GIVEN BY ANY PERSON OR ENTITY WITH RESPECT TO THE PRODUCT SHALL BIND CANON. (SOME STATES DO NOT ALLOW LIMITATIONS ON HOW LONG AN IMPLIED WARRANTY LASTS, SO THE ABOVE LIMITATION MAY NOT APPLY TO YOU.) CANON SHALL NOT BE LIABLE FOR LOSS OF REVENUES OR PROFITS, INCONVENIENCE, EXPENSE FOR SUBSTITUTE EQUIPMENT OR SERVICE, STORAGE CHARGES, LOSS OR CORRUPTION OF DATA, OR ANY OTHER SPECIAL, INCIDENTAL OR CONSEQUENTIAL DAMAGES CAUSED BY THE USE OR MISUSE OF, OR INABILITY TO USE THE PRODUCT, REGARDLESS OF THE LEGAL THEORY ON WHICH THE CLAIM IS BASED, AND EVEN IF CANON HAS BEEN ADVISED OF THE POSSIBILITY OF SUCH DAMAGES. IN NO EVENT SHALL RECOVERY OF ANY KIND AGAINST CANON BE GREATER IN AMOUNT THAN THE PURCHASE PRICE OF THE PRODUCT SOLD BY CANON WHICH CAUSED THE ALLEGED DAMAGE.

WITHOUT LIMITING THE FOREGOING, YOU ASSUME ALL RISK AND LIABILITY FOR LOSS, DAMAGE OR INJURY TO YOU AND YOUR PROPERTY AND TO OTHERS AND THEIR PROPERTY ARISING OUT OF USE OR MISUSE OF, OR INABILITY TO USE THE PRODUCT NOT CAUSED DIRECTLY BY THE NEGLIGENCE OF CANON. (SOME STATES DO NOT ALLOW THE EXCLUSION OR LIMITATION OF INCIDENTAL OR CONSEQUENTIAL DAMAGES, SO THE ABOVE EXCLUSION OR LIMITATION MAY NOT APPLY TO YOU.) THIS LIMITED WARRANTY SHALL NOT EXTEND TO ANYONE OTHER THAN THE ORIGINAL PURCHASER OF THE PRODUCT, OR THE PERSON FOR WHOM IT WAS PURCHASED AS A GIFT, AND STATES YOUR EXCLUSIVE REMEDY.

Canon offers a full range of customer technical support* options:

- For e-mail technical support, the latest driver downloads and answers to frequently asked questions (www.usa.canon.com)
- 24-hour, 7-day-a-week, automated support for troubleshooting issues on most current products (1-800-423-2366)
- 24-hour, Fax-On-Demand System for product specifications and technical information (1-800-526-4345)
- Free technical support Monday—Saturday (excluding holidays) for products still under warranty** (1-757-413-2848)
- Technical support 7 days a week (excluding holidays) for products no longer under warranty, at \$9.99 per call (1-757-413-2848)

If the problem can't be corrected by using one of the above technical support options, you will be asked to follow the applicable procedures for warranty service. **Note that a dated proof of purchase (bill of sale) is required to verify eligibility at the time of service. This requirement will be satisfied by providing a copy of your dated bill of sale. You will also need to supply the product serial number.**

Carry-In/Mail-In

Carry-In/Mail-In is a service program by which your defective product is repaired by an ASF. The name and telephone number of the ASF(s) nearest to your location may be obtained from our Web site at: www.usa.canon.com, or by calling the Canon Customer Care Center at 1-800-423-2366. If shipping is involved, it is your responsibility to properly package and send your defective product, together with your dated proof of purchase, a complete explanation of the problem and a return address, to the ASF at your expense. **Do not include any other items with your product.** The repair(s) covered by this limited warranty will be made and the product will be returned to you without charge by the ASF. Repairs not covered under this limited warranty will be charged to you at such costs as each ASF may generally establish from time to time.

InstantExchange[†]

InstantExchange is a warranty program that expedites, usually by the next business day,^{††} the exchange of a defective product with a refurbished product. The refurbished product you receive will be covered by the balance of the period remaining on your original limited warranty. **Note that by using this service you will keep the replacement product that is sent to you, and your originally purchased product shall become the property of Canon.** InstantExchange warranty program service is available only during the express limited-warranty period for your product and only in the continental United States, Alaska and Hawaii during such period.

If the Canon Customer Care Center representative cannot correct the problem with your product over the telephone, and you elect InstantExchange warranty program service, the representative will issue you a reference number upon verification of warranty eligibility. You will be asked for information pertaining to your defective product and for a ship-to location for the replacement product (street address only). You must also provide a major credit card number that will be pre-authorized by Canon in an amount up to the cost of a new product at the time you elect InstantExchange warranty program service. **Your credit card number will be charged in an amount up to the cost of a new product** (i) if you do not return your defective product to a Canon repair facility by the date specified by Canon and in the manner described below; (ii) if the defect(s) in the product is/are not covered by this limited warranty; or (iii) if the warranty period on the product has expired or has not been sufficiently established by your supplying the appropriate documentation.

The Canon repair facility will ship out the replacement product via overnight courier, prepaid by Canon. After receipt of the replacement product (with instructions and a pre-paid return waybill), follow the instructions to ship the defective product to a Canon repair facility. You must return the defective product in the shipping carton in which the replacement product was packed (be sure to retain your ink cartridges and tanks), and you

must include the reference number, **a copy of your dated proof of purchase** (bill of sale) and a complete explanation of the problem. **Do not include any other items in the return** shipping container.

This limited warranty gives you specific legal rights, and you may also have other rights that vary from state to state.

* Support program specifics are subject to change without notice.

** Refer to the individual product information for warranty details.

† InstantExchange warranty program service is subject to availability of refurbished replacement units.

†† 9 a.m.–5 p.m. (local), Monday–Friday (excluding holidays). The Canon Customer Care Center must receive pertinent information by 3 p.m. (E.S.T.) to ensure next-business-day InstantExchange warranty program service (two-business-day InstantExchange warranty service for Alaska and Hawaii). Canon does not guarantee next-business-day service in the event of factors beyond Canon’s reasonable control.

S800 Index

A

- adjusting
 - brightness 23
 - color balance 23
 - color saturation 23
 - colors in photographs 20
 - print quality 20, 22
- advanced print features 19
- aligning the printhead 29

B

- banner paper 5
- BJ Solution Software 45
 - installing 46
- brightness, adjusting 23

C

- Camera print mode 15
- cancelling print jobs, how to 14
- cleaning the printhead 32
- color balance, adjusting 23
- color photographs, optimizing colors in ... 20
- color saturation, adjusting 23
- creative media
 - banner paper 5
 - how to load 8
 - magnet sheets 5
 - transparencies 5
 - T-Shirt Transfers 5
- customer care center, contacting 44

D

- default printer, setting 2
- Draft print mode 15
- driver
 - definition of 1
 - installing 53
 - recalling saved settings 24
 - removing 55
 - saving setting for future use 24
 - setting options 15
 - troubleshooting installation of 36
 - uninstalling 55
- DTP print mode 15

E

- edges, smoothing 19
- envelopes
 - how to load 13
 - sizes of 4
- error messages, explanation of 40

F

- fixing problems, how to 35

G

- Graphic print mode 15

I

- ImageBrowser 50
- ink levels, monitoring 27
- ink tanks
 - monitoring levels in 27
 - replacing 28

- L**
- loading
 - envelopes 13
 - paper 8
- M**
- magnet sheets 5
 - maintaining your printer 27
 - Manual print mode 15
 - media to avoid 6
 - monitoring ink levels 27
- N**
- nozzle check pattern, printing 30
- O**
- online manual, BJ Solution Software 47
 - online product registration 56
- P**
- panoramic view 49, 52
 - paper
 - creative 5
 - general 4
 - how to choose 4
 - how to load 8
 - landscape 16
 - lever position for thick paper 7
 - orientation, setting 16
 - photograph 4
 - portrait 16
 - size, setting 16
 - special 4
 - thick 6
 - perforated paper 48, 51
 - Photo Paper Pro 48, 51
 - Photo print mode 15
 - photographs
 - caring for 4
 - optimizing color in 20
 - printing 3
 - prolonging life of 4
 - special paper for 4
 - PhotoStitch 49, 52
 - print job
 - cancelling 14
 - print mode
 - definition of 15
 - setting 15
 - print quality, adjusting 22
 - printer
 - choosing 2
 - maintaining your printer 27
 - setting as default 2
 - printer driver, definition of 1
 - printhead
 - aligning 29
 - cleaning 32
 - printing
 - adjusting brightness 23
 - adjusting color balance 23
 - adjusting color saturation 23
 - adjusting print quality 22
 - nozzle check pattern 30
 - on creative media 5
 - on specialty media 4
 - on thick paper 6
 - photographs 3, 20
 - smoothing rough edges 19
 - troubleshooting bad printouts 40
 - troubleshooting problems with 37
 - problems, what to do to fix 35
- R**
- registering your product 56
 - replacing empty ink tanks 28
- S**
- safety information 57
 - setting
 - orientation of paper 16
 - paper orientation 16
 - paper size 16
 - print mode 15
 - size of paper 16

smoothing rough edges in images	19
specialty media	
how to load	8
printing on	4
types of	4
Standard print mode	15
stopping print job, how to	14
system requirements	56

T

tech support, how to contact	44
Text print mode	15
thick paper	
lever position	7
sizes of	7
thick paper, printing on	6
transparencies	5
troubleshooting	
error messages	40
installing the print driver	36
printing problems	37
software installation problems	36
T-Shirt Transfers	5

U

uninstalling the BJ Solution Software ..	50, 52
uninstalling the print driver	55

W

warranty	64
----------------	----

Z

ZoomBrower EX	48
---------------------	----

