



Windows

Generic Plus UFR II/LIPSLX/LIPS4/PCL6/PS3 Printer Driver

User's Guide

Contents

Introduction	2
How to Use the Manual	3
Notations Used in the Manual	4
Disclaimers	5
Copyright	6
Trademarks	7
About This Driver	9
Before Use	12
How to Refer to the Manual of the Device	14
Printing	16
Printing from a Computer	17
Scaling	19
Watermark Printing	20
Poster Printing	21
Printing Over a Fixed Form	25
Attaching Encryption When Printing	27
Putting Print Jobs on Hold	28
Storing Print Data	29
Priority Printing	30
Changing the Default Settings	31
Setting 1-sided Printing by Default	32
Setting Black-and-white Printing by Default	33
Creating a Booklet When Printing	35
Booklet Printing	36
Creating a Booklet in Sets	37
Correcting Displacement During Booklet Printing	38
Saddle Stitched Booklet Printing	39
Saddle Press Processing When Creating Saddle Stitched Booklets	40
Trimming Pages When Creating Saddle Stitched Booklets	41
Perfect Binding	42
Using Various Types of Paper	44
Registering Custom Paper Sizes	45
Inserting Sheets Between Transparencies	46
Inserting Sheets	47

Inserting Tab Paper	48
Printing on Tab Paper	50
Adding Cover Sheets	51
Printing Multiple Files Together	53
About the [Edit and Preview] Function	54
Printing Files Together	55
Checking the Print Preview	57
Changing the Print Settings of the Combined File	59
Setting Color Printing Details	62
Adjusting Colors (PS3)	63
Cautions When Printing in Color from a PostScript Application (PS3)	64
Editing Favorite Settings	66
Registering Favorite Settings	67
Editing the Favorite Settings List	68
Linking the Driver and the Device	71
Setting Device Information	72
Device Functions Settings	77
Paper Sources and Output Destinations Settings	78
Exporting a Configuration Profile	87
Importing a Configuration Profile	89
About Configuration Profile Type Settings	92
Setting the Authentication Function	93
Setting the User Name	95
Setting Exceptional Pages (PS3)	98
Access Management System/Encrypted Secure Print	100
About the Access Management System/Encrypted Secure Print Function	101
Using the Access Management System	102
Enabling the AMS Function	103
Preparing to Print Using AMS	105
Specifying the User Information to Be Used for AMS Authentication	107
Specifying the Print Output Destination Device Using AMS	109
Retrieving Print Restriction Information Applied When Using AMS	110
Configuring an Authentication Server to Be Used in AMS User Authentication	111
Using Encrypted Secure Print	112
Enabling the Encrypted Secure Print Function	113
Enhancing the Security of the Encrypted Secure Print Function	116
Printing Using the Encrypted Secure Print Function	118

Settings List	122
Common Settings for All Sheets	123
[Basic Settings] Sheet	126
[Page Setup] Sheet	129
[Finishing] Sheet	132
[Paper Source] Sheet	142
[Quality] Sheet (UFR II/LIPSLX/LIPS4/PCL6)	145
[Quality] Sheet (PS3)	152
[Color] Sheet (PS3)	157
[Exceptional Settings] Sheet (PS3)	161
[Device Settings] Sheet	165
[Profile] Sheet	170
[AMS] Sheet	172
[Encrypted-P] Sheet	178
Canon PageComposer	181

Troubleshooting	185
Driver settings cannot be set	186
Print results are unsatisfactory	187
Printing takes a long time	189
Print results are too dark or too bright	190
Overlay printing will not execute	191
Cannot use the acquire device information function or authentication function	193
Causes and Remedies for Access Management System Error Messages	195
Cannot execute the Encrypted Secure Print function	202
Cannot print with the specified method using Encrypted Secure Print	203

Introduction

Introduction	2
How to Use the Manual	3
Notations Used in the Manual	4
Disclaimers	5
Copyright	6
Trademarks	7

Introduction

- ▶ **How to Use the Manual(P. 3)**
- ▶ **Disclaimers(P. 5)**
- ▶ **Copyright(P. 6)**
- ▶ **Trademarks(P. 7)**

How to Use the Manual

This explains things that you need to know in order to use this manual.

▶ **Notations Used in the Manual(P. 4)**

Notations Used in the Manual

This explains symbols and settings used in this manual.

Symbols Used in This Manual

In this manual, explanations of items and operations that must be followed while using the driver are set forth the symbols that indicate the following.



IMPORTANT

- Indicates operational requirements and restrictions. Be sure to read these items carefully to operate the product correctly, and avoid damage to the product.



NOTE

- Indicates a clarification of an operation, or contains additional explanations for a procedure. Reading these notes is highly recommended.

About Settings

In this manual, setting names displayed on the computer screen are represented as shown in the following examples.

Example:

[Print]

[OK]

Disclaimers

The information in this document is subject to change without notice.

CANON INC. MAKES NO WARRANTY OF ANY KIND WITH REGARD TO THIS MATERIAL, EITHER EXPRESS OR IMPLIED, EXCEPT AS PROVIDED HEREIN, INCLUDING WITHOUT LIMITATION, THEREOF, WARRANTIES AS TO MARKETABILITY, MERCHANTABILITY, FITNESS FOR A PARTICULAR PURPOSE OF USE OR NON-INFRINGEMENT. CANON INC. SHALL NOT BE LIABLE FOR ANY DIRECT, INCIDENTAL, OR CONSEQUENTIAL DAMAGES OF ANY NATURE, OR LOSSES OR EXPENSES RESULTING FROM THE USE OF THIS MATERIAL.

Copyright

Copyright CANON INC. 2022

No part of this publication may be reproduced, transmitted, transcribed, stored in a retrieval system, or translated into any language or computer language in any form or by any means, electronic, mechanical, magnetic, optical, chemical, manual, or otherwise, without the prior written permission of Canon Inc.

Trademarks

macOS and Safari are trademarks of Apple Inc.

All brand names and product names appearing on this document are registered trademarks or trademarks of their respective owners.

All other trademarks are the property of their respective owners.

About This Driver

About This Driver 9

About This Driver

This is a generic printer driver that supports various devices. You can use the same driver for all printer models by changing the settings for the printing port and device information.

Features

- Information regarding the functions and options of the device are collectively defined in a "configuration profile." By switching "configuration profiles," you can switch the driver settings screen to match the functions of the device.
- You do not need to reinstall the driver when you add or replace a device.

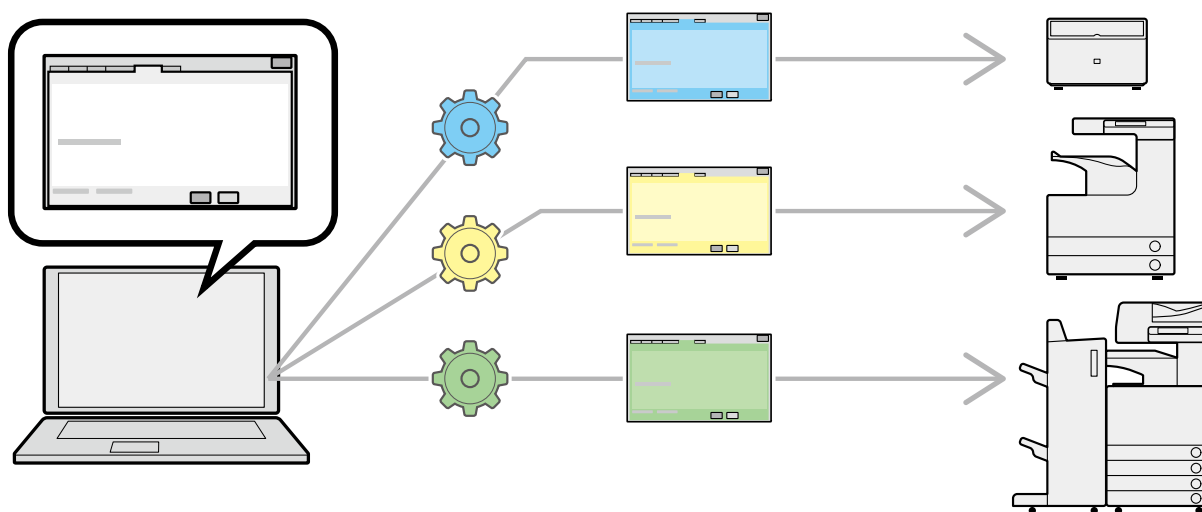

Utilizing Configuration Profiles

Configuration profiles corresponding to each printer model have been prepared beforehand. You can customize and use a configuration profile corresponding to your printer operation management.

By applying a configuration profile to the driver, the settings in the [Device Settings] sheet can be changed and the functions specific to the device can be set. You can also export and save the function and option settings for the device in the [Device Settings] sheet as a configuration profile.

Examples of How to Utilize Configuration Profiles

- **Making a driver settings screen for the printer model you are using**

When you can acquire the printer model information from the device, a configuration profile is applied automatically and the settings screen changes to match the device. When you cannot acquire the information, apply a configuration profile manually.

- **Efficiently configuring driver settings for multiple computers**

You can export and save the device function and options settings of the [Device Settings] sheet as a configuration profile. The device information of drivers used in other computers can be easily batch set by importing the exported configuration profile.

If you cannot acquire the device information, you can apply it by importing a configuration profile exported in an environment where the information could be acquired.

Related Topics

- [Setting Device Information\(P. 72\)](#)

- ▶ **Importing a Configuration Profile(P. 89)**
- ▶ **Exporting a Configuration Profile(P. 87)**

Before Use

Before Use 12

Before Use

- When using this driver, the following restrictions apply.
 - In order to set and print with the functions supported by the printer model you are using, you need to set a configuration profile suitable for the printer model and set the option status of the device. You can configure these settings in the [Device Settings] sheet.
 - If you set functions that are not supported by this driver on the control panel of the device you are using, those functions are enabled when printing.
- The newest driver software is posted on the Canon web site. Please verify the operating environment etc. and download the appropriate software as required.
Canon Global Site: <https://global.canon/>
- The functions that you can use may vary according to the following conditions.
 - The device you are using and its settings
 - The firmware version of the device
 - The option structure of the device
 - The driver you are using
 - The driver version
 - The computer environment you are using
- The applications used and computer environment, etc. may affect the operating speed of the computer.
- When printing from a Windows Store app, because you cannot display the print settings screen of the driver, the number of functions you can set is limited.
- The screen content, procedures, etc. displayed and described in the manual may differ from those actually displayed.
- In this manual, examples using Windows 11 are explained.

How to Refer to the Manual of the Device

How to Refer to the Manual of the Device 14

How to Refer to the Manual of the Device

There are cases when, in order to use the functions of this driver, operations must be carried out at the device beforehand.

For information about how to operate the device, refer to the manual of the device.

Printing

Printing	16
Printing from a Computer	17
Scaling	19
Watermark Printing	20
Poster Printing	21
Printing Over a Fixed Form	25
Attaching Encryption When Printing	27
Putting Print Jobs on Hold	28
Storing Print Data	29
Priority Printing	30
Changing the Default Settings	31
Setting 1-sided Printing by Default	32
Setting Black-and-white Printing by Default	33

Printing

- ▶ **Printing from a Computer(P. 17)**
- ▶ **Scaling(P. 19)**
- ▶ **Watermark Printing(P. 20)**
- ▶ **Poster Printing(P. 21)**
- ▶ **Printing Over a Fixed Form(P. 25)**
- ▶ **Attaching Encryption When Printing(P. 27)**
- ▶ **Putting Print Jobs on Hold(P. 28)**
- ▶ **Storing Print Data(P. 29)**
- ▶ **Priority Printing(P. 30)**
- ▶ **Changing the Default Settings(P. 31)**
- ▶ **Setting 1-sided Printing by Default(P. 32)**
- ▶ **Setting Black-and-white Printing by Default(P. 33)**

Printing from a Computer

This explains the basic procedure for printing configuring the printer driver settings.



NOTE

- When using a device connected via a WSD port, enable [Use WSD Printing] at the device.

1 Open a document in the application → display the print screen.

2 Select the device you are using → click [Preferences].

Depending on the application, [Preferences] may be called "Printer properties" or "Properties."

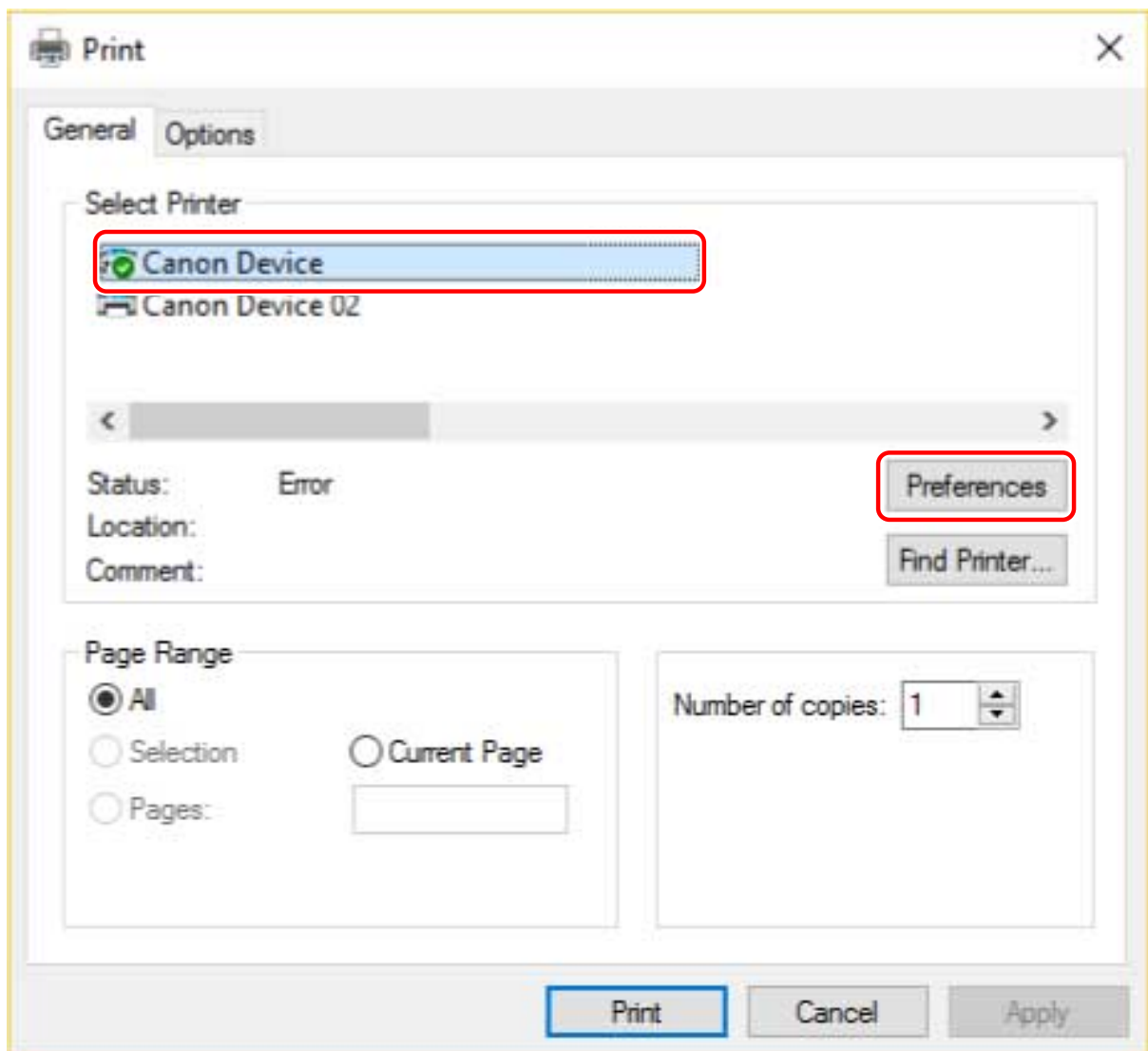

3 In the print settings screen of the driver, set the required items.

If necessary, switch sheets and configure relevant settings.

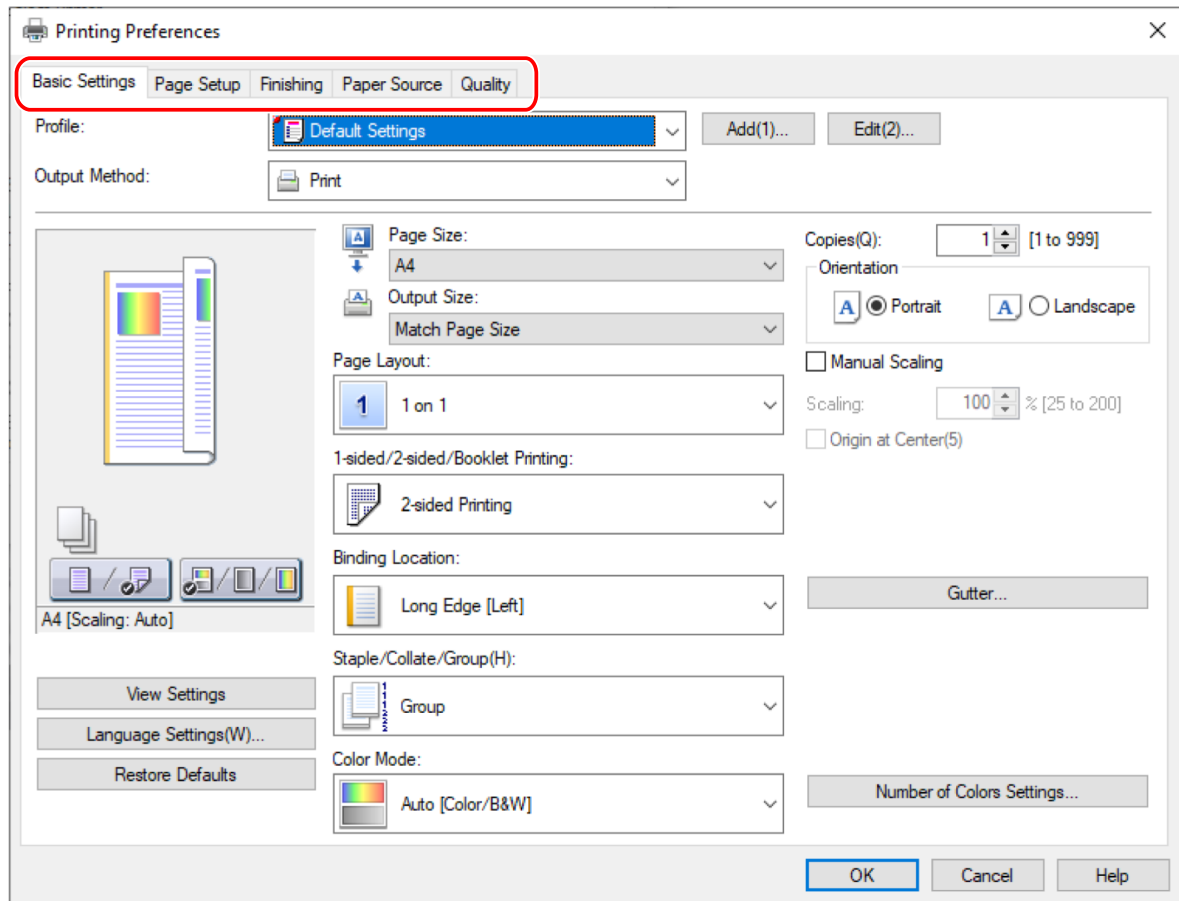
**NOTE**

- If the function you want to use is not displayed in the print settings screen, configure the print settings after enabling the functions of the device by acquiring the device information etc.

4 Click [OK].

5 In the print screen, click [Print] or [OK].

Related Topics

- ▶ [About This Driver\(P. 9\)](#)
- ▶ [Changing the Default Settings\(P. 31\)](#)
- ▶ [Setting Device Information\(P. 72\)](#)
- ▶ [Driver settings cannot be set\(P. 186\)](#)

Scaling

You can enlarge or reduce the print data when printing.

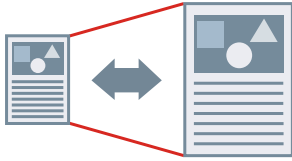

To Scale to the Output Page Size

- 1** Display the [Basic Settings] or [Page Setup] sheet.
- 2** Select the paper size set in the application from [Page Size].
- 3** Select the paper size you want to print on from [Output Size].

To Specify a Desired Scale

- 1** Display the [Basic Settings] or [Page Setup] sheet.
- 2** Select [Manual Scaling] → specify the magnification in [Scaling].

Related Topics

- ▶ [Basic Settings] Sheet(P. 126)
- ▶ [Page Setup] Sheet(P. 129)
- ▶ Registering Custom Paper Sizes(P. 45)
- ▶ Driver settings cannot be set(P. 186)

Watermark Printing

You can superimpose and print semi-transparent characters such as [TOP SECRET] or [DRAFT] over print data.

You can also create new watermarks.

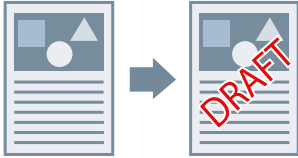

To Attach and Print a Watermark

- 1** Display the [Page Setup] sheet.
- 2** Select [Watermark] → select a watermark name.

To Create New Watermarks

- 1** Display the [Page Setup] sheet.
- 2** Select [Watermark] → click [Edit Watermark].
- 3** In the [Edit Watermark] dialog box, click [Add] → enter a name in [Name].
- 4** In [Attributes], set the characters and attributes for the watermark.
- 5** In [Alignment], set the positioning of the watermark.
- 6** In [Print Style], set the border and superimposition of the watermark.
- 7** In the [Edit Watermark] dialog box, click [OK].

The created watermark is added to the list in the [Page Setup] sheet > [Watermark].

Related Topics

- 🔗 [Page Setup] Sheet(P. 129)

Poster Printing

You can enlarge the print data of one page and print it over multiple sheets of paper. When the output sheets are joined together, they form a large print like a poster.

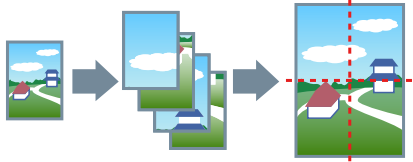

This topic also introduces poster printing setting and output examples.

▶ **Poster Printing Setting and Output Examples(P. 21)**

To Perform Poster Printing

- 1** Display the [Basic Settings] sheet.
- 2** Select [1-sided Printing] from [1-sided/2-sided/Booklet Printing].
- 3** Display the [Basic Settings] or [Page Setup] sheet.
- 4** Select [Poster [N x N]] from [Page Layout].
 N x N represents the number of sheets of paper over which the print data will be divided and printed.
 When printing with border lines, or when setting margins or the range of pages to be printed, perform the following procedure.
- 5** Click [Poster Details].
- 6** In the [Poster Details] dialog box, set any necessary items → click [OK].

Poster Printing Setting and Output Examples

This shows combinations of setting examples and output results relating to poster printing. The setting examples are shown in combination with the setting state in the [Poster Details] dialog box whenever required.

Setting Example 1.

- [Basic Settings] sheet > [Orientation]: [Portrait]
- [Basic Settings] or [Page Setup] sheet > [Page Layout]: [Poster [1 x 2]]

Output Result

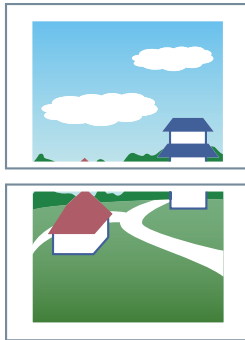

Setting Example 2.

- [Basic Settings] or [Page Setup] sheet > [Page Layout]: [Poster [2 x 2]]
- [Poster Details] dialog box > [Pages to Print] > [Specify Pages]: [2] and [4]

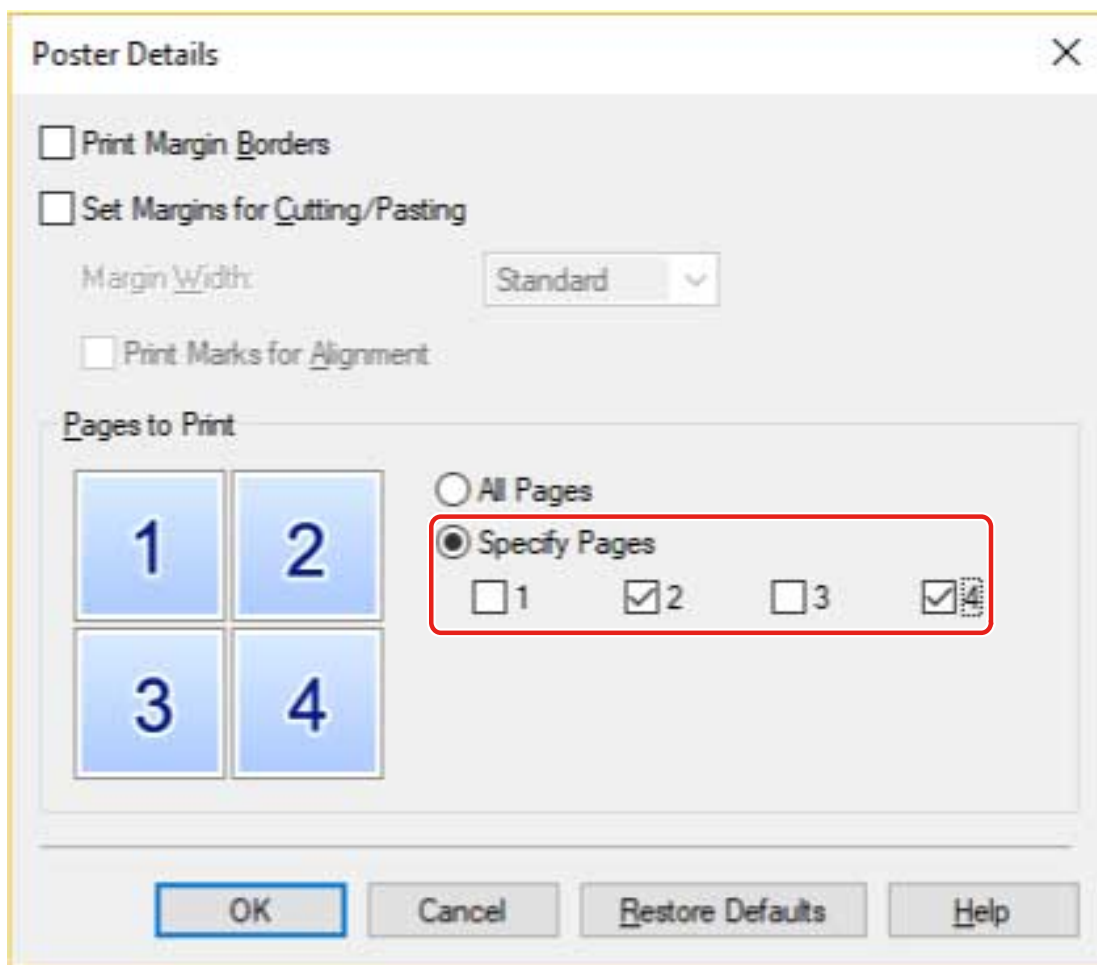

Output Result

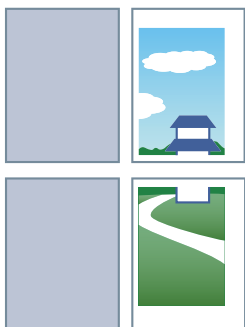

Setting Example 3.

- [Basic Settings] or [Page Setup] sheet > [Page Layout]: [Poster [2 x 2]]
- [Poster Details] dialog box: [Print Margin Borders], [Set Margins for Cutting/Pasting], and [Print Marks for Alignment]

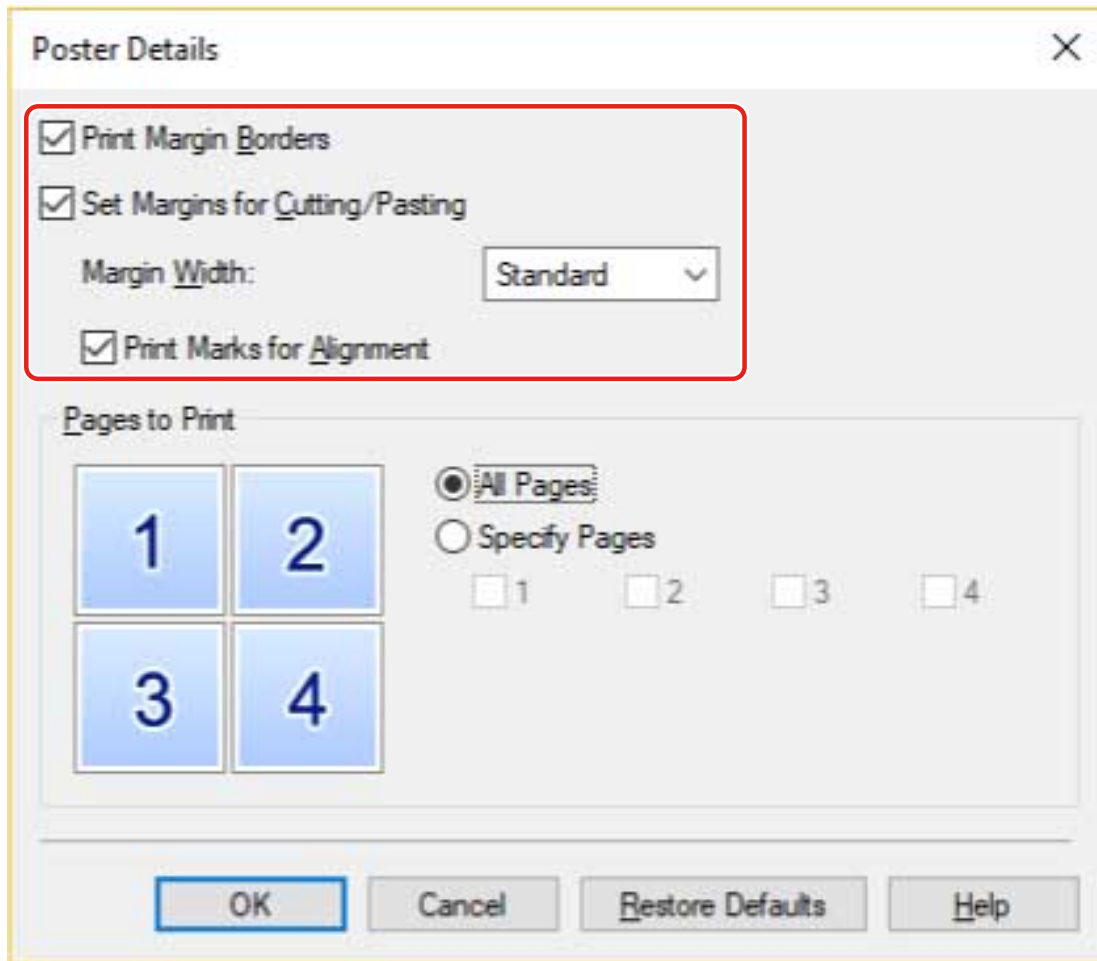

Output Result

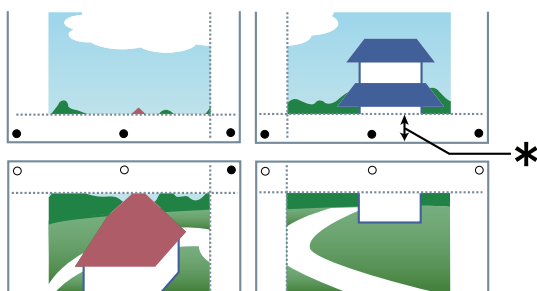

Legend

Broken line: border

○ : paste mark

● : cut mark

* : the margin set for [Margin Width] (10 mm (0.39 inches) when [Standard] is selected.)

Related Topics

- [Basic Settings] Sheet(P. 126)

▶ [Page Setup] Sheet(P. 129)

Printing Over a Fixed Form

You can print data overlapping a fixed form stored in the device. This function is known as overlay printing.

With the LIPS4/PS3 driver, you can use fixed forms saved not only on the device, but on a computer (host side) as well.

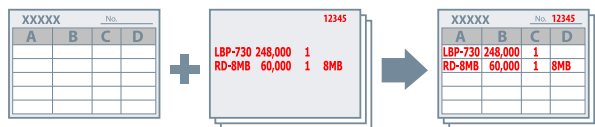

To Save a Fixed Form in the Device or the Computer

- 1** Select the print menu of the application.
- 2** In the displayed print screen, select the device you are using → click [Preferences] to display the print settings screen of the driver.
- 3** Display the [Page Setup] sheet.
- 4** Click [Page Options].
- 5** In the [Page Options] dialog box, display the [Overlay] sheet.
- 6** Select [Processing Method] > [Create a Form File] → specify a file name.
 When you can select the save destination for a form file, select the save destination from [Store in], then specify a file name.
 If you select [Host] from [Store in], fill in [Title] and [Sub-title] as required.
 When using the PS3 driver and [Host] is selected in [Store in], only the local computer can be specified as the location to save the form file. Another computer on the same network cannot be specified.
- 7** Click [OK].
- 8** In the print settings screen, click [OK].
- 9** In the print screen, click [Print] or [OK].

To Perform Overlay Printing

- 1 Display the [Page Setup] sheet.**
- 2 Click [Page Options].**
- 3 In the [Page Options] dialog box, display the [Overlay] sheet.**
- 4 Select [Processing Method] > [Use Overlay Printing] → specify the file name of the form to be used.**

When using a form file stored in the device:

Click [Retrieve Form File Information] → select the file from [File List].

If you cannot retrieve the information from the device, enter a file name in [File Name].

When performing two-sided printing, select the application range from [Apply to].

If [Retrieve Form File Information] is not displayed, select [Form File on Device] from [Form File to Use].

When using a form file stored in a computer:

Select [Form File on Host] from [Form File to Use] → click [Browse] and select the form file to be used.

If necessary, enter information in [File Info].
- 5 Click [OK].**



NOTE

- With some applications, form data may not be printed because the document sent overwrites the previous document.

Related Topics

- ▶ [\[Page Setup\] Sheet\(P. 129\)](#)
- ▶ [Overlay printing will not execute\(P. 191\)](#)

Attaching Encryption When Printing

You can attach a PIN to print data and save it in the device. When you print the saved data, enter the PIN in the control panel of the device. This function is useful when printing confidential documents etc.

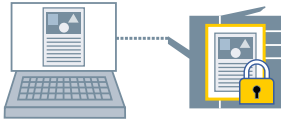

NOTE

- If you register the PIN used in secured printing as a default setting, you can reduce the effort required to configure settings when printing.

1 Display the appropriate sheet from the print settings screen of the driver.

2 Select [Secure Print] from [Output Method] → click [OK].

3 In the [Secure Print Details] dialog box, enter [User Name] and [PIN].

If the [Confirm PIN] dialog box is displayed when actually printing, you can confirm or change the data name, user name, and PIN.

4 Click [OK].

Related Topics

- ▶ [Common Settings for All Sheets\(P. 123\)](#)
- ▶ [Changing the Default Settings\(P. 31\)](#)

Putting Print Jobs on Hold

You can send print data to a hold queue (temporary storage area) in the device. You can also change the print order or settings of the stored data from the control panel of the device or the Remote UI.

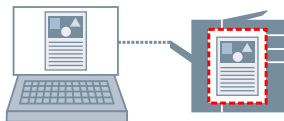

1 Display the appropriate sheet from the print settings screen of the driver.

2 Select [Hold] from [Output Method] → click [Details].

3 In the [Hold Details] dialog box, set the name of data.

If you want to specify a desired name, select [Name of Data to Hold] > [Enter Name] → enter the name in [Name].

The [Hold Details] dialog box is also displayed when actually printing, enabling you to confirm or change the specified name.

4 Click [OK].

Related Topics

- ▶ [Common Settings for All Sheets\(P. 123\)](#)
- ▶ [Changing the Default Settings\(P. 31\)](#)

Storing Print Data

You can store the print data in a box in the device. You can also change the settings of or combine the stored data with other stored data from the control panel of the device or the Remote UI.

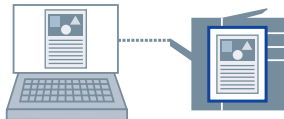

NOTE

- If you register the box number used in stored printing as a default setting, you can reduce the effort required to configure settings when printing.

- 1 Display the appropriate sheet from the print settings screen of the driver.**
- 2 Select [Store] from [Output Method] → click [OK].**
- 3 In the [Store Details] dialog box, set the name of data.**
If you want to specify a desired name, select [Data Name] > [Enter Name] → enter the name in [Name].
- 4 Click [Retrieve Mail Box Information] → select a storage destination from [Mail Boxes].**
You can select multiple boxes by pressing the [Ctrl] or [Shift] key.
- 5 Click [OK].**

Related Topics

- ▶ [Common Settings for All Sheets\(P. 123\)](#)
- ▶ [Changing the Default Settings\(P. 31\)](#)

Priority Printing

You can print a document with higher priority than other print jobs that are in a standby state in the device.

When performing priority printing, if there is a print job being processed at the device, priority printing is started as soon as that job is finished.

1 Display the appropriate sheet from the print settings screen of the driver.

2 Select [Promote Print] from [Output Method].

Related Topics

▶ [Common Settings for All Sheets\(P. 123\)](#)

Changing the Default Settings

You can change the default settings to desired print settings. If you change them to settings that you use frequently, you can reduce the effort required to configure settings when printing.



NOTE

- Because Excel carries over settings even when a file is closed, the default driver settings may not be correctly reflected in cases such as when the print settings of other users remain.
When printing an Excel file, check the settings on the print settings screen before printing.

1 Display the print settings screen of the driver.

If displaying from [Settings] in the Start menu

- (1) Display [Bluetooth & devices] (or [Devices]).
- (2) In [Printers & scanners], display the management screen for the device to set.
To display the management screen, click the device or click [Manage] for the corresponding device.
- (3) Click [Printing preferences] for the device to set.

If you are using the driver with multiple printer models, select the device to be set, then click [Printing preferences].

If displaying from [Control Panel]

- (1) Display [Devices and Printers].
- (2) From the printer list, right-click the device to be set → select [Printing preferences] from the displayed menu.

If you are using the driver with multiple printer models, select [Printing preferences], then select the device to be set.

2 In the displayed print settings screen of the driver, set the required items.

If necessary, switch sheets and configure relevant settings.

3 Click [OK].

Setting 1-sided Printing by Default

You can set 1-sided printing by default in order to eliminate the need to change the setting each time you print.

With this driver, 2-sided printing is set by default to meet the requirements of the International ENERGY STAR International Partners Program.

If you frequently use 1-sided printing, it is recommended that you follow this procedure to change the default setting.



NOTE

- Because Excel carries over settings even when a file is closed, the default driver settings may not be correctly reflected in cases such as when the print settings of other users remain.

When printing an Excel file, check the settings on the print settings screen before printing.

1 Display the print settings screen of the driver.

If displaying from [Settings] in the Start menu

- (1) Display [Bluetooth & devices] (or [Devices]).
- (2) In [Printers & scanners], display the management screen for the device to set.
To display the management screen, click the device or click [Manage] for the corresponding device.
- (3) Click [Printing preferences] for the device to set.

If displaying from [Control Panel]

- (1) Display [Devices and Printers].
- (2) From the printer list, right-click the device to be set → select [Printing preferences] from the displayed menu.

2 Display the [Basic Settings] or [Finishing] sheet.

3 Select [1-sided Printing] from [1-sided/2-sided/Booklet Printing] or [Print Style].

4 Click [OK].

Related Topics

- ▶ [Basic Settings] Sheet(P. 126)
- ▶ [Finishing] Sheet(P. 132)

Setting Black-and-white Printing by Default

You can set black-and-white printing by default in order to eliminate the need to change the setting each time you print.

With this driver, the color mode is set to [Auto [Color/B&W]] by default. When [Auto [Color/B&W]] is set, the driver automatically detects whether each page is in color or black-and-white.

If you frequently use black-and-white printing, it is recommended that you follow this procedure to change the default setting.



NOTE

- Because Excel carries over settings even when a file is closed, the default driver settings may not be correctly reflected in cases such as when the print settings of other users remain.

When printing an Excel file, check the settings on the print settings screen before printing.

1 Display the print settings screen of the driver.

If displaying from [ Settings] in the Start menu

- (1) Display [Bluetooth & devices] (or [Devices]).
- (2) In [Printers & scanners], display the management screen for the device to set.
To display the management screen, click the device or click [Manage] for the corresponding device.
- (3) Click [Printing preferences] for the device to set.

If displaying from [Control Panel]

- (1) Display [Devices and Printers].
- (2) From the printer list, right-click the device to be set → select [Printing preferences] from the displayed menu.

2 Display the [Basic Settings], [Quality], or [Color] sheet.

3 Select [Black and White] from [Color Mode].

4 Click [OK].

Related Topics

- ▶ [Basic Settings] Sheet(P. 126)
- ▶ [Quality] Sheet (UFR II/LIPSLX/LIPS4/PCL6)(P. 145)
- ▶ [Quality] Sheet (PS3)(P. 152)
- ▶ [Color] Sheet (PS3)(P. 157)

Creating a Booklet When Printing

Creating a Booklet When Printing	35
Booklet Printing	36
Creating a Booklet in Sets	37
Correcting Displacement During Booklet Printing	38
Saddle Stitched Booklet Printing	39
Saddle Press Processing When Creating Saddle Stitched Booklets	40
Trimming Pages When Creating Saddle Stitched Booklets	41
Perfect Binding	42

Creating a Booklet When Printing

- ▶ **Booklet Printing(P. 36)**
- ▶ **Creating a Booklet in Sets(P. 37)**
- ▶ **Correcting Displacement During Booklet Printing(P. 38)**
- ▶ **Saddle Stitched Booklet Printing(P. 39)**
- ▶ **Saddle Press Processing When Creating Saddle Stitched Booklets(P. 40)**
- ▶ **Trimming Pages When Creating Saddle Stitched Booklets(P. 41)**
- ▶ **Perfect Binding(P. 42)**

Booklet Printing

You can print with the pages automatically arranged so they create a booklet when folded in half.

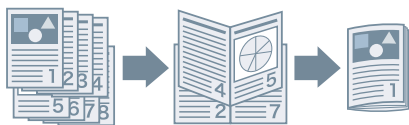

- 1** Display the [Basic Settings] or [Finishing] sheet.
- 2** Select [Booklet Printing] from [1-sided/2-sided/Booklet Printing] or [Print Style].
To set the binding position and gutter, follow the procedure below.
- 3** Click [Booklet].
- 4** In the [Detailed Settings for Booklet] dialog box, select the binding position from [Book Opening].
- 5** Select [Specify Booklet Gutter] → specify a gutter width in [Booklet Gutter].
- 6** Click [OK].

Related Topics

- ▶ [Basic Settings] Sheet(P. 126)
- ▶ [Finishing] Sheet(P. 132)
- ▶ Creating a Booklet in Sets(P. 37)
- ▶ Correcting Displacement During Booklet Printing(P. 38)
- ▶ Saddle Stitched Booklet Printing(P. 39)

Creating a Booklet in Sets

When creating a booklet from a document with a large number of pages, you can divide the pages into multiple sets and print them.



- 1** Display the [Basic Settings] or [Finishing] sheet.
- 2** Select [Booklet Printing] from [1-sided/2-sided/Booklet Printing] or [Print Style].
- 3** Click [Booklet].
- 4** Select [Booklet Printing Method] > [Divide into Sets].
- 5** Specify the number of pages contained in each set in [Sheets per Set].
- 6** Click [OK].

Related Topics

- ▶ [Basic Settings] Sheet(P. 126)
- ▶ [Finishing] Sheet(P. 132)
- ▶ Booklet Printing(P. 36)

Correcting Displacement During Booklet Printing

You can create and print a booklet while correcting the displacement between outer and inner pages that occurs during booklet printing. If you trim the edges of the pages using a trimmer, you can adjust the amount of margin so that the position of the print data on the page does not deviate between pages.

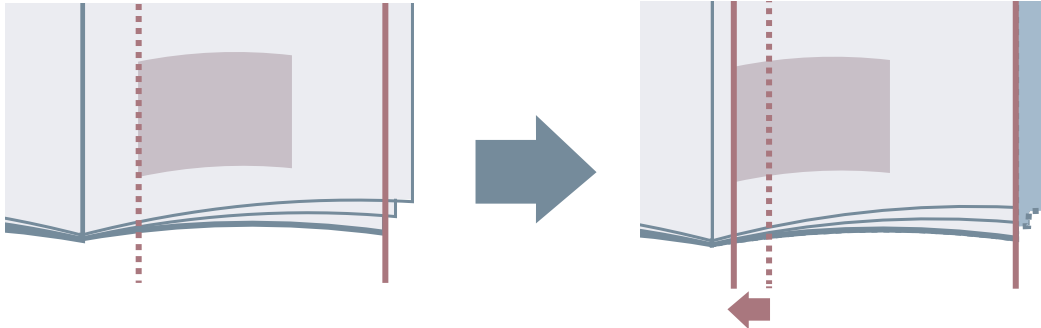

- 1** Display the [Basic Settings] or [Finishing] sheet.
- 2** Select [Booklet Printing] from [1-sided/2-sided/Booklet Printing] or [Print Style].
- 3** Click [Booklet].
- 4** Select [Booklet Printing Process] > [With Device Settings].
- 5** Select [Use Creep (Displacement) Correction] → select a correction method in [Displacement Correction Method].
If you select [Manual Correction], specify the amount of print area displacement between the outermost page and centermost page in [Correction Width].
- 6** Click [OK].

Related Topics

- ▶ [Basic Settings] Sheet(P. 126)
- ▶ [Finishing] Sheet(P. 132)
- ▶ Booklet Printing(P. 36)

Saddle Stitched Booklet Printing

When creating and printing a booklet, you can output pages that are stapled in the center. Depending on the device, you can also trim and align the edges of the pages.

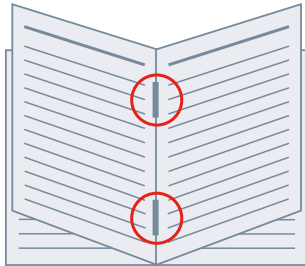

- 1** Display the [Basic Settings] or [Finishing] sheet.
- 2** Select [Booklet Printing] from [1-sided/2-sided/Booklet Printing] or [Print Style].
- 3** Select a finishing method from [Saddle Stitch Setting].
If you select [Fold + Saddle Stitch + Trim]/[Fold + Trim] from [Saddle Stitch Setting], perform the following procedure.
- 4** Display the [Finishing] sheet.
- 5** Select a trim width adjustment method from [Trim Settings] → specify the values according to the method that you select.

Related Topics

- ▶ [Basic Settings] Sheet(P. 126)
- ▶ [Finishing] Sheet(P. 132)
- ▶ Booklet Printing(P. 36)
- ▶ Saddle Press Processing When Creating Saddle Stitched Booklets(P. 40)
- ▶ Trimming Pages When Creating Saddle Stitched Booklets(P. 41)

Saddle Press Processing When Creating Saddle Stitched Booklets

When performing saddle stitched booklet printing, you can press the bound portion so that it is flattened.

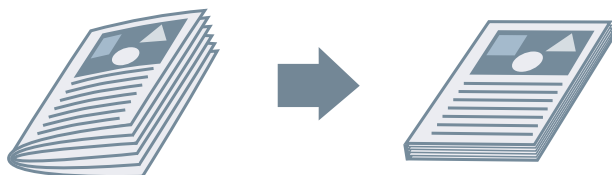

- 1** Display the [Basic Settings] or [Finishing] sheet.
- 2** Select [Booklet Printing] from [1-sided/2-sided/Booklet Printing] or [Print Style].
- 3** Select a finishing method from [Saddle Stitch Setting].
If you select [Fold + Saddle Stitch + Trim]/[Fold + Trim] from [Saddle Stitch Setting], set the trim width adjustment method in the [Finishing] sheet.
- 4** Click [Booklet].
- 5** Select [Saddle Press] → specify the force of saddle press processing in [Saddle Press Adjustment].
- 6** Click [OK].

Related Topics

- ▶ [Basic Settings] Sheet(P. 126)
- ▶ [Finishing] Sheet(P. 132)
- ▶ Saddle Stitched Booklet Printing(P. 39)

Trimming Pages When Creating Saddle Stitched Booklets

When performing saddle stitched booklet printing, you can trim and align the edges of the pages.

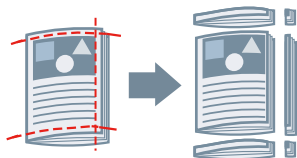

- 1** Display the [Finishing] sheet.
- 2** Select [Booklet Printing] from [Print Style].
- 3** Select [Fold + Saddle Stitch + Trim]/[Fold + Trim] from [Saddle Stitch Setting].
- 4** Select a trim width adjustment method from [Trim Settings] → specify the values according to the method that you select.

Related Topics

- ▶ [Basic Settings] Sheet(P. 126)
- ▶ [Finishing] Sheet(P. 132)
- ▶ Saddle Stitched Booklet Printing(P. 39)

Perfect Binding

You can apply glue to the gutter side of the contents and encloses them in a cover to create a booklet.

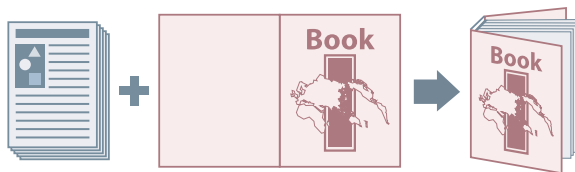

- 1** Display the [Finishing] sheet.
- 2** Select [Perfect Binding [1-sided]] or [Perfect Binding [2-sided]] from [Print Style].
- 3** Confirm the content of [Setting List].
- 4** If you want to change the settings, click [Perfect Binding Settings] → set the required items.
 When printing on a cover, select [Lay out Data the Same Size as Cover] from [Perfect Bound Cover Settings] > [Print Style] → specify [Front Cover Print Side]/[Back Cover Print Side].
 When adjusting the finishing size, click [Finishing Adjustment] → configure the appropriate settings → click [OK].
- 5** Click [OK].

Related Topics

- ▶ [Finishing] Sheet(P. 132)

Using Various Types of Paper

Using Various Types of Paper	44
Registering Custom Paper Sizes	45
Inserting Sheets Between Transparencies	46
Inserting Sheets	47
Inserting Tab Paper	48
Printing on Tab Paper	50
Adding Cover Sheets	51

Using Various Types of Paper

- ▶ **Registering Custom Paper Sizes(P. 45)**
- ▶ **Inserting Sheets Between Transparencies(P. 46)**
- ▶ **Inserting Sheets(P. 47)**
- ▶ **Inserting Tab Paper(P. 48)**
- ▶ **Printing on Tab Paper(P. 50)**
- ▶ **Adding Cover Sheets(P. 51)**

Registering Custom Paper Sizes

You can register a desired paper size and use it for printing. You can also use registered custom paper sizes to print with other devices from the computer you are using.

1 Display the print settings screen of the driver.

If displaying from [ Settings] in the Start menu

(1) Display [Bluetooth & devices] (or [Devices]).

(2) In [Printers & scanners], display the management screen for the device to set.

To display the management screen, click the device or click [Manage] for the corresponding device.

(3) Click [Printing preferences] for the device to set.

If displaying from [Control Panel]

(1) Display [Devices and Printers].

(2) From the printer list, right-click the device to be set → select [Printing preferences] from the displayed menu.

2 Display the [Page Setup] sheet.

3 Click [Custom Paper Size].

4 In the [Custom Paper Size Settings] dialog box, set [Name of Custom Paper Size], [Unit], and [Paper Size] → click [Register].

To use the custom paper selected on the [Page Setup] Sheet > [Output Size] as a regional paper size, enable [Use Some Custom Paper Sizes as Regional Paper Sizes].

5 Click [OK].

Related Topics

 [Page Setup] Sheet(P. 129)

Inserting Sheets Between Transparencies

You can print with sheets of paper inserted between transparencies. You can also print on the inserted sheets.

- 1 Display the [Paper Source] sheet.**
- 2 Select [Select by] > [Paper Source]/[Paper Type].**
- 3 Select [Transparency Cover Sheets] from [Paper Selection].**

4 Set [Transparencies] for [Cover Sheets].

If you select [Select by] > [Paper Source], select the paper source in which the paper to be used is set.

If you select [Select by] > [Paper Type], select the type of paper to be used.

- 5 If you also want to print on inserted sheets, select [Print on Cover Sheets].**

Related Topics

- [▶ \[Paper Source\] Sheet\(P. 142\)](#)

Inserting Sheets

You can insert sheets of paper between specified pages.



- 1** Display the [Paper Source] sheet.
- 2** Select [Select by] > [Paper Source] or [Paper Type].
- 3** Select [Insert Sheets] from [Paper Selection] → click [Insert Sheets Settings].
- 4** In the [Insert Sheets Settings] dialog box, select [Inserted Sheets] from [Sheets to Insert].
- 5** Set [Paper Source], [Print on], and [Insert] → click [Add].
The settings for inserting sheets are added to [Setting List].
- 6** Click [OK].
- 7** Select the paper for content pages from [Original Paper Source] or [Original Paper Type].

Related Topics

- ▶ [Paper Source] Sheet(P. 142)
- ▶ Inserting Tab Paper(P. 48)

Inserting Tab Paper

You can insert tab paper between specified pages. You can also print on the tab part.



- 1** Display the [Paper Source] sheet.
- 2** Select [Select by] > [Paper Source] or [Paper Type].
- 3** Select [Insert Sheets] from [Paper Selection] → click [Insert Sheets Settings].
- 4** In the [Insert Sheets Settings] dialog box, select [Tab Paper] from [Sheets to Insert].
- 5** Set [Paper Source], [Print on], and [Insert].
- 6** If you want to change the paper type of the tab paper, click [Tab Paper] > [Settings] → select the paper type to be used from [Paper Type] → click [OK].
To set the print position on the tab paper, follow the procedure below.
- 7** Click [Tab Details].
- 8** In the [Tab Details] dialog box, set [Printing Position on Tab] → click [OK].
To shift the print data to the tab part, select [Offset Printing Position] → specify the distance to shift the data in [Offset Width] → click [OK].
To print the print data without shifting it, select [Do Not Offset Printing Position] → select the tab paper size from [Tab Paper Size] → click [OK].
- 9** In the [Insert Sheets Settings] dialog box, click [OK].
- 10** Select the paper for content pages from [Original Paper Source] or [Original Paper Type].

Related Topics

- ◉ [Paper Source] Sheet(P. 142)

▶ **Printing on Tab Paper(P. 50)**

Printing on Tab Paper

You can print on the tab part of tab paper.

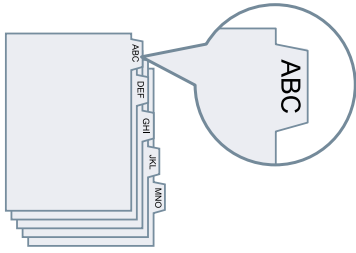

- 1** Display the [Paper Source] sheet.
- 2** Select [Select by] > [Paper Type].
- 3** Click [Paper Type] > [Settings].
- 4** In the [Paper Type Settings] dialog box, select tab paper from [Paper Type] → click [OK].

To set the print position on the tab paper, follow the procedure below.

- 5** Click [Tab Details].
- 6** In the [Tab Details] dialog box, set [Printing Position on Tab] → click [OK].

To shift the print data to the tab part, select [Offset Printing Position] → specify the distance to shift the data in [Offset Width] → click [OK].

To print the print data without shifting it, select [Do Not Offset Printing Position] → select the tab paper size from [Tab Paper Size] → click [OK].

Related Topics

- ▶ [Paper Source] Sheet(P. 142)
- ▶ Inserting Tab Paper(P. 48)

Adding Cover Sheets

You can add front and back covers to print data. You can also use paper that differs from that of the content pages, and specify which side(s) of the cover(s) to print on.

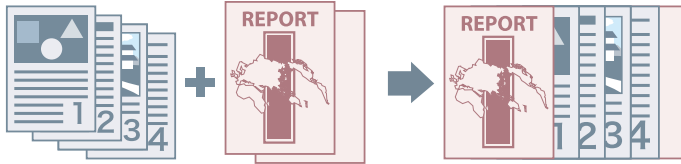

- 1** Display the [Paper Source] sheet.
- 2** Click [Front/Back Cover Settings].
- 3** In the [Front/Back Cover Settings] dialog box, select the cover(s) to add from [Cover Settings].
- 4** If you want to set the front cover, set [Front Cover] > [Paper Source] and [Print on].
- 5** If you want to set the back cover, set [Back Cover] > [Paper Source] and [Print on].
- 6** Click [OK].

Related Topics

- [Paper Source] Sheet(P. 142)

Printing Multiple Files Together

Printing Multiple Files Together	53
About the [Edit and Preview] Function	54
Printing Files Together	55
Checking the Print Preview	57
Changing the Print Settings of the Combined File	59

Printing Multiple Files Together

- ▶ **About the [Edit and Preview] Function(P. 54)**
- ▶ **Printing Files Together(P. 55)**
- ▶ **Checking the Print Preview(P. 57)**
- ▶ **Changing the Print Settings of the Combined File(P. 59)**

About the [Edit and Preview] Function

The [Edit and Preview] Function allows you to combine multiple files into one for printing.

You can set the [Edit and Preview] function from [Output Method] in each sheet of the print settings screen.

When you click the print button of an application, the Canon PageComposer main screen opens, and you can also do the following:

- Preview the print data for confirmation
- Change the print settings after checking the preview
- Delete unnecessary pages
- Perform proof printing
- Combine data created with different applications into one file for printing
- Unify the print settings when combining multiple files



Related Topics

- ▶ [Common Settings for All Sheets\(P. 123\)](#)
- ▶ [Canon PageComposer\(P. 181\)](#)
- ▶ [Printing Files Together\(P. 55\)](#)
- ▶ [Checking the Print Preview\(P. 57\)](#)
- ▶ [Changing the Print Settings of the Combined File\(P. 59\)](#)

Printing Files Together

You can combine multiple files into one file and print it. You can change the print settings for editing the combined file using Canon PageComposer.

Here, the procedure for performing operations from the icons in the toolbar of Canon PageComposer will be explained. You can also perform operations from the menu.

1 Display the appropriate sheet from the print settings screen of the driver.

2 Select [Edit and Preview] from [Output Method] → click [OK].

If you want to set the output method for the combined file, click [Details] → select the output method from [Output Method After Edit and Preview] → click [OK].

3 Click [OK] in the print settings screen → click [Print] or [OK] in the print screen.

The Canon PageComposer main screen is displayed.

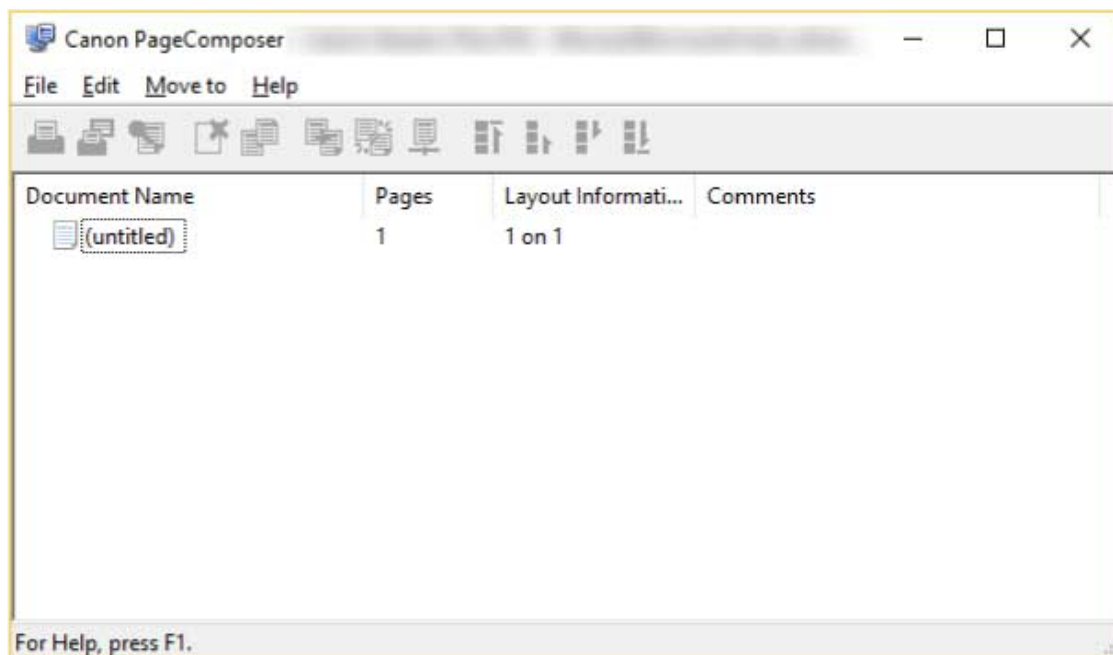

4 Repeat steps 1 to 3 for each file you want to combine.

5 In the Canon PageComposer main screen, select the files you want to combine from the list → click [] (Combine Documents).

6 In the [Combine] dialog box, set a name in [Document Name] if required.

7 If you want to change the print settings, click [Print Settings] sheet → set the required items → click [Combine].

You can check the current settings in the preview.

If you want to delete a page, select the page in the preview → click [Delete].

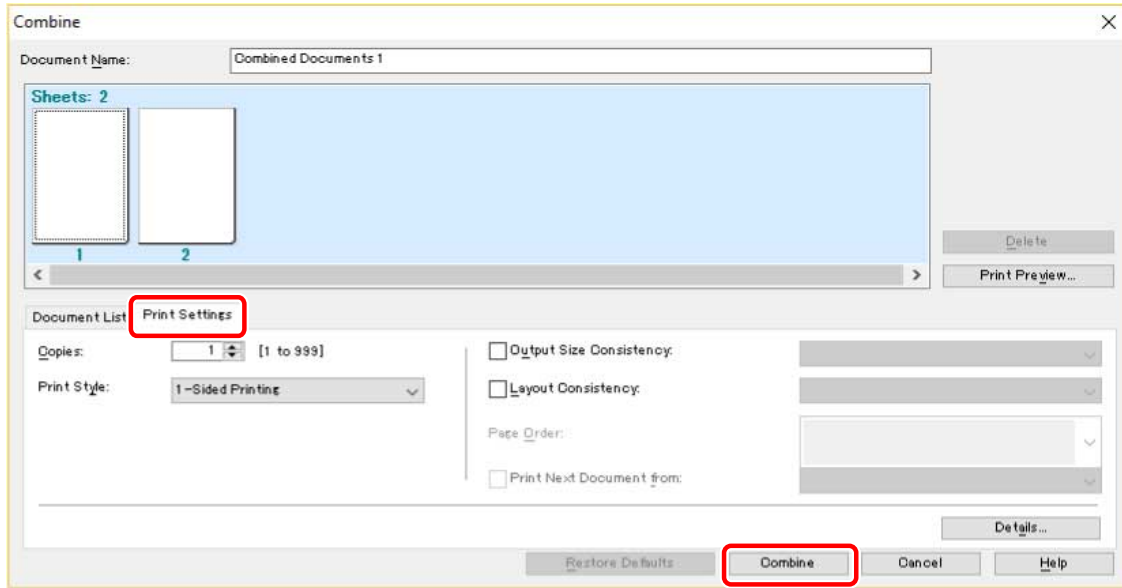

- 8** In the Canon PageComposer main screen, select the combined file → click [] (Print).

Related Topics

- ▶ Common Settings for All Sheets(P. 123)
- ▶ Canon PageComposer(P. 181)
- ▶ Checking the Print Preview(P. 57)
- ▶ Changing the Print Settings of the Combined File(P. 59)

Checking the Print Preview

You can preview the print data and check the page layout settings before printing.

Here, the procedure for performing operations from the icons in the toolbar of Canon PageComposer will be explained. You can also perform operations from the menu.

1 Display the appropriate sheet from the print settings screen of the driver.

2 Select [Edit and Preview] from [Output Method] → click [OK].

If you want to set the output method after combining files, click [Details] → select the output method from [Output Method After Edit and Preview] → click [OK].

3 Click [OK] in the print settings screen → click [Print] or [OK] in the print screen.

The Canon PageComposer main screen is displayed.

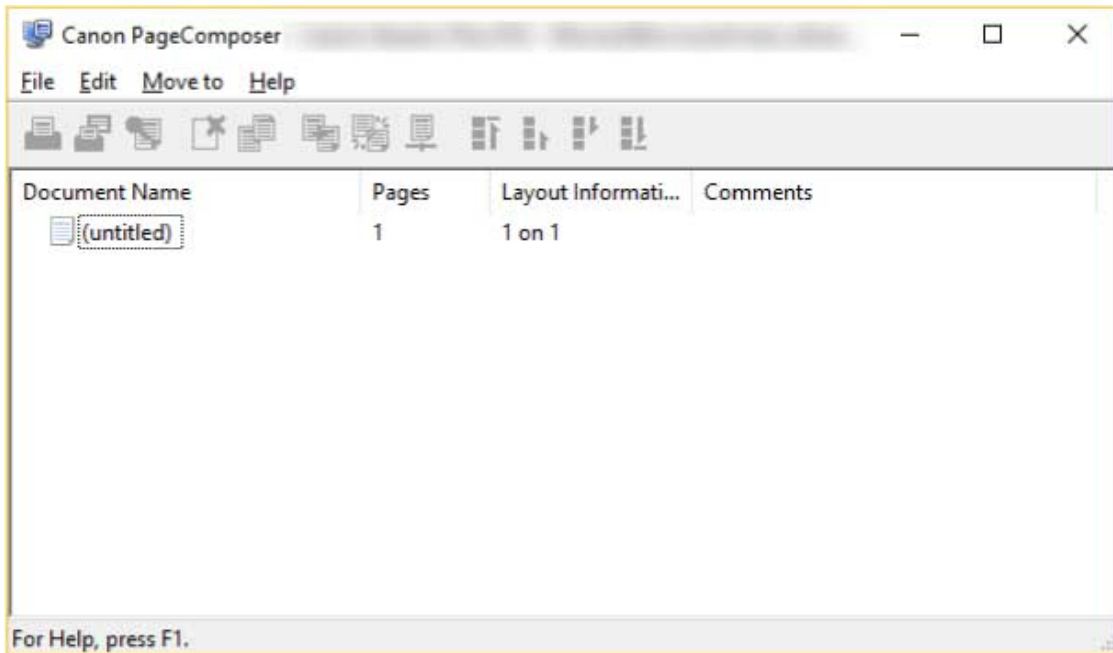

4 In the Canon PageComposer main screen, select the file whose print preview you want to check from the list → click [] (Print Preview).

5 In the [Print Preview] dialog box, check the preview → click [Close].

Click [] (Next) to display the next page.

Click the page image to zoom in or out.

Related Topics

- ▶ [Common Settings for All Sheets\(P. 123\)](#)
- ▶ [Canon PageComposer\(P. 181\)](#)
- ▶ [Printing Files Together\(P. 55\)](#)
- ▶ [Print results are unsatisfactory\(P. 187\)](#)

Changing the Print Settings of the Combined File

You can change the print settings of the combined file using Canon PageComposer. When editing files with different page sizes or layouts, you can unify the settings.

Here, the procedure for performing operations from the icons in the toolbar of Canon PageComposer will be explained. You can also perform operations from the menu.

1 In the Canon PageComposer main screen, select the file whose settings you want to change from the list → click [] (Change Print Settings).

2 In the [Change Print Settings] dialog box, set a name in [Document Name] if required.

3 Click [Print Settings] sheet → set the required items.

If you want to unify the output size settings, select [Output Size Consistency] → select a paper size.

If you want to unify the page layout settings, select [Layout Consistency] → select a layout setting.

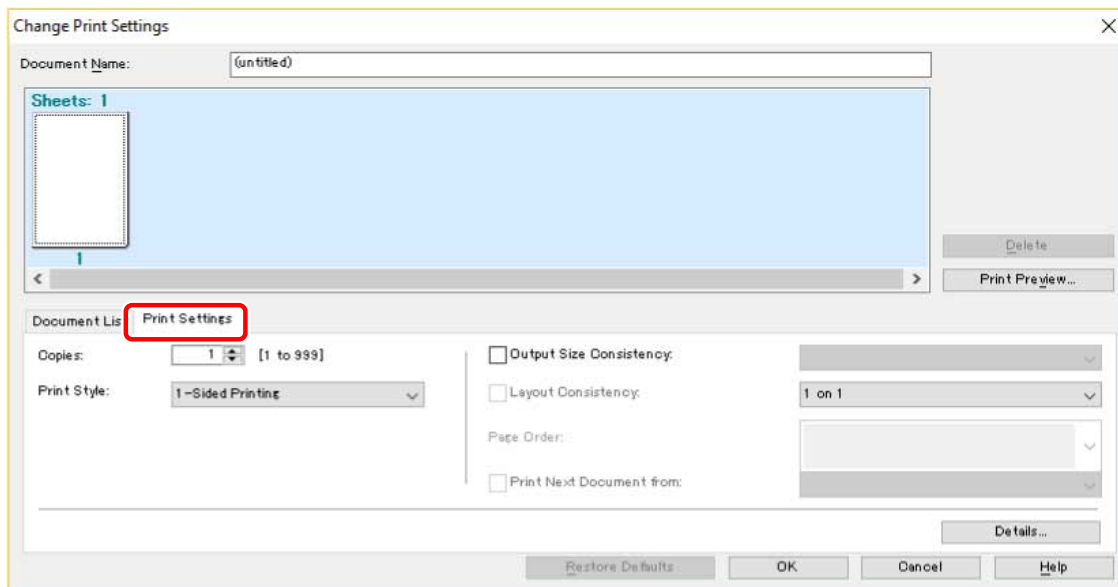

4 If you want to set where to start printing the next file from when combining files, select [Print Next Document from] → select an item.

5 If you want to specify detailed settings in the print settings screen of the driver, click [Details] → specify the relevant settings → click [OK].

6 In the [Change Print Settings] dialog box, click [OK].

Related Topics

- ▶ [Canon PageComposer\(P. 181\)](#)
- ▶ [Printing Files Together\(P. 55\)](#)

Setting Color Printing Details

Setting Color Printing Details	62
Adjusting Colors (PS3)	63
Cautions When Printing in Color from a PostScript Application (PS3)	64

Setting Color Printing Details

- ▶ **Adjusting Colors (PS3)(P. 63)**
- ▶ **Cautions When Printing in Color from a PostScript Application (PS3)(P. 64)**

Adjusting Colors (PS3)

If you are using the PS3 driver, you can adjust color, brightness, and contrast.

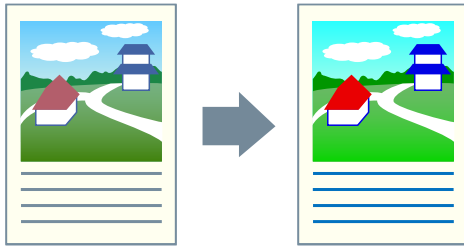

- 1** Display the [Color] sheet.
- 2** Click [Details].
- 3** In the [Detailed Settings] dialog box, select [RGB Color Input Adjustment] → click [Settings].
- 4** In the [RGB Color Input Adjustment Details] dialog box, set the color, brightness, and contrast → click [OK].
- 5** Click [OK] in the [Detailed Settings] dialog box.

Related Topics

- 🔗 [Color] Sheet (PS3)(P. 157)
- 🔗 Cautions When Printing in Color from a PostScript Application (PS3)(P. 64)

Cautions When Printing in Color from a PostScript Application (PS3)

If you perform color printing from a PostScript application* using the PS3 driver, the data processing method changes depending on the combination of settings for [Device Settings] sheet > [PS Output from Application] and printing functions.

The print functions that affect the data processing method are indicated below.

Poster [N x N] / Origin at Center / Watermark / Edit and Preview / Layout Options / Print Banner Page / Rotate Pages for Layout / paper feed methods other than [Same Paper for All Pages] / Use CanoFine / [Distinguish between Color/B&W Pages at Host]

Configure the appropriate settings according to the goal of printing.

* An application such as Adobe Reader, Adobe Acrobat, Adobe Illustrator, or Adobe Photoshop

[PS Output from Application] > [Auto]

- When a print function that affects the data processing method is set
RGB color model is used.
- When a print function that affects the data processing method is not set
Application generates PostScript code itself.
CMYK color model is normally used.

[PS Output from Application] > [On]

Print functions that affect the data processing method cannot be used.

[PS Output from Application] > [Off]

RGB color model is used.



NOTE

- The hues in the printed result when an RGB color model is used and those in the printed result when a CMYK color model is used may differ.

Related Topics

- [\[Device Settings\] Sheet\(P. 165\)](#)

Editing Favorite Settings

Editing Favorite Settings	66
Registering Favorite Settings	67
Editing the Favorite Settings List	68

Editing Favorite Settings

- ▶ **Registering Favorite Settings(P. 67)**
- ▶ **Editing the Favorite Settings List(P. 68)**

Registering Favorite Settings

You can register frequently used settings as a profile.

- 1 Display the appropriate sheet from the print settings screen of the driver → configure the settings you want to register.**
- 2 Click [Add] to the right of [Profile].**
- 3 In the [Add Profile] dialog box, set [Name] and [Icon].**
Enter a comment in [Comment] if required.
- 4 Click [OK].**

The new profile is added to [Profile]. You can apply registered print settings by simply selecting an item from [Profile].

Related Topics

- 🔗 [Common Settings for All Sheets\(P. 123\)](#)

Editing the Favorite Settings List

You can edit the [Profile] list, and import or export it to be used on other computers.

To Edit the [Profile] List

- 1 Display the appropriate sheet from the print settings screen of the driver.**
- 2 Click [Edit] to the right of [Profile].**
- 3 In the [Edit Profile] dialog box, select the profile you want to edit from [Profile List] → set [Name] and [Icon].**
Enter a comment in [Comment] if required.
If you want to delete a profile, select the profile from [Profile List] → click [Delete] → click [OK].
- 4 Click [OK].**

To Export a Profile

- 1 Display the appropriate sheet from the print settings screen of the driver.**
- 2 Click [Edit] to the right of [Profile].**
- 3 In the [Edit Profile] dialog box, select the profile you want to export from [Profile List] → click [Export].**
- 4 Specify the storage location and file name → click [Save] or [OK].**
- 5 Click [OK].**
The selected profile is saved as a "*.cfg" file.

To Import a Profile

- 1 Display the appropriate sheet from the print settings screen of the driver.**

- 2** Click [Edit] to the right of [Profile].
- 3** In the [Edit Profile] dialog box, click [Import] → select a profile file to be imported → click [Open].
- 4** Click [OK].

Related Topics

- ▶ [Common Settings for All Sheets\(P. 123\)](#)
- ▶ [Registering Favorite Settings\(P. 67\)](#)

Linking the Driver and the Device

Linking the Driver and the Device	71
Setting Device Information	72
Device Functions Settings	77
Paper Sources and Output Destinations Settings	78
Exporting a Configuration Profile	87
Importing a Configuration Profile	89
About Configuration Profile Type Settings	92
Setting the Authentication Function	93
Setting the User Name	95

Linking the Driver and the Device

- ▶ **Setting Device Information(P. 72)**
- ▶ **Device Functions Settings(P. 77)**
- ▶ **Paper Sources and Output Destinations Settings(P. 78)**
- ▶ **Exporting a Configuration Profile(P. 87)**
- ▶ **Importing a Configuration Profile(P. 89)**
- ▶ **About Configuration Profile Type Settings(P. 92)**
- ▶ **Setting the Authentication Function(P. 93)**
- ▶ **Setting the User Name(P. 95)**

Setting Device Information

This explains the procedure for setting options installed in the device and making functions exclusive to the device usable.

First, select the configuration profile that matches the printer model on the [Device Settings] sheet. The settings for using the device functions are displayed on the [Device Settings] sheet. Next, set the device function and option information. If you can use the acquire device information function, the function and option information of the device can be set automatically.

Perform a response according to the situation as shown below.

- **If you installed using the installer with a network connection:**

Normally, when installing, device information is acquired, and the configuration profile and device function and option information is automatically set. According to the following procedure, check that the configuration profile that matches the printer model is applied and that [Device Information] is set to [Auto].

- **If you installed using the installer with a USB connection:**

During installation, the configuration profile corresponding to the printer model is automatically set. The acquire device information function may not be supported when the device is connected via USB, depending on the device, driver, or environment. According to the following procedure, check that the configuration profile that matches the printer model is applied and set the device function and option information manually.

- **If the device information was not acquired during installation, or if you cannot use the device functions and options:**

According to the following procedure, set the configuration profile and device function and option information automatically or manually.

- **If you have added an option to the device:**

According to the following procedure, check that the configuration profile that matches the printer model is applied and set the added option automatically or manually.

- **If you change the printer model you are using:**

After changing the port, and set the configuration profile and device function and option information automatically or manually, according to the following procedure.

Prerequisites

- Settings at the device
 - If the device is connected via a WSD port, [Use WSD Browsing] is already set to on.
 - If the device is connected by specifying a standard TCP/IP port, [Retrieve Printer Mngt. Information from Host] is already set to on.

For details, refer to the manual of the device.

- When starting the computer, log on as a member of Administrators.
- When changing the printer model you are using, change the settings for the printing port.

Procedures

1 Display the printer properties screen.

If displaying from [ Settings] in the Start menu

(1) Display [Bluetooth & devices] (or [Devices]).

(2) In [Printers & scanners], display the management screen for the device to set.

To display the management screen, click the device or click [Manage] for the corresponding device.

(3) Click [Printer properties] for the device to set.

If you are using the driver with multiple printer models, select the device to be set, then click [Printer properties].

If displaying from [Control Panel]

(1) Display [Devices and Printers].

(2) From the printer list, right-click the device to be set → select [Printer properties] from the displayed menu.

If you are using the driver with multiple printer models, select [Printer properties], then select the device to be set.

2 Display the [Device Settings] sheet.

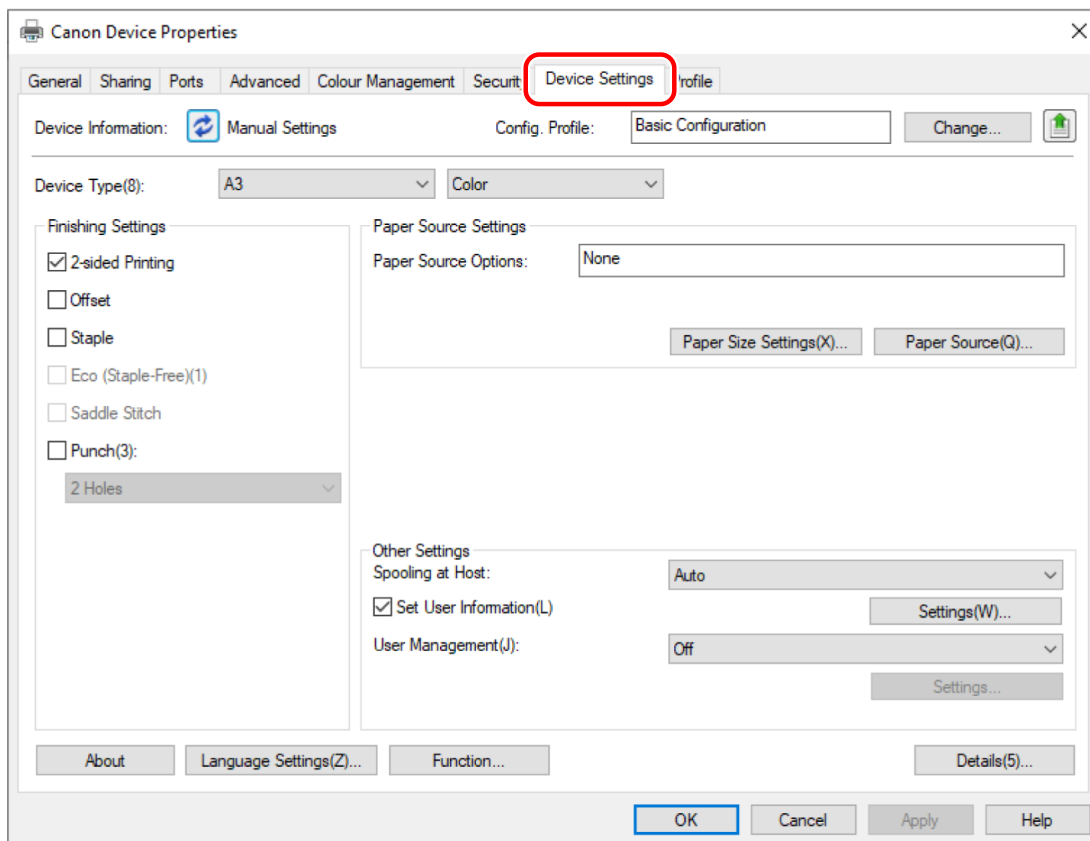

3 Check whether the configuration profile is suitable for the device you are using → if it does not match printer model, click [Change].

If a configuration profile that matches the printer model is set, skip to step 5.(P. 75)

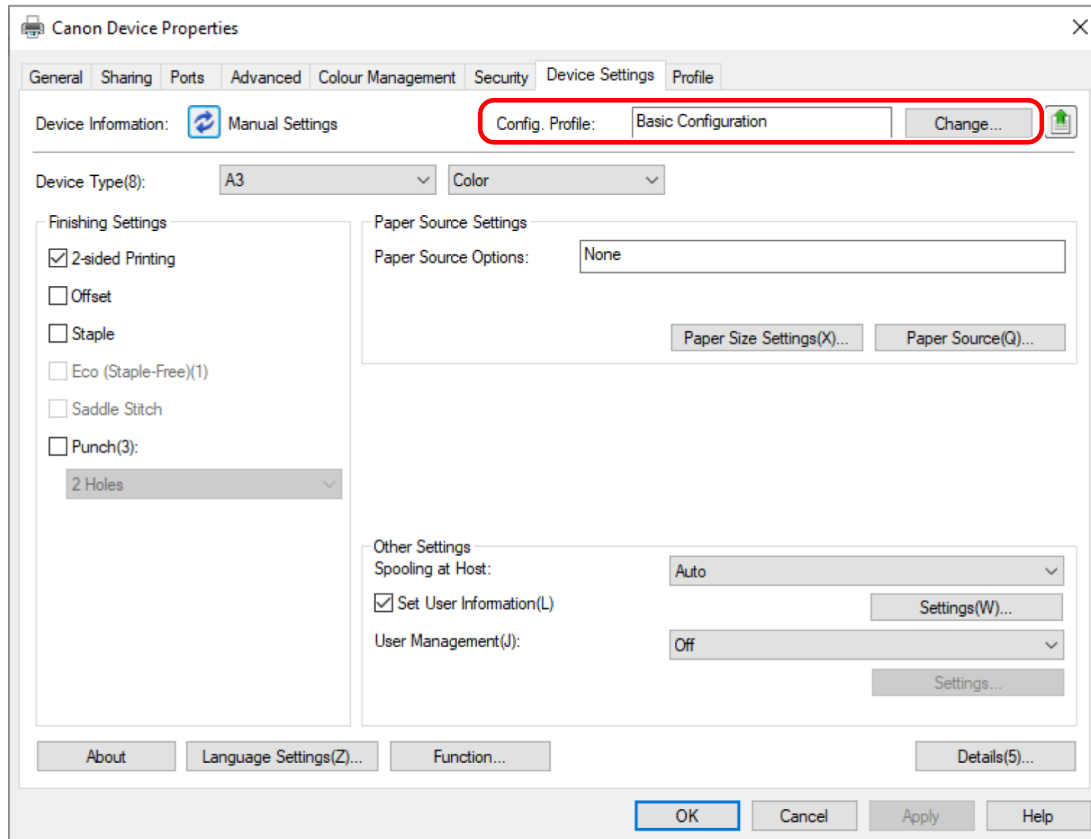

! IMPORTANT

- If you have not selected a configuration profile suitable for the device you are using, the device information may not be appropriately applied and some of the functions of the device may not be usable. Select a suitable configuration profile to display the required settings in the [Device Settings] sheet. Settings not displayed in the [Device Settings] sheet have not had the acquired device information applied to them.

4 Select [Select Configuration Profile Suitable for Your Device Automatically] → click [OK].

Select the configuration profile manually in either of the following cases:

- When device information cannot be retrieved because the device cannot connect
- When you need to select a configuration profile manually

To select a configuration profile manually, select [Select Manually] → select a configuration profile from [Configuration Profile] → click [OK].

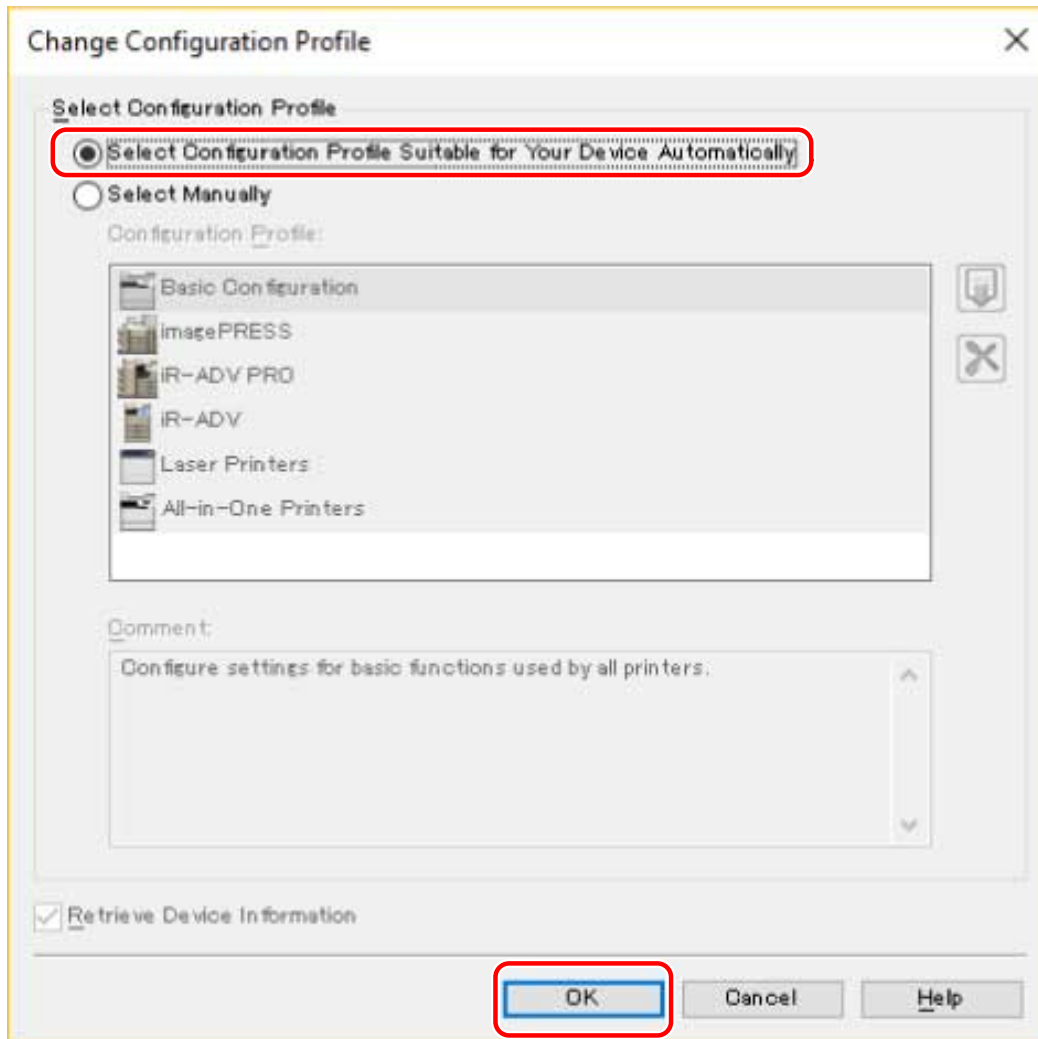

5 Confirm that [Device Information] is set to [Auto] → click [OK].

If [Device Information] is set to [Auto], the device information is acquired and the device function and option information is set automatically.

If you want to acquire the device information again when you have added an option etc., click [] (Retrieve Device Status Information).

If [Device Information] is set to [Manual Settings], the device information is not acquired. Set the options attached to the device and the functions supported by the device manually.

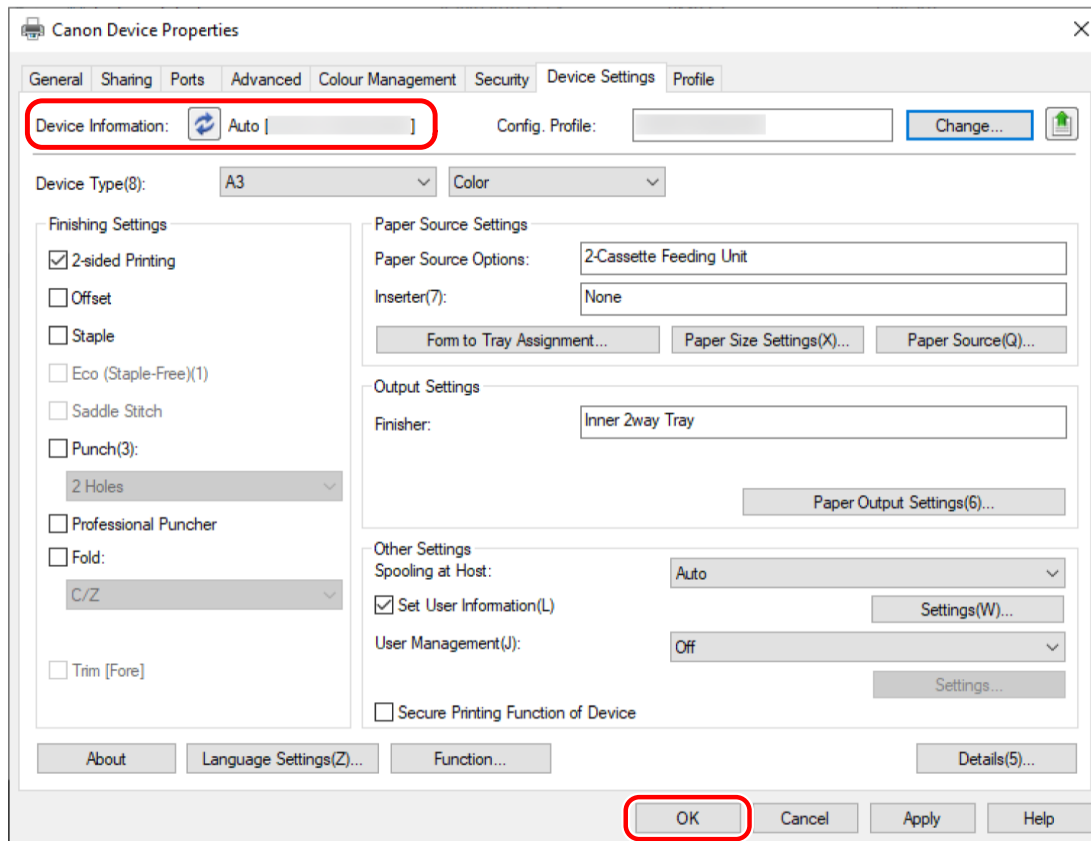

NOTE

- Even if you can use the acquired device information function, some device information must be set manually. For details, refer to the topics about the device functions settings.
- In any of the following cases, there is a possibility that you may not be able to acquire some of the device information. If that happens, set the options manually.
 - When using a USB connection
 - When using a device or port that cannot acquire device information
 - When the configuration profile is set to [Basic Configuration] or [Basic Configuration (Compatible)]
- You can export and save the device information settings in the [Device Settings] sheet as a configuration profile. By importing the exported configuration profile, you can set all of the device information at once.

Related Topics

- ▶ [\[Device Settings\] Sheet\(P. 165\)](#)
- ▶ [Device Functions Settings\(P. 77\)](#)
- ▶ [Paper Sources and Output Destinations Settings\(P. 78\)](#)
- ▶ [Importing a Configuration Profile\(P. 89\)](#)
- ▶ [Cannot use the acquire device information function or authentication function\(P. 193\)](#)

Device Functions Settings

Settings suitable for the device are required to use unique device functions. If device information is retrieved during installation, settings suitable for the device are automatically applied to the driver.

However, the optimal settings may not be applied for the following functions. Check that the settings suitable for the device have been applied before using these functions.

Functions that may require settings to be configured manually

- [Config. Profile]
- [Paper Size Settings] > [Paper Size to Use as Custom Paper Size]
- [Other Settings]
 - [Spooling at Host]
 - [PS Output from Application]
 - [Set User Information]
 - [User Management] > [Department ID Management] > [Settings]
- [Font Settings]
- [Details] > items with []



NOTE

- If [On] is selected for [Details] > [Other Settings] > [Change Configuration Profile When Retrieving Device Information], items indicated by [] may also be automatically set.
- When connected by a TCP/IP or IPP network, the device information can be acquired only by the driver.
- In a print server environment, the device information can be acquired when the Canon Driver Information Assist Service is installed in the server computer. You can install the service using the driver installer.
- The acquire device information function may not be supported when the device is connected via USB, depending on the device, driver, or environment. Set the device functions and installed options manually.

Related Topics

- ▶ [\[Device Settings\] Sheet\(P. 165\)](#)
- ▶ [Paper Sources and Output Destinations Settings\(P. 78\)](#)
- ▶ [Cannot use the acquire device information function or authentication function\(P. 193\)](#)

Paper Sources and Output Destinations Settings

This section explains the paper sources and output destinations of the device that are set in the [Device Settings] sheet for each configuration profile name.

Refer to the explanation of the configuration profile name set in the [Device Settings] sheet > [Config. Profile].

If [Basic Configuration], [Basic Configuration (Canon)], [Basic Configuration (Compatible)], or [Fiery Print Controller] is set in [Config. Profile], refer to the explanation of the configuration profile name that matches the printer model you are using.

- ▶ **Laser Printers(P. 78)**
- ▶ **iR-ADV(P. 79)**
- ▶ **iR-ADV PRO(P. 81)**
- ▶ **imagePRESS(P. 83)**
- ▶ **All-in-One Printers(P. 85)**

 **NOTE**

- Some options may not be usable depending on the driver and device you are using.
- Refer to the Readme file for restrictions and limitations concerning device settings.

Laser Printers

Paper Source Settings

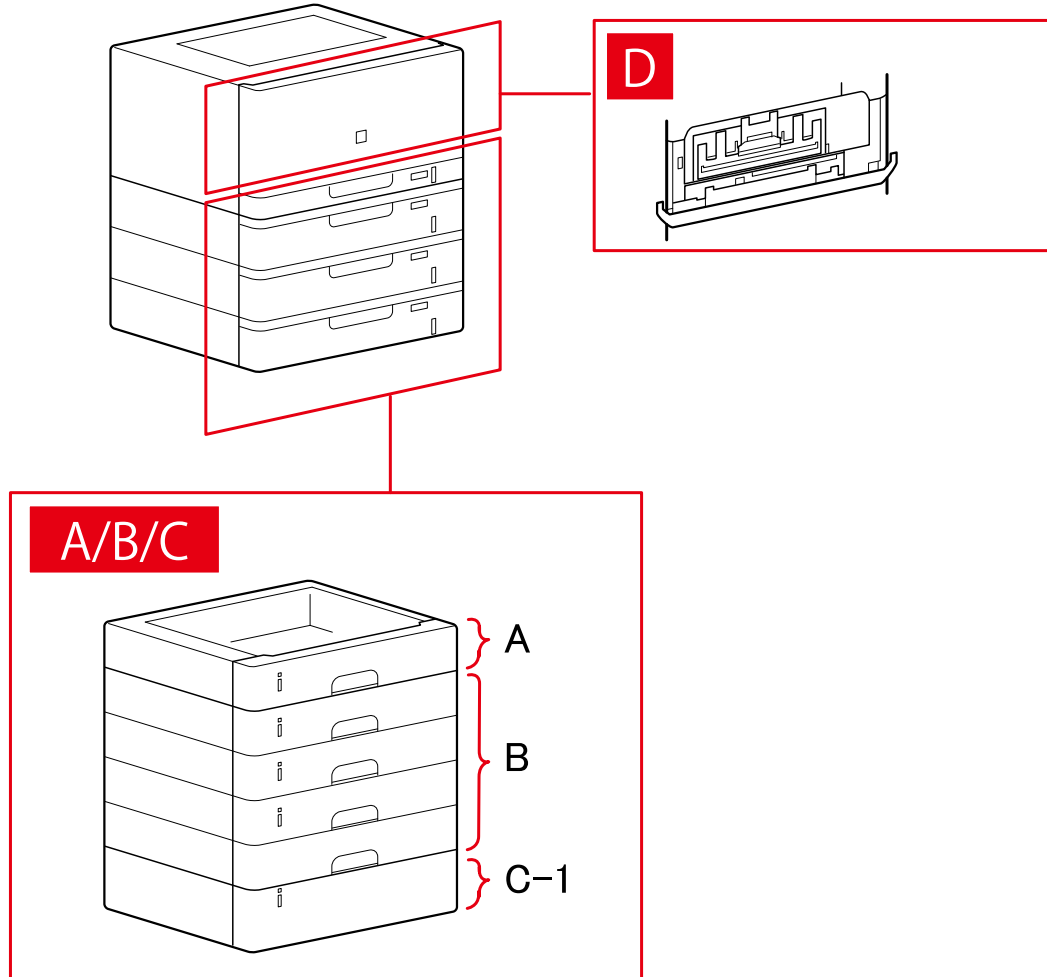

[Paper Source] Dialog Box

[Standard Paper Source]

A-1 [Drawer x 1]

[Optional Drawer/Cassette]

B-1 [Drawer x 1]

B-2 [Drawer x 2]

B-3 [Drawer x 3]

B-4 [Drawer x 4]

[Optional Deck]

C-1 [Paper Deck Unit]

D [Envelope Tray]

iR-ADV

Paper Source Settings

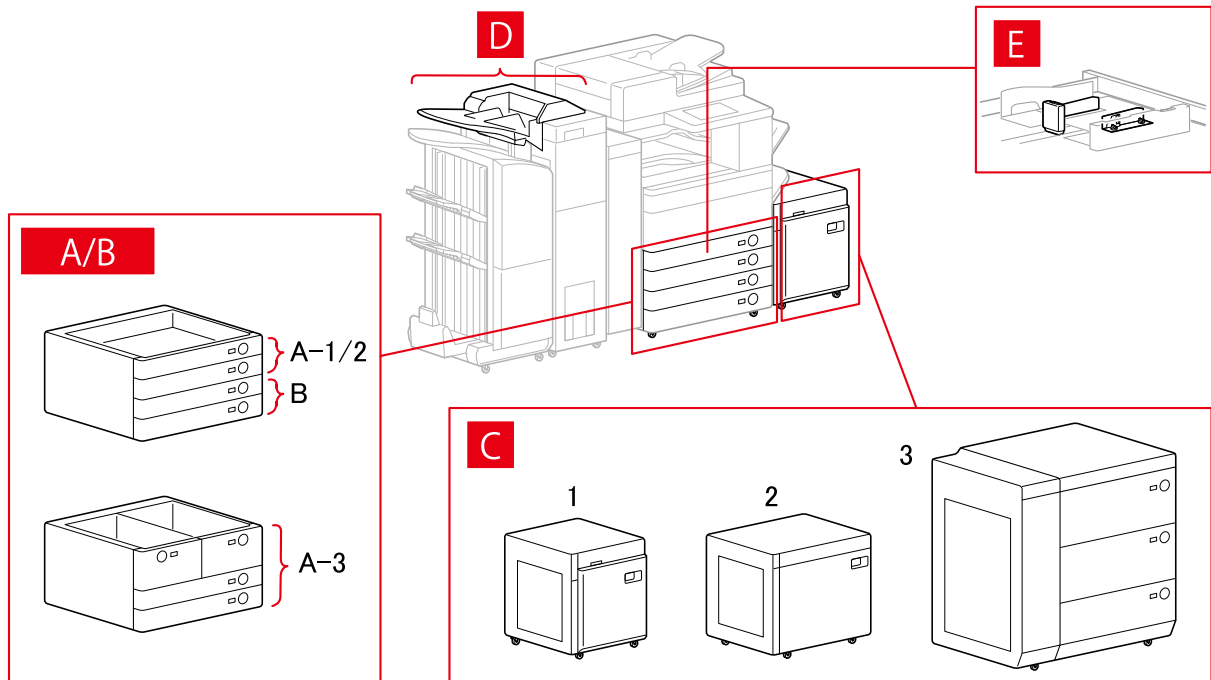

[Paper Source] Dialog Box

[Standard Paper Source]

A-1 [Drawer x 1]

A-2 [Drawer x 2]

A-3 [Deck x 2 + Drawer x 2]

[Optional Drawer/Cassette]

- B-1 [Drawer x 1]
- B-2 [Drawer x 2]
- B-3 [Drawer x 3]
- B-4 [1-Cassette Feeding Unit]
- B-5 [2-Cassette Feeding Unit]
- B-6 [3-Cassette Feeding Unit]
- B-7 [High Capacity Cassette Feeding Unit]

[Optional Deck]

- C-1 [Paper Deck Unit]
- C-2 [POD Deck Lite]
- C-3 [Multi-drawer Paper Deck]

[Inserter]

- D-1 [Document Insertion Unit (Tray x 2)]
- D-2 [Inserter of Paper Folding Unit/Document Insertion Unit (Tray x 1)]

[Envelope Feeder]

- E-1 [Drawer 1]
- E-2 [Drawer 2]

Output Destinations Settings

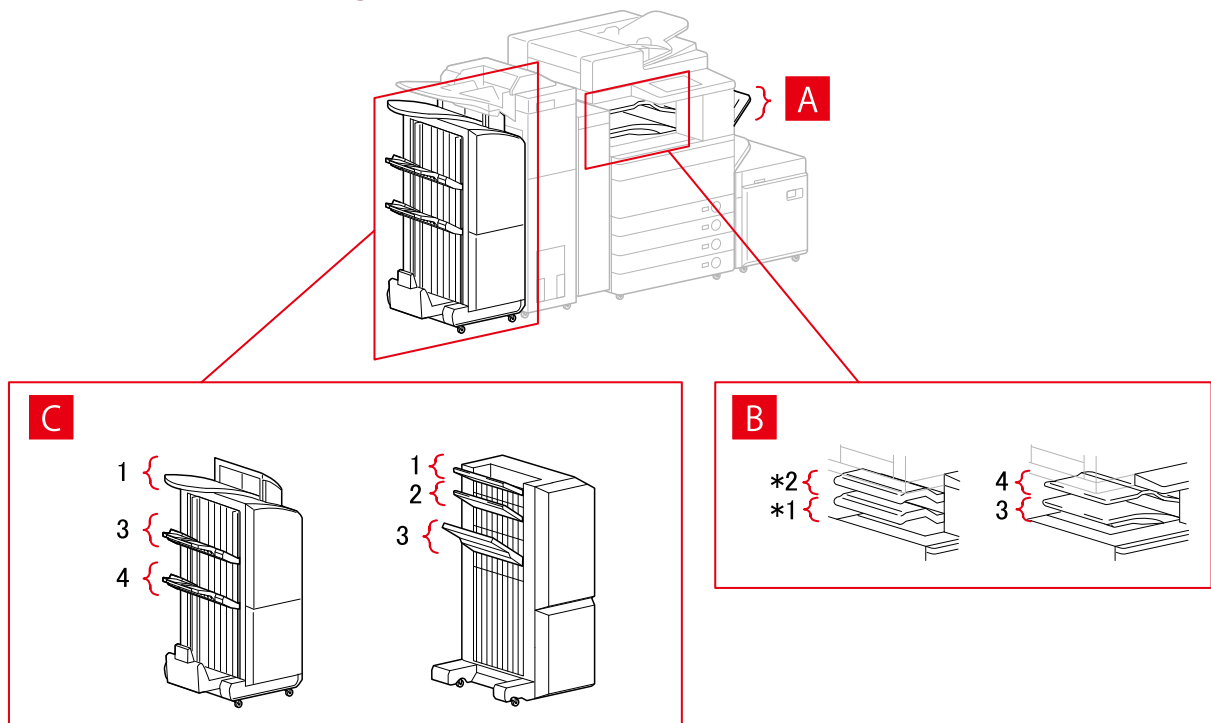

[Paper Output Settings] Dialog Box

- A-1 [Copy Tray]
- B-1 [Inner Finisher Tray]
- B-2 [Inner Finisher Additional Tray]

- B-3 [Inner Tray 1]
- B-4 [Inner Tray 2]
- C-1 [Finisher Tray 1 [No Collating]]
- C-2 [Finisher Tray 2 [No Collating]]
- C-3 [Finisher Tray 1]
- C-4 [Finisher Tray 2]

* Depending on the device, B-1 [Inner Finisher Tray] and B-2 [Inner Finisher Additional Tray] may be attached upside down.

iR-ADV PRO

Paper Source Settings

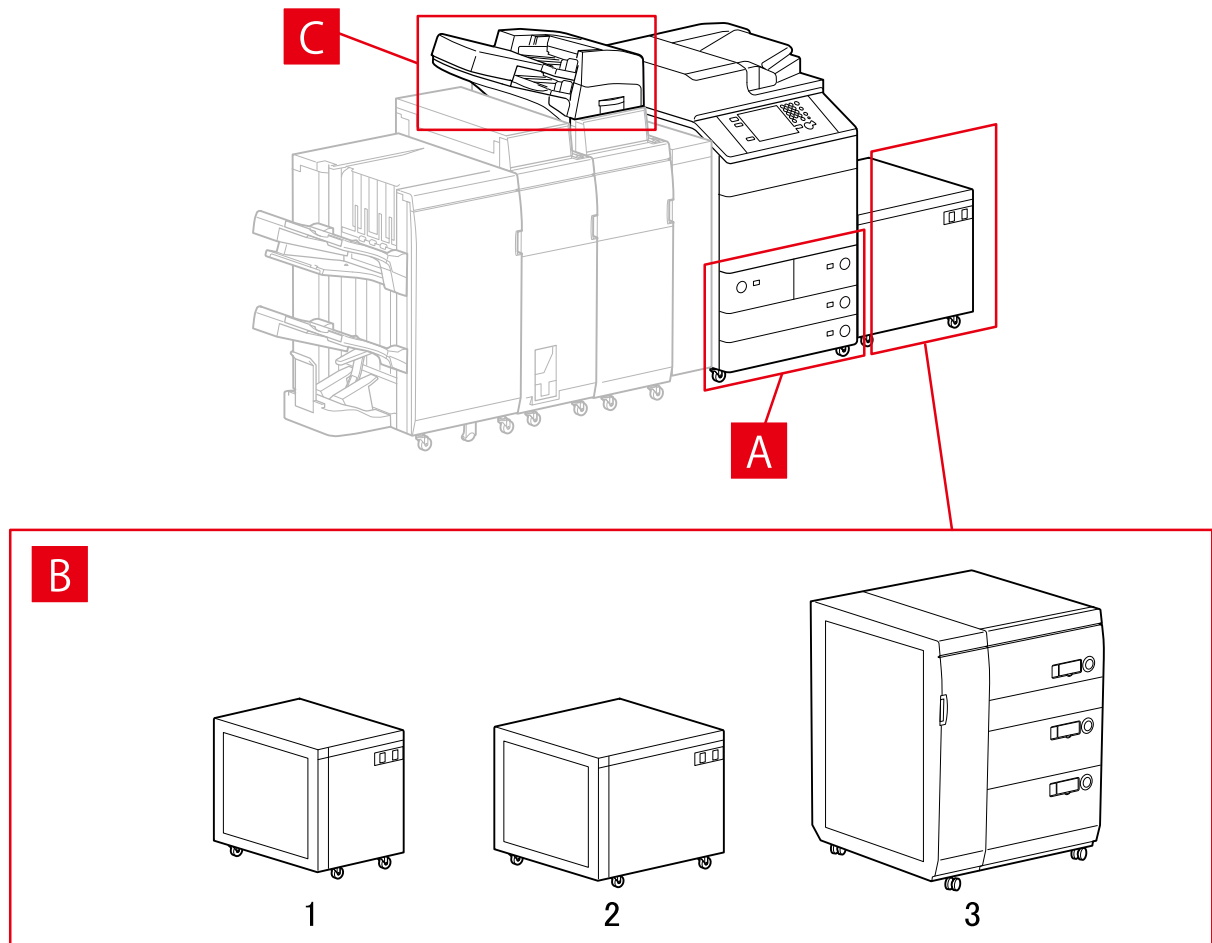

[Paper Source] Dialog Box

[Standard Paper Source]

A-1 [Deck x 2 + Drawer x 2]

[Optional Deck]

- B-1 [Paper Deck Unit]
- B-2 [POD Deck Lite]
- B-3 [Multi-drawer Paper Deck]

[Inserter]

C-1 [Document Insertion Unit (Tray x 2)]

C-2 [Inserter of Paper Folding Unit/Document Insertion Unit (Tray x 1)]

Output Destinations Settings

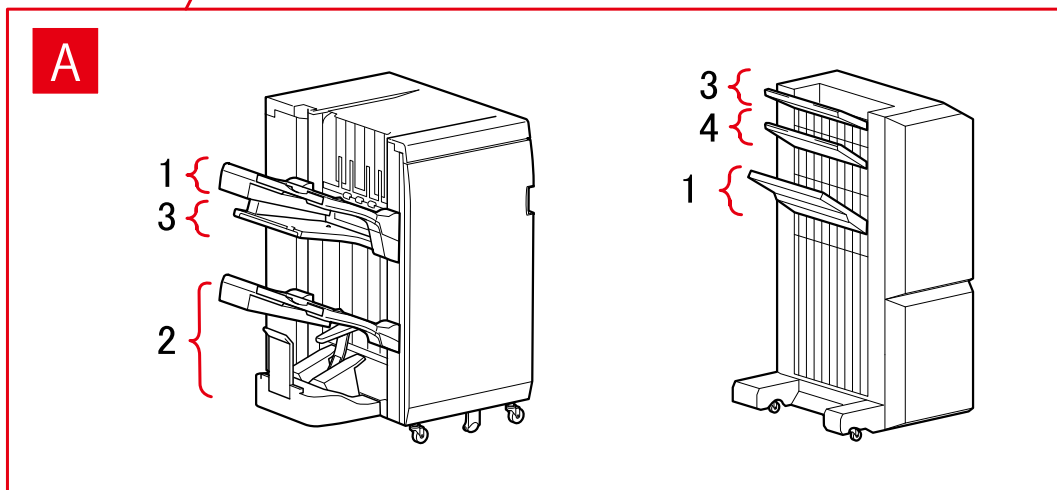
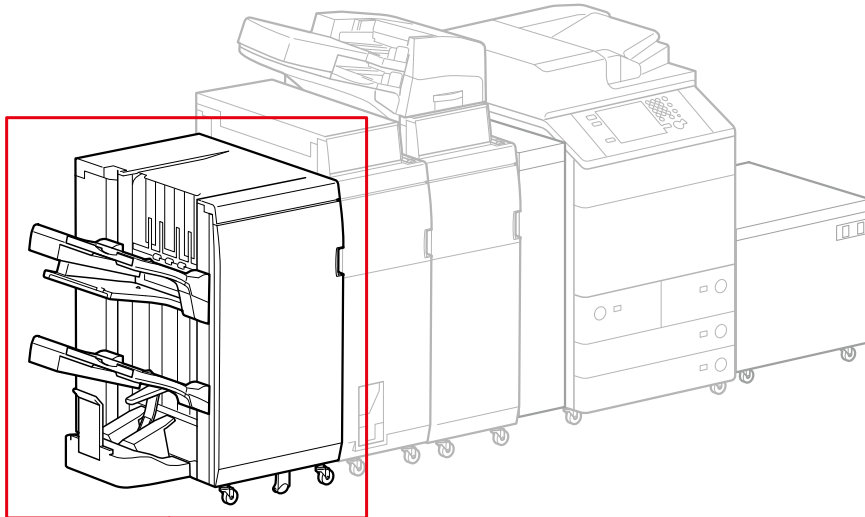

[Paper Output Settings] Dialog Box

Finisher Tray

A-1 [Finisher Tray 1]

A-2 [Finisher Tray 2]

A-3 [Finisher Tray 1 [No Collating]]

A-4 [Finisher Tray 2 [No Collating]]

imagePRESS

Paper Source Settings

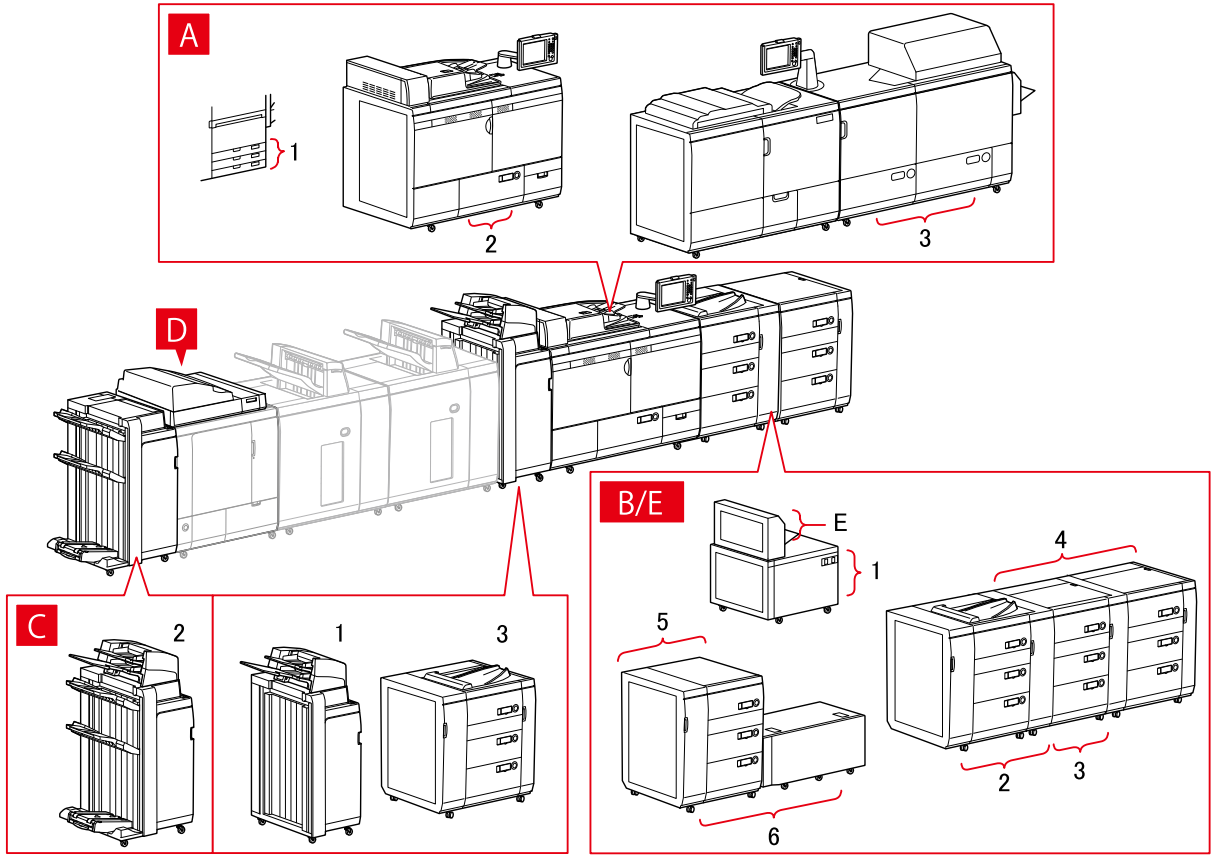

[Paper Source] Dialog Box

[Standard Paper Source]

- A-1 [Drawer x 3]
- A-2 [Deck x 1]
- A-3 [Deck x 2]

[Optional Deck]

- B-1 [POD Deck Lite]
- B-2 [POD Deck]
- B-3 [POD Deck + Secondary POD Deck]
- B-4 [POD Deck + Secondary POD Deck x 2]
- B-5 [Multi-drawer Paper Deck]
- B-6 [Multi-drawer Paper Deck + POD Deck Lite]

[Inserter]

- C-1 [Document Insertion Unit (Tray x 2)]
- C-2 [Document Insertion Unit [iPR C7010VP/6010]]
- C-3 [Multi Drawer Document Insertion Unit]

D [Inserters of Perfect Binder]

E [Multi-purpose Tray]

Output Destinations Settings

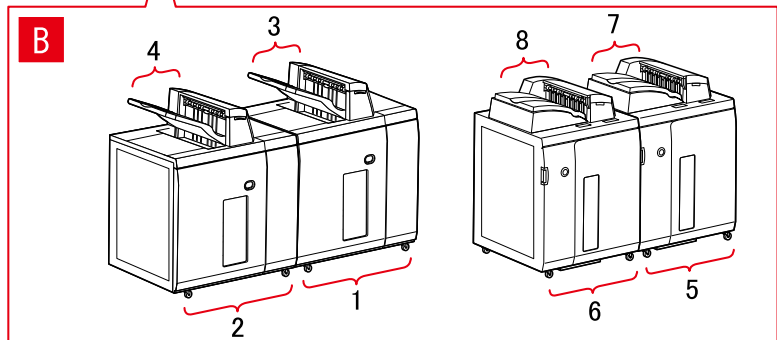
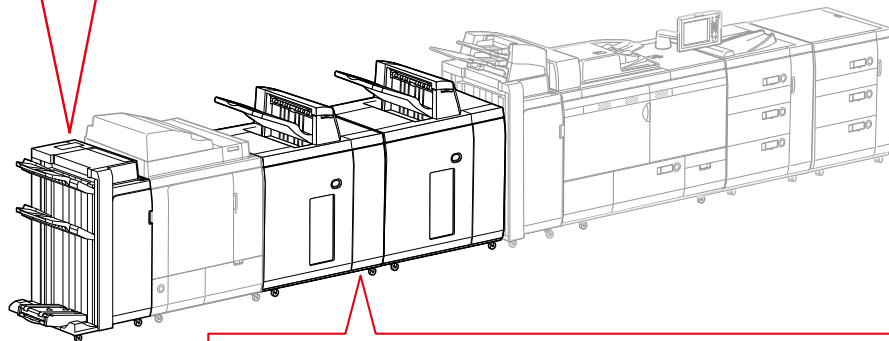
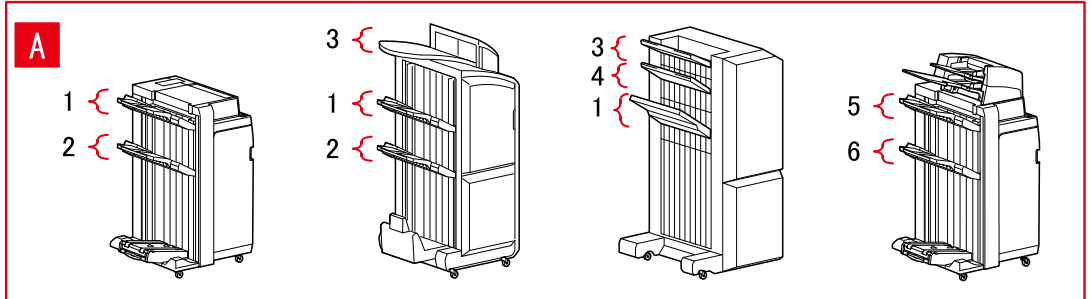

[Paper Output Settings] Dialog Box

Finisher Tray

- A-1 [Finisher Tray 1]
- A-2 [Finisher Tray 2]
- A-3 [Finisher Tray 1 [No Collating]]
- A-4 [Finisher Tray 2 [No Collating]]
- A-5 [Finisher Tray 1 [iPR C7010VP/6010]]
- A-6 [Finisher Tray 2 [iPR C7010VP/6010]]

Stacker

- B-1 [Stacker a [Stack]]
- B-2 [Stacker b [Stack]]
- B-3 [Stacker a [Output Tray]]

- B-4 [Stacker b [Output Tray]]
- B-5 [Stacker a [Stack] [iPR C7010VP/6010]]
- B-6 [Stacker b [Stack] [iPR C7010VP/6010]]
- B-7 [Stacker a [Output Tray] [iPR C7010VP/6010]]
- B-8 [Stacker b [Output Tray] [iPR C7010VP/6010]]

All-in-One Printers

Paper Source Settings

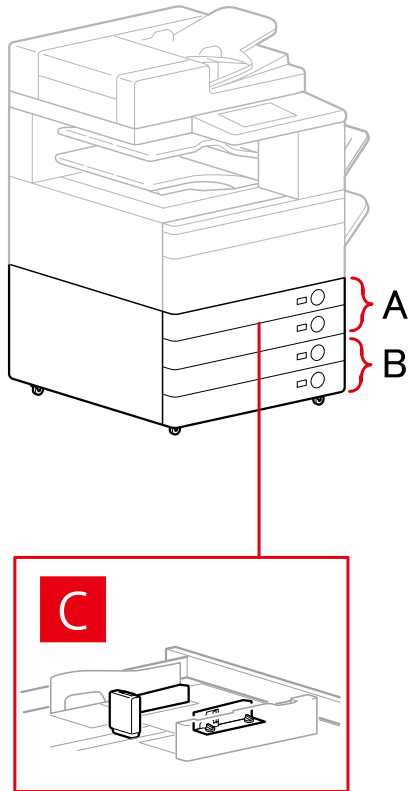

[Paper Source] Dialog Box

[Standard Paper Source]

- A-1 [Drawer x 1]
- A-2 [Drawer x 2]

[Optional Drawer/Cassette]

- B-1 [Drawer x 1]
- B-2 [Drawer x 2]
- B-3 [Drawer x 3]
- B-4 [1-Cassette Feeding Unit]
- B-5 [2-Cassette Feeding Unit]
- B-6 [3-Cassette Feeding Unit]

[Envelope Feeder]

- C-1 [Drawer 1]

C-2 [Drawer 2]

Output Destinations Settings

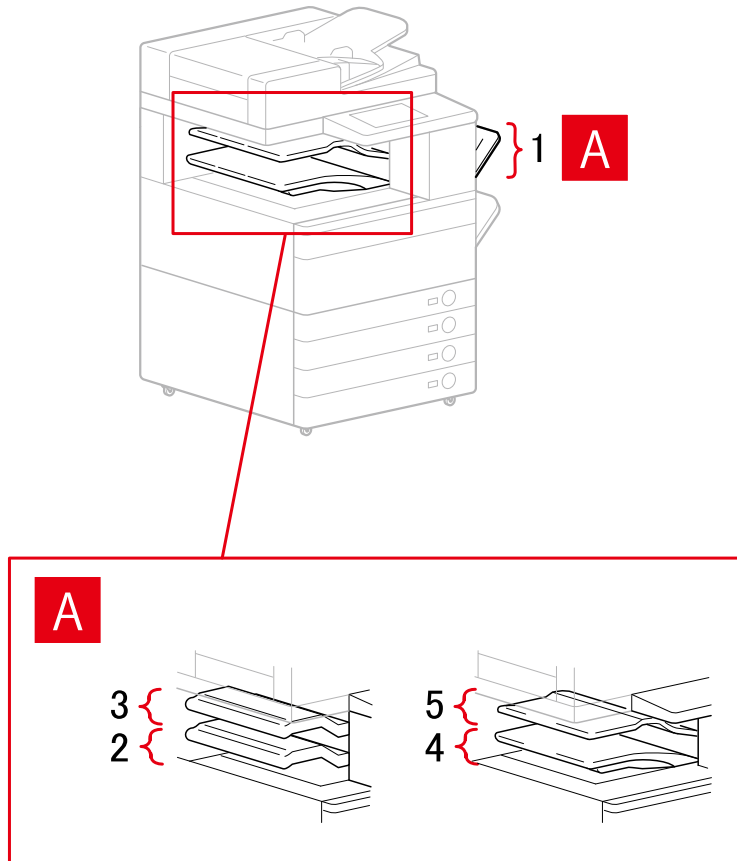

[Paper Output Settings] Dialog Box

- A-1 [Copy Tray]
- A-2 [Inner Finisher Tray]
- A-3 [Inner Finisher Additional Tray]
- A-4 [Inner Tray 1]
- A-5 [Inner Tray 2]

Related Topics

▶ [Device Settings] Sheet(P. 165)

Exporting a Configuration Profile

The settings in the [Device Settings] sheet can be exported and saved as a configuration profile file (*.typ). You can configure the same settings by importing the exported configuration profile.

This function is useful when streamlining driver settings for multiple computers or changing the items that can be set for each user.



NOTE

- You can import an exported configuration profile by clicking [Change] > [] (Import Configuration Profile) in the [Device Settings] sheet or by using the driver installer.

Prerequisites

- Settings at the device
 - If the device is connected via a WSD port, [Use WSD Browsing] is already set to on.
 - If the device is connected by specifying a standard TCP/IP port, [Retrieve Printer Mngt. Information from Host] is already set to on.
 For details, refer to the manual of the device.
- When starting the computer, log on as a member of Administrators.

Procedures

1 Display the printer properties screen.

If displaying from [ Settings] in the Start menu

- Display [Bluetooth & devices] (or [Devices]).
- In [Printers & scanners], display the management screen for the device to set.
To display the management screen, click the device or click [Manage] for the corresponding device.
- Click [Printer properties] for the device to set.

If displaying from [Control Panel]

- Display [Devices and Printers].
- From the printer list, right-click the device to be set → select [Printer properties] from the displayed menu.

2 Display the [Device Settings] sheet.

3 Check the displayed settings and option status → set the options manually as required.

4 Click [] (Export).

5 In the [Export Configuration Profile] dialog box, set [Name] and [Icon].

Enter a comment in [Comment] if required.

6 Click [Export] → specify the storage location and file name → click [Save] or [OK].

Related Topics

- ▶ [Device Settings] Sheet(P. 165)
- ▶ Importing a Configuration Profile(P. 89)

Importing a Configuration Profile

This explains the procedure for importing an exported configuration profile file (*.typ) and setting the device information.

If you cannot acquire the device information, you can apply it by importing a configuration profile exported in an environment where the information could be acquired.



IMPORTANT

- If a configuration profile suitable for the device you are using is not selected, some of the device functions may not be usable.

Prerequisites

- Settings at the device
 - If the device is connected via a WSD port, [Use WSD Browsing] is already set to on.
 - If the device is connected by specifying a standard TCP/IP port, [Retrieve Printer Mngt. Information from Host] is already set to on.

For details, refer to the manual of the device.
- When starting the computer, log on as a member of Administrators.

Procedures

1 Display the printer properties screen.

If displaying from [ Settings] in the Start menu

- (1) Display [Bluetooth & devices] (or [Devices]).
- (2) In [Printers & scanners], display the management screen for the device to set.
To display the management screen, click the device or click [Manage] for the corresponding device.
- (3) Click [Printer properties] for the device to set.

If displaying from [Control Panel]

- (1) Display [Devices and Printers].
- (2) From the printer list, right-click the device to be set → select [Printer properties] from the displayed menu.

2 Display the [Device Settings] sheet → click [Change].

Linking the Driver and the Device

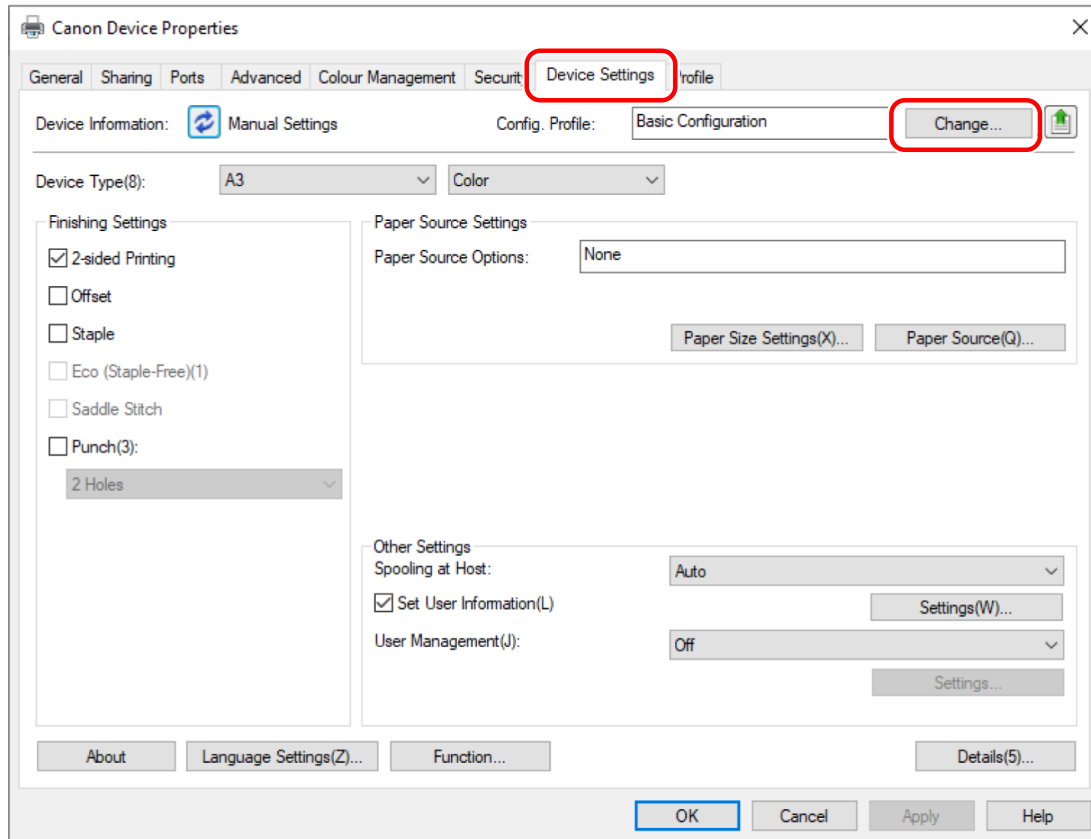

3 Select [Select Manually] → click [] (Import Configuration Profile).

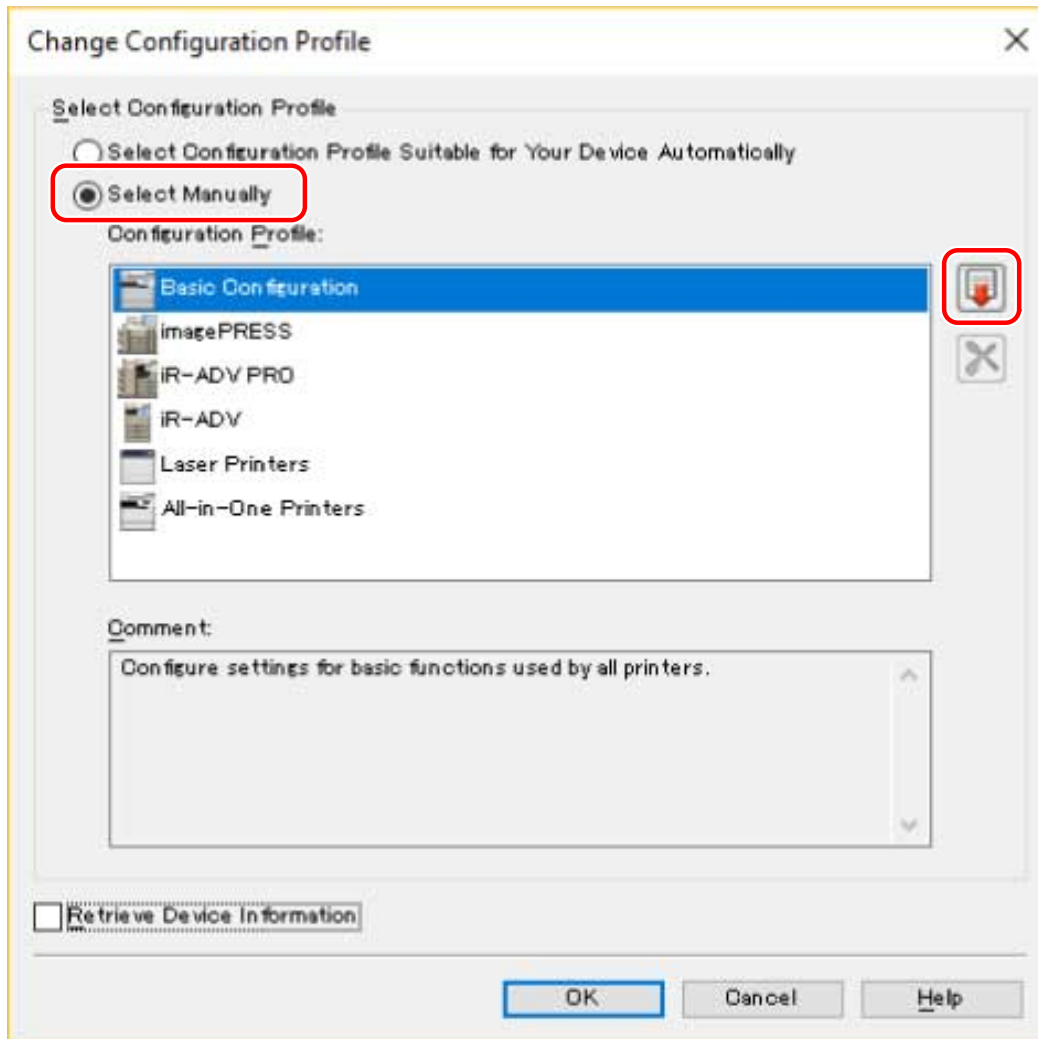

4 Select the configuration profile file to import → click [Open].

5 Click [OK] → click [OK] in the [Device Settings] sheet.

Related Topics

- ▶ [Device Settings] Sheet(P. 165)
- ▶ Exporting a Configuration Profile(P. 87)

About Configuration Profile Type Settings

If you cannot properly set items displayed in the [Device Settings] sheet even after applying a configuration profile that matches the name of the printer model, you can apply the function and option information corresponding to the device by setting a configuration profile type.

After activating [Details] > [Other Settings] > [Display Configuration Profile Types] in the [Device Settings] sheet, set a configuration profile type by clicking [Change] next to [Config. Profile].

For details of configuration profile types corresponding to devices, click the link below.

▶ [List of Configuration Profiles](#)

Related Topics

- ▶ [Setting Device Information\(P. 72\)](#)
- ▶ [\[Device Settings\] Sheet\(P. 165\)](#)

Setting the Authentication Function

You can manage printing by means of the department ID management function or the user authentication function.



Prerequisites

- When starting the computer, log on as a member of Administrators.

Procedures

1 Display the printer properties screen.

If displaying from [Settings] in the Start menu

- (1) Display [Bluetooth & devices] (or [Devices]).
- (2) In [Printers & scanners], display the management screen for the device to set.
To display the management screen, click the device or click [Manage] for the corresponding device.
- (3) Click [Printer properties] for the device to set.

If displaying from [Control Panel]

- (1) Display [Devices and Printers].
- (2) From the printer list, right-click the device to be set → select [Printer properties] from the displayed menu.

2 Display the [Device Settings] sheet.

3 Select the authentication function you want to use from [User Management] → click [Settings].

4 Select [Allow PIN Setting]/[Allow Password Settings] → enter the authentication information.

To use the department ID management function, enter the information in [Department ID] and [PIN].

To use the user authentication function, enter the information in [User Name] and [Password].

If you want to check that the authentication information set in the device and the entered content match, click [Verify].

5 Set the relevant settings → click [OK].

6 Click [Apply] in the [Device Settings] sheet.

If the [Confirm Department ID/PIN]/[Confirm User Name/Password] dialog box is displayed when printing, confirm or set the authentication information.

Related Topics

- [▶ \[Device Settings\] Sheet\(P. 165\)](#)

Setting the User Name

You can set a user name for print jobs and a PIN for secured printing. The set user name is displayed on the control panel of the device, and is printed as the user name for headers or footers.



Prerequisites

- When starting the computer, log on as a member of Administrators.

Procedures

1 Display the printer properties screen.

If displaying from [ Settings] in the Start menu

- (1) Display [Bluetooth & devices] (or [Devices]).
- (2) In [Printers & scanners], display the management screen for the device to set.
To display the management screen, click the device or click [Manage] for the corresponding device.
- (3) Click [Printer properties] for the device to set.

If displaying from [Control Panel]

- (1) Display [Devices and Printers].
- (2) From the printer list, right-click the device to be set → select [Printer properties] from the displayed menu.

2 Display the [Device Settings] sheet.

3 Select [Set User Information] → click [Settings].

4 Enter the user information in [User Name] and [PIN for Secure Print] → click [OK].

If you want to change the default user name setting, click [Default Value Settings] → set [Name to Set for User Name] → click [OK].

If you want to prevent changes to user names: Click [Default Value Settings] → select [Do Not Allow User Name Changes] → click [OK].

5 Click [Apply] in the [Device Settings] sheet.

Related Topics

- ▶ [Device Settings] Sheet(P. 165)

Setting Exceptional Pages (PS3)

Setting Exceptional Pages (PS3) 98

Setting Exceptional Pages (PS3)

If you are using the PS3 driver, you can apply printing settings for the specified page range within a document.



- 1** Display the [Exceptional Settings] sheet.
- 2** Click [Exceptional Page].
- 3** In the [Page Setup] sheet in the [Exceptional Page Settings] dialog box, specify the exceptional page range in [Page].
- 4** Set the required functions in the [Page Setup], [Quality], and [Color] sheets → click [OK].

The settings are displayed in [List of Exceptional Settings].

If you want to change an exceptional setting

Select the setting from [List of Exceptional Settings] → click [Edit].

If you want to combine multiple exceptional settings

Select the settings from [List of Exceptional Settings] → click [Merge].

You can only combine exceptional settings when the exceptional page range is continuous and the settings are the same.

If you want to delete an exceptional setting

Select the setting from [List of Exceptional Settings] → click [Delete].

Related Topics

- 🔍 [Exceptional Settings] Sheet (PS3)(P. 161)

Access Management System/ Encrypted Secure Print

Access Management System/Encrypted Secure Print	100
About the Access Management System/Encrypted Secure Print Function	101
Using the Access Management System	102
Enabling the AMS Function	103
Preparing to Print Using AMS	105
Specifying the User Information to Be Used for AMS Authentication	107
Specifying the Print Output Destination Device Using AMS	109
Retrieving Print Restriction Information Applied When Using AMS	110
Configuring an Authentication Server to Be Used in AMS User Authentication	111
Using Encrypted Secure Print	112
Enabling the Encrypted Secure Print Function	113
Enhancing the Security of the Encrypted Secure Print Function	116
Printing Using the Encrypted Secure Print Function	118

Access Management System/Encrypted Secure Print

- ▶ **About the Access Management System/Encrypted Secure Print Function(P. 101)**
- ▶ **Using the Access Management System(P. 102)**
- ▶ **Using Encrypted Secure Print(P. 112)**

About the Access Management System/Encrypted Secure Print Function

This explains an overview of the Access Management System and Encrypted Secure Print, as well as an explanation of supported languages.

For an explanation of how to use the Access Management System and Encrypted Secure Print functions of the device, refer to the manuals of the device.

AMS (Access Management System)

This refers to the "Access Management System Printer Driver Add-in."

It is sometimes referred to as AMS in this manual.

AMS is a function for retrieving user printing restriction information previously set by the administrator, and enabling print output according to those restrictions.

In this manual, server authentication (Active Directory) or domain authentication is referred to as "Active Directory Authentication."

Encrypted Secure Print

This refers to the "Encrypted Secure Print Driver Add-in for Client PC."

It is a function that strengthens security by encrypting print data when printing from a computer.

Using this function for printing enables you to prevent information leaks by outputting documents without allowing the print data to be seen by other users.

By setting a password on a computer and printing from an application, the print data is encrypted using that password and retained in the device. The document can then be decrypted and printed by entering the password at the device.

Supported Languages

The following driver display languages are supported with the Access Management System and the Encrypted Secure Print function.

English / Japanese / French / German / Italian / Spanish / Chinese (Simplified) / Korean / Chinese (Traditional)

When the Access Management System is enabled, the driver display language is limited to one of the above languages.

Functions That Cannot Be Used Together

The functions that cannot be used at the same time as the Access Management System and Encrypted Secure Print are indicated below.

- Functions that cannot be used in conjunction with the Access Management System
 - [Create a Form File] / [Use Overlay Printing] / [Set User Information]
 - Canon iW POD Hot Folder
- Functions that cannot be used in conjunction with Encrypted Secure Print
 - [Store] / [Secure Print] / [Create a Form File] / [EMF Spooling] / [Hold] / [Scheduled Print]
 - Canon iW POD Hot Folder

Using the Access Management System

- ▶ **Enabling the AMS Function(P. 103)**
- ▶ **Preparing to Print Using AMS(P. 105)**
- ▶ **Specifying the User Information to Be Used for AMS Authentication(P. 107)**
- ▶ **Specifying the Print Output Destination Device Using AMS(P. 109)**
- ▶ **Retrieving Print Restriction Information Applied When Using AMS(P. 110)**
- ▶ **Configuring an Authentication Server to Be Used in AMS User Authentication(P. 111)**

Enabling the AMS Function

This explains the procedure for enabling the AMS function.

Prerequisites

- When starting the computer, log on as a member of Administrators.

Procedures

1 Display the printer properties screen.

If displaying from [ Settings] in the Start menu

- (1) Display [Bluetooth & devices] (or [Devices]).
- (2) In [Printers & scanners], display the management screen for the device to set.
To display the management screen, click the device or click [Manage] for the corresponding device.
- (3) Click [Printer properties] for the device to set.

If displaying from [Control Panel]

- (1) Display [Devices and Printers].
- (2) From the printer list, right-click the device to be set → select [Printer properties] from the displayed menu.

2 Check whether the [AMS] sheet is displayed on the printer properties screen.

The [AMS] sheet may be displayed automatically because the device information was retrieved when the driver was installed. In this case, proceed to step 7.(P. 103)

3 Display the [Device Settings] sheet → click [Details].

4 In the displayed dialog box, display the [Other Settings] sheet → select [Access Management System] > [Enabled] → click [OK].

5 Click [OK] on the printer properties screen to close the screen → display the printer properties screen again.

For information on displaying the printer properties screen, see step 1.(P. 103)

6 Display the [AMS] sheet.

7 Select [Use AMS Function] → click [OK] or [Apply].

Related Topics

[▶ \[AMS\] Sheet\(P. 172\)](#)

Preparing to Print Using AMS

After enabling the Access Management System Printer Driver Add-in in the printer driver, specify the initial settings for printing using AMS. It is not necessary to specify the initial settings each time you print, but these settings must be specified when you add a printer icon of a device for which you set printing restrictions.

NOTE

- For information on enabling the Access Management System Printer Driver Add-in, see "[AMS] Sheet."(P. 172)
- In environments shared with a device that has the AMS function enabled, use the same driver version in all the client computers that use that device.

1 Display the [AMS] sheet.

2 Specify the user information to use for authentication.

If you have already set the user information to use for authentication on the [AMS] sheet for another printer icon, proceed to step 3.(P. 105)

For information on specifying the user information to use for authentication, see "Specifying the User Information to Be Used for AMS Authentication."(P. 107)

NOTE

- It is not necessary to set the user information to use for authentication for each printer icon. If you set it in one [AMS] sheet, the information is applied to all Access Management System Printer Driver Add-ins used on the computer you are logged on to.

3 Specify IP address/host name of the device to use for printing.

If you want to use the IP address/host name specified when installing the printer driver (Access Management System Printer Driver Add-in), proceed to step 4.(P. 105)

For information on specifying IP address/host name of the device to use for printing, see "Specifying the Print Output Destination Device Using AMS."(P. 109)

NOTE

- You cannot specify an IP address/host name of the device if you are logged on to the computer as a user without Windows administrator privileges.
- It may be necessary to specify the IP address/host name of the device again if your environment uses the "Auto Created Printer" function of XenApp.

4 Retrieve the print restriction information.

For information on retrieving print restriction information, see "Retrieving Print Restriction Information Applied When Using AMS."(P. 110)

 **NOTE**

- If you want to display the [Confirmation of Print Restrictions] dialog box to check the print restriction information each time you print, select [Check Print Restriction Information When Printing].
- Depending on your environment, the message "The printer requires your attention. Go to the desktop to take care of it." may be displayed when printing from a Windows Store app. If this happens, move to the desktop and follow the instructions in the displayed dialog box.

5 Click the [OK] button.

Related Topics

- ▶ [Enabling the AMS Function\(P. 103\)](#)
- ▶ [\[Confirmation of Print Restrictions\] Dialog Box\(P. 176\)](#)

Specifying the User Information to Be Used for AMS Authentication

You can set information for users printing from computers using AMS.

If the user's password changes or you want to change the user, reset the user information according to the following procedure.

1 Display the [AMS] sheet.

2 Click the [User Name/Password] button.

The [Setup User Names and Passwords for Authentication] dialog box is displayed.

3 In [Setup Method], select the method for setting the user information to use for authentication.

[Use the PC log-on information]	Use the information for the computer's log-on user.
[Setup authenticated user information]	In [User Information Used for Authentication], set the user name and password.

If you selected [Use the PC log-on information], proceed to step **6.(P. 108)**

NOTE

- [Setup Method] is enabled when you are logged on to the computer as a domain user in an environment using Active Directory authentication. Otherwise, [Setup authenticated user information] is selected.
- For information on setting user information, contact your device restriction administrator.

4 Specify [User Name] (sAMAccountName) and [Password], and select the location to authenticate the user information in [Authentication].

NOTE

- If you are using local device authentication, select [This Device] for [Authentication]. If you are using Active Directory authentication, enter the domain name (NetBIOS name).

5 If necessary, select [Save Password and Skip Authentication Dialog Box When Printing].

NOTE

- [Save Password and Skip Authentication Dialog Box When Printing] is only available when using local device authentication ([This Device] selected for [Setup Method]) and the device is set to allow passwords to be saved.
- If you select [Save Password and Skip Authentication Dialog Box When Printing], you can print without entering a password. However, it is recommended you set to enter a password each time printing is performed, for increased security.
- Depending on your environment, the message "The printer requires your attention. Go to the desktop to take care of it." may be displayed when printing from a Windows Store app. If this happens, move to the desktop and follow the instructions in the displayed dialog box.

6 Click the [OK] button.

Related Topics

- ▶ **Preparing to Print Using AMS(P. 105)**
- ▶ **[AMS] Sheet(P. 172)**
- ▶ **[Setup User Names and Passwords for Authentication] Dialog Box(P. 172)**
- ▶ **[Confirm Password for Authentication] Dialog Box(P. 175)**

Specifying the Print Output Destination Device Using AMS

You can specify a device IP address and/or host name as a print output destination using AMS.

If you want to change the IP address/host name of a device, or if you did not specify the IP address/host name of the device when installing the driver, specify it according to the following procedure.

NOTE

- If you want to change IP address/host name of the device used for printing, log on to the computer as a user with Windows administrator privileges.
- It may be necessary to specify the IP address/host name of the device again if your environment uses the "Auto Created Printer" function of XenApp.

1 Display the [AMS] sheet.

2 Click the [IP Address/Host Name] button.

The [Set IP Address/Host Name] dialog box is displayed.

3 Click the [Get IP Address/Host Name] button.

The IP address/host name is displayed in the [Device IP Address/Host Name] text box.

NOTE

- The IP address/host name of the device may not be able to be retrieved, depending on the type of printer driver and printer port. In this case, manually set the IP address/host name.
- In order to retrieve the IP address/host name of the device via the printer driver, it is necessary to use the installer of the printer driver to install the Canon Driver Information Assist Service to the print server in advance.

4 If the IP address/host name could not be retrieved, enter the IP address/host name of the device into the [Device IP Address/Host Name] text box manually.

5 Click the [OK] button.

Related Topics

- ▶ [Preparing to Print Using AMS\(P. 105\)](#)
- ▶ [\[AMS\] Sheet\(P. 172\)](#)
- ▶ [\[Set IP Address/Host Name\] Dialog Box\(P. 174\)](#)

Retrieving Print Restriction Information Applied When Using AMS

When printing using AMS, you need to retrieve print restriction information.

In the following cases, retrieve print restriction information again:

- When the print restriction information (role information) registered in the device is changed
- When the user information (user name/password) used for authentication is changed
- When the user's association with a role is changed
- When the IP address/host name of the device used for printing is changed

An error will occur when printing if the print restriction information in the device and driver do not match. Be aware that documents for which printing is only allowed once will be prohibited from printing again.

1 Display the [AMS] sheet.

2 Click the [Get Restriction Information] button.

If the [Confirm Password for Authentication] dialog box is displayed, enter the password for authentication.

NOTE

- If you are logged on to the computer as a user with Windows administrator privileges and the IP address/host name of the device to use for printing is not specified, the [Set IP Address/Host Name] dialog box is displayed. Specify the device to use for printing.
- If you are logged on to the computer as a user without Windows administrator privileges and the IP address/host name of the device to use for printing is not specified, an error message is displayed. Log on to the computer again as a user with Windows administrator privileges, and specify the device to use for printing.

3 Click the [OK] button.

Related Topics

- ▶ [Preparing to Print Using AMS\(P. 105\)](#)
- ▶ [\[AMS\] Sheet\(P. 172\)](#)
- ▶ [\[Confirm Password for Authentication\] Dialog Box\(P. 175\)](#)
- ▶ [\[Set IP Address/Host Name\] Dialog Box\(P. 174\)](#)

Configuring an Authentication Server to Be Used in AMS User Authentication

When applying AMS with a server authentication method, set the authentication server to be used for user authentication.

- 1** Display the [AMS] sheet.
- 2** Click the [Setup Authentication Server] button.
- 3** Select [Use an Authentication Server in Place of Individual Device Authentication].
- 4** In [Record Name], enter the record name of the server registered in the DNS.
- 5** Click the [OK] button.

Related Topics

- ◉ [AMS] Sheet(P. 172)
- ◉ [Setup Authentication Server] Dialog Box(P. 175)

Using Encrypted Secure Print

- ▶ **Enabling the Encrypted Secure Print Function(P. 113)**
- ▶ **Enhancing the Security of the Encrypted Secure Print Function(P. 116)**
- ▶ **Printing Using the Encrypted Secure Print Function(P. 118)**

Enabling the Encrypted Secure Print Function

This explains the procedure for enabling the Encrypted Secure Print function.

Prerequisites

- When starting the computer, log on as a member of Administrators.

Procedures

1 Display the printer properties screen.

If displaying from [ Settings] in the Start menu

- (1) Display [Bluetooth & devices] (or [Devices]).
- (2) In [Printers & scanners], display the management screen for the device to set.
To display the management screen, click the device or click [Manage] for the corresponding device.
- (3) Click [Printer properties] for the device to set.

If displaying from [Control Panel]

- (1) Display [Devices and Printers].
- (2) From the printer list, right-click the device to be set → select [Printer properties] from the displayed menu.

2 Check whether the [Encrypted-P] sheet is displayed on the printer properties screen.

The [Encrypted-P] sheet may be displayed automatically because the device information was retrieved when the driver was installed. In this case, proceed to step 7.(P. 115)

3 Display the [Device Settings] sheet → click [Details].

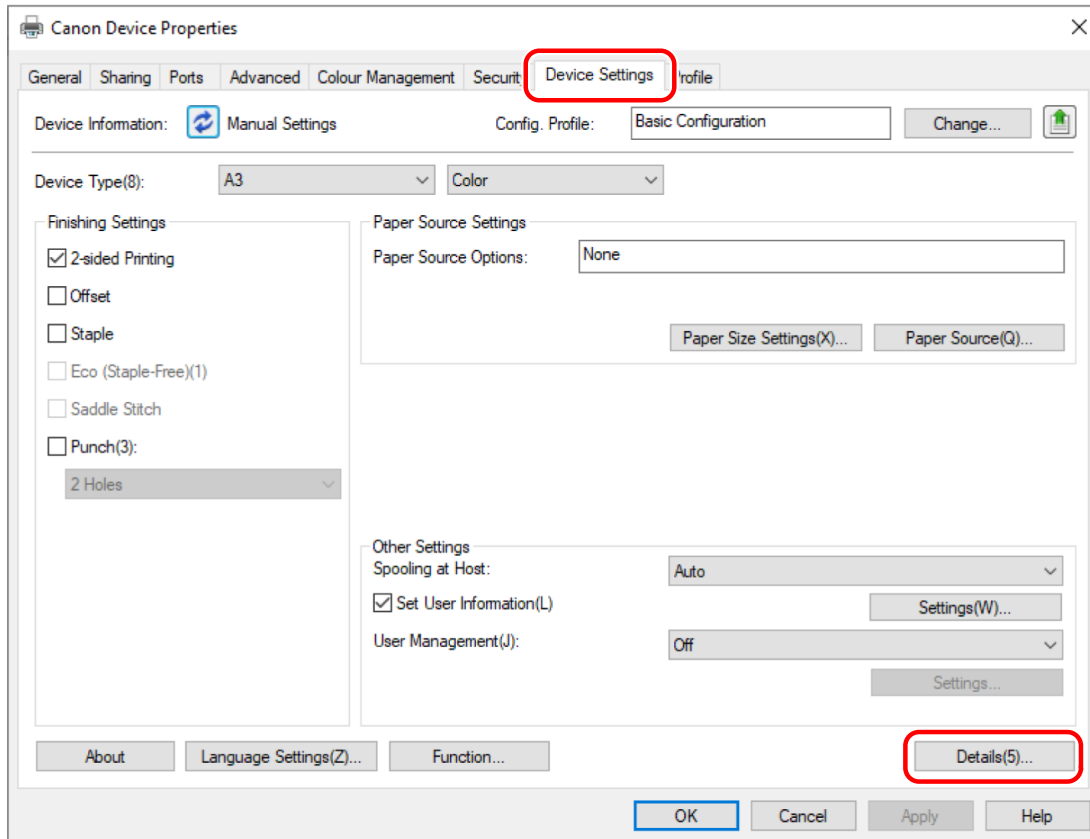

- 4** In the displayed dialog box, display the [Other Settings] sheet → select [Encrypted Secure Print] > [Enabled] → click [OK].

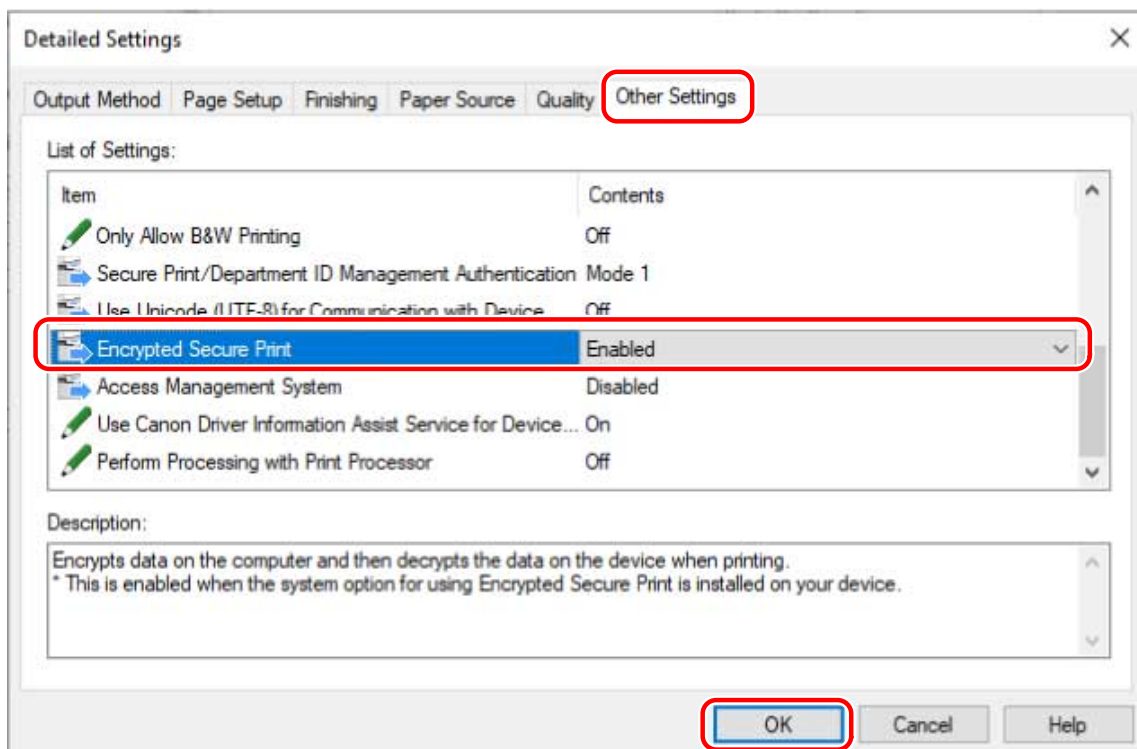

- 5** Click [OK] on the printer properties screen to close the screen → display the printer properties screen again.

For information on displaying the printer properties screen, see step 1.(P. 113)

6 Display the [Encrypted-P] sheet.

7 Select [Use Encrypted Secure Print] → click [OK] or [Apply].

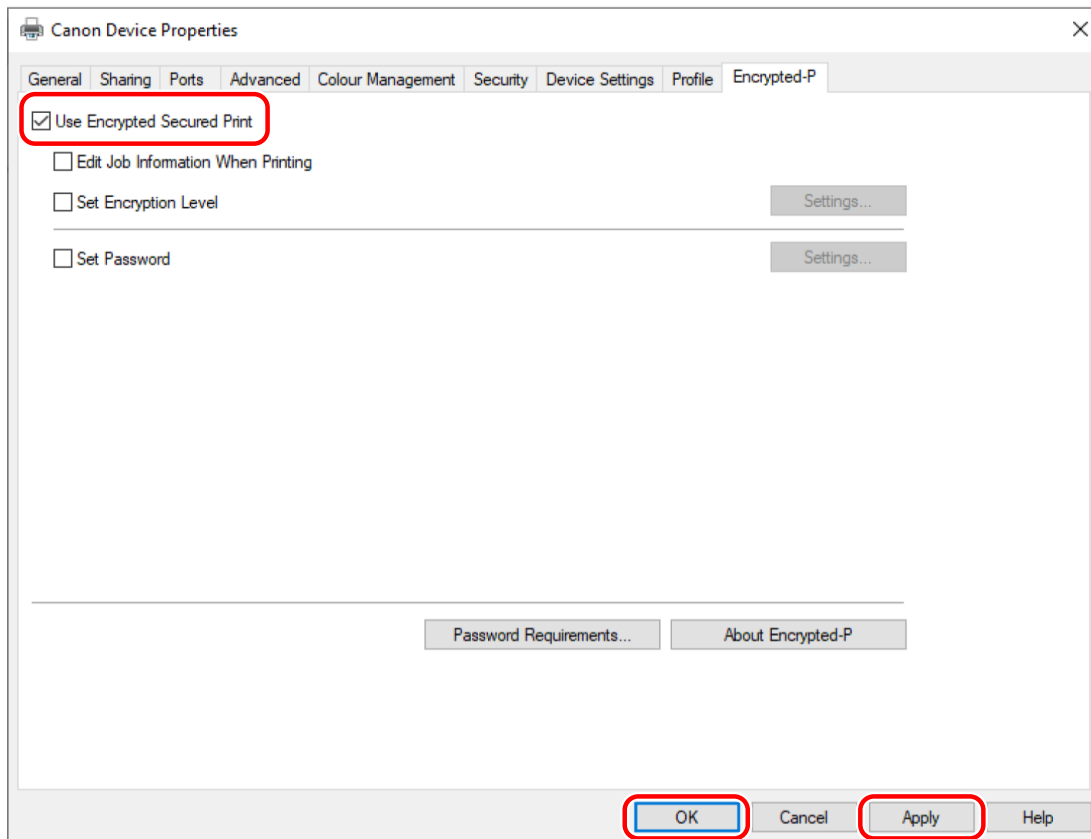

Related Topics

- ▶ [Encrypted-P] Sheet(P. 178)

Enhancing the Security of the Encrypted Secure Print Function

In order to enhance security, you can set the level of encryption strength and the number of characters that can be used for passwords.

Setting a default password saves time and effort for entering the password when printing.



NOTE

- By enabling the Encrypted Secure Print function, it can be used for printing with the default settings. Configure the settings in the following procedure as required.
- You can also enter a password in the dialog box displayed when printing each time instead of setting a default password.

Prerequisites

- **Enabling the Encrypted Secure Print Function(P. 113)**
- When starting the computer, log on as a member of Administrators.
Administrator privileges are required when changing settings other than [Set Password].

Procedures

1 Display the [Encrypted-P] sheet.

2 Configure settings related to enhanced security as required.

Editing the document name and user name displayed on the device

Select [Edit Job Information When Printing].

The document name and user name are displayed on the device when printing. Use this function to edit the job information if you do not want to display the names as they are.

Setting the encryption level

(1) Select [Set Encryption Level] → click [Settings].

(2) In the displayed dialog box, select the encryption level to set → click [OK].

Setting password requirements

You can set a minimum number of characters required for passwords and whether both letters and numbers can be included.

(1) Click [Password Requirements].

(2) In the displayed dialog box, select [Set Password Requirements] → set the password requirements → click [OK].

3 Select [Set Password] → click [Settings].

In the displayed dialog box, enter the default password → click [OK].

When [Do Not Display Password Dialog When Printing] is enabled, you can perform printing using the default password. In this case, the [Settings of Encrypted Secure Print Password] dialog box is not displayed when printing.

Related Topics

- ▶ **Printing Using the Encrypted Secure Print Function(P. 118)**
- ▶ **[Encrypted-P] Sheet(P. 178)**
- ▶ **[Encryption Level Settings] Dialog Box(P. 178)**
- ▶ **[Password Requirements] Dialog Box(P. 179)**
- ▶ **[Password Settings] Dialog Box(P. 179)**

Printing Using the Encrypted Secure Print Function

This explains the basic procedure for printing using the Encrypted Secure Print function.

Prerequisites

- **Enabling the Encrypted Secure Print Function(P. 113)**
Also configure settings for enhanced security as required.
- The same driver version is used in all client computers
In environments shared with a device that has Encrypted Secure Print enabled, make sure that the same driver version is installed in all client computers.

Procedures

1 Select the print menu of the application.

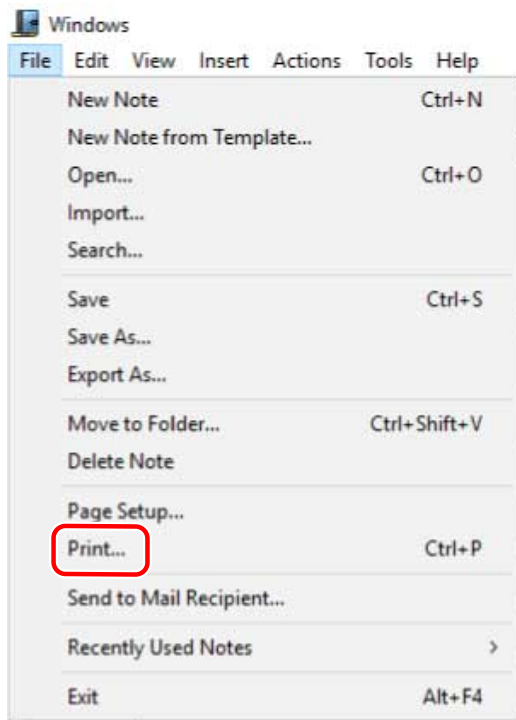

2 On the print screen, select the device you are using → click [Print] or [OK].

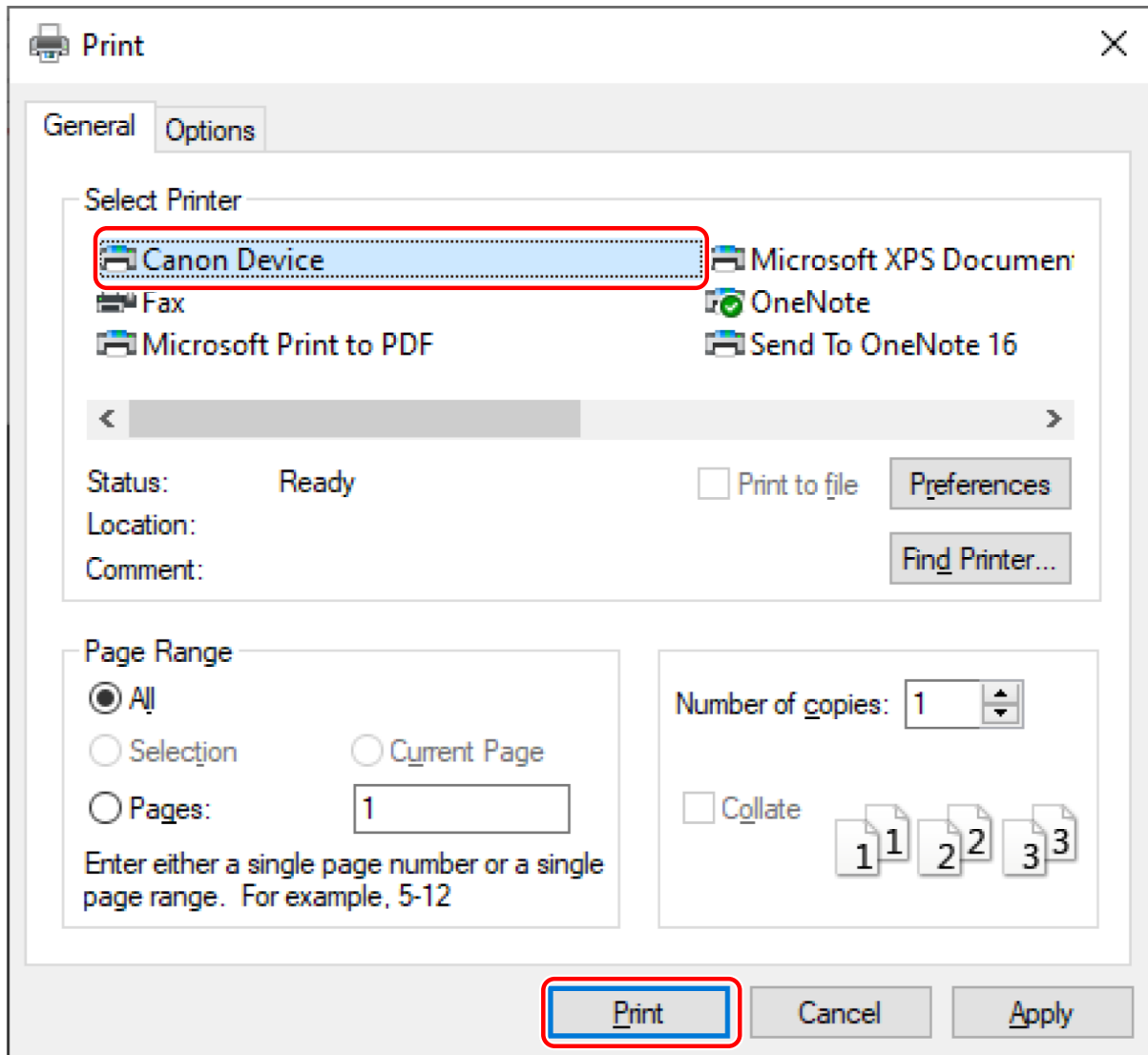

3 If the [Edit Job Information] dialog box is displayed, enter the name of the document to print and the name of the user executing printing → click [OK].

The number and type of characters that can be used differs according to the device. Enter the name within the range displayed next to [Document Name] or [User Name].

4 If the [Settings of Encrypted Secure Print Password] dialog box is displayed, enter the password → click [OK].

Enter the characters that can be used for the password within the maximum range.

When password requirements are set, enter a password that meets the requirements.

If you do not enter the password, the print data will not be encrypted.

 **NOTE**

- When the [Edit Job Information] dialog box and [Settings of Encrypted Secure Print Password] dialog box are set to be displayed when printing, a message prompting you to move to the desktop may be displayed if you print from a Windows store app. In this case, move to the desktop and perform the operations indicated in the displayed message.
- If you are printing a number of sheets in Microsoft Excel, multiple [Edit Job Information] dialog boxes or [Settings of Encrypted Secure Print Password] dialog boxes may be simultaneously displayed.

Related Topics

- ▶ **Enhancing the Security of the Encrypted Secure Print Function(P. 116)**
- ▶ **[Edit Job Information] Dialog Box(P. 179)**
- ▶ **[Settings of Encrypted Secure Print Password] Dialog Box(P. 179)**
- ▶ **Cannot execute the Encrypted Secure Print function(P. 202)**
- ▶ **Cannot print with the specified method using Encrypted Secure Print(P. 203)**

Settings List

Settings List	122
Common Settings for All Sheets	123
[Basic Settings] Sheet	126
[Page Setup] Sheet	129
[Finishing] Sheet	132
[Paper Source] Sheet	142
[Quality] Sheet (UFR II/LIPSLX/LIPS4/PCL6)	145
[Quality] Sheet (PS3)	152
[Color] Sheet (PS3)	157
[Exceptional Settings] Sheet (PS3)	161
[Device Settings] Sheet	165
[Profile] Sheet	170
[AMS] Sheet	172
[Encrypted-P] Sheet	178
Canon PageComposer	181

Settings List

- ▶ **Common Settings for All Sheets(P. 123)**
- ▶ **[Basic Settings] Sheet(P. 126)**
- ▶ **[Page Setup] Sheet(P. 129)**
- ▶ **[Finishing] Sheet(P. 132)**
- ▶ **[Paper Source] Sheet(P. 142)**
- ▶ **[Quality] Sheet (UFR II/LIPSLX/LIPS4/PCL6)(P. 145)**
- ▶ **[Quality] Sheet (PS3)(P. 152)**
- ▶ **[Color] Sheet (PS3)(P. 157)**
- ▶ **[Exceptional Settings] Sheet (PS3)(P. 161)**
- ▶ **[Device Settings] Sheet(P. 165)**
- ▶ **[Profile] Sheet(P. 170)**
- ▶ **[AMS] Sheet(P. 172)**
- ▶ **[Encrypted-P] Sheet(P. 178)**
- ▶ **Canon PageComposer(P. 181)**

Common Settings for All Sheets

This section explains the common settings for each sheet in the print settings screen.

Depending on the driver you are using, you may not be able to set some of the functions described herein.

[Profile]

Applies registered settings as selecting a profile. You can register frequently used settings as a profile.

[Add] > [Add Profile] Dialog Box

Registers the current print settings as a profile. Set [Name] and [Icon]. Enter a comment in [Comment] if required. If you want to check the current settings in a list, click [View Settings].

[Edit] > [Edit Profile] Dialog Box

Enables you to edit, import, and export profiles.

[Profile List]

Displays registered profiles as a list. You can change the order by selecting a profile and clicking []

(Move Up) or [] (Move Down).

[View Settings]

Displays the content of the selected profile as a list.

[Delete]

Deletes the selected profile.

[Name]/[Icon]/[Comment]

Displays the name, icon, and comment of the selected profile. You can edit the name, icon, and comment of user-registered profiles.

[Import]

Imports a profile saved as a "*.cfg" file and adds it to [Profile List].

[Export]

Exports the profile selected in [Profile List] and saves it as a "*.cfg" file.

[Apply Settings from Application]

Gives priority to the following settings from the application over the driver settings.

[Page Size] / [Copies] / [Orientation] / [1-sided/2-sided/Booklet Printing] / [Paper Source] / [Resolution]



NOTE

- Profiles with a red dot (●) next to them are pre-registered profiles and cannot be edited or deleted.
- If the language of the operating systems used by the print server and client computers in a shared printer environment differ, "<Change>" may be displayed before a name even when the profile settings on a client computer have not been changed.

[Output Method]

Switches the method for outputting print data. You can save the data to the device, move a print job in the print queue ahead of other jobs and print it, etc.

[Print]

Performs normal printing.

[Hold]

Saves print data in a hold queue (temporary storage area) in the device. You can change the print order or settings of the stored data from the control panel of the device or the Remote UI.

[Details] > [Hold Details] Dialog Box

Enables you to set the name of data.

[Secure Print]

Attaches a PIN to print data and saves it in the device. The saved data can be printed by entering the PIN in the control panel of the device.

[Details] > [Secure Print Details] Dialog Box

Enables you to set the user name and PIN.

[Confirm PIN] Dialog Box

Enables you to confirm or set a name for the print data, user name, and PIN when printing.

[Store]

Stores the print data to a box in the device. You can change the settings of or combine the stored data with other stored data from the control panel of the device or the Remote UI.

[Details] > [Store Details] Dialog Box

Enables you to set the storage destination.

[Interrupt Print]

Interrupts printing being processed at the device and prints the data to which the [Interrupt Print] setting has been applied ahead of all other print jobs.

[Promote Print]

Gives print data priority over other print data that is waiting to be printed by the device.

[Scheduled Print]

Starts printing at the specified time.

Synchronize the times on the computer and device you are using. If they are not synchronized, printing will start at the time indicated at the device.

[Details] > [Scheduled Print Details] Dialog Box

Sets the time to start printing.

[Edit and Preview]

Enables you to combine multiple files into one for printing. You can also preview the print data for confirmation and change the print settings.

If you always want to output with [Edit and Preview], in the print settings screen displayed in the procedure for changing the default settings of the driver, select [Edit and Preview], then change [Lock] to enable.

This function is useful for restricting the output methods of clients in a shared printer environment.

[Details] > [Edit and Preview Details] Dialog Box

Enables you to set the output method after Edit and Preview.

[Settings Preview]

Displays the current print settings in a preview. You can set basic print functions by clicking on the preview.

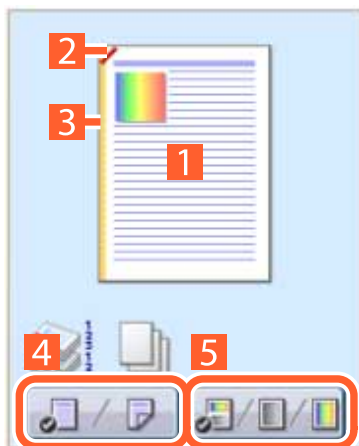
**1 N on 1 printing**

Arranges N pages of print data on each sheet of paper.

2 Stapling

Click where you want the page to be stapled.

3 Binding location

Click the edge of the page where you want to set the binding location.

4 Switch between 1-sided printing and 2-sided printing**5 Switch between color and black and white printing (color printers only)****[View Settings] > [View Settings] Dialog Box**

Displays the current driver settings in a list.

[Language Settings] > [Language Settings] Dialog Box

Enables you to switch the display language.

Related Topics

- ▶ **About the [Edit and Preview] Function(P. 54)**
- ▶ **Printing Files Together(P. 55)**
- ▶ **Attaching Encryption When Printing(P. 27)**
- ▶ **Putting Print Jobs on Hold(P. 28)**
- ▶ **Storing Print Data(P. 29)**
- ▶ **Priority Printing(P. 30)**
- ▶ **Registering Favorite Settings(P. 67)**
- ▶ **Editing the Favorite Settings List(P. 68)**
- ▶ **Changing the Default Settings(P. 31)**

[Basic Settings] Sheet

You can set basic print functions.

Depending on the driver you are using, you may not be able to set some of the functions described herein.

[Page Size]

Displays the paper size of the print data prepared in the application.

[Output Size]

Specifies the actual paper size to be printed on. If you select a size that differs from [Page Size], the print data is enlarged or reduced to fit the set page size when printing.

For the LIPS4 driver, paper sizes up to 487.7 mm (19.20 inches) in height can be selected. To select a paper size that exceeds this height, use a different type of driver, such as the UFR II/LIPSLX/PS3 driver.

[Envelope Print Details] > [Envelope Print Details] Dialog Box

Follow the wizard to configure the settings required for printing on envelopes.

You can configure the following settings that are found on separate sheets.

[Output Size]/[Paper Source]/[Paper Type]/[Orientation]/[Rotate Print Data 180 Degrees]

[Copies]

Specifies the number of copies to be printed.

[Orientation]

Specifies the orientation of print data.

[Page Layout]

Specifies how many pages to print on each sheet of paper.

[Manual Scaling]

Specifies an enlargement or reduction ratio for printing.

[Use 1 on 1 for Single-Page Data]

When printing multiple pages on each sheet, prints single page data over one sheet.

[1-sided/2-sided/Booklet Printing]

Specifies a method for outputting print data.

[Booklet] > [Detailed Settings for Booklet] Dialog Box

Enables you to set detailed settings such as gutter, displacement correction for booklet printing.

[Booklet Printing Process]

Switches the settings to be applied. Select [With Driver Settings] when using driver functions such as dividing the document into sets, gutter settings, etc. Select [With Device Settings] when using the creep (displacement) correction function.

[Booklet Printing Method]

Switches the booklet printing method. When creating a booklet in multiple sets, select [Divide into Sets] and then specify how many sheets are in each set in [Sheets per Set].

[Book Opening]

Specifies the direction the booklet opens.

[Specify Booklet Gutter]

Specifies the gutter width.

[Use Creep (Displacement) Correction]

Corrects displacement between outer and inner pages that occurs during booklet printing. Select a correction method from [Displacement Correction Method]. When specifying the displacement width of the print area between the outermost page and centermost page, select [Manual Correction] and specify a correction amount in [Correction Width].

[Saddle Press]

Presses the pages so that they are flattened when using saddle stitching with booklet printing. You can adjust the strength of the press by setting [Saddle Press Adjustment].

[Saddle Stitch Setting]

Prints a booklet folded in half and stapled in the middle. When trimming to align the edges of the pages, select [Fold + Saddle Stitch + Trim]/[Fold + Trim], and then set [Trim Settings] in the [Finishing] sheet.

[Binding Location]

Sets the edge of the paper to bind.

If you change [Orientation] in the [Basic Settings]/[Page Setup] sheet, [Binding Location] is changed to the left or top. The long edge/short edge positional relationship is maintained.

[Gutter] > [Gutter Settings] Dialog Box

Enables you to set the gutter width.

[Staple/Collate/Group]

Sets the order of pages and whether to staple the pages when printing multiple copies.



Collate

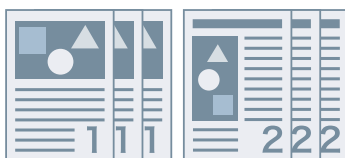

Group

Staple
Eco (Staple-Free)**[Off]**

Follows the application setting.

[Collate]

Outputs the specified number of copies in page order.

[Group]

Outputs the specified number of copies with all pages having the same page number grouped together.

[Staple + Collate]/[Eco (Staple-Free) + Collate]/[Staple + Group]/[Eco (Staple-Free) + Group]

Outputs the pages in the order specified for [Collate] or [Group] stapled together. "Eco (Staple-Free)" is a method of fixing pages together without using staples, and can be used when a finisher that supports binding without staples is installed.

[Staple Position] > [Staple Position] Dialog Box

Enables you to set the position of the staple(s).

[Color Mode]

Switches between printing in color or in black-and-white. To detect automatically whether each page should be printed in color or in black-and-white, select [Auto [Color/B&W]].

[Number of Colors Settings] > [Number of Colors Settings] Dialog Box

Enables you to switch between full color printing and two color printing.

If you select [Two Colors], set which color to use with black from [Color to Use with Black]. The parts of the print data for which there is no color data are printed in shades of black and white, while the parts for which there is color data are printed in shades of the specified color.

[Restore Defaults]

Returns all the print settings of the driver to their default values.

Related Topics

- ▶ **Common Settings for All Sheets(P. 123)**
- ▶ **Scaling(P. 19)**
- ▶ **Poster Printing(P. 21)**
- ▶ **Booklet Printing(P. 36)**
- ▶ **Saddle Stitched Booklet Printing(P. 39)**
- ▶ **Driver settings cannot be set(P. 186)**
- ▶ **Print results are unsatisfactory(P. 187)**

[Page Setup] Sheet

You can set the page size, print orientation, layout options, etc.

Depending on the driver you are using, you may not be able to set some of the functions described herein.

[Page Size]

Displays the paper size of the print data prepared in the application.

[Output Size]

Specifies the actual paper size to be printed on. If you select a size that differs from [Page Size], the print data is enlarged or reduced to fit the set page size when printing.

For the LIPS4 driver, paper sizes up to 487.7 mm (19.20 inches) in height can be selected. To select a paper size that exceeds this height, use a different type of driver, such as the UFR II/LIPSLX/PS3 driver.

[Envelope Print Details] > [Envelope Print Details] Dialog Box

Follow the wizard to configure the settings required for printing on envelopes.

You can configure the following settings that are found on separate sheets.

[Output Size]/[Paper Source]/[Paper Type]/[Orientation]/[Rotate Print Data 180 Degrees]

[Copies]

Specifies the number of copies to be printed.

[Orientation]

Specifies the orientation of print data.

[Page Layout]

Specifies how many pages to print on each sheet of paper.

[Poster Details] > [Poster Details] Dialog Box

Enables you to set detailed settings when printing a poster.

The poster printing function enlarges the print data of one page and prints it over multiple sheets of paper. When the output sheets are joined together, they form a large print like a poster.

[Print Margin Borders]

Prints borders with other sheets as a guide to paste sheets together.

[Set Margins for Cutting/Pasting]

Sets margins for cutting or pasting. Select a width from [Margin Width]. When printing marks indicating the cutout or margin section(s), select [Print Marks for Alignment].

[Pages to Print]

Specifies the page(s) to print.

[Page Order]

Specifies the page order to print.

[Manual Scaling]

Specifies an enlargement or reduction ratio for printing.

[Use 1 on 1 for Single-Page Data]

When printing multiple pages on each sheet, prints single page data over one sheet.

[Watermark]

Superimposes and prints semi-transparent characters such as [TOP SECRET] or [DRAFT] over print data.

[Edit Watermark] > [Edit Watermark] Dialog Box

Enables you to create and add a new watermark.

[Watermark List]

Displays registered watermarks as a list. When selecting a watermark, a preview is displayed to the left.

[Add]

Adds a new watermark to [Watermark List] as [Untitled]. You can set the name of the watermark in [Name] and its settings in the [Attributes], [Alignment], and [Print Style] sheets.

[Delete]

Deletes the selected watermark.

[Name]

Displays the name of the watermark selected in [Watermark List]. When adding a new watermark, enter the name of the watermark.

[Attributes] Sheet

Specifies the settings relating to the text in a watermark.

[Alignment] Sheet

[Position] specifies the position of the watermark as coordinates relative to the center (0) of the document. [Tilt] sets the angle of the watermark.

[Print Style] Sheet

[Watermark Border] sets whether a frame is printed around the text. [Watermark Position] sets the overlap position with respect to the print data. When printing the watermark on only the first page, select [Print on First Page Only].

[Custom Paper Size] > [Custom Paper Size Settings] Dialog Box

Enables you to register a desired paper size and use it for printing.

Papers with a red dot (●) next to them are standard paper sizes and cannot be edited or deleted.

If [Use Some Custom Paper Sizes as Regional Paper Sizes] is enabled, the custom paper size selected in [Output Size] is handled as a regional paper size if it is the same size as a regional paper size.

A regional paper size enables you to use print functions that cannot be specified with regular custom paper.

The paper types and sizes handled as regional paper with this driver are indicated below.

Settings List

Paper Name	Width x Height (Unit : mm)	Width x Height (Unit : inch)
Oficio	216.0 x 317.0	8.50 x 12.50
Oficio (Argentina)	220.0 x 340.0	8.66 x 13.39
Oficio (Brazil)	216.0 x 355.0	8.50 x 13.98
Oficio (Ecuador)	220.0 x 320.0	8.66 x 12.60
Oficio (Mexico)	216.0 x 341.0	8.50 x 13.43
Letter (Argentina)	220.0 x 280.0	8.66 x 11.02
Letter (Government)	203.0 x 267.0	8.00 x 10.50
Legal (Government)	203.0 x 330.0	8.00 x 13.00
Legal (India)	215.0 x 345.0	8.46 x 13.58
Legal (Korea)	190.0 x 268.0	7.48 x 10.55
German Legal Fanfold	216.0 x 330.0	8.50 x 13.00
Foolscap/Folio	216.0 x 330.0	8.50 x 13.00
Foolscap (Australia)	206.0 x 337.0	8.11 x 13.27
F4A	216.0 x 343.0	8.50 x 13.50
16K	195.0 x 270.0	7.68 x 10.63
8K	270.0 x 390.0	10.63 x 15.35

The available regional paper types depend on your device.

[Page Options] > [Page Options] Dialog Box

Specifies layout options such as borders, date, page numbers, etc. and overlay printing settings.

This also enables a document name, computer name, and print time to be inserted. The display format for dates and times depends on the settings of the operating system.

[Format Settings] > [Format Settings] Dialog Box

Enables you to configure font settings when printing the date, user name, and/or page numbers.

[Restore Defaults]

Returns all the settings to their default values.

Related Topics

- ▶ **Common Settings for All Sheets(P. 123)**
- ▶ **Scaling(P. 19)**
- ▶ **Watermark Printing(P. 20)**
- ▶ **Poster Printing(P. 21)**
- ▶ **Printing Over a Fixed Form(P. 25)**
- ▶ **Registering Custom Paper Sizes(P. 45)**
- ▶ **Driver settings cannot be set(P. 186)**
- ▶ **Print results are unsatisfactory(P. 187)**
- ▶ **Overlay printing will not execute(P. 191)**

[Finishing] Sheet

You can configure settings relating to layout printing and finishing such as sorting, collating, stapling, etc. Depending on the driver you are using, you may not be able to set some of the functions described herein.

[Print Style]

Specifies a method for outputting print data. According to what you select for [Print Style], the displayed settings change as follows.

- ▶ When [1-sided Printing] or [2-sided Printing] is selected(P. 132)
- ▶ When [Booklet Printing] is selected(P. 134)
- ▶ When [Perfect Binding [1-sided]] or [Perfect Binding [2-sided]] is selected(P. 135)

When [1-sided Printing] or [2-sided Printing] is selected

[Print with Mixed Paper Sizes/Orientations]/[Print in Different Orientations]

Enables you to print data that combines different page sizes and orientations.

[Details] > [Detailed Settings] Dialog Box

Enables you to set the combination of page sizes and alignment method when printing data that combines different page sizes and orientations.

[Crease Settings] > [Crease Settings] Dialog Box

Makes a crease in printed paper so that it is easier to fold. You can also select the number of creases.

[Binding Location]

Sets the edge of the paper to bind.

If you change [Orientation] in the [Basic Settings]/[Page Setup] sheet, [Binding Location] is changed to the left or top. The long edge/short edge positional relationship is maintained.

[Gutter] > [Gutter Settings] Dialog Box

Enables you to set the gutter width.

[Finishing]

Sets the order of pages and whether to staple the pages when printing multiple copies.



Collate



Group



Offset

Settings List



Rotate

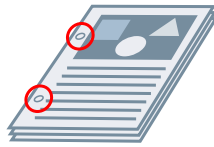

Hole Punch



Staple
Eco (Staple-Free)

[Off]

Follows the application setting.

[Collate]

Outputs the specified number of copies in page order.

[Group]

Outputs the specified number of copies with all pages having the same page number grouped together.

[Staple + Collate]/[Eco (Staple-Free) + Collate]/[Staple + Group]/[Eco (Staple-Free) + Group]

Outputs the pages in the order specified for [Collate] or [Group] stapled together. "Eco (Staple-Free)" is a method of fixing pages together without using staples, and can be used when a finisher that supports binding without staples is installed.

[Staple Position] > [Staple Position] Dialog Box

Enables you to set the position of the staple(s).

[Offset]

Outputs each copy separately. You can set how many copies are offset in [Number of Copies for Offset].

[Rotate]

Outputs each copy at a 90 degree angle relative to the copy before and after it.

[Hole Punch]

Outputs the document with multiple holes for ring binding.

[Fold]

Folds pages into one of a variety of forms when outputting them.

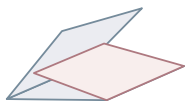

C-fold (Saddle C-fold)



Z-fold

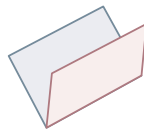

Half Fold (Saddle
Fold)

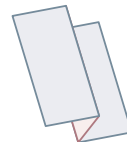

Accordion Z-fold

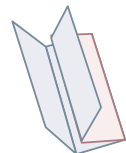

Double Parallel Fold

[Fold Details] > [Fold Details] Dialog Box

Enables you to set the fold direction. For saddle folding, you can specify the number of sheets of paper to fold together.

[C-fold Settings]/[Saddle Fold Settings]/[Saddle C-fold Settings]/[Half Fold Settings]/[Accordion Z-fold Settings]/[Double Parallel Fold Settings]

Select the type of folding.

[Sheets per Set]

For saddle folding, specify the number of sheets of paper to fold together.

[Perforation]

Perforates the printed paper. You can also select the number of perforations.

[Paper Output]

Specifies a printed paper output destination.

[Stack Details] > [Stack Details] Dialog Box

Enables you to set the number of copies to output and the automatic ejection timing.

When [Booklet Printing] is selected

[Booklet] > [Detailed Settings for Booklet] Dialog Box

Enables you to set detailed settings for booklet printing such as gutters and displacement correction.

[Booklet Printing Process]

Switches the settings to be applied. Select [With Driver Settings] when using driver functions such as dividing the document into sets, gutter settings, etc. Select [With Device Settings] when using the creep (displacement) correction function.

[Booklet Printing Method]

Switches the booklet printing method. When creating a booklet in multiple sets, select [Divide into Sets] and then specify how many sheets are in each set in [Sheets per Set].

[Book Opening]

Specifies the direction in which the booklet opens.

[Specify Booklet Gutter]

Specifies the gutter width.

[Use Creep (Displacement) Correction]

Corrects displacement between outer and inner pages that occurs during booklet printing. Select a correction method from [Displacement Correction Method]. When specifying the displacement width of the print area between the outermost page and centermost page, select [Manual Correction] and specify a correction amount in [Correction Width].

[Saddle Press]

Presses the pages so that they are flattened when using saddle stitching with booklet printing. You can adjust the strength of the press by setting [Saddle Press Adjustment].

[Saddle Stitch Setting]

Prints a booklet folded in half and stapled in the middle. When trimming to align the edges of the pages, select [Fold + Saddle Stitch + Trim], and then set [Trim Settings] in the [Finishing] sheet.

[Crease Settings] > [Crease Settings] Dialog Box

Makes a crease in printed paper so that it is easier to fold. You can also select the number of creases.

[Trim Settings]

Switches the trim width adjustment method.

[Apply Device Settings]

Follows the device setting.

[Specify Trim Width of Fore]

Trims the opening edges only. You can specify a desired trimming width.

[Specify Trim Width of Fore and Top/Bottom]

Trims the opening, top, and bottom edges. You can specify a desired trimming width.

[Specify Finishing Width]

Trims by automatically adjusting to the specified finishing width.

[Specify Finishing Width and Height]

Trims by automatically adjusting to the specified finishing width and height.

[Offset]

Outputs each copy separately. You can set how many copies are offset in [Number of Copies for Offset].

When [Perfect Binding [1-sided]] or [Perfect Binding [2-sided]] is selected

[Setting List]

Displays the current settings for perfect printing in a list.

[Perfect Binding Settings] > [Perfect Binding Settings] Dialog Box

Enables you to set the paper size, covers, and finishing size for perfect binding.

[Book Opening]

Specifies the direction the booklet opens.

[Perfect Bound Cover Settings]

Specifies the paper size and paper source of covers. When printing on covers, select [Lay out Data the Same Size as Cover] for [Print Style], and specify [Front Cover Print Side] and [Back Cover Print Side].

[Content Page Size]

Specifies the paper size for printing the content pages.

[Specify Finishing by]

Switches the adjustment method. When specifying the trim widths, select [Trim Width] and specify [Trim Width of Fore] and [Trim Width of Top/Bottom].

[Finishing Size]

Specifies the final finished size for perfect binding.

[Finishing Adjustment] > [Finishing Adjustment] Dialog Box

Enables you to adjust the printing position for content pages and covers, and the trimming angle and locations.

[Advanced Settings] > [Advanced Settings] Dialog Box

Enables you to set detailed finishing settings. Select the setting item you want to specify in [List of Settings], and select a setting from the drop-down list.

[Display in Printer as]

Specifies a name to be displayed in the device control panel while your print job is being printed. This is useful if multiple users share a printer.

[Print Banner Page]

Prints a banner page showing the user's login name, the time the print job was printed, and the document file name.

If any of the following are set, you cannot print a banner page.

- Secure Print / Store / Hold / Use Overlay Printing / Perfect Binding / Saddle Stitch / C-fold
- [Collate [By Device]] > [Off] and [Driver Collating] > [Pattern 1] in [Device Settings] sheet > [Details] > [Finishing]

[Details] > [Banner Page Print Details] Dialog Box

Enables you to set the paper source or paper type of a banner page.

[Job Note]

Displays a comment for the print data on the control panel of the device or in the Remote UI.

[Details] > [Job Note Details] Dialog Box

Enables you to enter a comment for the print data.

[Document Name Settings (Except for Store and Hold)]

Sets the document name displayed on the control panel of the device and in the Remote UI.

This function is only enabled when printing with an output method other than [Store] or [Hold] specified.

[Details] > [Document Name Setting Details] Dialog Box

Enables you to enter the default value for the document name. If a default value is not specified, the file name of the printed data is used as the document name.

[Expand Print Region and Print]

Expands the print area when printing.

Some data may be cropped around the edge of the paper, depending on the print data and environment.

[Details] > [Print Region Details] Dialog Box

Enables you to adjust margins.

[Detect Paper Size in Tray]

Checks the print data and paper size in the paper source tray, and displays a message on the control panel of the device if they do not match. This function is useful if you want to continue printing with a different paper size.

[Set Margin to 1/6 Inches]

Prints with a 1/6 inch margin on the top, bottom, left, and right edges of the page.

[Rotate Print Data 180 Degrees]

This function is useful when you want to print on tab paper, envelopes, etc. that need to be fed in a specific direction.

[Always Rasterize at Host]

Sets whether print data is always converted into raster (bitmap) format at the host (computer).

If the printed result is different from the image displayed in the application you are using, retry printing with [On] selected. The printed result may be improved, however it takes longer to process the data from the application.

[Black and White Bitmap Processing in Auto Color Mode]

When printing with both of the following set, enables you to select the method for processing the data when it is rasterized.

- [Color Mode] : [Auto [Color/B&W]]
- [Advanced Settings] dialog box > [Always Rasterize at Host] : [On]

The printing speed and precision of data detected as black-and-white can be switched, according to the selected processing method.

Details on the target for color detection by mode and the processing method for data detected as black-and-white are indicated below.

	Target for color detection	Output image for black-and-white data	Compression method for black-and-white data
[Mode 1]	Text/Graphics/Indexed image	24 bit RGB	JPEG
[Mode 2]	Text/Graphics/Indexed image	8 bit gray	SLICV/Packbits/RAW
[Mode 3]	Text/Graphics/All images	8 bit gray	SLICV/Packbits/RAW

[Line Refinement]

Thickens thin lines when printing. This function is useful when printing small text and barcodes. This setting may be disabled when the resolution is set to 600 dpi.

[Skip Blank Pages Mode]

Enables you to skip the output of blank pages that contain no print data.

When using this function, set the skip blank pages function also on the device side before printing. For information about how to operate the device, refer to the manual of the device.

Even if this function is set, blank pages are output when printing pages that includes data such as blank text and white objects.

[Auto 1]

Skips blank pages.

However, blank pages are output when the following functions are set to ensure that the page layout is not lost.

2-sided Printing/Poster Printing/Booklet Printing/Perfect Binding [1-sided]/Perfect Binding [2-sided]/Transparency Cover Sheets using the PageComposer function (when not printing on the inserted sheets)/Edit and Preview

[Auto 2]

Skips blank pages.

However, blank pages are output when the following functions are set to ensure that the page layout is not lost.

Poster Printing/Booklet Printing/Perfect Binding [1-sided]/Perfect Binding [2-sided]/Transparency Cover Sheets using the PageComposer function (when not printing on the inserted sheets)/Edit and Preview

[Off]

Outputs blank pages.

An example of performing two-sided printing with [Auto 2] specified for [Skip Blank Pages Mode] for an original with a blank second page is indicated below.

The blank second page is not output and the third page of the original is printed on the reverse side of the first printed sheet.

Original



Print result

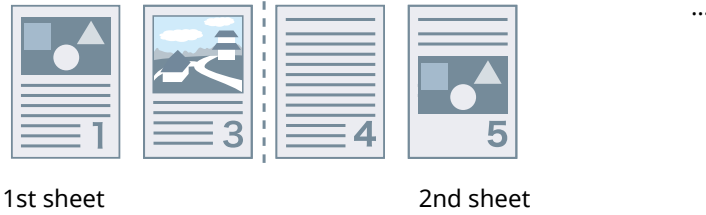

[Face Up/Face Down]

Enables you to set whether a document will be output face up or face down.

[Printer Default]

Uses the device setting.

[Face Down [Normal Output Order]]

For one-sided printing, outputs the document with the printed surface face down in order starting from the first page.

For two-sided printing, outputs odd number pages with the printed surface face down starting from the first sheet.

[Face Up [Reverse Output Order]]

For one-sided printing, outputs the document with the printed surface face up in order starting from the first page.

For two-sided printing, outputs odd number pages with the printed surface face up starting from the first sheet.

Examples of output when this function is specified are indicated below.

	For one-sided printing	For two-sided printing
Face Down [Normal Output Order]		
Face Up [Reverse Output Order]		

[Output Order]

Sets the page order in which the document is output.

[Print on Back Sides]

Enables you to configure the layout of the reverse side of a sheet of paper when printing portrait print data on one side of the sheet, and landscape print data on the other side.

[Rotate Pages for Layout]

Rotates the pages according to the orientation of the first page and aligns the size of each page when performing N on 1 printing or booklet printing of print data with pages whose orientation varies.

[Details] > [Rotate Pages for Layout Details] Dialog Box

Enables you to set a rotation direction.

[Auto]

Prints with the second page onward automatically rotated 90 degrees to the left or 90 degrees to the right according to the orientation of the first page.

[Right 90 Degrees]

Prints with pages whose orientation differs from the first page rotated 90 degrees to the right.

[Left 90 Degrees]

Prints with pages whose orientation differs from the first page rotated 90 degrees to the left.

[Secure Printing Function of Device]

Embeds restriction and tracking information into the print data as a dot pattern. This function is useful when printing confidential documents.

[Copy Set Numbering]

Enables you to print a serial number in semi-transparent text on each copy when you are printing several copies of a document. This function is useful when printing confidential documents. The serial number is printed in five positions, on the upper left, upper right, lower left, lower right, and center of the page.

[Details] > [Copy Set Numbering Details] Dialog Box

Enables you to set the starting number.

[Image Refinement]

Enables you to set whether to use smoothing processing, which adjusts the contours of text and diagrams to make them smoother. If you select [Printer Default], the default setting of the device is used.

[Image Special Process]

If bold characters or centers of lines are missing from printed data, select [Level 1]. If this does not solve the problem, select [Level 2].

[Special Print Adjustment A]/[Special Print Adjustment B]/[Special Print Adjustment C]/[Blurry Image Correction]/[Quiet Mode]

If lines appear in the printed output, you can adjust the print settings to compensate.

[Special Print Adjustment A]/[Blurry Image Correction] thins out the dots when printing. Try [Mode 1] first.

[Special Print Adjustment B] strengthens toner fixing. Try [Mode 1] first.

[Special Print Adjustment C]/[Quiet Mode] reduces the print speed.

Using the [Special Print Adjustment A] function may result in thinner print density and rough print results.

[Special Smoothing Mode]

Smooths the contours of text, lines, and diagrams, and internal gradations.

[Printer Default]

Uses the default setting of the device.

[Mode 1]

Prints the edges of dark colored text, lines, and diagrams smoothly. Normally, you should print with the [Mode 1] setting.

[Mode 2]

Prints not only the edges, but also the interior halftones of diagrams smoothly. If the interior halftones of dark colored large text and broad lines exhibit color shift and do not print smoothly with the [Mode 1] setting, try printing with [Mode 2].

[Mode 3]

Prints dark colored text and lines smoothly on halftone backgrounds. If the interior halftones of dark colored large text and broad lines exhibit color shift, and the edges of light colored text and lines are uneven and do not print smoothly with the [Mode 1] setting, try printing with [Mode 3].

[Mode 4]

Prints the edges of a variety of objects smoothly. If the edges of light colored large text and broad lines are uneven and do not print smoothly with the [Mode 1] setting, try printing with [Mode 4].

[Mode 5]

Prints images and halftone objects evenly. If the color bands of images, diagrams, and gradations are uneven, and shading patterns do not print uniformly with the [Mode 1] setting, try printing with [Mode 5].

[Mode 6]

Prints entire objects smoothly. If there is halftone shift and unevenness throughout images with the [Mode 1] setting, try printing with [Mode 6].

[Curl Correction]

If curling occurs, causing paper jams, use this function to alleviate the curling.

[Wrinkle Correction]

If wrinkling occurs, causing paper jams, use this function to alleviate the wrinkling. Try [Mode 1] first. Depending on the printer model, [Mode 1] corrects wrinkles when printing with envelopes, and [Mode 2] when printing with paper whose edges are moist.

[EMF Spooling]

Spools print data in EMF format. When printing from an application, this shortens the time taken for the application to send the data to the printer.

When spooling in EMF format, problems such as the printed result differing from the image shown on the monitor, and more time being required for printing than normal, may occur depending on the application being used. If such problems occur, change the setting for [EMF Spooling] to [Off].

[Invalidate Passthrough]

Disables the passthrough function of the printer driver. If you cannot print from an application that sends print data directly to the device, disabling passthrough may make printing possible.

[Print Mixed Color/B&W Documents at High Speed]

This function reduces the print time when printing data that contains a mixture of color pages and grayscale (black and white) pages.

[Print Last Page in 1-sided Mode When 2-sided Printing is Set]

When using 2-sided printing to output print data containing an odd number of pages, this function prints the last page in 1-sided print mode to reduce the print time.

[Special Fine Line Processing]

Corrects fine lines when printing so that they are thicker.

[Off]

Prints without correcting.

[Mode 1]

Corrects lines of less than two dots in width to a thickness of two dots when printing.

[Mode 2]

Corrects lines and rectangles of less than two dots in width to a thickness of two dots when printing.

[Mode 3]

Corrects lines and rectangles of less than three dots in width to a thickness of three dots when printing.



NOTE

- If noise and lines are prominent in gradation areas, the print result may be able to be improved by setting [Special Fine Line Processing] to [Off] or [Mode 1].

[Special Print Mode]

Enables you to set a special print mode for adjusting text and lines so that they print more clearly. This function is useful for printing barcodes, text, and images in documents that have strong contrast.

[Barcode Adjustment Mode]

In cases where barcode printing is unsatisfactory, such as when a barcode on a printed article is unreadable, this function adjusts the thickness of the printed lines.

[Special Print Mode [Plain Paper]]

Solves fixing problems such as curling when printing with plain paper.

[Printing Start Side]

Sets which side printing starts from when performing 2-sided printing.

Use this function if pages are not printed from the intended page source or on the intended page type when performing 2-sided printing. The pages may then be printed correctly.

[Printing Start Position Settings]

Shifts the starting point for printing data in the long edge (upward) and short edge (rightward) directions. This function is useful for adjusting margins when the widths of the top and bottom margins and right and left margins differ, and for hiding the header information of faxes.

[Details] > [Printing Start Position Details] Dialog Box

Enables you to specify print starting positions.

[Increase Print Speed for Forms]

Use this function with the [Printer Default] setting.

[Restore Defaults]

Returns all the settings to their default values.

Related Topics

- ▶ **Common Settings for All Sheets(P. 123)**
- ▶ **Booklet Printing(P. 36)**
- ▶ **Saddle Stitched Booklet Printing(P. 39)**
- ▶ **Perfect Binding(P. 42)**
- ▶ **Driver settings cannot be set(P. 186)**
- ▶ **Print results are unsatisfactory(P. 187)**
- ▶ **Printing takes a long time(P. 189)**

[Paper Source] Sheet

You can set the paper type and paper source.

Depending on the driver you are using, you may not be able to set some of the functions described herein.

[Select by]

Selects whether to specify the paper to print on by paper source or by paper type.

[Paper Selection]

Specifies the paper source method depending on the page.

[Paper Source]

Specifies the paper to print on by paper source.

[Paper Type]

Specifies the paper to print on by paper type.

[Settings] > [Paper Type Settings] Dialog Box

Enables you to change the paper type. When acquiring the paper type information from the device, click [Retrieve Paper Information].

[Insert Sheets Settings] > [Insert Sheets Settings] Dialog Box

Enables you to configure settings relating to inserted sheets.

[Setting List]

Displays the sheets to be inserted and their positions in a list.

[Delete]

Deletes the selected sheet insertion settings from [Setting List].

[Sheets to Insert]

Specifies the paper type of the sheets to be inserted.

[Paper Source]

Specifies the paper source of the sheets to be inserted.

[Print on]

Prints on the selected side(s) of sheets to be inserted.

[Insert]

Inserts sheets for separating the document into sections.

[Tab Paper]

Inserts tab paper into the document.

[Settings] > [Paper Type Settings] Dialog Box

Enables you to change the paper type of the tab paper.

[Tab Details] > [Tab Details] Dialog Box

Enables you to set the printing position on the tab papers.

[Add]

Adds the sheet insertion settings to [Setting List].

[Original Paper Source]

Specifies the paper source for print data.

[Original Paper Type]

Specifies the paper type for print data.

[Paper Name]

Specifies the paper source by the name of the paper. The name of the paper is registered via the Remote UI.

This function may not be available, depending on the device you are using.

In that case, set the paper for the paper source in [Paper Type].

[Cover Sheets]

Specifies the paper source or paper type used for cover sheets to insert between transparencies. When selecting various paper types registered in the device, click [Settings].

[Transparencies]

Specifies the paper source or paper type used for transparencies. When selecting various paper types registered in the device, click [Settings].

[Tab Details] > [Tab Details] Dialog Box

Enables you to set the printing position on the tab papers.

[Paper Source Information] > [Paper Source Information] Dialog Box

Displays information about the paper set in the paper sources. To acquire the paper source information from the device, click [Retrieve Paper Source Information].

[Carbon Copy]

Prints one copy of the same document from multiple specified paper sources.

This enables you to print to different types of paper at the same time, such as high quality paper and recycled paper.

[Settings] > [Carbon Copy Settings] Dialog Box

Selects the paper source to print from.

[Front/Back Cover Settings] > [Front/Back Cover Settings] Dialog Box

Inserts front and back covers. You can also set the paper source of the front and back covers and whether to print on them.

[Feed Standard Paper Sizes Vertically]

Feeds standard paper sizes vertically when printing.

[Feed Custom Paper Vertically]

Feeds custom paper sizes vertically when printing.

[Print on the Other Side]

If you want to print on both sides of paper fed manually into the multi-purpose tray, select this function to print on the other side of the paper.

[Restore Defaults]

Returns all the settings to their default values.

Related Topics

- ▶ **Common Settings for All Sheets(P. 123)**
- ▶ **Inserting Sheets(P. 47)**
- ▶ **Inserting Tab Paper(P. 48)**
- ▶ **Printing on Tab Paper(P. 50)**
- ▶ **Adding Cover Sheets(P. 51)**

[Quality] Sheet (UFR II/LIPSLX/LIPS4/PCL6)

You can set detailed print quality settings.

This section explains the settings displayed in the UFR II/LIPSLX/LIPS4/PCL6 driver.

Depending on the driver you are using, you may not be able to set some of the functions described herein.

[Objective]

Enables you to set a print quality mode that matches the purpose of the print data by simply selecting a setting.

You can check the settings status in the settings preview.

[Advanced Settings] > [Advanced Settings] Dialog Box

Enables you to set print quality details such as resolution, gradation, toner amount, etc.

[Graphics Mode]

Sets the processing method for print data.

[Vector Mode]/[LIPS Mode]

Processes print data with the LIPS control command or vector control command and sends it to the device. Normally, you need to select one of these modes.

[Raster Mode]

Converts print data to image (bitmap) data and sends it to the device. Select this setting if the image on the screen and the printed result differ, or if printing takes an especially long time, when printing with [Vector Mode] or [LIPS Mode].

[Rendering Rate]/[Mode Details]/[LIPS Mode Details]

Sets the image rasterizing method for print data.

[1 BPP]

Replaces all parts other than white with black for characters and fine lines, and prints at high speed.

[1 BPP [Enhanced]]/[High Speed]

Expresses gradation as halftones and prints at high speed. Prints characters and thin lines in black.

[24 BPP]/[High Quality]

Takes longer to print than [1 BPP], [1 BPP [Enhanced]], and [High Speed], but prints higher quality.

[Resolution]

Sets the print resolution.

[Gradation]

Sets the gradation method. [High 2] uses finer gradations than [High 1] to smooth gradations.

[Halftones]

Sets dither patterns for representing halftones (areas between dark areas and light areas).

[Printer Default]

Uses the settings of the device.

[Resolution]

Gives priority to resolution and prints contours smoothly.

[Gradation]

Gives priority to gradation and prints gradations smoothly.

[Error Diffusion]

Prints small characters and thin lines finely.

[Pattern 1] to [Pattern 7]

Applies the following halftone processing settings independently to text, graphic, and image data.

Where there are 7 patterns:

	Text	Graphics	Images
Pattern 1	Error Diffusion	Error Diffusion	Resolution
Pattern 2	Error Diffusion	Error Diffusion	Gradation
Pattern 3	Error Diffusion	Resolution	Resolution
Pattern 4	Error Diffusion	Gradation	Gradation
Pattern 5	Resolution	Resolution	Gradation
Pattern 6	Resolution	Gradation	Gradation
Pattern 7	Error Diffusion	Resolution	Gradation

Where there are 6 patterns:

	Text	Graphics	Images
Pattern 1	Resolution	Resolution	Gradation
Pattern 2	Resolution	Gradation	Gradation
Pattern 3	Resolution	Gradation	Resolution
Pattern 4	Gradation	Resolution	Resolution
Pattern 5	Gradation	Resolution	Gradation
Pattern 6	Gradation	Gradation	Resolution

Where there are 5 patterns:

	Text	Graphics	Images
Pattern 1	High Resolution/Resolution	Gradation	Color Tone
Pattern 2	Resolution	Color Tone	Color Tone
Pattern 3	Gradation	Gradation	Gradation
Pattern 4	High Resolution/Resolution	High Resolution/Resolution	Gradation
Pattern 5	Color Tone	Color Tone	Color Tone

[None [Solid]]

Prints the parts of text and lines other than white as solid black.

[Items to Prioritize for Processing When in Raster Mode]

Sets the items to prioritize when the print data conversion method is set to the raster mode. You can select images, graphics, or text.

The raster mode is set as the conversion method in the following cases.

Black-and-white printer: When [Raster Mode] is set in the [Advanced Settings] dialog box > [Graphics Mode] on the [Quality] sheet

Color printer: When [On] is set for [Advanced Settings] > [Always Rasterize at Host] on the [Finishing] sheet

[Host Side Rasterization]

Specifies if image data rasterization is performed by the host computer rather than the printer. This enables you to print clearer images, but slows down the processing speed.

[Retrieve Calibration Information When Printing]

Obtains calibration information from the device and adjusts colors automatically.

[Enable Image Correction]

Smooths out low-resolution coarse image data in graphic images, photographs, etc. that have been enlarged in applications when printing.

[Substitute TrueType Fonts with Printer Fonts]

Substitutes printer fonts for TrueType fonts when printing. The printer fonts to substitute can be set in [Font Settings] > [Font Substitution Table] on the [Device Settings] sheet.

[Prioritize Application Settings for Substitution of TrueType Fonts]

Enables the TrueType font substitution settings in the application to be prioritized.

[Toner Save]

Thins out the print data to save toner.

[Draft Mode]

Saves toner by printing with reduced toner.

[Toner Density]

Adjusts the toner density.

[Details] > [Toner Density Details] Dialog Box

Enables you to adjust the density of each color.

[Advanced Smoothing]

Smooths the contours of text, lines, and images. [Smooth 2] performs stronger smoothing processing than [Smooth 1].

[Toner Volume Correction]

Adjusts the amount of toner to match the content of the print data. [Gradation Priority] uses the optimum amount of toner for print data that includes large amounts of graphics and CG gradations. [Text Priority] uses the optimum amount of toner for print data that contains mainly text.

[Line Control]

Improves reproduction of text and lines. [Resolution Priority] gives priority to resolution. [Gradation Priority] gives priority to gradation.

[Sharpness]

Adjusts the sharpness of the contours of images.

[Sharpness (Photo)]

Strengthens the contours of images.

[Use Printer Fonts]

Use the TrueType fonts that reside within the device.

[TrueType Mode]

Sets the method used to print TrueType fonts. [Download as TrueType] sends TrueType fonts directly to the device where they are rasterized. [Download as Bit Image] rasterizes all TrueType fonts automatically and sends them as bitmapped data to the device.

[Dither Image Data on Device]

Performs dithering of image data at the device.

[Use TypeWing]

Performs high speed TrueType font processing.

[Accelerated Image Processing]

Sets the extent of high speed processing to be used. However, higher processing speeds can lead to loss of printing quality.

[Density Fine Adjustment]

Adjusts the print density for small-sized text and thin lines. This function is useful for correcting "cracks" in text and lines.

[Compressed Image Data Processing]

Sets the print processing method to be used when printing the compressed image data.

[Auto]

Automatically selects the optimum processing method.

[By Host]

Decompresses the compressed image data at the host.

[By Device]

Decompresses the compressed image data at the device. This normally enables printing at high speed.

[Process Images Collectively]

Combines multiple adjoining images into a single image at the computer end to reduce the data processing load.

[Color Data Processing When B&W Printing]

When printing color originals (data) in black-and-white, processes the data to enable differences in color to be more easily distinguished.

[Pattern Position Correction]

Corrects the position of tile patterns.

[Pattern Resolution]

Specifies the resolution used to draw tile patterns.

[Gray Compensation]

Prints black and gray data reliably in black and gray.

[Line Control [Gray Compensation]]

Improves reproduction of text and lines.

[Gradation Smoothing]

Prints transitions between colors in gradations smoothly. [Smooth 2] performs a stronger smoothing process than [Smooth 1].

[Image Compression]

Adjusts the print data compression ratio when sending it to the device, and prints with priority given to either image quality or print speed.

[Image Compression Optimization]

Uses an optimization method that switches between irreversible and reversible, or uses a uniform compression method without optimization. If the image is compressed with optimization, JPEG block noise is suppressed.

[Compression Processing for Data Transfer]

Switches between giving priority to image quality and giving priority to speed when compressing and transferring image data.

Even when priority is given to speed, printing may take longer than when priority is given to image quality, depending on the print data and environment.

[Always Print PDF File in Raster Mode]

Automatically selects raster mode every time you print PDF file.

[Print Diagonal Lines at High Speed]

Reduces the processing time when printing diagonal lines. As a result, gaps between diagonals in diagrams may stand out. If this happens, turn this function off.

[POP Printing Optimization]

Increases the amount of toner to print POP advertisements and images clearly.

This function can only be used when a configuration profile that supports Laser Printers/All-in-One Printers is selected in [Config. Profile]. The following items must also be set in advance.

- [Basic Settings]/[Finishing] Sheet

- When [Laser Printers] is selected in [Config. Profile]
Select [1-sided Printing] in [1-sided/2-sided/Booklet Printing] or [Print Style]
- When [All-in-One Printers] is selected in [Config. Profile]
Select [1-sided Printing] or [2-sided Printing] in [1-sided/2-sided/Booklet Printing] or [Print Style]
- [Basic Settings]/[Quality] Sheet
 - Select [Auto [Color/B&W]] or [Color] in [Color Mode]
 - Select [Full Color] in [Number of Colors Settings]
- [Quality] Sheet
 - In [Advanced Settings] > [Resolution], select something other than [1200 dpi] for the resolution.
 - Select [Manual Color Settings] → select [Device Matching Mode] or [No Driver Matching] in [Matching Mode] on the [Color Settings] > [Matching] sheet
- [Device Settings] Sheet
 - Enable [[POP Printing Optimization] Function] on the [Details] > [Quality] sheet

When enabling this function, it is recommended that the timing for low toner notifications is set to the [POP Print] of the device. For details, refer to the manual of the device.

[Special 1 BPP Mode]

Reduces the size of the data to be printed.

[Output Adjustment Mode]

Switches between giving priority to image quality and giving priority to speed when printing. Select [On] to prioritize image quality when printing.

[Grayscale Conversion]

Sets the method for converting color print data to grayscale.

[Width Adjustment]

Adjusts the thickness of specific objects such as text and lines.

[Trapping]

Performs an overlapping process at the borders between text or graphics and the background to prevent white lines around the edge portions of the text or graphics.

[Details] > [Trapping Details] Dialog Box

Enables you to set the trapping width and density.

[Adjust Toner Volume Used for Color Printing]

Adjusts the amount of toner to prevent too much toner being used when color printing. [Level 1] slightly reduces the amount of toner in areas of strong color. [Level 2] reduces the amount of toner overall.

[Use Driver Grayscale Conversion When B&W Printing]

Gives the driver grayscale conversion priority over the conversion of the application when black-and-white printing.

[Correction Processing for Reduced Graphic Details]

Performs correction to maintain print quality when reducing print data.

[Uniform Printing of Fine Diagonal Lines]

Unifies the width of fine diagonal lines.

[CanoFine]

Adjusts the contrast and color balance of images to print distinct images.

[Details] > [CanoFine Details] Dialog Box

Enables you to set the print processing method using the [CanoFine] function.

[Color Mode]

Switches between printing in color or in black-and-white. To detect automatically whether each page should be printed in color or in black-and-white, select [Auto [Color/B&W]].

[Number of Colors Settings] > [Number of Colors Settings] Dialog Box

Enables you to switch between full color printing and two color printing.

If you select [Two Colors], set which color to use with black from [Color to Use with Black]. The parts of the print data for which there is no color data are printed in shades of black and white, while the parts for which there is color data are printed in shades of the specified color.

[Manual Color Settings]/[Manual Grayscale Settings]

Enables you to manually configure color or grayscale settings.

[Color Settings]/[Grayscale Settings] > [Color Settings]/[Grayscale Settings] Dialog Box

Enables you to configure detailed color, brightness, contrast, and color matching settings.

[Color Adjustment]/[Grayscale Adjustment] Sheet**[Original]/[Preview]**

Enables you to check the adjusted image.

[Increase (Color)]

Adjusts the color. Click and drag the image toward the color(s) you want to strengthen.

[Brightness]

Adjusts the brightness. Use the side bar to lighten or darken the image.

[Contrast]

Adjusts the contrast. Use the side bar to increase or decrease the contrast of the image.

[Object Adjustment] > [Object Adjustment] Dialog Box

Sets the type of data to be subjected to color adjustment. You can select images, graphics, or text.

[Restore Defaults]

Returns all the settings to their default values.

[Matching] Sheet**[Matching Mode]**

Sets whether to perform color matching on the device side or the driver side, or whether color matching is not performed by the driver.

[Application Color Matching Priority]

Gives priority over the application settings when performing matching processing.

Enabling this function may improve the print result if part of the image is missing when printing.

[Matching Method]

Sets what factor is prioritized when matching.

[Monitor Profile]

Enables you to select the setting suitable for your monitor when [Device Matching Mode] is selected for [Matching Mode]. If several gamma values are provided for one option, to obtain better results select the higher gamma value if the printed image is lighter than that of the monitor.

[Images]/[Graphics]/[Text]

Enables you to set [Matching Method] and [Monitor Profile] for images, graphics, and text when [Matching Mode] > [Device Matching Mode] is selected.

[Gamma]

Enables you to adjust gamma when the gamma adjustment item is selected for [Matching Mode].

[Retrieve Calibration Information]

Retrieves calibration information from the device to automatically adjust the color when printing.

[About]

Displays the version of the driver.

[Restore Defaults]

Returns all the settings to their default values.

Related Topics

- ▶ **Common Settings for All Sheets(P. 123)**
- ▶ **Print results are too dark or too bright(P. 190)**

[Quality] Sheet (PS3)

You can set detailed print quality settings.

This section explains the settings displayed in the PS3 driver.

[Rendering Rate]

Sets the image rasterizing method for print data.

[1 BPP [Enhanced]]

Expresses gradation as halftones and prints at high speed. Prints characters and thin lines in black.

[24 BPP]

Takes longer to print than [1 BPP [Enhanced]], but prints higher quality.

[Resolution]

Sets the print resolution.

[Halftones]

Sets dither patterns for representing halftones (areas between dark areas and light areas).

[Printer Default]

Uses the settings of the device.

[Resolution]

Gives priority to resolution and prints contours smoothly.

[High Resolution]

Uses a dither pattern resolution with even more lines than [Resolution].

[Gradation]

Uses a dither pattern that gives priority to gradation.

[Error Diffusion]

Uses a dither pattern that gives priority to error diffusion, which has excellent detail.

[Pattern 1] to [Pattern 7]

Applies the following halftone processing settings independently to text, graphic, and image data.

Where there are 7 patterns:

	Text	Graphics	Images
Pattern 1	Error Diffusion	Error Diffusion	Resolution
Pattern 2	Error Diffusion	Error Diffusion	Gradation
Pattern 3	Error Diffusion	Resolution	Resolution
Pattern 4	Error Diffusion	Gradation	Gradation
Pattern 5	Resolution	Resolution	Gradation
Pattern 6	Resolution	Gradation	Gradation
Pattern 7	Error Diffusion	Resolution	Gradation

Where there are 6 patterns:

	Text	Graphics	Images
Pattern 1	Resolution	Resolution	Gradation
Pattern 2	Resolution	Gradation	Gradation
Pattern 3	Resolution	Gradation	Resolution
Pattern 4	Gradation	Resolution	Resolution
Pattern 5	Gradation	Resolution	Gradation
Pattern 6	Gradation	Gradation	Resolution

[Custom]

Uses a customized dither pattern.

[Settings] > [Custom Settings] Dialog Box

Enables you to specify the number of screen lines (frequency) and pattern angle.

[Toner Save]

Thins out the print data to save toner.

[Advanced Smoothing]

Smooths the contours of text, lines, and images. [Smooth 2] performs stronger smoothing processing than [Smooth 1].

[Color Mode]

Switches between printing in color or in black-and-white. To detect automatically whether each page should be printed in color or in black-and-white, select [Auto [Color/B&W]].

[Print as Negative Image]

Prints a negative image of the document by reversing the black-and-white values.

[Print as Mirror Image]

Prints a mirror image of the document by flipping the image horizontally.

[Manual Grayscale Adjustment]

Enables you to adjust grayscale printing.

[Grayscale Adjustment] > [Grayscale Adjustment] Dialog Box

Enables you to set brightness when printing a document in grayscale.

[Manual Grayscale Settings]

Enables you to manually adjust the brightness and contrast.

[Grayscale Settings] > [Grayscale Settings] Dialog Box

Enables you to configure detailed brightness and contrast settings.

[Grayscale Adjustment] Sheet

[Original]/[Preview]

Enables you to check the adjusted image.

[Brightness]

Adjusts the brightness. Use the side bar to lighten or darken the image.

[Contrast]

Adjusts the contrast. Use the side bar to increase or decrease the contrast of the image.

[Restore Defaults]

Returns all the settings to their default values.

[About]

Displays the version of the driver.

[Advanced Settings] > [Advanced Settings] Dialog Box

Enables you to set print quality details such as resolution, gradation, toner amount, etc.

[Output Format]

Enables you to select the data format for PS files.

[TrueType Font Settings]

Enables you to specify detailed settings for TrueType fonts.

[Details] > [TrueType Font Details] Dialog Box

Enables you to set the format in which TrueType fonts are sent to the device.

[Gradation]

Sets the gradation method. [High 2] uses finer gradations than [High 1] to smooth gradations.

[Line Refinement]

Thickens thin lines when printing. This function is useful when printing small text and barcodes. This setting may be disabled when the resolution is set to 600 dpi.

[Toner Density]

Adjusts the toner density.

[Details] > [Toner Density Details] Dialog Box

Enables you to adjust the density of each color.

[Brightness]

Adjusts the brightness.

[Toner Volume Correction]

Adjusts the amount of toner to match the content of the print data. [Gradation Priority] uses the optimum amount of toner for print data that includes large amounts of graphics and CG gradations. [Text Priority] uses the optimum amount of toner for print data that contains mainly text.

[Line Control]

Improves reproduction of text and lines. [Resolution Priority] gives priority to resolution. [Gradation Priority] gives priority to gradation.

[Sharpness]

Adjusts the sharpness of the contours of images.

[Sharpness (Photo)]

Strengthens the contours of images.

[Density Fine Adjustment]

Adjusts the print density for small-sized text and thin lines. This function is useful for correcting "cracks" in text and lines.

[Combined Image Processing]

Switches between printing with pseudo-raster processing and printing without any processing if raster processing, which is not supported by PS3 driver, is specified from an application. Use this setting when you cannot obtain the expected print result.

[Gradation Smoothing]

Prints transitions between colors in gradations smoothly. [Smooth 2] performs a stronger smoothing process than [Smooth 1].

[Image Compression]

Adjusts the print data compression ratio when sending it to the device, and prints with priority given to either image quality or print speed.

[Image Compression Optimization]

Uses an optimization method that switches between irreversible and reversible, or uses a uniform compression method without optimization. If the image is compressed with optimization, JPEG block noise is suppressed.

[Compression Processing for Data Transfer]

Switches between giving priority to image quality and giving priority to speed when compressing and transferring image data.

Even when priority is given to speed, printing may take longer than when priority is given to image quality, depending on the print data and environment.

[Image Refinement]

Enables you to set whether to use smoothing processing, which adjusts the contours of text and diagrams to make them smoother. If you select [Printer Default], the default setting of the device is used.

[Grayscale Conversion]

Specifies a method for converting color document data to grayscale.

[Dot Gain Adjustment]

Enables you to adjust halftone dots to correct dot gain. Adjustment is performed with [Standard] (dot gain value + 20%) as a reference.

[Width Adjustment]

Adjusts the thickness of specific objects such as text and lines.

[Trapping]

Performs an overlapping process at the borders between text or graphics and the background to prevent white lines around the edge portions of the text or graphics.

[Details] > [Trapping Details] Dialog Box

Enables you to set the trapping width and density.

[Adjust Toner Volume Used for Color Printing]

Adjusts the amount of toner to prevent too much toner being used when color printing. [Level 1] slightly reduces the amount of toner in areas of strong color. [Level 2] reduces the amount of toner overall.

[Use Driver Grayscale Conversion When B&W Printing]

Gives the driver grayscale conversion priority over the conversion of the application when black-and-white printing.

[POP Printing Optimization]

Increases the amount of toner to print POP advertisements and images clearly.

This function can only be used when a configuration profile that supports Laser Printers/All-in-One Printers is selected in [Config. Profile]. The following items must also be set in advance.

- [Basic Settings]/[Finishing] Sheet
 - When [Laser Printers] is selected in [Config. Profile]
 - Select [1-sided Printing] in [1-sided/2-sided/Booklet Printing] or [Print Style]
 - When [All-in-One Printers] is selected in [Config. Profile]

Select [1-sided Printing] or [2-sided Printing] in [1-sided/2-sided/Booklet Printing] or [Print Style]

- [Basic Settings]/[Color] Sheet

Select [Auto [Color/B&W]] or [Color] in [Color Mode]

- [Basic Settings] Sheet

Select [Full Color] in [Number of Colors Settings]

- [Quality] Sheet

In [Resolution], select something other than [1200 dpi] for the resolution.

- [Device Settings] Sheet

Enable [[POP Printing Optimization] Function] on the [Details] > [Quality] sheet

When enabling this function, it is recommended that the timing for low toner notifications is set to the [POP Print] of the device. For details, refer to the manual of the device.

[Restore Defaults]

Returns all the settings in this sheet to their default values.

Related Topics

- ▶ **Common Settings for All Sheets(P. 123)**
- ▶ **Print results are too dark or too bright(P. 190)**

[Color] Sheet (PS3)

You can switch between color printing and black-and-white printing, and adjust colors.



NOTE

- If you select [Printer Default], the setting of the device is applied.

[Color Mode]

Switches between printing in color or in black-and-white. To detect automatically whether each page should be printed in color or in black-and-white, select [Auto [Color/B&W]].

[RGB Matching Mode]

Enables you to select the color matching mode for RGB input.

If [Device Link Profile] has been selected, a profile that is a combination of ambient light and color space profiles is used. You can select the optimum settings from [RGB Input [Light + Color Space]].

[RGB Source Profile]

Enables you to select an RGB profile that matches the monitor and is applied when printing RGB data. If [None] is selected, color separation of the RGB data to CMYK is performed without applying an RGB profile.



NOTE

- If you want to add a profile that you have created, download it to the device using the Resource Management plug-in of the imageWARE Enterprise Management Console/iW Management Console.

[RGB Matching Method]

Enables you to select the printing method when an RGB input profile is applied.

[Printer Default]

Uses the settings of the device.

[Saturation]

Optimizes the output of pure, saturated colors and produces clear outlines for text.

[Perceptual [Monitor Color Matched]]/[Perceptual]

Optimizes the range of colors on the device to produce the best result for bitmapped images.

[Perceptual [Photographic]]/[General]

Optimizes the range of colors on the device to produce the best result for photographic images.

[Colorimetric]

Provides a close match when rendering RGB colors into CMYK colors, regardless of the media being used.

[Vivid Photo]

Provides stronger and deeper colors than [Perceptual [Photographic]].



NOTE

- If you set [Output Profile] to a setting other than [Standard], [Perceptual [Photographic]] becomes the same color shade as [Perceptual [Monitor Color Matched]]/[Perceptual], and [Vivid Photo] becomes the same color shade as [Saturation].

[RGB Pure Black Process]

Prints black and gray data with the equivalent ratio of R to G to B using black (K) toner only. If you do not select this option, the CMYK toners are used, with the settings selected for [Output Profile] are applied.

[RGB Input [Light + Color Space]]

Enables you to select ambient light, color temperature, and monitor color space to apply to a device link profile for RGB input.

[CMYK Matching Mode]

Enables you to set the color matching mode for CMYK input.

If [Device Link Profile] has been selected, a profile that is a combination of ambient light and color space profiles is used. You can select the optimum settings from [CMYK Input [Light + Color Space]].

[CMYK Simulation Profile]

Enables you to select a CMYK simulation profile. If [None] is selected, device-dependent color model is applied without applying a CMYK profile.

[CMYK Pure Black Process]

Prints black and gray data using black (K) toner only. If you do not select this option, the CMYK toners are used, with the settings selected for [Output Profile] are applied.

[CMYK Input [Light + Color Space]]

Enables you to select ambient light, color temperature, and monitor color space to apply to a device link profile for CMYK input.

[Output Profile]

Enables you to select a profile defining color attributes, according to the device you are using or the paper type.



NOTE

- If you want to add a profile that you have created, download it to the device using the Resource Management plug-in of the imageWARE Enterprise Management Console/iW Management Console.

[100% GCR Profile]

Enables you to adjust the toner density so that irregularities in the print density of lines and text do not occur.

[Details] > [Detailed Settings] Dialog Box

Enables you to configure detailed color adjustment settings.

[Pure Black]

Prints black data (R=G=B=0%, C=M=Y=100%/Bk=N%, or C=M=Y=0%/Bk=100%) using only black toner. This prevents non-aligned color toner from being printed around the black data.

[Black Overprint]

Prints black data over the top of color backgrounds. When set together with [Pure Black], color backgrounds are all printed in color, after which the black data is printed overlapping the backgrounds, preventing unprinted white paper appearing at the edges of the text or graphics.

[Combine Color Separations]

Combines color-separated CMYK data into one set of data when printing.

[Composite Overprint]

Overprints CMYK data in its composite output form. Since all of the colors used in the data set are overprinted on one plate, you can confirm the finished result without separating the colors.

[Spot Color Matching]

Specifies the optimum method of reproducing a spot color (special color). Using a named color profile specified in an application, you can convert colors to device-independent CMYK values that are closest to the spot colors. To do so, you must first download the named color profile to the printer using the resource downloader.

**NOTE**

- If you want to use this function, download the specified color profile to the device using the Resource Management plug-in of the imageWARE Enterprise Management Console/iW Management Console.

[Toner Density]

Adjusts the toner density.

[Details] > [Toner Density Details] Dialog Box

Enables you to adjust the density of each color.

[Brightness]

Enables you to adjust the brightness with a slider bar.

[Grayscale Profile]

Converts printer dependent gray data to CMYK data when printing. If you do not use this function, the data is printed with black (K) toner only.

[RGB Color Input Adjustment]

Enables you to adjust color when printing RGB data.

[Settings] > [RGB Color Input Adjustment Details] Dialog Box

Enables you to adjust the hue, brightness, and contrast manually.

[Use CanoFine]

Adjusts the contrast and color balance of images to print distinct images.

[Settings] > [CanoFine Details] Dialog Box

Enables you to set the print processing method using the CanoFine function. If you select [Single-page Batch Processing], multiple bitmaps on a page are processed as a single data item.

[Distinguish between Color/B&W Pages at Host]

Distinguishes whether the print data is color or black-and-white (monochromatic) at the computer and prints in the mode corresponding to the result. If there is a large amount of bitmap data included in the data, it is printed in color.

[Apply Color/B&W Settings from Applications]

Prints with priority given to the color print setting or black and white print settings of the application.

[Restore Defaults]

Returns all the settings in this sheet to their default values.

Related Topics

- ▶ [Common Settings for All Sheets\(P. 123\)](#)
- ▶ [Adjusting Colors \(PS3\)\(P. 63\)](#)

[Exceptional Settings] Sheet (PS3)

You can apply printing settings for the specified page range within a document.

[Exceptional Page] > [Exceptional Page Settings] Dialog Box

Enables you to set exceptional settings for specified pages.

Common Settings for All Sheets

[Page]

Set the page range for exceptional settings.



NOTE

- If you select [Apply Basic Settings], the functions set in each sheet other than the [Exceptional Settings] sheet are applied.

[Page Setup] Sheet

[Paper Source]

Specifies the paper to print on by paper source.

[Print Style]

Specifies a method for outputting print data.

[Basic Settings]

Displays the functions set in each sheet other than the [Exceptional Settings] sheet in a list.

[Finishing Details] > [Finishing Details] Dialog Box

Enables you to specify print starting positions.

[Quality] Sheet

[Halftones]

Sets dither patterns for representing halftones (areas between dark areas and light areas).

[Settings] > [Custom Settings] Dialog Box

Enables you to specify the number of screen lines (frequency) and pattern angle.

[Sharpness]

Adjusts the sharpness of the contours of images.

[Density Fine Adjustment]

Adjusts the print density for small-sized text and thin lines. This function is useful for correcting "cracks" in text and lines.

[Color] Sheet

[Color Mode]

Switches between printing in color or in black-and-white. To detect automatically whether each page should be printed in color or in black-and-white, select [Auto [Color/B&W]].

[RGB Matching Mode]

Enables you to select the color matching mode for RGB input.

If [Device Link Profile] has been selected, a profile that is a combination of ambient light and color space profiles is used. You can select the optimum settings from [RGB Input [Light + Color Space]].

[RGB Source Profile]

Enables you to select an RGB profile that matches the monitor and is applied when printing RGB data. If [None] is selected, color separation of the RGB data to CMYK is performed without applying an RGB profile.



NOTE

- If you want to add a profile that you have created, download it to the device using the Resource Management plug-in of the imageWARE Enterprise Management Console/iW Management Console.

[RGB Matching Method]

Enables you to select the printing method when an RGB input profile is applied.

[Apply Basic Settings]

Applies the functions set in each sheet other than the [Exceptional Settings] sheet.

[Saturation]

Optimizes the output of pure, saturated colors and produces clear outlines for text.

[Perceptual [Monitor Color Matched]]/[Perceptual]

Optimizes the range of colors on the device to produce the best result for bitmapped images.

[Perceptual [Photographic]]/[General]

Optimizes the range of colors on the device to produce the best result for photographic images.

[Colorimetric]

Provides a close match when rendering RGB colors into CMYK colors, regardless of the media being used.

[Vivid Photo]

Provides stronger and deeper colors than [Perceptual [Photographic]].



NOTE

- If you set [Output Profile] to a setting other than [Standard], [Perceptual [Photographic]] becomes the same color shade as [Perceptual [Monitor Color Matched]]/[Perceptual], and [Vivid Photo] becomes the same color shade as [Saturation].

[RGB Pure Black Process]

Prints black and gray data with the equivalent ratio of R to G to B using black (K) toner only. If you do not select this option, the CMYK toners are used, with the settings selected for [Output Profile] are applied.

[RGB Input [Light + Color Space]]

Enables you to select ambient light, color temperature, and monitor color space to apply to a device link profile for RGB input.

[CMYK Matching Mode]

Enables you to set the color matching mode for CMYK input.

If [Device Link Profile] has been selected, a profile that is a combination of ambient light and color space profiles is used. You can select the optimum settings from [CMYK Input [Light + Color Space]].

[CMYK Simulation Profile]

Enables you to select a CMYK simulation profile. If [None] is selected, device-dependent color model is applied without applying a CMYK profile.

[CMYK Pure Black Process]

Prints black and gray data using black (K) toner only.

[CMYK Input [Light + Color Space]]

Enables you to select ambient light, color temperature, and monitor color space to apply to a device link profile for CMYK input.

[100% GCR Profile]

Enables you to adjust the toner density so that irregularities in the print density of lines and text do not occur.

[Details] > [Detailed Settings] Dialog Box

Enables you to configure detailed color adjustment settings.

[Grayscale Profile]

Converts printer dependent gray data to CMYK data when printing. If you do not use this function, the data is printed with black (K) toner only.

[Covers] > [Front/Back Cover Settings] Dialog Box

Inserts front and back covers. You can also set the paper source of the front and back covers and whether to print on them.

[Insert Sheets] > [Insert Sheets Settings] Dialog Box

Enables you to configure settings relating to inserted sheets.

[Setting List]

Displays the sheets to be inserted and their positions in a list.

[Delete]

Deletes the selected sheet insertion settings from [Setting List].

[Sheets to Insert]

Specifies the paper type of the sheets to be inserted.

[Paper Source]

Specifies the paper source of the sheets to be inserted.

[Print on]

Prints on the selected side(s) of sheets to be inserted.

[Insert]

Inserts sheets for separating the document into sections.

[Tab Paper]

Inserts tab paper into the document.

[Settings] > [Paper Type Settings] Dialog Box

Enables you to change the paper type of the tab paper.

[Tab Details] > [Tab Details] Dialog Box

Enables you to set the printing position on the tab papers.

[Add]

Adds the sheet insertion settings to [Setting List].

[List of Exceptional Settings]

Displays the current exceptional settings in a list.

[Edit]

Enables you to edit the selected exceptional setting.

[Merge]

Combines the selected multiple exceptional settings into one. You can only combine settings whose page ranges are continuous and settings are the same.

[Delete]

Deletes the selected exceptional setting.

[Basic Settings]

Displays the functions set in each sheet other than the [Exceptional Settings] sheet in a list.

Related Topics

- ▶ [Common Settings for All Sheets\(P. 123\)](#)
- ▶ [Setting Exceptional Pages \(PS3\)\(P. 98\)](#)

[Device Settings] Sheet

You can configure device option settings such as a configuration profile that matches your device and administrator settings.

When you set a configuration profile, optimal values for the device are automatically set for each item. For details, see the following link.

▶ **About Configuration Profile Type Settings(P. 92)**

Depending on the driver you are using, you may not be able to set some of the functions described herein.

[Device Information]

Displays whether the device status is set automatically or manually. When acquiring the device information and applying it to the settings in the [Device Settings] sheet, click [] (Retrieve Device Status Information).



NOTE

- If you select [On] from [Other Settings] > [Change Configuration Profile When Retrieving Device Information] in the [Detailed Settings] dialog box, the configuration profile is automatically changed according to the retrieved device information.

[Config. Profile]

Displays the applied configuration profile.

[Change] > [Change Configuration Profile] Dialog Box

Enables you to change or import a configuration profile.

[Select Configuration Profile]

[Select Configuration Profile Suitable for Your Device Automatically]

Sets the configuration profile suitable for the printer model you are using.

[Select Manually]

Enables you to manually set a configuration profile.

[] (Import Configuration Profile)

Imports an exported configuration profile file (*.typ).

[] (Delete)

Deletes the imported configuration profile selected from [Configuration Profile].

[Retrieve Device Information]

Acquires the device information and applies it to the settings in the [Device Settings] sheet.



NOTE

- If device information cannot be acquired, manually set a configuration profile that matches the name of the printer model.
- If you cannot properly set items displayed in the [Device Settings] sheet even after applying a configuration profile that matches the name of the printer model, you can apply the function and option information corresponding to the device by setting a configuration profile type.

▶ **About Configuration Profile Type Settings(P. 92)**

(Export) > [Export Configuration Profile] Dialog Box

Enables you to export and save the current settings in the [Device Settings] sheet as a configuration profile file (*.typ).

[Device Type]

Sets the type of device.

[Finishing Settings]

Sets the finishing functions of the device.

[Paper Source Settings]

Displays the paper source options attached to the device.

[Form to Tray Assignment] > [Form to Tray Assignment] Dialog Box

Enables you to set the paper size and paper type set in each paper source.

[Paper Size Settings] > [Paper Size Settings] Dialog Box

Enables you to set paper sizes to be used.

[Paper Source] > [Paper Source] Dialog Box

Enables you to set the paper source options attached to the device.

[Output Settings]

Displays the paper output options attached to the device.

[Paper Output Settings] > [Paper Output Settings] Dialog Box

Enables you to set the paper output options attached to the device.

[Other Settings]

Enables you to configure administrator settings relating to the device.

[Spooling at Host]

Sets whether processing of the print data is performed at the host (computer) or at the device.

If you select [Auto], processing is performed at the device when it is possible using only the device functions, increasing the print speed.

[PS Output from Application]

Sets whether an application sends PostScript code directly to the printer.

The output results for booklet printing and overlay printing may change due to the setting for this function.

[Set User Information]

Enables you to set a user name to be used for print jobs and the PIN used in secured printing.

[Settings] > [User Information Settings] Dialog Box

[User Name]

Sets a user name to be used for print jobs.

[PIN for Secure Print]

Sets a PIN for secured printing.

[Always Confirm User Information When Performing Secure Print]

Displays the [Confirm PIN] dialog box for confirming or setting a name for the print data, user name, and PIN when performing secured printing.

[Confirm User Name When Printing]

Displays the [Confirm User Name] dialog box for confirming or setting a user name when printing.

[Display Previously Entered Information When Confirming]

Displays confirmation dialog boxes with the user name and PIN you entered last time automatically entered.

[User Name Management]/[Default Value Settings] > [User Name Management]/[Default Value Settings] Dialog Box

Enables you to configure the default settings for the user name and PIN.

[Name to Set for User Name]

Enables you to specify the Windows logon name, computer name, or any desired name for the user name.

[PIN for Secure Print]

Set a PIN for secured printing.

[Always Confirm User Information When Performing Secure Print]

Displays the [Confirm PIN] dialog box for confirming or setting a name for the print data, user name, and PIN when performing secured printing.

[Confirm User Name When Printing]

Displays the [Confirm User Name] dialog box for confirming or setting a user name when printing.

[Do Not Allow User Name Changes]

Prohibits changes to the user name in the [User Information Settings] dialog box.

[Fix [User Information Settings]-[Always Confirm User Information When Performing Secure Print] Setting]

Fixes the [Always Confirm User Information When Performing Secure Print] setting to the setting set in the [Default Value Settings] dialog box.

[Fix [User Information Settings]-[Confirm User Name When Printing] Setting]

Fixes the [Confirm User Name When Printing] setting to the setting set in the [User Name Management] or [Default Value Settings] dialog box.

[User Management]

Sets the type of authentication function to use.

[Settings] > [Department ID/PIN Settings] Dialog Box

Enables you to configure the detailed settings when you select [Department ID Management] from [User Management].

[Allow PIN Setting]

Enables you to set the PIN in this dialog box. In a shared printer environment, deselect this item at the server if you want to disable PIN or password settings at the client computers.

[Department ID]

Sets the department ID which has been set at the device.

[PIN]

Sets a PIN for the department ID management. If the PIN has not been set at the device, leave this box blank.

[Verify]

Verifies whether the entered department ID and PIN match those set at the device.

[Confirm Department ID/PIN When Printing]

Displays the [Confirm Department ID/PIN] dialog box for confirming or setting the department ID and the PIN when printing.

[Display Confirm Dialog]

Sets the timing at which the [Confirm Department ID/PIN] dialog box is displayed.

[Do Not Use Department ID Management When B&W Printing]

Enables you to print without applying department ID management when printing in black and white.

[Authenticate Department ID/PIN at Device]

Performs authentication of the department ID and PIN at the device.

[Settings] > [User Authentication Settings] Dialog Box

Enables you to configure the detailed settings when you select [User Authentication] from [User Management].

[Allow Password Settings]

Enables you to set a password. If you do not set a password here, input the password when printing.

[User Name]

Sets a user name to be used for user authentication.

[Password]

Sets a password for user authentication. If the password has not been set at the device, leave this box blank.

[Verify]

Verifies whether the entered password matches that set at the device.

[Confirm Authentication Information When Printing]

Displays the [Confirm User Name/Password] dialog box for confirming or setting authentication information when printing.

[Display Confirm Dialog]

Sets the timing at which the [Confirm User Name/Password] dialog box is displayed.

[Perform Authentication at Device]

Performs the authentication process at the device.

[Secure Printing Function of Device]

Embeds restriction and tracking information into the print data as a dot pattern when using the document scan lock kit.

[About]

Displays the version of the driver.

[Language Settings] > [Language Settings] Dialog Box

Enables you to switch the display language.

[Special] > [Special Settings] Dialog Box

Enables you to set [Fix [Output Method] as [Store]].



[Function] > [Device Function Settings] Dialog Box

Displays the controller function ID and function version of the device. You can also set a name for the device.

[Font Settings] > [Font Settings] Dialog Box

Enables you to substitute printer fonts for TrueType fonts.

[Details] > [Detailed Settings] Dialog Box

Enables you to configure the settings in the print settings screen of the driver. Items with [] are set automatically by the acquire device information function. Items with [] may require settings to be configured manually.

IMPORTANT

- If you set a paper source that is not installed in the device, paper will be supplied from the device's priority paper source.
- If the paper source you have specified and the paper size/type do not match, an error will occur.
- If you specify [Finishing Settings] (2-sided printing, stapling, etc.) functions for a device that does not have those functions, printing will be performed without those functions. For example, if you specify 2-sided printing for a device that does not support 2-sided printing, the data will be printed on one side of the paper.
- If you select [Store] from [Output Method] when printing from a device that does not support box storage, the data will be printed normally. If an error is displayed on the touch panel display of the device and the device goes offline, the data is printed when the device goes online again.
- If you set the department ID management function or the user authentication function when printing for a device that does not have those functions, an error will occur.
- If you enable [Perform Processing with Print Processor] in the [Other Settings] sheet of the [Detailed Settings] dialog box, the usable functions are restricted. For details, refer to the Readme file.

Related Topics

- ▶ **Setting Device Information(P. 72)**
- ▶ **Device Functions Settings(P. 77)**
- ▶ **Paper Sources and Output Destinations Settings(P. 78)**
- ▶ **Importing a Configuration Profile(P. 89)**
- ▶ **Exporting a Configuration Profile(P. 87)**
- ▶ **Setting the Authentication Function(P. 93)**
- ▶ **Setting the User Name(P. 95)**
- ▶ **Driver settings cannot be set(P. 186)**
- ▶ **Cannot use the acquire device information function or authentication function(P. 193)**

[Profile] Sheet

You can edit, import, and export profiles. If you edit profiles on the server side in a shared printer environment, the changes are reflected in the client profiles.

Depending on the driver you are using, you may not be able to set some of the functions described herein.

[Profile List]

Displays registered profiles as a list. You can change the order by selecting a profile and clicking [] (Move

Up) or [] (Move Down).



NOTE

- Profiles with a red dot (●) next to them are pre-registered profiles and cannot be edited or deleted.

[View Settings]

Displays the content of the selected profile as a list.

[Add]/[Edit] > [Add/Edit Profile] Dialog Box

Enables you to add a new profile or edit the settings of a user-registered profile. Set [Name] and [Icon]. Enter a comment in [Comment] if required. Switch sheets and configure relevant settings. If you want to check the current settings in a list, click [View Settings].

[Edit]

Enables you to edit the settings of a user-registered profile.

[Delete]

Deletes the selected profile.

[Name]/[Comment]

Displays the name and comment of the selected profile. You can edit the name and comment of user-registered profiles.

[Import]

Imports a profile saved as a "*.cfg" file and adds it to [Profile List].

[Export]

Exports the profile selected in [Profile List] and saves it as a "*.cfg" file.

[Define Document Property]

Allows settings in the print settings screen of the driver. This function is useful when restricting usage of the print settings in client computers in a shared printer environment.

If you deselect the following settings at the server, the settings of all client computers are fixed at those configured at the server.

[Allow Profile Selection]

Enables you to select profiles in the print settings screen.

[Allow Editing of Settings]

Enables you to configure print settings other than selecting profiles in the print settings screen. This setting can be selected when [Allow Profile Selection] is selected.

Related Topics

- ▶ **Driver settings cannot be set(P. 186)**

[AMS] Sheet

You can set the user information and device information required to use AMS.

You can also confirm information for the currently authenticated user and print restrictions.

A dialog box may be displayed when printing to check the password or print restriction information.

This explains the items in the [AMS] sheet and the dialog box displayed when printing.

▶ Descriptions of Settings(P. 172)

▶ Dialog Box Displayed When Printing(P. 175)

NOTE

- In the following cases, the correct print restrictions may not be applied, depending on the application.
 - Printing using the pass-through print function (UFR II/LIPSLX/PS3 driver)
Because printing is performed without passing through the driver.
 - Printing using a PPD file (PS3 driver)

Descriptions of Settings

[Use AMS Function]

Select this to enable the Access Management System Printer Driver Add-in.

[Current User Name]

Displays the user name of the currently authenticated user.

You cannot specify the user name in the dialog box that is displayed when printing by the Secure Print function of the printer driver or the Encrypted Secure Print Driver Add-in for Client PC. Printing is executed using the user name displayed in [Current User Name].

[User Name/Password] ▶ [Setup User Names and Passwords for Authentication] Dialog Box

Displays a dialog box for specifying a user name and password for authentication.

[Setup Method]

In [Setup Method], select the method for setting the user information to use for authentication.

[Use the PC log-on information]	Use the information for the computer's log-on user. If you are using Active Directory authentication, this setup method is recommended. This item cannot be used for a computer used as both a domain server and client, as authentication information cannot be retrieved.
[Setup authenticated user information]	In [User Information Used for Authentication], set the user name and password.

NOTE

- [Setup Method] is enabled when you are logged on to the computer as a domain user in an environment using Active Directory authentication. Otherwise, [Setup authenticated user information] is selected.
- For information on setting user information, contact your device restriction administrator.

[User Information Used for Authentication]

If you selected [Setup authenticated user information] for [Setup Method], set the user information to use for user authentication.

Enter the [User Name] (sAMAccountName) and [Password], and select the authentication location of user information in [Authentication].

If you are using local device authentication, select [This Device] for [Authentication]. If you are using Active Directory authentication, enter the domain name (NetBIOS name).

 **NOTE**

- If you selected [Use the PC log-on information] for [Setup Method], it is not necessary to specify [User Name], [Password] and [Authentication].
- If you are using Active Directory authentication, the [Confirm Password for Authentication] dialog box is displayed each time you print. However, it is not necessary to enter a password if printing within approximately 30 minutes of the last authentication (if the date and time settings of the device and the computer are synchronized).

[Save Password and Skip Authentication Dialog Box When Printing]

Set whether to display the [Confirm Password for Authentication] dialog box each time you print. If you select [Save Password and Skip Authentication Dialog Box When Printing], the [Confirm Password for Authentication] dialog box is not displayed, and you can print without entering a password.

 **NOTE**

- If you do not select [Save Password and Skip Authentication Dialog Box When Printing], the [Confirm Password for Authentication] dialog box is displayed each time you print. However, it is not necessary to enter a password if printing within approximately 30 minutes of the last authentication (if the date and time settings of the device and the computer are synchronized).
- [Save Password and Skip Authentication Dialog Box When Printing] is only available when using local device authentication ([This Device] selected for [Setup Method]) and the device is set to allow passwords to be saved.
- Depending on your environment, the message "The printer requires your attention. Go to the desktop to take care of it." may be displayed when printing from a Windows Store app. If this happens, move to the desktop and follow the instructions in the displayed dialog box.

[Print Restriction Information]

Displays the print restrictions for the user displayed in [Current User Name].

[Print]	If [You do not have privileges to print using this device] is displayed, you cannot print. To enable printing, it is necessary to contact the device restriction administrator and get the print restriction information changed.
[Color Print]	If [Not Available] is displayed, documents will be printed in black-and-white.

Settings List

[1-Sided/2-Sided Printing]	If [2-sided Printing Only] is displayed, documents will always use 2-sided printing, even if 1-sided printing is specified in the print settings.
[Page Layout]	Displays how many pages of a file will be printed on each sheet of paper. If [No Restrictions] is displayed, you can print with the layout you specify. [1 on 1 Not Available]: Set the layout to 2 to 16 pages per sheet to print. If 1 page per sheet is specified, 2 pages are printed per sheet. If 2 to 16 pages are specified for one sheet, the specified layout is printed. [1-2 on 1 Not Available]: Set the layout to 4 to 16 pages per sheet to print. If 1 or 2 pages per sheet is specified, 4 pages are printed per sheet. If 4 to 16 pages are specified for one sheet, the specified layout is printed.
[Store in Mail Box]	If [Not Available] is displayed, you cannot save files in an inbox (the hard disk of the device), hold print jobs, or execute output methods that are not compatible with AMS.
[Restriction Information Not Obtained]	Click the [Get Restriction Information] button to retrieve the print restriction information for the currently authenticated user.

NOTE

- Page layout restrictions are also applied when performing printing within the restrictions, such as when printing a document with only one page.
- If printing is performed without opening the printer properties dialog box after changing page layout restrictions, printing may be performed using the page layout restrictions before change, depending on the application.

[Check Print Restriction Information When Printing]

Set whether to check the print restrictions each time printing is performed.

If you select [Check Print Restriction Information When Printing], the [Confirmation of Print Restrictions] dialog box is displayed each time you print, enabling you to check the print restriction information.

For information on operating the [Confirmation of Print Restrictions] dialog box, see the following.

[Confirmation of Print Restrictions] Dialog Box(P. 176)

NOTE

- Depending on your environment, the message "The printer requires your attention. Go to the desktop to take care of it." may be displayed when printing from a Windows Store app. If this happens, move to the desktop and follow the instructions in the displayed dialog box.

[IP Address/Host Name] ► [Set IP Address/Host Name] Dialog Box

Displays a dialog box for changing the information of the device used for printing.

Use this when you want to change the IP address/host name of the device used for printing or did not specify the IP address/host name of the device during installation.

[Get IP Address/Host Name]

Automatically retrieves the device information via the printer driver.

 **NOTE**

- The IP address/host name of the device may not be able to be retrieved, depending on the type of printer driver and printer port. In this case, manually set the IP address/host name.
- In order to retrieve the IP address/host name of the device via the printer driver, it is necessary to use the installer of the printer driver to install the Canon Driver Information Assist Service to the print server in advance.

[Device IP Address/Host Name]

Displays the IP address/host name of the device retrieved by clicking the [Get IP Address/Host Name] button. If the IP address/host name could not be retrieved, enter the IP address/host name of the device.

When specifying a link-local unicast address for IPv6, it is necessary to place devices related to this driver in the same network segment. If you want to place them in different segments, specify another unicast address that can communicate or a DNS name.

 **NOTE**

- [IP Address/Host Name] is only enabled when you are logged on to the computer as a user with Windows administrator privileges.
- It may be necessary to specify the IP address/host name of the device again if your environment uses the "Auto Created Printer" function of XenApp.

[Get Restriction Information]

Displays the print restriction information for the currently authenticated user.

[Setup Authentication Server] ► [Setup Authentication Server] Dialog Box

Displays a dialog box for configuring an authentication server.

[Use an Authentication Server in Place of Individual Device Authentication]

Select this to enable the authentication server settings.

[Record Name]

Enter the record name registered in the DNS for the authentication server.

[About AMS]

Displays the version information for AMS.

Dialog Box Displayed When Printing**[Confirm Password for Authentication] Dialog Box**

This dialog box is for entering a password for user authentication.

The [Confirm Password for Authentication] dialog box is displayed in the following cases:

- If you did not select [Save Password and Skip Authentication Dialog Box When Printing] in the [Setup User Names and Passwords for Authentication] dialog box
- If you have not printed for over 30 minutes after being authenticated or after retrieving restriction information

It may take some time for it to be displayed, depending on your environment. Change the settings in the [AMS] sheet > [User Name/Password] > [Setup User Names and Passwords for Authentication] dialog box, as required.

[User Name]

Displays the user name specified in the [Setup User Names and Passwords for Authentication] dialog box.

[Password]

Enter the password for the user displayed in [User Name].

[Authentication]

Displays the location for authentication specified in the [Setup User Names and Passwords for Authentication] dialog box.

[Temporarily Save Password]

If you select this, the [Confirm Password for Authentication] dialog box is not displayed from next time, and you can print without entering a password.

 **NOTE**

- If you do not select [Save Password and Skip Authentication Dialog Box When Printing], the [Confirm Password for Authentication] dialog box is displayed each time you print. However, it is not necessary to enter a password if printing within approximately 30 minutes of the last authentication (if the date and time settings of the device and the computer are synchronized).
- [Temporarily Save Password] is only available when using local device authentication ([This Device] selected for [Setup Method]) and the device is set to allow passwords to be saved.
- To display the [Confirm Password for Authentication] dialog box again, deselect [Save Password and Skip Authentication Dialog Box When Printing] in the [Setup User Names and Passwords for Authentication] dialog box.

[Confirmation of Print Restrictions] Dialog Box

Displays the print restriction information for the currently authenticated user.

The [Confirmation of Print Restrictions] dialog box is displayed when you perform printing if [Check Print Restriction Information When Printing] is selected on the [AMS] sheet.

When printing multiple copy sets, the [Confirmation of Print Restrictions] dialog box may be displayed once for each set for some applications, because multiple copy sets of a document are output as separate print jobs.

It may also take some time for the dialog box to be displayed, depending on your environment.

When printing is performed with settings not allowed by print restrictions, printing will be performed within the range of restrictions, or printing will be canceled.

[Print Restriction Information]

Displays the print restrictions for the user displayed in [Current User Name].

[Color Print]	If [Not Available] is displayed, documents will be printed in black-and-white.
[1-Sided/2-Sided Printing]	If [2-sided Printing Only] is displayed, documents will always use 2-sided printing, even if 1-sided printing is specified in the print settings.
[Page Layout]	Displays how many pages of a file will be printed on each sheet of paper. If [No Restrictions] is displayed, you can print with the layout you specify.

Settings List

[1 on 1 Not Available]	Set the layout to 2 to 16 pages per sheet to print. If 1 page per sheet is specified, 2 pages are printed per sheet. If 2 to 16 pages are specified for one sheet, the specified layout is printed.
[1-2 on 1 Not Available]	Set the layout to 4 to 16 pages per sheet to print. If 1 page per sheet is specified, 4 pages are printed per sheet. If 4 to 16 pages are specified for one sheet, the specified layout is printed.
[Store in Mail Box]	If [Not Available] is displayed, you cannot save files in an inbox (the hard disk of the device), hold print jobs, or execute output methods that are not compatible with AMS.

NOTE

- When printing from a Windows Store app, printing restrictions are not displayed on the print settings screen displayed in the Windows Store app.

[Do Not Show This Dialog Box Again]

If you select [Do Not Show This Dialog Box Again], the [Confirmation of Print Restrictions] dialog box is not displayed from next time you print.

If you want to display [Confirmation of Print Restrictions] dialog box again, enable [Check Print Restriction Information When Printing] on the [AMS] sheet.

[Yes]/[No]

Click the [Yes] button to print with the displayed settings, or the [No] button to cancel printing.

Contact your AMS administrator if the documents are not printed with the displayed settings when you click the [Yes] button.

Related Topics

- ▶ [Enabling the AMS Function\(P. 103\)](#)
- ▶ [Specifying the User Information to Be Used for AMS Authentication\(P. 107\)](#)
- ▶ [Preparing to Print Using AMS\(P. 105\)](#)
- ▶ [Retrieving Print Restriction Information Applied When Using AMS\(P. 110\)](#)
- ▶ [Specifying the Print Output Destination Device Using AMS\(P. 109\)](#)
- ▶ [Configuring an Authentication Server to Be Used in AMS User Authentication\(P. 111\)](#)

[Encrypted-P] Sheet

You can set the information required for the Encrypted Secure Print function.

A dialog box may be displayed when printing for checking the password or editing the job information, depending on the settings.

This explains the items in the [Encrypted-P] sheet and the dialog box displayed when printing.

Descriptions of Settings

Items indicated with an asterisk can only be changed by displaying the [Encrypted-P] sheet as a user with administrator privileges, such as logging on to the computer as a member of Administrators.

[Use Encrypted Secure Print] *

Enable this to use the Encrypted Secure Print function for printing.

[Edit Job Information When Printing] *

Enable this to edit the document name and user name when printing.

When this function is enabled, the [Edit Job Information] dialog box is displayed when printing.

The user name can be edited when changes are allowed in the driver. To edit the user name, click the "Open details" indicated below to allow the user name to be edited.

(1) Select the device to be set in the Windows printer list → display the printer properties screen.

(2) Display the [Device Settings] sheet → check [Other Settings] > [Set User Information].

If [Set User Information] is disabled, the user name can be edited when printing.

If [Set User Information] is enabled, also perform the procedure below.

(3) Click [Set User Information] > [Settings].

(4) In the [User Information Settings] dialog box, click [User Name Management] or [Default Value Settings].

(5) Disable [Do Not Allow User Name Changes] in the displayed dialog box.

[Set Encryption Level] *

Set the encryption level.

The encryption level is automatically set according to your environment when the Encrypted Secure Print function is installed.

[Settings] ► [Encryption Level Settings] Dialog Box

Select the encryption level to set.

Higher encryption level numbers indicate stronger encryption.

[Set Password]

Set the default password to use for encryption.

You can also set whether to check the password when printing.

When using multiple devices, the setting values in the [Password Settings] dialog box will be the same for all devices. Different values cannot be set for each device.

[Settings] ► [Password Settings] Dialog Box**[Password (Default)]**

Enter the password.

The following characters can be used.

0-9 a-z A-Z ! " # \$ % & ' () * + , - . / : ; > = < ? @ [\] ^ _ ` { | } ~ spaces

A maximum of 48 characters (15 alphanumeric characters for some devices) can be specified.

If password requirements are set in the [Encrypted-P] sheet > [Password Requirements], the number and type of characters that can be specified are further restricted.

[Do Not Display Password Dialog When Printing]

Prevents the [Settings of Encrypted Secure Print Password] dialog box from being displayed when printing.

In this case, the password set in [Password (Default)] is used.

[Password Requirements] * ► [Password Requirements] Dialog Box

In order to enhance security, set the password requirements used for encryption.

You can set a minimum number of characters required for passwords and whether both letters and numbers can be included.

[About Encrypted-P]

Displays information regarding the version of the Encrypted Secure Print function you are using.

Dialog Box Displayed When Printing**[Edit Job Information] Dialog Box**

Enter the name of the document to print and the name of the user executing printing. The names specified here are displayed on the device.

The number and type of characters that can be used differs according to the device. Enter the name within the range displayed next to [Document Name] or [User Name].

The user name can be edited when changes are allowed in the driver. If the user name cannot be edited, the name set in the driver is displayed in [User Name].

[Settings of Encrypted Secure Print Password] Dialog Box

Enter the password for encrypting the print data.

The following characters can be used.

0-9 a-z A-Z ! " # \$ % & ' () * + , - . / : ; > = < ? @ [\] ^ _ ` { | } ~ spaces

A maximum of 48 characters (15 alphanumeric characters for some devices) can be specified.

When password requirements are set in the [Encrypted-P] sheet > [Password Requirements], enter a password that meets the requirements.

Related Topics

- ◉ **Enabling the Encrypted Secure Print Function(P. 113)**
- ◉ **Enhancing the Security of the Encrypted Secure Print Function(P. 116)**

▶ **Printing Using the Encrypted Secure Print Function(P. 118)**

Canon PageComposer

You can combine multiple files created with different applications into one file for printing.

The Canon PageComposer main screen opens when you print using the [Edit and Preview] function of the driver.

[File] Menu

[Print]/[] (Print)

Prints the selected file(s).

[Print Sample]/[] (Print Sample)

Performs proof printing of the selected file(s).

[Print Preview]/[] (Print Preview)

Displays a print preview of the selected file.

[Exit]

Closes the Canon PageComposer main screen.

[Edit] Menu

[Delete]/[] (Delete Document)

Deletes the selected file(s).

[Duplicate]/[] (Duplicate Document)

Duplicates the selected file(s).

[Combine]/[] (Combine Documents) > [Combine] Dialog Box

Combines the selected multiple files into one, and enables you to specify a name and configure the settings of the combined file.

Displays the current settings for each page as thumbnail images.

[Document Name]

Sets the name of the combined file.

[Delete]

Deletes the selected page.

[Print Preview]

Displays a print preview of the selected page.

[Document List] Sheet

Changes the order of files in the combined file or deletes a file from the combined file.

[Print Settings] Sheet

Changes the print settings of the combined file. When unifying the output size settings, select [Output Size Consistency]. When unifying the page layout settings, select [Layout Consistency].

If you want to specify detailed settings in the print settings screen of the driver, click [Details].

[Separate]/[] (Separate Documents)

Separates the selected file you have combined.

[Change Print Settings]/[] (Change Print Settings) > [Change Print Settings] Dialog Box

Changes the name and settings of the selected file.

Displays the current settings for each page as thumbnail images.

[Document Name]

Sets the name of the file.

[Delete]

Deletes the selected page.

[Print Preview]

Displays a print preview of the selected page.

[Document List] Sheet

Changes the order of files when combining multiple files or deletes a file from the combined file.

[Print Settings] Sheet

Changes the print settings of the file.

[Copies]

Specifies the number of copies to be printed.

[Print Style]

Specifies a method for outputting print data.

[Staple]

Outputs the pages stapled together.

[Saddle Stitch]

Prints a booklet folded in half and stapled in the middle.

[Output Size Consistency]

Enables you to use the paper of the same size selected from the drop-down list box for a combined file consisting of files with different page sizes.

[Layout Consistency]

Enables you to set a single layout selected from the drop-down list box for a combined file consisting of files with different layout.

[Page Order]

Specifies the page order to print.

[Print Next Document from]

Enables you to set where to start printing the next file from when combining files.

[Details]

Enables you to specify detailed settings in the print settings screen of the driver.

[Select All]

Selects all files in the list.

[Move to] Menu

[Top]/[Previous]/[Next]/[Last]



Allows you to change the order by moving the selected file(s).

[Help] Menu

[Help]

Displays the online help.

[About]

Displays the version of Canon PageComposer.

Related Topics

- ▶ **About the [Edit and Preview] Function(P. 54)**
- ▶ **Printing Files Together(P. 55)**
- ▶ **Checking the Print Preview(P. 57)**
- ▶ **Changing the Print Settings of the Combined File(P. 59)**

Troubleshooting

Troubleshooting	185
Driver settings cannot be set	186
Print results are unsatisfactory	187
Printing takes a long time	189
Print results are too dark or too bright	190
Overlay printing will not execute	191
Cannot use the acquire device information function or authentication function	193
Causes and Remedies for Access Management System Error Messages	195
Cannot execute the Encrypted Secure Print function	202
Cannot print with the specified method using Encrypted Secure Print	203

Troubleshooting

This explains solutions to common problems.

- ▶ **Driver settings cannot be set(P. 186)**
- ▶ **Print results are unsatisfactory(P. 187)**
- ▶ **Printing takes a long time(P. 189)**
- ▶ **Print results are too dark or too bright(P. 190)**
- ▶ **Overlay printing will not execute(P. 191)**
- ▶ **Cannot use the acquire device information function or authentication function(P. 193)**
- ▶ **Causes and Remedies for Access Management System Error Messages(P. 195)**
- ▶ **Cannot execute the Encrypted Secure Print function(P. 202)**
- ▶ **Cannot print with the specified method using Encrypted Secure Print(P. 203)**

Driver settings cannot be set

Page size, orientation, paper selection settings are not valid

Cause

Depending on the application you are using, the settings corresponding to these in the application are given priority over the driver settings.

Remedy

Configure these settings in the application.

The [Device Settings] and [Profile] sheets can be displayed, but settings are unavailable

Cause

Your account does not have full control permission for the printer.

Remedy

Logon to the computer as a member of Administrators. Contact your system administrator for further information.

The functions supported by the device are not displayed or cannot be set in the [Device Settings] sheet

Cause

The appropriate configuration profile has not been set.

Remedy

Acquire the device information and set the configuration profile that matches the printer model you are using. If device information cannot be acquired, manually set a configuration profile that matches the name of the printer model.

If you cannot properly set items displayed in the [Device Settings] sheet even after applying a configuration profile that matches the name of the printer model, you can apply the function and option information corresponding to the device by setting a configuration profile type.

- ▶ **About Configuration Profile Type Settings(P. 92)**

Related Topics

- ▶ **Printing from a Computer(P. 17)**
- ▶ **[Device Settings] Sheet(P. 165)**

Print results are unsatisfactory

Page layout is not correct

If the printing area on the page is not positioned correctly, or if part of the printed area is missing, check the following.

Cause 1.

Print data is not set in the printable area.

Remedy

Confirm the printable area of the device, and correct the print data in the application you are using.

Cause 2.

The [Output Size] settings in the [Basic Settings], [Page Setup], or [Exceptional Settings] sheet does not match the actual size of the paper loaded in the device.

Remedy

Confirm that the [Output Size] setting matches the size of the paper in the device.

Cause 3.

The magnification ratio is not set properly for the print data.

Remedy

Change the settings in the [Basic Settings] or [Page Setup] sheet > [Manual Scaling] > [Scaling].

Cause 4.

The gutter setting is too large, so that there is not enough space on the page for the printout.

Remedy

Change the settings in the [Finishing] sheet > [Gutter].

Part of the printout does not match what you see on the screen

Cause

The application uses EMF format data which cannot be processed by page printers.

Remedy

In the [Finishing] sheet, click [Advanced Settings], and then select [Off] from [EMF Spooling].

Settings are not reflected in the print results

Cause

Functions that cannot be enabled at the same time are set in the application and driver.

Remedy

The settings may be able to be reflected in the results by setting them in the driver only.

Related Topics

- ▶ [\[Basic Settings\] Sheet\(P. 126\)](#)
- ▶ [\[Page Setup\] Sheet\(P. 129\)](#)
- ▶ [\[Finishing\] Sheet\(P. 132\)](#)

Printing takes a long time

Cause

The application uses EMF format data which cannot be processed by page printers.

Remedy

In the [Finishing] sheet, click [Advanced Settings], and then select [Off] from [EMF Spooling].

Related Topics

▶ [\[Finishing\] Sheet\(P. 132\)](#)

Print results are too dark or too bright

Cause

The colors on the computer monitor and in the print results differ because their color representation methods differ.

Remedy 1.

For the UFR II/LIPSLX/LIPS4/PCL6 driver, change the color settings according to the following procedure.

- (1) Display the [Quality] sheet.
- (2) Select [Manual Color Settings] or [Manual Grayscale Settings] → click [Color Settings] or [Grayscale Settings].
- (3) In the [Color Adjustment] or [Grayscale Adjustment] sheet, adjust the brightness with the slide bar.

Remedy 2.

For the PS3 driver, change the color settings according to the following procedure.

- (1) Display the [Color] sheet → Click [Details].
- (2) Select [Brightness] in the [Detailed Settings] dialog box → adjust the brightness using the slider bar.

Related Topics

- ▶ [Quality] Sheet (UFR II/LIPSLX/LIPS4/PCL6)(P. 145)
- ▶ [Color] Sheet (PS3)(P. 157)

Overlay printing will not execute

Cannot perform overlay printing

Cause 1.

The resolution of the print data differs from that of the form file.

Remedy 1.

For the UFR II/LIPSLX/LIPS4/PCL6 driver, change the resolution according to the following procedure.

- (1) Display the [Quality] sheet.
- (2) Click [Advanced Settings] → select [Resolution].
- (3) For [Resolution], set the same resolution as that of the form file.

Remedy 2.

For the PS3 driver, change the resolution according to the following procedure.

- (1) Display the [Quality] sheet.
- (2) For [Resolution], set the same resolution as that of the form file.

Cause 2.

[Black and White] has been specified for [Color Mode] and a form produced in color has been set.

Remedy

Change [Color Mode] in the [Basic Settings] sheet to [Color].

Cannot use previously stored overlay form

Cause

The overlay print settings are not configured correctly.

Remedy

Check the settings according to the following procedure.

- (1) Display the [Page Setup] sheet.
- (2) Click [Page Options].
- (3) In the displayed dialog box, display the [Overlay] sheet.
- (4) Confirm that [Processing Method] > [Use Overlay Printing] is selected.

Related Topics

- ▶ [Quality] Sheet (UFR II/LIPSLX/LIPS4/PCL6)(P. 145)
- ▶ [Quality] Sheet (PS3)(P. 152)
- ▶ [Basic Settings] Sheet(P. 126)

▶ **[Page Setup] Sheet(P. 129)**

Cannot use the acquire device information function or authentication function

If you cannot acquire the device information, or cannot use the department ID management function or the user authentication function, check the following.

Cause 1.

The device is turned off, or the cable is not plugged in properly.

Remedy

Check the status of the device.

Cause 2.

The settings for your connection environment have not been configured correctly.

Remedy

Confirm the printable area of the device, and correct the print data in the application you are using.

In a print server environment

- Install the Canon Driver Information Assist Service in the server computer using the driver installer.
- Install TCP/IP as a protocol in your environment from the CD-ROM for the operating system you are using.

When the device is connected in a USB connection or port connection environment

You cannot use the acquire device information, department ID management, and user authentication functions. Also, you cannot use them in the following port connection environments:

- An environment in which the computer is directly connected to the device using the SMB function
- An environment in which [Enable printer pooling] in the [Ports] sheet of the printer properties screen of Windows * is enabled

Use another connection environment such as a TCP/IP network connection environment for the acquire device information, department ID management, and user authentication functions.

However, the functions may be able to be used via a USB connection, depending on the device or driver you are using.

Cause 3.

The name of the device is too long.

Remedy

Confirm that the name of the device registered in the printer list of Windows does not exceed the following number of characters.

- Device name: within 209 characters
- Share name: within 260 characters

If it exceeds the above numbers, change the name in the [General] or [Sharing] sheet of the Windows printer properties screen *.

* The Windows printer properties screen can be displayed by either one of the following procedures.

If displaying from [ Settings] in the Start menu

- (1) Display [Bluetooth & devices] (or [Devices]).
- (2) In [Printers & scanners], display the management screen for the device to set.
To display the management screen, click the device or click [Manage] for the corresponding device.
- (3) Click [Printer properties] for the device to set.

If displaying from [Control Panel]

- (1) Display [Devices and Printers].
- (2) From the printer list, right-click the device to be set → select [Printer properties] from the displayed menu.

Causes and Remedies for Access Management System Error Messages

This section describes the causes and remedies for error messages which are displayed when using AMS.

The output may differ from the specified print settings, or the print job may be canceled because the following settings are in conflict with the print restrictions.

<Control Names>

Cause	A value specified by the user exceeds the value set for the print restrictions.
Remedy	Check the value set for the print restrictions. If the print job was canceled, specify the value again so that it does not exceed the value set for the print restrictions, and perform printing again. To check the values set for the print restrictions, click the [Get Restriction Information] button on the [AMS] page of the printer properties dialog box.

Could not obtain restriction information because the device is not responding. Make sure that the device is turned on and try to obtain the information again later. If the same error occurs, contact the administrator for details.

Cause	Could not communicate with the device for an unspecified reason. There may be a problem with the communication environment, such as the network settings or network connection.
Remedy	Try retrieving the restriction information again after confirming that the power of the device is turned ON and the LAN cable, etc., is connected correctly. If you still cannot retrieve the information, contact the AMS administrator.

Could not obtain restriction information.

Cause	There may be a problem with the communication environment, such as the network settings or connection status.
Remedy	After confirming the network settings, try retrieving the restriction information again. If the restriction information cannot be retrieved, contact your AMS administrator.

The version of this add-in does not match the obtained restriction information.

Cause	The restriction information retrieved from the installed add-in is not supported.
Remedy	Check the version of the add-in and the restriction information. To check the version of the add-in, click the [About AMS] button on the [AMS] page of the printer properties dialog box.

The print restrictions have been updated. Try to print again.

Cause	When print restriction information set in the AMS server has been updated.
Remedy	Check the value set for the print restrictions, and try printing again. To check the value set for the print restrictions, click the [Get Restriction Information] button on the [AMS] page of the printer properties dialog box.

Printing will be canceled because the following settings are in conflict with the print restrictions.

<Control Names>

Cause	In the print settings of the printer, settings that cannot be used in conjunction with the print restrictions set in the restriction information are set.
Remedy	Confirm the print restrictions, and try printing again. To check the value set for the print restrictions, click the [Get Restriction Information] button on the [AMS] page of the printer properties dialog box.

**You do not have privileges to print using this device.
Select a different printer.**

Cause	You do not have the privileges to print from the selected device.
Remedy	Get the device restriction administrator to assign privileges to print from the selected device to you, or select another device to print from.

**Cannot set to [Store] because [Store in Mail Box] is set to [Not Available].
Printing will be canceled.**

Cause	[Store] is specified as the output method for printing. [Store in Mail Box] is not allowed in the print restrictions.
Remedy	Cancel the Store mode. Alternatively, contact the device restriction administrator.

The output may differ from the specified print settings because the following settings are in conflict with the print restrictions.

<Control Names>

Cause	A value specified by the user exceeds the value set for the print restrictions. However, this message is displayed if a setting that cannot be used in conjunction with a compatible printer exceeds the print restriction.
Remedy	Check the value set for the print restrictions. To check the value set for the print restrictions, click the [Get Restriction Information] button on the [AMS] page of the printer properties dialog box.

**Cannot print with booklet settings because [Page Layout] is set to [1-2 on 1 Not Available].
Change the settings and try again.**

Cause	Cannot perform booklet printing because of page layout restrictions.
Remedy	Cancel booklet printing. Alternatively, contact the device restriction administrator.

**Cannot print in poster layout because [Page Layout] is set to [1 on 1 Not Available] or [1-2 on 1 Not Available].
Change the settings and try again.**

Cause	Cannot perform poster printing because of page layout restrictions.
-------	---------------------------------------------------------------------

Remedy	Cancel poster printing. Alternatively, contact the device restriction administrator.
--------	--------------------------------------------------------------------------------------

Cannot print in poster layout because [1-Sided/2-Sided Printing] is set to [2-sided Printing Only].

Change the settings and try again.

Cause	Cannot perform poster printing because of the print restrictions.
Remedy	Cancel poster printing. Alternatively, contact the device restriction administrator.

Cannot set to [Store] because [Store in Mail Box] is set to [Not Available].

Change the settings and try again.

Cause	[Store] is specified as the output method for printing. [Store in Mail Box] is not allowed in the print restrictions.
Remedy	Cancel the Store mode. Alternatively, contact the device restriction administrator.

Cannot print with booklet settings because [Page Layout] is set to [1-2 on 1 Not Available].

Printing will be canceled.

Cause	Cannot perform booklet printing because of page layout restrictions.
Remedy	Cancel booklet printing. Alternatively, contact the device restriction administrator.

Cannot print in poster layout because [Page Layout] is set to [1 on 1 Not Available] or [1-2 on 1 Not Available].

Printing will be canceled.

Cause	Cannot perform poster printing because of page layout restrictions.
Remedy	Cancel poster printing. Alternatively, contact the device restriction administrator.

Cannot print in poster layout because [1-Sided/2-Sided Printing] is set to [2-sided Printing Only].

Printing will be canceled.

Cause	Cannot perform poster printing because of the print restrictions.
Remedy	Cancel poster printing. Alternatively, contact the device restriction administrator.

Cannot create a form file or use overlay printing.

Printing will be canceled.

Cause	Overlay printing or form file creation is specified in the print settings. Overlay printing or form file creation cannot be used.
Remedy	Cancel overlay printing or form file creation. Alternatively, contact the device restriction administrator.

Cannot obtain the device IP Address or host name.

Contact the administrator for details.

Cause	Could not retrieve the IP address/host name of the device.
Remedy	If a user with Windows administrator privileges is logged in, specify the IP address/host name of the device in the [Set IP Address/Host Name] dialog box. If the setting cannot be specified, contact your AMS administrator.

**Cannot obtain restriction information because network settings are incorrect.
Contact the administrator for details.**

Cause	The IP address/host name set in the Access Management System Printer Driver Add-in is incorrect, or there is a problem in the network settings.
Remedy	Check the IP address/host name settings in the [Set IP Address/Host Name] dialog box and the network settings, and retrieve the restriction information again. If you still cannot retrieve the information, contact the AMS administrator.

**Cannot create a form file or use overlay printing.
Change the settings.**

Cause	Overlay printing or form file creation is specified in the print settings. Overlay printing or form file creation cannot be used.
Remedy	Cancel overlay printing or form file creation, or contact your device restriction administrator.

**Cannot obtain restriction information because network settings are incorrect.
Contact the administrator for details.
Printing will be canceled.**

Cause	The IP address/host name set in the Access Management System Printer Driver Add-in is incorrect, or there is a problem in the network settings.
Remedy	Check the IP address/host name settings in the [Set IP Address/Host Name] dialog box and the network settings, and try printing again. If you still cannot print, contact the AMS administrator.

**Could not obtain restriction information because the device is not responding.
Printing will be canceled.
Make sure that the device is turned on and try to print again later.
If the same error occurs, contact the administrator for details.**

Cause	Could not communicate with the device for an unspecified reason. There may be a problem with the communication environment, such as the network settings or network connection.
Remedy	Try printing again after confirming that the power of the device is turned ON and the LAN cable, etc., is connected correctly. If you still cannot print, contact the AMS administrator.

**Cannot print with perfect binding settings because [Page Layout] is set to [1 on 1 Not Available] or [1-2 on 1 Not Available].
Change the settings and try again.**

Cause	Cannot print with the Perfect Binding mode because of page layout restrictions.
-------	---------------------------------------------------------------------------------

Remedy	Cancel the Perfect Binding mode. Alternatively, contact the device restriction administrator.
--------	-----------------------------------------------------------------------------------------------

**Cannot print with perfect binding settings because [Page Layout] is set to [1 on 1 Not Available] or [1-2 on 1 Not Available].
Printing will be canceled.**

Cause	Cannot print with the Perfect Binding mode because of page layout restrictions.
Remedy	Cancel the Perfect Binding mode. Alternatively, contact the device restriction administrator.

Could not set the user information.

Cause	User information could not be retrieved, for an unspecified reason.
Remedy	Try retrieving the user information again after waiting a while. If you still cannot set the user information, contact the AMS administrator.

Could not obtain the device IP address or the host name.

Cause	Could not retrieve the IP address/host name of the device.
Remedy	Enter the IP address/host name in the [Device IP Address/Host Name] text box.

**Cannot set to [Hold] because [Store in Mail Box] is set to [Not Available].
Printing will be canceled.**

Cause	[Hold] is specified as the output method for printing. [Store in Mail Box] is not allowed in the print restrictions.
Remedy	Cancel the Hold mode. Alternatively, contact the device restriction administrator.

**Cannot set the output method as selected because [Store in Mail Box] is set to [Not Available].
Printing will be canceled.**

Cause	[Store] or [Hold] is specified as the output method for printing. [Store in Mail Box] is not allowed in the print restrictions.
Remedy	Deselect the Store or Hold mode. Alternatively, contact the device restriction administrator.

**Cannot set to [Hold] because [Store in Mail Box] is set to [Not Available].
Change the settings and try again.**

Cause	[Hold] is specified as the output method for printing. [Store in Mail Box] is not allowed in the print restrictions.
Remedy	Cancel the Hold mode. Alternatively, contact the device restriction administrator.

Cannot set the output method as selected because [Store in Mail Box] is set to [Not Available].

Change the settings and try again.

Cause	[Store] or [Hold] is specified as the output method for printing. [Store in Mail Box] is not allowed in the print restrictions.
Remedy	Deselect the Store or Hold mode. Alternatively, contact the device restriction administrator.

**The [Device IP Address/Host Name] has not been entered.
Enter the [Device IP Address/Host Name].**

Cause	[OK] was clicked without specifying [Device IP Address/Host Name].
Remedy	Specify [Device IP Address/Host Name] before clicking [OK].

**Could not set the user information because the network settings are incorrect.
Contact the administrator for details.**

Cause	The IP address/host name set in the Access Management System Printer Driver Add-in is incorrect, or there is a problem in the network settings.
Remedy	Check the IP address/host name settings in the [Set IP Address/Host Name] dialog box and the network settings, and retrieve the user information again. If you still cannot retrieve the information, contact the AMS administrator.

**Could not set the user information because the device is not responding.
Make sure that the device is turned on and try to set the information again later.
If the same error occurs, contact the administrator for details.**

Cause	Could not communicate with the device for an unspecified reason. There may be a problem with the communication environment, such as the network settings or network connection.
Remedy	Try setting the user information again after confirming that the power of the device is turned ON and the LAN cable, etc., is connected correctly. If you still cannot set the user information, contact the AMS administrator.

**Characters that cannot be used have been entered for the Domain Name
[Authentication]. Check the entered characters.**

Cause	If you are using local device authentication, an authentication server other than [This Device] is selected in [Authentication]. If you are using Active Directory authentication, invalid characters are used in the domain name entered in [Authentication].
Remedy	If you are using local device authentication, select [This Device] in [Authentication]. If you are using Active Directory authentication, confirm and enter the correct domain name.

**The set user information and obtained restriction information do not match.
Set the user information again.
For Domain Authentication,
enter the NetBIOS domain name in [Authentication].**

Cause	The user information set for the Access Management System Printer Driver Add-in and the user information set in the retrieved restriction information does not match.
-------	-----------------------------------------------------------------------------------------------------------------------------------------------------------------------

Remedy	Check the user information specified in the [Setup User Names and Passwords for Authentication] dialog box. Select [This Device] in [Authentication] for local device authentication. Select the NetBIOS domain name for Active Directory authentication.
--------	-----------------------------------------------------------------------------------------------------------------------------------------------------------------------------------------------------------------------------------------------------------

**The set user information and obtained restriction information do not match.
Set the user information again.**

Cause	The user information set for the Access Management System Printer Driver Add-in and the user information set in the retrieved restriction information does not match.
Remedy	Check the user information specified in the [Setup User Names and Passwords for Authentication] dialog box. Select [This Device] in [Authentication] for local device authentication. Select the NetBIOS domain name for Active Directory authentication.

**The set user information and obtained restriction information do not match.
Printing will be canceled.**

Cause	The user information set for the Access Management System Printer Driver Add-in and the user information set in the retrieved restriction information does not match.
Remedy	Check the user information specified in the [Setup User Names and Passwords for Authentication] dialog box. Select [This Device] in [Authentication] for local device authentication. Select the NetBIOS domain name for Active Directory authentication.

**The account is locked out.
Try to authenticate the account later, or contact the administrator for details.**

Cause	The user account that is used for authentication in the [Setup User Names and Passwords for Authentication] dialog box is locked out.
Remedy	Try to authenticate again after waiting a while. If you still cannot authenticate, contact the device restriction administrator.

**Could not obtain restriction information because the account is locked out.
Try to obtain it later, or contact the administrator for details.**

Cause	The user account that is used for authentication to obtain restriction information is locked out.
Remedy	Try to authenticate again after waiting a while. If you still cannot obtain restriction information, contact the device restriction administrator.

**Could not obtain restriction information because the account is locked out. Printing will be canceled.
Try to print later, or contact the administrator for details.**

Cause	The user account that is used for authentication for printing is locked out.
Remedy	Try to print again after waiting a while. If you still cannot print, contact the device restriction administrator.

Cannot execute the Encrypted Secure Print function

If you cannot use the Encrypted Secure Print function, it could be due to a number of causes. Enable printing by referring to each "Remedy."

Cause 1.

Invalid characters have been entered for the password.

Remedy

Enter only valid characters for the password. The following characters can be used.

0-9 a-z A-Z ! " # \$ % & ' () * + , - . / : ; > = < ? @ [\] ^ _ ` { | } ~ spaces

The password can be specified in the [Encrypted-P] sheet > [Set Password] > [Settings] or the [Settings of Encrypted Secure Print Password] dialog box displayed when printing.

Cause 2.

A password that does not meet the requirements has been entered.

Remedy

If password requirements are set, enter a password that meets the requirements.

The password requirements can be checked in the [Encrypted-P] sheet > [Password Requirements].

Cause 3.

The document name or user name has not been entered in the [Edit Job Information] dialog box displayed when printing.

Remedy

Enter both the document name and user name in the [Edit Job Information].

To prevent the document name and user name from being edited when printing, disable the [Encrypted-P] sheet > [Edit Job Information When Printing].

Related Topics

- ▶ [Encrypted-P] Sheet(P. 178)
- ▶ [Settings of Encrypted Secure Print Password] Dialog Box(P. 179)
- ▶ [Edit Job Information] Dialog Box(P. 179)

Cannot print with the specified method using Encrypted Secure Print

You may not be able to use the Encrypted Secure Print function, depending on the driver settings. Enable printing by referring to each "Remedy."

Cause 1.

Form file creation is set for overlay printing in the print settings of the driver.

Remedy

In order to print using the Encrypted Secure Print function, follow the procedure below to disable form file creation.

- (1) Display the driver print settings screen.
- (2) Display the [Page Setup] sheet.
- (3) Click [Page Options] → display the [Overlay] sheet in the displayed dialog box.
- (4) In [Processing Method], select an option other than [Create a Form File] → click [OK].

Cause 2.

An output method that cannot be used with the Encrypted Secure Print function has been specified in the print settings of the driver.

Remedy

In order to print using the Encrypted Secure Print function, do not specify the following output methods in the print settings of the driver.

[Hold]/[Secure Print]/[Store]/[Scheduled Print]

Follow the procedure below to check the output method for the print settings configured in the driver.

- (1) Display any sheet on the driver print settings screen.
- (2) Refer to [Output Method] on the top of the sheet.

This Font Software is licensed under the SIL Open Font License, Version 1.1.

This license is copied below, and is also available with a FAQ at: <http://scripts.sil.org/OFL>

SIL OPEN FONT LICENSE Version 1.1 - 26 February 2007

PREAMBLE

The goals of the Open Font License (OFL) are to stimulate worldwide development of collaborative font projects, to support the font creation efforts of academic and linguistic communities, and to provide a free and open framework in which fonts may be shared and improved in partnership with others.

The OFL allows the licensed fonts to be used, studied, modified and redistributed freely as long as they are not sold by themselves. The fonts, including any derivative works, can be bundled, embedded, redistributed and/or sold with any software provided that any reserved names are not used by derivative works. The fonts and derivatives, however, cannot be released under any other type of license. The requirement for fonts to remain under this license does not apply to any document created using the fonts or their derivatives.

DEFINITIONS

"Font Software" refers to the set of files released by the Copyright Holder(s) under this license and clearly marked as such. This may include source files, build scripts and documentation.

"Reserved Font Name" refers to any names specified as such after the copyright statement(s).

"Original Version" refers to the collection of Font Software components as distributed by the Copyright Holder(s).

"Modified Version" refers to any derivative made by adding to, deleting, or substituting -- in part or in whole -- any of the components of the Original Version, by changing formats or by porting the Font Software to a new environment.

"Author" refers to any designer, engineer, programmer, technical writer or other person who contributed to the Font Software.

PERMISSION & CONDITIONS

Permission is hereby granted, free of charge, to any person obtaining a copy of the Font Software, to use, study, copy, merge, embed, modify, redistribute, and sell modified and unmodified copies of the Font Software, subject to the following conditions:

- 1) Neither the Font Software nor any of its individual components, in Original or Modified Versions, may be sold by itself.
- 2) Original or Modified Versions of the Font Software may be bundled, redistributed and/or sold with any software, provided that each copy contains the above copyright notice and this license. These can be included either as stand-alone text files, human-readable headers or in the appropriate machine-readable metadata fields within text or binary files as long as those fields can be easily viewed by the user.
- 3) No Modified Version of the Font Software may use the Reserved Font Name(s) unless explicit written permission is granted by the corresponding Copyright Holder. This restriction only applies to the primary font name as presented to the users.
- 4) The name(s) of the Copyright Holder(s) or the Author(s) of the Font Software shall not be used to promote, endorse or advertise any Modified Version, except to acknowledge the contribution(s) of the Copyright Holder(s) and the Author(s) or with their explicit written permission.
- 5) The Font Software, modified or unmodified, in part or in whole, must be distributed entirely under this license, and must not be distributed under any other license. The requirement for fonts to remain under this license does not apply to any document created using the Font Software.

TERMINATION

This license becomes null and void if any of the above conditions are not met.

DISCLAIMER

THE FONT SOFTWARE IS PROVIDED "AS IS", WITHOUT WARRANTY OF ANY KIND, EXPRESS OR IMPLIED, INCLUDING BUT NOT LIMITED TO ANY WARRANTIES OF MERCHANTABILITY, FITNESS FOR A PARTICULAR PURPOSE AND NONINFRINGEMENT OF COPYRIGHT, PATENT, TRADEMARK, OR OTHER RIGHT. IN NO EVENT SHALL THE COPYRIGHT HOLDER BE LIABLE FOR ANY CLAIM, DAMAGES OR OTHER LIABILITY, INCLUDING ANY GENERAL, SPECIAL, INDIRECT, INCIDENTAL, OR CONSEQUENTIAL DAMAGES, WHETHER IN AN ACTION OF CONTRACT, TORT OR OTHERWISE, ARISING FROM, OUT OF THE USE OR INABILITY TO USE THE FONT SOFTWARE OR FROM OTHER DEALINGS IN THE FONT SOFTWARE.