

Canon

TR7600 series

Getting Started

Démarrage

Online Setup Configuration en ligne

Detailed instructions and videos are available on the Canon website.

Des instructions détaillées et des vidéos sont disponibles sur le site Web de Canon.

.....

Setup a Computer

Configurer un ordinateur



<https://ij.start.canon>

Setup a Smartphone

Configurer un smartphone



Read **Safety and Important Information** (addendum) first.

Commencez par lire **Sécurité et informations importantes** (addendum).



QT63771V01



Installing the Printer.....page 1

Installation de l'imprimante.....page 1



Connecting to a Computer, Smartphone or Tablet.....page 6

Connexion à un ordinateur, un smartphone ou une tablette.....page 6

Holding the Printer

Manipulation de l'imprimante

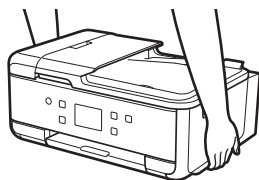

Instructional Videos

Instructions vidéo



3. XXXXXXXXXXXXXXXXXXXX



Setting Up the Printer

 **Online Setup**
<https://ij.start.canon> 

1. Box Contents

- Ink Tanks for setup

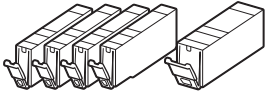

- Power Cord
- Phone Cable
- Setup CD-ROM
- Safety and Important Information
- Getting Started (this manual)

2. Removing Packing Materials



- 1 Remove and dispose of any protective film and orange tape.
 - Using the printer with orange tape or protective film still attached, may cause the printer to malfunction.
- 2 Open the scanning unit / cover and remove the orange tape.

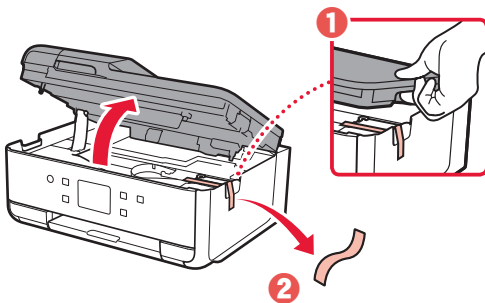

- 3 Close the scanning unit / cover.

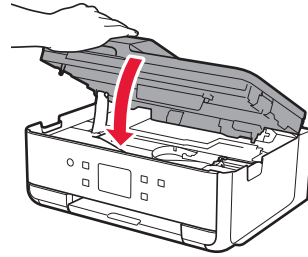

▲ Caution
Watch your fingers.

3. Turning on the Printer



- 1 Connect the power cord.
 - The plug is set at an angle.

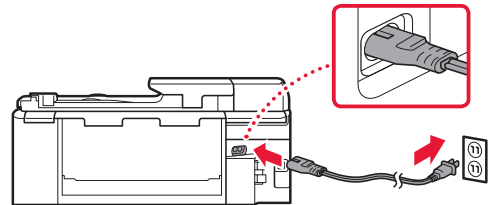

Back

- 2 Open the operation panel and press the **ON** button.

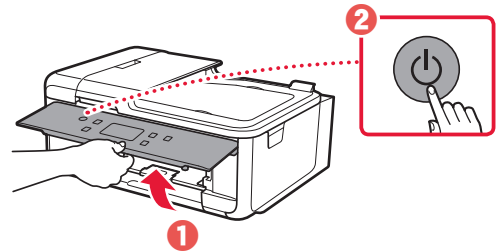

Setting Up the Printer

- 3 Scroll and tap to select your language, and then tap **Yes**.

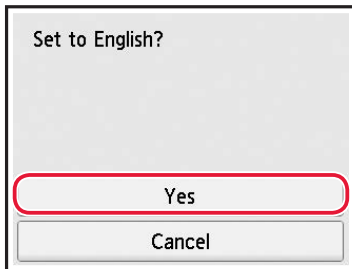
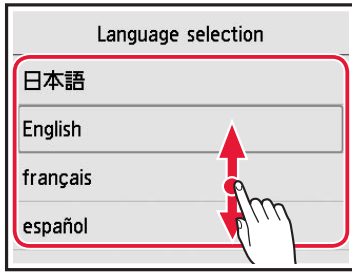

- 4 If the following screen appears, tap your country or region to select.

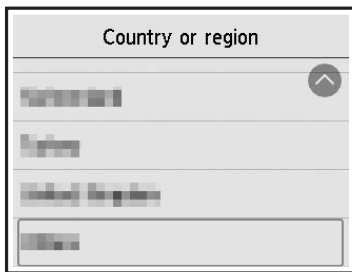

- 5 Tap **OK**.

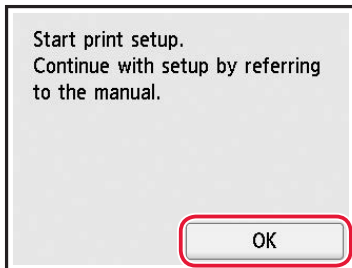

4. Installing the Ink Tanks



- 1 Open the scanning unit / cover.

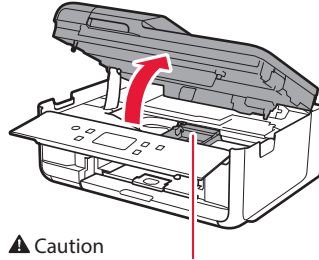

▲ Caution

Do not touch the print head holder until it stops moving.

- 2 Remove the tape and film on the ink tank.

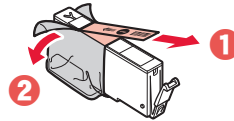

- Check that no tape or film is left.

- 3 Slowly remove the orange cap.

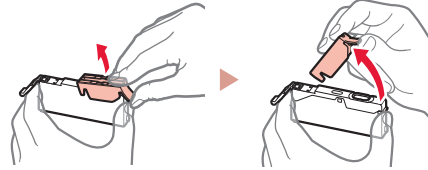

▶▶▶ Important

- Do not squeeze the ink tank with the Y-shaped air hole blocked.

- Do not touch the areas shown in red.

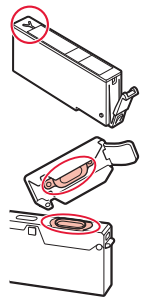

4 Install the ink tank.

- Insert the ink tank into the print head and press down until it clicks.

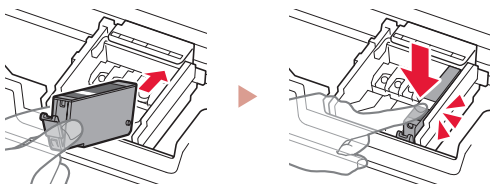

5 Check that the color of the ink tank you installed appears on the screen.

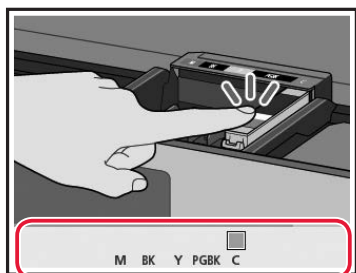

Important

If the color is not displayed on the screen even though you have installed the ink tank, the color of the ink tank may be wrong or you may have installed an ink tank, such as one with a different model number, that is not supported by this printer. Either install an ink tank for the correct color or use the provided ink tank for setup.

6 Repeat steps 2 through 5 to install all the ink tanks.

- Check that all the colors appear.

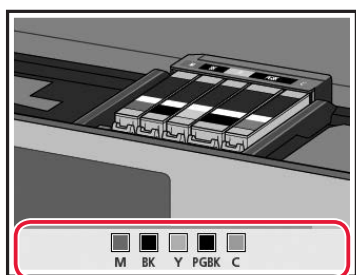

7 Close the scanning unit / cover.

- The printer will start initializing.

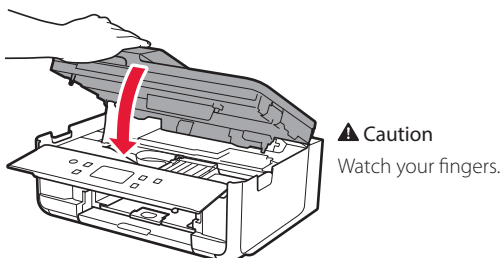

5. Loading Paper



1 Tap OK.

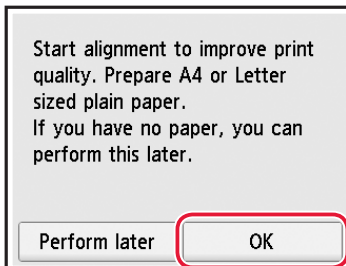

2 Remove the cassette from the printer.

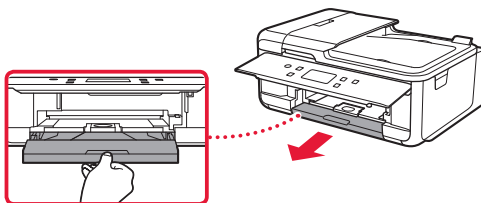

3 Remove the cassette cover.

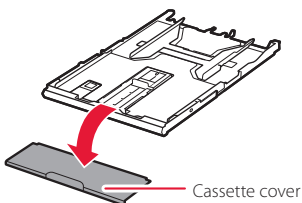

4 Slide apart the paper guides.

- Slide the right paper guide to the right edge. Align the front paper guide with the Letter mark.

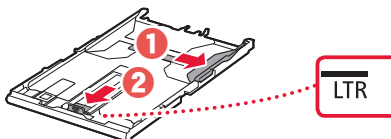

Setting Up the Printer

5 Load Letter sized plain paper.

- Place the paper against the front paper guide, and align the right paper guide to the width of the paper.

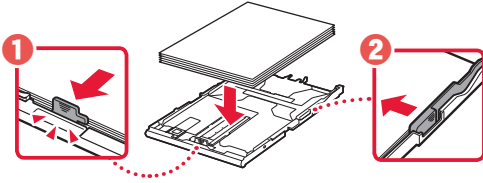

6 Attach the cassette cover and replace the cassette.

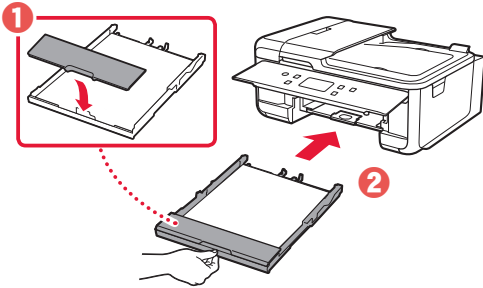

7 Pull out the paper output tray.

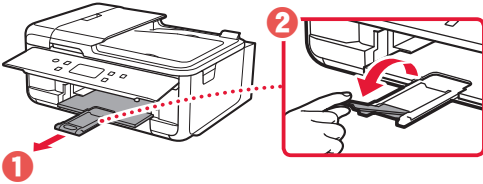

6. Aligning Print Head



1 Tap **OK**.

Ready to perform alignment to improve print quality.
Load a sheet of A4 or Letter sized plain paper in the cassette and tap [OK].

How to set

OK

- The Print Head Alignment pattern starts printing.

2 Check that the pattern is printed.

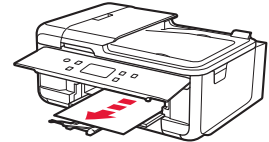
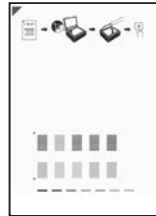

Printed Print Head Alignment pattern

3 Place the pattern on the platen.

- Open the document cover and place the print side facing down.

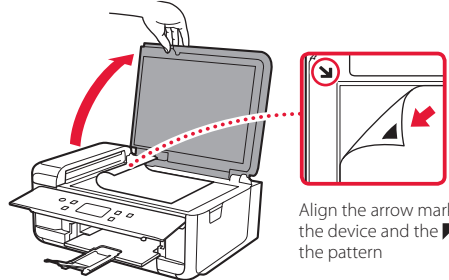

Align the arrow mark on the device and the  on the pattern

4 Close the document cover and tap **OK**.



Place the printed pattern face down on the platen and tap [OK].

OK

5 When the following screen appears, tap **OK**.



6 Tap **Next**.

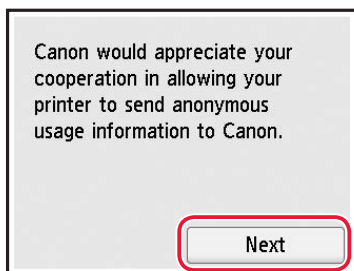

- Follow the on-screen instructions to continue setup. This includes making selections related to sending information. Refer to "Sending Information To Canon" in **Safety and Important Information**.

7 Check that the following screen appears.

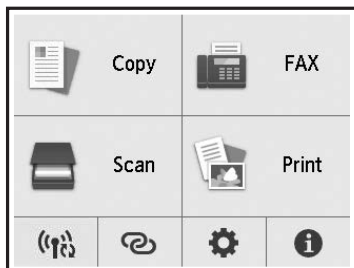

If you will use the printer without connecting any other devices, setup is now complete.

Select the connection method that best matches how you will use the printer.

- To use the printer without connecting to any other devices

➔ Setup is now complete.

To set up a fax, see "Using Fax Function" on page 8.

- To use the printer connecting to a computer or smartphone

➔ Proceed to the next page.

Setting Up the Printer

What device are you connecting?



Computer



Computer and
smartphone





Smartphone

7-a

Connecting to a Computer

If you are using multiple computers, perform these steps on each computer.



- 1 Access the Canon website from your computer.
 <https://ij.start.canon>
- 2 Select  **Set Up**.
- 3 Enter your printer's model name and click **Go**.
- 4 Click **Start**.
- 5 Click **(B) Connecting to a Computer/ Smartphone**.
 - The following steps are for Windows users.

- 6 Click **Download**.
- 7 Run the downloaded file.
- 8 Click **Start Setup**.



- 9 Follow the on-screen instructions.
 - These operations may take some time.
 - To connect to a smartphone as well, see "7-b. Connecting to a Smartphone" on page 7.
 - To set up a fax, see "Using Fax Function" on page 8.



Using the Setup CD-ROM

Double click **EasySetup.exe** in the CD-ROM, and then continue from step 3. If you do not have an internet connection, open the **win** folder in the CD-ROM and double click **SETUP.exe**. This will install the printer driver.

7-b Connecting to a Smartphone

If you are using multiple smartphones, perform these steps on each smartphone.



1 Install the "Canon PRINT Inkjet/SELPHY" app on your smartphone.



- Search for "Canon PRINT" in App Store, or Google Play.
- Access the Canon website to download the app.



2 Open the installed app, and follow the on-screen instructions in the app to add your printer.



-
- Once you have added your printer, you can print from your smartphone. To print photos, see "Loading Photo Paper" on page 8.
 - To set up a fax, see "Using Fax Function" on page 8.
-

Loading Photo Paper

Photo paper can only be loaded in the rear tray.

- 1 Open the rear tray cover and extend the paper support.

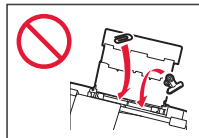
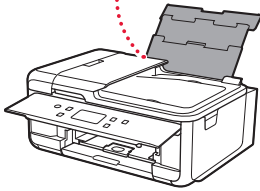
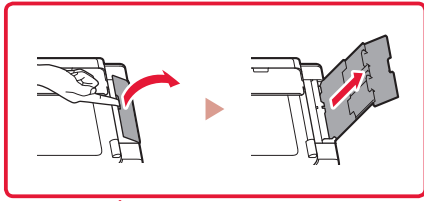

- 2 Open the feed slot cover and slide the right-hand side paper guide to the far right.

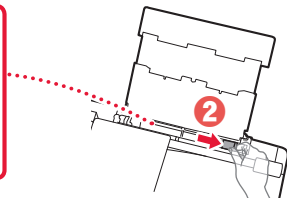
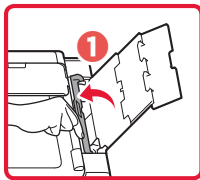

- 3 Load several sheets of photo paper with the print side facing up and slide the side paper guide against the edge of the paper stack.

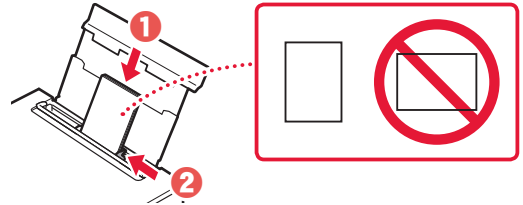

- 4 Close the feed slot cover.
 - Follow the on-screen instructions to set information for the loaded paper.

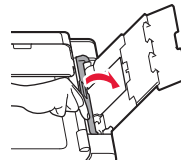

Using Fax Function



The fax function of your printer requires setup. Refer to **FAX Setup Guide**.

- Access the FAX Setup Guide

- 1 Access the Canon website.

 <https://ij.start.canon>

- 2 Click  **See Recommended Functions.**

- 3 Click **Functions/Services.**

- 4 Click  **Setting Up the FAX.**

Configuration de l'imprimante

Configuration en ligne
<https://ij.start.canon>



1. Contenu de la boîte

- Cartouches d'encre pour la configuration

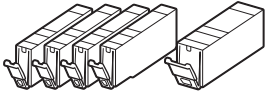

- Cordon d'alimentation
- Câble téléphonique
- CD-ROM d'installation
- Sécurité et informations importantes
- Démarrage (ce manuel)

2. Retrait du matériel d'emballage



- 1 Enlevez et jetez tout film de protection bande orange.
 - L'utilisation de l'imprimante avec la bande orange ou le film de protection encore fixé risque d'entraîner un dysfonctionnement.
- 2 Ouvrez l'unité de numérisation / capot et retirez la bande orange.

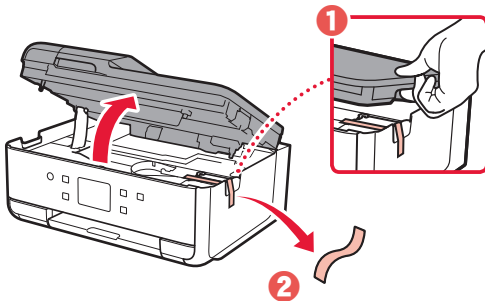

- 3 Fermez l'unité de numérisation / capot.

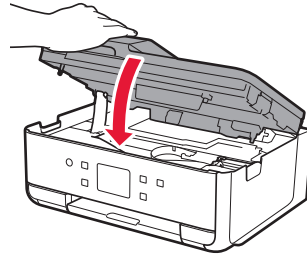

⚠ Attention

Faites attention à vos doigts.

3. Mise sous tension de l'imprimante



- 1 Branchez le cordon d'alimentation.

- La prise est placée en angle.

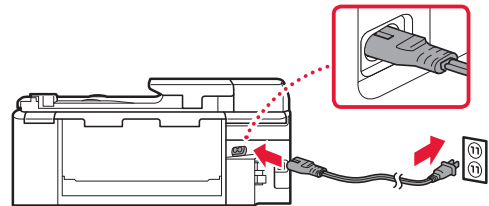

Arrière

- 2 Ouvrez le panneau de contrôle et appuyez sur le bouton **MARCHE (ON)**.

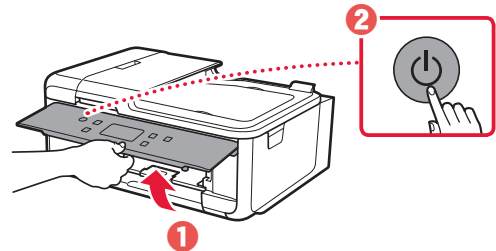

Configuration de l'imprimante

- 3 Faites défiler et touchez pour sélectionner votre langue, puis touchez **Oui**.

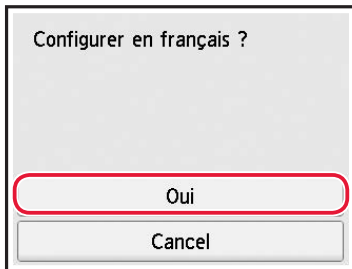
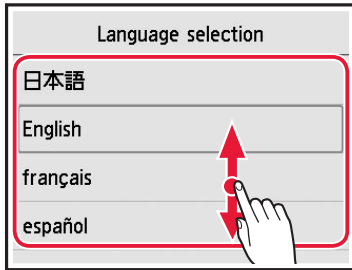

- 4 Si l'écran suivant s'affiche, touchez le pays ou la région de votre choix.

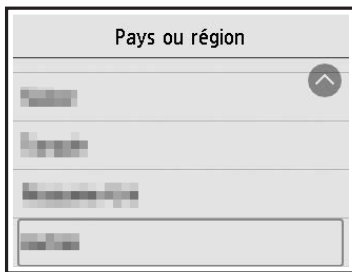

- 5 Touchez **OK**.

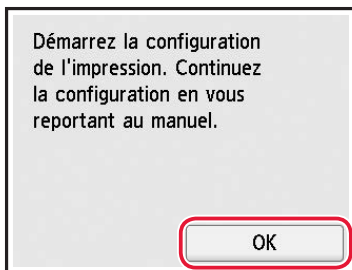

4. Installation des cartouches d'encre



- 1 Ouvrez l'unité de numérisation / capot.

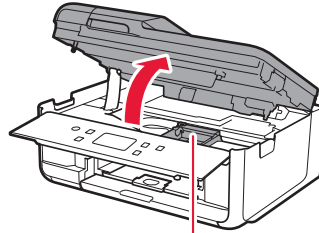

⚠ Attention

Évitez tout contact avec le support de tête d'impression tant que celui-ci n'est pas arrêté.

- 2 Retirez la bande et le film sur la cartouche d'encre.

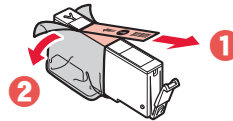

- Vérifiez qu'il ne reste ni bande ni film.

- 3 Retirez doucement le capuchon orange.

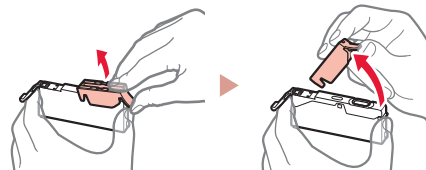

»»» Important

- N'appuyez pas sur la cartouche d'encre alors que le trou d'arrivée d'air en forme de Y est obstrué.
- Ne touchez pas les zones signalées en rouge.

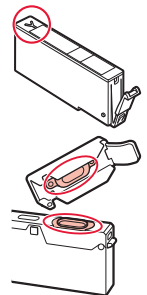

4 Installez la cartouche d'encre.

- Insérez la cartouche d'encre dans la tête d'impression et appuyez dessus jusqu'à ce qu'un clic se produise.

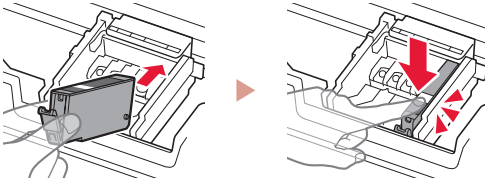

5 Vérifiez que la couleur de la cartouche d'encre que vous avez installée s'affiche à l'écran.

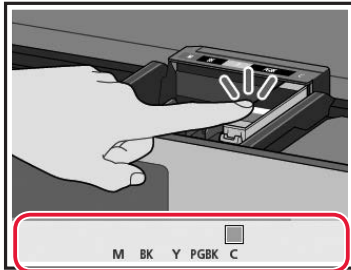

»»» Important

Si la couleur ne s'affiche pas à l'écran alors que vous avez installé la cartouche d'encre, la couleur de la cartouche d'encre est peut-être fautive, ou vous avez peut-être installé une cartouche d'encre non prise en charge par l'imprimante, par exemple une cartouche avec un numéro de modèle différent. Installez une cartouche d'encre de la bonne couleur ou utilisez la cartouche d'encre pour la configuration fournie.

6 Répétez les étapes 2 à 5 pour installer toutes les cartouches d'encre.

- Vérifiez que toutes les couleurs s'affichent.

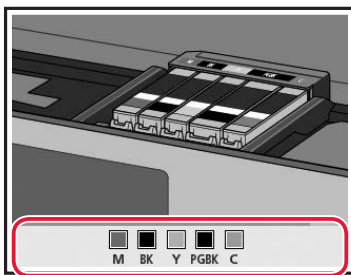

7 Fermez l'unité de numérisation / capot.

- L'imprimante commence à s'initialiser.

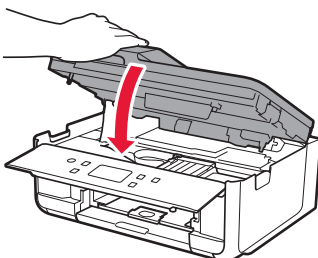

▲ Attention
Faites attention à vos doigts.

5. Chargement du papier



1 Touchez **OK**.

Lancez l'align. pr améliorer la qualité d'impress. Préparez du pap. ord. au form. A4 ou Lettre. Si vous n'en avez pas, vous pouvez l'effectuer plus tard.

Plus tard

OK

2 Retirez la cassette de l'imprimante.

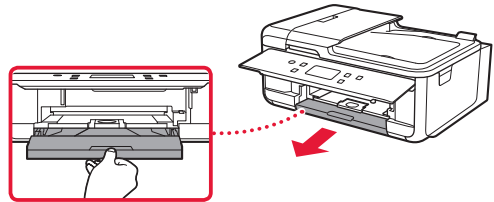

3 Retirez le couvercle de la cassette.

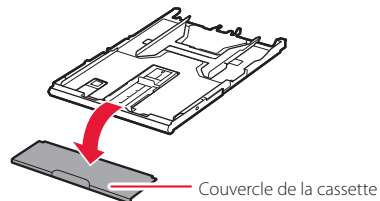

4 Faites glisser séparément les guides papier.

- Faites glisser le guide papier droit vers le bord droit. Alignez le guide papier avant sur la marque Lettre.

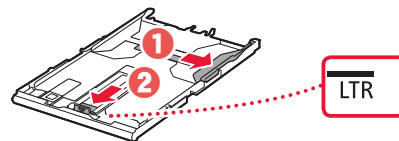

Configuration de l'imprimante

5 Chargez du papier ordinaire au format Lettre.

- Placez le papier contre le guide papier avant et alignez le guide papier droit sur la largeur du papier.

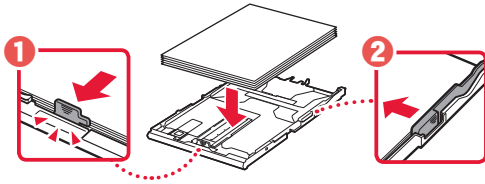

6 Fixez le couvercle de la cassette et remettez la cassette en place.

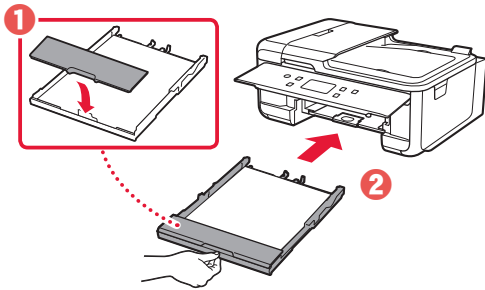

7 Retirez le bac de sortie papier.

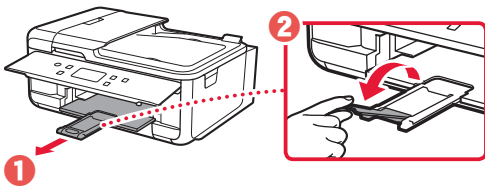

6. Alignement de la tête d'impression



1 Touchez **OK**.

Prêt à effectuer l'alignement pour améliorer la qualité d'impression. Chargez une feuille de papier ordinaire au format A4 ou Lettre dans la cassette et touchez [OK].

Guide install.

OK

- Le motif d'alignement de la tête d'impression commence à s'imprimer.

2 Assurez-vous que le motif est imprimé.

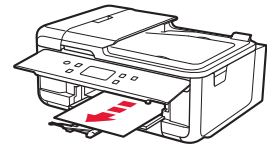

Motif d'alignement de la tête d'impression imprimé

3 Placez le motif sur la vitre d'exposition.

- Ouvrez le capot du scanner et placez l'impression face vers le bas.

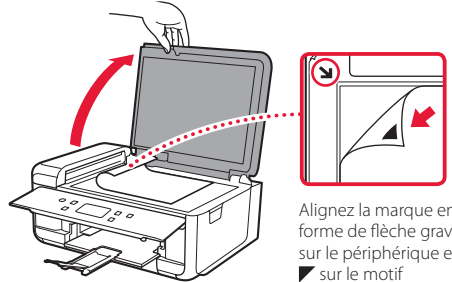

Alignez la marque en forme de flèche gravée sur le périphérique et le  sur le motif

4 Fermez le capot du scanner et touchez **OK**.



Placez le motif imprimé face vers le bas sur la vitre d'exposition et touchez [OK].

OK

5 Lorsque l'écran suivant s'affiche, touchez **OK**.

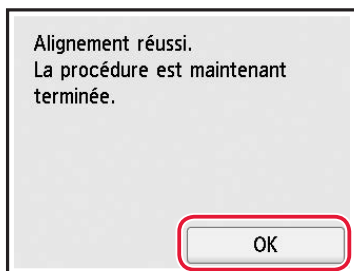

6 Touchez **Suivant**.

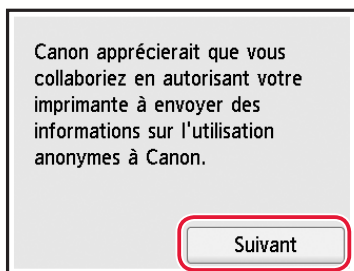

- Suivez les instructions à l'écran pour poursuivre la configuration. Cela inclut des sélections relatives à l'envoi d'informations. Reportez-vous à « Envoi d'informations à Canon » dans **Sécurité et informations importantes**.

7 Assurez-vous que l'écran suivant s'affiche.

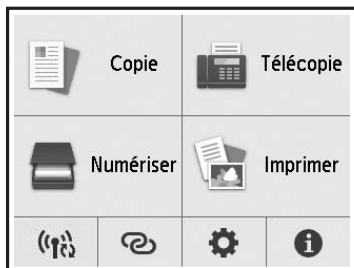

Pour utiliser l'imprimante sans connecter aucun autre périphérique, la configuration est terminée.

Sélectionnez la méthode de connexion correspondant le mieux à la manière dont vous utiliserez l'imprimante.

- Pour utiliser l'imprimante sans connexion à aucun autre périphérique

➔ La configuration est terminée.

Pour configurer un télécopieur, reportez-vous à la section « Utilisation de la fonction de télécopie » à la page 8.

- Pour utiliser l'imprimante en la connectant à un ordinateur ou à un smartphone

➔ Passez à la page suivante.

Quel périphérique connectez-vous ?



Ordinateur



Ordinateur et
smartphone



Smartphone

7-a

Connexion à un ordinateur

Si vous utilisez plusieurs ordinateurs, effectuez ces étapes sur chaque ordinateur.



- 1 Accès au site Web Canon à partir de votre ordinateur.

 <https://ij.start.canon>

- 2 Sélectionnez  **Configuration**.
- 3 Entrez le nom de modèle de votre imprimante et cliquez sur **Accéder**.

- 4 Cliquez sur **Démarrer**.

- 5 Cliquez sur **(B) Connexion à un ordinateur/smartphone**.
 - Les étapes suivantes concernent les utilisateurs Windows.

- 6 Cliquez sur **Télécharger**.

- 7 Exécutez le fichier téléchargé.

- 8 Cliquez sur **Commencer la configuration**.



- 9 Suivez les instructions à l'écran.
 - Ces opérations peuvent prendre du temps.
 - Pour vous connecter aussi à un smartphone, voir « 7-b. Connexion à un smartphone » à la page 7.
 - Pour configurer un télécopieur, reportez-vous à la section « Utilisation de la fonction de télécopie » à la page 8.



Utilisation du CD-ROM d'installation

Cliquez deux fois sur **EasySetup.exe** à partir du CD-ROM, puis continuez à partir de l'étape 3. Si vous ne disposez pas d'une connexion Internet, ouvrez le dossier **win** à partir du CD-ROM et cliquez deux fois sur **SETUP.exe**. Cette procédure permet d'installer le pilote d'imprimante.

7-b

Connexion à un smartphone

Si vous utilisez plusieurs smartphones, effectuez ces étapes sur chaque smartphone.



1 Installez l'application « Canon PRINT Inkjet/SELPHY » sur votre smartphone.



- Recherchez « Canon PRINT » dans App Store ou Google Play.
- Accédez au site Web Canon pour télécharger l'application.



2 Ouvrez l'application installée, puis suivez les instructions affichées à l'écran par l'application pour ajouter votre imprimante.



-
- Une fois que vous avez ajouté votre imprimante, vous pouvez imprimer depuis votre smartphone. Pour imprimer des photos, consultez « Chargement de papier photo » à la page 8.
 - Pour configurer un télécopieur, reportez-vous à la section « Utilisation de la fonction de télécopie » à la page 8.
-

Chargement de papier photo

Le papier photo peut être chargé uniquement dans le réceptacle arrière.

- 1 Ouvrez le couvercle du réceptacle arrière et déployez le support papier.

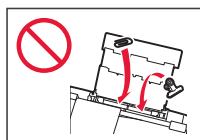
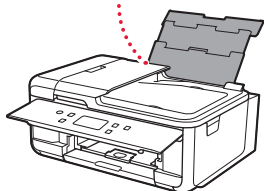
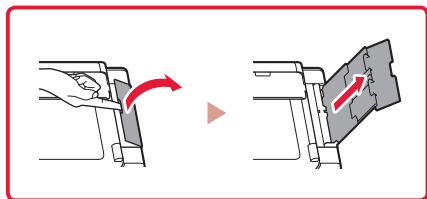

- 2 Ouvrez le couvercle de la fente d'alimentation et faites glisser le guide papier droit vers l'extrême droite.

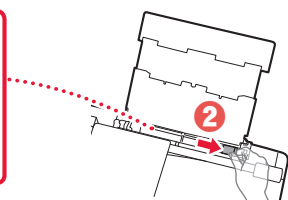
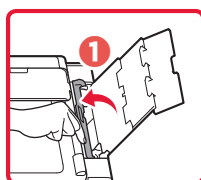

- 3 Chargez plusieurs feuilles de papier photo face à imprimer vers le haut et faites glisser le guide papier latéral contre le bord de la pile de papier.

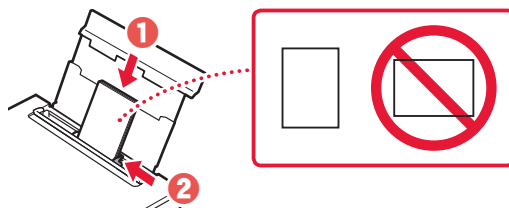

- 4 Fermez le couvercle de la fente d'alimentation.
 - Suivez les instructions à l'écran pour définir les informations sur le papier chargé.

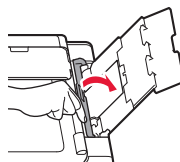

Utilisation de la fonction de télécopie



La fonction de télécopie de votre imprimante requiert une configuration. Reportez-vous à **Guide d'installation du télécopieur**.

- Accédez au Guide d'installation du télécopieur

- 1 Accédez au site Web Canon.

 <https://ij.start.canon>

- 2 Cliquez sur  **Consultez Fonctions recommandées.**

- 3 Cliquez sur **Fonctions/services.**

- 4 Cliquez sur  **Configuration du FAX.**



Access Online Manual

Accès au Manuel en ligne

From your browser

À partir de votre navigateur



<https://ij.start.canon>

