

Canon

G3060 series

Getting Started

Guía de inicio

Para Começar



<https://ij.start.canon>



Read **Safety and Important Information** (addendum) first.

Lea primero **Información de seguridad e información importante** (apéndice).

Leia **Informações Importantes e Sobre Segurança** (adendo) primeiro.



QT63699V01



Installing the Printer.....page 1

Instalación de la impresorapágina 1

Instalando a impressorapágina 1



Connecting to a Computer, Smartphone or Tablet..... page 4

Conexión con un ordenador, teléfono inteligente o tabletapágina 4

Conectando a um computador, smartphone ou tablet.....página 4

Holding the Printer

Cómo sujetar la impresora

Segurando a impressora

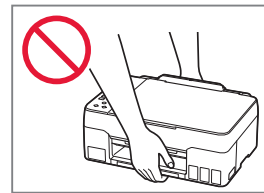
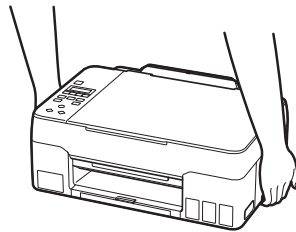

Instructional Videos

Vídeos instructivos

Vídeos instrucionais



3. XXXXXXXXXXXXXXXXXXXX



Setting Up the Printer

1. Box Contents

● Print Heads

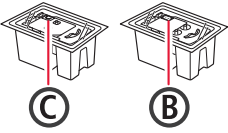

- Ink Bottles
- Power Cord
- Setup CD-ROM
- Safety and Important Information
- Getting Started (this manual)

2. Removing Packing Materials



- 1 Remove and dispose of any packing materials and orange tape.
- 2 Open the scanning unit / cover, remove and dispose of the orange tape and protective material inside.

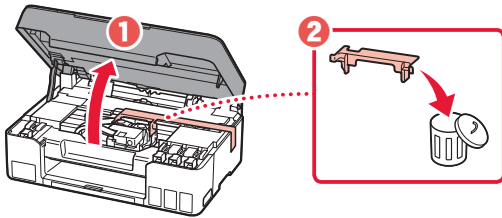

3. Installing the Print Heads



- 1 Open the print head locking cover.
- 2 Take out each print head from the package and remove the label.

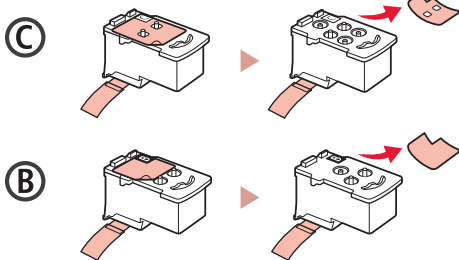
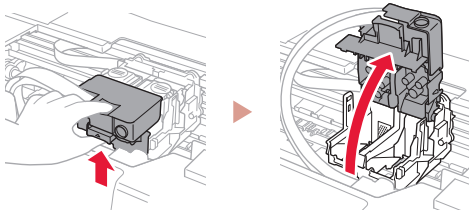

- 3 Remove the protective tape.

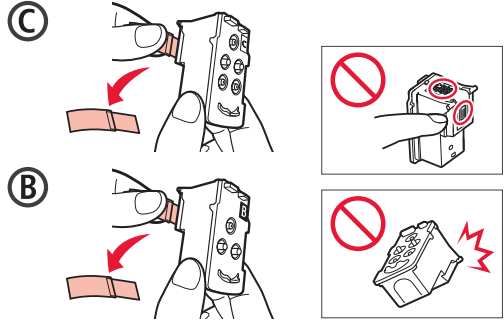

- 4 Insert the C (color) print head on the left and the B (black) print head on the right.

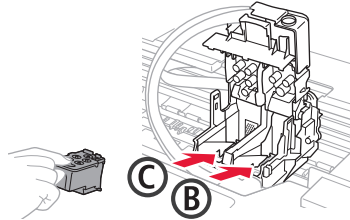

- 5 Close the print head locking cover and press down until it clicks.

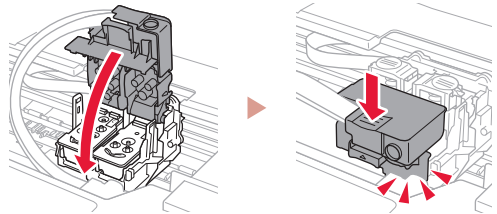

- 6 Press down both joint buttons completely until they click.

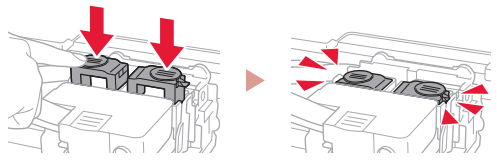

Check!



- 7 Close the scanning unit / cover.
 - Open the scanning unit / cover fully and then close it.

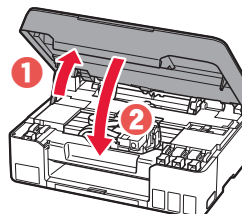

⚠ Caution
Watch your fingers.

Setting Up the Printer

4. Turning on the Printer



- 1 Connect the power cord.

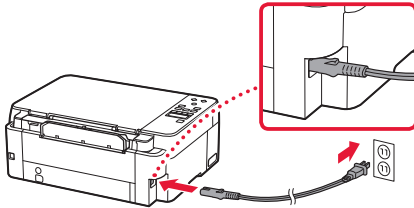

Back

- 2 Press the **ON** button.

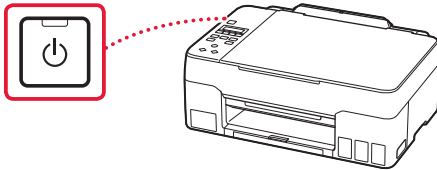

- 3 When the following screen appears, use the ◀ and ▶ buttons to select a language, and then press the **OK** button.



▶▶▶ Important

If an error appears on the screen, see "If an error message (support code) appears on the screen" on page 3 and follow the instructions.

5. Pouring Ink



▶▶▶ Important

This product requires careful handling of ink. Ink may splatter when the ink tanks are filled with ink. If ink gets on your clothes or belongings, it may not come off.

- 1 Open the scanning unit / cover.

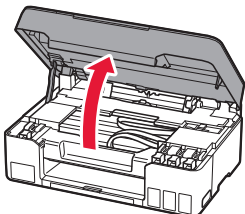

- 2 Open the tank cap on the left of the printer.

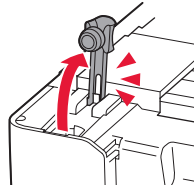

- 3 Hold the ink bottle upright and gently twist the bottle cap to remove.

Check!



- 4 Align the nozzle of the ink bottle with the inlet.

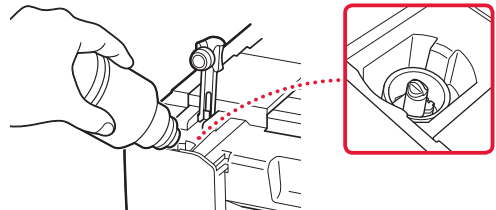

- 5 Slowly stand the ink bottle upside down and push down to pour the ink.

- If the ink does not pour, gently remove the ink bottle and try again.

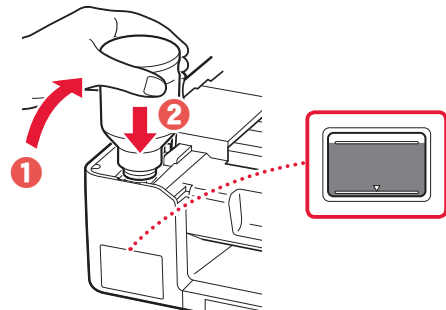

- 6 Gently remove the ink bottle from the inlet.

- Be careful not to spill the ink.

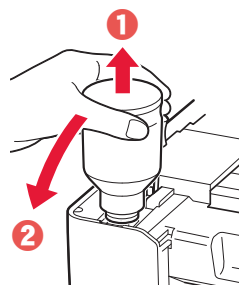

7 Replace the tank cap **securely**.

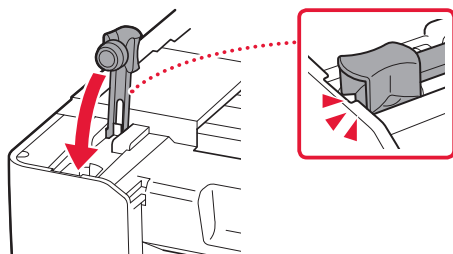

8 Repeat steps 2 through 7 to pour all ink into the corresponding ink tanks on the right.

Check!

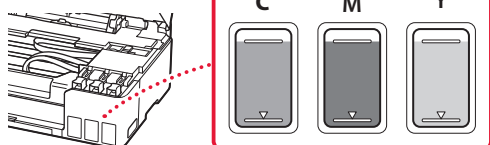

9 Close the scanning unit / cover.

- Open the scanning unit / cover fully and then close it.

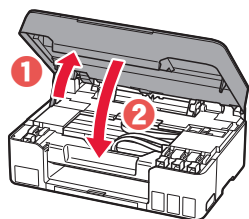

Caution
Watch your fingers.

10 When the following screen appears, use the ◀ and ▶ buttons to select **Yes**, and then press the **OK** button.

Are the ink tanks filled w
Yes < No >



Initializing ink system...
About 1 min. remaining

- Please wait momentarily until the following screen appears. Follow the on-screen instructions, and then press the OK button.

Setup is complete
[OK]Next

Copy
100% 01

If you will use the printer without connecting any other devices, setup is now complete.

Select the connection method that best matches how you will use the printer.

- To use the printer without connecting to any other devices
 - ➔ Setup is now complete.
- To use the printer connecting to a computer or smartphone
 - ➔ Proceed to the next page.

? If an error message (support code) appears on the screen

Protective material rema
Support code 1890 — Support code

Check the support code, and then follow the instructions if the displayed code is written below.

- **1890**
Protective material remaining.
➔ "2. Removing Packing Materials" on page 1
- **1470**
Print heads are not installed correctly.
➔ "3. Installing the Print Heads" on page 1
- **1471**
Print heads cannot be recognized.
➔ "3. Installing the Print Heads" on page 1
- **5200**
Ink system preparation was not completed successfully. Press the **ON** button to restart the printer, and then see "5. Pouring Ink" on page 2.

For all other cases, refer to the **Online Manual**.

Setting Up the Printer

What device are you connecting?



Computer



Computer and
smartphone





Smartphone

6-a

Connecting to a Computer

If you are using multiple computers, perform these steps on each computer.



- 1 Access the Canon website from your computer.
 <https://ij.start.canon>
- 2 Select  **Set Up**.
- 3 Enter your printer's model name and click **Go**.
- 4 Click **Start**.
- 5 Click **(B) Connecting to a Computer/Smartphone**.
 - The following steps are for Windows users.
- 6 Click **Download**.
- 7 Run the downloaded file.
 - Follow the on-screen instructions.
 - This may take some time.
 - To connect to a smartphone as well, see "6-b. Connecting to a Smartphone" on page 5.



Using the Setup CD-ROM

Double click **EasySetup.exe** in the CD-ROM, and then continue from step 3. If you do not have an internet connection, open the **win** folder in the CD-ROM and double click **SETUP.exe**. This will install the printer driver.

6-b

Connecting to a Smartphone

If you are using multiple smartphones, perform these steps on each smartphone.



1 Install the "Canon PRINT Inkjet/SELPHY" app on your smartphone.



- Search for "Canon PRINT" in App Store, or Google Play.
- Access the Canon website to download the app.



2 Open your smartphone's Wi-Fi settings. Check that the network name (SSID) that starts with "Canon_ij_" appears.

(Example of iOS screen)

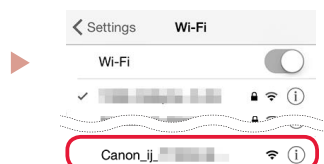

The network name (SSID) that starts with "Canon_ij_"

- If "Canon_ij_" appears → Proceed to step **3**.
- If "Canon_ij_" does not appear → Proceed to step **4**.

3 Tap the network name (SSID) that starts with "Canon_ij_".

4 Open the installed app, and follow the on-screen instructions in the app to add your printer.



Once you have added your printer, you can print from your smartphone.
To print photos, see "Loading Paper" on page 6.

Loading Paper

- 1 Extend the paper support.

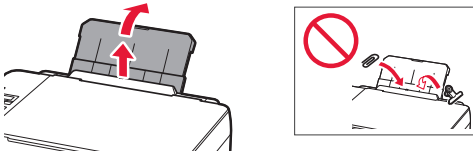

- 2 Open the feed slot cover and slide the right-hand side paper guide to the far right.

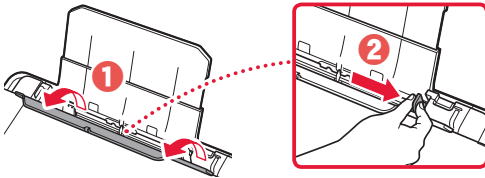

- 3 Load several sheets of paper with the print side facing up and slide the side paper guide against the edge of the paper stack.

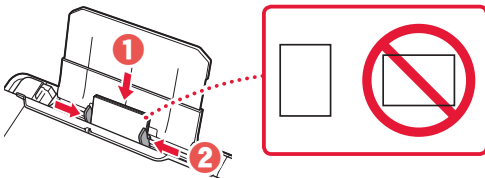

- 4 Close the feed slot cover.

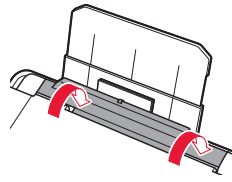

- 5 When **Save the rear tray paper information** appears on the printer's screen, press the **OK** button.

- 6 Select the paper size and type, and press the **OK** button.

- 7 Extend the paper output tray.

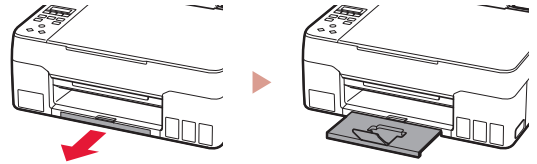

Transporting Your Printer

When relocating the printer, check the following. Refer to the **Online Manual** for details.

Check that both joint buttons are pressed down completely to avoid ink leaks.

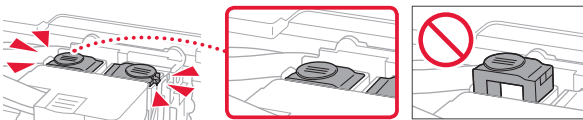

Check that the position of the ink valve lever is closed.

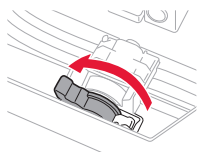

Pack the printer in a plastic bag in case ink leaks.

- Pack the printer in a sturdy box so that it is placed with its bottom facing down, using sufficient protective material to ensure safe transport.
- Do not tilt the printer. Ink may leak.
- Please handle with care and ensure the box remains flat and NOT turned upside down or on its side, as the printer may be damaged and ink in the printer may leak.
- When a shipping agent is handling transport of the printer, have its box marked "THIS SIDE UP" to keep the printer with its bottom facing down. Mark also with "FRAGILE" or "HANDLE WITH CARE".

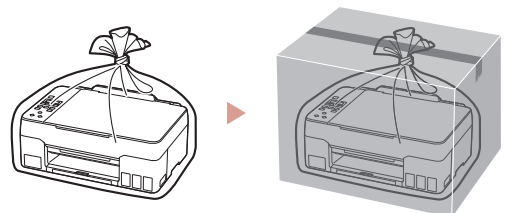

Instalación de la impresora

1. Contenido de la caja

● Cabezales de impresión

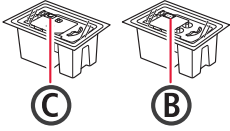

- Frascos de tinta
- Cable de alimentación
- CD-ROM de instalación
- Información de seguridad e información importante
- Guía de inicio (este manual)

2. Retirar los materiales de protección



- 1 Retire y tire los materiales de protección y la cinta naranja.
- 2 Abra la cubierta/unidad de escaneado, retire y tire la cinta naranja y el material de protección que hay dentro.

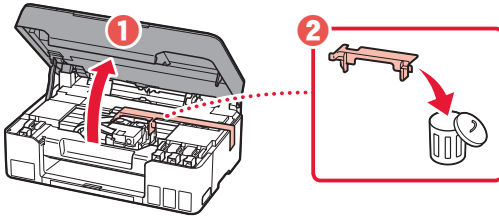

3. Instalar los cabezales de impresión



- 1 Abra la cubierta de bloqueo del cabezal de impresión.
- 2 Saque cada cabezal de impresión del paquete y retire la etiqueta.

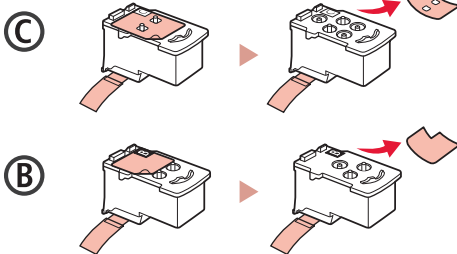
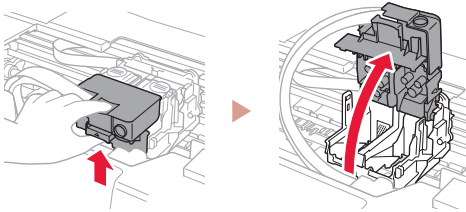

- 3 Retire la cinta protectora.

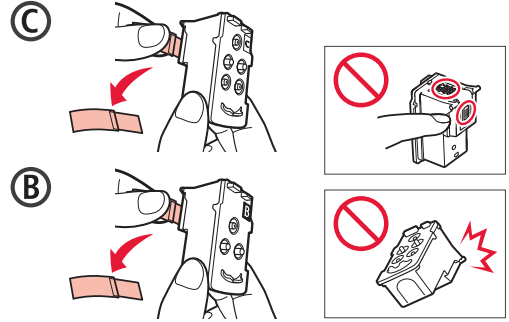

- 4 Inserte el cabezal de impresión C (color) a la izquierda y el cabezal de impresión B (negro) a la derecha.

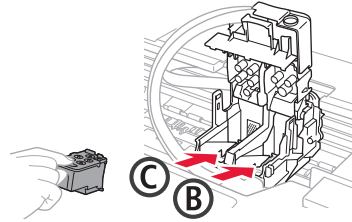

- 5 Cierre la cubierta de bloqueo del cabezal de impresión y presione hacia abajo hasta que haga clic.

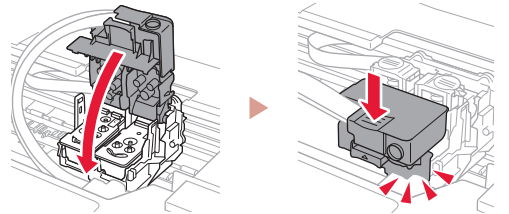

- 6 Presione hacia abajo los dos botones de unión completamente hasta que hagan clic.

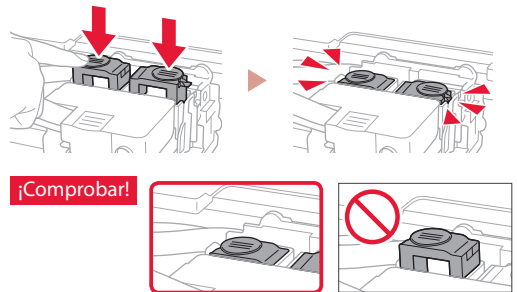

- 7 Cierre la cubierta/unidad de escaneado.

- Abra la cubierta/unidad de escaneado completamente y luego ciérrela.

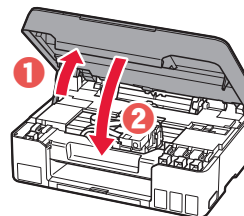

⚠ Precaución
Tenga cuidado con los dedos.

Instalación de la impresora

4. Encender la impresora



- 1 Conecte el cable de alimentación.

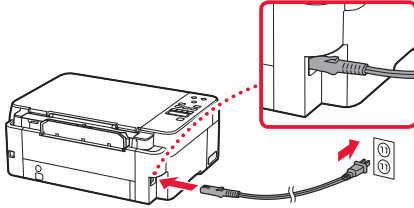

Atrás

- 2 Pulse el botón **ACTIVADO (ON)**.

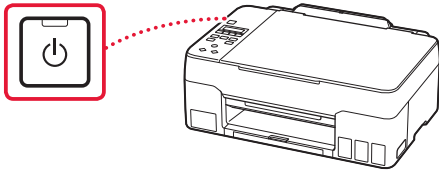

- 3 Si aparece la siguiente pantalla, use los botones ◀ y ▶ para seleccionar el idioma y pulse el botón **OK**.



►►► Importante

Si aparece un error en la pantalla, consulte "Si se muestra un mensaje de error (código de asistencia) en la pantalla" en la página 3 y siga las instrucciones.

5. Verter la tinta



►►► Importante

Este producto requiere un tratamiento cuidadoso de la tinta, ya que puede salpicar cuando se rellenan de tinta los depósitos de tinta. Es posible que las manchas de tinta no salgan de la ropa u otras pertenencias.

- 1 Abra la cubierta/unidad de escaneado.

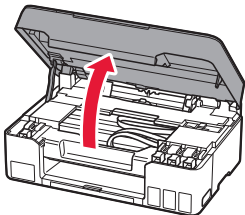

- 2 Abra la tapa del depósito de la izquierda de la impresora.

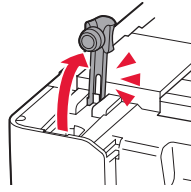

- 3 Sujete el frasco de tinta hacia arriba y gire suavemente la tapa del frasco para retirarla.

¡Comprobar!



- 4 Alinee la boquilla del frasco de tinta con la entrada.

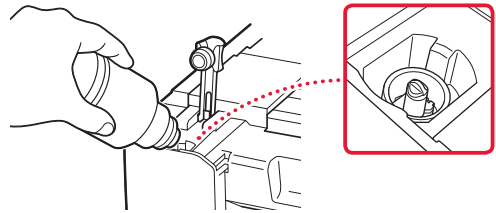

- 5 Coloque el frasco de tinta boca abajo despacio y empuje hacia abajo para verter la tinta.

- Si la tinta no se vierte, retire suavemente el frasco de tinta e inténtelo de nuevo.

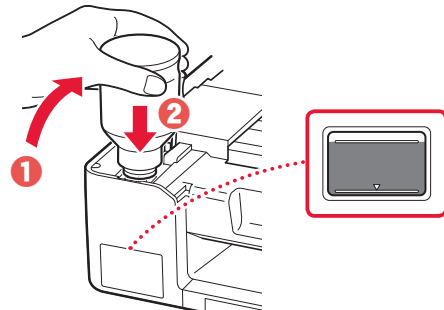

- 6 Retire suavemente el frasco de tinta de la entrada.

- Tenga cuidado de no derramar la tinta.

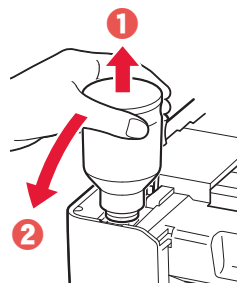

7 Vuelva a colocar la tapa del depósito firmemente.

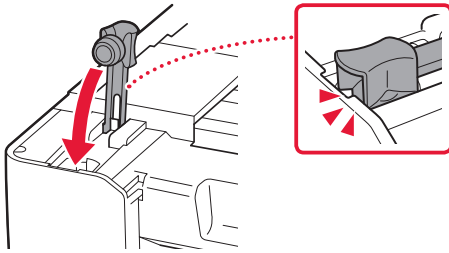

8 Repita los pasos del 2 al 7 para verter toda la tinta en los depósitos de tinta correspondientes de la derecha.

¡Comprobar!

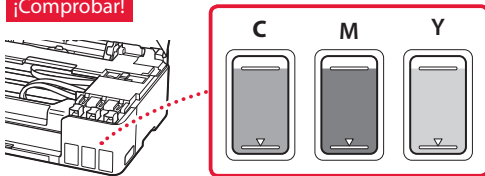

9 Cierre la cubierta/unidad de escaneado.

- Abra la cubierta/unidad de escaneado completamente y luego ciérrela.

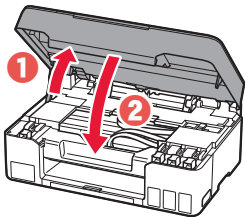

⚠ Precaución
Tenga cuidado con los dedos.

10 Si aparece la siguiente pantalla, use los botones ◀ y ▶ para seleccionar **Sí (Yes)** y, a continuación, pulse el botón **OK**.

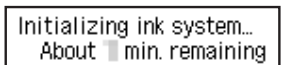
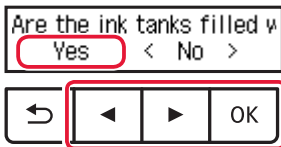

- Espere un momento hasta que aparezca la siguiente pantalla. Siga las instrucciones en pantalla y luego pulse el botón **OK**.

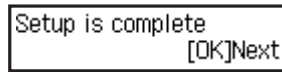

Si va a utilizar la impresora sin conectar con ningún otro dispositivo, la configuración ya se ha completado.

Seleccione el método de conexión que mejor se adapte al uso de la impresora.

- Para usar la impresora sin conectar con ningún otro dispositivo
 - ➔ Ha finalizado la configuración.
- Para usar la impresora conectándola a un ordenador o un teléfono inteligente
 - ➔ Continúe a la página siguiente.



Si se muestra un mensaje de error (código de asistencia) en la pantalla

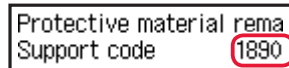

Código asist. (Support code)

Compruebe el código de asistencia y después siga las instrucciones si el código que se muestra está escrito a continuación.

- **1890**
Material de protección restante.
➔ "2. Retirar los materiales de protección" en la página 1
- **1470**
Los cabezales de impresión no están instalados correctamente.
➔ "3. Instalar los cabezales de impresión" en la página 1
- **1471**
No se pueden reconocer los cabezales de impresión.
➔ "3. Instalar los cabezales de impresión" en la página 1
- **5200**
La preparación del sistema de tinta no se ha completado correctamente.
Pulse el botón **ACTIVADO (ON)** para reiniciar la impresora y, a continuación, consulte "5. Verter la tinta" en la página 2.

Para los demás casos, consulte el **Manual en línea**.

¿Qué dispositivo va a conectar?



Ordenador



Ordenador y
teléfono inteligente





Teléfono inteligente

6-a

Conectar al ordenador

Si utiliza varios ordenadores, realice estos pasos en cada ordenador.



- 1 Acceda al sitio web de Canon desde el ordenador.
 <https://ij.start.canon>
- 2 Seleccione  **Configurar**.
- 3 Escriba el nombre del modelo de su impresora y haga clic en **Ir**.
- 4 Haga clic en **Iniciar**.
- 5 Haga clic en **(B) Conexión con un ordenador/teléfono inteligente**.
 - Los siguientes pasos son para usuarios de Windows.
- 6 Haga clic en **Descargar**.
- 7 Ejecute el archivo descargado.
 - Siga las instrucciones que aparezcan en pantalla.
 - Esto puede llevar algún tiempo.
 - Para conectar con un teléfono inteligente también, consulte "6-b. Conexión con un teléfono inteligente" en la página 5.



Uso del CD-ROM de instalación

Haga doble clic en **EasySetup.exe** en el CD-ROM y después continúe desde el paso 3. Si no tiene una conexión a Internet, abra la carpeta **win** en el CD-ROM y haga doble clic en **SETUP.exe**. Esto instalará el controlador de la impresora.

6-b

Conexión con un teléfono inteligente

Si utiliza varios teléfonos inteligentes, realice estos pasos en cada teléfono inteligente.



1 Instale la aplicación "Canon PRINT Inkjet/SELPHY" en su teléfono inteligente.



- Busque "Canon PRINT" en App Store o Google Play.
- Acceda al sitio web Canon para descargar la aplicación.



2 Abra la configuración de Wi-Fi de su teléfono inteligente. Compruebe que aparezca el nombre de red (SSID) que empieza con "Canon_ij_".

(Ejemplo de la pantalla de iOS)

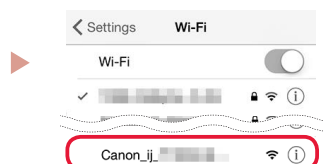

El nombre de red (SSID) que empieza con "Canon_ij_ "

- Si se muestra "Canon_ij_" → continúe en el paso **3**.
- Si no se muestra "Canon_ij_" → continúe en el paso **4**.

3 Toque el nombre de red (SSID) que empieza con "Canon_ij_".

4 Abra la aplicación instalada y luego siga las instrucciones en la aplicación para agregar su impresora.



Cuando haya agregado la impresora, podrá imprimir desde su teléfono inteligente.
Para imprimir fotos, consulte "Carga de papel" en la página 6.

Carga de papel

- 1 Extienda el soporte del papel.

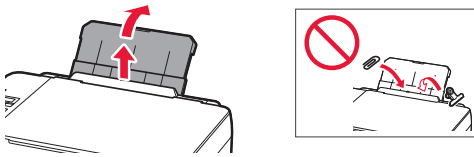

- 2 Abra la cubierta de la ranura de alimentación y deslice la guía del papel del lado derecho totalmente hacia la derecha.

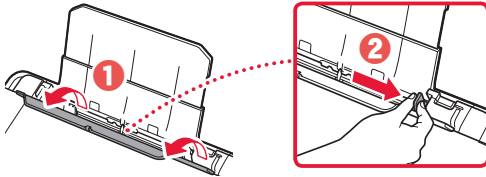

- 3 Cargue varias hojas de papel con la cara de impresión hacia arriba y deslice la guía del papel lateral contra el borde de las hojas de papel.

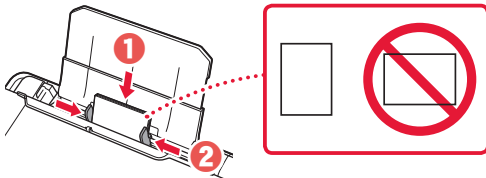

- 4 Cierre la cubierta de la ranura de alimentación.

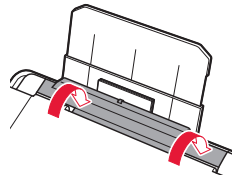

- 5 Cuando se muestre **Registre la información de papel de la bandeja posterior (Save the rear tray paper information)** en la pantalla de la impresora, pulse el botón **OK**.

- 6 Seleccione el tipo y tamaño de papel y pulse el botón **OK**.

- 7 Extienda la bandeja de salida del papel.

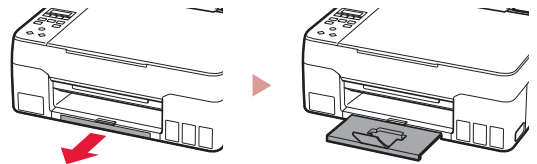

Transporte de la impresora

Cuando vaya a transportar la impresora, compruebe lo siguiente. Consulte el **Manual en línea** para obtener más información.

Compruebe que ambos botones de unión se hayan presionado hacia abajo completamente para evitar derrames de tinta.

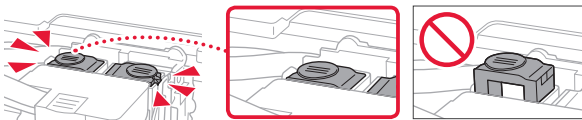

Compruebe que la palanca de válvula de tinta esté en la posición cerrada.

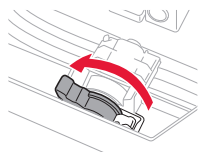

Embale la impresora en una bolsa de plástico por si hay derrames de tinta.

- Embale la impresora en una caja resistente y de modo que no quede boca abajo. Utilice suficiente material de protección para garantizar un transporte seguro.
- No incline la impresora. De lo contrario, es posible que la tinta se derrame.
- Manipule con cuidado y asegúrese de que la caja permanece en una superficie plana y que **NO** se coloca boca abajo o de lado, ya que la impresora podría dañarse y la tinta de la impresora, derramarse.
- Cuando se ocupe del transporte de la impresora una empresa de mensajería, marque la caja con "ESTE LADO ARRIBA" para mantener la impresora con la parte inferior abajo. Márquela también con "FRÁGIL" o "MANEJAR CON CUIDADO".

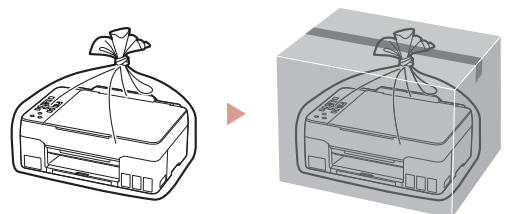

Configurando a impressora

1. Conteúdo da Caixa

● Cabeças de impressão

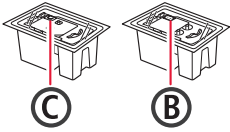

- Garrafas de tinta
- Cabo de alimentação
- CD-ROM de instalação
- Informações Importantes e Sobre Segurança
- Para Começar (este manual)

2. Removendo os materiais da embalagem



- 1 Remova e descarte quaisquer materiais de embalagem e a fita laranja.
- 2 Abra a unidade de digitalização/tampa, remova e descarte a fita laranja e o material de proteção que estão dentro.

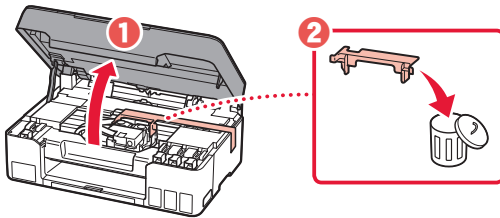

3. Instalando as cabeças de impressão



- 1 Abra a tampa de fixação da cabeça de impressão.
- 2 Retire cada cabeça de impressão do pacote e remova a etiqueta.

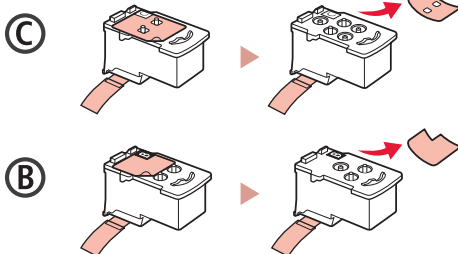
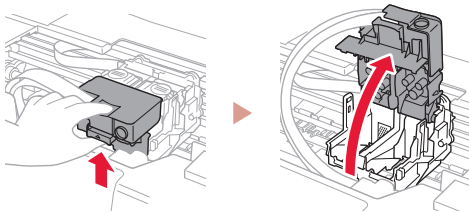

- 3 Remova a fita de proteção.

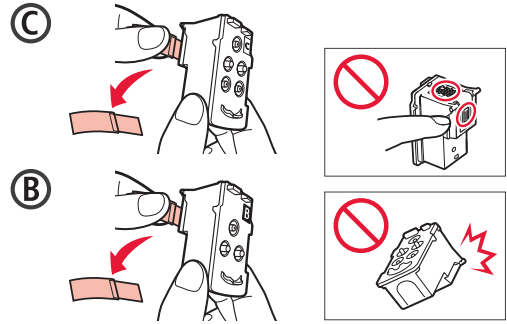

- 4 Insira a cabeça de impressão C (colorida) à esquerda e a cabeça de impressão B (preta) à direita.

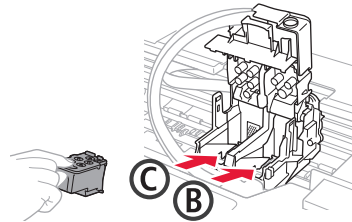

- 5 Feche a tampa de fixação da cabeça de impressão e pressione para baixo até ouvir um clique.

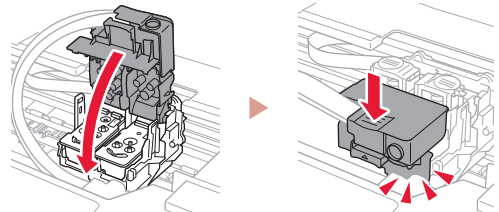

- 6 Pressione os dois botões acoplados completamente até que eles emitam um clique.

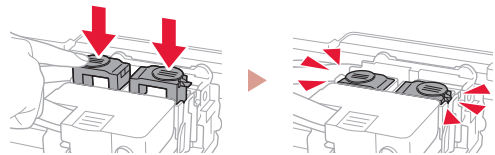

Verificar!



- 7 Feche a unidade de digitalização/tampa.
 - Abra totalmente a unidade de digitalização/tampa e feche em seguida.

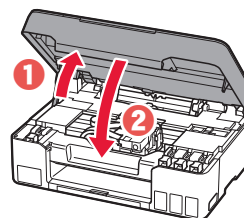

▲ Cuidado

Cuidado com seus dedos.

Configurando a impressora

4. Ligando a Impressora



- 1 Conecte o cabo de alimentação.

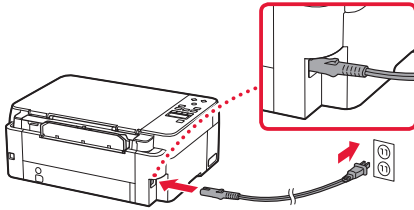

Parte traseira

- 2 Pressione o botão **ATIVADO (ON)**.

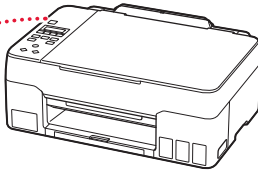

- 3 Quando a tela a seguir for exibida, use os botões ◀ e ▶ para selecionar um idioma e, em seguida, pressione o botão **OK**.



►►► Importante

Se aparecer um erro na tela, consulte "Se uma mensagem de erro (código de suporte) aparecer na tela" na página 3 e siga as instruções.

5. Colocando tinta



►►► Importante

Este produto requer manuseio cauteloso da tinta. A tinta pode respingar quando os cartuchos de tinta estão cheios. Se a tinta entrar em contato com roupas ou objetos, pode ser que ela não saia.

- 1 Abra a unidade de digitalização/tampa.

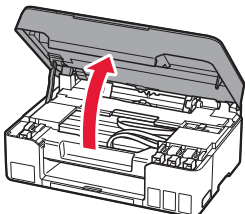

- 2 Abra a tampa do cartucho à esquerda da impressora.

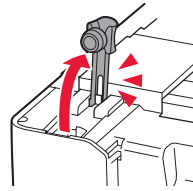

- 3 Segure a garrafa de tinta na posição vertical e gire cuidadosamente a tampa da garrafa para removê-la.

Verificar!



- 4 Alinhe o bocal da garrafa de tinta com a entrada.

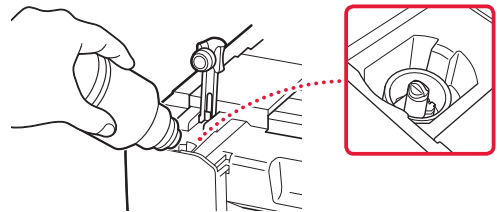

- 5 Levante lentamente a garrafa de tinta de cabeça para baixo e empurre para baixo para despejar a tinta.

- Se a tinta não for despejada, remova lentamente a garrafa de tinta e tente novamente.

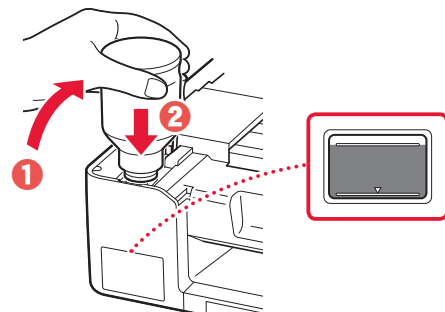

- 6 Remova lentamente a garrafa de tinta da entrada.

- Tenha cuidado para não derramar a tinta.

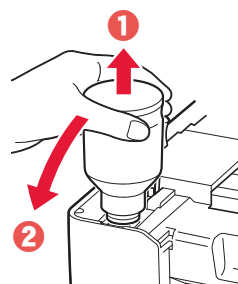

7 Recoloque **firmemente** a tampa do cartucho.

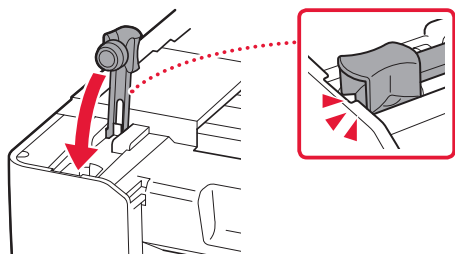

8 Repita as etapas de 2 a 7 para colocar toda a tinta nos cartuchos de tinta correspondentes à direita.

Verificar!

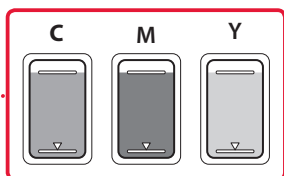
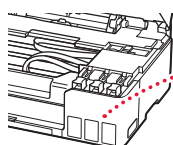

9 Feche a unidade de digitalização/tampa.

- Abra totalmente a unidade de digitalização/tampa e feche em seguida.

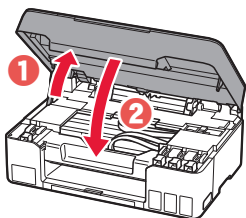

⚠ Cuidado
Cuidado com seus dedos.

10 Quando a tela a seguir for exibida, use os botões ◀ e ▶ para selecionar **Sim (Yes)** e, em seguida, pressione o botão **OK**.

Are the ink tanks filled w
Yes < No >



Initializing ink system...
About 1 min. remaining

- Aguarde um momento até que a tela a seguir apareça. Siga as instruções na tela e pressione o botão **OK**.

Setup is complete
[OK]Next

Copy
100% ██████████ 01

Se você for usar a impressora sem conectar nenhum outro dispositivo, a configuração estará concluída.

Selecione o método de conexão que melhor se adequa ao seu uso da impressora.

- Para usar a impressora sem conectá-la a nenhum outro dispositivo
 - ➔ A configuração foi concluída.
- Para utilizar a impressora com conexão a um computador ou smartphone
 - ➔ Prossiga para a página seguinte.

? Se uma mensagem de erro (código de suporte) aparecer na tela

Protective material rema
Support code 1890 Cód. suporte
(Support code)

Verifique o código de suporte e siga as instruções se o código exibido estiver escrito abaixo.

- 1890
Material de proteção restante.
➔ "2. Removendo os materiais da embalagem" na página 1
- 1470
Cabeças de impressão não estão instaladas corretamente.
➔ "3. Instalando as cabeças de impressão" na página 1
- 1471
Cabeças de impressão não podem ser reconhecidas.
➔ "3. Instalando as cabeças de impressão" na página 1
- 5200
A preparação do sistema de tinta não foi concluída com sucesso. Pressione o botão **ATIVADO (ON)** para reiniciar a impressora e consulte "5. Colocando tinta" na página 2.

Para todos os outros casos, consulte o **Manual On-line**.

Configurando a impressora

Qual dispositivo você está conectando?



Computador



Computador e
smartphone



Smartphone

6-a

Conectando a um Computador

Se você estiver usando vários computadores, execute estas etapas em cada computador.



- 1 Acesse o site Canon do seu computador.
 <https://ij.start.canon>
- 2 Selecione  **Configurar**.
- 3 Insira o nome do modelo da sua impressora e clique em **Ir**.
- 4 Clique em **Iniciar**.
- 5 Clique em **(B) Conectar a um Computador/Smartphone**.
 - As etapas a seguir são para usuários do Windows.
- 6 Clique em **Download**.
- 7 Execute o arquivo baixado.
 - Siga as instruções na tela.
 - Isso pode levar algum tempo.
 - Para conectar a um smartphone também, consulte "6-b. Conectando a um smartphone" na página 5.



Usando o CD-ROM de instalação

Clique duas vezes em **EasySetup.exe** no CD-ROM e, em seguida, continue a partir da etapa 3. Se você não tiver uma conexão com a internet, abra a pasta **win** no CD-ROM e clique duas vezes em **SETUP.exe**. Isso instalará o driver da impressora.

6-b

Conectando a um smartphone

Se você estiver usando vários smartphones, execute estas etapas em cada smartphone.



1 Instale o aplicativo "Canon PRINT Inkjet/SELPHY" no seu smartphone.



- Procure por "Canon PRINT" na App Store, ou Google Play.
- Acesse o site Canon para fazer o download do aplicativo.



2 Abra as configurações do seu Wi-Fi smartphone. Verifique se o nome da rede (SSID) que começa com "Canon_ij_" aparece.

(Exemplo da tela do iOS)

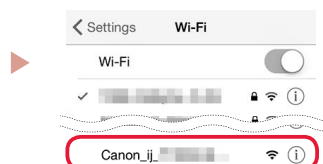

O nome da rede (SSID) que começa com "Canon_ij_"

- Se "Canon_ij_" aparecer, → prossiga para a etapa **3**.
- Se "Canon_ij_" não aparecer, → prossiga para a etapa **4**.

3 Toque no nome da rede (SSID) que começa com "Canon_ij_".

4 Abra o aplicativo instalado e siga as instruções para adicionar sua impressora.



Depois que você adicionar a impressora, poderá imprimir a partir do smartphone.
Para imprimir fotos, consulte "Colocando papel" na página 6.

Colocando papel

- 1 Abra o suporte de papel.

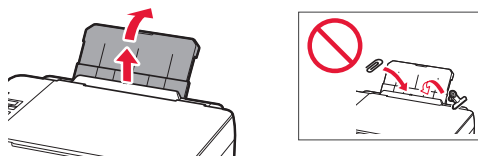

- 2 Abra a tampa do slot de alimentação e deslize a guia do papel do lado direito para a extrema direita.

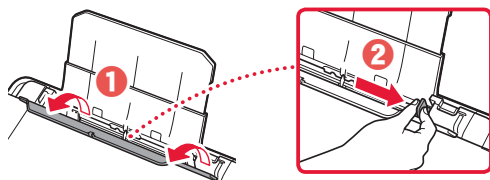

- 3 Coloque várias folhas de papel com o lado a ser impresso virado para cima e deslize a guia do papel lateral em direção à borda da pilha de papel.

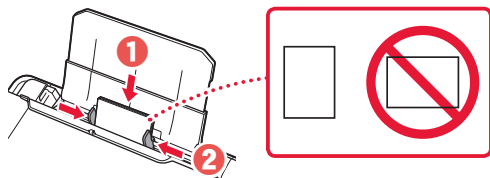

- 4 Feche a tampa do slot de alimentação.

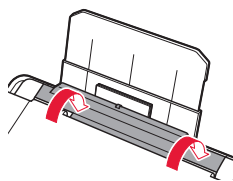

- 5 Quando **Registrar as informações do papel da bandeja traseira (Save the rear tray paper information)** aparecer na tela da impressora, pressione o botão **OK**.

- 6 Selecione o tamanho e o tipo de papel, e depois pressione o botão **OK**.

- 7 Abra a bandeja de saída do papel.

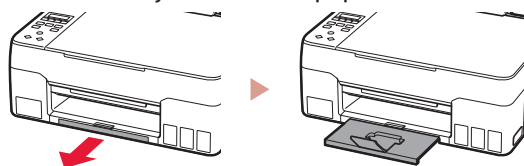

Transportando a Impressora

Ao mudar a posição da impressora, verifique o seguinte. Consulte o **Manual On-line** para obter detalhes.

Verifique se ambos os botões acoplados foram pressionados para baixo completamente para evitar vazamentos de tinta.

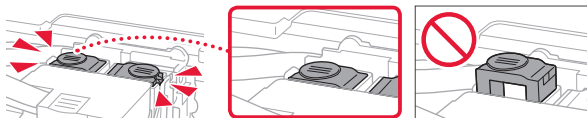

Verifique se a posição da alavanca de válvula de tinta está fechada.

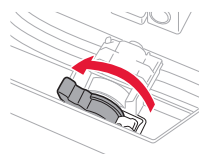

Embale a impressora em um saco plástico caso ocorra vazamento de tinta.

- Coloque a impressora em uma caixa resistente de modo que a parte inferior fique virada para baixo, usando material de proteção suficiente para garantir o transporte seguro.
- Não incline a impressora. A tinta pode vazar.
- Manuseie com cuidado e garanta que a caixa permaneça na horizontal, e NÃO de cabeça para baixo ou de lado, pois a impressora pode ser danificada e a tinta da impressora pode vazar.
- Quando um agente de transporte estiver manuseando o transporte da impressora, marque a caixa com "ESTE LADO PARA CIMA" para manter a parte inferior da impressora virada para baixo. Marque também com "FRÁGIL" ou "MANUSEAR COM CUIDADO".

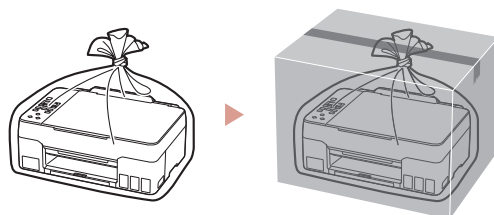

Trademarks

- Windows is a trademark or registered trademark of Microsoft Corporation in the U.S. and/or other countries.
- App Store is a trademark of Apple Inc., registered in the U.S. and other countries.
- Google Play is a registered trademark of Google LLC..

Marcas comerciales

- Windows es una marca comercial o marca comercial registrada de Microsoft Corporation, registrada en EE.UU. y/o en otros países.
- App Store es una marca comercial de Apple Inc., registradas en EE.UU. y en otros países.
- Google Play es una marca comercial registrada de Google LLC.

Marcas registradas

- Windows é uma marca comercial ou marca registrada da Microsoft Corporation nos EUA e/ou em outros países.
- App Store é uma marca registrada da Apple Inc., registradas nos EUA e em outros países.
- Google Play é uma marca registrada do Google LLC.



Access Online Manual

Acesse o Manual On-line

Acceso al Manual en línea

From your browser

Desde su navegador

Do seu navegador



<https://ij.start.canon>

